

Entry Trim

For all Adams Rite Exit Devices

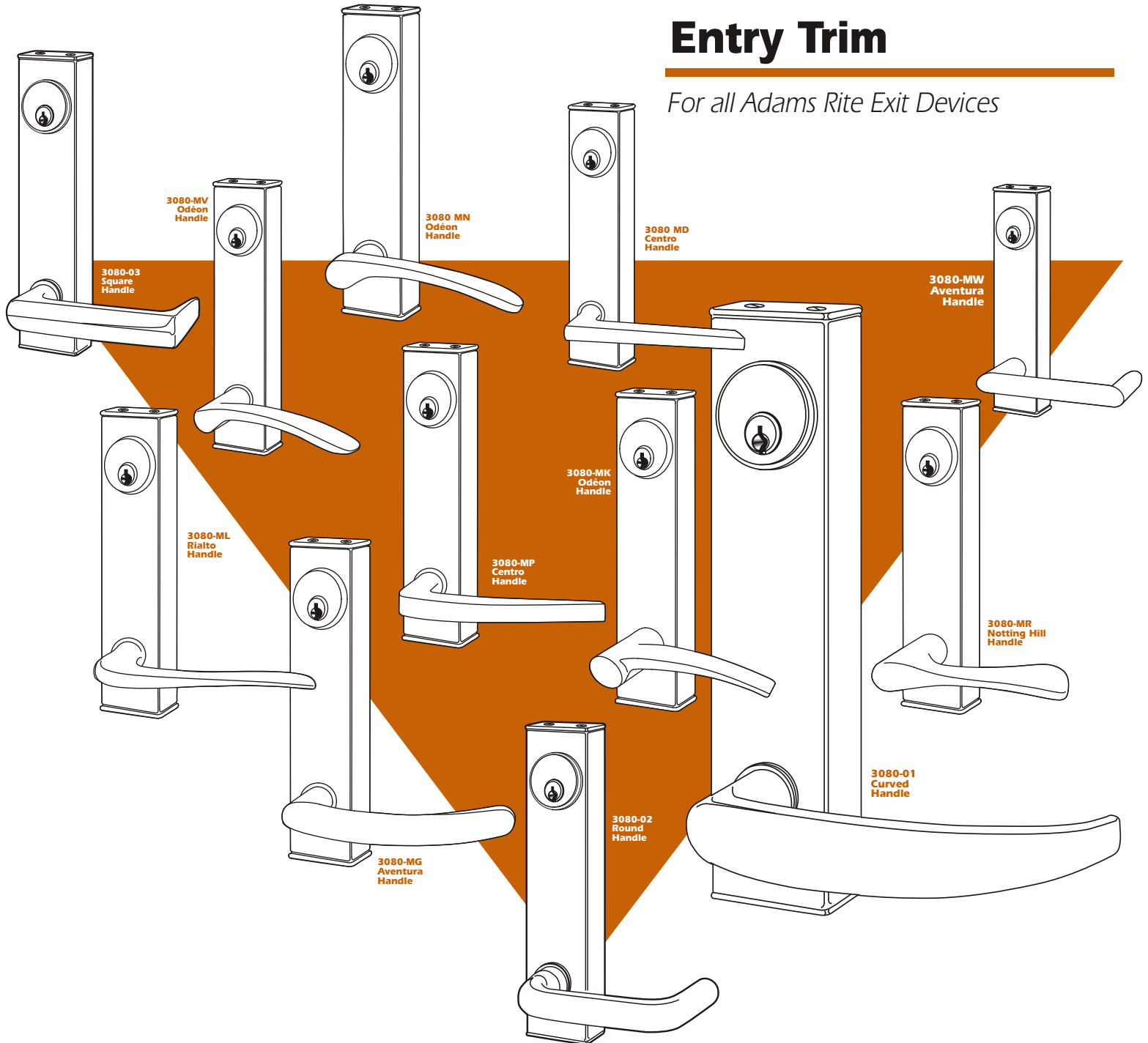

3080 Series Entry Trim

The 3080 Series provides outside activation of narrow stile aluminum, wood or hollow metal doors that have any type of Adams Rite Exit Device. Breakaway clutching mechanism protects the locked handle from vandalism or forced entry, in either direction. All models share the same core

components, so handles can be changed without having to replace the entire trim. Solid construction meets Grade 1 standards. An electrified version is also available for integrating with card readers, keypads and other access control devices. (See page ED-11.)



Entry Trim

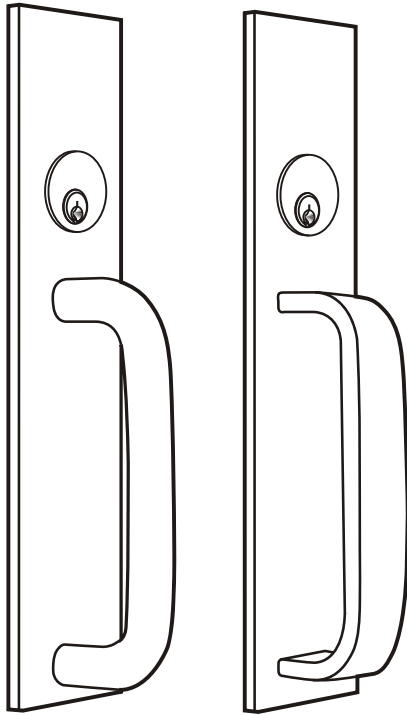

**3001 & 3002
Fixed Pulls**

3001 & 3002 Fixed Pulls

US32D Satin Stainless Steel pulls have 2-3/4" x 1-1/2" escutcheon. Order with or without cylinder hole. For hollow metal and wood doors only.

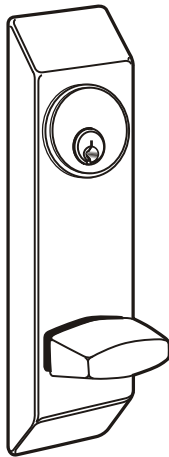

**8066
Thumbturn**

8066 Thumbturn

Thumbturn and any standard mortise cylinder with MS cam allow entry control in two modes: latched, but openable by thumbturn, or latched with entry by key only with 8067 Nightlatch Kit.

Rim Cylinder

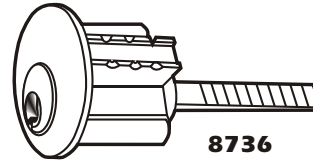

8736

Standard five-pin unit with spindle to suit Surface Vertical Rod exit devices. All brass with same choices of keying as Mortise cylinder. Available in finishes 628, 313 or 335. Any other make standard Rim cylinder can be used to key in with existing systems. Note that if entry trim is specified for cylinder use, the cylinder must be Mortise type, regardless of exit device.

Mortise Cylinder

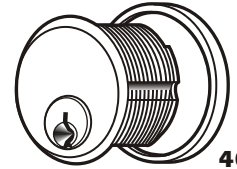

4036-01

Standard diameter five-pin unit with MS® cam, suitable for use with Entry Trim. All brass construction with front "scalp" available in finishes 628, 313 and 335. Available in quantity all keyed different (KD), in pairs (KA2) or fifty alike (KA50). Any other make standard Mortise cylinder with MS® cam can be used to "key in" with existing systems.

DIMENSIONS

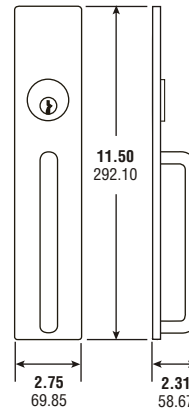

**3001
Round Pull**

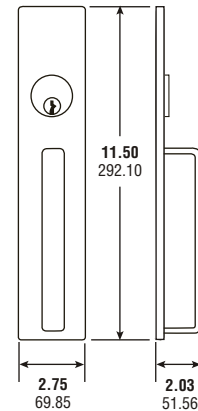

**3002
Flat Pull**

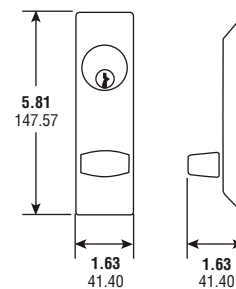

**8066
Thumbturn**

Entry Trim

DIMENSIONS

INCHES
MILLIMETERS

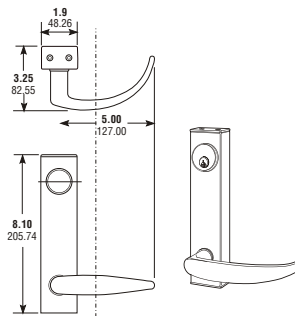

3080-01
Curved Handle

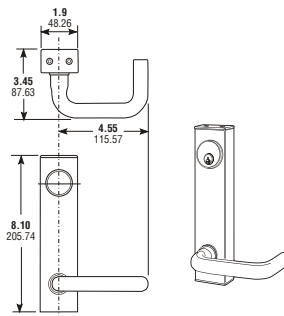

3080-02
Round Handle

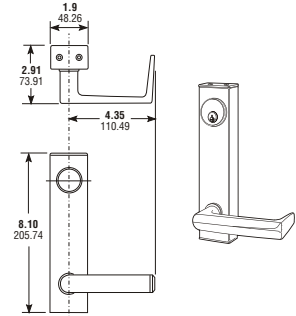

3080-03
Square Handle

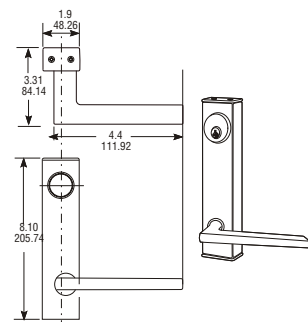

3080-MD
Centro Handle

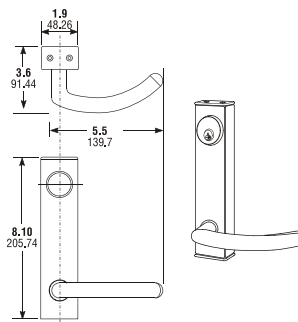

3080-MG
Aventura Handle

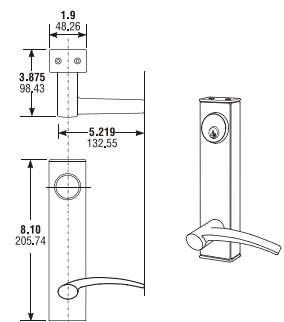

3080-MK
Odéon Handle

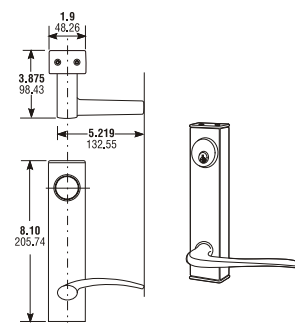

3080-ML
Rialto Handle

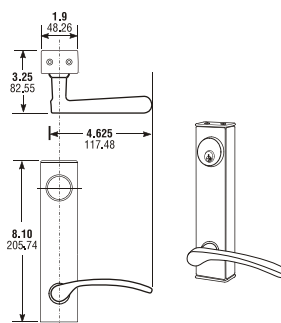

3080-MN
Odéon Handle

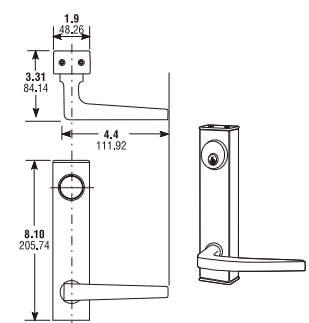

3080-MP
Centro Handle

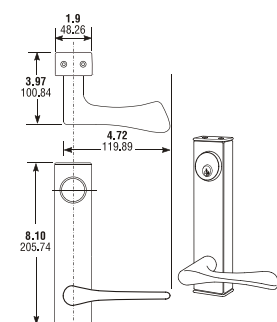

3080-MR
Notting Hill Handle

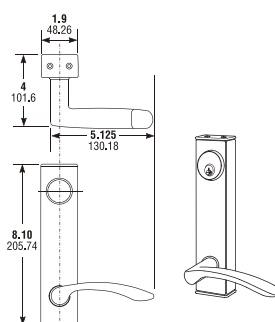

3080-MV
Odéon Handle

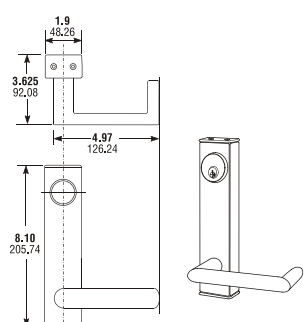

3080-MW
Aventura Handle



ENTRY TRIM

Entry Trim Ordering Matrix

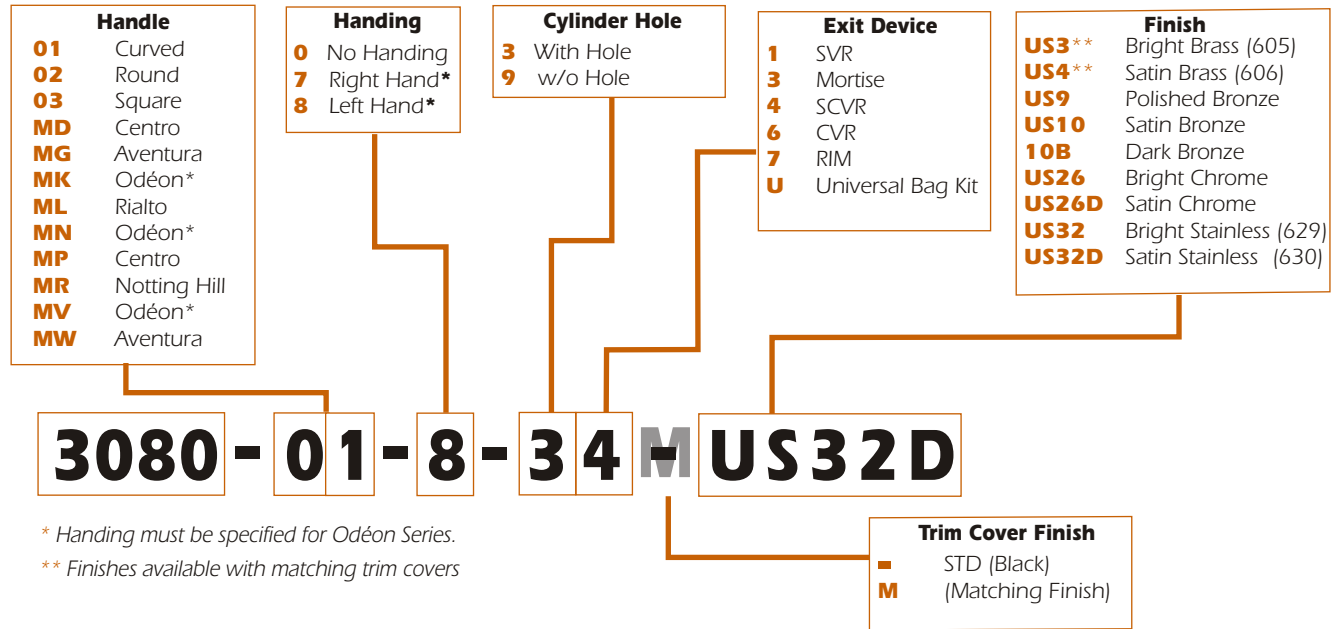

HOW TO ORDER 3001 or 3002 FIXED PULLS

Specify quantity and the following information.
 Order related hardware separately.

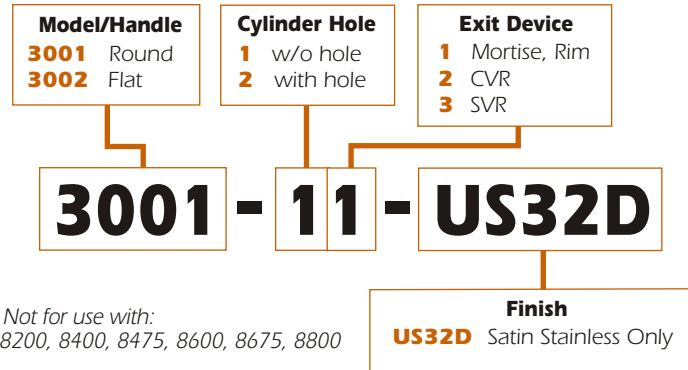

HOW TO ORDER 8066 THUMBTURN

Specify quantity and the following information.
 Order related hardware separately.

