

**LIFE SAFETY,
SECURITY DOOR HARDWARE
AND
INTEGRATED DOOR
SECURITY SYSTEMS**

PRICE LIST

Effective August 1, 2008

Where Trust is Built™
DETEX®
Life Safety and Security Door Hardware

NOTES

TABLE OF CONTENTS

Order Conditions	1
Warranties	2
Standards and Certifications	3
Finishes Cross Reference Chart	4

Life Safety and Security Door Hardware

ADVANTEK®

Wide Stile Devices	
10 Series Rim Device	5
20 Series Surface Vertical Rod Device.....	6
21 Series Surface Vertical Rod Device - Top Rod Only.....	7
30 Series Mortise Lock Device	8
Outside Trims for 10/20/21/30 Devices	9
Narrow Stile Devices	
40 Series Rim Device	10
50 Series Surface Vertical Rod Device.....	11
51 Series Surface Vertical Rod Device - Top Rod Only.....	12
Outside Trims for 40/50/51 Devices	13
Advantex Trim Cross Reference Matrix.....	14
Electrical Options.....	16
Advantex Easy Price Reference	20
Parts & Accessories.....	22

VALUE SERIES®

Standard & Narrow Stile Devices	
Value Series V40 Rim Device.....	25
Value Series V50 Surface Vertical Rod Device	26
Value Series V51 Surface Vertical Rod Device	27
Outside Trims for V40/V50/V51 Devices	28
Value Series Trim Cross Reference Matrix.....	29
Electrical Options.....	30
Value Series Easy Price Reference	34
Parts & Accessories	35
Power Supplies and Accessories	37

TABLE OF CONTENTS CONTINUED

Mullions

90 Series	38
-----------------	----

AO19 SERIES® (Low Energy Automatic Door Operators)

Automatic Operator - AO19-1 (Single Door).....	39
Automatic Operator - AO19-2 (Pair of Doors).....	40
Automatic Operator - AO19-3 (Double Egress Doors)	41
Automatic Operator - AO19 Parts/Accessories	42

ECL (Exit Control Locks)

Exit Control Locks (ECL-230, ECL-600)	43
Accessories	44
Keepers and Strike Kits	45
Multi-Point Security (ECL-230DxVRA)	45
Cylinders and Accessories	46

DX Bolts

Hinge Side Bolts -DX1, DX2, DX3	46
---------------------------------------	----

EAX®(Exit Alarms)

Exit Alarms - EAX-500	47
Exit Alarms - EAX-2500	48
Exit Alarms - EAX-3500	49
Door Prop Alarms (400 Series).....	50
Remote Alarms (CS-900 and CS-2900)	50
Door Switches	51
Accessories	51
Power Sources	52

Redi-Key

Key Vaults.....	53
-----------------	----

TABLE OF CONTENTS CONTINUED

DTX® (Access Control)

DTX3000 Series	54
Options and Accessories	55
DTX1000 Series	56
Options and Accessories	57
Anti-tailgate Pedestals.....	57

Miscellaneous

Key Switches and Covers.....	58
Motion Sensor	58
Push Buttons	59
Electric Strikes	59
Electromagnetic Locks	60
Weatherized Horns/Strobes	60
Power Transfers/Electric Hinges	60
Remote Indicating Panels.....	61
NEMA Enclosures.....	61

Series 800

Controllers and Power Supplies	62
Controller Accessories.....	63

Integrated Door Security Systems

EasyKit®

Access Control Doors	64
Delayed Egress Doors.....	69
Weatherized Delayed Egress Doors	73
Electrified Dogging	75
Automatically Operated Doors.....	77

ORDER CONDITIONS

Prices: Prices are subject to change without notice. **No prices are guaranteed;** all shipments will be made at prices prevailing at the time of receipt of order.

Terms: Net 45 days. Past due accounts may be subject to a shipping hold.

Acceptance: We reserve the right to decline an order, in whole or part, when the type or quantity of goods or credit worthiness of the purchaser is not satisfactory.

Delivery: All shipments are Ex Works Factory New Braunfels, Texas. **Freight allowance (ground service only) will be based on individual shipments of \$5,000 or more in the U.S. and Canada.** Most standard products are shipped within two working days from receipt of order. We have consistently met this fill rate standard 99% of the time for the past 5 years.

Returned Goods: Materials may be returned for credit within **six (6) months** of purchase. No goods will be accepted for return unless a **Return Materials Authorization** has been issued. Contact your local representative with requests. **Returns must be unmounted and in original packaging.** Credit will be issued at price paid or current price, whichever is lower, less a minimum 25% restocking charge. **Obsolete, discontinued or special products are not returnable.**

Special Order Items: Products made for a specific customer requirement and other specialized one of a kind products are **non-returnable** and **non-cancelable**, and may require a prepayment of 50%. Exit devices can be precut at factory - call for pricing.

Cancellation & Changes: If orders have been entered for manufacturing, cancellations cannot be accepted without our permission and may be subject to a cancellation charge.

Corrections: We expressly reserve the right to correct clerical, stenographic and other obvious errors at any time.

TOLL FREE FAX NUMBER FOR PLACING ORDERS

1-800-653-3839

**TOLL FREE NUMBER FOR PLACING ORDERS DIRECTLY TO
OUR SALES DEPARTMENT**

1-800-729-3839

or e-mail

sales@detex.com

International e-mail

export@detex.com

For the name of the representative in your area,
see our web page at www.detex.com or call factory.

WARRANTIES

Limited Warranties:





Detex® **ADVANTEX**® and **Value Series**® panic hardware, when properly installed, used and maintained, is warranted to be free of defects in material and workmanship. We will, for a period of ten (10) years from the date of purchase, **repair or replace** any part which, upon our examination, proves to be defective under normal use. Electrical components, when properly installed and maintained, are warranted to be free of defects in material and workmanship for a period of three (3) years. This warranty will be honored only upon presentation of proof that the product covered thereby was purchased directly from an authorized Detex distributor. WE SHALL NOT BE LIABLE FOR ANY DIRECT, INCIDENTAL OR CONSEQUENTIAL LOSS OR DAMAGE ARISING OUT OF THE FAILURE OF THIS PANIC HARDWARE TO OPERATE.

Warranty Conditions: Detex power supplies are required when powering Delayed Egress and Latch Retraction exit devices. Failure to use Detex recommended power supplies will void manufacturers warranty.

Limited Warranty: All Detex security hardware products or signaling devices are warranted to be free of defects in material and workmanship when properly installed, used and maintained according to instructions. We will, for a period of *three (3) years from the date of purchase, **repair or replace** any part which, upon our examination, proves to be defective under normal use. (This does not apply to batteries or to damage from battery leakage.) This warranty will be honored only upon presentation of proof that the product covered thereby was purchased directly from an authorized Detex Distributor. WE SHALL NOT BE LIABLE FOR ANY DIRECT, INCIDENTAL OR CONSEQUENTIAL LOSS OR DAMAGE ARISING OUT OF THE FAILURE OF THE PRODUCT OR DEVICE.

*ECL-230D, ECL-230D-PH, ECL-600 and 90KR
— ten (10) years
AO19 Series — 3 year mechanical / 1 year
electrical





STANDARDS AND CERTIFICATIONS

Product	Type	Application	3 Hour Fire Rated Openings				Mortise Cylinder Required	Limited Warranty
Advantex								
10 Series	Relatching Lock	Rim Exit	Yes*	Yes	4140-0127:105 3725-0127:108	Yes**	CD, EA, EI, EE, EExER & EM	10/3 year
20 Series	Relatching 2 point Lock	SVR	Yes*	Yes	4140-0127:105 3725-0127:108	No NOA	CD, EA, EE, & EExER	10/3 year
21 Series	Relatching Lock	SVR Top Rod Only	Yes*	Yes	4140-0127:105 3725-0127:108	No NOA	CD, EA, EE, & EExER	10/3 years
30 Series	Mortise Lock	Mortise Exit Device	Yes*	Yes	4140-0127:105 3725-0127:108	No NOA	CD, EA, EE, & EExER	10/3 years
40 Series	Relatching Lock	Narrow Stile Rim Exit	Yes *	Yes	4140-0127:105 3725-1027:108	Yes **	CD, EA, EI, EE, EExER & EM	10/3 years
50 Series	Relatching 2 point Lock	Narrow Stile SVR	Yes *	Yes	4140-0127:105 3725-1027:108	No NOA	CD, EA, EE, & EExER	10/3 years
51 Series	Relatching Lock	Narrow SVR Top Rod Only	Yes *	Yes	4140-0127:105 3725-1027:108	No NOA	CD, EA, EE, & EExER	10/3 years
Value Series								
V40 Series	Relatching Lock	Rim Exit Device	Yes *	Yes	4140-0127:105 & 3725-0127:108 on all except - 4140-0127:105, 3774-0127:106 3725-0127:108 (EE and EM only)	Yes **	CD, EB(W), EE, EH(R), EI, & EM	10/3 years
V50 Series	Relatching 2 point Lock	SVR	Yes *	Yes	Pending	No NOA	CD, EB, EH(R),	10/3 years
V51 Series	Relatching Lock	SVR Top Rod Only	Yes *	Yes	Pending	No NOA	CD, EB, EH(R),	10/3 years
Other								
AO19 Series	Low Energy Automatic Door Operator	Single, Pairs, and Double Egress Doors	Pending		N/A	N/A	N/A	3/1 years
90KR	Key Removable Mullion	Pairs of Doors	Yes *	Yes	N/A	No NOA	Rim Cylinder Required	10 years

* - Add Prefix "F" for 3 hour Fire Rating

** - Add Prefix "H" for Miami Dade Hurricane Component Approval Listing see www.miamidade.gov - NOA #04-0810.04 Approval #FL9052
10/3 year warranty = 10 year limited warranty on mechanical components, 3 year limited warranty on electrical components

STANDARDS AND CERTIFICATIONS

Product	Type	Application	3 Hour Fire Rated Openings				Cylinder Required	Limited Warranty
ECL-230D	Deadbolt Lock	9V Alarm	No	Yes	4140-0127:102	No NOA	Rim	10 years
ECL-230DPH	Deadbolt Lock	9V Alarm	No	Yes	4140-0127:102	No NOA	Rim	10 years
ECL-600	Deadbolt & Relatching 2 point Lock	9V Alarm	Yes		4140-0127:102	No NOA	Rim	10 years
90KR	Keyed Removable Mullion	Pairs of Doors / no alarm	Yes *	Yes	N/A	No NOA	Rim	10 years
VRA-143	2 Point Vertical Rod Deadbolt Lock	N/A	No	Yes	N/A	No NOA	N/A	3 years
EAX-500	Door Mount Alarm	9V Alarm	Yes***	ANSI 156.29 Listed	N/A	—†	Mortise	3 years
EAX-2500	Wall Mount Door Alarm	12-24VAC Alarm	—†	ANSI 156.29 Listed	N/A	—†	Mortise	3 years
EAX-3500	Timed Bypass Exit Alarm	24VAC/VDC Alarm	N/A	N/A	N/A	N/A	Mortise	3 years
BE-961	Power Supply	9VDC power supply	—†	N/A	N/A	—†	N/A	3 years
Series 800	Power Supplies & Logic Controllers	Power Supplies w/ Logic	—†	Yes	3774-0127:107	—†	N/A	3 years
MS-2049	Magnetic Door Switch	Industrial grade	Yes***	Yes	N/A	N/A	N/A	3 years
DTX Series	Access Keypad / Card readers	Access Control	—†	N/A	N/A	—†	N/A	3 years

* Add Prefix "F" for 3 hour Fire Exit Hardware

*** UL Listed Miscellaneous Fire Door Accessory

10/3 year warranty = 10 year limited warranty on mechanical components, 3 year limited warranty on electrical components

—† Wall mounted - may be used with Rated Openings

FINISHES CROSS REFERENCE CHART

BHMA	US		BHMA	US	
605	US3	Brass, bright	626	US26D	Chromium, satin
606	US4	Brass, satin	628	US28	Aluminum, satin
611	US9	Bronze, bright	629	US32	Stainless Steel, bright
612	US10	Bronze, satin	630	US32D	Stainless Steel, satin
613	US10B	Brass, satin-oxidized-oil rubbed	689	SP28	Lacquer Sprayed Aluminum
619	US15	Satin, Nickel Plated, Clear-coated	693	SPBLK	Black, painted
622	US19	Flat Black, painted	711	DC35	Anodized Aluminum, black
625	US26	Chromium, bright			

Note: See product details for finishes offered

10 SERIES RIM DEVICE



Finishes

Outside Function	Device	630 (Std.)	606, 612, 613	605, 611, 629
Device Only - Exit Only No Trim	10	\$ 875.00	\$ 900.00	\$1,050.00
Outside Function	Device / Function / Trim	630 (Std.)	606, 612, 613	605, 611, 629
01 Exit only, cover plate	1001C	\$ 990.00	\$1,034.00	\$1,184.00
	1001W	\$ 990.00	\$1,076.00	\$1,226.00
02 Dummy pull trim	1002C	\$1,045.00	\$1,097.00	\$1,247.00
03 Key Retracts Latch pull trim	1003C	\$1,050.00	\$1,108.00	\$1,258.00
	1003W	\$ 990.00	\$1,076.00	\$1,226.00
	1003WS	\$1,010.00	\$1,076.00	\$1,226.00
02 Dummy Lever Trim	1002D	\$1,160.00	\$1,258.00	\$1,408.00
08 Key Locks/Unlocks Outside Lever	1008D	\$1,250.00	\$1,352.00	\$1,502.00
09 Lever Trim Active by Key; Locked when key removed	1009D	\$1,250.00	\$1,352.00	\$1,502.00
10 Double Cylinder	1010D	\$1,387.00	\$1,489.00	\$1,639.00
14 Outside Lever Always Active	1014D	\$1,250.00	\$1,352.00	\$1,502.00

(03 C shown)

08 D with S Lever (Standard) - shown

(1010D shown)

NOTE:
For all trim information and graphics see page 9

DEVICE COMES STANDARD WITH:

- 630 Brushed Stainless Steel Finish (Entire Device)
- HD Hex Dogging
- 36" 36" Device for 3 foot doors
- 99 Surface Strike



OPTIONS

- F Fire Rated - Specify prefix F (ex. F1001) Add \$125.00
 - H Hurricane Rated - Specify prefix H (ex. H1001) Add \$ 75.00
 - FH Fire Rated/Hurricane Rated - Specify prefix FH (ex. FH1001) Add \$200.00
- Electrified Options - see pages 16-19**

- 24" 24" Device for 2'0" doors Add \$ 65.00
- 48" 48" Device for 4'0" doors Add \$ 20.00
- KS Key Stop Installed Add \$ 5.00
- CD Cylinder Dogging N/C*
- LD Less Dogging N/C*
- 94 Double Door Strike available - see page 22
- 98 Semi-Mortise Strike N/C*

* N/C - No charge when ordered with device

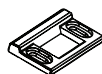

(98 Strike)



(94 Strike)

MC65



IC7



NOTE - Cylinders not included. Products on this page can be ordered with cylinders (MC65) or Interchangeable core housings (IC7) pre-installed at Detex prior to shipping (See page 23).

20 SERIES SURFACE VERTICAL ROD DEVICE

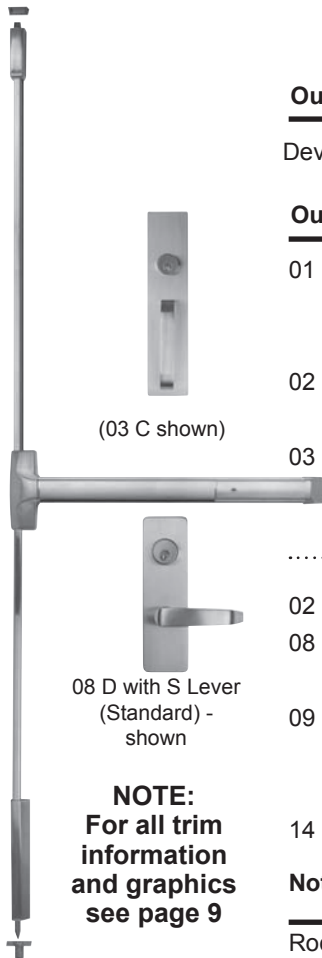

(03 C shown)

08 D with S Lever
(Standard) -
shown

NOTE:
For all trim
information
and graphics
see page 9

DEVICE COMES
STANDARD
WITH:

Outside Function	Device	Finishes		
		630 (Std.)	606, 612, 613	605, 611, 629
Device Only - Exit Only No Trim	20	\$1,375.00	\$1,434.00	\$1,550.00
Outside Function	Device / Function / Trim	630 (Std.)	606, 612, 613	605, 611, 629
01 Exit only, cover plate	2001C	\$1,490.00	\$1,568.00	\$1,684.00
	2001W	\$1,490.00	\$1,610.00	\$1,726.00
02 Dummy pull trim	2002C	\$1,545.00	\$1,631.00	\$1,747.00
03 Key Retracts Latch pull trim	2003C	\$1,550.00	\$1,642.00	\$1,758.00
	2003W	\$1,490.00	\$1,610.00	\$1,726.00
	2003WS	\$1,510.00	\$1,610.00	\$1,726.00
02 Dummy Lever Trim	2002D	\$1,660.00	\$1,792.00	\$1,908.00
08 Key Locks/Unlocks Outside Lever	2008D	\$1,750.00	\$1,886.00	\$2,002.00
09 Lever Trim Active by Key; Locked when key removed	2009D	\$1,750.00	\$1,886.00	\$2,002.00
14 Outside Lever Always Active	2014D	\$1,750.00	\$1,886.00	\$2,002.00

Note - Devices are shipped RHR unless specified LHR (Field Reversible)

- Rod, Latch and ADA Bottom Bolt Covers
- 630 Brushed Stainless Steel Finish (Entire Device)
- HD Hex Dogging
- 36" 36" Device for 3 foot doors
- 84" 84" Device for 7 foot doors
- 97 Surface Strike
- 97 Dust Proof Bottom Strike



OPTIONS

F Fire Rated - Specify prefix F (ex. F2001)	Add \$125.00
For Electrified Options see pages 16-19	
24" 24" Device for 2'0" doors	Add \$ 65.00
48" 48" Device for 4'0" doors	Add \$ 20.00
96" Add for 8' doors	Add \$ 10.00
120" Add for 10' doors	Add \$ 50.00
KS Key Stop Installed	Add \$ 5.00
CD Cylinder Dogging	N/C*
LD Less Dogging	N/C*

* N/C - No charge when ordered with device

MC65



IC7



NOTE - Cylinders not included. Products on this page can be ordered with cylinders (MC65) or Interchangeable core housings (IC7) pre-installed at Detex prior to shipping (See page 23).

21 SERIES SURFACE VERTICAL ROD DEVICE TOP ROD ONLY

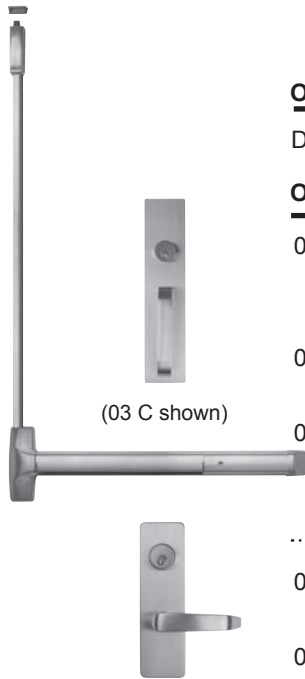

(03 C shown)

08 D with S Lever (Standard) - shown

NOTE:
For all trim information and graphics see page 9

DEVICE COMES STANDARD WITH:

Outside Function	Device	Finishes		
		630 (Std.)	606, 612, 613	605, 611, 629
Device Only - Exit Only No Trim	21	\$1,375.00	\$1,434.00	\$1,550.00
Outside Function	Device / Function / Trim	630 (Std.)	606, 612, 612	605, 611, 629
01 Exit only, cover plate	2101C	\$1,490.00	\$1,568.00	\$1,684.00
	2101W	\$1,490.00	\$1,610.00	\$1,726.00
02 Dummy pull trim	2102C	\$1,545.00	\$1,631.00	\$1,747.00
03 Key Retracts Latch pull trim	2103C	\$1,550.00	\$1,642.00	\$1,758.00
	2103W	\$1,490.00	\$1,610.00	\$1,726.00
	2103WS	\$1,510.00	\$1,610.00	\$1,726.00
02 Dummy Lever Trim	2102D	\$1,660.00	\$1,792.00	\$1,908.00
08 Key Locks/Unlocks Outside Lever	2108D	\$1,750.00	\$1,886.00	\$2,002.00
09 Lever Trim Active by Key; Locked when key removed	2109D	\$1,750.00	\$1,886.00	\$2,002.00
14 Outside Lever Always Active	2114D	\$1,750.00	\$1,886.00	\$2,002.00

Note - Devices are shipped RHR unless specified LHR (Field Reversible)

Rod Cover
630 Brushed Stainless Steel Finish (Entire Device)
HD Hex Dogging
36" 36" Device for 3 foot doors
84" 84" Device for 7 foot doors
97 Surface Strike



OPTIONS

F Fire Rated - Specify prefix F (ex. F2101)	Add \$125.00
For Electrified Options see pages 16-19	
24" 24" Device for 2'0" doors	Add \$ 65.00
48" 48" Device for 4'0" doors	Add \$ 20.00
96" Add for 8' doors	Add \$ 10.00
120" Add for 10' doors	Add \$ 50.00
KS Key Stop Installed	Add \$ 5.00
CD Cylinder Dogging	N/C*
LD Less Dogging	N/C*

* N/C - No charge when ordered with device

MC65



IC7



NOTE - Cylinders not included. Products on this page can be ordered with cylinders (MC65) or Interchangeable core housings (IC7) pre-installed at Detex prior to shipping (See page 23).



30 SERIES MORTISE LOCK EXIT DEVICE

Finishes

Outside Function	Device	630 (Std.)	606, 612, 613	605, 611, 629
Device Only - Exit Only No Trim	30	\$1,325.00	\$1,350.00	\$1,500.00
Outside Function	Device / Function / Trim	630 (Std.)	606, 612, 613	605, 611, 629
01 Exit only, cover plate	3001CM	\$1,440.00	\$1,484.00	\$1,634.00
	3001WM	\$1,440.00	\$1,526.00	\$1,676.00
02 Dummy pull trim	3002CM	\$1,495.00	\$1,547.00	\$1,697.00
03 Key Retracts Latch pull trim	3003CM	\$1,500.00	\$1,552.00	\$1,702.00
	3003WM	\$1,440.00	\$1,526.00	\$1,676.00
02 Dummy Lever Trim	3002DM	\$1,610.00	\$1,708.00	\$1,858.00
08 Key Locks/Unlocks Outside Lever	3008DM	\$1,700.00	\$1,802.00	\$1,952.00
09 Lever Trim Active by Key; Locked when key removed	3009DM	\$1,700.00	\$1,802.00	\$1,952.00
10 Double Cylinder	3010DM	\$1,837.00	\$1,939.00	\$2,089.00
14 Outside Lever Always Active	3014DM	\$1,700.00	\$1,802.00	\$1,952.00

(03 CM shown)

08 DM with S Lever (Standard) - shown

(3010DM shown)

NOTE:
For all trim information and graphics see page 9

NOTE: Specify -M for Mortise Trim

DEVICE COMES STANDARD WITH:

- HD Hex Dogging
- 630 Brushed Stainless Steel Finish (Entire Device)
- 36" 36" Device for 3 foot doors
- 90 Non-Handed Curved Lip Strike

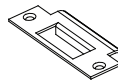

OPTIONS

F Fire Rated - Specify prefix F (ex. F3001)	Add \$125.00
For Electrified Options see pages 16-19	
48" 48" Device for 4'0" doors	Add \$ 20.00
KS Key Stop Installed	Add \$ 5.00
CD Cylinder Dogging	N/C*
LD Less Dogging	N/C*
91 ANSI Flat Lip Strike	Add \$ 5.00
92 Double Door Short Open Back Strike	Add \$ 33.00
93 Double Door Long Open Back Strike	Add \$ 29.00

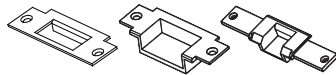

91 92 93







MC65

IC7



NOTE - Cylinders not included. Products on this page can be ordered with cylinders (MC65) or Interchangeable core housings (IC7) pre-installed at Detex prior to shipping (See page 23).





PLATES AND PULL TRIMS

W Trim for 10/20/21 Series Devices WM Trim for 30 Series Device		WS Trim for 10/20/21 Series Devices	C Trim for 10/20/21 Series Devices CM Trim (30) S Handle		
 01W/ 01WM	 03W/ 03WM	 03WS	 01C/ 01CM	 02C/ 02CM	 03C/ 03CM
Function	Description	Trim	Finishes: 630** 606, 612, 613 605, 611, 629 (Std.)		
01	Exit only, cover plate	W, WM	\$115.00	\$176.00	\$176.00
03*	Key retracts latch	W, WM	\$115.00	\$176.00	\$176.00
03*	Key retracts latch	WS**	\$135.00	\$176.00	\$176.00
01	Exit only, cover plate	C, CM	\$115.00	\$134.00	\$134.00
02	Dummy pull	C, CM	\$170.00	\$197.00	\$197.00
03*	Key retracts latch	C, CM	\$175.00	\$208.00	\$208.00

* Rim cylinder not included (order separately - see page 23)

** WS Trim - Not available in Stainless Steel (630) - Specify 625 or 626 (626 - same price as 630)

LEVER TRIM

		D Trim - for 10/20/21 Series Devices DM Trim - for 30 Series Device				
 08, 09D/DM	 02, 14D/DM	 S Lever - Standard	 T Lever	 U Lever		
Function	Description	Trim	Lever	Finishes: 626 606, 612, 613 605, 611, 629 (Std.)		
02	Dummy lever	D, DM	S, T or U	\$285.00	\$362.00	\$362.00
08*	Key locks/unlocks outside lever	D, DM	S, T or U	\$375.00	\$452.00	\$452.00
09*	Lever trim active by key; locked when key removed	D, DM	S, T or U	\$375.00	\$452.00	\$452.00
14	Outside lever always active	D, DM	S, T or U	\$375.00	\$452.00	\$452.00

* Mortise cylinder not included (order separately - see page 23)

NOTE: Lever Trims are shipped RHR unless specified LHR (Field Reversible)



40 SERIES NARROW STILE RIM DEVICE

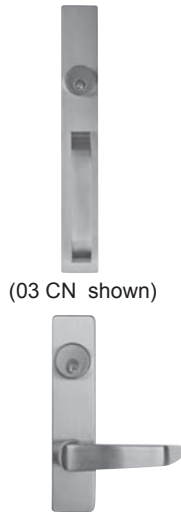

(03 CN shown)

08 DN with S Lever (Standard) - shown

NOTE:
For all trim information and graphics see page 13

DEVICE COMES STANDARD WITH:

Outside Function	Device	Finishes		
		630 (Std.)	606, 612, 613	605, 611, 629
Device Only - Exit Only No Trim	40	\$ 971.00	\$ 996.00	\$1,146.00
Outside Function	Device / Function / Trim	630 (Std.)	606, 612, 613	605, 611, 629
01 Exit only, cover plate	4001CN	\$1,111.00	\$1,155.00	\$1,305.00
02 Dummy pull trim	4002CN	\$1,166.00	\$1,243.00	\$1,368.00
03 Key Retracts Latch pull trim	4003CN	\$1,171.00	\$1,273.00	\$1,398.00
	4003WS	\$1,131.00	\$1,197.00	\$1,347.00
02 Dummy Lever Trim	4002DN	\$1,281.00	\$1,379.00	\$1,529.00
08 Key Locks/Unlocks Outside Lever	4008DN	\$1,371.00	\$1,473.00	\$1,623.00
09 Lever Trim Active by Key; Locked when key removed	4009DN	\$1,371.00	\$1,473.00	\$1,623.00
14 Outside Lever Always Active	4014DN	\$1,371.00	\$1,473.00	\$1,623.00

- HD Hex Dogging
- 630 Brushed Stainless Steel Finish (Entire Device)
- 36" 36" Device for 3 foot doors
- 98 Semi-Mortise Strike

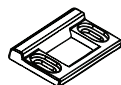

OPTIONS

- F Fire Rated - Specify prefix F (ex. F4001) Add \$125.00
- H Hurricane Rated - Specify prefix H (ex. H4001) Add \$ 75.00
- FH Fire Rated/Hurricane Rated - Specify prefix FH (ex. FH4001) Add \$200.00

Electrified Options - see pages 16-19

- 48" 48" Device for 4'0" doors Add \$ 20.00
- KS Key Stop Installed Add \$ 5.00
- CD Cylinder Dogging N/C*
- LD Less Dogging N/C*
- 94 Double Door Strike Available - see page 22
- 99 Surface Strike N/C*

* N/C - No charge when ordered with device



(99 Strike)



(94 Strike)

MC65



IC7



NOTE - Cylinders not included. Products on this page can be ordered with cylinders (MC65) or Interchangeable core housings (IC7) pre-installed at Detex prior to shipping (See page 23).



50 SERIES NARROW STILE SURFACE VERTICAL ROD DEVICE

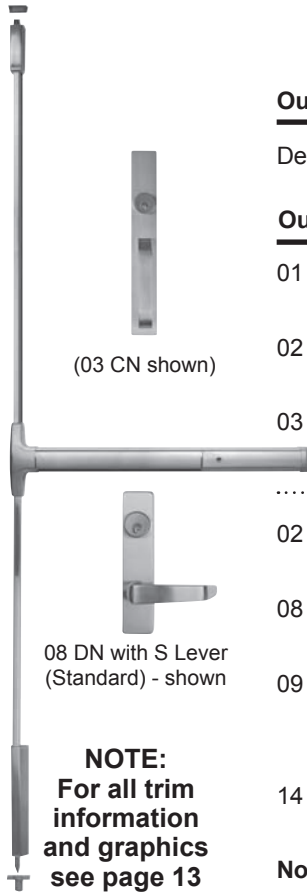

NOTE:
For all trim information and graphics see page 13

Outside Function	Device	Finishes		
		630 (Std.)	606, 612, 613	605, 611, 629
Device Only - Exit Only No Trim	50	\$1,475.00	\$1,534.00	\$1,650.00
Outside Function	Device / Function / Trim	630 (Std.)	606, 612, 613	605, 611, 629
01 Exit only, cover plate	5001CN	\$1,615.00	\$1,693.00	\$1,809.00
02 Dummy pull trim	5002CN	\$1,670.00	\$1,781.00	\$1,872.00
03 Key Retracts Latch pull trim	5003CN	\$1,625.00	\$1,811.00	\$1,902.00
	5003WS	\$1,635.00	\$1,735.00	\$1,851.00
.....				
02 Dummy Lever Trim	5002DN	\$1,785.00	\$1,917.00	\$2,033.00
08 Key Locks/Unlocks Outside Lever	5008DN	\$1,875.00	\$2,011.00	\$2,127.00
09 Lever Trim Active by Key; Locked when key removed	5009DN	\$1,875.00	\$2,011.00	\$2,127.00
14 Outside Lever Always Active	5014DN	\$1,875.00	\$2,011.00	\$2,127.00

Note - Devices are shipped RHR unless specified LHR (Field Reversible)

DEVICE COMES STANDARD WITH:

- Rod Covers
- 630 Brushed Stainless Steel Finish (Entire Device)
- HD Hex Dogging
- 36" 36" Device for 3 foot doors
- 84" 84" Device for 7 foot doors
- 96 Surface Strike
- 96 Dust Proof Bottom Strike

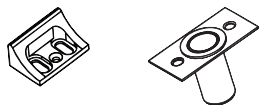

OPTIONS

F Fire Rated - Specify prefix F (ex. F5001)	Add \$125.00
For Electrified Options see pages 16-19	
24" 24" Device for 2'0" doors	Add \$ 65.00
48" 48" Device for 4'0" doors	Add \$ 20.00
96" Add for 8' doors	Add \$ 10.00
120" Add for 10' doors	Add \$ 50.00
KS Key Stop Installed	Add \$ 5.00
CD Cylinder Dogging	N/C*
LD Less Dogging	N/C*

* N/C - No charge when ordered with device



NOTE - Cylinders not included. Products on this page can be ordered with cylinders (MC65) or Interchangeable core housings (IC7) pre-installed at Detex prior to shipping (See page 23).

51 SERIES NARROW STILE SURFACE VERTICAL ROD DEVICE - TOP ROD ONLY



NOTE:
For all trim information and graphics see page 13

DEVICE COMES STANDARD WITH:

Outside Function	Device	Finishes		
		630 (Std.)	606, 612, 613	605, 611, 629
Device Only - Exit Only No Trim	51	\$1,475.00	\$1,534.00	\$1,650.00
Outside Function	Device / Function / Trim	630 (Std.)	606, 612, 613	605, 611, 629
01 Exit only, cover plate	5101CN	\$1,615.00	\$1,693.00	\$1,809.00
02 Dummy pull trim	5102CN	\$1,670.00	\$1,781.00	\$1,872.00
03 Key Retracts Latch pull trim	5103CN	\$1,625.00	\$1,811.00	\$1,902.00
	5103WS	\$1,635.00	\$1,735.00	\$1,851.00
02 Dummy Lever Trim	5102DN	\$1,785.00	\$1,917.00	\$2,033.00
08 Key Locks/Unlocks Outside Lever	5108DN	\$1,875.00	\$2,011.00	\$2,127.00
09 Lever Trim Active by Key; Locked when key removed	5109DN	\$1,875.00	\$2,011.00	\$2,127.00
14 Outside Lever Always Active	5114DN	\$1,875.00	\$2,011.00	\$2,127.00

Note - Devices are shipped RHR unless specified LHR (Field Reversible)

Rod Cover
630 Brushed Stainless Steel Finish (Entire Device)
HD Hex Dogging
36" 36" Device for 3 foot doors
84" 84" Device for 7 foot doors
96 Surface Strike



OPTIONS

F Fire Rated - Specify prefix F (ex. F5101)	Add \$125.00
For Electrified Options see pages 16-19	
24" 24" Device for 2'0" doors	Add \$ 65.00
48" 48" Device for 4'0" doors	Add \$ 20.00
96" Add for 8' doors	Add \$ 10.00
120" Add for 10' doors	Add \$ 50.00
KS Key Stop Installed	Add \$ 5.00
CD Cylinder Dogging	N/C*
LD Less Dogging	N/C*

* N/C - No charge when ordered with device

MC65



IC7







NOTE - Cylinders not included. Products on this page can be ordered with cylinders (MC65) or Interchangeable core housings (IC7) pre-installed at Detex prior to shipping (See page 23).

Where Trust is Built™

DETEX®
Life Safety and Security Door Hardware





PLATES AND PULL TRIMS

WS Trim for 40/50/51 Series Devices			CN Trim for 40/50/51 Series Devices S Handle		
 03WS			 01CN  02CN  03CN		
Function	Description	Trim	Finishes: 630** (Std.)	606, 612, 613	605, 611, 629
03	Key retracts latch	WS**	\$160.00	\$201.00	\$201.00
01	Exit only, cover plate	CN	\$140.00	\$159.00	\$159.00
02	Dummy pull	CN	\$195.00	\$222.00	\$222.00
03*	Key retracts latch	CN	\$200.00	\$233.00	\$233.00

* Rim cylinder not included (order separately - see page 23)

** WS Trim - Not available in Stainless Steel (630) - Specify 625 or 626 (626 - same price as 630)

LEVER TRIM NARROW STILE

DN Trim for 40/50/51 Series Devices						
 08, 09DN  02, 14DN  S Lever - Standard  T Lever  U Lever						
Function	Description	Trim	Lever	Finishes: 626 (Std.)	606, 612, 613	605, 611, 629
02	Dummy lever	DN	S, T or U	\$310.00	\$383.00	\$383.00
08*	Key locks/unlocks outside lever	DN	S, T or U	\$400.00	\$477.00	\$477.00
09*	Lever trim active by key; locked when key removed	DN	S, T or U	\$400.00	\$477.00	\$477.00
14	Outside lever always active	DN	S, T or U	\$400.00	\$477.00	\$477.00

* Mortise cylinder not included (order separately - see page 23)

NOTE: Lever Trims are shipped RHR unless specified LHR (Field Reversible)

BHMA Function	BHMA Definition	Description	ADVANTEX®	Manufacturer #A	Manufacturer #B
			Standard 10 Series Rim	Exit Devices Standard 98 Series Rim	Exit Devices Standard 21 Series Rim
01	Exit Only	Cover Plate	01C & 01W	990EO	1701
02	Pull When Dogged	Dummy Pull	02C	990DT	1702A
03	Key Retracts Latch Bolt	Night Latch Pull	03C	990NL	1703A
03	Key Retracts Latch Bolt	Night Latch - Cylinder Only - Pull by Others	03WS & 03W	110NL-OP	C03
02	Pull When Dogged	Dummy Lever	02D	996LxDT	4902A
08	Key Unlocks & Locks Lever	Classroom Lever	08D	996L	4908A
09	Lever Active by Key: Locked when key removed	Night Latch / Storeroom Lever	09D	996LxNL	4903A
10	Inside or outside, key locks or unlocks lever	Double Cylinder Lever	10D	996L	4908A
14	Lever always active	Passage Lever	14D	996LxBE	4914A

BHMA Function	BHMA Definition	Description	SVR Rim 20/21 Series Rim	SVR Rim 9827 Series Rim	SVR Rim 22 Series Rim
01	Exit Only	Cover Plate	01C & 01W	990EO	1701
02	Pull When Dogged	Dummy Pull	02C	990DT	1702A
03	Key Retracts Latch Bolt	Night Latch Pull	03C	990NL	1703A
03	Key Retracts Latch Bolt	Night Latch - Cylinder Only - Pull by Others	03WS & 03W	370T	C03
02	Pull When Dogged	Dummy Lever	02D	996LxDT	4902A
08	Key Unlocks & Locks Lever	Classroom Lever	08D	996L	4908A
09	Lever Active by Key: Locked when key removed	Night Latch / Storeroom Lever	09D	996LxNL	4903A
14	Lever always active	Passage Lever	14D	996LxBE	4914A

BHMA Function	BHMA Definition	Description	Mortise 30 Series	Mortise 9875 Series	Mortise 23 Series
01	Exit Only	Cover Plate	01CM	990EO	1701
02	Pull When Dogged	Dummy Pull	02CM	990DT	1702A
03	Key Retracts Latch Bolt	Night Latch Pull	03CM	990NL	1703A
03	Key Retracts Latch Bolt	Night Latch - Cylinder Only - Pull by Others	03W		C03
02	Pull When Dogged	Dummy Lever	02DM	996LxDT	M4902A
08	Key Unlocks & Locks Lever	Classroom Lever	08DM	996L	M4908A
09	Lever Active by Key: Locked when key removed	Night Latch / Storeroom Lever	09DM	996LxNL	M4903A
10	Inside or outside, key locks or unlocks lever	Double Cylinder Lever	10DM	996L	M4908A
14	Lever always active	Passage Lever	14DM	996LxBE	M4914A

Note: Detex Trims can be ordered separately from Detex Exit Devices

TRIM CROSS REFERENCE CONT'D ON PAGE 15

Where Trust is Built™

DETEX®
Life Safety and Security Door Hardware

ADVANTEX[®] TRIM CROSS REFERENCE MATRIX CONT'D

BHMA Function	BHMA Definition	Description	ADVANTEX[®]	Manufacturer #A	Manufacturer #B
			Narrow Stile 40 Series Rim	Exit Devices Narrow Stile 35A Series Rim	Exit Devices Narrow Stile 24 Series Rim
01	Exit Only	Cover Plate	01CN	360EO	2001
02	Pull When Dogged	Dummy Pull	02CN	386DT	2002A
03	Key Retracts Latch Bolt	Night Latch Pull	03CN	386NL	2003A
03	Key Retracts Latch Bolt	Night Latch -	03WS	388	C03
02	Pull When Dogged	Dummy Lever	02DN		2902A
08	Key Unlocks & Locks Lever	Classroom Lever	08DN	360L	2908A
09	Lever Active by Key: Locked when key removed	Night Latch / Storeroom Lever	09DN	360L-NL	2903A
14	Lever always active	Passage Lever	14DN	360L-BE	2914A

BHMA Function	BHMA Definition	Description	SVR Narrow Stile 50/51 Series Rim	SVR Narrow Stile 3327 Series Rim	Narrow Stile SVR Not Available
01	Exit Only	Cover Plate	01CN	3527A	
02	Pull When Dogged	Dummy Pull	02CN	386DT	
03	Key Retracts Latch Bolt	Night Latch Pull	03CN	386NL	
03	Key Retracts Latch Bolt	Night Latch - Cylinder Only - Pull by Others	03WS	388	
02	Pull When Dogged	Dummy Lever	02DN	360LxDT	
08	Key Unlocks & Locks Lever	Classroom Lever	08DN	360L	
09	Lever Active by Key: Locked when key removed	Night Latch / Storeroom Lever	09DN	360LxNL	
14	Lever always active	Passage Lever	14DN	360L-BE	

Note: Detex Trims can be ordered separately from Detex Exit Devices

Exit Alarm (EA) - Available on all Devices	Price
Standard Package Includes: - Switch monitors push pad - Green & Red LED, cylinder arming, 9 Volt battery and piezo horn - Cylinder Dogging (CD) standard except for "F" (Fire Rated) device - Self-adhesive Door Sign (EA-561 English - Red)	Add \$420.00
<u>EA Accessories</u>	
PP-5152-3 Transformer 12VAC (Order Separately)	\$ 29.00
PT-5 - Power Transfer	Add \$117.00
EWH8-626 - Electric Hinge	Add \$265.00
<u>EA Options</u>	
FC - Flex Conduit and End Cap (Example EAXFC)	Add \$ 27.00
KS - Key Stop Feature Installed	Add \$ 5.00
LD - Less Dogging	N/C
Substitute Door Signage Available (See Accessories - Page 24)	N/C
Electric Dogging (ED) - Available on all Devices	Price
Standard Package Includes: - On-board switching requires initial manual push pad depression after electric activation - Long-term dogging (Note: A Logic Controller & Power Supply is required for ED but not included in standard package)	Add \$375.00
<u>ED Accessories</u>	
PP-5152-2 24VAC transformer (Order Separately)	\$ 36.00
80-800 power supply for filtered, regulated power and simplified fire loop connections - (Order Separately)	(See Page 37)
PT-5 - Power Transfer	Add \$117.00
EWH8-626 - Electric Hinge	Add \$265.00
<u>ED Options</u>	
FC - Flex Conduit and End Cap (example EDxFC)	Add \$ 27.00
EX - Request to Exit Switching (example EDxEX)	Add \$175.00
Electric Latch Retraction (ER) - Available on all Devices	Price
Standard Package Includes - Simultaneous latch and push pad retraction - Long term dogging capability - Switches to monitor push pad (Note: Required but not included in standard ER package - Detex Series 800 Logic Controller & Power Supply)	Add \$675.00
<u>ER Accessories</u>	
81-800, 82-800 or 83-800 Logic Controller & Power Supply for Electric Latch Retraction	(See Page 37)
PT-5 - Power Transfer	Add \$117.00
EWH8-626 - Electric Hinge	Add \$265.00
<u>ER Options</u>	
FC - Flex Conduit and End Cap (example ERxFC)	Add \$ 27.00
EX - Request to Exit Switching (example ERxEX)	Add \$175.00

ELECTRIFIED OPTIONS CONT'D ON PAGE 17

Delayed Egress (EE) - Available on all Devices	Price
Standard Package Includes:	Add \$1,240.00
- 15 second Delayed Egress with dead latch monitoring	
- 24V Filtered and Regulated Power Supply with simplified fire loop connections.	
(NOTE: Detex Power Supply required and included with Standard EE package)	
- On-board logic controller	
- Switches monitor push pad, latch bolt and outside trim input	
- Cylinder Dogging (CD) standard except for "F" (Fire Rated) Device	
- Self-adhesive, Code Compliant Door Sign (ECL-395 English - 15 Second - Red)	
EE Accessories	
PT-5 - Power Transfer	Add \$ 117.00
EWH8-626 - Electric Hinge	Add \$ 265.00
EE Options	
30 - 30 Second Delayed Egress (example EEx30)	N/C
FC - Flex Conduit and End Cap (example EExFC)	Add \$ 27.00
KS - Key Stop feature installed	Add \$ 5.00
LD - Less Dogging	N/C
Delayed Egress with Latch Retraction (EExER) - Available on all Devices	Price
Standard Package Includes:	Add \$1,900.00
- Switches to monitor push pad, dead latch and outside trim input	
- Green and Red LED, cylinder arming and piezo horn (logic & power supply separate)	
- Self-adhesive, Code Compliant Door Sign (ECL-395 English - 15 Second - Red)	
(Note: Required but not included in standard EExER pkg - Detex Series 800 Logic Controller & Power Supply)	
EExER Accessories	
PT-5 - Power Transfer	Add \$ 117.00
EWH8-626 - Electric Hinge	Add \$ 265.00
EExER Options	
30 - 30 Second Delayed Egress (example EExERx30)	N/C
84-800 - Logic Controller & Power Supply for EExER	(See Page 37)
85-800 - Logic Controller & Power Supply for EExER	(See Page 37)
FC - Flex Conduit and End Cap (Example EExERxFC)	Add \$ 27.00
KS - Key Stop feature installed	Add \$ 5.00
Substitute Door Signage Available (See Accessories - Page 24)	N/C
Delayed Egress with Magnetic Lock (EM) - Available on 10/40 Devices Only	Price
Standard Package Includes	Add \$1,523.00
- 15 second Delayed Egress with dead latch monitoring	
- 24V Filtered and Regulated Power Supply with simplified fire loop connections.	
(NOTE: Detex Power Supply required and included with Standard EM package)	
- Cylinder Dogging (CD) standard except for "F" (Fire Rated) device	
- Magnetic Lock	
- Self-adhesive, Code Compliant Door Sign (ECL-395 English - 15 Second - Red)	
EM Accessories	
PT-5 - Power Transfer	Add \$ 117.00
EWH8-626 - Electric Hinge	Add \$ 265.00
EM Options	
30 - 30 Second Delayed Egress (example EMx30)	N/C
FC - Flex Conduit and End Cap (example EMxFC)	Add \$ 27.00
KS - Key Stop Feature Installed	Add \$ 5.00
LD - Less Dogging	N/C
Substitute Door Signage Available (See Accessories - Page 24)	N/C

ELECTRIFIED OPTIONS CONT'D ON PAGE 18

Electric Integration (EI) - Available on 10/40 Devices Only	Price
Standard Package Includes: - Switches to monitor dead latch and outside trim input - Green and Red LED, cylinder arming and piezo horn (logic & power supply separate) - Cylinder Dogging (CD) standard except for "F" (Fire Rated) device - Code Compliant Signage (EA-561 English Red) (Note: A Logic Controller & Power Supply is required for EI but not included in standard package)	Add \$310.00
<u>EI Accessories</u>	
10-800 or 11-800 - Logic Controller & Power Supply for Electric Integration	(See Page 62)
PT-5 - Power Transfer	Add \$117.00
EWH8-626 - Electric Hinge	Add \$265.00
<u>EI Options</u>	
FC - Flex Conduit and End Cap (Example EIxFC)	Add \$ 27.00
KS - Key Stop Feature Installed	Add \$ 5.00
LD - Less Dogging	N/C
Electric Switching (ES) - Available on 10/40 Devices Only	Price
Standard Package Includes: - Switches to monitor dead latch and outside trim input - Hex Dogging (HD) standard except for Fire Rated device	Add \$260.00
<u>ES Accessories</u>	
PT-5 - Power Transfer	Add \$117.00
EWH8-626 - Electric Hinge	Add \$265.00
<u>ES Options</u>	
FC - Flex Conduit and End Cap (example ESxFC)	Add \$ 27.00
CD - Cylinder Dogging	N/C
LD - Less Dogging	N/C
Request to Exit Signaling (EX) - Available on all Devices	Price
Standard Package Includes: - Switch monitors push pad - Hex Dogging (HD) standard except for "F" (Fire Rated) device	Add \$175.00
<u>EX Accessories</u>	
PT-5 - Power Transfer	Add \$117.00
EWH8-626 - Electric Hinge	Add \$265.00
<u>EX Options</u>	
FC - Flex Conduit and End Cap (example EXxFC)	Add \$ 27.00
CD - Cylinder Dogging	N/C
LD - Less Dogging	N/C
Weatherized Request to Exit Signaling (EXxW) - Available on all Devices	Price
Standard Package Includes: - Weatherized switch monitors push pad - Hex Dogging (HD) standard except for "F" (Fire Rated) device	Add \$205.00
<u>EXxW Accessories</u>	
PT-5 - Power Transfer	Add \$117.00
EWH8-626 - Electric Hinge	Add \$265.00
<u>EXxW Options</u>	
FC - Flex Conduit and End Cap (example EXxWxFC)	Add \$ 27.00
CD - Cylinder Dogging	N/C
LD - Less Dogging	N/C

ELECTRIFIED OPTIONS CONT'D ON PAGE 19

Request to Exit Switching for High Voltage (EXV) - Available on all Devices	Price
Standard Package Includes: - 3 AMP Switch monitors push pad - Hex Dogging (HD) standard except for "F" (Fire Rated) device	Add \$310.00
<u>EXV Accessories</u>	
PT-5 - Power Transfer	Add \$117.00
EWH8-626 - Electric Hinge	Add \$265.00
<u>EXV Options</u>	
FC - Flex Conduit and End Cap (example EXVxFC)	Add \$ 27.00
CD - Cylinder Dogging	N/C
LD - Less Dogging	N/C
Weatherized Request to Exit Switching for High Voltage (EXVxW) - Available on all Devices	Price
Standard Package Includes: - 3 AMP Weatherized switch monitors push pad - Hex Dogging (HD) standard except for "F" (Fire Rated) device	Add \$350.00
<u>EXVxW Accessories</u>	
PT-5 - Power Transfer	Add \$117.00
EWH8-626 - Electric Hinge	Add \$265.00
<u>EXVxW Options</u>	
FC - Flex Conduit and End Cap (example EXVxWxFC)	Add \$ 27.00
CD - Cylinder Dogging	N/C
LD - Less Dogging	N/C



EASY PRICE REFERENCE CHART

Model	Base Price	EA	ED	EI	ER	EE	EEEXER	EM	ES	EX	EXW	EXV	EXVW
		\$420	\$375	\$310	\$675	\$1,240	\$1,900	\$1,523	\$260	\$175	\$205	\$310	\$350
10 Series Rim (device only)	\$875	1,295	1,250	1,185	1,550	2,115	2,775	2,398	1,135	1,050	1,080	1,185	1,225
1001 W (exit only cover plate)	\$990	1,410	1,365	1,300	1,665	2,230	2,890	2,513	1,250	1,165	1,195	1,300	1,340
1001 C (exit only cover plate)	\$990	1,410	1,365	1,300	1,665	2,230	2,890	2,513	1,250	1,165	1,195	1,300	1,340
1002 C (Dummy Pull)	\$1,045	1,465	1,420	1,355	1,720	2,285	2,945	2,568	1,305	1,220	1,250	1,355	1,395
1002 D (Dummy Lever*)	\$1,160	1,580	1,535	1,470	1,835	2,400	3,060	2,683	1,420	1,335	1,365	1,470	1,510
1003 W (Key retracts latch)	\$990	1,410	1,365	1,300	1,665	2,230	2,890	2,513	1,250	1,165	1,195	1,300	1,340
1003 WS (Key retracts latch)	\$1,010	1,430	1,385	1,320	1,685	2,250	2,910	2,533	1,270	1,185	1,215	1,320	1,360
1003 C (Key retracts latch pull)	\$1,050	1,470	1,425	1,360	1,725	2,290	2,950	2,573	1,310	1,225	1,255	1,360	1,400
1008 D (lever trim*)	\$1,250	1,670	1,625	1,560	1,925	2,490	3,150	2,773	1,510	1,425	1,455	1,560	1,600
1009 D (lever trim* - locked when key removed)	\$1,250	1,670	1,625	1,560	1,925	2,490	3,150	2,773	1,510	1,425	1,455	1,560	1,600
1010 D (lever trim* double cylinder)	\$1,387	1,807	1,762	1,697	2,062	2,627	3,287	2,910	1,647	1,562	1,592	1,697	1,737
1014 D (lever trim* passage)	\$1,250	1,670	1,625	1,560	1,925	2,490	3,150	2,773	1,510	1,425	1,455	1,560	1,600

20 Series Surface Vertical Rod (device only)	\$1,375	1,795	1,750	N/A	2,050	2,615	3,275	N/A	N/A	1,550	1,580	1,685	1,725
2001 W (exit only cover plate)	\$1,490	1,910	1,865	N/A	2,165	2,730	3,390	N/A	N/A	1,665	1,695	1,800	1,840
2001 C (exit only cover plate)	\$1,490	1,910	1,865	N/A	2,165	2,730	3,390	N/A	N/A	1,665	1,695	1,800	1,840
2002 C (Dummy Pull)	\$1,545	1,965	1,920	N/A	2,220	2,785	3,445	N/A	N/A	1,720	1,750	1,855	1,895
2002 D (Dummy Lever*)	\$1,660	2,080	2,035	N/A	2,335	2,900	3,560	N/A	N/A	1,835	1,865	1,970	2,010
2003 W (Key retracts latch)	\$1,490	1,910	1,865	N/A	2,165	2,730	3,390	N/A	N/A	1,665	1,695	1,800	1,840
2003 WS (Key retracts latch)	\$1,510	1,930	1,885	N/A	2,185	2,750	3,410	N/A	N/A	1,685	1,715	1,820	1,860
2003 C (Key retracts latch pull)	\$1,550	1,970	1,925	N/A	2,225	2,790	3,450	N/A	N/A	1,725	1,755	1,860	1,900
2008 D (lever trim*)	\$1,750	2,170	2,125	N/A	2,425	2,990	3,650	N/A	N/A	1,925	1,955	2,060	2,100
2009 D (lever trim* - locked when key removed)	\$1,750	2,170	2,125	N/A	2,425	2,990	3,650	N/A	N/A	1,925	1,955	2,060	2,100
2014 D (lever trim* passage)	\$1,750	2,170	2,125	N/A	2,425	2,990	3,650	N/A	N/A	1,925	1,955	2,060	2,100

21 Series Surface Vertical Rod (TRO) device only	\$1,375	1,795	1,750	N/A	2,050	2,615	3,275	N/A	N/A	1,550	1,580	1,685	1,725
2101 W (exit only cover plate)	\$1,490	1,910	1,865	N/A	2,165	2,730	3,390	N/A	N/A	1,665	1,695	1,800	1,840
2101 C (exit only cover plate)	\$1,490	1,910	1,865	N/A	2,165	2,730	3,390	N/A	N/A	1,665	1,695	1,800	1,840
2102 C (Dummy Pull)	\$1,545	1,965	1,920	N/A	2,220	2,785	3,445	N/A	N/A	1,720	1,750	1,855	1,895
2102 D (Dummy Lever*)	\$1,660	2,080	2,035	N/A	2,335	2,900	3,560	N/A	N/A	1,835	1,865	1,970	2,010
2103 W (Key retracts latch)	\$1,490	1,910	1,865	N/A	2,165	2,730	3,390	N/A	N/A	1,665	1,695	1,800	1,840
2103 WS (Key retracts latch)	\$1,510	1,930	1,885	N/A	2,185	2,750	3,410	N/A	N/A	1,685	1,715	1,820	1,860
2103 C (Key retracts latch pull)	\$1,550	1,970	1,925	N/A	2,225	2,790	3,450	N/A	N/A	1,725	1,755	1,860	1,900
2108 D (lever trim*)	\$1,750	2,170	2,125	N/A	2,425	2,990	3,650	N/A	N/A	1,925	1,955	2,060	2,100
2109 D (lever trim* - locked when key removed)	\$1,750	2,170	2,125	N/A	2,425	2,990	3,650	N/A	N/A	1,925	1,955	2,060	2,100
2114 D (lever trim* - passage)	\$1,750	2,170	2,125	N/A	2,425	2,990	3,650	N/A	N/A	1,925	1,955	2,060	2,100

30 Series Mortise Device (device only)	\$1,325	1,745	1,700	N/A	2,000	2,565	3,225	N/A	N/A	1,500	1,530	1,635	1,675
3001 WM (exit only - cover plate)	\$1,440	1,860	1,815	N/A	2,115	2,680	3,340	N/A	N/A	1,615	1,645	1,750	1,790
3001 CM (exit only - cover plate)	\$1,440	1,860	1,815	N/A	2,115	2,680	3,340	N/A	N/A	1,615	1,645	1,750	1,790
3002 CM (Dummy Pull)	\$1,495	1,915	1,870	N/A	2,170	2,735	3,395	N/A	N/A	1,670	1,700	1,805	1,845
3002 DM (Dummy Lever*)	\$1,610	2,030	1,985	N/A	2,285	2,850	3,510	N/A	N/A	1,785	1,815	1,920	1,960
3003 WM (Key retracts latch)	\$1,440	1,860	1,815	N/A	2,115	2,680	3,340	N/A	N/A	1,615	1,645	1,750	1,790
3003 CM (Key retracts latch pull)	\$1,500	1,920	1,875	N/A	2,175	2,740	3,400	N/A	N/A	1,675	1,705	1,810	1,850
3008 DM (lever trim*)	\$1,700	2,120	2,075	N/A	2,375	2,940	3,600	N/A	N/A	1,875	1,905	2,010	2,050
3009 DM (lever trim* - locked when key removed)	\$1,700	2,120	2,075	N/A	2,375	2,940	3,600	N/A	N/A	1,875	1,905	2,010	2,050
3010 DM (lever trim* double cylinder)	\$1,837	2,257	2,212	N/A	2,512	3,077	3,737	N/A	N/A	2,012	2,042	2,147	2,187
3014 DM (lever trim* passage)	\$1,700	2,120	2,075	N/A	2,375	2,940	3,600	N/A	N/A	1,875	1,905	2,010	2,050

*lever design specify S, T, or U

EASY PRICE REFERENCE CHART CONT'D ON PAGE 21



EASY PRICE REFERENCE CHART CONT'D

Model	Base Price	EA	ED	EI	ER	EE	EE/ER	EM	ES	EX	EX/W	EXV	EX/WV
		\$420	\$375	\$310	\$675	\$1,240	\$1,900	\$1,523	\$260	\$175	\$205	\$310	\$350
40 Series Narrow Rim (device only)	\$971	1,391	1,346	1,281	1,646	2,211	2,871	2,494	1,231	1,146	1,176	1,281	1,321
4001 CN (exit only cover plate)	\$1,111	1,531	1,486	1,421	1,786	2,351	3,011	2,634	1,371	1,286	1,316	1,421	1,461
4002 CN (Dummy pull)	\$1,166	1,586	1,541	1,476	1,841	2,406	3,066	2,689	1,426	1,341	1,371	1,476	1,516
4002 DN (Dummy trim*)	\$1,281	1,701	1,656	1,591	1,956	2,521	3,181	2,804	1,541	1,456	1,486	1,591	1,631
4003 WS (Key retracts latch)	\$1,131	1,551	1,506	1,441	1,806	2,371	3,031	2,654	1,391	1,306	1,336	1,441	1,481
4003 CN (Key retracts latch pull)	\$1,171	1,591	1,546	1,481	1,846	2,411	3,071	2,694	1,431	1,346	1,376	1,481	1,521
4008 DN (lever trim*)	\$1,371	1,791	1,746	1,681	2,046	2,611	3,271	2,894	1,631	1,546	1,576	1,681	1,721
4009 DN (lever trim* - locked when key removed)	\$1,371	1,791	1,746	1,681	2,046	2,611	3,271	2,894	1,631	1,546	1,576	1,681	1,721
4014 DN (lever trim* passage)	\$1,371	1,791	1,746	1,681	2,046	2,611	3,271	2,894	1,631	1,546	1,576	1,681	1,721
50 Series Narrow Surface Vertical Rod (device only)	\$1,475	1,895	1,850	N/A	2,150	2,715	3,375	N/A	N/A	1,650	1,680	1,785	1,825
5001 CN (exit only cover plate)	\$1,615	2,035	1,990	N/A	2,290	2,855	3,515	N/A	N/A	1,790	1,820	1,925	1,965
5002 CN (Dummy Pull)	\$1,670	2,090	2,045	N/A	2,345	2,910	3,570	N/A	N/A	1,845	1,875	1,980	2,020
5002 DN (Dummy Lever*)	\$1,785	2,205	2,160	N/A	2,460	3,025	3,685	N/A	N/A	1,960	1,990	2,095	2,135
5003 WS (Key retracts latch)	\$1,635	2,055	2,010	N/A	2,310	2,875	3,535	N/A	N/A	1,810	1,840	1,945	1,985
5003 CN (Key retracts latch pull)	\$1,625	2,045	2,000	N/A	2,300	2,865	3,525	N/A	N/A	1,800	1,830	1,935	1,975
5008 DN (lever trim*)	\$1,875	2,295	2,250	N/A	2,550	3,115	3,775	N/A	N/A	2,050	2,080	2,185	2,225
5009 DN (lever trim* - locked when key removed)	\$1,875	2,295	2,250	N/A	2,550	3,115	3,775	N/A	N/A	2,050	2,080	2,185	2,225
5014 DN (lever trim* passage)	\$1,875	2,295	2,250	N/A	2,550	3,115	3,775	N/A	N/A	2,050	2,080	2,185	2,225
51 Series Narrow Surface Vertical Rod (TRO Device Only)	\$1,475	1,895	1,850	N/A	2,150	2,715	3,375	N/A	N/A	1,650	1,680	1,785	1,825
5101 CN (exit only cover plate)	\$1,615	2,035	1,990	N/A	2,290	2,855	3,515	N/A	N/A	1,790	1,820	1,925	1,965
5102 CN (Dummy Pull)	\$1,670	2,090	2,045	N/A	2,345	2,910	3,570	N/A	N/A	1,845	1,875	1,980	2,020
5102 DN (Dummy Lever*)	\$1,785	2,205	2,160	N/A	2,460	3,025	3,685	N/A	N/A	1,960	1,990	2,095	2,135
5103 WS (Key retracts latch)	\$1,635	2,055	2,010	N/A	2,310	2,875	3,535	N/A	N/A	1,810	1,840	1,945	1,985
5103 CN (Key retracts latch pull)	\$1,625	2,045	2,000	N/A	2,300	2,865	3,525	N/A	N/A	1,800	1,830	1,935	1,975
5108 DN (lever trim*)	\$1,875	2,295	2,250	N/A	2,550	3,115	3,775	N/A	N/A	2,050	2,080	2,185	2,225
5109 DN (lever trim* - locked when key removed)	\$1,875	2,295	2,250	N/A	2,550	3,115	3,775	N/A	N/A	2,050	2,080	2,185	2,225
5114 DN (lever trim* passage)	\$1,875	2,295	2,250	N/A	2,550	3,115	3,775	N/A	N/A	2,050	2,080	2,185	2,225

SIF-EA - Electric Slide-In Filler Kit		Finishes: 630 606, 612, 613 605, 611, 629			
SIF-EA	Exit Alarm 9VDC/12VAC with remote signal and remote bypass	36" Device	\$371.00	\$407.00	\$407.00
		48" Device	\$371.00	\$407.00	\$407.00
	Kit Includes: End Cap Bracket with Battery Clip 9V Battery Warning Sign (ECL-561)				
	NOTE: YOU MUST SPECIFY THE DEVICE SERIES, SIZE AND FINISH WHEN ORDERING.				
Options					
KS	Key Stop Kit				\$4.00
SIF-HD-CD-LD Slide-In Filler Kits		Finishes: 630 606, 612, 613 605, 611, 629			
SIF-LD-36	Less Dogging Slide-In Filler	36" Device	\$111.00	\$147.00	\$170.00
SIF-LD-48	Less Dogging Slide-In Filler	48" Device	\$126.00	\$162.00	\$185.00
SIF-HD-36	Hex Key Dogging Slide-In Filler	36" Device	\$134.00	\$170.00	\$170.00
SIF-HD-48	Hex Key Dogging Slide-In Filler	48" Device	\$149.00	\$185.00	\$185.00
SIF-CD-36	Cylinder Dogging Slide-In Filler	36" Device	\$147.00	\$183.00	\$183.00
SIF-CD-48	Cylinder Dogging Slide-In Filler	48" Device	\$162.00	\$198.00	\$198.00
	NOTE: YOU MUST SPECIFY THE DEVICE SERIES, SIZE AND FINISH WHEN ORDERING.				
Dummy Push Bars		Finishes: 630 606, 612, 613 605, 611, 629			
0000-36	Dummy Push Bar - No moving parts, rail with end caps		\$500.00	\$525.00	\$675.00
0001-36*	Dummy Push Bar - Active push pad, std. head cover, no latch bolt		\$700.00	\$725.00	\$875.00
0004-36*	Dummy Push Bar - Active push pad, narrow head cover, no latch bolt		\$796.00	\$821.00	\$971.00
0005-36	Dummy Push Bar - No moving parts, rail with end caps (narrow stile doors)		\$700.00	\$725.00	\$875.00
	Add \$20.00 for 48" Device				
	* FOR ELECTRICAL FUNCTIONS EX, EXxW, EXV and EXVxW SEE ELECTRICAL OPTIONS PAGE 18				
ERK1 - ER Retrofit Kit					Price
ERK1 - ER	Retrofit Kit Complete				\$659.00
	Kit Includes: ER Module Push Pad Assembly Hardware Kit Instructions				
	NOTE: YOU MUST SPECIFY THE DEVICE SIZE AND WHETHER TO ADD H OR EX OPTION WHEN ORDERING REQUIRES 81/82/83-800 POWER SUPPLY AND CONTROLLER, SOLD SEPARATELY, SEE PG. 37 FOR DETAILS				
Strikes					Price
90	Non-Handed Curved Lip Strike				\$ 27.00
91	ANSI Flat Lip Strike				\$ 27.00
92	Double Door Short Open Back Strike				\$ 55.00
93	Double Door Long Open Back Strike				\$ 68.00
94	Double Door Strike Kit with Tamper Resistant and Standard Fasteners (No security driver required)				\$ 51.00
96 Top	Surface Non-Roller Strike (for 50/51 Series Devices)				\$ 30.00
96B Bottom	Dust Proof Strike (for 50 Series Devices)				\$ 27.00
97 Top	Surface Non-Roller Strike (for 20/21 Series Devices)				\$ 30.00
97 Bottom	Dust Proof Strike (for 20 Series Devices)				\$ 27.00
98	Semi-Mortise Strike (for 10/40 Series Devices)				\$ 32.00
99	Surface Non-Roller Strike (for 10/40 Series Devices)				\$ 30.00
SHK1	Strike Hook Kit (1 per package)				\$ 12.00
Hex Dogging Key					Price
HDK	Hex Dogging Key				\$ 2.00

PARTS/ACCESSORIES CONT'D ON PAGE 23

Where Trust is Built™

DETEX
Life Safety and Security Door Hardware

Sex Nuts - Security Screws - Security Bits			Price	
SN1	Sex Nut Kit 1/4"-20 (2 per package) *	Specify Finishes: 606, 613, 626	\$ 10.00	
SN2	Sex Nut Kit 10-32 (2 per package) *	Specify Finishes: 606, 613, 630	\$ 10.00	
SSK1	Torx® Security Screw Kit for Rim Exit Device, Stainless Steel only, incl. Torx® bits		\$ 21.00	
SSK2	Torx® Security Screw Kit for SVR Exit Device, Stainless Steel only, incl. Torx® bits		\$ 45.00	
TT10	Torx® driver tip for 6-32 undercut FH screws		\$ 6.00	
TT15	Torx® driver tip for 6-32 FH screws		\$ 6.00	
TT25	Torx® driver tip for 10-32 FH screws		\$ 6.00	
TT27	Torx® driver tip for 1/4" and #14 screws		\$ 6.00	
Electrified Relay Kits			Price	
RLY12	12 VAC Relay Kit - For use with 12V alarms that have remote bypass feature		\$ 43.00	
Used with remote bypass to shunt alarm and activate another electrified device - Separate J-Box required				
RLY24	24 VAC Relay Kit - For use with 24V alarms that have remote bypass feature		\$ 43.00	
Used with remote bypass to shunt alarm and activate another electrified device - Separate J-Box required				
Glass Bead Kits			Price	
GB1	Glass Bead Kit - 10 Series		\$ 44.00	
GB2	Glass Bead Kit - 40 Series		\$ 44.00	
GB3	Glass Bead Kit - 20 Series	7 foot height	\$ 80.00	
GB4	Glass Bead Kit - 21 Series	7 foot height	\$ 69.00	
GB5	Glass Bead Kit - 50 Series	7 foot height	\$ 80.00	
GB6	Glass Bead Kit - 51 Series	7 foot height	\$ 69.00	
GB7	Glass Bead Kit - 20 Series	8 foot height	\$106.00	
GB8	Glass Bead Kit - 21 Series	8 foot height	\$ 95.00	
GB9	Glass Bead Kit - 50 Series	8 foot height	\$106.00	
GB10	Glass Bead Kit - 51 Series	8 foot height	\$ 95.00	
GB11	Glass Bead Kit - 20 Series	10 foot height	\$212.00	
GB12	Glass Bead Kit - 21 Series	10 foot height	\$191.00	
GB13	Glass Bead Kit - 50 Series	10 foot height	\$212.00	
GB14	Glass Bead Kit - 51 Series	10 foot height	\$191.00	
GB16	Glass Bead Kit - 30 series		\$ 53.00	
Cylinders and Accessories			Price	Price
				(Factory Installed)
MC65	Mortise Cylinder, Schlage "C" Keyway, 1-1/8" 6-pin, Keyed 5-pin	Specify Finish	\$27.00	\$ 60.00
IC7	7-pin SFIC Mortise Cylinder Housing (Core not included)		\$27.00	\$ 60.00
RC65	Rim Cylinder, Schlage "C" Keyway, 6-pin, Keyed 5-pin	Specify Finish	\$27.00	\$ 60.00
(Also known as ECL-445K)				
CCL	Cylinder Collar, Long 11/16"	Specify Finish	\$18.00	
CCS	Cylinder Collar, Short 7/16"	Specify Finish	\$15.00	
CBK	Cylinder Bracket Kit (for rim cylinder used with other manufacturer's trim)		\$25.00	
SE-2	Shaft Extension Kit for Lever Trims for 2 - 2 1/2" thick door**		\$32.00	
Flex Conduit Kits, Armored Loops and Power Transfers			Price	
FCA	Flex Conduit Kit (3') includes conduit, end cap and fittings (Specify finish)		\$105.00	
AL18	Surface Mount Armor Loop - 18" (Aluminum Finish)		\$ 50.00	
JB1	Junction Box - Flex Conduit Kit (for EM Maglock)		\$ 64.00	
PT-5	Power Transfer		\$117.00	
EWH8-626 Electric Hinge			\$265.00	
* Devices may require more than 1 Kit - For more information refer to Advantex Technical Information in Architectural Catalog				
** For other door thicknesses, contact factory				

Delayed Egress Peel and Stick Door Signage Chart		Price
PUSH UNTIL ALARM SOUNDS - DOOR CAN BE OPENED IN XX SECONDS		
ECL-395	English - 15 Second -Red (Standard)	\$10.00
ECL-395-1	English - 30 Second - Red	\$10.00
ECL-395-2	French/Canadian - 15 Second - Red	\$10.00
ECL-395-3	French/Canadian - 30 Second - Red	\$10.00
ECL-395-4	Spanish - 15 Second - Red	\$10.00
ECL-395-5	Spanish - 30 Second - Red	\$10.00
ECL-395-6	French - 15 Second - Green	\$10.00
ECL-395-7	French - 30 Second - Green	\$10.00
ECL-395-8	German - 15 Second - Green	\$10.00
ECL-395-9	German - 30 Second - Green	\$10.00
ECL-395-10	Chinese - 15 Second - Red	\$10.00
ECL-395-11	Chinese - 30 Second - Red	\$10.00
ECL-395-12	English European - 15 Second - Red	\$10.00
ECL-395-13	English European - 30 Second - Red	\$10.00
PUSH TO OPEN - ALARM WILL SOUND		
101802-1	English - Green	\$12.00
101802-2	French - Green	\$12.00
101802-3	German - Green	\$12.00
101802-4	Chinese - Red	\$12.00
101802-5	Spanish - Red	\$12.00
101802-6	French/Canadian - Red	\$12.00
Delayed Egress Outdoor Signage Chart		Price
PUSH UNTIL ALARM SOUNDS - DOOR CAN BE OPENED IN 15 SECONDS		
101906	English - 15 Second (Metal Sign - Non Adhesive)	\$50.00

VALUE SERIES®

V40 RIM DEVICE



(03 A shown)



(08 BN shown)

NOTE:
For all trim information and graphics see page 28

Outside Function	Device	Baseplate Finish	
		628 (Std.) Aluminum	711 Black
Device Only - Exit Only No Trim	V40	\$330.00	\$340.00

Outside Function	Device / Function / Trim	Baseplate Finish	
		628 (Std.) Aluminum	711 Black
03 Key Retracts Latch pull trim	V4003 P	\$385.00	\$395.00
	V4003 PN	\$385.00	\$395.00
	V4003 WS	\$465.00	\$475.00
02 Dummy Pull Trim	V4002 A	\$388.00	\$398.00
	V4002 AN	\$388.00	\$398.00
03 Key Retracts Latch Pull Trim	V4003 A	\$394.00	\$404.00
	V4003 AN	\$394.00	\$404.00
.....			
08 Key Locks/Unlocks Outside Lever	V4008 BN	\$510.00	\$520.00
09 Lever Active by Key; Locked when key removed	V4009 BN	\$510.00	\$520.00
14 Outside Lever Always Active	V4014 BN	\$510.00	\$520.00

DEVICE COMES STANDARD WITH:

- 628 Aluminum Baseplate
- HD Hex Dogging
- 36" 36" Device for 3 foot doors
- 99 Surface Strike



FINISHES

Aluminum device extrusion is BHMA 628
Aluminum Trims:
P and PN BHMA 628 (clear anodized aluminum)
WS BHMA 626 (brushed chrome)
A, AN and BN BHMA 689 (powder coated aluminum)

Black device extrusion is BHMA 711
Black Trims:
P and PN BHMA 711 (black anodized aluminum)
WS BHMA 613 (oil rubbed bronze)
A, AN and BN BHMA 693 (powder coated black)

OPTIONS

NS Narrow stile door option - Specify prefix NS for use on full 36" and 48" wide doors with 2" stile. 98 semi-mortise strike included. Add \$ 45.00

F Fire Rated - Specify prefix F (ex. FV40) Add \$ 50.00

H Hurricane Rated - Specify prefix H (ex. HV40) Add \$ 50.00

FH Fire Rated/Hurricane Rated - Specify prefix FH (ex. FHV40) Add \$100.00

Electrified Options - see pages 30-33

48" 48" Device for 4'0" doors Add \$ 20.00

KS Key Stop Installed Add \$ 5.00

CD Cylinder Dogging N/C*

LD Less Dogging N/C*

94 Double Door Strike Available - see pg 35

98 Semi-Mortise Strike N/C*



* N/C - No charge when ordered with device

MC65



IC7



NOTE - Cylinders not included. Products on this page can be ordered with cylinders (MC65) or Interchangeable core housings (IC7) pre-installed at Detex prior to shipping (See page 35).



VALUE SERIES®

V50 SERIES SURFACE VERTICAL ROD DEVICE

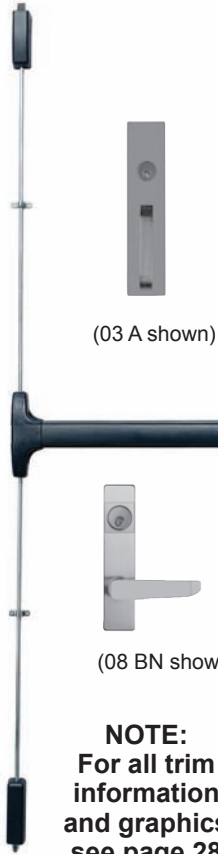

DEVICE COMES STANDARD WITH:

OPTIONS

MC65



IC7



Outside Function	Device	Baseplate Finish	
		628 (Std.) Aluminum	711 Black
Device Only - Exit Only No Trim	V50	\$635.00	\$645.00

Outside Function	Device / Function / Trim	Baseplate Finish	
		628 (Std.) Aluminum	711 Black
03 Key Retracts Latch pull trim	V5003P	\$690.00	\$700.00
	V5003PN	\$690.00	\$700.00
	V5003WS	\$770.00	\$780.00
02 Dummy Pull Trim	V5002A	\$693.00	\$703.00
	V5002AN	\$693.00	\$703.00
03 Key Retracts Latch Pull Trim	V5003A	\$699.00	\$709.00
	V5003 AN	\$699.00	\$709.00
08 Key Locks/Unlocks Outside Lever	V5008BN	\$815.00	\$825.00
09 Lever Trim Active by Key; Locked when key removed	V5009BN	\$815.00	\$825.00
14 Outside Lever Always Active	V5014BN	\$815.00	\$825.00

Note - Devices are shipped RHR unless specified LHR (Field Reversible)

FINISHES	
628 Aluminum Baseplate	Aluminum device extrusion is BHMA 628
HD Hex Dogging	Aluminum Trims:
36" 36" Device for 3 foot doors	P and PN BHMA 628 (clear anodized aluminum)
84" 84" Device for 7 foot doors	WS BHMA 626 (brushed chrome)
96 Surface Strike	A, AN and BN BHMA 689 (powder coated aluminum)
	Black device extrusion is BHMA 711
	Black Trims:
	P and PN BHMA 711 (black anodized aluminum)
	WS BHMA 613 (oil rubbed bronze)
	A, AN and BN BHMA 693 (powder coated black)

NS Narrow stile door option - Specify prefix NS for use on full 36" and 48" wide doors with 2" stile.	Add \$ 45.00
F Fire Rated - Specify prefix F (ex. FV50)	Add \$ 50.00
RC Rod Covers Stainless Steel Finish - (ex. V50xRC)	Add \$190.00
BG Bottom Bolt Guard 12" ramped per ADA - (ex. V50xBG)	Add \$110.00
RCxBG Rod Covers and Bottom Bolt Guard - (ex. V50xRCxBG)	Add \$300.00

Electrified Options - see pages 30-33

48" 48" Device for 4'0" doors	Add \$ 20.00
96" 96" Device for 8'0" doors	Add \$ 10.00
120" 120" Device for 10'0" doors	Add \$ 50.00
KS Key Stop Installed	Add \$ 5.00
CD Cylinder Dogging	N/C*
LD Less Dogging	N/C*
96B Dust Proof Strike	Add \$ 40.00

* N/C - No charge when ordered with device

NOTE - Cylinders not included. Products on this page can be ordered with cylinders (MC65) or Interchangeable core housings (IC7) pre-installed at Detex prior to shipping (See page 35).

Where Trust is Built™
DETEX®
 Life Safety and Security Door Hardware

VALUE SERIES®

V51 SERIES SURFACE VERTICAL ROD DEVICE - TOP ROD ONLY

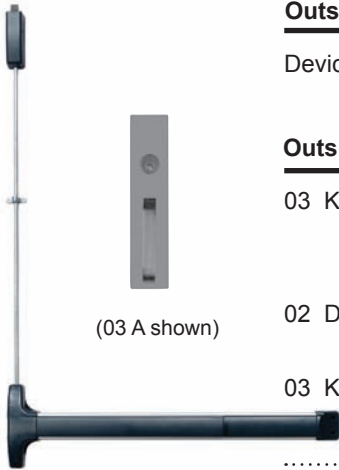

(03 A shown)



(08 BN shown)

Outside Function	Device	Baseplate Finish	
		628 (Std.) Aluminum	711 Black
Device Only - Exit Only No Trim	V51	\$635.00	\$645.00

Outside Function	Device / Function / Trim	Baseplate Finish	
		628 (Std.) Aluminum	711 Black
03 Key Retracts Latch pull trim	V5103P	\$690.00	\$700.00
	V5103PN	\$690.00	\$700.00
	V5103WS	\$770.00	\$780.00
02 Dummy Pull Trim	V5102A	\$693.00	\$703.00
	V5102AN	\$693.00	\$703.00
03 Key Retracts Latch Pull Trim	V5103A	\$699.00	\$709.00
	V5103 AN	\$699.00	\$709.00
08 Key Locks/Unlocks Outside Lever	V5108BN	\$815.00	\$825.00
09 Lever Trim Active by Key; Locked when key removed	V5109BN	\$815.00	\$825.00
14 Outside Lever Always Active	V5114BN	\$815.00	\$825.00

Note - Devices are shipped RHR unless specified LHR (Field Reversible)

NOTE:
For all trim information and graphics see page 28

DEVICE COMES STANDARD WITH:

- 628 Aluminum Baseplate
- HD Hex Dogging
- 36" 36" Device for 3 foot doors
- 84" 84" Device for 7 foot doors
- 96 Surface Strike



FINISHES

Aluminum device extrusion is BHMA 628
Aluminum Trims:
P and PN BHMA 628 (clear anodized aluminum)
WS BHMA 626 (brushed chrome)
A, AN and BN BHMA 689 (powder coated aluminum)

Black device extrusion is BHMA 711
Black Trims:
P and PN BHMA 711 (black anodized aluminum)
WS BHMA 613 (oil rubbed bronze)
A, AN and BN BHMA 693 (powder coated black)

OPTIONS

NS Narrow stile door option - Specify prefix NS for use on full 36" and 48" wide doors with 2" stile.	Add \$ 45.00
F Fire Rated - Specify prefix F (ex. FV51)	Add \$ 50.00
RC Rod Covers Stainless Steel Finish - (ex. V51xRC)	Add \$190.00
Electrified Options - see pages 30-33	
48" 48" Device for 4'0" doors	Add \$ 20.00
96" 96" Device for 8'0" doors	Add \$ 10.00
120" 120" Device for 10'0" doors	Add \$ 50.00
KS Key Stop Installed	Add \$ 5.00
CD Cylinder Dogging	N/C*
LD Less Dogging	N/C*

* N/C - No charge when ordered with device







MC65



IC7



NOTE - Cylinders not included. Products on this page can be ordered with cylinders (MC65) or Interchangeable core housings (IC7) pre-installed at Detex prior to shipping (See page 35).

P Trim for Value Series Devices		PN Trim for Value Series Devices		WS Trim for Value Series Devices	
 03P		 03PN		 03WS	
Function	Description	Trim	Aluminum (628 Std.) Finish	or	Black (711) Finish
03	Key retracts latch	P	\$ 55.00 (628 or 711 Finish Only)		
03	Key retracts latch	PN	\$ 55.00 (628 or 711 Finish Only)		
03	Key retracts latch	WS*	\$135.00* (626 Finish) \$176.00** (Other Finishes)		
A Trim for Value Series Devices S Handle		AN Trim for Value Series Devices S Handle		BN Trim for Value Series Devices (Include 161 cover plate)	
 02A 03A		 02AN 03AN		 08, 09BN 14BN S Lever - Standard	
Function	Description	Trim	Aluminum (689 Std.) Finish	or	Black (693) Finish
02	Dummy pull	A	\$ 58.00 (689 or 693 Finish Only)		
02	Dummy pull	AN	\$ 58.00 (689 or 693 Finish Only)		
03	Key retracts pull	A	\$ 64.00 (689 or 693 Finish Only)		
03	Key retracts pull	AN	\$ 64.00 (689 or 693 Finish Only)		
08	Key locks/unlocks outside lever	BN	\$180.00 (689 or 693 Finish Only)		
09	Lever trim active by key; locked when key removed	BN	\$180.00 (689 or 693 Finish Only)		
14	Outside lever always active	BN	\$180.00 (689 or 693 Finish Only)		

NOTE: Lever Trims are shipped RHR (Field Reversible)

Applies to WS Trim Only -

* 626 = Brushed Chrome

**OTHER FINISHES

605, 606, 611, 612, 613, 625

689 = Powder coated, Aluminum

693 = Powder coated, Black

PULLS & PLATES

BHMA Function	BHMA Definition	Description	VALUE SERIES®	Manufacturer A Exit Devices	Manufacturer B Exit Devices
			Standard Value Series	Standard 19-R Series	Standard 51 Series
02	Pull When Dogged	Dummy Pull	02A 02AN	910DT	702A
03	Key Retracts Latch Bolt	Night Latch Pull	03A; 03AN	NA/910NL	703A
			03P; 03PN	N/A/920NL	603
03	Key Retracts Latch Bolt	Night Latch - Cylinder Only - Pull by Others	03WS	930C	N/A

LEVER TRIMS

BHMA Function	BHMA Definition	Description	VALUE SERIES®	Manufacturer A Exit Devices	Manufacturer B Exit Devices
			Standard Value Series	Standard 19 Series	Standard 51 Series
08	Key Locks/Unlocks Lever	Classroom Lever	08BN	912L	808A
09	Lever Active by Key; Locked when key removed	Night Latch Lever / Storeroom Lever	09BN	912LNL	—
14	Lever Always Active	Passage Lever	14BN	912L-BE	814A

Exit Alarm (EB) - Battery Powered - Available on all VS Devices	Price
Standard Package Includes: - Switch Monitors Pushpad - Green & Red LED, cylinder arming, 9 Volt battery and piezo horn - Cylinder Dogging (CD) standard except for "F" (Fire Rated) device - Push Pad Signage "Push to Open Alarm Will Sound"	Add \$191.00
EB Options	
KS - Key Stop Option Installed at Factory	Add \$ 5.00
LD - Less Dogging	N/C
BLK - Black Push Pad - (includes peel & stick door signage - "Emergency Exit Only Alarm Will Sound")	N/C
LBM - Latch Bolt Monitoring - V40 only (alarm triggered by dead latch)	Add \$ 35.00
Weatherized Exit Alarm (EBxW) - Battery Powered - Available on V40 Devices Only	Price
Standard Package Includes: - Remote signaling, remote bypass, push pad monitoring - Green & Red LED, cylinder arming, 9 Volt battery and piezo horn - Cylinder Dogging (CD) standard except for "F" (Fire Rated) device - Push Pad Signage "Push to Open Alarm Will Sound"	Add \$405.00
EBxW Options	
KS - Key Stop Option Installed at Factory	Add \$ 5.00
LD - Less Dogging	N/C
BLK - Black Push Pad - (includes peel & stick door signage - "Emergency Exit Only Alarm Will Sound")	N/C
Exit Alarm (EH) - Hardwired 12V - 24 VAC - Available on all VS Devices	Price
Standard Package Includes: - Switch Monitors Push Pad - Cylinder Dogging (CD) standard except for "F" (Fire Rated) device - 120V to 12VAC Transformer and 9V Battery Backup - Flexible 3' Conduit Loop and End Cap Connector - Push Pad Signage "Push to Open Alarm Will Sound"	Add \$269.00
EH Accessories	
PT-5 - Power Transfer	Add \$117.00
EWH8-626 - Electric Hinge	Add \$265.00
EH Options	
KS - Key Stop Option Installed at Factory	Add \$ 5.00
LD - Less Dogging	N/C
BLK - Black Push Pad - (includes peel & stick door signage - "Emergency Exit Only Alarm Will Sound")	N/C
IN - 220V to 24VAC Transformer substituted for standard transformer	N/C
277 - 277V to 24VAC Transformer substituted for standard transformer	Add \$ 45.00
LBM - Latch Bolt Monitoring - V40 only (alarm triggered by dead latch)	Add \$ 35.00

ELECTRIFIED OPTIONS CONT'D ON PAGE 31

Exit Alarm with Remote Signal (EHxR) - Hardwired 12V - 24 VAC - Available on all VS Devices	Price
Standard Package Includes - Switch Monitors Push Pad - Cylinder Dogging (CD) standard except for "F" (Fire Rated) device - 120V to 12VAC Transformer and 9V Battery Backup - Flexible 3' Conduit Loop and End Cap Connector - Push Pad Signage "Push to Open Alarm Will Sound"	Add \$337.00
<u>EHxR Accessories</u>	
PT-5 - Power Transfer	Add \$117.00
EWH8-626 - Electric Hinge	Add \$265.00
<u>EHxR Options</u>	
KS - Key Stop Option Installed at Factory	Add \$ 5.00
LD - Less Dogging	N/C
BLK - Black Push Pad - (includes peel & stick door signage - "Emergency Exit Only Alarm Will Sound")	N/C
IN - 220V to 24VAC Transformer substituted for standard transformer	N/C
277 - 277V to 24VAC Transformer substituted for standard transformer	Add \$ 45.00
LBM - Latch Bolt Monitoring (alarm triggered by dead latch)	Add \$ 35.00
Electric Dogging (ED) - Available on V40 Devices Only	Price
Standard Package Includes: - On-board switching requires initial manual push pad depression after electric activation - Long-term dogging (Note: A Power Supply or Transformer is required for ED but not included in Standard Package)	Add \$371.00
<u>ED Accessories</u>	
PP-5152-2 24VAC Transformer	Add \$ 36.00
80-800 Power Supply for filtered, regulated power and simplified fire loop connections	(See Page 37)
FC - Flexible 3' Conduit Loop and End Cap Connector	Add \$ 27.00
PT-5 - Power Transfer	Add \$117.00
EWH8-626 - Electric Hinge	Add \$265.00
<u>ED Options</u>	
IN - 220V to 24VAC Transformer substituted for standard transformer	N/C
EX - Request to Exit Switching (example EDxEX)	Add \$123.00
Electric Latch Retraction (ER) - Available on V40 Devices Only	Price
Standard Package Includes - Simultaneous latch and push pad retraction - Long term dogging capability - Switches to monitor push pad, latch bolt and outside trim input (Note: A Logic Controller and Power Supply is required for ER but not included in standard package)	Add \$675.00
<u>ER Accessories</u>	
81-800, 82-800 or 83-800 Logic Controller & Power Supply for Electric Latch Retraction	(See Page 37)
FC - Flexible 3' Conduit Loop and End Cap Connector	Add \$ 27.00
PT-5 - Power Transfer	Add \$117.00
EWH8-626 - Electric Hinge	Add \$265.00
EX - Request to Exit Switching (example ERxEX)	Add \$123.00

ELECTRIFIED OPTIONS CONT'D ON PAGE 32

VALUE SERIES® ELECTRIFIED OPTIONS CONT'D

Delayed Egress (EE) - Available on V40 Devices Only	Price
Standard Package Includes: - 15 second Delayed Egress with dead latch monitoring - 24V Filtered and Regulated Power Supply with simplified fire loop connections. (NOTE: Detex Power Supply required and included with standard EE Package) - Cylinder Dogging (CD) standard except "F" (Fire Rated) device - Delayed Egress Door Sign (ECL-395 English, 15 seconds, Red) - Flexible 3' Conduit Loop and End Cap Connector - Push Pad Signage "Push to Open Alarm Will Sound"	Add \$1,240.00
EE Accessories	
PT-5 - Power Transfer	Add \$ 117.00
EWH8-626 - Electric Hinge	Add \$ 265.00
EE Options	
KS - Key Stop Option Installed at Factory	Add \$ 5.00
LD - Less Dogging	N/C
30 - 30 Second Delayed Egress (example EEx30)	N/C
Substitute Door Signage Available in various languages (See Accessories - page 36)	N/C
BLK - Black Push Pad - (includes peel & stick door signage - "Emergency Exit Only Alarm Will Sound")	N/C
Delayed Egress Magnetic Locking (EM) - Available on V40 Devices Only	Price
Standard Package Includes: - 15 second Delayed Egress with dead latch monitoring - 24V Filtered and Regulated Power Supply with simplified fire loop connections. (NOTE: Detex Power Supply required and included with standard EM Package) - Cylinder Dogging (CD) standard except for "F" (Fire Rated) device - Magnetic Lock - Delayed Egress Door Sign (ECL-395 English, 15 seconds, Red) - Flexible 3' Conduit Loop and End Cap Connector - Push Pad Signage "Push to Open Alarm Will Sound"	Add \$1,523.00
EM Accessories	
PT-5 - Power Transfer	Add \$ 117.00
EWH8-626 - Electric Hinge	Add \$ 265.00
EM Options	
KS - Key Stop Option Installed at Factory	Add \$ 5.00
LD - Less Dogging	N/C
30 - 30 Second Delayed Egress (example EMx30)	N/C
Substitute Door Signage Available in various languages (See Accessories - Page 36)	N/C
BLK - Black Push Pad - (includes peel & stick door signage)	N/C
Electric Integration (EI) - Available on V40 Devices Only	Price
Standard Package Includes: - Switches to monitor dead latch and outside trim input - Green and Red LED, cylinder arming and piezo horn (logic & power supply separate) - Cylinder Dogging (CD) standard except for "F" (Fire Rated) device - Black Push Pad with peel and stick door signage "Push To Exit Alarm Will Sound" (Note: A Logic Controller & Power Supply is required for EI but not included in standard package)	Add \$ 157.00
EI Accessories	
10-800 or 11-800 - Logic Controller & Power Supply for Electric Integration	(See Page 62)
FC - Flexible 3' Conduit Loop and End Cap Connector	Add \$ 27.00
PT-5 - Power Transfer	Add \$ 117.00
EWH8-626 - Electric Hinge	Add \$ 265.00
EI Options	
KS - Key Stop Option Installed at Factory	Add \$ 5.00
LD - Less Dogging	N/C
RWE - Red Push Pad with white signage (English) other languages available	N/C

ELECTRIFIED OPTIONS CONT'D ON PAGE 33

VALUE SERIES® ELECTRIFIED OPTIONS CONT'D

Electric Switching (ES) - Available on V40 Devices Only	Price
Standard Package Includes:	Add \$145.00
- Switching monitors dead latch and outside trim input	
- HD (Hex Dogging) standard except for "F" (Fire Rated) device	
- Black Push Pad with peel and stick door signage "Push to Exit Alarm Will Sound"	
<u>ES Accessories</u>	
PT-5 - Power Transfer	Add \$117.00
EWH8-626 - Electric Hinge	Add \$265.00
<u>ES Options</u>	
FC - Flex 3' Conduit Loop and End Cap Connector	Add \$ 27.00
CD - Cylinder Dogging	N/C
LD - Less Dogging	N/C
RWE - Red Push Pad with white signage (English) other languages available	N/C
Request to Exit Signaling (EX) - Available on all VS Devices	Price
Standard Package Includes:	Add \$123.00
- Switch monitors push pad	
- Hex Dogging (HD) standard except for "F" (Fire Rated) device	
- Black Push Pad with peel and stick door signage "Push To Exit Alarm Will Sound"	
<u>EX Accessories</u>	
PT-5 - Power Transfer	Add \$117.00
EWH8-626 - Electric Hinge	Add \$265.00
<u>EX Options</u>	
V - Substitute 3 AMP switch for signal switch	Add \$ 80.00
FC - Flex 3' Conduit Loop and End Cap Connector	Add \$ 27.00
CD - Cylinder Dogging	N/C
LD - Less Dogging	N/C
RWE - Red Push Pad with white signage (English) other languages available	N/C
Weatherized Request to Exit Signaling (EXxW) - Available on all VS Devices	Price
Standard Package Includes:	Add \$145.00
- Weatherized Switch monitors push pad	
- Hex Dogging (HD) standard except for "F" (Fire Rated) device	
- Black Push Pad with peel and stick door signage "Push To Exit Alarm Will Sound"	
<u>EXxW Accessories</u>	
PT-5 - Power Transfer	Add \$117.00
EWH8-626 - Electric Hinge	Add \$265.00
<u>EXxW Options</u>	
VxW - Substitute 3 AMP weatherized switch for signal switch	Add \$ 80.00
FC - Flexible 3' Conduit Loop and Weather Resistant End Cap Connector - (Order Separately)	\$ 46.00
CD - Cylinder Dogging	N/C
LD - Less Dogging	N/C
RWE - Red Push Pad with White Signage (English) other languages available	N/C

	Base Price	EB	EBXW	ED	EE	EH	EHR	EI	EM	ER	ES	EX	EXXW
V40 Rim (device only)	\$330	\$191	\$405	\$371	\$1,240	\$269	\$337	\$157	\$1,523	\$675	\$145	\$123	\$145
V4003 P (key retracts latch pull trim)	\$385	521	735	701	1570	599	667	487	1853	1005	475	453	475
V4003 PN (key retracts latch pull trim)	\$385	576	790	756	1625	654	722	542	1908	1060	530	508	530
V4003 WS (key retracts latch pull trim)	\$465	576	790	756	1625	654	722	542	1908	1060	530	508	530
V4002 A (dummy pull)	\$388	656	870	836	1705	734	802	622	1988	1140	610	588	610
V4002 AN (dummy pull)	\$388	579	793	759	1628	657	725	545	1911	1063	533	511	533
V4003 A (key retracts latch pull trim)	\$394	579	793	759	1628	657	725	545	1911	1063	533	511	533
V4003 AN (key retracts latch pull trim)	\$394	585	799	765	1634	663	731	551	1917	1069	539	517	539
V4008 BN (key locks/unlocks outside lever)	\$510	585	799	765	1634	663	731	551	1917	1069	539	517	539
V4009 BN (lever active by key; locked when key removed)	\$510	701	915	881	1750	779	847	667	2033	1185	655	633	655
V4014 BN (outside lever always active)	\$510	701	915	881	1750	779	847	667	2033	1185	655	633	655

	Base Price	EB	EBXW	ED	EE	EH	EHR	EI	EM	ER	ES	EX	EXXW
V50 Surface Vertical Rod (device only)	\$635	\$191	N/A	N/A	N/A	\$269	\$337	N/A	N/A	N/A	N/A	\$123	\$145
V5003 P (key retracts latch pull trim)	\$690	826	N/A	N/A	N/A	\$904	972	N/A	N/A	N/A	N/A	758	780
V5003 PN (key retracts latch pull trim)	\$690	881	N/A	N/A	N/A	\$1,150	1027	N/A	N/A	N/A	N/A	813	835
V5003 WS (key retracts latch pull trim)	\$770	881	N/A	N/A	N/A	\$1,150	1027	N/A	N/A	N/A	N/A	813	835
V5002 A (dummy pull)	\$693	961	N/A	N/A	N/A	\$1,039	1107	N/A	N/A	N/A	N/A	893	915
V5002 AN (dummy pull)	\$693	884	N/A	N/A	N/A	\$962	1030	N/A	N/A	N/A	N/A	816	838
V5003 A (key retracts latch pull trim)	\$699	884	N/A	N/A	N/A	\$962	1030	N/A	N/A	N/A	N/A	816	838
V5003 AN (key retracts latch pull trim)	\$699	890	N/A	N/A	N/A	\$968	1036	N/A	N/A	N/A	N/A	822	844
V5008 BN (key locks/unlocks outside lever)	\$815	890	N/A	N/A	N/A	\$968	1036	N/A	N/A	N/A	N/A	822	844
V5009 BN (lever active by key; locked when key removed)	\$815	1006	N/A	N/A	N/A	\$1,084	1152	N/A	N/A	N/A	N/A	938	960
V5014 BN (outside lever always active)	\$815	1006	N/A	N/A	N/A	\$1,084	1152	N/A	N/A	N/A	N/A	938	960

	Base Price	EB	EBXW	ED	EE	EH	EHR	EI	EM	ER	ES	EX	EXXW
V51 Surface Vertical Rod (TRO) device only	\$635	\$191	N/A	N/A	N/A	\$269	\$337	N/A	N/A	N/A	N/A	\$123	\$145
V5103 P (key retracts latch pull trim)	\$690	826	N/A	N/A	N/A	\$904	972	N/A	N/A	N/A	N/A	758	780
V5103 PN (key retracts latch pull trim)	\$690	881	N/A	N/A	N/A	\$1,150	1027	N/A	N/A	N/A	N/A	813	835
V5103 WS (key retracts latch pull trim)	\$770	881	N/A	N/A	N/A	\$1,150	1027	N/A	N/A	N/A	N/A	813	835
V5102 A (dummy pull)	\$693	961	N/A	N/A	N/A	\$1,039	1107	N/A	N/A	N/A	N/A	893	915
V5102 AN (dummy pull)	\$693	884	N/A	N/A	N/A	\$962	1030	N/A	N/A	N/A	N/A	816	838
V5103 A (key retracts latch pull trim)	\$699	884	N/A	N/A	N/A	\$962	1030	N/A	N/A	N/A	N/A	816	838
V5103 AN (key retracts latch pull trim)	\$699	890	N/A	N/A	N/A	\$968	1036	N/A	N/A	N/A	N/A	822	844
V5108 BN (key locks/unlocks outside lever)	\$815	890	N/A	N/A	N/A	\$968	1036	N/A	N/A	N/A	N/A	822	844
V5109 BN (lever active by key; locked when key removed)	\$815	1006	N/A	N/A	N/A	\$1,084	1152	N/A	N/A	N/A	N/A	938	960
V5114 BN (outside lever always active)	\$815	1006	N/A	N/A	N/A	\$1,084	1152	N/A	N/A	N/A	N/A	938	960

Where Trust is Built™





Electric Slide-In Filler Kits (For Service & Repair Parts - Contact Factory)			Price	
SIFV-EB	Exit Alarm 9VDC (Battery Powered) Includes push pad monitoring	SIFV-EB-36"	\$212.00	
		SIFV-EB-48"	\$223.00	
SIFV-EB-W	Weatherized Exit Alarm 9VDC (Battery Powered) Includes push pad monitoring, remote signal & remote bypass	SIFV-EB-W-36"	\$318.00	
		SIFV-EB-W-48"	\$329.00	
SIFV-EH	Exit Alarm 12VAC - 24VAC (Hardwired) Includes push pad monitoring	SIFV-EH-36"	\$292.00	
		SIFV-EH-48"	\$302.00	
SIFV-EH-R	Exit Alarm 12VAC - 24 VAC (Hardwired) Includes push pad monitoring & remote signal	SIFV-EH-R-36"	\$350.00	
		SIFV-EH-R-48"	\$360.00	
SIFV-EX	Request to Exit Switching Includes push pad monitoring Specify Cylinder Dogging (CD), Less Dogging (LD) or Hex Dogging (HD)	SIFV-EX-36"	\$ 90.00	
		SIFV-EX-48"	\$101.00	
SIFV-EX-W	Weatherized Request to Exit Switching Includes weatherized push pad monitoring Specify Cylinder Dogging (CD), Less Dogging (LD) or Hex Dogging (HD)	SIFV-EX-W-36"	\$111.00	
		SIFV-EX-W-48"	\$122.00	
Relay Kits			Price	
RLY12	12 VAC Relay Kit - For use with 12V alarms that have remote bypass feature Used with remote bypass to shunt alarm and activate another electrified device - Separate J-Box required		\$ 43.00	
RLY24	24 VAC Relay Kit - For use with 24V alarms that have remote bypass feature Used with remote bypass to shunt alarm and activate another electrified device - Separate J-Box required		\$ 43.00	
HD-CD-LD Slide-In Filler Kits			Price	
SIFV-LD	Less Dogging Slide-In Filler Kit	SIFV-LD-36"	\$ 16.00	
		SIFV-LD-48"	\$ 21.00	
SIFV-HD	Hex Key Dogging Slide-In Filler Kit	SIFV-HD-36"	\$ 37.00	
		SIFV-HD-48"	\$ 42.00	
SIFV-CD	Cylinder Dogging Slide-In Filler Kit	SIFV-CD-36"	\$ 42.00	
		SIFV-CD-48"	\$ 48.00	
Cylinders and Accessories			Price	Price
				(Factory Installed)
MC65	Mortise Cylinder, Schlage "C" Keyway, 1-1/8" 6-pin, Keyed 5-pin Specify Finish	\$ 27.00	\$ 60.00	
IC7	7-pin SFIC Mortise Cylinder Housing (Core not included)	\$ 27.00	\$ 60.00	
RC65	Rim Cylinder, Schlage "C" Keyway, 6-pin, Keyed 5-pin (Also known as ECL-445K) Specify Finish	\$ 27.00	\$ 60.00	
CCL	Cylinder Collar, Long 11/16" Specify Finish	\$ 18.00		
CCS	Cylinder Collar, Short 7/16" Specify Finish	\$ 15.00		
CBK	Cylinder Bracket Kit (for rim cylinder used with other manufacturer's trim)	\$ 25.00		
SE-2	Shaft Extension Kit for Lever Trims for 2 - 2 1/2" thick door (For other door thicknesses, contact factory)	\$ 32.00		
Strike Kits			Price	
94	Double Door Strike Kit with Tamper Resistant and Standard Fasteners (no security driver required)		\$ 51.00	
96	Surface Non-Roller Strike (for V50/V51 Series Devices)		\$ 30.00	
96B	Dust Proof Strike (for V50 Series Devices)		\$ 27.00	
98	Semi-Mortise Strike		\$ 32.00	
99	Surface Strike		\$ 30.00	
SHK1	Strike Hook Kit (1 per package)		\$ 12.00	
Hex Dogging Key			Price	
HDK	Hex Dogging Key		\$ 2.00	



PARTS/ACCESSORIES CONT'D ON PAGE 36

Mounting Accessories		Price		
NSK	Narrow Stile Door Kit (not available for Delayed Egress) Converts Standard Value Series Device to fit 2" stile - Specify Device Finish: 628 or 711		\$ 45.00	
SN1	Sex Nut Kit 1/4"-20 (2 per pkg) Specify Finish: 606,613,626		\$ 10.00	
SSK3	Torx® Security Screw Kit for Value Series Includes security tip driver and tamper resistant fasteners		\$ 21.00	
Glass Bead Kit		Price		
GB15	Glass Bead Kit - V40 Series (Used as 1/4" shim for flush doors with light kit moldings)		\$ 39.00	
Flexible Conduit Loop Kits, Armored Cable Kits and Power Transfers			Price	
FCV	Flex Conduit Kit includes conduit, end cap and fittings	FCV-3'	\$ 37.00	
		FCV-10'	\$ 48.00	
FCV-W	Weatherized Flex Conduit Kit includes conduit, end cap, fittings and waterproof wire nuts	FCV-W-3'	\$ 46.00	
		FCV-W-10'	\$ 56.00	
AL18	Surface Mount Flex Armor Loop, Alum Finish, 18" Mounted to door and wall		\$ 50.00	
JB1	Junction Box - Flex Conduit Kit (for use with EM to run wires to Magnetic Lock)		\$ 64.00	
PT-5	Power Transfer		\$117.00	
EWH8-626	Electric Hinge		\$265.00	
Delayed Egress Peel and Stick Door Signage Chart			Delayed Egress Outdoor Signage Chart	
PUSH UNTIL ALARM SOUNDS - DOOR CAN BE OPENED IN XX SECONDS			PUSH UNTIL ALARM SOUNDS - DOOR CAN BE OPENED IN 15 SECONDS	
		Price		Price
ECL-395	English - 15 Second -Red (Standard)	\$10.00	101906 English - 15 Second (Metal Sign - Non Adhesive)	\$50.00
ECL-395-1	English - 30 Second - Red	\$10.00		
ECL-395-2	French/Canadian - 15 Second - Red	\$10.00		
ECL-395-3	French/Canadian - 30 Second - Red	\$10.00		
ECL-395-4	Spanish - 15 Second - Red	\$10.00		
ECL-395-5	Spanish - 30 Second - Red	\$10.00		
ECL-395-6	French - 15 Second - Green	\$10.00		
ECL-395-7	French - 30 Second - Green	\$10.00		
ECL-395-8	German - 15 Second - Green	\$10.00		
ECL-395-9	German - 30 Second - Green	\$10.00		
ECL-395-10	Chinese - 15 Second - Red	\$10.00		
ECL-395-11	Chinese - 30 Second - Red	\$10.00		
ECL-395-12	English European - 15 Second - Red	\$10.00		
ECL-395-13	English European - 30 Second - Red	\$10.00		
PUSH TO OPEN - ALARM WILL SOUND				
101802-1	English - Green	\$12.00		
101802-2	French - Green	\$12.00		
101802-3	German - Green	\$12.00		
101802-4	Chinese - Red	\$12.00		
101802-5	Spanish - Red	\$12.00		
101802-6	French/Canadian - Red	\$12.00		
Optional Push Pad Door Signage Chart			Price	
PUSH TO OPEN - ALARM WILL SOUND			36"	48"
RWE	English - Red (Standard)	\$ 5.00	\$ 6.00	
GWE	English - Green	\$12.00	\$13.00	
GWF	French - Green	\$12.00	\$13.00	
GWG	German - Green	\$12.00	\$13.00	
RWC	Chinese - Red	\$12.00	\$13.00	
RWS	Spanish - Red	\$12.00	\$13.00	
RWFC	French/Canadian -Red	\$12.00	\$13.00	

POWER SUPPLY PRODUCTS

	MODEL NO.	DESCRIPTION	SUGGESTED LIST PRICE
	80-800 *	Power Supply - 1.0A continuous Can be used with ED, EE, EM products	\$ 318.00
	81-800 *	Controller and Power Supply - 1 Amp continuous Powers and controls ER device for 1 door with signal output for 1 operator	\$ 650.00
	82-800 *	Controller and Power Supply - 2 Amp continuous Powers and controls ER device for 1 pair of doors with signal output for 1 operator	\$ 695.00
	83-800 *	Controller and Power Supply - 2 Amp continuous Powers and controls ER device for 2 independent doors with signal output for 2 operators	\$1,051.00
	84-800 *	Controller and Power Supply - 1 Amp continuous Powers and controls EExER device for 1 door with signal output for 1 operator	\$1,325.00
	85-800 *	Controller and Power Supply - 2 Amp continuous Powers and controls EExER device for 2 independent doors with signal output for 2 operators	\$1,725.00
NOTE: Battery Charging Circuit included on all above (Battery sold separately)			
	90-800 *	120VAC/24VDC Power Supply - 1.0A continuous Can be used with ED, EE, EM products	\$ 318.00
*Cover lock and keys not included - See Power Supply Accessories (below) to order lock			

POWER SUPPLY ACCESSORIES

	MODEL NO.	DESCRIPTION	SUGGESTED LIST PRICE
	70-12B	Battery 12VDC 4AH	\$ 46.00
	70-24B	Battery 24VDC 4AH - 2 batteries provided Includes linking cable (Battery Box not Included)	\$ 90.00
	L	Cover Lock and 2 keys	ADD \$ 8.00
	M12	12 Volt Module	ADD \$ 127.00
Signage - ECL-395 (see page 36) and EA-561 (see page 51) sold separately			

90 SERIES MULLIONS

Keyed Removable Mullions For use with
Advantex® & Value Series® Devices



Rim Cylinder
Not Included

Standard Mullions	Price
90KR - Keyed Removable Mullion - 7 foot	\$595.00
90KR - Keyed Removable Mullion - 8 foot	\$595.00
90KR - Keyed Removable Mullion - 10 foot	\$655.00
Fire Rated Mullions	Price
F90KR - Fire rated Keyed Removable Mullion - 7 foot	\$695.00
F90KR - Fire rated Keyed Removable Mullion - 8 foot	\$695.00

Shipped less rim cylinder - Rim Cylinder available at additional cost (see page 46)



NOTE: Fire Rated Listing allows field location of strike. Detex Fire Rated Mullion can be strike prepped in the field.

Detex Fire Rated Mullion can be used with other manufacturers exit devices that are fire rated for pairs of doors with a Mullion.

AO19 SERIES® LOW ENERGY AUTOMATIC DOOR OPERATORS FOR SINGLE DOOR APPLICATIONS

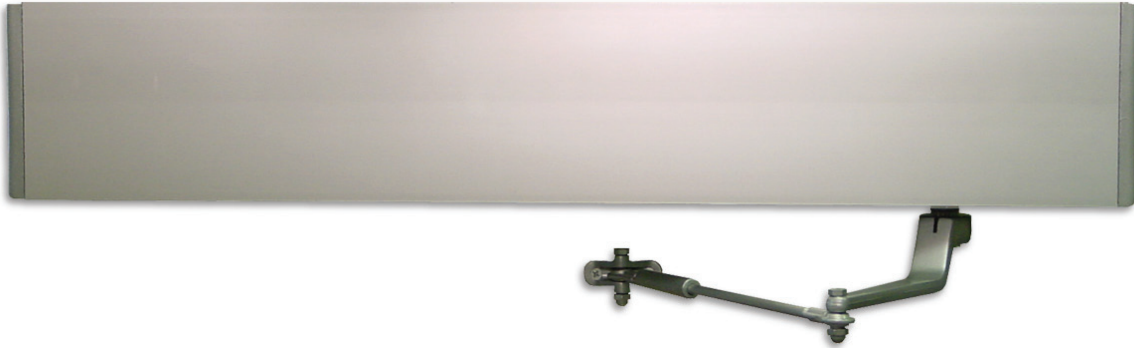

**Effective
Immediately
Price Reduction**

Model Number	Description	Finish		Finish	
		Clear (xAL)	Bronze (xBZ)	Clear (xAL)	Bronze (xBZ)
AO19-1xLH Push	Single Door Left Hand Push	\$4,354.00	\$4,465.00	\$3,400.00	\$3,400.00
AO19-1xRH Push	Single Door Right Hand Push	\$4,354.00	\$4,465.00	\$3,400.00	\$3,400.00
AO19-1xLH Pull	Single Door Left Hand Pull	\$4,490.00	\$4,596.00	\$3,400.00	\$3,400.00
AO19-1xRH Pull	Single Door Right Hand Pull	\$4,490.00	\$4,596.00	\$3,400.00	\$3,400.00

FINISHES:

AL - 204-Ri Clear Arch. Class II anodized coating, AA-M12C22A31 (Std.)

BZ - 313-Ri Dark Bronze Arch. Class II anodized coating, AA-M1q2C22A32

DEVICE COMES
STANDARD
WITH: AL - Clear Finish
39.5" Device for 3 foot doors

OPTIONS	45.5" Device for 4 foot doors	Add \$410.00	N/C
---------	-------------------------------	-------------------------	-----

AO19 SERIES® LOW ENERGY AUTOMATIC DOOR OPERATORS FOR DOUBLE DOOR APPLICATIONS



**Effective
Immediately
Price Reduction**

Model Number	Description	Finish		Finish	
		Clear (xAL)	Bronze (xBZ)	Clear (xAL)	Bronze (xBZ)
AO19-2 Push	Double Door Push	\$8,701.00	\$8,973.00	\$6,420.00	\$6,420.00
AO19-2 Pull	Double Door Pull	\$8,973.00	\$9,381.00	\$6,420.00	\$6,420.00
DEVICE COMES STANDARD WITH:		FINISHES: AL - 204-Ri Clear Arch. Class II anodized coating, AA-M12C22A31 (Std.) BZ - 313-Ri Dark Bronze Arch. Class II anodized coating, AA-M1Q2C22A32			
OPTIONS	92" Device for pairs of 4 foot doors	Add \$950.00		N/C	

AO19 SERIES® LOW ENERGY AUTOMATIC DOOR OPERATORS FOR DOUBLE EGRESS DOOR APPLICATIONS



**Effective
Immediately
Price Reduction**

Model Number	Description	Finish		Finish	
		Clear (xAL)	Bronze (xBZ)	Clear (xAL)	Bronze (xBZ)
AO19-3xRH Push	Double Egress Doors RH Push / RH Pull	\$8,837.00	\$9,245.00	\$6,420.00	\$6,420.00
AO19-3xLH Push	Double Egress Doors LH Push / LH Pull	\$8,837.00	\$9,245.00	\$6,420.00	\$6,420.00

FINISHES:

AL - 204-Ri Clear Arch. Class II anodized coating, AA-M12C22A31 (Std.)

BZ - 313-Ri Dark Bronze Arch. Class II anodized coating, AA-M1q2C22A32

DEVICE COMES
STANDARD
WITH:

AL - Clear Finish
75.5" Device for pairs of
3 foot doors

OPTIONS

92" Device for pairs of 4 foot double egress doors

~~Add \$950.00~~

N/C

**AO19 SERIES® LOW ENERGY
AUTOMATIC DOOR
OPERATORS
PARTS/ACCESSORIES**



**Effective
Immediately
Price Reduction**

Part Number	Description	Price	Price
104798-1	3-Point Push Arm Assembly AL	\$ 680.00	\$ 190.00
104798-2	3-Point Push Arm Assembly BZ	\$ 680.00	\$ 190.00
104797-1	Parallel Arm Pull Assembly AL	\$ 680.00	\$ 210.00
104797-2	Parallel Arm Pull Assembly BZ	\$ 680.00	\$ 210.00
104796-1	Motor / Gearbox LH Push	\$2,719.00	\$1,000.00
104796-2	Motor / Gearbox LH Pull	\$2,719.00	\$1,000.00
104796-3	Motor / Gearbox RH Push	\$2,719.00	\$1,000.00
104796-4	Motor / Gearbox RH Pull	\$2,719.00	\$1,000.00
104795	Microswitch Harness	\$ 190.00	\$ 70.00
104794	3-Position Switch & Wire Assembly	\$ 190.00	\$ 80.00
104793	Universal Control	\$1,795.00	\$ 700.00
104792	Wireless Button Pkg. - 2 buttons, box & receiver	\$ 952.00	\$ 370.00
104790	D 97 Safety - Presence Detector	\$1,088.00	\$ 400.00
104788-1	4.5 Square Post with wireless button - Aluminum	\$1,496.00	\$ 600.00
104788-2	4.5 Square Post with wireless button - Bronze	\$1,496.00	\$ 600.00
104787	Caution Automatic Door - Activate Switch Decal	\$ 42.00	\$ 24.00
104785	ISP Synchronization Cable	\$ 84.00	\$ 40.00
104786	Vestibule Package #3	\$2,654.00	\$ 650.00

EXIT CONTROL HARDWARE DEAD BOLTS

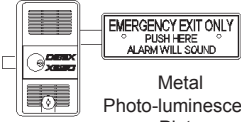

ECL-230 SERIES

 Metal Photo-luminescent Plate	MODEL NO.	DESCRIPTION	SUGGESTED LIST PRICE
	ECL-230D	UL Listed Panic Hardware Exit Control Lock	\$334.00
 Metal Photo-luminescent Plate	ECL-230D-PH	UL Listed Panic Hardware Standard Exit Control Lock w/Long Bar 36" to 48" Door Width	\$371.00
Supplied with: *9 volt battery *cover lock w/2 keys *ECL-437 & ECL-439 Keepers Available in Gray or Black *English paddle bar plate (ECL-8220 w/ECL-230D or ECL-2109 w/ECL-230D-PH) *Shipped less rim cylinder - Rim cylinder available at additional cost (see page 46) *Foreign language paddle bar plates available (see page 44)			

FIRE RATED HARDWARE

ECL-600

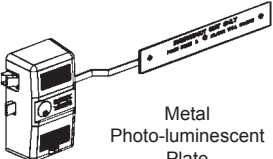
 Metal Photo-luminescent Plate	MODEL NO.	DESCRIPTION	SUGGESTED LIST PRICE
	ECL-600	Warnock Hersey Listed Fire Exit Hardware w/Long Bar 36" to 48" Door Width	\$555.00
3 Hour Listing - Single Door to 4' x 8' - Double Doors to 8' x 8' Supplied with: *9 volt battery *cover lock w/2 keys Available in Gray or Black *Keeper & strike kit *English paddle bar plate - ECL-2109 *Shipped less control cylinders *Rim cylinders available at additional cost (see page 46)			

ECL-620 Outside Lever Trim for ECL-600

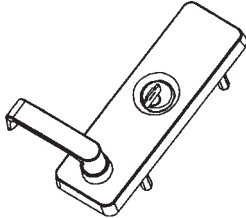
	MODEL NO.	DESCRIPTION	SUGGESTED LIST PRICE
	ECL-620	Outside Lever Trim Lever retracts latch bolt only Rim Cylinder (not included) operates dead bolt Finish: Black only Field Reversible	\$252.00

Accessories - ECL-230 and ECL-600 Series



	MODEL NO.	DESCRIPTION	SUGGESTED LIST PRICE
	ECL-2105K	Field Conversion Kit For 36" to 48" Door Width with metal Photo-luminescent plate (ECL-8220)	\$59.00
	ECL-436K	Bar Guard Kit (For use with Standard ECL-230D)	\$22.00
	ECL-2100K	Bar Guard Kit (For use with ECL-230D-PH & ECL-600)	\$35.00
	ECL-475K	Decorative Back Plate Kit	\$35.00
	ECL-498K	Outside Pull and Warning Sign (Not for use on Fire Rated Doors)	\$92.00
	ECL-2111K	6V-to-9V Conversion Kit (For use with ECL-230D and ECL-230C models only)	\$59.00
 (Metal Photo-Luminescent Plate)	ECL-8220 (RWE) ECL-2109	ECL-230D Metal Exit Bar Plates Specify: English ECL-230D-PH and ECL-600 Metal Exit Bar Plates Specify: English	\$17.00 \$21.00
	ECL-8225-8 (RWS) ECL-8225-5 (RWI) ECL-8225-6 (RWC) ECL-8225-9 (GWC) ECL-8225-7 (RWF) ECL-8225-1 (RWD) ECL-8225-2 (GWF) ECL-8225-3 (RWG) 101248-1 101248-2 101248-3	ECL-230D Exit Bar Plates Specify: Spanish Italian Chinese (Red) Chinese (Green) French Canadian Dutch French German ECL-230D-PH and ECL-600 Exit Bar Plates Specify: French Canadian Chinese (Red) Chinese (Green) for PH	\$17.00 \$17.00 \$17.00 \$17.00 \$17.00 \$17.00 \$17.00 \$17.00 \$17.00 \$28.00 \$28.00 \$28.00

Keeper and Strike Kits - ECL-230

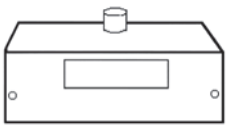

	MODEL NO.	DESCRIPTION	SUGGESTED LIST PRICE
	ECL-439K	Mortise Strike Plate Kit	\$ 8.00
	ECL-435K	Adjustable Surface Keeper "L" & "Z" bracket for double door applications	\$ 16.00
	ECL-437K	Adjustable Surface (standard)	\$ 10.00
	All Strikes Non- Handed		

	MODEL NO.	DESCRIPTION	SUGGESTED LIST PRICE
	DDH-2250	Double Door Holder (ECL-230 Series and V40 Series)	\$ 89.00

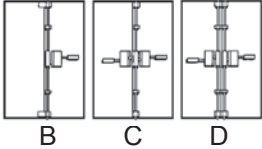
Vertical Rod Assemblies - For Use With ECL-230 Only

  	MODEL NO.	DESCRIPTION	SUGGESTED LIST PRICE
	VRA-143 (B,C) 84" Standard	Inside Locking Only (B,D) (For Outside Locking Order Type "C")	\$ 394.00
	VRA-143 (D) 84" Standard	Application: Each Leaf Independent	\$ 780.00
	Installation Type B/C	Special Heights over 84" to 96"	\$ 482.00
	Installation Type D		\$ 964.00
	Installation Type B/C	Over 96"	\$ 550.00
	Installation Type D		\$1,093.00
	Specify actual door opening height up to 120". Specify type of installation to be made - B, C, or D. Note: VRA-143B can also be used for a single door application to provide 2-point latching.		

Cylinders and Accessories



MODEL NO.	DESCRIPTION	SUGGESTED LIST PRICE
RC65 (Also known as -ECL-445K) 	Rim Cylinder, Schlage "C" Keyway with 2 keys	\$ 27.00
MC65 	Mortise Cylinder, Schlage "C" Keyway, 626 Brushed Chrome Finish with 2 keys	\$ 27.00
IC7 	Interchangeable Core Mortise Cylinder Housing, Small Format (Core not included)	\$ 27.00
ECL-470	Extra key for RC65 or MC65 (Specify Key #)	\$ 5.00
CBK	Cylinder Bracket Kit for use with rim cylinders and Non-Detex trims Includes spring-loaded tailpiece assembly	\$ 25.00
ECL-1595	Standard Cylinder Collars for use with ECL-230 Series & ECL-620	\$ 2.00
CCS	Short Cylinder Collar (7/16") accommodates most 5- and 6-pin mortise cylinders	\$ 15.00
CCL	Long Cylinder Collar (11/16") for most 7-pin and 6-and 7-pin interchangeable core cylinders Brushed Chrome Finish	\$ 18.00
NOTE: All cylinders are keyed different. Keyed alike is available upon request.		

DX Bolts

	MODEL NO.	DESCRIPTION	SUGGESTED LIST PRICE
	DX1	1 Bolt and Through Bolt Mounting Hardware Available in Gray (Std.) or Black - Specify Finish	\$ 40.00
	DX2	2 Bolts and Through Bolt Mounting Hardware Available in Gray (Std.) or Black - Specify Finish	\$ 77.00
	DX3	3 Bolts and Through Bolt Mounting Hardware Available in Gray (Std.) or Black - Specify Finish	\$112.00

EXIT ALARMS

EAX®-500 Series - Surface Mount Only

	MODEL NO.	DESCRIPTION	SUGGESTED LIST PRICE
Mortise Cylinder Not Included	EAX-500	Surface Mount Battery Alarm (Sensor Kit & EA-561 Warning Sign Included) Gray Finish - standard	\$212.00
  Mortise Cylinder Not Included	EAX-500W	Weatherized Surface Mount Battery Alarm (Sensor Kit & EA-561 Warning Sign Included) Gray Finish - standard	\$318.00
EAX-500 Series is UL Classified Miscellaneous Fire Door Accessories			

CONFIGURABLE OPTIONS - EAX®-500

	DESCRIPTION	SUGGESTED LIST PRICE
BK	Suffix for black finish	No Additional Cost
EA-561 EA-704-2 102651-1 EA-705 EA-561G 102651-3 102651-2	Self-Adhesive Door Signs English - Red (RWE) Spanish - Red (RWS) French - Green (GWF) French Canadian - Red (RWF) German - Green (RWG) Chinese - Red (RWC) English/German - Green (GWE)	No Additional Cost when ordered with EAX
MC65	Mortise Cylinder, factory installed	Add \$ 60.00
IC7	7-pin IC Cylinder Housing (Core not included), factory installed	Add \$ 60.00
KS	Key Stop, factory installed	Add \$ 5.00
L11 thru L20	Cover lock with specific key number (EAX-500 only)	No Additional Cost

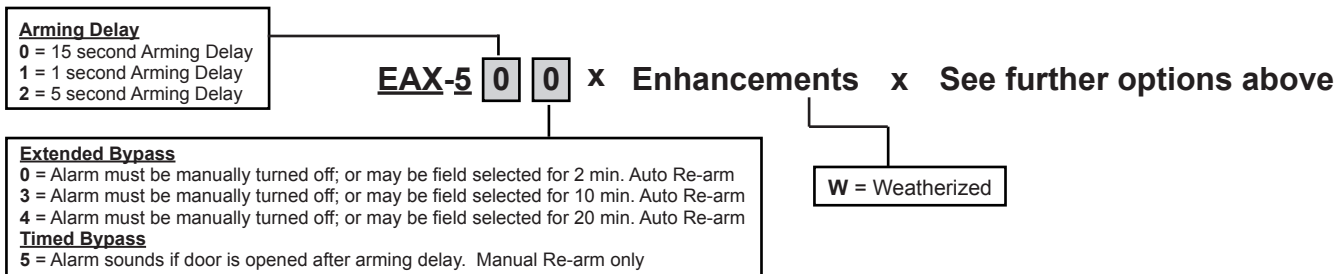

NOTE - Cylinders not included. Products on this page can be ordered with cylinders (MC65) or Interchangeable core housings (IC7) pre-installed at Detex prior to shipping (See above).

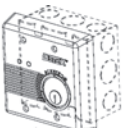
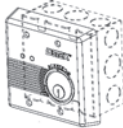
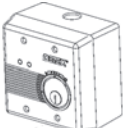
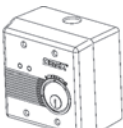

EAX®-2500 Series - Wall Mount

	MODEL NO.	DESCRIPTION	SUGGESTED LIST PRICE
 Mortise Cylinder Not Included	EAX-2500F	Flush Mount AC/DC Powered Alarm Gray Finish - Standard (EA-561 Warning Sign and Back Box Included) Does Not Include, but Requires: Magnetic Door Contacts - See Pg. 51 Transformer - See Pg. 52	\$420.00
 Mortise Cylinder Not Included	EAX-2500FK	Kit -Flush Mount AC/DC Powered Alarm Gray Finish - Standard (EA-561 Warning Sign, Back Box, flush magnetic switch contacts and 24VAC Transformer Included)	\$519.00
 Mortise Cylinder Not Included	EAX-2500S	Surface Mount AC/DC Powered Alarm Gray Finish - Standard (EA-561 Warning Sign and Back Box Included) Does Not Include, but Requires: Magnetic Door Contacts - See Pg. 51 Transformer - See Pg. 52	\$420.00
 Mortise Cylinder Not Included	EAX-2500SK	Kit - Surface Mount AC/DC Powered Alarm Gray Finish - Standard (EA-561 Warning Sign, Back Box, surface magnetic switch contacts and 24VAC Transformer Included)	\$536.00

CONFIGURABLE OPTIONS - EAX®-2500

	DESCRIPTION	SUGGESTED LIST PRICE
BK	Suffix for black finish	No Additional Cost
EA-561 EA-704-2 102651-1 EA-705 EA-561G 102651-3 102651-2	Self-Adhesive Door Signs English - Red (RWE) Spanish - Red (RWS) French - Green (GWF) French Canadian - Red (RWF) German - Green (RWG) Chinese - Red (RWC) English/German - Green (GWE)	No Additional Cost when ordered with EAX
MC65	Mortise Cylinder, factory installed	Add \$ 60.00
IC7	7-pin IC Cylinder Housing (Core not included), factory installed	Add \$ 60.00
KS	Key Stop, factory installed	Add \$ 5.00
C	Conversion kit for retrofit from EA-2500F	Add \$ 27.00

Arming Delay

0 = 15 second Arming Delay
1 = 1 second Arming Delay
2 = 5 second Arming Delay

EAX-25 0 0 x See further options above

Extended Bypass

0 = Alarm must be manually turned off; or may be field selected for 2 min. Auto Re-arm
3 = Alarm must be manually turned off; or may be field selected for 10 min. Auto Re-arm
4 = Alarm must be manually turned off; or may be field selected for 20 min. Auto Re-arm

Timed Bypass

5 = Alarm sounds if door is open after arming delay. Manual Re-arm only

MC65





IC7



NOTE - Cylinders not included. Products on this page can be ordered with cylinders (MC65) or Interchangeable core housings (IC7) pre-installed at Detex prior to shipping (See above).

EAX®-3500 Series (Surface Mount Only)

	MODEL NO.	DESCRIPTION	SUGGESTED LIST PRICE
 Mortise Cylinder Not Included	EAX-3500	24VAC/DC Hardwired Timed Bypass Exit Alarm with Rechargeable Battery (EA-561 Warning Sign Included) Does not include, but requires: Magnetic Door Contacts - See page 51 24V Transformer - See page 52	\$550.00
 Mortise Cylinder Not Included	EAX-3500FK	Kit - 24VAC/DC Hardwired Timed Bypass Flush Exit Alarm with Rechargeable Battery, Flush Door Contacts, Plug-in Transformer	\$655.00
 Mortise Cylinder Not Included	EAX-3500SK	Kit - 24VAC/DC Hardwired Timed Bypass Surface Exit Alarm with Rechargeable Battery, Surface Door Contacts, Plug-in Transformer	\$630.00

CONFIGURABLE OPTIONS - EAX®-3500

	DESCRIPTION	SUGGESTED LIST PRICE
EA-561 EA-704-2 102651-1 EA-705 EA-561G 102651-3 102651-2	Self-Adhesive Door Signs English - Red (RWE) Spanish - Red (RWS) French - Green (GWF) French Canadian - Red (RWF) German - Green (RWG) Chinese - Red (RWC) English/German - Green (GWE)	No Additional Cost when ordered with EAX
MC65	Mortise Cylinder, factory installed	Add \$ 60.00
IC7	7-pin IC Cylinder Housing (Core not included), factory installed	Add \$ 60.00

ACCESSORIES - EAX®-3500

	DESCRIPTION	SUGGESTED LIST PRICE
CL-1	Key	\$ 4.00
BR12	Rechargeable Battery 12 VDC, 3.4AH	\$ 42.00
103945	Allows EAX-3500 Surface Alarm to be recessed into hollow wall construction Kit includes: Flush Box, Instructions and Mounting Hardware	\$100.00

MC65



IC7





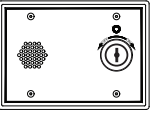

NOTE - Cylinders not included. Products on this page can be ordered with cylinders (MC65) or Interchangeable core housings (IC7) pre-installed at Detex prior to shipping (See above).







DOOR PROP ALARMS

	MODEL NO.	DESCRIPTION	SUGGESTED LIST PRICE
	EAX-411SK	Surface Mount AC/DC 85dB Door Prop Alarm Kit (Back Box, Surface Magnetic Switch Contacts and 24VAC Transformer Included)	\$350.00
	EAX-4200SK	Surface Mount AC/DC 85dB Exit Alarm/Door Prop Alarm Kit (Back Box, Surface Magnetic Switch Contacts, 24VAC Transformer, and rim cylinder Included)	\$800.00

REMOTE ALARMS CS Series

	MODEL NO.	DESCRIPTION	SUGGESTED LIST PRICE
	CS-940F CS-950F	Flush Mount 9VDC Battery Powered Remote Alarm No cylinder required Available in : Gray Black	\$159.00
	CS-940S CS-950S	Surface Mount 9VDC Battery Powered Remote Alarm No cylinder required Available in: Gray Black	\$159.00
	CS-2940F CS-2950F	Flush Mount Externally Powered Remote Alarm with 9 VDC battery backup. AC adapter included No cylinder required Available in: Gray Black	\$212.00
	CS-2940S CS-2950S	Surface Mount Externally Powered Remote Alarm with 9 VDC battery backup. AC adapter included No cylinder required Available in: Gray Black	\$212.00

DOOR SWITCHES

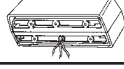

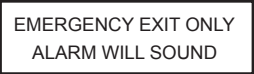

	MODEL NO.	DESCRIPTION	SUGGESTED LIST PRICE
	MS-1039F	Economical Magnetic Switch Flush Mount, White, Closed Contacts	\$ 27.00
	MS-1039S*	Economical Magnetic Switch Surface Mount, White, Closed Contacts	\$ 37.00
	MS-1059F	Economical Magnetic Switch Flush Mount, Brown, Closed Contacts	\$ 27.00
	MS-1059S*	Economical Magnetic Switch Surface Mount, Brown, Closed Contacts	\$ 37.00
	MS-2049F**	Heavy Duty Form C Magnetic Switch (Flush Mount)	\$ 64.00
	MS-2049S**	Heavy Duty Form C Magnetic Switch (Surface Mount)	\$ 81.00
	MS-2049SC**	Heavy Duty Form C Magnetic Switch (Surface/Conduit Mount)	\$135.00
	MS-2049SI	Heavy Duty Form C Magnetic Switch (Surface Inswinging Mount)	\$135.00
<p>* Meets UL 634 Level 2 High Security Sensor Standard ** UL Classified Miscellaneous Fire Door Accessories</p>			

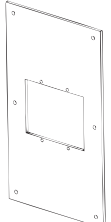
ACCESSORIES

	MODEL NO.	DESCRIPTION	SUGGESTED LIST PRICE
 <p>EMERGENCY EXIT ONLY ALARM WILL SOUND</p>		Self-Adhesive Door Signs - Pricing for additional Self-Adhesive Door Signs not ordered with EAX	
	EA-561	English - Red (RWE)	\$ 2.00
	EA-704-2	Spanish - Red (RWS)	\$ 8.00
	102651-1	French - Green (GWF)	\$ 8.00
	EA-705	French Canadian - Red (RWF)	\$ 8.00
	EA-561G	German - Green (RWG)	\$ 8.00
	102651-3	Chinese - Red (RWC)	\$ 8.00
	102651-2	English/German - Green (GWE)	\$ 8.00

	MODEL NO.	DESCRIPTION	SUGGESTED LIST PRICE
	102640	Conversion Kit for Retrofit from EA-2500F to EAX-2500F Size: 11" x 6.5" x .16" Aluminum Plate Includes: Anchors, Screws and Instructions	\$ 27.00

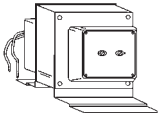
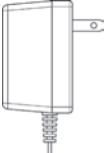
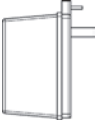
POWER SOURCES





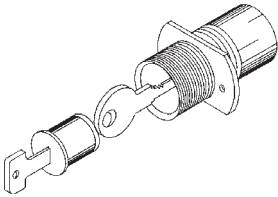

	MODEL NO.	DESCRIPTION	SUGGESTED LIST PRICE
	BE-961-1	Battery Eliminator - 120VAC to 9VDC Includes 10' Flex Conduit Powers up to 3 ECLs or 3 V40s	\$259.00
	BE-961-2	Battery Eliminator - Same as above with Supervisory Loop Power, alarm and LED (For use with ECL-230 Series only)	\$301.00
	BE-961-5	Battery Eliminator - 12VAC to 9VDC Does not include Transformer or Flex Conduit Powers up to 3 ECLs or 3 V40s	\$174.00
	BE-961-6	Battery Eliminator - 24VAC to 9VDC Does not include Transformer or Flex Conduit Powers up to 3 ECLs or 3 V40s	\$174.00
		PP-5567	9V Battery
	PP-5152-2	Transformer, 120VAC - 24VAC 40 VA-60Hz	\$ 41.00
	PP-5152-3	Transformer, 120VAC - 12VAC 25 VA-60Hz	\$ 29.00
	PP-5452-2	Transformer, 240VAC - 12VAC, 25VA-50Hz	\$ 41.00
	277	Transformer, 277VAC TO 24VAC 100VA	\$ 76.00
	TFMR9	Plug-In Transformer, with wires 120VAC - 9VDC 200mA	\$ 27.00
	TFMR12	Plug-In Transformer, with terminals 120VAC - 12VDC	\$ 42.00
	TFMR24	Plug-In Transformer, with terminals 120VAC - 24VAC 20 VA	\$ 27.00

REDI-KEY KEY VAULTS

	MODEL NO.	DESCRIPTION	SUGGESTED LIST PRICE
	FS-3000-S	Standard Unit - Stainless Steel Key Control System	\$349.00
	Unit furnished with cylinder and two (2) keys on request Call factory for availability on any special keying requirements Two levels of High Security Control available		

ACCESS CONTROLS

DTX-3000 SERIES (PC Managed)

	MODEL NO.	DESCRIPTION	SUGGESTED LIST PRICE
	DTX-3001	Complete system in a metal enclosure that includes: One processor board with two Weigand inputs and one relay output board to control a maximum of two doors. Also included is a plug in transformer. (Required with all systems)	\$1,674.00
	DTX-3002	One processor board with two Weigand inputs and one relay output board to control a maximum of two doors. (Does not include enclosure and transformer)	\$1,417.00
	DTX-3040	R10 Reader - Base Model 6100 Operates at 13.56 MHz., Weigand Output Mullion Mount proximity reader Size: 1.90" x 4.04" x .80"	\$ 220.00
	DTX-3041	RK40 Reader - Base Model 6130 Operates at 13.56 MHz., Weigand Output Reader with Keypad combination Size: 3.30" x 4.80" x .90"	\$1,015.00
	DTX-3042	R40 Reader - Base Model 6120 Operates at 13.56 MHz., Weigand Output Reader Only - Standard Mounting Size: 3.30" x 4.80" x .85"	\$ 553.00
	DTX-3043	R90 Long Range Weatherized Reader - Base Model 6150 Operates at 13.56 MHz., Weigand Output 18" read range with DTX-3020 Smart Card Size: 12" x 12" x 1.25"	\$1,392.00
	DTX-3044	MaxiProx Operates at 125 kHz., Weigand output Up to 8 feet read range with DTX-3023 Vehicle Tag Size: 12" x 12" x 1.0" Available in gray	\$1,392.00

Contact Factory for Lead Time

DTX-3000 SERIES Optional Features

OPTIONAL FEATURE	DESCRIPTION	SUGGESTED LIST PRICE
DTX-3010*	DTX® Lite Single PC Only, 4 doors maximum SOFTWARE ONLY No charge for Software if ordered with DTX®3030 Interface Module Converter	\$ 133.00
DTX-3011	DTX® EXpress Single PC Only, 30 doors maximum SOFTWARE ONLY DTX®3030 Interface Module Converter Must Be Purchased Separately	\$ 589.00
DTX-3030	Interface Module Converter - for RS-232 to RS-485 Maximum 1500 feet	\$ 615.00
DTX-3020	Model 2000 iClass Proximity Smart Card. Operates at 13.56 MHz. Must order in quantity of 100 pieces, minimum	\$ 993.00 per 100
DTX-3021	Model 2060 iClass Proximity Smart Tag. Operates at 13.56 MHz. Adhesive backing attaches to non-metallic surfaces Must order in quantity of 100 pieces, minimum	\$ 806.00 per 100
DTX-3022	Model 2051 iClass Proximity Smart Key. Operates at 13.56 MHz, for key rings. Must order in quantity of 100 pieces, minimum	\$1,832.00 per 100
DTX-3023	ProxPass Vehicle Active Tag for vehicle access control. Compatible with DTX-3044 MaxiProx reader. Must order in quantity of 10 pieces, minimum	\$ 843.00 for 10
*Note: No charge for DTX Lite Software (DTX-3010) if purchased with Interface Module (DTX-3030)		

DTX-3000 SERIES ACCESSORIES

MODEL NO.	DESCRIPTION	SUGGESTED LIST PRICE
DTX-3070	Din Rail Mount Kit - Used to mount DTX-3002, Processor and Relay boards.	\$ 71.00
DTX-3071	Lock Kit - Enclosure, includes lock and 2 keys	\$ 23.00
DTX-3060	Quad Output Module - 4 relays per module, up to 4 modules can be added to each system for a total of 16 relays. Call Detex for more information	\$ 495.00
DTX-3061	Supervised Input Module - Controls and manages 8 fully supervised and 4 unsupervised inputs for a total of 12 inputs	\$ 575.00
DTX-3031	RAMM Remote Access Control Module Maintains all configuration information locally even during extended power and communication outages. Call Detex for more information.	\$1,830.00

Contact Factory for Lead Time

ACCESS CONTROLS

DTX-1000 SERIES (Stand Alone)

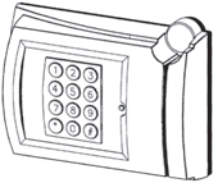
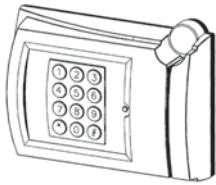
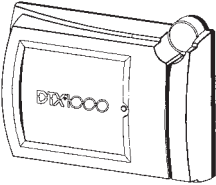
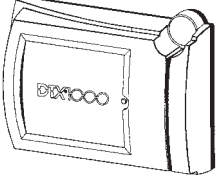
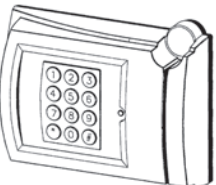
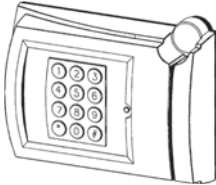
	MODEL NO.	DESCRIPTION	SUGGESTED LIST PRICE
	DTX-1100	Access Control Keypad	\$411.00
	DTX-1150	Access Control Keypad with Anti-Tamper Switch, Conformal Coated Board and Thermostatic Heater	\$470.00
	DTX-1200	Access Control Cardreader with Handheld Programmer	\$470.00
	DTX-1250	Access Control Cardreader with Anti-Tamper Switch, Conformal Coated Board, Thermostatic Heater and Handheld Programmer	\$530.00
	DTX-1300	Access Control Keypad plus Cardreader	\$587.00
	DTX-1350	Access Control Keypad plus Cardreader with Anti-Tamper Switch, Conformal Coated Board and Thermostatic Heater	\$647.00
Weatherstrip supplied standard with all units.			

DTX-1000 SERIES Optional Features

OPTIONAL FEATURE	DESCRIPTION	SUGGESTED LIST PRICE
ATS	Anti-Tamper Switch - This Form C relay output is used to signal an external alarm system when the case is pried open.	\$ 8.00
CCB	Conformal Coated Board - Used in wet-weather conditions. The coating will prevent chemical residue buildup from affecting the board.	\$22.00
HTR	Thermostatic Heater - For use in colder climates to keep the electronic circuitry operating properly.	\$53.00
OHP	Omit Handheld Programmer from DTX1200 or DTX1250.	< -\$20.00 >
120	120V/12V Transformer (PP-5152-3) to be packaged in carton.	\$29.00
240	240V/12V Transformer (PP-5452-2) to be packaged in carton.	\$41.00
101121-3	Standard Detex cards. 1-99	\$ 4.00
	100-499	\$ 4.00
	500-999	\$ 4.00
	1000 & Up	\$ 3.50
DS-1697	25 foot Printer Interface Cable	\$28.00
	50 foot Printer Interface Cable	\$56.00
	75 foot Printer Interface Cable	\$84.00
101178-75	PC Interface Package - Software & 75 foot Cable	\$85.00
DS-1625	Card Clip	\$ 2.00

ANTI-TAILGATE

	MODEL NO.	DESCRIPTION	SUGGESTED LIST PRICE
	ES5200-RO	Anti-Tailgate without remote alarm	\$4,275.00
ES5200-R1	Anti-Tailgate with remote alarm	\$4,460.00	

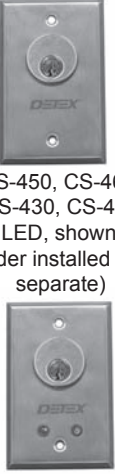

KEY SWITCHES

 <p>CS-450, CS-460, CS-430, CS-440 (No LED, shown with cylinder installed - sold separate)</p> <p>CS-452, CS-462, CS-432, CS-442 (2 LEDs - red & green, shown with cylinder installed - sold separate)</p>	MODEL NO.	DESCRIPTION	SUGGESTED LIST PRICE
	CS-450	Key switch, single, momentary, no LED	\$150.00
	CS-452	Key switch, single, momentary, 2 LED's (green - red)	\$150.00
	CS-460	Key switch, single, maintained, no LED	\$150.00
	CS-462	Key switch, single, maintained, 2 LED's (green - red)	\$150.00
	CS-430	Key switch, 2 switches, momentary, no LED	\$150.00
	CS-432	Key switch, 2 switches, momentary, 2 LED's (green - red)	\$150.00
	CS-440	Key switch, 2 switches, maintained, no LED	\$150.00
	CS-442	Key switch, 2 switches, maintained, 2 LED's (green - red)	\$150.00
<p>Note: Single switch back box not included; requires mortise cylinder</p>			

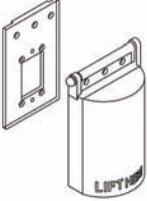

KEY SWITCH COVERS

	MODEL NO.	DESCRIPTION	SUGGESTED LIST PRICE
	PC1	Key Switch Cover & Adapter Plate	\$ 75.00



MOTION SENSORS

	MODEL NO.	DESCRIPTION	SUGGESTED LIST PRICE
	MN01	Motion Detector, 12/24VDC, form C relay	\$203.00
	MN02	Motion Detector, 9-16VDC, form A relay (N.O.)	\$ 53.00





PUSH BUTTONS

	MODEL NO.	DESCRIPTION	SUGGESTED LIST PRICE
	PB-2138-3	Shroud, beige, terminals, form C, single gang	\$285.00
	PB-2158-3	Shroud, aluminum, terminals, form C, mullion mount	\$235.00
	PB-2048-3	Mushroom, aluminum, terminals, form C, single gang	\$200.00
Note: Single switch back box not included			



ELECTRIC STRIKES

	MODEL NO.	DESCRIPTION	SUGGESTED LIST PRICE
	DS-1481-630	12/24 VDC, Rim	\$675.00
	DS-1581-LBM	12/24 VDC, Rim, LBM	\$810.00

ELECTROMAGNETIC LOCKS

	MODEL NO.	DESCRIPTION	SUGGESTED LIST PRICE
	ML-1548	1600 lbs., 12/24 VDC, Surface	\$495.00
	ML-1548RT	1600 lbs., 12/24 VDC, Timer (0-30 seconds)	\$575.00
	ML-1549W	Weatherized	\$475.00
	ML-1549WF	Weatherized, Face Mount	\$517.00

WEATHERIZED HORN/STROBE

	MODEL NO.	DESCRIPTION	SUGGESTED LIST PRICE
	HR2	Horn, Red, no lettering, backbox, 2 wire, 12/24 VDC	\$125.00
	SR2	Strobe, red, black lettering, backbox, 2 wire, 12/24 VDC	\$197.00
	HSR2	Horn/Strobe, red, black lettering, backbox, 2 wire, 12/24 VDC	\$244.00
	HSR4	Horn/Strobe, red, black lettering backbox, 4 wire, 12/24 VDC	\$265.00

POWER TRANSFERS / ELECTRIC HINGE

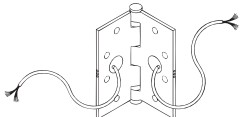
	MODEL NO.	DESCRIPTION	SUGGESTED LIST PRICE
	PT-5	Power Transfer - 628 Finish	\$117.00
	EWH8-626	4.5" x 4.5" x 8 wire Standard Weight Electric Hinge	\$265.00



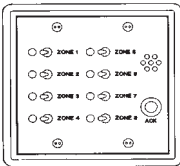
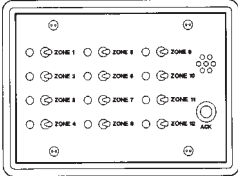



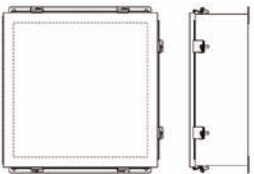

REMOTE INDICATING PANELS

	MODEL NO.	DESCRIPTION	SUGGESTED LIST PRICE
	ES-621 *	2 Gang Switch Box Wall Mount 8-ZONE ANNUNCIATOR W/SHUNT 12V DC	\$ 608.00
	ES-631 *	3 Gang Switch Box Wall Mount 12-ZONE ANNUNCIATOR W/SHUNT 12V DC	\$ 848.00
* Units do not come with Back Box supplied. Fits standard 2 or 3 gang electrical box.			

NEMA ENCLOSURE

	MODEL NO.	DESCRIPTION	SUGGESTED LIST PRICE
	104500	16" x 14" x 6" NEMA 4X Enclosure (sealed enclosure)	\$1,200.00



CONTROLLER AND POWER SUPPLY PRODUCTS

	MODEL NO.	DESCRIPTION	SUGGESTED LIST PRICE
	10-800 *	Series 800 Controller -Stand-Alone 120VAC/24VDC System contains back box, transformer and Series 800 electronics.	\$ 978.00
	11-800 *	Series 800 Controller - Stand-Alone 120VAC/24VDC System contains back box, insert, 24 point terminal strip, transformer and Series 800 electronics.	\$ 998.00
	30-800 *	Series 800 Controller - 120VAC/24VDC Surface Box - Zinc Plated System contains back box w/ metal stand-off, lid and Series 800 electronics. Requires low voltage remote source of power	\$ 775.00
	31-800	Series 800 Controller - 120VAC/24VDC Flat Mount Plate Requires low voltage remote source of power	\$ 750.00
	40-800*	Series 800 Controller - 120VAC/24VDC Surface Box - Black System contains back box, upper back pan and flip-up insert with Series 800 electronics. Requires low voltage remote source of power	\$ 893.00
	41-800 * **	Series 800 Controller - 120VAC/24VDC Surface Box- Black Without Flip-up insert unit Requires low voltage remote source of power	\$ 809.00
	50-800	Circuit Board - 24VAC/24VDC Comes with 5 stand-off, requires non-conductive support studs for proper installation	\$ 715.00
	80-800 *	12 or 24VDC Power Supply - 1.0A continuous Can be used with ED, EE, EM products	\$ 318.00
	81-800 *	Controller and Power Supply - 1 Amp continuous Powers and controls ER device for 1 door with signal output for 1 operator	\$ 650.00
	82-800 *	Controller and Power Supply - 2 Amp continuous Powers and controls ER device for 1 pair of doors with signal output for 1 operator	\$ 695.00
	83-800 *	Controller and Power Supply - 2 Amp continuous Powers and controls ER device for 2 independent doors with signal output for 2 operators	\$1,051.00
	84-800 *	Controller and Power Supply - 1 Amp continuous Powers and controls EExER device for 1 door with signal output for 1 operator	\$1,325.00
	85-800 *	Controller and Power Supply - 2 Amp continuous Powers and controls EExER device for 2 independent doors with signal output for 2 operators NOTE: Battery Charging Circuit included on all 80-800 through 85-800 (Battery sold separately)	\$1,725.00
	90-800 *	120 VAC/24VDC Power Supply - 1.0A continuous Can be used with ED, EE, EM products	\$ 318.00

*Cover lock and keys not included - See Controller Accessories (Page 63) to order lock

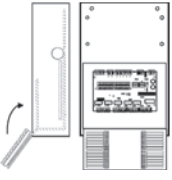
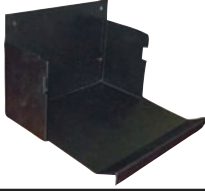

** This application is generally used for integrated applications that require additional splice chamber room or for the pass through of cable, wire or circuit boards associated to low voltage systems. Preparation of upper back pan and flip-up portion of insert to suit other manufacturers components is available. For custom application, please call for quotation.

CONTROLLER ACCESSORIES



	MODEL NO.	DESCRIPTION	SUGGESTED LIST PRICE
	60-06	Folding Insert Tray Add this to 10-800 Controller to provide space for digital timer or door call module	\$148.00
	70-2B	Battery Box Extension Black (Battery not included)	\$ 65.00
	70-12B	Battery 12VDC 4AH	\$ 46.00
	70-24B	Battery 24VDC 4AH - 2 batteries provided Includes linking cable (Battery Box not Included)	\$ 90.00
	L	Cover Lock and 2 keys	ADD \$ 8.00
	M12	12 Volt Module	ADD \$127.00
Signage - ECL-395 (see page 36) and EA-561 (see page 51) sold separately			

One Part Number = One Easy Solution
 Easy to Specify, Easy To Order, Easy to Price, Easy to Sell, Easy to Install
 Best in class products, kitted together for custom solutions to common applications.









Below are several pre-configured EasyKits, however, Detex can create a more custom EasyKit for a specific application. Just contact your local sales representative or email your request to marketing@detex.com. For more information, visit our website at www.detex.com and click on Integrated Door Security Systems.

MODEL NO.	DESCRIPTION	SUGGESTED LIST PRICE
ACDx10xS5000x1S-1	<p align="center">Advantex Rim Exit Device with Kaba S5000 Exit Trim for Single Door</p> <p>Kit Includes: (1) Detex 10 Series rim device with hex dogging, brushed stainless finish, for 36" door, surface strike (1) Kaba 5010XSWL62641 S5000 Simplex push button, exit device lever trim, with single common pin user, Schlage C key override, Winston Lever, Satin Chrome</p> <hr/>  <p>The diagram shows two components: on the left, a 'Simplex Exit Trim' labeled 'S5000' which is a push button with a lever; on the right, a 'Rim Exit Device' which is a long cylindrical metal rod with a handle on one end.</p>	\$1,425.00
ACDx10xS5000x1S-2	<p align="center">Advantex Rim Exit Device with Kaba S5000 Exit Trim for Single Door</p> <p>Kit Includes: (1) Detex 10 Series rim device with hex dogging, brushed stainless finish, for 36" door, surface strike (1) Kaba 5010BWL62641 S5000 Simplex push button, exit device lever trim, with single common pin user, BEST interchangeable core key override, Winston Lever, Satin Chrome</p> <hr/>  <p>The diagram shows two components: on the left, a 'Simplex Exit Trim' labeled 'S5000' which is a push button with a lever; on the right, a 'Rim Exit Device' which is a long cylindrical metal rod with a handle on one end.</p>	\$1,450.00



ACCESS CONTROL DOOR KITS CONT'D ON PAGE 65

MODEL NO.	DESCRIPTION	SUGGESTED LIST PRICE
ACDx10xE5000x1S-1	<p align="center">Advantex Rim Exit Device with Kaba E5000 Exit Trim for Single Door</p> <p>Kit Includes: (1) Detex 10 Series rim device with hex dogging, brushed stainless finish, for 36" door, surface strike (1) Kaba E5010XSWL62641 E5000 E-plex push button, exit device lever trim, with 100 pin users, Schlage C key override, Winston Lever, Satin Chrome</p> <hr/>  <p>The diagram shows two components: on the left, the 'E-Plex Exit Trim' (labeled E5000) which is a rectangular push button with a lever; on the right, the 'Rim Exit Device' which is a long, cylindrical metal handle with a mounting bracket.</p>	<p align="center">\$1,610.00</p>
ACDx10xE5000x1S-2	<p align="center">Advantex Rim Exit Device with Kaba E5000 Exit Trim for Single Door</p> <p>Kit Includes: (1) Detex 10 Series rim device with hex dogging, brushed stainless finish, for 36" door, surface strike (1) Kaba E5010BWL62641 E5000 E-plex push button, exit device lever trim, with 100 pin users, BEST interchangeable core key override, Winston Lever, Satin Chrome</p> <hr/>  <p>The diagram shows two components: on the left, the 'E-Plex Exit Trim' (labeled E5000) which is a rectangular push button with a lever; on the right, the 'Rim Exit Device' which is a long, cylindrical metal handle with a mounting bracket.</p>	<p align="center">\$1,635.00</p>



ACCESS CONTROL DOOR KITS CONT'D ON PAGE 66

MODEL NO.	DESCRIPTION	SUGGESTED LIST PRICE
ACDxML1548RTx1S-1	<p align="center">Electromagnetic Lock with Motion Detector & Push Buttons for Single Door</p> <p>Kit Includes: (1) Detex ML-1548xRT magnetic lock, brushed aluminum finish, with relay timer (1) Detex 80-800 24V DC Power Supply with Battery charging circuit (batteries sold separate), (2) Detex wall mount palm/mushroom push buttons (1) Detex MN01 Motion Detector, (1) Set of install & wiring instructions</p> <hr/> <div style="display: flex; justify-content: space-around; align-items: center;"> <div style="text-align: center;">  Motion Detector </div> <div style="text-align: center;">  Push Button </div> <div style="text-align: center;">  Power Supply </div> </div> <div style="text-align: center; margin-top: 10px;">  Electromagnetic Lock </div>	\$1,488.00
ACDxML1548RTx1S-2	<p align="center">Electromagnetic Lock with Motion Detector & Push Buttons for Single Door</p> <p>Kit Includes: (1) Detex ML-1548xRT magnetic lock, brushed aluminum finish, with relay timer (1) Detex 90-800 24V DC Power Supply, (2) Detex wall mount palm/mushroom push buttons (1) Detex MN01 Motion Detector, (1) Set of install & wiring instructions</p> <hr/> <div style="display: flex; justify-content: space-around; align-items: center;"> <div style="text-align: center;">  Motion Detector </div> <div style="text-align: center;">  Push Button </div> <div style="text-align: center;">  Power Supply </div> </div> <div style="text-align: center; margin-top: 10px;">  Electromagnetic Lock </div>	\$1,456.00

ACCESS CONTROL DOOR KITS CONT'D ON PAGE 67



MODEL NO.	DESCRIPTION	SUGGESTED LIST PRICE
ACDx10xERx1S-1	<p align="center">Advantex Latch Retraction Rim Exit Device with Detex Access Control System for Single Door</p> <p>Kit Includes:</p> <ul style="list-style-type: none"> (1) Detex 1003CxER, Rim exit latch retraction device with night latch cylinder pull trim with cylinder, brushed stainless finish for a 36" door, and surface strike (1) Detex 81-800 Power Supply for single door (1) Detex M12 12 Volt Module (1) DTX-3002 Access Control Processor (not shown) (2) DTX-3040 Proximity Readers (1) DTX-3030 Interface Module Converter (not shown) (1) DTX-3010 DTX Lite AC Software Package (1) DTX-3020 Package of 100 AC Proximity Smart Cards (1) Set of Install and wiring instructions <hr/> 	\$6,027.00
ACDx21xERx1P-1	<p align="center">Advantex Latch Retraction Rim Exit Device with Detex Access Control System for Pair of Doors without a Mullion</p> <p>Kit Includes:</p> <ul style="list-style-type: none"> (2) Detex 2103CxER, Rim exit latch retraction devices with night latch cylinder pull trim with cylinder, brushed stainless finish for a 36" door, and surface strike (1) Detex 82-800 Power Supply for pair of door (1) Detex M12 12 Volt Module (1) DTX-3002 Access Control Processor (not shown) (2) DTX-3040 Proximity Readers (1) DTX-3030 Interface Module Converter (not shown) (1) DTX-3010 DTX Lite AC Software Package (1) DTX-3020 Package of 100 AC Proximity Smart Cards (1) Set of Install and wiring instructions <hr/> 	\$8,857.00

ACCESS CONTROL DOOR KITS CONT'D ON PAGE 68



MODEL NO.	DESCRIPTION	SUGGESTED LIST PRICE
ACDx10xERxATx1S-1	<p>Advantex Latch Retraction Rim Exit Device, Detex Access Control System with Anti-Tailgate Detection System for a Single Door</p> <p>Kit Includes:</p> <ul style="list-style-type: none"> (1) Detex 1003CxER, Rim exit latch retraction device with night latch cylinder pull trim with cylinder, brushed stainless finish for a 36" door, and surface strike (1) Detex 81-800 Power Supply for single door (1) Detex M12 12 Volt Module (1) DTX-3002 Access Control Processor (not shown) (1) ES-5200-R1 Anti-Tailgate System with remote alarm - allows only one entry per valid access control entry (2) DTX-3040 Proximity Readers (1) DTX-3030 Interface Module Converter (not shown) (1) DTX-3010 DTX Lite AC Software Package (1) DTX-3020 Package of 100 AC Proximity Smart Cards (1) Set of Install and wiring instructions <hr/> 	\$10,487.00
ACDx10xERxATx1P-1	<p>Advantex Latch Retraction Rim Exit Device, Detex Access Control System with Anti-Tailgate Detection System for a Pair of Doors</p> <p>Kit Includes:</p> <ul style="list-style-type: none"> (2) Detex 1003CxER, Rim exit latch retraction devices with night latch cylinder pull trim with cylinder, brushed stainless finish for a 36" door, and surface strike (1) Detex 82-800 Power Supply for a pair of doors (1) Detex M12 12 Volt Module (1) DTX-3002 Access Control Processor (not shown) (1) ES-5200-R1 Anti-Tailgate System with remote alarm - allows only one entry per valid access control entry (2) DTX-3040 Proximity Readers (1) DTX-3030 Interface Module Converter (not shown) (1) DTX-3010 DTX Lite AC Software Package (1) DTX-3020 Package of 100 AC Proximity Smart Cards (1) Set of Install and wiring instructions <hr/> 	\$12,437.00

One Part Number = One Easy Solution
 Easy to Specify, Easy To Order, Easy to Price, Easy to Sell, Easy to Install
 Best in class products, kitted together for custom solutions to common applications.

Below are several pre-configured EasyKits, however, Detex can create a more custom EasyKit for a specific application. Just contact your local sales representative or email your request to marketing@detex.com. For more information, visit our website at www.detex.com and click on Integrated Door Security Systems.

MODEL NO.	DESCRIPTION	SUGGESTED LIST PRICE
DEx01EXx1S-1	<p>Advantex Request to Exit Signal Device with Controller and components for Single Door</p> <p>Kit Includes:</p> <ul style="list-style-type: none"> (1) Detex 01 Series device with hex dogging, brushed stainless finish, for 36" door, active pushpad activates signal switch - no latch or strike, includes end cap with flexible conduit loop & fittings (1) 11-800 Controller / Power Supply with wiring diagram (1) ML-1548 Electromagnetic Lock (1) HR2 - Horn with adjustable tone settings (1) Key switch with momentary switching (Mortise cylinder included) (1) ECL-395 Delayed Egress, Code Compliant Peel & Stick Door Sign 	\$2,805.00
DEx10EXx1S-1	<p>Advantex Request to Exit Signal Rim Exit Device with Controller and components for Single Door</p> <p>Kit Includes:</p> <ul style="list-style-type: none"> (1) Detex 10 Series device with hex dogging, brushed stainless finish, for 36" door, pushpad activates signal switch - surface strike (#99), includes end cap with flexible conduit loop & fittings (1) 11-800 Controller / Power Supply with wiring diagram (1) ML-1548 Electromagnetic Lock (1) HR2 - Horn with adjustable tone settings (1) Key switch with momentary switching (Mortise cylinder included) (1) ECL-395 Delayed Egress, Code Compliant Peel & Stick Door Sign 	\$2,980.00



DELAYED EGRESS DOOR KITS CONT'D ON PAGE 70

MODEL NO.	DESCRIPTION	SUGGESTED LIST PRICE
DEx01EXx1P-1	<p align="center">Advantex Request to Exit Signal Device with Controller and components for a Pair of Doors</p> <p>Kit Includes: (2) Detex 01 Series device with hex dogging, brushed stainless finish, for 36" door, active pushpad activates signal switch - no latch or strike, includes end cap with flexible conduit loop & fittings (1) 11-800 Controller / Power Supply with wiring diagram (2) ML-1548 Electromagnetic Lock (1) HR2 - Horn with adjustable tone settings (1) Key switch with momentary switching (Mortise cylinder included) (2) ECL-395 Delayed Egress, Code Compliant Peel & Stick Door Sign</p> <hr/> 	\$3,715.00
DEx10EXx1P-1	<p align="center">Advantex Request to Exit Signal Rim Exit Device with Controller and components for a Pair of Doors</p> <p>Kit Includes: (2) Detex 10 Series device with hex dogging, brushed stainless finish, for 36" door, pushpad activates signal switch - surface strike (#99), includes end cap with flexible conduit loop & fittings (1) 11-800 Controller / Power Supply with wiring diagram (2) ML-1548 Electromagnetic Lock (1) HR2 - Horn with adjustable tone settings (1) Key switch with momentary switching (Mortise cylinder included) (2) ECL-395 Delayed Egress, Code Compliant Peel & Stick Door Sign</p> <hr/> 	\$4,533.00

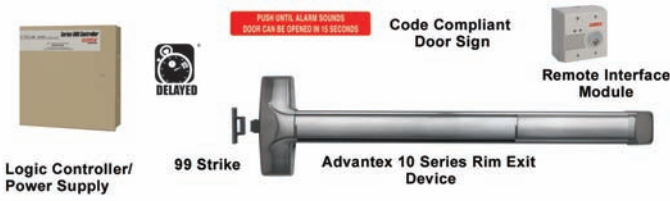
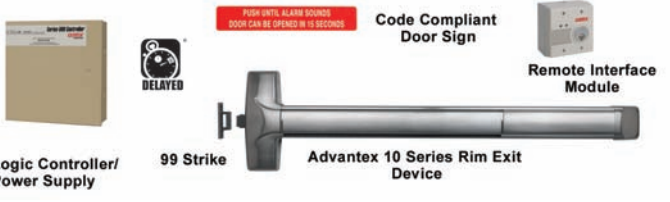
DELAYED EGRESS DOOR KITS CONT'D ON PAGE 71



MODEL NO.	DESCRIPTION	SUGGESTED LIST PRICE
DEx10EEExERx1S-1	<p align="center">Advantex Delayed Egress & Latch Retraction Rim Exit Device for Single Door</p> <p>Kit Includes:</p> <p>(1) Detex 10 Series Delayed Egress & Latch Retract rim exit device, brushed stainless finish, for 36" door, Surface strike (#99), wall mount remote interface module which includes key switch, LED's and horn includes end cap with flexible conduit loop & fittings</p> <p>(1) 84-800 Controller / Power Supply with wiring diagram</p> <p>(1) ECL-395 Delayed Egress, Code Compliant Peel & Stick Door Sign</p> <hr/>  <p>Logic Controller/ Power Supply 99 Strike Advantex 10 Series Rim Exit Device Code Compliant Door Sign Remote Interface Module</p>	\$4,125.00
DEx10EEExERx1S-2	<p align="center">Advantex Delayed Egress & Latch Retraction Rim Exit Device for a 48" Door</p> <p>Kit Includes:</p> <p>(1) Detex 10 Series Delayed Egress & Latch Retract rim exit device, brushed stainless finish, for 48" door, Surface strike (#99), wall mount remote interface module which includes key switch, LED's and horn includes end cap with flexible conduit loop & fittings</p> <p>(1) 84-800 Controller / Power Supply with wiring diagram</p> <p>(1) ECL-395 Delayed Egress, Code Compliant Peel & Stick Door Sign</p> <hr/>  <p>Logic Controller/ Power Supply 99 Strike Advantex 10 Series Rim Exit Device Code Compliant Door Sign Remote Interface Module</p>	\$4,145.00

DELAYED EGRESS DOOR KITS CONT'D ON PAGE 72



MODEL NO.	DESCRIPTION	SUGGESTED LIST PRICE
DEx10EEExERx1P-1	<p align="center">Advantex Delayed Egress & Latch Retraction Rim Exit Device for a Pair of Doors</p> <p>Kit Includes: (2) Detex 10 Series Delayed Egress & Latch Retract rim exit device, brushed stainless finish, for 36" door, Surface strike (#99), wall mount remote interface module which includes key switch, LED's and horn includes end cap with flexible conduit loop & fittings (1) 85-800 Controller / Power Supply with wiring diagram (2) ECL-395 Delayed Egress, Code Compliant Peel & Stick Door Sign</p> <hr/>  <p>Logic Controller/Power Supply 99 Strike Advantex 10 Series Rim Exit Device Code Compliant Door Sign Remote Interface Module</p>	\$7,325.00
DEx10EEExERx1P-2	<p align="center">Advantex Delayed Egress & Latch Retraction Rim Exit Device for a Pair of 48" Doors</p> <p>Kit Includes: (2) Detex 10 Series Delayed Egress & Latch Retract rim exit device, brushed stainless finish, for 48" door, Surface strike (#99), wall mount remote interface module which includes key switch, LED's and horn includes end cap with flexible conduit loop & fittings (1) 85-800 Controller / Power Supply with wiring diagram (2) ECL-395 Delayed Egress, Code Compliant Peel & Stick Door Sign</p> <hr/>  <p>Logic Controller/Power Supply 99 Strike Advantex 10 Series Rim Exit Device Code Compliant Door Sign Remote Interface Module</p>	\$7,365.00

One Part Number = One Easy Solution
 Easy to Specify, Easy To Order, Easy to Price, Easy to Sell, Easy to Install
 Best in class products, kitted together for custom solutions to common applications.

Below are several pre-configured EasyKits, however, Detex can create a more custom EasyKit for a specific application. Just contact your local sales representative or email your request to marketing@detex.com. For more information, visit our website at www.detex.com and click on Integrated Door Security Systems.

MODEL NO.	DESCRIPTION	SUGGESTED LIST PRICE
WDEx01EXx1S-1	<p>Advantex Weatherized Request to Exit Signal Device with Controller and components for Single Door</p> <p>Kit Includes:</p> <ul style="list-style-type: none"> (1) Detex 01 Series Weatherized device, brushed stainless finish, for 36" door, active pushpad activates signal switch - no latch or strike, includes end cap with flexible conduit loop & fittings (1) 11-800 Controller / Power Supply with wiring diagram and NEMA 4X enclosure (1) ML-1549W Outdoor Electromagnetic Lock (1) HRK - Outdoor Horn with adjustable tone settings (1) Key switch with momentary switching (Mortise cylinder included) (1) Protective Clear Plastic Cover for Key switch (not shown) (1) Outdoor Delayed Egress, Code Compliant Door Sign (not shown) <hr/> 	\$4,236.00
WDEx10EXx1S-1	<p>Advantex Weatherized Request to Exit Signal Rim Exit Device with Controller and components for Single Door</p> <p>Kit Includes:</p> <ul style="list-style-type: none"> (1) Detex 10 Series Weatherized device, brushed stainless finish, for 36" door, pushpad activates signal switch - surface strike (#99), includes end cap with flexible conduit loop & fittings (1) 11-800 Controller / Power Supply with wiring diagram and NEMA 4X enclosure (1) ML-1549W Outdoor Electromagnetic Lock (1) HRK - Outdoor Horn with adjustable tone settings (1) Key switch with momentary switching (Mortise cylinder included) (1) Protective Clear Plastic Cover for Key switch (not shown) (1) Outdoor Delayed Egress, Code Compliant Door Sign (not shown) <hr/> 	\$4,411.00

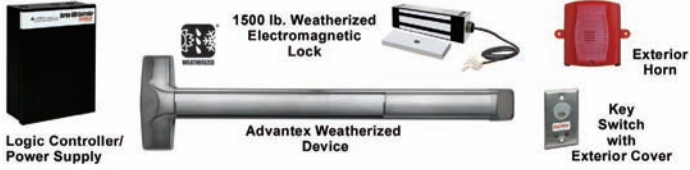
WEATHERIZED DELAYED EGRESS DOOR KITS CONT'D ON PAGE 74

MODEL NO.	DESCRIPTION	SUGGESTED LIST PRICE
<p>WDEx01EXx1P-1</p>	<p>Advantex Weatherized Request to Exit Signal Device with Controller and components for a Pair of Doors</p> <p>Kit Includes:</p> <p>(2) Detex 01 Series Weatherized device, brushed stainless finish, for 36" door, active pushpad activates signal switch - no latch or strike, includes end cap with flexible conduit loop & fittings</p> <p>(1) 11-800 Controller / Power Supply with wiring diagram and NEMA 4X enclosure</p> <p>(2) ML-1549W Outdoor Electromagnetic Lock</p> <p>(1) HRK - Outdoor Horn with adjustable tone settings</p> <p>(1) Key switch with momentary switching (Mortise cylinder included)</p> <p>(1) Protective Clear Plastic Cover for Key switch (not shown)</p> <p>(2) Outdoor Delayed Egress, Code Compliant Door Sign (not shown)</p> <hr/> 	<p>\$5,747.00</p>
<p>WDEx10EXx1P-1</p>	<p>Advantex Weatherized Request to Exit Signal Rim Exit Device with Controller and components for a Pair of Doors</p> <p>Kit Includes:</p> <p>(2) Detex 10 Series Weatherized device, brushed stainless finish, for 36" door, pushpad activates signal switch - surface strike (#99), includes end cap with flexible conduit loop & fittings</p> <p>(1) 11-800 Controller / Power Supply with wiring diagram and NEMA 4X enclosure</p> <p>(2) ML-1549W Outdoor Electromagnetic Lock</p> <p>(1) HRK - Outdoor Horn with adjustable tone settings</p> <p>(1) Key switch with momentary switching (Mortise cylinder included)</p> <p>(1) Protective Clear Plastic Cover for Key switch (not shown)</p> <p>(2) Outdoor Delayed Egress, Code Compliant Door Sign (not shown)</p> <hr/> 	<p>\$6,097.00</p>

One Part Number = One Easy Solution
 Easy to Specify, Easy To Order, Easy to Price, Easy to Sell, Easy to Install
 Best in class products, kitted together for custom solutions to common applications.

Below are several pre-configured EasyKits, however, Detex can create a more custom EasyKit for a specific application. Just contact your local sales representative or email your request to marketing@detex.com. For more information, visit our website at www.detex.com and click on Integrated Door Security Systems.

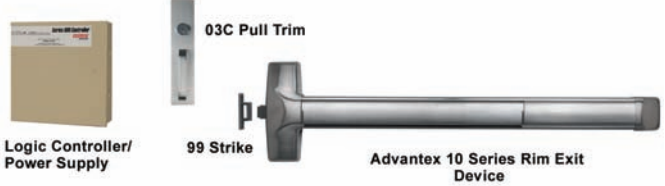
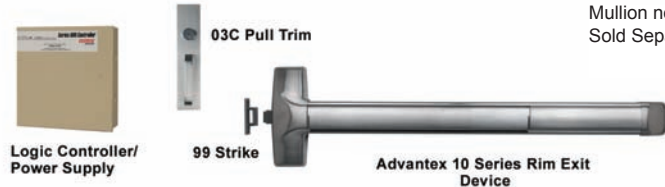
MODEL NO.	DESCRIPTION	SUGGESTED LIST PRICE
EDx10EDx1S-1	<p>Advantex Electrified Dogging Device with Power Supply and components for a Single Door</p> <p>Kit Includes: (1) Detex 10 Series Rim Exit Device with Electrified Dogging, brushed stainless steel finish, flex conduit loop, end cap and fittings, night latch pull trim (cylinder included) for 36" door height (1) 90-800 Power Supply</p> <hr/>  <p>Logic Controller/ Power Supply 03C Pull Trim 99 Strike Advantex 10 Series Rim Exit Device</p>	\$1,768.00
EDx10EDx1P-1	<p>Advantex Electrified Dogging Device with Power Supply and components for a Pair of Doors with a mullion</p> <p>Kit Includes: (2) Detex 10 Series Rim Exit Device with Electrified Dogging, brushed stainless steel finish, flex conduit loop, end cap and fittings, night latch pull trim (cylinder included) for 36" door height (1) 90-800 Power Supply</p> <hr/>  <p>Logic Controller/ Power Supply 03C Pull Trim 99 Strike Advantex 10 Series Rim Exit Device</p> <p>Mullion not shown Sold Separate</p>	\$3,240.00

ELECTRIFIED DOGGING DOOR KITS CONT'D ON PAGE 76

MODEL NO.	DESCRIPTION	SUGGESTED LIST PRICE
EDx21EDx1P-1	<p>Advantex Electrified Dogging Device with Power Supply and components for a Pair of Doors without a mullion</p> <p>Kit Includes: (2) Detex 21 Series Surface Vertical Top Rod Exit Devices with Electrified Dogging, brushed stainless steel finish, flex conduit loop, end cap and fittings, night latch pull trim (cylinder included) for 36" x 84" door (1) 90-800 Power Supply</p>	\$4,240.00
		

CAMPUS LOCKDOWN EASYKIT

MODEL NO.	DESCRIPTION	SUGGESTED LIST PRICE
EDx10EDKx1S-1	<p>Advantex Electrified Dogging Device with Key Control for Campus Lockdown</p> <p>Kit Includes: (1) Detex 10 Series Rim Exit Devices with Electrified Dogging, brushed stainless steel finish, flex conduit loop, end cap and fittings, night latch pull trim (cylinder included) for 36" x 84" door (1) Detex PP-5152-2 Transformer (1) Detex PB-2048-3 Central Control Switch</p>	\$1,693.00
		

One Part Number = One Easy Solution
 Easy to Specify, Easy To Order, Easy to Price, Easy to Sell, Easy to Install
 Best in class products, kitted together for custom solutions to common applications.

Below are several pre-configured EasyKits, however, Detex can create a more custom EasyKit for a specific application. Just contact your local sales representative or email your request to marketing@detex.com. For more information, visit our website at www.detex.com and click on Integrated Door Security Systems.

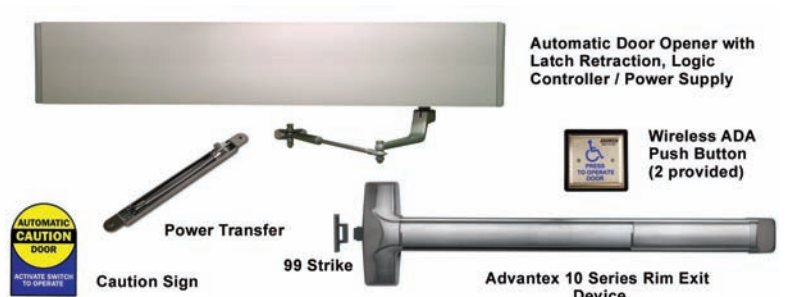
MODEL NO.	DESCRIPTION	SUGGESTED LIST PRICE
AODx10ERx1S-1	<p>Low Energy Automatic Door, Latch Retraction Exit Device with Power Supply for RHR/LH/AL Push, Single Door</p> <p>Kit Includes:</p> <ul style="list-style-type: none"> (1) AO19-1 Low Energy Automatic Door Operator (1) Detex 10 Series device with Electric Latch Retraction, brushed stainless finish, for 36" door, when energized both push pad and latch is retracted, Surface strike (#99), 03C, night latch function pull trim with rim cylinder (1) 81-800 Controller / Power Supply with wiring diagram (1) Power Transfer - call ahead for template for door/frame prep (1) Wireless ADA, Knowing Act push buttons (kit includes 2 buttons) <hr/> 	\$7,825.00

AUTOMATICALLY OPERATED DOOR KITS - LOW ENERGY APPLICATION CONT'D ON PAGE 78

MODEL NO.	DESCRIPTION	SUGGESTED LIST PRICE
AODx21ERx1P-1	<p>Low Energy Automatic Door, Latch Retraction Exit Device with Power Supply for a pair of Push, AL Doors</p> <p>Kit Includes:</p> <ul style="list-style-type: none"> (1) AO19-2 x CL x 75.5 Low Energy Automatic Door Operator (2) Detex 21 Series devices with Electric Latch Retraction, brushed stainless finish, for a pair of 36"x84" doors, when energized both push pad and latch is retracted, Surface strike (#99), 03C, night latch function pull trim with rim cylinder (1) 82-800 Controller / Power Supply with wiring diagram (1) Power Transfer - call ahead for template for door/frame prep (1) Wireless ADA, Knowing Act push buttons (kit includes 2 buttons) <hr/> 	\$14,952.00

Where Trust is Built™

DETEX®

Life Safety and Security Door Hardware

Detex Corporation

302 Detex Drive

New Braunfels, Texas 78130-3045 USA

PH: (830) 629-2900

(800) 729-3839

FAX: (830) 620-6711

(800) 653-3839

<http://www.detex.com>

USA Sales:

marketing@detex.com

International Sales:

export@detex.com