



**KABA®**

# E-PLEX® 5x70 Series Stand-Alone Access Controller

Installation Instructions

# Table of Contents

STEP .....	PAGE
Tools Required .....	2
A-1 Wall Installation .....	4
A-2 Gang Box Installation .....	5
B-1 System Components .....	6
C-1 Component Wiring Connections .....	6
D-1 Tamper and Security Features .....	16
E-1 Software Setting .....	18
F-1 Hard Rest Procedure .....	18
Warranty Card .....	7
Template .....	10-11

**WARNING:** The Master Code of this unit has been factory preset: 1, 2, 3, 4, 5, 6, 7, 8. To activate lock functions, the master combination must be changed at time of installation.

## Warning and Cautions

IMPORTANT: Carefully inspect windows, doorframes, door, lights, etc. to ensure that the recommended procedures will not cause any damage. Kaba Access Control's warranty does not cover damages caused by installation.

**CAUTION:** Wear safety glasses during installation.

### TOOLS REQUIRED

- Electric Drill/Screwdriver with Variable Speed and Torque
- Various Flat and Phillips Bits for Power Driver
- Wire Cutter/Stripper
- Small Straight (Flat Head) Manual Screwdriver
- Wall Anchors with #10 and or #6 Flat Head Screws or Masonry Screws
- Masonry or Wood Drill Bits for Various Surfaces



For technical assistance please call  
1.800.849.TECH (8324) or 336.725.1331

# ACU

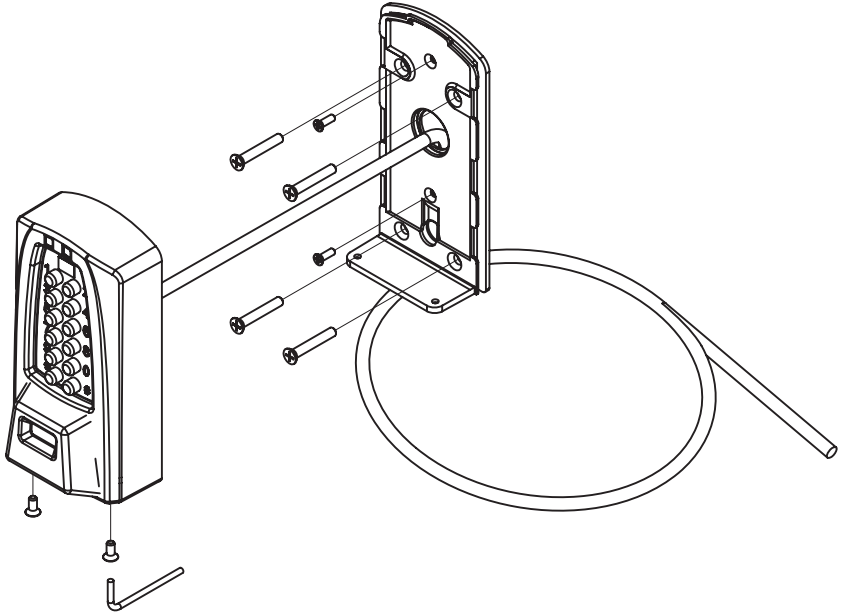

# PIU

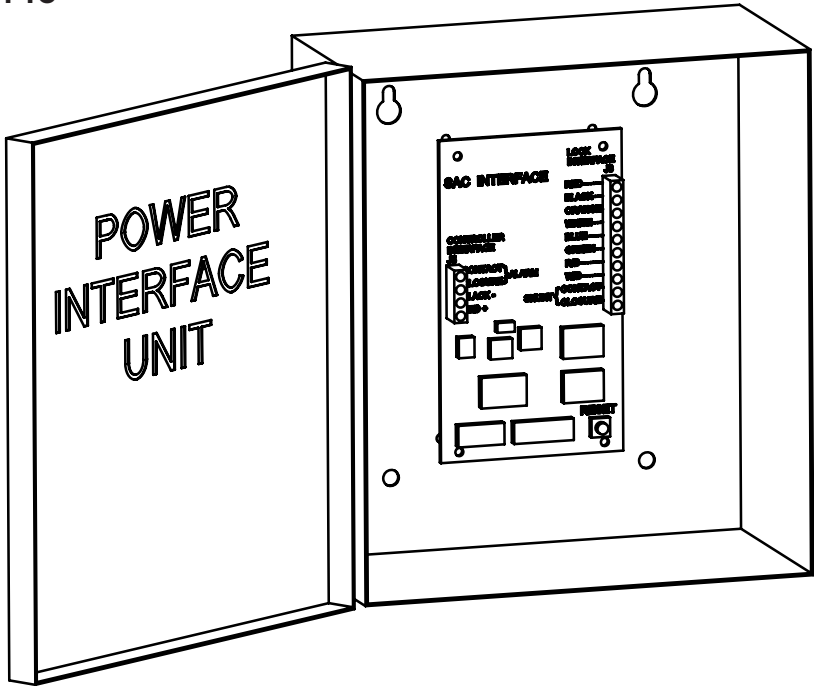

## A-1 WALL INSTALLATION

- A-1.1** Please place the template (located in the middle of this manual) on mounting surface to ensure that there are no obstructions; this allows the keypad housing to be moved up, then in and down onto the base plate. Mark and drill four holes for wood screws, wall anchors, or masonry screws and a 1/2" diameter cable hole. Remove the template.
- A-1.2** Thread the cable from the back of the Outside Housing, through the large hole in the Shim and into the hole in the wall. Remove the two security screws from the bottom of the Backplate & Gasket using the small wrench provided in the bag. Slide the back down about one inch while pulling it away from the housing.
- A-1.3** Position Shim, Gasket & Backplate and fasten with #10 Flat Head screws in the four large holes or with two #6 Flat Head screws in the two smaller holes or any combination of each. A minimum of two #6 screws is recommended.
- A-1.4** Push all excess cable into the wall. Hold the top of the Outside Housing about one inch above the top of the Baseplate that is now screwed to the wall and push until the Gasket is flush with the back edges of the Outside Housing. Now push in and down until the bottom of the Baseplate and the bottom of the Outside Housing are flush. Use the wrench provided to replace the security screws.

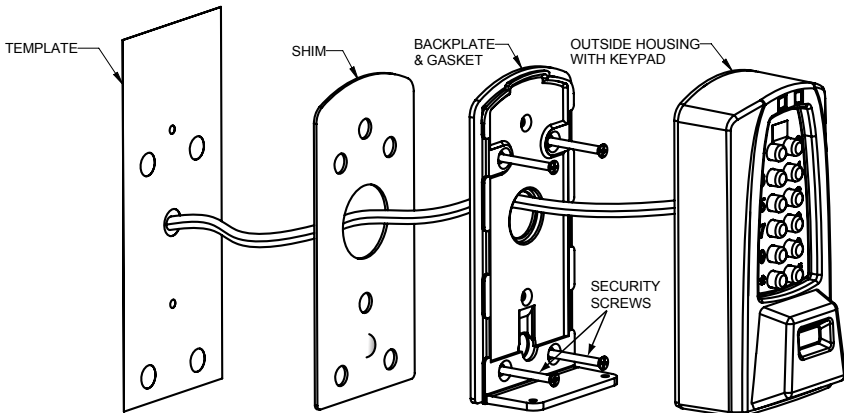

## A-2 GANG BOX INSTALLATION

- A-2.1** Mount Gang Box on the wall referring to the Template to insure clearance above the box. This allows the Keypad Housing to be moved up, then in and down onto the Baseplate. Mark and drill holes for wood screws, wall anchors, or masonry screws and a  $\frac{1}{2}$ " diameter cable hole.
- A-2.2** Thread the cable from the back of the Outside Housing through the large hole in the Shim, into the hole in the Gang Box and into the wall. Remove the two security screws from the bottom of the Backplate & Gasket using the small wrench provided in the bag. Slide the back down about one inch while pushing it away from the housing.
- A-2.3** Position the Backplate & Gasket, sandwiching the Shim against the Gang Box and fasten the Backplate & Gasket with #6 Flat Head screws into the two smaller holes that line up with the holes in the Gang Box.
- A-2.4** Push all excess cable into the wall conduit. Hold the top of the Outside Housing about one inch above the top of the Baseplate that is now screwed to the Gang Box and push until the Gasket is flush with the back edges of the Outside Housing. Now push in and down until the bottom of the Baseplate and the bottom of the Outside Housing are flush. Use the wrench provided to replace the security screws.

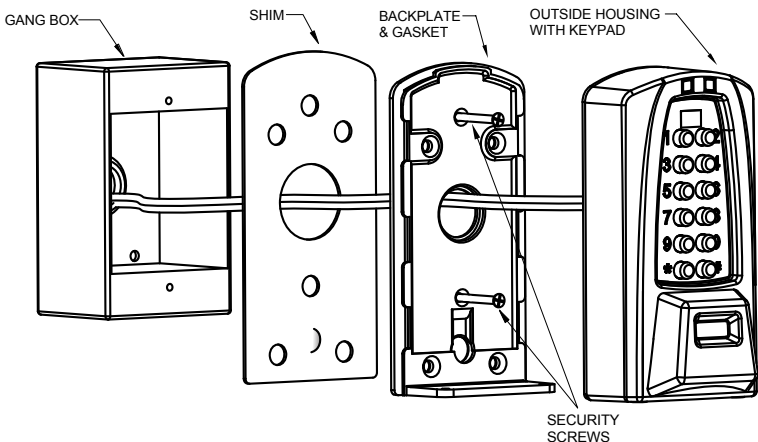

## B SYSTEM COMPONENTS

**B-1** Kaba's E-Plex Stand-Alone Access Controller consists of the Access Control Unit (ACU) and the Power Interface Unit (PIU). It is typically used in conjunction with an off-the shelf door controller or power extender (not included) connected to either a magnetic lock or electric strike for securing doors or a parking gate for access control of parking areas. The door controller which must have battery back-up (manufactured by Securitron, Altronix, and others) is typically mounted on the inside wall next to the door or up in a drop ceiling for control of the door through interface with the magnetic lock or electric strike.

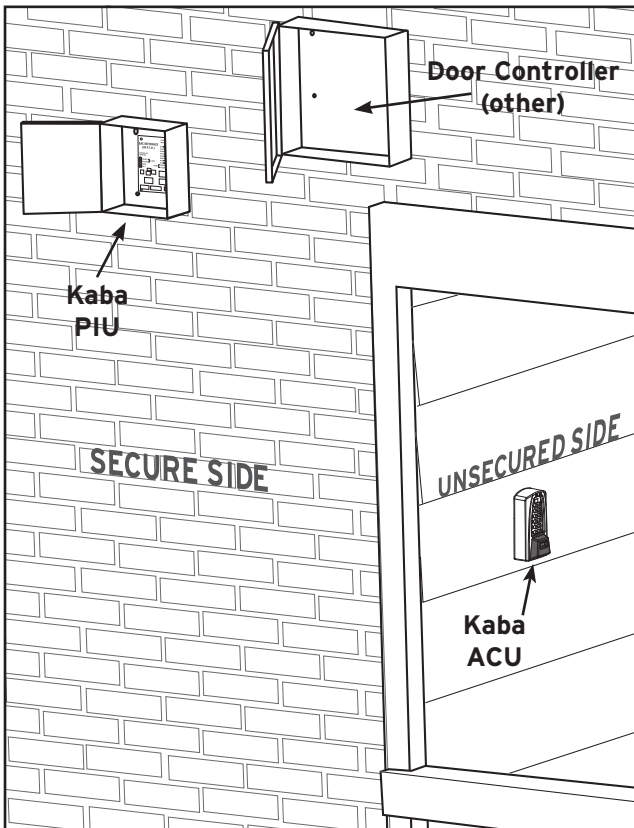

## C COMPONENT WIRING CONNECTIONS

**C-1** Installation of this system is really quite simple. The door controller is interfaced to the device that permits access to the door which typically provides support for either a magnetic lock or electric strike, along with inputs for remote exit (RE) and Fire alarm access.

## **KABA E-PLEX® LIMITED WARRANTY**

Kaba Access Control warrants this product to be free from defects in material and workmanship under normal use and service for a period of three (3) years. Kaba Access Control will repair or replace, at our discretion, locks found by Kaba Access Control analysis to be defective during this period. Our only liability, whether in tort or in contract, under this warranty is to repair or replace products that are returned to Kaba Access Control within the three (3) year warranty period.

This warranty is in lieu of and not in addition to any other warranty or condition, express or implied, including without limitation merchantability, fitness for purpose or absence of latent defects.

**ATTENTION:** This warranty does not cover problems arising out of improper installation, neglect or misuse. All warranties implied or written will be null and void if the lock is not installed properly and/or if any supplied component part is substituted with a foreign part. If the lock is used with a wall bumper, the warranty is null and void. If a doorstop is required, we recommend the use of a floor secured stop.

The environment and conditions of use determine the life of finishes on Kaba Access Control products. Finishes on Kaba Access Control products are subject to change due to wear and environmental corrosion. Kaba Access Control cannot be held responsible for the deterioration of finishes.

### **Authorization to Return Goods**

Returned merchandise will not be accepted without prior approval. Approvals and Returned Goods Authorization Numbers (RGA Numbers) are available through our Customer Service department in Winston-Salem, NC (800) 849.8324. **The serial number of a lock is required to obtain this RGA Number.** The issuance of an RGA does not imply that a credit or replacement will be issued.

The RGA number must be included on the address label when material is returned to the factory. All component parts including latches and strikes (even if not inoperative) must be included in the package with return. All merchandise must be returned prepaid and properly packaged to the address indicated.

## For your records

Model No.: \_\_\_\_\_

Date Purchased: \_\_\_\_\_

Dealer: \_\_\_\_\_

Name: \_\_\_\_\_

Telephone: \_\_\_\_\_

### Notes

---

---

---

---

---

---

---

---

---

---



For technical assistance please call  
1.800.849.TECH (8324) or 336.725.1331





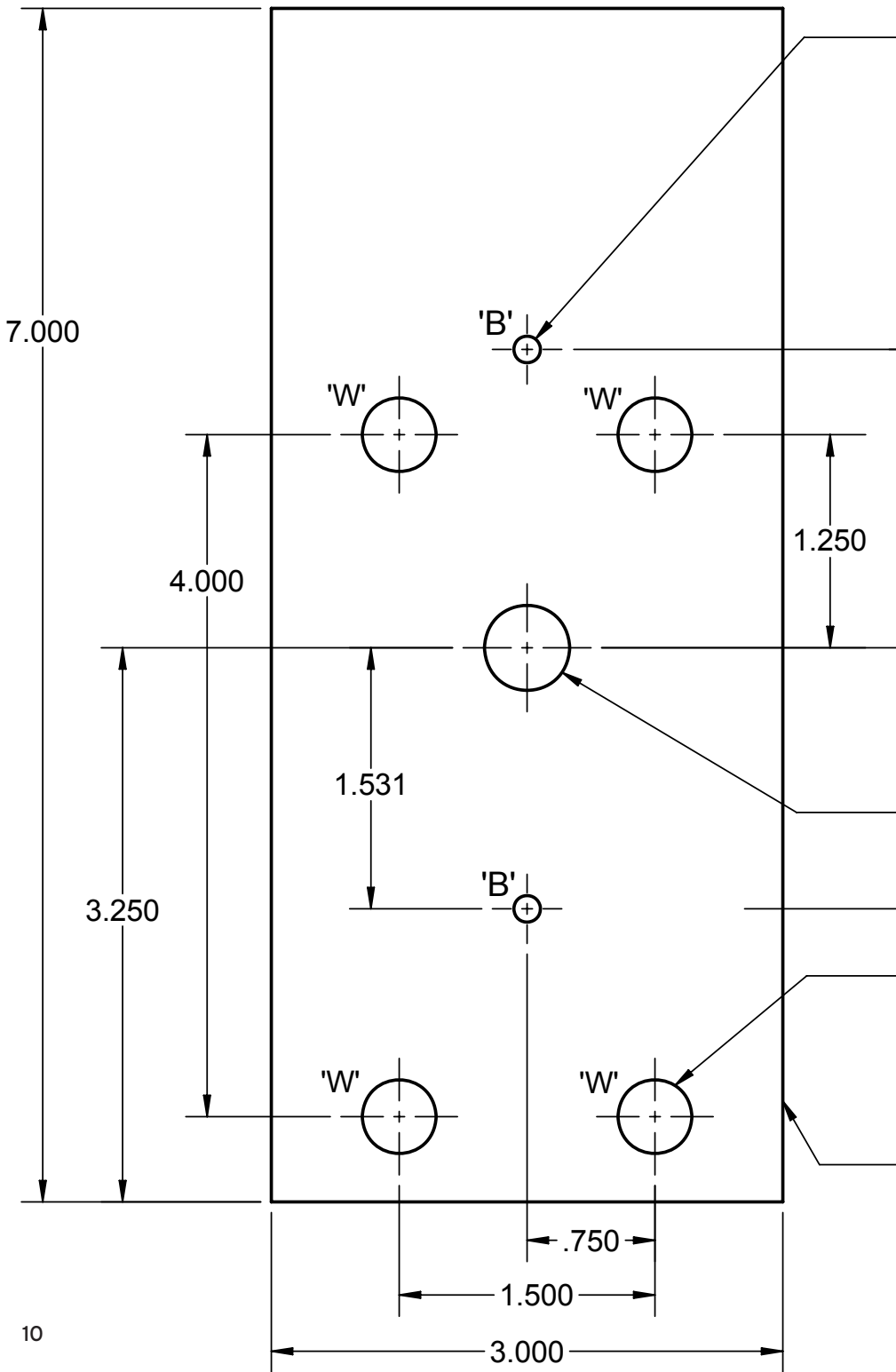

2 HOLES 'B', ARE SPACED FOR DUPLEX OUTLETS, WHEN MOUNTING TO A SINGLE GANG OUTLET BOX. ALIGN THE HOLE IN THE BACK OF THE BOX TO THE HOLE IN THE WALL MADE FOR THE CABLE, SCREW THE BACK OF THE BOX TO THE WALL, DRILL A 3/8" HOLE INTO A BLANK OUTLET COVER THEN THREAD THE CABLE THROUGH THE SUPPLIED SHIM PLATE, AND ON THROUGH THE BACK OF THE BOX INTO THE WALL HOLE, USE 2 #6 FLAT HEAD SCREWS TO GO THROUGH THE ACU'S BASE HOLES THEN THROUGH THE BLANK COVER INTO THE SINGLE GANG BOX HOLES. (SCREWS NOT PROVIDED)

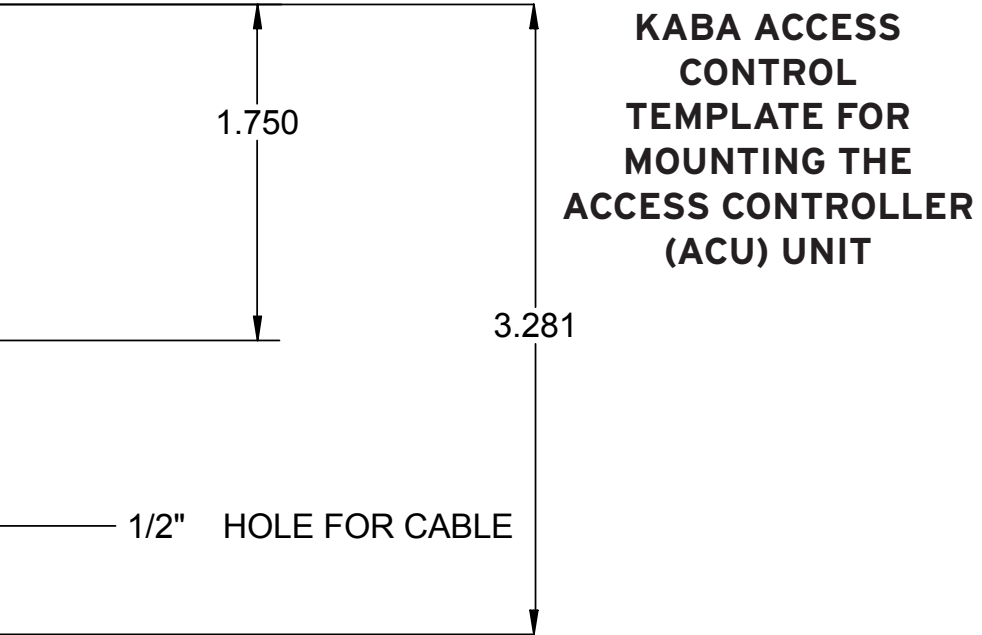

WHEN NOT MOUNTING TO AN OUTLET BOX, USE THESE 4 HOLE POSITIONS, 'W', TO LOCATE DRILL POINTS FOR WALL ANCHORS THAT USE #10 FLAT HEAD SCREWS. FOR MASONRY, 2 DIAGONAL HOLES MAY BE SUFFICIENT. (DO NOT OVERTIGHTEN AND WARP BASE) (WALL ANCHORS ARE NOT PROVIDED.) ALTERNATIVELY, 4 PILOT HOLES FOR #10 WOOD SCREW FOR CLAPBOARD CONSTRUCTION MAY BE POSITIONED AT THESE LOCATIONS.

THIS RECTANGULAR OUTLINE IS THE APPROXIMATE AREA THAT MUST BE CLEARED AROUND THE ACU.

**NOT TO SCALE**



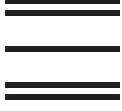

NO POSTAGE  
NECESSARY  
IF MAILED  
IN THE  
UNITED STATES

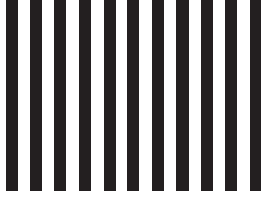

**BUSINESS REPLY MAIL**

FIRST-CLASS MAIL PERMIT NO. 1563 WINSTON-SALEM, NC

POSTAGE WILL BE PAID BY ADDRESSEE

KABA ACCESS CONTROL  
2941 INDIANA AVENUE  
WINSTON-SALEM, NC 27199-3770



## REGISTRATION CARD

Thank you for purchasing our product. In order to protect your investment and to enable us to better serve you in the future, please fill out this registration card and return it to Kaba Access Control, or register online at [www.kababaccess.com](http://www.kababaccess.com).

Name \_\_\_\_\_

Position \_\_\_\_\_

Company \_\_\_\_\_

Address \_\_\_\_\_

City \_\_\_\_\_

State \_\_\_\_\_ ZIP (Postal Code) \_\_\_\_\_ Country \_\_\_\_\_

Phone \_\_\_\_\_

Email \_\_\_\_\_

Name of Dealer Purchased From \_\_\_\_\_

Date of Purchase \_\_\_\_\_

Lock Model Number \_\_\_\_\_

### This lock will be used in what type of facility?

- Commercial Building  Industrial / Manufacturing  
 Airport  
 College / University  Government / Military  
 School / Educational  Hospital / Healthcare  
 Other (please specify) \_\_\_\_\_

### What area is being secured with this lock? (e.g. Front Door,

Common Door, Exercise Room) \_\_\_\_\_

### This lock is:

- New Installation  
 Replacing a conventional keyed lock  
 Replacing a Kaba Mechanical Pushbutton Lock  
 Replacing a Kaba Electronic Access Control  
 Replacing a Keyless Lock other than Kaba

### How did you learn about Kaba Access Control Pushbutton Locks?

- Advertisement  Previous Use  Internet / Web  
 Another Use  Locksmith  Maintenance  
 Training Class  Other (please specify) \_\_\_\_\_

What was your reason for buying this lock? \_\_\_\_\_

### Who installed your lock?

- Locksmith  Maintenance  Other

Check here if you would like more information on Kaba Access Control locks.

- C-2** The PIU requires a four (4) wire interface from the door controller. Two wires provide +12 or +24 VDC to the power interface unit and two wires support normally open (N.O.) switch closure from the power interface unit.

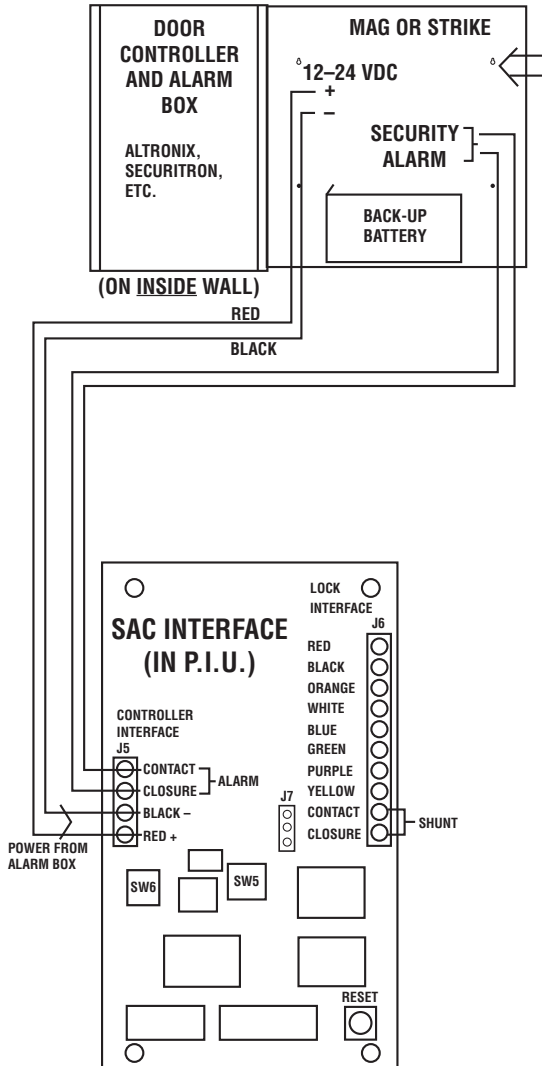

- C-3** The interface between the PIU and the ACU requires an eight wire connection using the screw terminals on the interface board assembly inside the PIU enclosure. On the opposite end, the eight wires are expanded inside the ACU which also includes 10 feet of cable for ease of installation in most door installations.

- C-4** Each of the wire colors is plainly labeled on the PIU's interface board assembly next to the connector J6. (See **Figure 1**) The standard cable length is 10 feet. Typical installation will have Kaba's ACU mounted on the unsecured side of the wall next to the door controlled. The door controller and Kaba's PIU are mounted on the secure side of the door. The ACU is designed to be mounted directly onto different types of wall surfaces or on a single gang electrical box.

## **D TAMPER AND SECURITY FEATURES**

- D-1** Kaba's Stand-Alone Access Controller has features built in that can provide an extra layer of security to the installation. The Shim Plate installed between the ACU and mounting surface has a bump that extends through a hole in the Back-plate. This bump depresses a security switch in the controller to indicate that the installation is secure. If the ACU is opened, vandalized, or removed from the surface it is mounted to, the switch will trigger a disarming of the lock. If tampering is detected by the ACU, the lights at the top of the unit will glow blue until the unit is reset. The ACU must be returned to the secure position and the reset button pressed on the PIU (See **Figure 1**) to restore the door access and operation. Since the reset occurs at the PIU which is on the secure side of the door, another point of access must be available. This feature may be disabled by turning the bottom switch on SW6 off. (Refer to **Figure 3 on Page 19**)
- D-2** Another feature of this lock is the SHUNT circuit. SW5 allows selection of one of four switches to control the duration of the Shunt. A SHUNT is typically used to indicate a valid access to a central alarm system. Different alarm systems require different period closures for this purpose and therefore the selections are .1, .2, .5, and 1 second duration. Only ONE switch may be selected. This SHUNT period is also part of the overall period selected for opening. If the SHUNT is one second and the period for opening is three seconds, the opening will only last 2 seconds. The door remains secure until the end of the SHUNT period. The SHUNT closure is factory set to normally open (N.O.) but may be changed by changing the jumper on J7 from 1->2 to 2->3. This will make the SHUNT normally closed (N.C.). (See **Figure 2**)



**Figure 1**

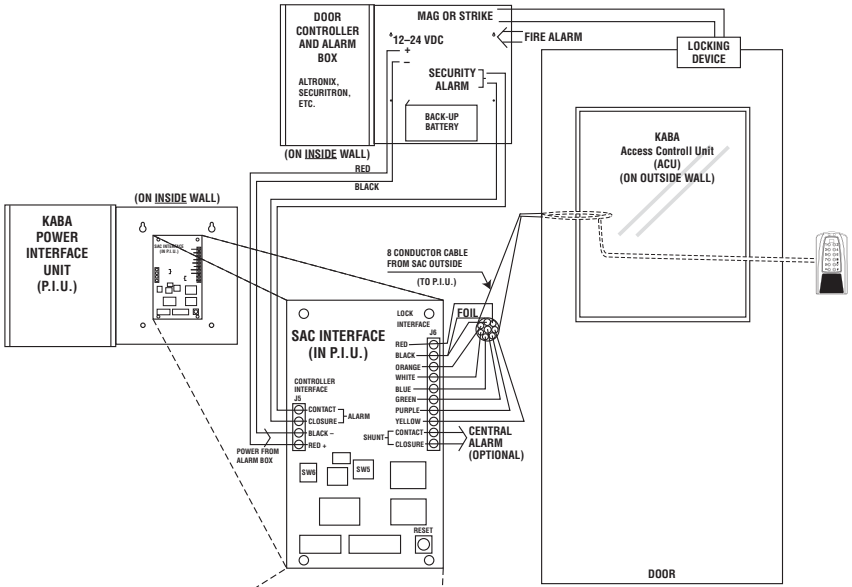

**Close-up**

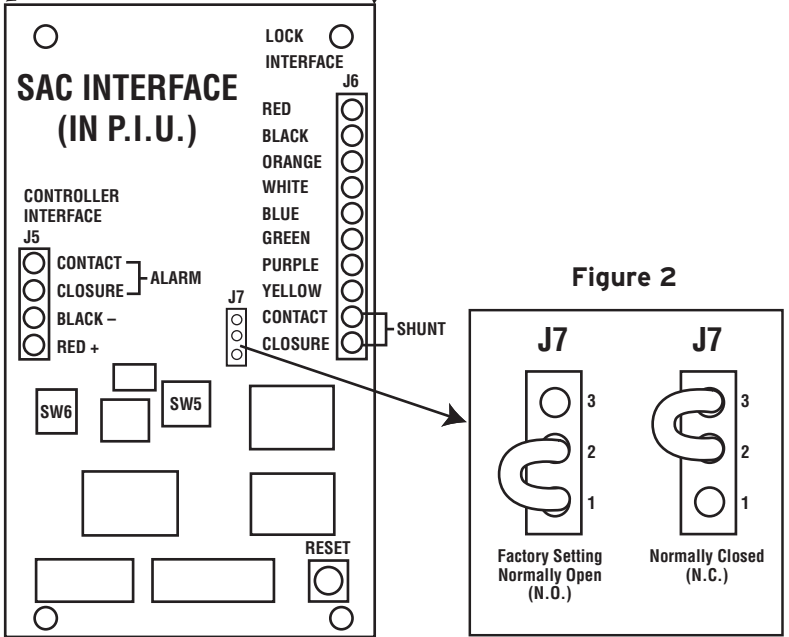

## E Software Settings for Kaba's Stand-Alone Access Controller (SAC)

- E-1 When configuring the E5070 series SAC using the optional Standard Software, choose the box that contains "Entry Lock with Passage (Cylindrical or Mortise without Deadbolt)" during lock setup.
- E-2 When configuring the E5270/5770 series SAC using the mandatory ACS Software, select the "Cylindrical or Mortise without Deadbolt" box during lock setup.

## F Hard Reset Procedure for Kaba's Stand-Alone Access Controller (SAC)

- F-1 A hard reset may be necessary if the master code for the lock is lost. **A hard reset erases all user codes including the master user and all lock parameters go back to factory default.** See the Operations Manual for information on other types of resets that can be performed at the ACU's keypad.

This procedure requires two people within hearing range of each other to verify the sequence below. One person must have access to the Lock Interface board assembly inside the **PIU** enclosure on the secure side and another person must be located at the **ACU** unit on the non-secure side of the door.

### **Steps 2, 3, and 4 below must be completed within 5 seconds**

1. Person 1: Unlock and open cover to **PIU** unit
2. Person 1: Slide the **TOP** switch of **SW6** on the **PIU's** Lock Interface board to **ON** (See Figure 3)
3. Person 2: Press the # key on the **ACU's** keypad
4. Person 1: Slide the **TOP** switch of **SW6** on the **PIU's** Lock Interface board to **OFF** and close cover on **PIU** unit
5. Person 2: Observe Green and Red LEDs flashing on **ACU**
6. Person 2: Press **1-2-3-4-5-6-7-8** on Keypad, then press #
7. The **ACU** is now in Factory Default Setup

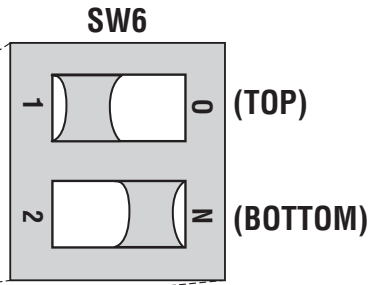
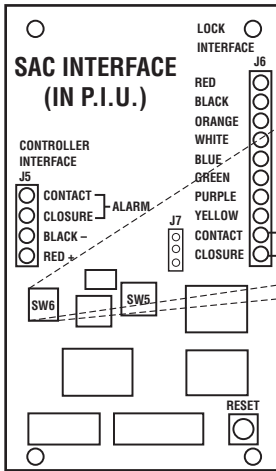

**Figure 3**

## Notes

---



---



---



---



---



---



---



---



---



---



For technical assistance please call  
1.800.849.TECH (8324) or 336.725.1331



**Kaba Access Control**  
2941 Indiana Avenue  
Winston-Salem, NC 27105 USA  
Tel: (800) 849.8324 (336) 725.1331  
Fax: (800) 346.9640 (336) 725.3269

For Technical Assistance  
Tel: 1.800.849.TECH (336) 725.1331

[www.kabaaccess.com](http://www.kabaaccess.com)

PKG3239 0808