

PEMKO Price List

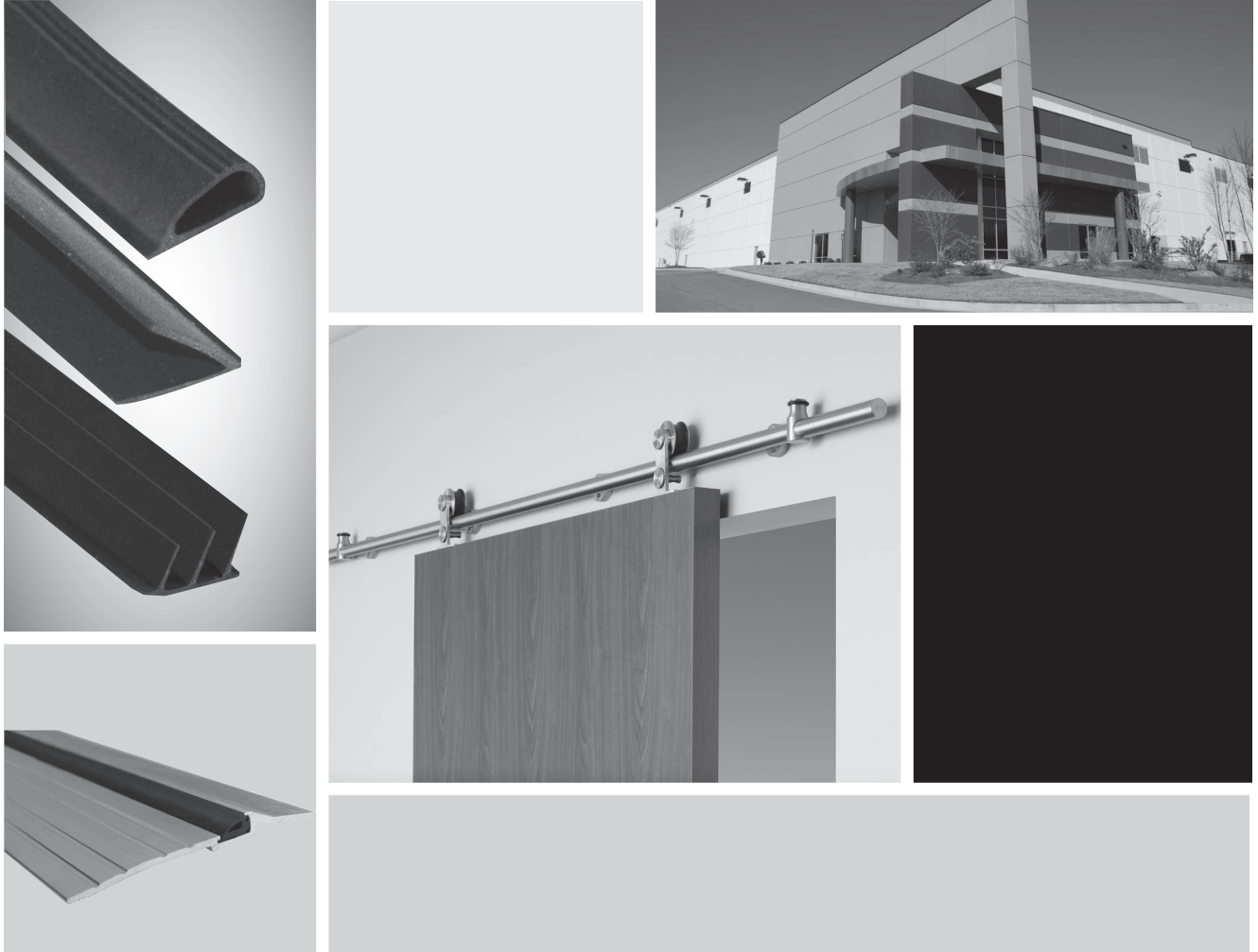

© 2011-2015 Pemko Manufacturing Co.

Prices Effective January 1, 2015



ASSA ABLOY, the global leader
in door opening solutions

General Information.....	2-3
Option Tables.....	3-4
Finishes and Inserts.....	4
Thresholds & Weatherstripping.....	5-17
Adhesive Gasketing & HSS2000 Combination Seals.....	18-22
Brush Weatherstripping.....	23
Automatic Door Bottoms.....	24
Foam Tape/Garage Weatherstrip.....	25
Tools, Replacement Seals and Fasteners.....	26-28
PemkoHinge™ – Continuous Geared Aluminum Hinges.....	29-33
Aluminum and Rubber Modular Ramp Systems.....	34-37
Threshold and Cover Plate Assemblies for Floor Closers.....	38-39
Sliding & Folding Door Hardware.....	40-48
Lite Kits.....	49-53
Grills/Vision Lites.....	54
Louvers.....	55-56
Door & Frame Accessories.....	57
Acoustic Seal Sets.....	58-59

General Information

- TERMS:** All prices are F.O.B. factory. To customers with satisfactory and/or prior approved credit and account status, terms of 2% 10th prox., NET 20th, will be allowed. Please enclose an account application prior to or with your initial order.
- CREDIT CARD CAPABILITIES:** Visa, Mastercard and American Express are accepted (only for established open accounts). Payment terms are NET.
- FREIGHT TERMS:** All orders are F.O.B. factory. For NET orders of \$1000.00 or more, freight will be prepaid in the continental U.S. for shipment the most economical way. For shipments to Hawaii on NET orders of \$1350.00 or more, freight will be prepaid the most economical way. A freight allowance of \$13/cwt will apply on shipments to Canada, Alaska, or Puerto Rico for NET orders of \$1100.00 or more. All shipments that exceed 108" in packaged length must be shipped LTL. Add 4" to the length of the product for finish package length. Minimum freight on these orders is \$130.00.
- OVERSIZED CRATING CHARGES/SPECIAL PACKAGING:** \$50.00 NET. This will be added to any order not meeting prepaid freight where the product is a) over 10 feet in length, b) welded threshold assemblies, or c) as deemed appropriate to ensure product safety while in transit.
- MINIMUM ORDER LEVEL:** A surcharge of \$8.00 NET will be added to NET orders less than \$40.00.
- RETURNS and ALLOWANCES:** No merchandise will be accepted for return or credit unless prior written approval is obtained. Returned merchandise must be of recent sale (6 months), in restockable/resalable quality, size, and condition. A minimum 25% charge plus freight charges will be made for returns. Material that is not in standard stock sizes, is made to special order, has a custom finish, or has been sold at special consideration or closeout is subject to additional charges. Foam tape is not returnable. Adhesive gasketing may only be returned within six months of the date of sale.
- CANCELLATION CHARGES:** Cancelled orders for special material, non-stock sizes, or special sizes are subject to cancellation charges, based on factory expense and material used.
- GUARANTEE:** PEMKO products are guaranteed for 5 years against defects in material or workmanship, except: 1) PemKote abrasive surface for thresholds is guaranteed for ten (10) years. 2) Polyurethane foam tapes are guaranteed for 90 days. 3) Grade 1 PemkoHinges are guaranteed for the life of the opening against defects in material or workmanship. All other grades of PemkoHinge carry a ten (10) year warranty. 4) Electrical modification performance is guaranteed for five (5) years on Heavy Duty Grade 1 (HDI) and 1100 Series hinges. Electrical modification performance is guaranteed for one (1) year on Standard Duty and Heavy Duty Grade 3 (HD3) hinges. 5) PC Henderson products are guaranteed for two (2) years against defects in material workmanship. PEMKO will not be liable for defects or damages arising from improper installation, product modification, incorrect application or storage of product. Written notice of damages must occur within the warranty period. Liability shall be limited to the replacement of product or component determined to be defective and shall not include costs arising from removal or reinstallation of product. Cost of replacement shall not exceed original purchase price. No other claims will be allowed. In no event shall liability be extended to include punitive, incidental or consequential damages arising from use of PEMKO products. This is the sole warranty given by Pemko Manufacturing Company. No other warranty implied or expressed shall be allowed.
- CLAIMS FOR SHORTAGE OR DAMAGE IN TRANSIT:** All claims must be made within ten (10) days of receipt of goods. Consignee assumes the risk of loss or damage in transit.
- MILL LENGTHS:** Most extrusions are available in mill lengths. Cut lengths over 12 feet are charged as mill lengths.
- ORDERING INFORMATION:** Please order material by product number, specifying length required per piece and the number of pieces. Most weatherstrips are stocked in standard sizes. If it is not practical to furnish the size ordered, the next larger size will be furnished and charged. Thresholds are maintained in standard sizes with 1/2" extra length on thresholds thru 47" and 1" extra length for thresholds 48" and longer to allow for fitting and field trim, unless exact net cut size is specified. Cut lengths under 24" will be charged as 24".
- NON-STOCK FINISH INFORMATION:** Some items shown in this catalog are not stocked in certain finishes (i.e. BDG, PW, and G). "Batch charges" may be required on non-stock finishes to achieve our normally fast lead times. Contact PEMKO Customer Service for a quotation and lead time.

Note: Call PEMKO for lead time & price quote on items or finishes not shown.

General Information *continued*

13. OPTION TABLES: The option tables (pages 3-4) are provided for selection of other than standard or normal finishes, components, fabrication, or fasteners. Since these are other than standard or normal, please allow an appropriate amount of extra lead time for option(s) selected.

14. CUTTING TOLERANCES:

Elastometric: -0 + 2" (50.8mm)	Net Cut: +/- 0.060, 1/16" (1.5mm)
Thresholds (up to 48"): + 1/2" (12.7mm)	Hinges: +/- 0.032, 1/32" (0.8mm)
Thresholds (48" and up): +1" (25.4mm)	Automatic Door Bottoms: +/- 0.060, 1/16" (1.5mm)

Orders are subject to acceptance by PEMKO. All prices and terms are subject to change without notice.

Option Tables

Designation/Description	List Price Add
FINISH OPTIONS	
PemKote	Threshold Price + 0.40/sq. in.
Black Anodized.....	Quote
Clear Anodized.....	Quote
Chrome Plate.....	Quote
Prime Coat.....	Quote
Pewter Finish for Aluminum.....	Threshold/WS Price + 300%
Polish/Buf Brass.....	Threshold/WS Price + 20%
Polish/Buf Aluminum.....	Threshold/WS Price + 100%
Satin Buff Brushed Brass.....	Threshold/WS Price + 20%
Oxidized & Oil Rubbed Weatherstrip: ANSI/BHMA 722.....	Weatherstrip Price + 50%
Oxidized & Oil Rubbed Weatherstrip: custom finish.....	Weatherstrip Price + 60%
Oxidized & Oil Rubbed Thresholds: ANSI/BHMA 722.....	Threshold Price + 40%
Oxidized & Oil Rubbed Thresholds: custom finish.....	Threshold Price + 60%
Oxidized & Oil Rubbed L-metal: ANSI/BHMA 722.....	Threshold Price + 80%
Oxidized & Oil Rubbed L-metal: custom finish.....	Threshold Price + 100%
Oxidized & Oil Rubbed: ANSI/BHMA 722.....	Min charge per order = 24.00 NET
Oxidized & Oil Rubbed: custom finish.....	Min charge per order = 30.00 NET
COMPONENT OPTIONS	
Aluminum Pan, 3-1/2", for Water Return Thresholds:	Threshold Price + 0.84/ft
(Standard sizes - 32", 36", 48", 72", 84" and 96"	
Brass Pan, 3-1/2", for Water Return Thresholds.....	Threshold Price + 4.20/ft
(Standard sizes - 32", 36", 48", 72", 84" and 96"	
FABRICATION OPTIONS	
Concealed Fasteners Only Available on 2009PK, 2010PK, and FG Models using "x292"	Threshold Price + 2.50/ft
(Designated by "xCF")	
Bevel	
One Edge	Threshold Price + 5.00/ft
Cut	
Thresho-Sill Nosing Flush.....	Threshold Price + 5.00/ft
Leadline	
Leadline of Astragals.....	Astragal Price + Quote
Rip	
Width.....	Threshold Price + 5.00/ft
Weld	
One Line.....	Threshold Price + 9.00/ft
Tab	
Welded Tab & Screw	Threshold Price + 21.00/ea
Support Leg	
For Elevated Plates 4" CC.....	9.00/ft
L-Notch	
Both Ends of Threshold.....	Threshold Price + 10.00/pr
U-Notch	
Both Ends of Threshold.....	Threshold Price + 20.00 pr
Drill	
Thresho-Sill (Add "H" to Prod. #).....	Threshold Price + 3.00/ea
Mill & Drill	
Thresho-Sill (Add "M" to Prod. #)	Threshold Price + 7.50/ea
Miter1-1	
Single, One End of Threshold.....	Threshold Price + 28.90/ea
Miter1-2	
Single, Both Ends of Threshold.....	Threshold Price + 57.80/pr
Miter2-1	
Double, One End of Threshold.....	Threshold Price + 57.80/ea
Miter2-2	
Double, Both Ends of Threshold.....	Threshold Price + 115.60/pr
MITERDS1-1	
Door Shoe Miter; One End of Door Shoe.....	Door Shoe Price + 10.00/ea
MITERDS1-2	
Door Shoe Miter; Both Ends of Door Shoe.....	Door Shoe Price + 19.00/pr
MITERDS1-SETUP	
Door Shoe Miter Setup Charge for ALL MITERDS.....	\$50 NET added to either MITERDS
Half Notch	
1/2", Door Shoe, Both Ends, Drip Only.....	Door Shoe Price + 2.40/pr
(Designated by "N")	
Half Notch	
1/2", Door Shoe, Both Ends, Drip Only.....	Door Shoe Price + 2.40/pr
Half Notch	
9/16", Door Shoe, Drip Only, Both Ends.....	Door Shoe Price + 2.52/pr
Half Notch	
5/8", Door Shoe, Drip Only, Both Ends.....	Door Shoe Price + 2.64/pr
Half Notch	
3/4", Door Shoe, Drip Only, Both Ends.....	Door Shoe Price + 2.76/pr
Full Notch	
1/2", Door Shoe, Both Ends.....	Door Shoe Price + 2.40/pr
Full Notch	
1/2", Door Shoe, Both Ends.....	Door Shoe Price + 2.40/pr
(Designated by "M")	
FABRICATION OPTIONS IMPORTANT NOTE:	
Complicated fabrications are quoted based on time & materials, plus 12% for Engineering.....	Quote
Note: Call PEMKO for lead time & price quote on items or finishes not shown.	

Option Tables *continued*

Designation/Description	List Price Add
FASTENER OPTIONS	
MSES10 #10 Machine Screws & Expansion Shields.....	\$0.90/ft
MSES25 1/4-20 Machine Screws & Expansion Shields.....	\$1.10/ft
MSES10SS #10 Stainless Steel Machine Screws & Expansion Shields.....	\$1.44/ft
MSES25SS 1/4-20 Stainless Steel Machine Screws & Expansion Shields.....	\$1.68/ft
MS10 #10 Machine Screws Only (No Anchors).....	\$0.28/ft
MS25 1/4-20 Machine Screws Only (No Anchors).....	\$0.42/ft
MS10SS #10 Machine Screws Only-Stainless Steel.....	\$0.84/ft
MS25SS 1/4-20 Stainless Steel Machine Screws Only.....	\$1.08/ft
ES10L #10 Lead Expansion Shields.....	\$0.60/ft
ES14L 1/4-20 Lead Expansion Shields.....	\$0.84/ft
WSLS10 #10 Wood Screws & Lead Shields.....	\$0.60/ft
WSxPLA10 #10 Wood Screws & Plastic Anchors.....	\$0.42/ft
WS10SS #10 Stainless Steel Wood Screws.....	\$0.90/ft
FHSL14 1/4x20x2 Flat Head Sleeve Anchors.....	\$2.22/ft
TKSP8 #8x3/4 Self-Drilling Screws.....	\$0.42/ft
THRU-BOLT KITS:	
SSTB-KIT 1/4-20x1-5/8" SS Thru-Bolt with 1" SS Machine Screw.....	\$10.00/ea
ZTB-KIT 1/4-20x1-5/8" Zinc Thru-Bolt with 3/4" Zinc Machine Screw.....	\$2.00/ea
Torx Screws Types & Sizes Vary.....	Quote
Tapcons See page 28 Section 28	
TST Two-Sided Tape, includes Tek Screws.....	\$1.32/ft

FASTENER OPTIONS IMPORTANT NOTE: Some thresholds require more than 1 row of fasteners across their width. Carpet thresholds which are 4" or wider (2364, 2464 and 2366) require 2 rows of fasteners. Floor plates and safety treads which are 6" or wider (such as 193) require 2 rows of fasteners. All thermal barrier thresholds (such as 253x3AFG) require 2 rows of fasteners. All other thresholds which are 8" or wider (including custom assemblies) require more than 1 row of fasteners. Special order fastener prices double, triple, quadruple, etc. depending upon the number of rows of fasteners across the width of a given threshold.

Finishes and Inserts

STANDARD FINISHES

- A** - Mill Finish Aluminum
- AK** - Mill Finish Aluminum w/PemKote
- B** - Mill Finish Extruded Bronze (Brass)
- BDC** - Bright Dip Clear Anodized Aluminum
- BDG** - Bright Dip Gold Anodized Aluminum
- C** - Clear Anodized Aluminum
- CB** - Cladded Brass
- D** - Dark Bronze Anodized Aluminum
- G** - Gold Anodized Aluminum
- K** - PemKote (on Aluminum or bronze)
- PA** - Painted Mill Finish Aluminum
- PD** - Painted Dark Bronze Aluminum
- PG** - Painted Gold Aluminum
- PW** - Painted White Aluminum
- S** - Cladded Stainless Steel
- SN** - Satin Nickel Anodized Aluminum
- SP** - Galvannealed Steel
- SS** - Stainless Steel (see individual part for finish)
- Z** - Zinc Metal

SPECIAL ORDER FINISHES

- Champagne
- Light/Medium Dark Bronze
- Painted Aluminum (any color)
- Polished Aluminum, Uncoated
- Polished Bronze, Uncoated
- Satin Brushed Aluminum, Uncoated
- Satin Brushed Bronze, Uncoated
- Oxidized and Oil Rubbed Bronze

FINISH OPTIONS

- PemKote
- Anodized (clear, light/medium dark bronze, black, champagne, gold)
- Chrome Plate
- Prime Coat
- Pewter Finish for Aluminum
- Polish/Buf Brass
- Polish/Buf Aluminum
- Satin Buff Brushed Brass
- Oxidized & Oil Rubbed L-metal (ANSI/BHMA 722)
- Oxidized & Oil Rubbed L-metal (custom finish)
- Oxidized & Oil Rubbed Thresholds (ANSI/BHMA 722)
- Oxidized & Oil Rubbed Thresholds (custom finish)
- Oxidized & Oil Rubbed Weatherstrip (ANSI/BHMA 722)
- Oxidized & Oil Rubbed Weatherstrip (custom finish)

ADHESIVE GASKETING/REPLACEMENT VINYL FINISHES

- BL** - Black
- C** - Clear
- D** - Dark Brown
- GR** - Gray
- TAN** - Tan
- W** - White

HINGE FIREPIN FINISHES

- B** - Black Oxide
- Z** - Zinc

LITES & LOUVERS FINISHES

- B** - Beige Powder Coat
- D** - Dark Bronze Duranodic Powder Coat
- G** - Gray Primer Powder Coat

INSERTS

- E** - EPDM
- M** - Magnetic
- N** - Neoprene or EPDM*
- NB** - Nylon Brush
- P** - Pile
- PK** - PemkoPrene™
- Q** - Kerf-in Foam
- R** - Sponge Neoprene or EPDM*
- S** - SiliconSeal
- SB** - Soft Brush
- T** - ThermoSeal
- TF** - Triple Foam
- V** - Eco-V™

Note: Call PEMKO for lead time & price quote on items or finishes not shown.

*Neoprenes are being phased out for the environmentally friendly EPDM

Product Number	List Price	Per Unit	Product Number	List Price	Per Unit	Product Number	List Price	Per Unit	Product Number	List Price	Per Unit
PDL10B	\$33.00	ea	P50W250	\$218.00	ea !	B70D-100	\$260.00	ea !	S105D	\$2.00	ft
PDL26	\$31.00	ea	P51B17	\$43.40	ea !	B70E-100	\$312.00	ea !	S105D100	\$160.00	ea
PDL26D/15	\$30.00	ea	PK52BL18	\$31.32	ea !	B70F-100	\$333.00	ea !	S105W	\$2.00	ft
PDL3	\$33.00	ea	PK52BL20	\$34.80	ea !	B71-96	\$148.00	ea !	S105W100	\$160.00	ea
PDL4	\$33.00	ea	PK52BL21	\$36.50	ea !	SS71-96	\$198.00	ea !	Q106BL-85	\$8.80	ea !
PDL-D1	\$6.40	ea	PK52BL25	\$43.40	ea !	B73-96	\$18.00	ea !	Q106D-36	\$3.78	ea !
PDL-D2	\$6.40	ea	PK52BL300	\$500.00	ea !	P74B17	\$62.00	ea !	Q106D-81	\$8.80	ea !
PDLBRKT	\$6.00	ea	PK52W18	\$31.40	ea !	B74-96	\$27.00	ea !	Q106D-85	\$8.80	ea !
SA1	\$42.00	ea !	PK52W20	\$34.80	ea !	SS74-96	\$58.00	ea !	Q106D-97	\$10.00	ea !
SA1D	\$50.00	ea !	PK52W21	\$36.50	ea !	B75-96	\$32.00	ea !	Q106D-121	\$12.50	ea !
B2P-96	\$74.18	ea !	PK52W25	\$43.40	ea !	EV80D36	\$15.60	ea !	Q106W-36	\$3.78	ea !
EXT2A	\$4.08	ft	PK52W300	\$500.00	ea !	EV80D42	\$18.20	ea !	Q106W-81	\$8.80	ea !
EXT2BDG	\$6.90	ft	S52BL100	\$218.00	ea !	101A	\$5.40	ft	Q106W-85	\$8.80	ea !
EXT2D	\$6.00	ft	S52W100	\$218.00	ea !	101B	\$27.60	ft	Q106W-97	\$10.00	ea !
EXT2SN	\$6.36	ft	56AV	\$3.06	ft	101BDG	\$7.86	ft	Q106W-121	\$12.50	ea !
SA2	\$42.00	ea !	56BDGV	\$4.56	ft	101D	\$6.00	ft	107A	\$5.88	ft
SA2D	\$50.00	ea !	56DV	\$4.08	ft	101G	\$7.86	ft	107D	\$7.74	ft
Z2P-96	\$31.32	ea !	56GV	\$4.50	ft	Q102BL-36	\$3.78	ea !	107G	\$8.58	ft
EXT3A	\$5.10	ft	56PWV	\$3.48	ft	Q102BL-85	\$8.80	ea !	Q107BL	\$1.20	ft
EXT3BDG	\$7.86	ft	56SNV	\$4.44	ft	Q102BL-97	\$10.00	ea !	Q107W	\$1.20	ft
EXT3D	\$7.02	ft	57AV	\$2.94	ft	Q102BL-121	\$12.50	ea !	108B	\$31.20	ft
EXT3SN	\$7.38	ft	57BDGV	\$4.32	ft	Q102D-36	\$3.78	ea !	Q108BL	\$1.20	ft
SA3	\$42.00	ea !	57DV	\$3.72	ft	Q102D-81	\$8.80	ea !	Q108W	\$1.20	ft
SA3D	\$50.00	ea !	57GV	\$4.32	ft	Q102D-85	\$8.80	ea !	S109D	\$1.75	ft
EXT3/4A	\$3.12	ft	57PWV	\$3.48	ft	Q102D-97	\$10.00	ea !	S109D100	\$144.00	ea
EXT3/4BDG	\$5.64	ft	57SNV	\$3.78	ft	Q102D-121	\$12.50	ea !	S109W	\$1.75	ft
EXT3/4D	\$5.04	ft	61B32	\$16.32	ea !	Q102D3684	\$21.38	ea !	S109W100	\$144.00	ea
EXT3/4SN	\$5.40	ft	61B36	\$18.36	ea !	Q102T-85	\$8.80	ea !	110A	\$8.58	ft
B4C-96	\$92.04	ea !	61B48	\$24.48	ea !	Q102W-36	\$3.78	ea !	110B	\$88.00	ft
B4P-96	\$92.04	ea !	61Z32	\$9.18	ea !	Q102W-81	\$8.80	ea !	110D	\$12.78	ft
SA4	\$44.00	ea !	61Z36	\$10.20	ea !	Q102W-85	\$8.80	ea !	110G	\$14.28	ft
SA4D	\$52.00	ea !	61Z48	\$13.26	ea !	Q102W-97	\$10.00	ea !	ACP112BL	\$2.20	ea
Z4C-96	\$38.22	ea !	B61-32	\$14.28	ea !	Q102W-121	\$12.50	ea !	ACP112W	\$2.20	ea
Z4P-96	\$41.22	ea !	Z61-32	\$8.82	ea !	Q102W3684	\$21.38	ea !	P112PS	\$1.40	ea
Z6C-96	\$44.04	ea !	B61-36	\$16.74	ea !	Q103BL-122	\$12.50	ea !	P112WPS	\$1.40	ea
B10-96	\$108.00	ea !	Z61-36	\$10.08	ea !	Q103BL-86	\$8.80	ea !	114A	\$12.24	ft
Z10-96	\$54.00	ea !	B61-48	\$22.32	ea !	Q103D-36	\$3.78	ea !	114B	\$120.00	ft
14/1A	\$0.85	sq/in	Z61-48	\$13.44	ea !	Q103D-81	\$8.80	ea !	114D	\$15.30	ft
18/1A	\$0.56	sq/in	66A	\$2.22	ft	Q103D-85	\$8.80	ea !	114G	\$17.04	ft
B30-96	\$35.28	ea !	66B	\$13.50	ft	Q103D-97	\$10.00	ea !	115A	\$10.92	ft
B41-96	\$53.88	ea !	66BDG	\$4.56	ft	Q103D-121	\$12.50	ea !	115D	\$14.22	ft
Z41-96	\$26.46	ea !	66D	\$4.08	ft	Q103W-36	\$3.78	ea !	115G	\$16.08	ft
B41M-96	\$53.88	ea !	66G	\$4.56	ft	Q103W-81	\$8.80	ea !	120A	\$12.90	ft
Z41M-96	\$26.46	ea !	A67	\$1.98	ft	Q103W-85	\$8.80	ea !	120B	\$122.40	ft
B43-96	\$54.00	ea !	D67	\$3.06	ft	Q103W-97	\$10.00	ea !	120D	\$19.08	ft
P50BL17	\$15.66	ea !	G67	\$3.48	ft	Q103W-121	\$12.50	ea !	120G	\$21.36	ft
P50BL25	\$22.98	ea !	68AR	\$3.30	ft	S104D	\$1.60	ft	121A	\$10.44	ft
P50BL250	\$218.00	ea !	68DR	\$5.04	ft	S104D100	\$140.00	ea	121D	\$13.80	ft
P50W17	\$15.66	ea !	68GR	\$5.64	ft	S104W	\$1.60	ft	121G	\$15.54	ft
P50W25	\$22.98	ea !	B70C-100	\$250.00	ea !	S104W100	\$140.00	ea			

! = Only available in sizes shown.

Product Number	List Price	Per Unit	Product Number	List Price	Per Unit	Product Number	List Price	Per Unit	Product Number	List Price	Per Unit
123B	\$180.00	ft	149SNV	\$7.98	ft	160AM	\$10.08	ft	171AK	\$33.78	ft
136A	\$15.12	ft	151A	\$6.78	ft	160BDGM	\$15.00	ft	171B	\$136.00	ft
136B	\$153.00	ft	151B	\$82.02	ft	160D	\$13.92	ft	171BDG	\$15.66	ft
136BDG	\$25.08	ft	151D	\$9.18	ft	160DM	\$13.32	ft	171D	\$13.98	ft
136D	\$19.20	ft	151G	\$10.56	ft	160G	\$15.42	ft	171G	\$15.66	ft
136G	\$20.64	ft	153AT	\$9.90	ft	160GM	\$14.82	ft	171SN	\$15.06	ft
136SN	\$19.62	ft	153AV	\$8.94	ft	160PW	\$13.92	ft	172A	\$11.76	ft
140AM	\$11.04	ft	153BDGT	\$17.64	ft	160PWM	\$13.32	ft	172A36	\$34.56	ea
140BDGM	\$16.96	ft	153BDGV	\$15.72	ft	160SNM	\$13.80	ft	172AK	\$40.56	ft
140DM	\$15.00	ft	153DT	\$13.32	ft	161AM	\$14.16	ft	172B	\$162.00	ft
140GM	\$16.96	ft	153DV	\$12.36	ft	161BDGM	\$20.58	ft	172D	\$16.30	ft
140PWM	\$15.00	ft	153GT	\$17.64	ft	161DM	\$18.06	ft	172G	\$18.36	ft
140SNM	\$16.14	ft	153SNV	\$13.08	ft	161GM	\$20.40	ft	172SN	\$17.16	ft
142A	\$9.60	ft	154A	\$12.24	ft	161PWM	\$18.06	ft	173A	\$4.62	ft
142D	\$13.50	ft	154D	\$15.30	ft	161SNM	\$19.20	ft	173B	\$44.00	ft
142G	\$15.36	ft	154G	\$17.76	ft	163AM	\$10.20	ft	173D	\$6.60	ft
145A	\$9.84	ft	154SS36	\$252.00	ea \$	163BDGM	\$17.10	ft	173G	\$7.56	ft
145B	\$116.00	ft	154SS48	\$336.00	ea \$	163DM	\$13.86	ft	174B	\$79.00	ft
145BDG	\$17.76	ft	154SS72	\$504.00	ea \$	163GM	\$15.42	ft	174C	\$7.44	ft
145D	\$14.04	ft	154SS98	\$672.00	ea \$	163PWM	\$13.86	ft	174D	\$9.78	ft
145G	\$17.76	ft	154SS120	\$840.00	ea \$	163SNM	\$14.52	ft	174G	\$11.04	ft
145PW	\$14.04	ft	155AV	\$6.24	ft	164AM	\$13.38	ft	175A	\$8.82	ft
145SN	\$16.32	ft	155DV	\$8.46	ft	164BDGM	\$17.28	ft	175B	\$104.00	ft
146A	\$12.12	ft	155GV	\$9.60	ft	164DM	\$15.36	ft	175D	\$12.24	ft
146B	\$135.96	ft	156A	\$14.58	ft	164GM	\$17.28	ft	175G	\$15.30	ft
146BDG	\$20.58	ft	156D	\$16.80	ft	164PWM	\$15.36	ft	175SS36	\$234.00	ea \$
146D	\$16.44	ft	156G	\$18.84	ft	165AT	\$9.06	ft	175SS48	\$312.00	ea \$
146G	\$20.58	ft	157A	\$12.36	ft	165AV	\$8.16	ft	175SS72	\$468.00	ea \$
146PW	\$16.44	ft	157D	\$19.08	ft	165DT	\$11.82	ft	175SS98	\$624.00	ea \$
146SN	\$16.44	ft	157G	\$21.54	ft	165DV	\$10.86	ft	175SS120	\$780.00	ea \$
147A	\$11.10	ft	158A	\$12.36	ft	166A	\$6.36	ft	176A	\$15.90	ft
147BDG	\$19.56	ft	158D	\$19.08	ft	166D	\$8.82	ft	176A36	\$46.80	ft
147D	\$15.72	ft	158G	\$21.54	ft	166G	\$9.90	ft	176B	\$196.00	ft
147G	\$19.56	ft	158SS36	\$408.00	ea	167A	\$3.42	ft	176D	\$20.82	ft
147SN	\$16.92	ft	159AP	\$12.60	ft	167D	\$4.56	ft	176G	\$22.92	ft
149AP	\$5.28	ft	159AT	\$14.22	ft	167G	\$5.16	ft	177A	\$11.88	ft
149AT	\$6.36	ft	159AV	\$12.60	ft	168A	\$7.86	ft	177AP	\$12.48	ft
149AV	\$5.28	ft	159BDGP	\$19.20	ft	168D	\$11.28	ft	177AT	\$13.20	ft
149BDGP	\$8.58	ft	159BDGT	\$20.82	ft	168G	\$12.84	ft	177AV	\$12.48	ft
149BDGT	\$10.56	ft	159BDGV	\$19.20	ft	169A	\$6.48	ft	177BT	\$140.00	ft
149BDGV	\$9.18	ft	159BP	\$138.00	ft	169D	\$9.66	ft	177BV	\$140.00	ft
149DP	\$7.74	ft	159BT	\$138.00	ft	169G	\$10.92	ft	177DP	\$16.50	ft
149DT	\$9.18	ft	159BV	\$138.00	ft	170A	\$7.62	ft	177DT	\$17.22	ft
149DV	\$7.74	ft	159DP	\$16.68	ft	170A36	\$22.32	ea	177DV	\$16.50	ft
149GT	\$10.56	ft	159DT	\$18.48	ft	170B	\$102.00	ft	177GP	\$18.60	ft
149GV	\$9.18	ft	159DV	\$16.68	ft	170BDG	\$12.12	ft	177GT	\$19.32	ft
149PWP	\$6.36	ft	159GT	\$20.82	ft	170D	\$11.04	ft	177GV	\$18.60	ft
149PWT	\$8.22	ft	159GV	\$18.72	ft	170G	\$12.12	ft	179A	\$11.88	ft
149PWV	\$6.54	ft	159PWT	\$18.48	ft	171A	\$9.78	ft	179AP	\$12.48	ft
149SNP	\$7.98	ft	159PWV	\$16.68	ft	171A36	\$28.80	ea	179AT	\$13.20	ft
149SNT	\$9.78	ft	160A	\$10.68	ft				179AV	\$12.48	ft

! = Only available in sizes shown. \$ = Sizes ordered other than shown priced at the next larger size + \$6.00 each list.

Product Number	List Price	Per Unit	Product Number	List Price	Per Unit	Product Number	List Price	Per Unit	Product Number	List Price	Per Unit
179BT	\$140.00	ft	188G	\$5.52	ft	205AP	\$5.64	ft	213D	\$11.76	ft
179BV	\$140.00	ft	188SN	\$5.16	ft	205AT	\$6.36	ft	213G	\$13.20	ft
179DP	\$16.50	ft	189A	\$4.92	ft	205AV	\$5.64	ft	213SN	\$12.24	ft
179DT	\$17.22	ft	189B	\$36.72	ft	205DP	\$8.10	ft	214A	\$7.74	ft
179DV	\$16.50	ft	189D	\$7.14	ft	205DT	\$8.82	ft	214BDG	\$11.64	ft
179GT	\$19.32	ft	189G	\$8.10	ft	205DV	\$8.10	ft	214D	\$10.26	ft
179GV	\$18.60	ft	190A	\$7.62	ft	205GT	\$10.38	ft	214G	\$11.64	ft
181A	\$12.36	ft	190B	\$63.00	ft	205GV	\$9.66	ft	214PW	\$9.90	ft
181AP	\$13.08	ft	190D	\$9.48	ft	205PWP	\$8.10	ft	214SN	\$10.44	ft
181AT	\$13.80	ft	190G	\$10.62	ft	205PWT	\$8.82	ft	215APK	\$6.00	ft
181AV	\$13.08	ft	191A	\$10.44	ft	205PWV	\$8.10	ft	215AV	\$4.56	ft
181BP	\$154.00	ft	191B	\$94.00	ft	206AV	\$5.88	ft	215BDGPK	\$8.58	ft
181BT	\$154.00	ft	191D	\$13.80	ft	206DV	\$8.10	ft	215BDGV	\$6.96	ft
181BV	\$154.00	ft	191G	\$15.54	ft	206GV	\$9.06	ft	215DPK	\$7.50	ft
181DP	\$17.28	ft	192A	\$13.20	ft	207AV	\$6.84	ft	215DV	\$5.88	ft
181DT	\$18.12	ft	192B	\$135.00	ft	207DV	\$9.66	ft	215GPK	\$8.46	ft
181DV	\$17.28	ft	192D	\$17.16	ft	207GV	\$10.92	ft	215GV	\$6.72	ft
181GP	\$19.20	ft	192G	\$18.36	ft	208AV	\$3.30	ft	215PWPK	\$7.14	ft
181GT	\$20.34	ft	193A	\$18.96	ft	208DV	\$4.56	ft	215PWV	\$5.40	ft
181GV	\$19.20	ft	193B	\$206.00	ft	208GV	\$5.16	ft	215SNPK	\$7.74	ft
182A	\$16.74	ft	193D	\$25.08	ft	208OAK36	\$13.44	ea !	215SNV	\$6.00	ft
182D	\$22.92	ft	193G	\$26.94	ft	209AV	\$3.06	ft	216APK	\$6.12	ft
182G	\$25.68	ft	194A	\$6.96	ft	209DV	\$4.14	ft	216AV	\$4.68	ft
183A	\$1.98	ft	194B	\$62.00	ft	209GV	\$4.68	ft	216BDCFG	\$14.82	ft
183B	\$18.84	ft	194D	\$10.02	ft	210APK	\$5.40	ft	216BDGFG	\$14.82	ft
183BDG	\$4.56	ft	194G	\$11.40	ft	210AV	\$3.78	ft	216BDGPK	\$8.34	ft
183D	\$3.48	ft	195A	\$4.68	ft	210BDGPK	\$7.62	ft	216BDGV	\$6.84	ft
183G	\$4.20	ft	195B	\$44.00	ft	210BDGV	\$5.88	ft	216BPK	\$63.00	ft
183SN	\$3.72	ft	195D	\$6.72	ft	210DPK	\$6.72	ft	216BV	\$63.00	ft
184AP	\$4.80	ft	195G	\$7.50	ft	210DV	\$5.04	ft	216DFG	\$12.24	ft
184AT	\$5.52	ft	196A	\$4.80	ft	210GPK	\$7.62	ft	216DPK	\$7.50	ft
184AV	\$4.80	ft	196B	\$50.00	ft	210GV	\$5.76	ft	216DV	\$5.76	ft
184BT	\$40.68	ft	196D	\$6.84	ft	210PWPK	\$6.24	ft	216GPK	\$8.22	ft
184BV	\$40.68	ft	196G	\$7.74	ft	210PWV	\$4.80	ft	216GV	\$6.72	ft
184DP	\$6.48	ft	E197BL	\$3.24	ft	210SNPK	\$7.10	ft	216PWFG	\$12.24	ft
184DT	\$7.20	ft	198A	\$10.38	ft	210SNV	\$5.52	ft	216PWPK	\$7.08	ft
184DV	\$6.48	ft	198B	\$117.00	ft	211APK	\$5.16	ft	216PWV	\$5.40	ft
184GT	\$8.34	ft	198D	\$15.90	ft	211AV	\$3.54	ft	216SNFG	\$14.34	ft
184GV	\$7.62	ft	198G	\$18.36	ft	211DPK	\$6.72	ft	216SNPK	\$7.74	ft
185AP	\$11.04	ft	E199/196A120	\$350.00	ea !	211DV	\$5.16	ft	216SNV	\$6.12	ft
185AT	\$11.76	ft	E199/196A180	\$525.00	ea !	211GPK	\$7.32	ft	217APK	\$6.00	ft
185AV	\$11.04	ft	E199/196A96	\$280.00	ea !	211GV	\$5.64	ft	217AV	\$4.56	ft
185DP	\$15.78	ft	E199BL	\$30.00	ft	211PWV	\$4.78	ft	217BDGPK	\$8.34	ft
185DT	\$16.50	ft	200A	\$6.72	ft	212A	\$5.88	ft	217BDGV	\$6.84	ft
185DV	\$15.78	ft	200B	\$79.00	ft	212BDG	\$9.42	ft	217DPK	\$7.44	ft
185GT	\$18.84	ft	200D	\$9.42	ft	212D	\$8.34	ft	217DV	\$5.88	ft
185GV	\$18.12	ft	200G	\$10.68	ft	212G	\$9.42	ft	217GPK	\$8.22	ft
188A	\$2.94	ft	203OAK36	\$21.42	ea !	212PW	\$8.34	ft	217GV	\$6.72	ft
188B	\$28.00	ft	203OAK72	\$42.84	ea !	212SN	\$8.58	ft	217PWPK	\$7.50	ft
188BDG	\$5.52	ft	204OAK36	\$61.20	ea !	213A	\$9.66	ft	217PWV	\$5.76	ft
188D	\$4.92	ft	204OAK72	\$122.40	ea !	213BDG	\$13.20	ft	217SNPK	\$7.74	ft

! = Only available in sizes shown.

Product Number	List Price	Per Unit	Product Number	List Price	Per Unit	Product Number	List Price	Per Unit	Product Number	List Price	Per Unit
217SNV	\$6.00	ft	231D	\$9.90	ft	252x2SSFG96	\$616.00	ea \$	253SSFG72	\$300.00	ea \$
218A	\$5.04	ft	231G	\$11.16	ft	252x3AFG	\$15.66	ft	253SSFG96	\$400.00	ea \$
218BDG	\$8.46	ft	233A	\$7.26	ft	252x3BFG	\$164.00	ft	253x3AFG	\$17.40	ft
218D	\$7.20	ft	233BDG	\$10.92	ft	252x3DFG	\$20.34	ft	253x3BFG	\$177.00	ft
218G	\$8.46	ft	233D	\$9.78	ft	252x3GFG	\$22.80	ft	253x3DFG	\$22.62	ft
218OAK36	\$18.36	ea !	233G	\$10.92	ft	252x3SSFG36	\$270.00	ea \$	253x3GFG	\$24.96	ft
218OAK72	\$36.72	ea !	233PW	\$9.30	ft	252x3SSFG48	\$360.00	ea \$	253x3SSFG36	\$300.00	ea \$
218PW	\$7.20	ft	233SN	\$9.90	ft	252x3SSFG72	\$540.00	ea \$	253x3SSFG48	\$400.00	ea \$
218SN	\$7.32	ft	234APK	\$4.80	ft	252x3SSFG96	\$720.00	ea \$	253x3SSFG72	\$600.00	ea \$
219A	\$6.48	ft	234AV	\$2.94	ft	252x4AFG	\$17.76	ft	253x3SSFG96	\$800.00	ea \$
219BDG	\$8.94	ft	234DPK	\$5.64	ft	252x4BFG	\$204.00	ft	253x4AFG	\$19.56	ft
219D	\$8.10	ft	234DV	\$4.08	ft	252x4DFG	\$23.40	ft	253x4BFG	\$218.00	ft
219G	\$8.94	ft	234GPK	\$6.12	ft	252x4SSFG36	\$300.00	ea \$	253x4DFG	\$25.68	ft
219OAK36	\$52.20	ea !	234GV	\$4.56	ft	252x4SSFG48	\$400.00	ea \$	253x4GFG	\$28.38	ft
219OAK72	\$104.40	ea !	236A	\$5.16	ft	252x4SSFG72	\$600.00	ea \$	253x4SSFG36	\$330.00	ea \$
219PW	\$8.10	ft	236B	\$42.84	ft	252x4SSFG96	\$800.00	ea \$	253x4SSFG48	\$440.00	ea \$
219SN	\$8.34	ft	236BDG	\$7.86	ft	252x5AFG	\$19.44	ft	253x4SSFG72	\$660.00	ea \$
220APK	\$5.88	ft	236D	\$6.96	ft	252x5BFG	\$222.00	ft	253x4SSFG96	\$880.00	ea \$
220AV	\$4.32	ft	236G	\$7.86	ft	252x5DFG	\$24.48	ft	253x5AFG	\$21.90	ft
220DPK	\$7.50	ft	246A	\$5.16	ft	252x226A	\$18.48	ft	253x5BFG	\$237.00	ft
220DV	\$5.76	ft	246D	\$6.72	ft	252x226AFG	\$14.28	ft	253x5DFG	\$28.08	ft
220GPK	\$8.22	ft	249AV36	\$41.00	ea !	252x226AFGP	\$14.58	ft	253x6AFG	\$27.92	ft
220GV	\$6.72	ft	249AV48	\$60.00	ea !	252x226AFGT	\$15.30	ft	253x6DFG	\$31.80	ft
221APK	\$14.58	ft	249AV72	\$82.00	ea !	252x226AFGV	\$14.58	ft	253x226AFG	\$16.14	ft
221AV	\$12.84	ft	249AV96	\$132.00	ea !	252x226AP	\$18.72	ft	253x226AFGP	\$16.38	ft
221DPK	\$18.60	ft	249AV120	\$160.00	ea !	252x226AT	\$19.44	ft	253x226AFGT	\$17.16	ft
221DV	\$16.92	ft	249DV36	\$54.00	ea !	252x226AV	\$18.72	ft	253x226AFGV	\$16.38	ft
221GPK	\$20.70	ft	249DV48	\$72.00	ea !	252x226BFGP	\$134.00	ft	253x226BFGP	\$156.00	ft
221GV	\$18.96	ft	249DV72	\$108.00	ea !	252x226BFGT	\$138.00	ft	253x226BFGT	\$157.00	ft
221PWW	\$16.92	ft	249DV96	\$160.00	ea !	252x226BFGV	\$134.00	ft	253x226BFGV	\$156.00	ft
222APK	\$7.50	ft	249DV120	\$200.00	ea !	252x226BP	\$138.00	ft	253x226DFGP	\$21.06	ft
222AV	\$5.76	ft	250AV36	\$43.00	ea !	252x226BT	\$142.00	ft	253x226DFGT	\$21.78	ft
222DPK	\$8.82	ft	250AV72	\$86.00	ea !	252x226BV	\$142.00	ft	253x226DFGV	\$21.06	ft
222DV	\$7.32	ft	250DV36	\$60.00	ea !	252x226DFGP	\$18.60	ft	253x226GFGP	\$23.04	ft
222GPK	\$9.78	ft	250DV72	\$120.00	ea !	252x226DFGT	\$19.32	ft	253x226GFGT	\$23.76	ft
222GV	\$8.22	ft	252A	\$5.04	ft	252x226DFGV	\$18.60	ft	253x226GFGV	\$23.04	ft
225AV	\$4.92	ft	252B	\$73.00	ft	252x226DP	\$22.80	ft	254A	\$8.94	ft
227A	\$16.80	ft	252D	\$7.08	ft	252x226DT	\$23.52	ft	254B	\$128.00	ft
227B	\$161.00	ft	252G	\$8.10	ft	252x226DV	\$22.80	ft	254D	\$12.48	ft
227D	\$23.64	ft	252SN	\$8.10	ft	252x226GFGP	\$20.46	ft	254G	\$13.98	ft
227G	\$26.46	ft	252SSFG36	\$117.00	ea \$	252x226GFGT	\$21.18	ft	254SSFG36	\$180.00	ea \$
228A	\$25.68	ft	252SSFG48	\$156.00	ea \$	252x226GFGV	\$20.46	ft	254SSFG48	\$240.00	ea \$
228D	\$35.16	ft	252SSFG72	\$234.00	ea \$	252x226GP	\$19.68	ft	254SSFG72	\$360.00	ea \$
228G	\$39.42	ft	252SSFG96	\$312.00	ea \$	252x226GV	\$24.48	ft	254SSFG96	\$480.00	ea \$
229A	\$19.08	ft	252x2AFG	\$13.80	ft	253A	\$6.84	ft	254x4AFG	\$21.66	ft
229D	\$25.56	ft	252x2BFG	\$150.00	ft	253B	\$87.00	ft	254x4B	\$265.00	ft
229G	\$28.80	ft	252x2DFG	\$17.88	ft	253D	\$9.42	ft	254x4BFG	\$261.00	ft
230A	\$9.60	ft	252x2GFG	\$20.28	ft	253G	\$10.68	ft	254x4DFG	\$28.74	ft
230D	\$13.32	ft	252x2SSFG36	\$231.00	ea \$	253SSFG36	\$150.00	ea \$	254x4GFG	\$31.80	ft
230G	\$15.18	ft	252x2SSFG48	\$308.00	ea \$	253SSFG48	\$200.00	ea \$	254x4SSFG36	\$360.00	ea \$
231A	\$7.74	ft	252x2SSFG72	\$462.00	ea \$				254x4SSFG48	\$480.00	ea \$

! = Only available in sizes shown. \$ = Sizes ordered other than shown priced at the next larger size + \$6.00 each list.

Product Number	List Price	Per Unit	Product Number	List Price	Per Unit	Product Number	List Price	Per Unit	Product Number	List Price	Per Unit
254x4SSFG72	\$720.00	ea \$	255x226DFGP	\$26.64	ft	273x3AFG	\$17.88	ft	278D	\$4.80	ft
254x4SSFG96	\$960.00	ea \$	255x226DFGT	\$27.18	ft	273x3BFG	\$166.00	ft	278G	\$6.00	ft
254x5AFG	\$24.12	ft	255x226DFGV	\$26.64	ft	273x3DFG	\$22.14	ft	278x224AFGT	\$14.28	ft
254x5B	\$284.00	ft	255x226DP	\$30.48	ft	273x3GFG	\$25.44	ft	278x224AFGP	\$14.16	ft
254x5BFG	\$278.00	ft	255x226DT	\$31.20	ft	273x4AFG	\$18.96	ft	278x224AFGV	\$14.16	ft
254x5DFG	\$30.96	ft	255x226DV	\$30.48	ft	273x4BFG	\$193.00	ft	278x224DFGT	\$18.60	ft
254x5GFG	\$34.26	ft	255x226GFGT	\$29.88	ft	273x4DFG	\$23.52	ft	278x224DFGP	\$18.45	ft
254x226A	\$22.38	ft	255x226GP	\$33.18	ft	273x4GFG	\$26.94	ft	278x224DFGV	\$18.48	ft
254x226AFG	\$18.24	ft	255x226GV	\$33.18	ft	273x224AFGT	\$16.20	ft	278x224GFGT	\$19.92	ft
254x226AFGP	\$18.48	ft	256A	\$13.80	ft	273x224AFGP	\$16.08	ft	278x224GFGP	\$19.80	ft
254x226AFGT	\$19.20	ft	256D	\$17.88	ft	273x224AFGV	\$16.08	ft	278x224GFGV	\$19.80	ft
254x226AFGV	\$18.48	ft	256G	\$19.98	ft	273x224DFGT	\$21.12	ft	278x292AFGPK	\$15.12	ft
254x226AP	\$22.62	ft	256x6A	\$35.58	ft	273x224DFGP	\$21.00	ft	278x292DFGPK	\$19.68	ft
254x226AT	\$23.40	ft	256x6AFG	\$31.20	ft	273x224DFGV	\$21.00	ft	279A	\$5.28	ft
254x226AV	\$22.68	ft	256x6D	\$43.92	ft	273x224GFGT	\$22.80	ft	279D	\$6.96	ft
254x226BFGT	\$203.00	ft	256x6DFG	\$39.96	ft	273x224GFGP	\$22.68	ft	279x224AFGT	\$14.76	ft
254x226BP	\$209.00	ft	256x6G	\$48.24	ft	273x224GFGV	\$22.68	ft	279x224AFGP	\$14.64	ft
254x226BT	\$210.00	ft	256x6GFG	\$44.28	ft	273x292AFGPK	\$17.04	ft	279x224AFGV	\$14.64	ft
254x226BV	\$209.00	ft	257A	\$13.44	ft	273x292DFGPK	\$22.20	ft	279x224DFGT	\$19.20	ft
254x226DFGP	\$24.24	ft	257B	\$142.00	ft	274A	\$8.10	ft	279x224DFGP	\$19.08	ft
254x226DFGT	\$24.96	ft	257D	\$18.00	ft	274B	\$104.00	ft	279x224DFGV	\$19.08	ft
254x226DFGV	\$24.24	ft	257G	\$20.34	ft	274D	\$10.44	ft	279x224GFGT	\$20.64	ft
254x226DP	\$26.22	ft	257x259A	\$32.76	ft	274G	\$11.40	ft	279x224GFGP	\$20.52	ft
254x226DT	\$26.94	ft	257x259B	\$286.00	ft	274x4AFG	\$19.98	ft	279x224GFGV	\$20.52	ft
254x226DV	\$26.22	ft	257x259D	\$41.40	ft	274x4B	\$216.00	ft	279x292AFGPK	\$15.30	ft
254x226GFGT	\$27.78	ft	257X259G	\$45.60	ft	274x4BFG	\$212.00	ft	279x292DFGPK	\$19.92	ft
254x226GFGV	\$27.06	ft	259A	\$11.40	ft	274x4DFG	\$24.72	ft	282A	\$3.06	ft
254x226GV	\$28.62	ft	259B	\$136.00	ft	274x4GFG	\$26.64	ft	282B	\$24.48	ft
255A	\$11.40	ft	259D	\$15.42	ft	274x224AFGT	\$17.22	ft	282D	\$4.32	ft
255B	\$146.00	ft	259G	\$17.28	ft	274x224AFGP	\$17.10	ft	282G	\$4.80	ft
255D	\$14.82	ft	270A	\$6.60	ft	274x224AFGV	\$17.10	ft	283A	\$4.92	ft
255G	\$16.56	ft	270A36	\$19.44	ea	274x224DFGT	\$22.32	ft	283B	\$51.48	ft
255x5AFG	\$26.94	ft	270B	\$92.00	ft	274x224DFGP	\$22.20	ft	283D	\$6.78	ft
255x5B	\$300.00	ft	270D	\$10.20	ft	274x224DFGV	\$22.20	ft	283G	\$7.56	ft
255x5BFG	\$296.00	ft	270G	\$12.00	ft	274x224GFGT	\$24.00	ft	285CPK	\$7.14	ft
255x5DFG	\$33.78	ft	271A	\$9.42	ft	274x224GFGP	\$23.88	ft	285CR	\$7.14	ft
255x5GFG	\$37.32	ft	271A36	\$27.72	ea	274x224GFGV	\$19.68	ft	285DPK	\$7.56	ft
255x6A	\$33.06	ft	271B	\$112.00	ft	274x292AFGPK	\$23.88	ft	285DR	\$7.56	ft
255x6AFG	\$29.04	ft	271D	\$13.92	ft	274x292DFGPK	\$29.52	ft	285GPK	\$8.40	ft
255x6D	\$40.92	ft	271G	\$16.38	ft	276A	\$15.90	ft	285GR	\$8.40	ft
255x226AFGP	\$20.94	ft	271SN	\$15.30	ft	276A36	\$46.80	ft	290APK	\$6.12	ft
255x226AFGT	\$21.66	ft	272A	\$11.76	ft	276B	\$184.00	ft	290APKSTOP	\$6.12	ft
255x226AFGV	\$20.94	ft	272A36	\$34.56	ft	276D	\$20.46	ft	290AS	\$6.72	ft
255x226AP	\$25.08	ft	272B	\$146.00	ft	276G	\$24.12	ft	290ASSTOP	\$6.72	ft
255x226AT	\$25.86	ft	272D	\$15.90	ft	277AR	\$15.78	ft	290AV	\$5.64	ft
255x226AV	\$25.08	ft	272G	\$18.72	ft	277AS	\$19.26	ft	290AVSTOP	\$5.64	ft
255x226BFGT	\$218.00	ft	272SN	\$17.52	ft	277DR	\$19.98	ft	290DPK	\$7.56	ft
255x226BFGV	\$217.00	ft	273A	\$7.08	ft	277DS	\$23.28	ft	290DPKSTOP	\$7.56	ft
255x226BP	\$222.00	ft	273B	\$81.00	ft	277GR	\$22.14	ft	290DS	\$8.16	ft
255x226BT	\$223.00	ft	273D	\$9.18	ft	277GS	\$25.98	ft	290DSSSTOP	\$8.16	ft
255x226BV	\$222.00	ft	273G	\$10.86	ft	278A	\$3.78	ft	290DV	\$6.96	ft

\$ = Sizes ordered other than shown priced at the next larger size + \$6.00 each list.

Product Number	List Price	Per Unit	Product Number	List Price	Per Unit	Product Number	List Price	Per Unit	Product Number	List Price	Per Unit
290DVSTOP	\$6.96	ft	300CP144	\$131.20	ea@	305D	\$3.06	ft	309GP	\$4.20	ft
290GPK	\$8.52	ft	300DP84	\$81.90	ea@	305DN	\$6.24	ft	309PWP	\$3.36	ft
290GPKSTOP	\$8.52	ft	300DP96	\$93.60	ea@	305DR	\$4.68	ft	309SNP	\$3.84	ft
290GS	\$9.36	ft	300DP108	\$126.00	ea@	305DS	\$6.36	ft	310C80	\$16.32	ea@
290GSSTOP	\$9.36	ft	300DP120	\$140.00	ea@	305G	\$3.72	ft	310C84	\$16.80	ea@
290GV	\$7.80	ft	300DP144	\$168.00	ea@	305GN	\$7.08	ft	310C96	\$19.20	ea@
294AV	\$1.44	ft	300GP84	\$91.00	ea@	305GR	\$5.52	ft	311CIN3.75	\$9.24	ft
294AVTST	\$4.20	ft	300GP96	\$104.00	ea@	305GS	\$7.20	ft	311CIN4.00	\$9.60	ft
294BDGV	\$3.24	ft	300GP108	\$140.40	ea@	305SSE	\$15.60	ft	311CIN4.25	\$10.08	ft
294CV	\$1.68	ft	300GP120	\$156.00	ea@	305SSR	\$15.60	ft	312BR	\$15.36	ft
294DV	\$2.94	ft	303APK	\$1.92	ft	305SSS	\$15.72	ft	312CR	\$3.84	ft
294DVTST	\$4.32	ft	303APKTST	\$3.18	ft	306AQD	\$2.16	ft	312DR	\$4.56	ft
294GV	\$3.36	ft	303AS	\$2.40	ft	306AQW	\$2.16	ft	312GR	\$5.52	ft
294PWW	\$2.70	ft	303ASTST	\$3.66	ft	306AV	\$1.44	ft	313AN	\$6.12	ft
294SNV	\$3.24	ft	303ATF	\$1.80	ft	306BDGV	\$3.00	ft	313AP	\$3.24	ft
296CPK	\$3.36	ft	303AV	\$1.44	ft	306DQD	\$3.54	ft	313DN	\$8.16	ft
296CR	\$4.44	ft	303AVTST	\$2.64	ft	306DV	\$2.64	ft	313DP	\$4.08	ft
296CS	\$6.36	ft	303BDGPK	\$3.66	ft	306GV	\$3.00	ft	313GN	\$9.36	ft
296DPK	\$4.56	ft	303BDGS	\$4.26	ft	306PWQW	\$3.30	ft	313GP	\$4.92	ft
296DR	\$5.52	ft	303BDGSTST	\$5.46	ft	306PWV	\$2.40	ft	314CN	\$11.40	ft
296DS	\$7.86	ft	303BDGV	\$3.00	ft	306SNV	\$2.94	ft	314DN	\$12.48	ft
296GPK	\$5.04	ft	303BDGVTST	\$4.20	ft	307APK	\$2.88	ft	314GN	\$14.04	ft
296GR	\$6.12	ft	303CPK	\$3.00	ft	307AV	\$2.04	ft	315BN	\$22.08	ft
296GS	\$8.76	ft	303CS	\$3.54	ft	307BDGPK	\$4.44	ft	315BR	\$21.72	ft
297APK	\$1.92	ft	303CSTST	\$4.74	ft	307BDGV	\$3.48	ft	315BDGN	\$6.60	ft
297AS	\$2.40	ft	303CV	\$2.40	ft	307CPK	\$3.66	ft	315CN	\$4.44	ft
297AV	\$1.44	ft	303CVTST	\$3.88	ft	307CV	\$2.76	ft	315CN36	\$13.00	ea
297BDGPK	\$3.66	ft	303DPK	\$3.30	ft	307DPK	\$4.02	ft	315CN36TK	\$14.20	ea
297BDGS	\$4.38	ft	303DPKTST	\$4.50	ft	307DV	\$3.00	ft	315CN-GS	\$10.44	ft
297BDGV	\$3.06	ft	303DS	\$3.78	ft	307GPK	\$4.38	ft	315CR	\$4.68	ft
297DPK	\$3.30	ft	303DSTST	\$5.04	ft	307GV	\$3.42	ft	315DN	\$5.64	ft
297DS	\$3.78	ft	303DV	\$2.64	ft	307PWPK	\$3.72	ft	315DR	\$5.40	ft
297DV	\$2.70	ft	303DVTST	\$3.96	ft	307PWV	\$2.76	ft	315GN	\$6.48	ft
297GPK	\$3.66	ft	303GPK	\$3.66	ft	307SNPK	\$4.32	ft	315GR	\$6.48	ft
297GS	\$4.38	ft	303GS	\$4.26	ft	307SNV	\$3.30	ft	315PWN	\$5.52	ft
297GV	\$3.06	ft	303GV	\$3.00	ft	308APK	\$2.88	ft	315PWR	\$5.52	ft
297PWPK	\$3.06	ft	303GVTST	\$4.26	ft	308AV	\$2.04	ft	315SNN	\$5.88	ft
297PWS	\$3.54	ft	303PWPK	\$2.88	ft	308BDGPK	\$4.38	ft	315SNN-GS	\$11.88	ft
297PWV	\$2.46	ft	303PWS	\$3.54	ft	308BDGV	\$3.42	ft	315SSN36	\$48.00	ea@
297SNPK	\$3.42	ft	303PWV	\$2.40	ft	308CV	\$2.16	ft	315SSN48	\$64.00	ea@
297SNS	\$4.08	ft	303PWWTST	\$3.72	ft	308CPK	\$3.66	ft	315SSN120	\$200.00	ea@
297SNV	\$3.00	ft	303SNPK	\$3.42	ft	308DPK	\$4.02	ft	315SSR36	\$48.00	ea@
300BP84	\$252.00	ea@	303SNS	\$3.90	ft	308DV	\$3.00	ft	315SSR48	\$64.00	ea@
300BP96	\$288.00	ea@	303SNV	\$2.94	ft	308GV	\$3.42	ft	315SSR72	\$105.00	ea@
300BP108	\$390.00	ea@	305BN	\$18.00	ft	308PWPK	\$3.66	ft	315SSR80	\$116.00	ea@
300BP120	\$432.00	ea@	305BR	\$15.96	ft	308PWV	\$2.76	ft	315SSR84	\$112.00	ea@
300BP144	\$516.00	ea@	305BS	\$18.48	ft	308SNPK	\$4.26	ft	315SSR96	\$128.00	ea@
300CP84	\$63.00	ea@	305C	\$2.46	ft	308SNV	\$3.30	ft	315SSR120	\$175.00	ea@
300CP96	\$72.00	ea@	305CN	\$5.16	ft	309AP	\$2.16	ft	315SSR3684	\$298.00	ea@
300CP108	\$97.20	ea@	305CR	\$3.72	ft	309BDGP	\$4.20	ft	316APK	\$1.92	ft
300CP120	\$108.00	ea@	305CS	\$5.28	ft	309DP	\$3.60	ft	316AS	\$2.40	ft

@ = Sizes ordered other than shown priced at the next available size.

Product Number	List Price	Per Unit	Product Number	List Price	Per Unit	Product Number	List Price	Per Unit	Product Number	List Price	Per Unit
316AV	\$1.44	ft	326SN	\$5.76	ft	345PWV	\$4.56	ft	351C144	\$190.00	ea@
316BDGPK	\$3.66	ft	327A	\$5.04	ft	346A	\$4.56	ft	351CP80	\$99.00	ea@
316BDGS	\$4.26	ft	327BDG	\$10.08	ft	346C	\$5.04	ft	351CP84	\$104.00	ea@
316BDGV	\$3.00	ft	327D	\$8.76	ft	346D	\$6.24	ft	351CP96	\$119.00	ea@
316DPK	\$3.30	ft	327G	\$10.08	ft	346G	\$7.20	ft	351CP108	\$161.00	ea@
316DS	\$3.78	ft	327PW	\$7.92	ft	346PW	\$6.24	ft	351CP120	\$179.00	ea@
316DV	\$2.64	ft	327SN	\$9.36	ft	347A	\$3.42	ft	351CP144	\$215.00	ea@
316GPK	\$3.66	ft	329CN	\$6.12	ft	347D	\$5.52	ft	351CPK84	\$107.00	ea@
316GS	\$4.26	ft	329DN	\$7.08	ft	347G	\$6.12	ft	351CPK96	\$122.00	ea@
316GV	\$3.00	ft	330AV	\$1.86	ft	MAG349D-37	\$6.60	ea !	351CPK120	\$183.00	ea@
317AN	\$6.96	ft	330BDGV	\$4.44	ft	MAG349D-85	\$15.60	ea !	351CS80	\$104.00	ea@
317AP	\$4.20	ft	330CV	\$2.88	ft	MAG349D-96	\$17.64	ea !	351CS84	\$109.00	ea@
317DN	\$8.28	ft	330DV	\$3.72	ft	MAG349D-121	\$22.20	ea !	351CS96	\$124.00	ea@
317DP	\$5.40	ft	330GV	\$4.44	ft	MAG349D-3684	\$37.44	ea !	351CS108	\$168.00	ea@
317GN	\$9.60	ft	330PWV	\$2.88	ft	MAG349W-37	\$6.60	ea !	351CS120	\$188.00	ea@
317GP	\$6.00	ft	330SNV	\$4.20	ft	MAG349W-85	\$15.60	ea !	351CS144	\$226.00	ea@
318AV	\$4.56	ft	B331-96	\$24.84	ea !	MAG349W-96	\$17.64	ea !	351CV80	\$99.00	ea@
318BDGV	\$8.52	ft	332CR	\$3.66	ft	MAG349W-121	\$22.20	ea !	351CV84	\$104.00	ea@
318DV	\$7.68	ft	332CS	\$5.28	ft	MAG349W-3684	\$37.44	ea !	351CV96	\$119.00	ea@
318GV	\$8.52	ft	332DR	\$4.68	ft	350CSPK	\$14.64	ft	351CV120	\$179.00	ea@
318PWV	\$7.32	ft	332DS	\$6.30	ft	350CSR	\$14.64	ft	351C/CP80	\$187.00	ea@
319CN	\$5.64	ft	332GR	\$5.52	ft	350DSPK	\$17.28	ft	351C/CP84	\$196.00	ea@
319CR	\$4.20	ft	332GS	\$7.20	ft	350DSR	\$17.28	ft	351C/CP96	\$224.00	ea@
319CS	\$5.76	ft	335AR	\$4.20	ft	350GSPK	\$19.20	ft	351C/CV96	\$224.00	ea@
319DN	\$6.72	ft	335DR	\$5.52	ft	350GSR	\$19.20	ft	351C/CP120	\$336.00	ea@
319DR	\$5.16	ft	336A	\$2.28	ft	351B80	\$456.00	ea@	351D80	\$114.00	ea@
319DS	\$6.84	ft	336D	\$3.36	ft	351B84	\$478.00	ea@	351D84	\$120.00	ea@
319GN	\$7.56	ft	PA343-36	\$10.08	ea !	351B96	\$547.00	ea@	351D96	\$136.00	ea@
319GR	\$6.12	ft	PA343-48	\$13.44	ea !	351B108	\$734.00	ea@	351D108	\$184.00	ea@
319GS	\$7.68	ft	B344-36	\$46.80	ea !	351B120	\$816.00	ea@	351D120	\$205.00	ea@
319SSN	\$16.08	ft	PA344-36	\$10.08	ea !	351BPK84	\$488.00	ea@	351DP80	\$118.00	ea@
321CN	\$5.16	ft	B344-48	\$62.28	ea !	351BPK96	\$556.00	ea@	351DP84	\$124.00	ea@
321DN	\$6.24	ft	PA344-48	\$13.44	ea !	351BP80	\$464.00	ea@	351DP96	\$142.00	ea@
321GN	\$7.08	ft	345A	\$2.28	ft	351BP84	\$487.00	ea@	351DP108	\$192.00	ea@
321SSN	\$9.24	ft	345APK	\$4.68	ft	351BP96	\$556.00	ea@	351DP120	\$212.00	ea@
322CSPK	\$15.60	ft	345AV	\$3.60	ft	351BP108	\$750.00	ea@	351DPK84	\$127.00	ea@
322DSPK	\$18.00	ft	345B	\$23.64	ft	351BP120	\$833.00	ea@	351DPK96	\$145.00	ea@
322GSPK	\$20.28	ft	345BDG	\$4.20	ft	351BS84	\$488.00	ea@	351DPK120	\$218.00	ea@
324A	\$4.80	ft	345BDGPK	\$6.60	ft	351BS96	\$556.00	ea@	351DS84	\$130.00	ea@
324B	\$55.00	ft	345BDGV	\$5.64	ft	351BS108	\$750.00	ea@	351DS96	\$148.00	ea@
324BDG	\$9.84	ft	345C	\$2.82	ft	351BS120	\$833.00	ea@	351DS108	\$200.00	ea@
324D	\$6.12	ft	345CV	\$4.32	ft	351BV84	\$487.00	ea@	351DS120	\$220.00	ea@
324G	\$7.08	ft	345D	\$3.42	ft	351BV108	\$750.00	ea@	351DS144	\$224.00	ea@
324PW	\$5.88	ft	345DPK	\$5.88	ft	351BV120	\$833.00	ea@	351DV80	\$118.00	ea@
324SN	\$6.12	ft	345DV	\$5.04	ft	351B/BP84	\$965.00	ea@	351DV84	\$124.00	ea@
326A	\$3.12	ft	345G	\$4.20	ft	351B/BP96	\$1,100.00	ea@	351DV96	\$142.00	ea@
326B	\$68.00	ft	345GPK	\$6.60	ft	351C80	\$88.00	ea@	351DV120	\$212.00	ea@
326BDG	\$6.00	ft	345GV	\$5.64	ft	351C84	\$92.40	ea@	351D/DP80	\$232.00	ea@
326D	\$5.40	ft	345PW	\$3.48	ft	351C96	\$105.60	ea@	351D/DP84	\$244.00	ea@
326G	\$6.00	ft	345PWPK	\$5.40	ft	351C108	\$142.56	ea@	351D/DP108	\$376.00	ea@
326PW	\$4.68	ft	345SNV	\$5.16	ft	351C120	\$158.40	ea@	351D/DV80	\$232.00	ea@

@ = Sizes ordered other than shown priced at the next available size. ! = Only available in sizes shown.

Product Number	List Price	Per Unit	Product Number	List Price	Per Unit	Product Number	List Price	Per Unit	Product Number	List Price	Per Unit
351D/DV96	\$278.00	ea@	354C108	\$150.00	ea@	354GS96	\$171.96	ea@	355GP96	\$61.08	ea@
351G80	\$128.00	ea@	354C120	\$166.44	ea@	354GV84	\$144.00	ea@	355GP108	\$68.76	ea@
351G84	\$134.00	ea@	354CP80	\$97.20	ea@	354GV96	\$164.52	ea@	355GS84	\$59.40	ea@
351G96	\$153.00	ea@	354CP84	\$102.00	ea@	355BDGP84	\$53.40	ea@	355GS96	\$67.80	ea@
351G120	\$230.00	ea@	354CP96	\$116.40	ea@	355BDGP108	\$82.56	ea@	355GS108	\$91.44	ea@
351GP80	\$132.00	ea@	354CP108	\$157.32	ea@	355BDGS84	\$59.40	ea@	355GS120	\$101.64	ea@
351GP84	\$138.00	ea@	354CP120	\$174.84	ea@	355BDGS96	\$67.80	ea@	355GV80	\$50.76	ea@
351GP96	\$158.00	ea@	354CPK84	\$104.76	ea@	355BDGS120	\$101.64	ea@	355GV84	\$53.40	ea@
351GP120	\$236.00	ea@	354CPK96	\$119.64	ea@	355BDGV84	\$53.40	ea@	355GV96	\$61.08	ea@
351GPK84	\$142.00	ea@	354CPK108	\$161.52	ea@	355BDGV96	\$61.08	ea@	355GV108	\$82.56	ea@
351GPK96	\$163.00	ea@	354CPK120	\$179.28	ea@	355BDGV108	\$82.56	ea@	355GV120	\$91.68	ea@
351GS80	\$139.00	ea@	354CS84	\$107.76	ea@	355BDGV120	\$91.68	ea@	355PWP84	\$44.16	ea@
351GS84	\$146.00	ea@	354CS96	\$123.00	ea@	355BP84	\$299.88	ea@	355PWP96	\$50.40	ea@
351GS96	\$167.00	ea@	354CS120	\$184.32	ea@	355BP108	\$448.80	ea@	355PWP120	\$75.60	ea@
351GS120	\$250.00	ea@	354CV84	\$102.00	ea@	355BS84	\$303.96	ea@	355PWS80	\$47.16	ea@
351GV84	\$134.00	ea@	354CV96	\$116.40	ea@	355BS96	\$336.60	ea@	355PWS84	\$49.32	ea@
351GV96	\$153.00	ea@	354CV120	\$174.84	ea@	355BS108	\$456.96	ea@	355PWS96	\$56.40	ea@
351G/GP80	\$261.00	ea@	354C/CP120	\$341.28	ea@	355BS120	\$510.00	ea@	355PWS108	\$76.20	ea@
351G/GP84	\$274.00	ea@	354C/CP84	\$199.20	ea@	355BV84	\$299.88	ea@	355PWS120	\$84.72	ea@
351G/GP96	\$313.00	ea@	354C/CP96	\$227.28	ea@	355BV96	\$332.52	ea@	355PWW84	\$44.16	ea@
352CR80	\$73.44	ea@	354C/CV120	\$341.28	ea@	355BV108	\$450.84	ea@	355PWW96	\$50.40	ea@
352CR84	\$77.28	ea@	354C/CV84	\$199.20	ea@	355BV120	\$501.84	ea@	355PWW108	\$68.04	ea@
352CR96	\$88.08	ea@	354D80	\$117.96	ea@	355CP84	\$35.40	ea@	355PWW120	\$75.60	ea@
352CR108	\$119.28	ea@	354D84	\$123.72	ea@	355CP96	\$40.32	ea@	355SNP84	\$49.32	ea@
352CR120	\$132.24	ea@	354D96	\$141.36	ea@	355CP108	\$54.48	ea@	355SNP96	\$56.40	ea@
352DR84	\$107.76	ea@	354D120	\$212.16	ea@	355CP120	\$60.60	ea@	355SNP120	\$112.80	ea@
352DR96	\$123.00	ea@	354DP84	\$128.52	ea@	355CS80	\$38.64	ea@	355SNS84	\$54.72	ea@
352DR108	\$165.84	ea@	354DP96	\$146.76	ea@	355CS84	\$40.68	ea@	355SNS96	\$62.40	ea@
352DR120	\$184.32	ea@	354DP120	\$220.32	ea@	355CS96	\$46.44	ea@	355SNS108	\$84.36	ea@
352GR84	\$120.72	ea@	354DPK80	\$125.04	ea@	355CS108	\$62.64	ea@	355SNV84	\$49.32	ea@
352GR120	\$206.52	ea@	354DPK84	\$131.40	ea@	355CS120	\$69.60	ea@	355SNV96	\$56.40	ea@
354B80	\$442.00	ea@	354DPK96	\$150.12	ea@	355CV80	\$33.72	ea@	355SNV108	\$76.08	ea@
354B84	\$464.00	ea@	354DPK120	\$225.12	ea@	355CV84	\$35.40	ea@	356AV80	\$21.00	ea@
354B96	\$534.00	ea@	354DS84	\$134.28	ea@	355CV96	\$40.32	ea@	356AV84	\$22.08	ea@
354B108	\$718.00	ea@	354DS96	\$153.48	ea@	355CV108	\$54.48	ea@	356AV96	\$25.20	ea@
354B120	\$798.00	ea@	354DS108	\$206.76	ea@	355CV120	\$60.60	ea@	356AV120	\$37.92	ea@
354BP80	\$450.00	ea@	354DS120	\$230.16	ea@	355DP84	\$47.64	ea@	356BDGV80	\$28.68	ea@
354BP84	\$472.00	ea@	354DV84	\$128.52	ea@	355DP96	\$54.48	ea@	356BDGV84	\$30.00	ea@
354BP96	\$548.00	ea@	354DV96	\$146.76	ea@	355DP120	\$81.60	ea@	356BDGV96	\$34.32	ea@
354BP108	\$732.00	ea@	354DV108	\$198.12	ea@	355DS80	\$50.40	ea@	356BDGV120	\$51.24	ea@
354BP120	\$816.00	ea@	354DV120	\$220.32	ea@	355DS84	\$52.92	ea@	356DV80	\$25.44	ea@
354BPK96	\$550.00	ea@	354D/DP84	\$252.24	ea@	355DS96	\$60.48	ea@	356DV84	\$26.64	ea@
354BS80	\$454.00	ea@	354D/DP96	\$288.12	ea@	355DS108	\$81.60	ea@	356DV96	\$30.48	ea@
354BS84	\$480.00	ea@	354G84	\$138.72	ea@	355DS120	\$90.72	ea@	356DV120	\$45.84	ea@
354BS96	\$550.00	ea@	354G96	\$158.52	ea@	355DV80	\$45.24	ea@	356PWW80	\$25.44	ea@
354BS120	\$816.00	ea@	354G120	\$237.48	ea@	355DV84	\$47.64	ea@	356PWW84	\$26.64	ea@
354BV84	\$472.00	ea@	354GP84	\$144.00	ea@	355DV96	\$54.48	ea@	356PWW96	\$30.48	ea@
354BV120	\$816.00	ea@	354GP96	\$164.52	ea@	355DV108	\$73.44	ea@	356PWW120	\$45.84	ea@
354C80	\$92.40	ea@	354GP120	\$246.60	ea@	355DV120	\$81.60	ea@	356SNV84	\$32.40	ea@
354C84	\$97.20	ea@	354GPK84	\$147.12	ea@	355GP80	\$50.76	ea@	356SNV96	\$36.96	ea@
354C96	\$110.88	ea@	354GPK96	\$168.12	ea@	355GP84	\$53.40	ea@	357C80	\$40.80	ea@

@ = Sizes ordered other than shown priced at the next available size.

Product Number	List Price	Per Unit	Product Number	List Price	Per Unit	Product Number	List Price	Per Unit	Product Number	List Price	Per Unit
357C84	\$42.84	ea @	359D80	\$61.80	ea @	405GV36	\$33.72	ea !	1855AV	\$11.04	ft
357C96	\$48.96	ea @	359D84	\$61.80	ea @	405PWW36	\$24.48	ea !	1855DP	\$15.84	ft
357C108	\$66.12	ea @	359D96	\$70.92	ea @	SL450U	\$15.84	ft	1855DT	\$16.68	ft
357C120	\$73.44	ea @	359D108	\$104.88	ea @	SLA450	\$4.92	ea	1855DV	\$15.84	ft
357D80	\$52.20	ea @	359D120	\$117.96	ea @	510C36	\$55.92	ea @	1855GT	\$18.72	ft
357D84	\$54.84	ea @	368CN	\$7.80	ft	510C48	\$74.64	ea @	1855GV	\$17.76	ft
357D96	\$62.64	ea @	368DN	\$9.12	ft	510D36	\$64.92	ea @	1875A	\$15.24	ft
357D108	\$84.60	ea @	368GN	\$10.32	ft	510D48	\$86.52	ea @	1875D	\$21.24	ft
357D120	\$93.96	ea @	369AP	\$3.66	ft	530C36	\$92.04	ea @	1875G	\$23.88	ft
357G80	\$58.80	ea @	369APK	\$4.26	ft	530C48	\$122.64	ea @	1877A	\$21.24	ft
357G84	\$61.68	ea @	369AS	\$4.62	ft	530D36	\$102.12	ea @	1877D	\$22.56	ft
357G96	\$70.56	ea @	369AV	\$3.66	ft	530D48	\$135.96	ea @	1877G	\$25.32	ft
357G108	\$84.60	ea @	369CP	\$4.26	ft	1546A	\$13.32	ft	1951A	\$3.60	ft
357G120	\$105.72	ea @	369DP	\$4.74	ft	1546AK	\$42.12	ft	1951D	\$4.44	ft
357SP80	\$39.12	ea \$	369DPK	\$5.10	ft	1546D	\$16.32	ft	2001AP	\$10.80	ft
357SP80xTB	\$57.12	ea \$	369DS	\$5.56	ft	1547A	\$15.96	ft	2001AT	\$11.64	ft
357SP84	\$41.16	ea \$	369DV	\$4.74	ft	1571A	\$24.48	ft	2001AV	\$10.80	ft
357SP84xTB	\$60.00	ea \$	369GP	\$5.34	ft	1665A	\$11.04	ft	2001DP	\$13.80	ft
357SP86	\$42.12	ea \$	369GPK	\$5.70	ft	1665D	\$14.76	ft	2001DT	\$14.64	ft
357SP86xTB	\$61.20	ea \$	369GS	\$6.48	ft	1665G	\$16.56	ft	2001DV	\$13.80	ft
357SP96	\$47.04	ea \$	369GV	\$5.40	ft	1700A	\$5.52	ft	2001GT	\$16.68	ft
357SP96xTB	\$68.52	ea \$	A371P84	\$25.20	ea !	1700D	\$7.80	ft	2001GV	\$15.84	ft
357SP108	\$71.04	ea \$	A371P96	\$28.80	ea !	1710A	\$7.44	ft	2002AQ	\$9.60	ft
357SP108xTB	\$97.92	ea \$	A372P84	\$28.32	ea !	1710D	\$11.64	ft	2002DQ	\$12.60	ft
357SP120	\$71.04	ea \$	A372P96	\$32.28	ea !	1715A	\$24.84	ft	2002GQ	\$14.40	ft
357SP120xTB	\$97.92	ea \$	375BR	\$29.04	ft	1715AK	\$48.84	ft	2005AP	\$10.80	ft
357SPND80	\$36.72	ea \$	375CR	\$5.40	ft	1715D	\$33.60	ft	2005AT	\$11.64	ft
357SPND84	\$37.80	ea \$	375DR	\$7.32	ft	1716A	\$35.40	ft	2005AV	\$10.80	ft
357SPND86	\$38.76	ea \$	375GR	\$8.16	ft	1716AK	\$64.20	ft	2005BP	\$122.00	ft
357SPND96	\$44.04	ea \$	377V	\$4.68	ft	1716D	\$47.88	ft	2005BT	\$123.00	ft
357SPND108	\$67.32	ea \$	377VP	\$5.04	ft	1717A	\$41.52	ft	2005BV	\$122.00	ft
357SPND120	\$67.32	ea \$	378C86	\$70.92	ea !	1717AK	\$75.12	ft	2005DP	\$13.80	ft
357SS84	\$171.36	ea \$	378C96	\$78.96	ea !	1717D	\$55.92	ft	2005DT	\$14.64	ft
357SS84xTB	\$188.76	ea \$	378D86	\$143.28	ea !	1718A	\$47.28	ft	2005DV	\$13.80	ft
357SS96	\$195.84	ea \$	378D96	\$159.96	ea !	1718AK	\$85.68	ft	2005GP	\$15.84	ft
357SS96xTB	\$213.84	ea \$	378G86	\$160.56	ea !	1718D	\$63.72	ft	2005GT	\$16.68	ft
357SS120	\$265.20	ea \$	378G96	\$179.40	ea !	1719A	\$53.28	ft	2005GV	\$15.84	ft
357SS120xTB	\$283.20	ea \$	379CPK	\$10.80	ft	1719AK	\$96.48	ft	2006AP	\$10.80	ft
CUT357	\$6.00	ea	379CR	\$10.80	ft	1719D	\$71.88	ft	2006APK	\$11.64	ft
358CN	\$13.32	ft	379CS	\$12.24	ft	1842APK	\$3.84	ft	2006AT	\$11.64	ft
358DN	\$16.68	ft	379DPK	\$13.08	ft	1842AS	\$4.56	ft	2006AV	\$10.80	ft
358GN	\$18.72	ft	379DR	\$13.08	ft	1842AV	\$3.12	ft	2006DP	\$13.80	ft
359A80	\$14.40	ea @	379DS	\$13.44	ft	1842DPK	\$4.56	ft	2006DPK	\$14.64	ft
359A84	\$14.40	ea @	379GPK	\$14.76	ft	1842DS	\$5.52	ft	2006DT	\$14.64	ft
359A96	\$16.92	ea @	379GR	\$14.76	ft	1842DV	\$4.44	ft	2006DV	\$13.80	ft
359A120	\$28.92	ea @	379GS	\$15.36	ft	1842GPK	\$5.40	ft	2006GT	\$16.68	ft
359BDG80	\$75.84	ea @	P395V25	\$16.80	ea	1842GS	\$6.12	ft	2006STCxQ380A	\$11.64	ft
359BDG84	\$75.84	ea @	405CV36	\$21.48	ea !	1842GV	\$4.92	ft	2006STCxQ380D	\$14.64	ft
359BDG96	\$88.32	ea @	405CV42	\$24.96	ea !	1855AP	\$11.04	ft	2007APK	\$11.64	ft
359BDG120	\$132.72	ea @	405DV36	\$27.60	ea !	1855AT	\$12.12	ft	2007AT	\$11.64	ft

! = Only available in sizes shown. @ = Sizes ordered other than shown priced at the next available size.
 \$ = Sizes ordered other than shown priced at the next larger size + \$6.00 each list.

Product Number	List Price	Per Unit	Product Number	List Price	Per Unit	Product Number	List Price	Per Unit	Product Number	List Price	Per Unit
2007DPK	\$14.64	ft	2113GV36UN	\$25.80	ea !	2175W72	\$15.96	ea !	ADJ2325V14-36BL	\$165.00	ea !
2007DT	\$14.64	ft	2113GV48	\$47.40	ea !	2211APK	\$15.12	ft	EV232BL-36	\$35.16	ea !
2007STCxQ380A	\$11.64	ft	2113GV48UN	\$34.44	ea !	2203AV	\$9.76	ft	EV232BL-48	\$46.44	ea !
2007STCxQ380D	\$14.64	ft	2120A36	\$5.76	ea !	2203DV	\$11.76	ft	EV232BL-73	\$70.32	ea !
2008APK	\$11.64	ft	2120A72	\$11.64	ea !	2211AV	\$13.56	ft	EV232D-36	\$36.72	ea !
2008DPK	\$14.64	ft	2120G36	\$7.08	ea !	2211DPK	\$19.32	ft	EV232D-48	\$46.32	ea !
2008STCxQ380A	\$11.64	ft	2120G72	\$13.92	ea !	2211DV	\$17.88	ft	EV232D-73	\$74.52	ea !
2008STCxQ380D	\$14.64	ft	2131A36	\$4.44	ea !	2211GPK	\$21.48	ft	EV2320BL-36	\$35.76	ea !
2009APK	\$12.24	ft	2131A72	\$8.64	ea !	2211GV	\$20.16	ft	EV2320BL-48	\$47.28	ea !
2009DPK	\$15.96	ft	2131G36	\$5.64	ea !	2212APK773BL36	\$43.74	ea !	EV2320BL-73	\$71.16	ea !
2010APK	\$12.24	ft	2131G72	\$11.40	ea !	2212APK773BL49	\$58.32	ea !	EV2321BL-36	\$40.32	ea !
2010DPK	\$15.96	ft	2132A36	\$5.52	ea !	2212APK773GR36	\$43.74	ea !	EV2321BL-48	\$81.60	ea !
2051AP	\$6.48	ft	2132A72	\$11.16	ea !	2212APK773GR49	\$58.32	ea !	EV2321BL-73	\$81.60	ea !
2051AT	\$7.32	ft	2132G36	\$7.32	ea !	2212DPK773BL36	\$55.80	ea !	EV2321D-36	\$40.32	ea !
2051AV	\$6.84	ft	2132G72	\$14.52	ea !	2212DPK773BL49	\$74.40	ea !	EV2321D-73	\$81.60	ea !
2051DP	\$8.52	ft	2132W36	\$7.68	ea !	2212GPK773BL36	\$62.10	ea !	EV2322BL-36	\$35.76	ea !
2051DT	\$9.96	ft	2132W72	\$15.60	ea !	2212GPK773BL49	\$82.80	ea !	EV2322BL-48	\$47.28	ea !
2051DV	\$8.64	ft	2133W36	\$24.12	ea !	2213AV36	\$59.64	ea	EV2322BL-73	\$71.16	ea !
2051GT	\$11.04	ft	2133W72	\$48.12	ea !	2218A36	\$4.32	ea !	EV2325BL-36	\$35.16	ea !
2051GV	\$9.96	ft	2134A36	\$7.92	ea !	2218A72	\$8.52	ea !	EV2325BL-48	\$46.44	ea !
2051PWP	\$8.76	ft	2134A72	\$15.96	ea !	2218G36	\$5.40	ea !	EV2325BL-73	\$70.32	ea !
2051PWT	\$9.96	ft	2134G36	\$9.96	ea !	2218G72	\$10.92	ea !	EV2325D-36	\$37.44	ea !
2051PWW	\$8.64	ft	2134G72	\$19.92	ea !	2219A36	\$4.92	ea !	EV2325D-48	\$47.28	ea !
2052A36	\$13.56	ea !	2163AV36UN	\$17.40	ea !	2219A72	\$9.84	ea !	EV2325D-73	\$71.16	ea !
2052A72	\$27.36	ea !	2163DV36UN	\$21.60	ea !	2219G36	\$6.12	ea !	EV2326BL-36	\$35.76	ea !
2052D36	\$16.32	ea !	2170DV36	\$26.88	ea !	2219G72	\$12.36	ea !	EV2326BL-48	\$47.28	ea !
2052D72	\$32.64	ea !	2170DV36UN	\$22.92	ea !	2219W36	\$6.72	ea !	EV2326BL-73	\$71.16	ea !
2053A36	\$16.92	ea !	2170DV48	\$36.00	ea !	2219W72	\$13.20	ea !	EV2326D-36	\$35.76	ea !
2053A72	\$33.84	ea !	2170DV48UN	\$30.48	ea !	2221APK	\$7.92	ft	2343AV36	\$20.52	ea !
2053D36	\$21.48	ea !	2170VV36	\$26.88	ea !	2221AV	\$6.48	ft	2343AV36UN	\$10.92	ea !
2053D72	\$42.96	ea !	2170VV36UN	\$22.92	ea !	2221DPK	\$10.20	ft	2343AV48	\$27.48	ea !
2054A36	\$17.88	ea !	2170VV48	\$36.00	ea !	2221DV	\$8.28	ft	2343AV48UN	\$14.40	ea !
2054A72	\$35.64	ea !	2170VV48UN	\$30.48	ea !	2221GPK	\$11.28	ft	2343DV36	\$24.72	ea !
2054D36	\$21.72	ea !	2173AV36	\$29.28	ea !	2221GV	\$9.48	ft	2343DV36UN	\$13.08	ea !
2054D72	\$43.44	ea !	2173AV36UN	\$18.36	ea !	2250W36	\$15.72	ea !	2343DV48	\$32.88	ea !
2055A36	\$18.84	ea !	2173AV48	\$38.88	ea !	2250W72	\$31.32	ea !	2343DV48UN	\$17.52	ea !
2055A72	\$37.80	ea !	2173AV48UN	\$24.48	ea !	2251AV	\$5.04	ft	2343GV36	\$27.72	ea !
2055BDG36	\$33.48	ea !	2173BDGV36	\$40.92	ea !	2266A	\$27.48	ft	2343GV48	\$36.96	ea !
2055BDG72	\$66.84	ea !	2173BDGV36UN	\$23.28	ea !	2266D	\$38.40	ft	2350W36.5	\$18.36	ea !
2055BDG96	\$89.16	ea !	2173BDGV48	\$54.48	ea !	2286A	\$36.60	ft	2350W73.5	\$36.60	ea !
2055D36	\$24.60	ea !	2173BDGV48UN	\$30.96	ea !	2286D	\$49.32	ft	2364A	\$9.24	ft
2055D72	\$49.08	ea !	2173DV36	\$35.28	ea !	2286G	\$55.20	ft	2364B	\$88.80	ft
2113AV36	\$28.56	ea !	2173DV36UN	\$22.20	ea !	2300W36	\$20.40	ea !	2364D	\$12.60	ft
2113AV36UN	\$19.80	ea !	2173DV48	\$47.04	ea !	2300W72	\$40.80	ea !	2364G	\$14.16	ft
2113AV48	\$37.92	ea !	2173DV48UN	\$29.52	ea !	ADJ232V8-36BL	\$120.00	ea !	2366A	\$14.28	ft
2113AV48UN	\$26.40	ea !	2173GV36	\$38.64	ea !	ADJ232V8-48BL	\$160.00	ea !	2366D	\$19.44	ft
2113DV36	\$34.92	ea !	2173PWW36	\$36.72	ea !	ADJ232V8-73BL	\$239.00	ea !	2408C72	\$9.84	ea !
2113DV36UN	\$25.08	ea !	2173PWW36UN	\$22.56	ea !	ADJ2325V8-36BL	\$120.00	ea !	2464A	\$11.04	ft
2113DV48	\$46.44	ea !	2173PWW48	\$48.96	ea !	ADJ232V14-36BL	\$165.00	ea !	2464D	\$14.16	ft
2113DV48UN	\$33.48	ea !	2173PWW48UN	\$30.00	ea !	ADJ232V14-48BL	\$220.00	ea !	2464G	\$15.96	ft
2113GV36	\$35.64	ea !	2175W36	\$7.92	ea !	ADJ232V14-73BL	\$330.00	ea !	2500W36	\$45.00	ea !

! = Only available in sizes shown.

Product Number	List Price	Per Unit	Product Number	List Price	Per Unit	Product Number	List Price	Per Unit	Product Number	List Price	Per Unit
2500W72	\$90.00	ea !	2749D	\$28.44	ft	2959C96	\$28.92	ea !	3452CPK	\$4.44	ft
2548A	\$20.52	ft	2749G	\$32.04	ft	3151BN36	\$73.00	ea	3452CV	\$3.48	ft
2548D	\$27.36	ft	2750A	\$25.56	ft	3151CN	\$6.48	ft	3452DPK	\$4.44	ft
2548G	\$30.84	ft	2750D	\$33.72	ft	3151CN36	\$19.44	ea	3452DV	\$3.48	ft
2549A	\$23.16	ft	2750G	\$38.04	ft	3151CN48	\$25.92	ea	3452GPK	\$4.80	ft
2549D	\$30.72	ft	2813A	\$11.64	ft	3151CR	\$4.32	ft	3452GV	\$3.84	ft
2549G	\$34.80	ft	2813BDG	\$17.52	ft	3151DN	\$8.52	ft	3452PWPK	\$4.44	ft
2550A	\$25.68	ft	2813D	\$13.20	ft	3151DN36	\$25.56	ea	3452PWV	\$3.48	ft
2550D	\$34.08	ft	2813G	\$14.76	ft	3151DN48	\$34.08	ea	3452SNPK	\$4.56	ft
2550G	\$38.52	ft	2813PW	\$13.56	ft	3151DR	\$6.60	ft	3452SNV	\$3.60	ft
2555A	\$13.68	ft	2813SN	\$13.80	ft	3151SSN	\$22.00	ft	3481FB	\$20.16	ea
2555D	\$18.36	ft	2815CM	\$6.72	ft	3151SSR	\$20.00	ft	3481FIR/Q80	\$270.00	ea @
2555x253A	\$29.16	ft	2815DM	\$7.68	ft	3185AV	\$4.08	ft	3481FIR/Q84	\$270.00	ea @
2555x253AFG	\$23.88	ft	2815GM	\$8.64	ft	3185AV36	\$12.24	ea	3481FIR/Q96	\$280.00	ea @
2565A	\$16.56	ft	2815MAG	\$3.24	ft	3185AV48	\$16.32	ea	3481OAK/Q80	\$230.00	ea @
2565D	\$23.76	ft	2891APK	\$7.20	ft	3185DV	\$5.88	ft	3481OAK/Q84	\$230.00	ea @
2604A36	\$4.20	ea !	2891AS	\$7.80	ft	3185DV36	\$17.64	ea	3481OAK/Q96	\$240.00	ea @
2604A72	\$8.04	ea !	2891AV	\$6.72	ft	3185DV72	\$35.16	ea	3483FB	\$20.76	ea
2604G36	\$6.48	ea !	2891DPK	\$8.64	ft	3261A	\$2.64	ft	3483FIR84	\$160.00	ea @
2604G72	\$12.84	ea !	2891DS	\$9.48	ft	3261D	\$5.28	ft	3483FIR96	\$180.00	ea @
2604W36	\$8.04	ea !	2891DV	\$8.16	ft	3261G	\$5.88	ft	3483OAK84	\$150.00	ea @
2604W72	\$16.20	ea !	2891GPK	\$9.96	ft	3261SN	\$5.28	ft	3483OAK96	\$170.00	ea @
2705AT	\$18.00	ft	2891GS	\$10.56	ft	3443CS80	\$122.40	ea L, @	3493BDGS80	\$100.56	ea L, @
2705AKT	\$42.00	ft	2891GV	\$9.36	ft	3443CS84	\$128.52	ea L, @	3493BDGS96	\$120.84	ea L, @
2705DT	\$22.32	ft	2892AV	\$6.72	ft	3443CS96	\$146.88	ea L, @	3493BDGS120	\$181.08	ea L, @
2715A	\$17.64	ft	2892DV	\$8.16	ft	3443CS120	\$214.20	ea L, @	3493BDGV80	\$94.92	ea L, @
2715AK	\$41.64	ft	2893AV	\$6.72	ft	3443DS80	\$159.12	ea L, @	3493BDGV84	\$99.60	ea L, @
2715D	\$26.40	ft	2893DV	\$8.16	ft	3443DS84	\$166.32	ea L, @	3493BDGV96	\$113.64	ea L, @
2716A	\$27.60	ft	2897C96	\$14.40	ea !	3443DS96	\$185.64	ea L, @	3493BDGV120	\$170.40	ea L, @
2716AK	\$56.40	ft	2899C96	\$19.92	ea !	3443DS120	\$259.08	ea L, @	3493CS80	\$79.80	ea L, @
2716D	\$40.08	ft	2901C96	\$14.40	ea !	3443PWS80	\$133.68	ea L, @	3493CS84	\$83.88	ea L, @
2727A	\$15.60	ft	2902AV	\$5.16	ft	3443PWS84	\$140.76	ea L, @	3493CS96	\$95.76	ea L, @
2727D	\$20.76	ft	2902DV	\$6.48	ft	3443PWS96	\$161.16	ea L, @	3493CS120	\$143.64	ea L, @
2727G	\$23.40	ft	2902GV	\$7.32	ft	3443PWS120	\$240.72	ea L, @	3493CV80	\$73.92	ea L, @
2727SS	\$228.00	ft	2903AV	\$5.16	ft	3444CS80	\$135.48	ea @	3493CV84	\$77.52	ea L, @
2746A	\$11.40	ft	2903DV	\$6.48	ft	3444CS84	\$142.44	ea @	3493CV96	\$88.56	ea L, @
2746D	\$14.88	ft	2903GV	\$7.32	ft	3444CS96	\$162.72	ea @	3493CV120	\$132.96	ea L, @
2746G	\$17.04	ft	2905C96	\$18.12	ea !	3444CS120	\$244.08	ea @	3493DS80	\$92.76	ea L, @
2746x6A	\$31.08	ft	2909C96	\$24.48	ea !	3444DS80	\$160.44	ea @	3493DS84	\$97.44	ea L, @
2746x6AFG	\$26.40	ft	2913C96	\$16.56	ea !	3444DS84	\$168.72	ea @	3493DS96	\$111.12	ea L, @
2746x6D	\$38.16	ft	2917C96	\$34.80	ea !	3444DS96	\$192.72	ea @	3493DS120	\$166.80	ea L, @
2746x6DFG	\$30.96	ft	2925C96	\$50.76	ea !	3444DS120	\$288.96	ea @	3493DV80	\$86.88	ea L, @
2746x6G	\$42.48	ft	2929C96	\$65.88	ea !	3444PWS80	\$153.60	ea @	3493DV84	\$91.08	ea L, @
2746x6GFG	\$35.28	ft	2933C72	\$11.28	ea !	3444PWS84	\$161.16	ea @	3493DV96	\$104.04	ea L, @
2746x292AFGPK	\$24.84	ft	2933C96	\$15.24	ea !	3444PWS96	\$184.20	ea @	3493GS80	\$92.76	ea L, @
2746x292DFGPK	\$37.20	ft	2937C72	\$12.72	ea !	3444PWS120	\$276.12	ea @	3493GS84	\$97.44	ea L, @
2748A	\$19.08	ft	2937C96	\$17.04	ea !	3452APK	\$3.00	ft	3493GV80	\$86.88	ea L, @
2748D	\$25.20	ft	2945C96	\$10.92	ea !	3452AV	\$1.92	ft	3493GV96	\$104.04	ea L, @
2748G	\$28.44	ft	2949C96	\$14.88	ea !	3452BDGPK	\$4.80	ft	3493PWS80	\$88.92	ea L, @
2749A	\$21.96	ft	2953C96	\$21.48	ea !	3452BDGV	\$3.84	ft	3493PWS84	\$93.12	ea L, @

! = Only available in sizes shown. @ = Sizes ordered other than shown priced at the next available size. L = For an 18" long throw, add "L" to the end of the part number (i.e. 3493BDGS80L), add \$19.00 to the price (i.e. \$100.56 + \$19.00(L) = \$119.56).

Product Number	List Price	Per Unit	Product Number	List Price	Per Unit	Product Number	List Price	Per Unit	Product Number	List Price	Per Unit
3493PWS96	\$106.32	ea L, @	3494SNV96	\$146.88	ea @	3496DQ96	\$146.04	ea @	3572SP80	\$172.00	ea \$
3493PWW80	\$82.92	ea L, @	3494SNV120	\$216.24	ea @	3496DQ120	\$219.00	ea @	3572SP84	\$172.00	ea \$
3493PWW84	\$87.00	ea L, @	3495BDGM80	\$109.56	ea L, @	3496PWM80	\$122.64	ea @	3572SP96	\$197.00	ea \$
3493PWW96	\$99.36	ea L, @	3495BDGM96	\$131.64	ea L, @	3496PWM96	\$147.24	ea @	3572SP120	\$246.00	ea \$
3493SNS80	\$96.84	ea L, @	3495BDGQ80	\$109.44	ea L, @	3496PWQ80	\$118.68	ea @	3572SP-ND80	\$152.00	ea \$
3493SNS84	\$101.52	ea L, @	3495BDGQ84	\$115.20	ea L, @	3496PWQ84	\$124.56	ea @	3572SP-ND84	\$152.00	ea \$
3493SNS96	\$116.04	ea L, @	3495BDGQ96	\$131.52	ea L, @	3496PWQ96	\$142.44	ea @	3572SP-ND96	\$172.00	ea \$
3493SNS120	\$173.88	ea L, @	3495BDGQ120	\$197.04	ea L, @	3496PWQ120	\$213.72	ea @	3572SP-ND120	\$215.00	ea \$
3493SNV80	\$90.84	ea L, @	3495CM80	\$86.88	ea L, @	3496SNQ80	\$129.72	ea @	3572SS84	\$343.00	ea \$
3493SNV84	\$95.40	ea L, @	3495CM84	\$91.08	ea L, @	3496SNQ96	\$155.52	ea @	3572SS96	\$392.00	ea \$
3493SNV96	\$108.84	ea L, @	3495CM96	\$104.04	ea L, @	3497BDGM80	\$131.76	ea L, @	3572SS-ND84	\$258.00	ea \$
3493SNV120	\$163.32	ea L, @	3495CQ80	\$82.92	ea L, @	3497BDGQ80	\$127.20	ea L, @	3572SS-ND96	\$294.00	ea \$
3494BDGS80	\$130.56	ea @	3495CQ84	\$87.00	ea L, @	3497BDGQ84	\$133.92	ea L, @	3692APK773BL36	\$16.32	ea !
3494BDGS84	\$137.52	ea @	3495CQ96	\$99.36	ea L, @	3497BDGQ96	\$152.76	ea L, @	3692APK773BL49	\$21.72	ea !
3494BDGS96	\$156.84	ea @	3495DM80	\$101.64	ea L, @	3497CQ80	\$98.64	ea L, @	3692APK773GR36	\$16.32	ea !
3494BDGV80	\$118.68	ea @	3495DM84	\$106.68	ea L, @	3497CQ84	\$103.68	ea L, @	5110BL120	\$19.44	ea
3494BDGV84	\$124.56	ea @	3495DM96	\$122.04	ea L, @	3497CQ96	\$118.32	ea L, @	8451AQ	\$10.32	ft
3494BDGV96	\$142.44	ea @	3495DQ80	\$97.68	ea L, @	3497DM96	\$141.12	ea L, @	8451BDGQ	\$16.08	ft
3494BDGV120	\$213.72	ea @	3495DQ84	\$102.72	ea L, @	3497DQ80	\$113.64	ea L, @	8451DQ	\$14.04	ft
3494CS80	\$112.20	ea @	3495DQ96	\$117.24	ea L, @	3497DQ84	\$119.40	ea L, @	8451SNQ	\$16.08	ft
3494CS84	\$118.32	ea @	3495DQ120	\$175.92	ea L, @	3497DQ96	\$136.32	ea L, @	8452AQ	\$11.16	ft
3494CS96	\$134.64	ea @	3495GM80	\$101.64	ea L, @	3497DQ120	\$204.48	ea L, @	8452DQ	\$16.92	ft
3494CS120	\$184.92	ea @	3495GM96	\$122.04	ea L, @	3497PWM84	\$120.60	ea L, @	8452SNQ	\$19.20	ft
3494CV80	\$106.08	ea @	3495PWM80	\$98.64	ea L, @	3497PWQ80	\$110.76	ea L, @	19125A	\$11.88	ft
3494CV84	\$112.20	ea @	3495PWM96	\$118.32	ea L, @	3497PWQ84	\$116.28	ea L, @	19125AK	\$26.28	ft
3494CV96	\$128.52	ea @	3495PWQ80	\$94.92	ea L, @	3497PWQ96	\$132.96	ea L, @	19125D	\$16.92	ft
3494CV120	\$193.80	ea @	3495PWQ84	\$99.60	ea L, @	3498BDGQ80	\$154.20	ea @	19125G	\$18.96	ft
3494DS80	\$132.60	ea @	3495PWQ96	\$113.64	ea L, @	3498BDGQ84	\$161.64	ea @	19325A	\$22.32	ft
3494DS84	\$138.72	ea @	3495PWQ120	\$170.40	ea L, @	3498BDGQ96	\$184.92	ea @	19325D	\$28.44	ft
3494DS96	\$153.00	ea @	3495SNQ80	\$105.60	ea L, @	3498BDGQ120	\$277.32	ea @	19325G	\$32.04	ft
3494DS120	\$222.36	ea @	3495SNQ84	\$111.00	ea L, @	3498CQ80	\$122.64	ea @	29310CP	\$5.52	ft
3494DV80	\$126.48	ea @	3495SNQ96	\$126.84	ea L, @	3498CQ84	\$128.76	ea @	29310CPK	\$6.00	ft
3494DV84	\$132.60	ea @	3495SNQ120	\$190.20	ea L, @	3498CQ96	\$147.24	ea @	29310CS	\$6.72	ft
3494DV96	\$146.88	ea @	3496BDGM80	\$140.88	ea @	3498CQ120	\$220.80	ea @	29310CV	\$5.40	ft
3494DV120	\$216.24	ea @	3496BDGM96	\$168.96	ea @	3498DM84	\$148.68	ea @	29310DP	\$8.16	ft
3494GV80	\$126.48	ea @	3496BDGQ80	\$136.44	ea @	3498DQ80	\$137.76	ea @	29310DPK	\$8.52	ft
3494GV84	\$132.60	ea @	3496BDGQ84	\$143.04	ea @	3498DQ84	\$144.48	ea @	29310DS	\$9.36	ft
3494GV96	\$146.88	ea @	3496BDGQ96	\$163.68	ea @	3498DQ96	\$165.00	ea @	29310DV	\$8.16	ft
3494PWS80	\$126.48	ea @	3496CM80	\$110.76	ea @	3498DQ120	\$247.68	ea @	29310GP	\$8.16	ft
3494PWS84	\$132.60	ea @	3496CM84	\$116.28	ea @	3498PWM80	\$138.60	ea @	29310GPK	\$8.52	ft
3494PWS96	\$146.88	ea @	3496CM96	\$132.96	ea @	3498PWM84	\$145.68	ea @	29310GS	\$9.36	ft
3494PWS120	\$216.24	ea @	3496CQ80	\$106.56	ea @	3498PWM96	\$166.32	ea @	29310GV	\$8.16	ft
3494PWW80	\$112.20	ea @	3496CQ84	\$111.96	ea @	3498PWM120	\$249.36	ea @	29313CTF	\$4.20	ft
3494PWW84	\$118.32	ea @	3496CQ96	\$128.04	ea @	3498PWQ80	\$134.64	ea @	29313DTF	\$5.16	ft
3494PWW96	\$134.64	ea @	3496CQ120	\$192.24	ea @	3498PWQ84	\$141.24	ea @	29313PWTF	\$7.68	ft
3494PWW120	\$206.04	ea @	3496DM80	\$125.88	ea @	3498PWQ96	\$161.40	ea @	29314C	\$4.20	ft
3494SNS80	\$126.48	ea @	3496DM84	\$131.88	ea @	3498PWQ120	\$242.40	ea @	29314D	\$5.16	ft
3494SNS84	\$132.60	ea @	3496DM96	\$150.84	ea @	3572PP7-84	\$213.24	ea \$	29321CTF	\$4.20	ft
3494SNS96	\$146.88	ea @	3496DM120	\$226.20	ea @	3572PP7-96	\$244.80	ea \$	29321DTF	\$5.16	ft
3494SNV80	\$120.36	ea @	3496DQ80	\$121.80	ea @	3572PP7-ND84	\$192.00	ea \$	29326CV	\$17.64	ft
3494SNV84	\$126.48	ea @	3496DQ84	\$127.68	ea @	3572PP7-ND96	\$224.00	ea \$	45050DV	\$7.56	ft

! Only available in sizes shown. @ = Sizes ordered other than shown priced at the next available size. L = For an 18" long throw, add "L" to the end of the part number (i.e. 3493BDGS80L), add \$19.00 to the price (i.e. \$100.56 + \$19.00(L) = \$119.56). \$ = Sizes ordered other than shown priced at the next larger size + \$6.00 each list.

Product Number	List Price	Per Unit	Product Number	List Price	Per Unit	Product Number	List Price	Per Unit	Product Number	List Price	Per Unit
45100CV	\$4.32	ft	75518A73.75	\$71.28	ea@	94518A98	\$115.80	eaNT,@	95518BDG36.5	\$62.52	eaNT,@
74518A32.5	\$31.92	ea@	75518A73.75SYN	\$84.36	ea@	94518A120	\$261.84	eaNT,@	95518BDG73.75	\$125.04	eaNT,@
74518A36.5	\$32.64	ea@	75518A98	\$106.68	ea@	94518AW32.5	\$40.80	eaNT,@	95518BDG98	\$185.52	eaNT,@
74518A36.5SYN	\$39.12	ea@	75518BDG32.5	\$52.92	ea@	94518AW36.5	\$41.28	eaNT,@	95518BDG120	\$290.64	eaNT,@
74518A64	\$58.80	ea@	75518BDG36.5	\$54.12	ea@	94518AW36.5SYN	\$50.52	eaNT,@	95518BDGW32.5	\$59.52	eaNT,@
74518A73.75	\$65.16	ea@	75518BDG36.5SYN	\$54.24	ea@	94518AW73.75	\$82.56	eaNT,@	OS95518BDGW32.5	\$65.76	ea@
74518A73.75SYN	\$78.12	ea@	75518BDG64	\$97.20	ea@	94518AW73.75SYN	\$101.04	eaNT,@	95518BDGW36.5	\$60.12	eaNT,@
74518A98	\$97.80	ea@	75518BDG73.75	\$108.12	ea@	94518AW98	\$121.92	eaNT,@	OS95518BDGW36.5	\$66.48	ea@
74518A120	\$143.64	ea@	75518BDG96	\$154.44	ea@	94518BDG32.5	\$58.56	eaNT,@	95518BDGW73.75	\$120.36	eaNT,@
74518BDG32.5	\$47.88	ea@	75518BDG120	\$189.12	ea@	94518BDG36.5	\$59.04	eaNT,@	OS95518BDGW73.75	\$132.72	ea@
74518BDG36.5	\$48.84	ea@	75518D32.5	\$47.16	ea@	94518BDG73.75	\$117.84	eaNT,@	95518BDGW98	\$178.08	eaNT,@
74518BDG36.5SYN	\$58.32	ea@	75518D36.5	\$48.24	ea@	94518BDG96	\$185.88	eaNT,@	95518D32.5	\$54.00	eaNT,@
74518BDG64	\$87.48	ea@	75518D36.5SYN	\$57.12	ea@	94518BDG120	\$261.96	eaNT,@	95518D36.5	\$54.60	eaNT,@
74518BDG73.75	\$97.20	ea@	75518D64	\$86.64	ea@	94518BDGW32.5	\$56.28	eaNT,@	95518D73.75	\$109.08	eaNT,@
74518BDG120	\$166.32	ea@	75518D73.75	\$96.24	ea@	94518BDGW36.5	\$57.00	eaNT,@	95518D98	\$161.64	eaNT,@
74518D32.5	\$42.60	ea@	75518D73.75SYN	\$114.24	ea@	94518BDGW73.75	\$113.64	eaNT,@	95518D120	\$255.00	eaNT,@
74518D36.5	\$43.44	ea@	75518D98	\$144.24	ea@	94518BDGW96	\$179.16	eaNT,@	95518DW32.5	\$52.08	eaNT,@
74518D36.5SYN	\$50.04	ea@	75518D120	\$176.76	ea@	94518D32.5	\$52.08	eaNT,@	OS95518DW32.5	\$58.68	ea@
74518D64	\$78.00	ea@	75518SN32.5	\$50.52	ea@	94518D36.5	\$52.80	eaNT,@	95518DW36.5	\$52.92	eaNT,@
74518D73.75	\$86.64	ea@	75518SN36.5	\$51.48	ea@	94518D73.75	\$105.12	eaNT,@	95518DW73.75	\$105.36	eaNT,@
74518A36.5SYN	\$39.12	ea@	75518SN64	\$92.64	ea@	94518D98	\$156.12	eaNT,@	95518DW73.75SYN	\$130.20	eaNT,@
74518A64	\$58.80	ea@	75518SN73.75	\$103.08	ea@	94518D120	\$244.56	eaNT,@	OS95518DW73.75	\$118.32	ea@
74518A73.75	\$65.16	ea@	75518SN98	\$154.32	ea@	94518DW32.5	\$50.28	eaNT,@	95518DW98	\$156.12	eaNT,@
74518A73.75SYN	\$78.12	ea@	75518SN120	\$226.92	ea@	94518DW36.5	\$50.88	eaNT,@	OS95518DW96	\$191.76	ea@
74518A98	\$97.80	ea@	84514A	\$7.08	ft	94518DW73.75	\$101.40	eaNT,@	95518DW108	\$215.64	eaNT,@
74518A120	\$143.64	ea@	84514BDG	\$10.92	ft	94518DW98	\$150.48	eaNT,@	95518DW120	\$224.52	eaNT,@
74518BDG32.5	\$47.88	ea@	84514D	\$9.84	ft	94518DW120	\$235.68	eaNT,@	95518SN32.5	\$61.92	eaNT,@
74518BDG36.5	\$48.84	ea@	84514SN	\$10.44	ft	94518SN32.5	\$54.36	eaNT,@	95518SN36.5	\$62.52	eaNT,@
74518BDG36.5SYN	\$58.32	ea@	N84518AV	\$10.92	ft	94518SN36.5	\$54.96	eaNT,@	95518SN73.75	\$125.04	eaNT,@
74518BDG64	\$87.48	ea@	N84518BDGV	\$14.88	ft	94518SN73.75	\$109.92	eaNT,@	95518SN98	\$185.52	eaNT,@
74518BDG73.75	\$97.20	ea@	N84518DV	\$13.32	ft	94518SN98	\$162.84	eaNT,@	95518SNW32.5	\$59.52	eaNT,@
74518BDG120	\$166.32	ea@	N84518SNV	\$14.16	ft	94518SN120	\$261.96	eaNT,@	95518SNW36.5	\$60.12	eaNT,@
74518D32.5	\$42.60	ea@	85514A	\$7.92	ft	94518SNW32.5	\$51.96	eaNT,@	95518SNW73.75	\$120.36	eaNT,@
74518D36.5	\$43.44	ea@	85514BDG	\$12.60	ft	94518SNW36.5	\$52.44	eaNT,@	95518SNW98	\$178.08	eaNT,@
74518D36.5SYN	\$50.04	ea@	85514D	\$11.16	ft	94518SNW73.75	\$104.88	eaNT,@	OS95518AW32.5	\$44.76	ea@
74518D64	\$78.00	ea@	85514SN	\$12.12	ft	94518SNW98	\$155.64	eaNT,@	OS95518AW36.5	\$45.24	ea@
74518D73.75	\$86.64	ea@	N85518AV	\$11.88	ft	95518A32.5	\$40.80	eaNT,@	OS95518AW73.75	\$90.48	ea@
74518D73.75SYN	\$88.32	ea@	N85518BDGV	\$15.24	ft	95518A36.5	\$41.28	eaNT,@	OS95518BDGW32.5	\$65.76	ea@
74518D98	\$129.84	ea@	N85518DV	\$13.32	ft	95518A73.75	\$82.56	eaNT,@	OS95518BDGW36.5	\$66.48	ea@
74518D120	\$159.12	ea@	93518AW32.5	\$36.60	ea@	95518A98	\$121.92	eaNT,@	OS95518BDGW73.75	\$132.72	ea@
74518SN32.5	\$45.24	ea@	93518AW36.5	\$37.08	ea@	95518A120	\$191.28	eaNT,@	OS95518DW32.5	\$58.68	ea@
74518SN36.5	\$46.20	ea@	93518AW36.5SYN	\$46.20	ea@	95518AW32.5	\$42.96	eaNT,@	OS95518DW36.5	\$59.28	ea@
74518SN36.5SYN	\$52.80	ea@	93518AW73.75	\$74.04	ea@	OS95518AW32.5	\$44.76	ea@	OS95518DW73.75	\$118.32	ea@
74518SN64	\$83.40	ea@	93518AW108	\$138.72	ea@	95518AW36.5	\$43.32	eaNT,@			
74518SN73.75	\$92.40	ea@	93518DW32.5	\$47.88	ea@	OS95518AW36.5	\$45.24	ea@			
74518SN98	\$138.48	ea@	93518DW36.5	\$48.48	ea@	95518AW73.75	\$86.64	eaNT,@			
74518SN120	\$204.00	ea@	93518DW73.75	\$96.96	ea@	OS95518AW73.75	\$90.48	eaNT,@			
75518A32.5	\$35.04	ea@	93518DW97	\$135.96	ea@	95518AW98	\$128.52	eaNT,@			
75518A36.5	\$35.64	ea@	94518A32.5	\$38.64	eaNT,@	OS95518AW96	\$148.92	eaNT,@			
75518A36.5SYN	\$42.24	ea@	94518A36.5	\$39.12	eaNT,@	95518AW108	\$164.28	eaNT,@			
75518A64	\$64.20	ea@	94518A73.75	\$78.24	eaNT,@	95518BDG32.5	\$61.92	eaNT,@			

@ = Sizes ordered other than shown priced at the next available size. NT = oak wood trim (currently 7/16" x 1-1/8") is now available at 3/16" x 1-1/8" - Narrow Trim. Add "NT" to the end of the part number (i.e. 94518A32.5NT); price is the same.

Product Number	Description	List Price	Per Unit	Product Number	Description	List Price	Per Unit
AM44BL17	Antimicrobial Silicone Gasket	\$89.25	ea	AM88D21	Antimicrobial Silicone Gasket	\$110.25	ea
AM44BL18	Antimicrobial Silicone Gasket	\$94.50	ea	AM88D25	Antimicrobial Silicone Gasket	\$131.25	ea
AM44BL20	Antimicrobial Silicone Gasket	\$105.00	ea	AM88D30	Antimicrobial Silicone Gasket	\$157.50	ea
AM44BL204	Antimicrobial Silicone Gasket	\$1,038.00	ea	AM88D510	Antimicrobial Silicone Gasket	\$2,550.00	ea
AM44BL21	Antimicrobial Silicone Gasket	\$110.25	ea	AM88GR17	Antimicrobial Silicone Gasket	\$89.25	ea
AM44BL25	Antimicrobial Silicone Gasket	\$131.25	ea	AM88GR18	Antimicrobial Silicone Gasket	\$94.50	ea
AM44BL30	Antimicrobial Silicone Gasket	\$157.50	ea	AM88GR20	Antimicrobial Silicone Gasket	\$105.00	ea
AM44BL510	Antimicrobial Silicone Gasket	\$2,550.00	ea	AM88GR204	Antimicrobial Silicone Gasket	\$1,038.00	ea
AM44C17	Antimicrobial S44 Gasket, Clear	\$102.00	ea	AM88GR21	Antimicrobial Silicone Gasket	\$110.25	ea
AM44C18	Antimicrobial S44 Gasket, Clear	\$108.00	ea	AM88GR25	Antimicrobial Silicone Gasket	\$131.25	ea
AM44C20	Antimicrobial S44 Gasket, Clear	\$120.00	ea	AM88GR30	Antimicrobial Silicone Gasket	\$157.50	ea
AM44C204	Antimicrobial S44 Gasket, Clear	\$1,188.00	ea	AM88GR510	Antimicrobial Silicone Gasket	\$2,550.00	ea
AM44C21	Antimicrobial S44 Gasket, Clear	\$126.00	ea	AM88W17	Antimicrobial Silicone Gasket	\$89.25	ea
AM44C25	Antimicrobial S44 Gasket, Clear	\$150.00	ea	AM88W18	Antimicrobial Silicone Gasket	\$94.50	ea
AM44C30	Antimicrobial S44 Gasket, Clear	\$180.00	ea	AM88W20	Antimicrobial Silicone Gasket	\$105.00	ea
AM44C510	Antimicrobial S44 Gasket, Clear	\$2,910.00	ea	AM88W204	Antimicrobial Silicone Gasket	\$1,038.00	ea
AM44D17	Antimicrobial Silicone Gasket	\$89.25	ea	AM88W21	Antimicrobial Silicone Gasket	\$110.25	ea
AM44D18	Antimicrobial Silicone Gasket	\$94.50	ea	AM88W25	Antimicrobial Silicone Gasket	\$131.25	ea
AM44D20	Antimicrobial Silicone Gasket	\$105.00	ea	AM88W30	Antimicrobial Silicone Gasket	\$157.50	ea
AM44D204	Antimicrobial Silicone Gasket	\$1,038.00	ea	AM88W510	Antimicrobial Silicone Gasket	\$2,550.00	ea
AM44D21	Antimicrobial Silicone Gasket	\$110.25	ea	FG3000S45-7	Glazing Tape, 45 Minute, 7 feet	\$14.90	ea !
AM44D25	Antimicrobial Silicone Gasket	\$131.25	ea	FG3000S45-8	Glazing Tape, 45 Minute, 8 feet	\$17.00	ea !
AM44D30	Antimicrobial Silicone Gasket	\$157.50	ea	FG3000S45-14	Glazing Tape, 45 Minute, 14 feet	\$28.70	ea !
AM44D510	Antimicrobial Silicone Gasket	\$2,550.00	ea	FG3000S45-16	Glazing Tape, 45 Minute, 16 feet	\$33.00	ea !
AM44W17	Antimicrobial Silicone Gasket	\$89.25	ea	FG3000S90-8	Glazing Tape, 90 Minute, 8 feet	\$29.80	ea !
AM44W18	Antimicrobial Silicone Gasket	\$94.50	ea	FG3000S90-16	Glazing Tape, 90 Minute, 16 feet	\$58.50	ea !
AM44W20	Antimicrobial Silicone Gasket	\$105.00	ea	FGL3000-8	Glazing Liner, 1 pc @ 8 feet	\$74.90	ea !
AM44W204	Antimicrobial Silicone Gasket	\$1,038.00	ea	FGL4000-8	Glazing Liner, 45 minute, 8 feet	\$128.00	ea !
AM44W21	Antimicrobial Silicone Gasket	\$110.25	ea	FGL5000-20	Glazing Liner, 20 pcs @ 1 foot	\$74.70	ea !
AM44W25	Antimicrobial Silicone Gasket	\$131.25	ea	FGL5000-50	Glazing Liner, 50 pcs @ 1 foot	\$174.40	ea !
AM44W30	Antimicrobial Silicone Gasket	\$157.50	ea	HSS1000-7	Intumescent Seal, Mortised, 7ft, Graphite	\$14.10	ea !
AM44W510	Antimicrobial Silicone Gasket	\$2,550.00	ea	HSS1000-8	Intumescent Seal, Mortised, 8ft, Graphite	\$16.20	ea !
AM88BL17	Antimicrobial Silicone Gasket	\$89.25	ea	HSS1000-10	Intumescent Seal, Mortised, 10ft, Graphite	\$20.20	ea !
AM88BL18	Antimicrobial Silicone Gasket	\$94.50	ea	HSS1000-18	Intumescent Seal, Mortised, 18ft, Graphite	\$36.40	ea !
AM88BL20	Antimicrobial Silicone Gasket	\$105.00	ea	HSS1000-21	Intumescent Seal, Mortised, 21ft, Graphite	\$42.50	ea !
AM88BL204	Antimicrobial Silicone Gasket	\$1,038.00	ea	HSS1000-24	Intumescent Seal, Mortised, 24ft, Graphite	\$48.50	ea !
AM88BL21	Antimicrobial Silicone Gasket	\$110.25	ea	HSS1000W-7	Intumescent Seal, Mortised, 7ft, White	\$14.90	ea !
AM88BL25	Antimicrobial Silicone Gasket	\$131.25	ea	HSS1000W-8	Intumescent Seal, Mortised, 8ft, White	\$17.00	ea !
AM88BL30	Antimicrobial Silicone Gasket	\$157.50	ea	HSS1000W-18	Intumescent Seal, Mortised, 18ft, White	\$38.30	ea !
AM88BL510	Antimicrobial Silicone Gasket	\$2,550.00	ea	HSS1000W-21	Intumescent Seal, Mortised, 21ft, White	\$44.70	ea !
AM88C17	Antimicrobial S88 Gasket, Clear	\$102.00	ea	HSS1000W-24	Intumescent Seal, Mortised, 24ft, White	\$51.10	ea !
AM88C18	Antimicrobial S88 Gasket, Clear	\$108.00	ea	HSS2000-7	Intumescent Seal, Adhesive, 7ft, Graphite	\$11.60	ea !
AM88C20	Antimicrobial S88 Gasket, Clear	\$120.00	ea	HSS2000-8	Intumescent Seal, Adhesive, 8ft, Graphite	\$13.20	ea !
AM88C204	Antimicrobial S88 Gasket, Clear	\$1,188.00	ea	HSS2000-10	Intumescent Seal, Adhesive, 10ft, Graphite	\$16.50	ea !
AM88C21	Antimicrobial S88 Gasket, Clear	\$126.00	ea	HSS2000-18	Intumescent Seal, Adhesive, 18ft, Graphite	\$29.70	ea !
AM88C25	Antimicrobial S88 Gasket, Clear	\$150.00	ea	HSS2000-21	Intumescent Seal, Adhesive, 21ft, Graphite	\$34.70	ea !
AM88C30	Antimicrobial S88 Gasket, Clear	\$180.00	ea	HSS2000-24	Intumescent Seal, Adhesive, 24ft, Graphite	\$39.60	ea !
AM88C510	Antimicrobial S88 Gasket, Clear	\$2,910.00	ea	HSS2000W-7	Intumescent Seal, Adhesive, 7ft, White	\$11.90	ea !
AM88D17	Antimicrobial Silicone Gasket	\$89.25	ea	HSS2000W-8	Intumescent Seal, Adhesive, 8ft, White	\$13.60	ea !
AM88D18	Antimicrobial Silicone Gasket	\$94.50	ea	HSS2000W-10	Intumescent Seal, Adhesive, 10ft, White	\$17.00	ea !
AM88D20	Antimicrobial Silicone Gasket	\$105.00	ea	HSS2000W-18	Intumescent Seal, Adhesive, 18', White	\$30.60	ea !
AM88D204	Antimicrobial Silicone Gasket	\$1,038.00	ea	HSS2000W-21	Intumescent Seal, Adhesive, 21', White	\$35.70	ea !

! = Only available in sizes shown.

Product Number	Description	List Price	Per Unit	Product Number	Description	List Price	Per Unit
HSS2000V-24	Intumescent Seal, Adhesive, 24', White	\$40.90	ea	HSS2000xS88C7284	HSS x S88 Clear, 1 @ 74" x 2 @ 86"	\$94.10	ea
HSS2000xS44BL3684	HSS x S44 Black, 1 @ 38" x 2 @ 86"	\$69.50	ea	HSS2000xS88C7296	HSS x S88 Clear, 1 @ 74" x 2 @ 98"	\$103.50	ea
HSS2000xS44BL3696	HSS x S44 Black, 1 @ 38" x 2 @ 98"	\$77.70	ea	HSS2000xS88C8484	HSS x S88 Clear, 3 @ 86"	\$98.80	ea
HSS2000xS44BL4884	HSS x S44 Black, 1 @ 50" x 2 @ 86"	\$73.60	ea	HSS2000xS88C9696	HSS x S88 Clear, 3 @ 98"	\$112.90	ea
HSS2000xS44BL4896	HSS x S44 Black, 1 @ 50" x 2 @ 98"	\$81.70	ea	HSS2000xS88C120120	HSS x S88 Clear, 3 @ 122"	\$141.20	ea
HSS2000xS44BL7284	HSS x S44 Black, 1 @ 74" x 2 @ 86"	\$81.70	ea	HSS2000xS88D3684	HSS x S88 Dark, 1 @ 38" x 2 @ 86"	\$70.50	ea
HSS2000xS44BL7296	HSS x S44 Black, 1 @ 74" x 2 @ 98"	\$89.90	ea	HSS2000xS88D3696	HSS x S88 Dark, 1 @ 38" x 2 @ 98"	\$78.80	ea
HSS2000xS44BL8484	HSS x S44 Black, 3 @ 86"	\$85.80	ea	HSS2000xS88D4884	HSS x S88 Dark, 1 @ 50" x 2 @ 86"	\$74.68	ea
HSS2000xS44BL9696	HSS x S44 Black, 3 @ 98"	\$98.10	ea	HSS2000xS88D4896	HSS x S88 Dark, 1 @ 50" x 2 @ 98"	\$83.00	ea
HSS2000xS44BL120120	HSS x S44 Black, 3 @ 122"	\$122.60	ea	HSS2000xS88D7284	HSS x S88 Dark, 1 @ 74" x 2 @ 86"	\$83.00	ea
HSS2000xS44D3684	HSS x S44 Dark, 1 @ 38" x 2 @ 86"	\$69.50	ea	HSS2000xS88D7296	HSS x S88 Dark, 1 @ 74" x 2 @ 98"	\$91.30	ea
HSS2000xS44D3696	HSS x S44 Dark, 1 @ 38" x 2 @ 98"	\$77.70	ea	HSS2000xS88D8484	HSS x S88 Dark, 3 @ 86"	\$87.10	ea
HSS2000xS44D4884	HSS x S44 Dark, 1 @ 50" x 2 @ 86"	\$73.60	ea	HSS2000xS88D9696	HSS x S88 Dark, 3 @ 98"	\$99.60	ea
HSS2000xS44D4896	HSS x S44 Dark, 1 @ 50" x 2 @ 98"	\$81.70	ea	HSS2000xS88D120120	HSS x S88 Dark, 3 @ 122"	\$124.50	ea
HSS2000xS44D7284	HSS x S44 Dark, 1 @ 74" x 2 @ 86"	\$81.70	ea	HSS2000xS88GR3684	HSS x S88 Grey, 1 @ 38" x 2 @ 86"	\$70.50	ea
HSS2000xS44D7296	HSS x S44 Dark, 1 @ 74" x 2 @ 98"	\$89.90	ea	HSS2000xS88GR3696	HSS x S88 Grey, 1 @ 38" x 2 @ 98"	\$78.80	ea
HSS2000xS44D8484	HSS x S44 Dark, 3 @ 86"	\$85.80	ea	HSS2000xS88GR4884	HSS x S88 Grey, 1 @ 50" x 2 @ 86"	\$74.70	ea
HSS2000xS44D9696	HSS x S44 Dark, 3 @ 98"	\$98.10	ea	HSS2000xS88GR4896	HSS x S88 Grey, 1 @ 50" x 2 @ 98"	\$83.00	ea
HSS2000xS44D120120	HSS x S44 Dark, 3 @ 122"	\$122.60	ea	HSS2000xS88GR7284	HSS x S88 Grey, 1 @ 74" x 2 @ 86"	\$83.00	ea
HSS2000xS44GR3684	HSS x S44 Grey, 1 @ 38" x 2 @ 86"	\$69.50	ea	HSS2000xS88GR7296	HSS x S88 Grey, 1 @ 74" x 2 @ 98"	\$91.30	ea
HSS2000xS44GR3696	HSS x S44 Grey, 1 @ 38" x 2 @ 98"	\$77.70	ea	HSS2000xS88GR8484	HSS x S88 Grey, 3 @ 86"	\$87.10	ea
HSS2000xS44GR4884	HSS x S44 Grey, 1 @ 50" x 2 @ 86"	\$73.60	ea	HSS2000xS88GR9696	HSS x S88 Grey, 3 @ 98"	\$99.60	ea
HSS2000xS44GR4896	HSS x S44 Grey, 1 @ 50" x 2 @ 98"	\$81.70	ea	HSS2000xS88GR120120	HSS x S88 Grey, 3 @ 122"	\$124.50	ea
HSS2000xS44GR7284	HSS x S44 Grey, 1 @ 74" x 2 @ 86"	\$81.70	ea	HSS2000xS88TAN3684	HSS x S88 Tan, 1 @ 38" x 2 @ 86"	\$70.50	ea
HSS2000xS44GR7296	HSS x S44 Grey, 1 @ 74" x 2 @ 98"	\$89.90	ea	HSS2000xS88TAN3696	HSS x S88 Tan, 1 @ 38" x 2 @ 98"	\$78.80	ea
HSS2000xS44GR8484	HSS x S44 Grey, 3 @ 86"	\$85.80	ea	HSS2000xS88TAN4884	HSS x S88 Tan, 1 @ 50" x 2 @ 86"	\$74.70	ea
HSS2000xS44GR9696	HSS x S44 Grey, 3 @ 98"	\$98.10	ea	HSS2000xS88TAN4896	HSS x S88 Tan, 1 @ 50" x 2 @ 98"	\$83.00	ea
HSS2000xS44GR120120	HSS x S44 Grey, 3 @ 122"	\$122.60	ea	HSS2000xS88TAN7284	HSS x S88 Tan, 1 @ 74" x 2 @ 86"	\$83.00	ea
HSS2000xS44V3684	HSS x S44 White, 1 @ 38" x 2 @ 86"	\$69.50	ea	HSS2000xS88TAN7296	HSS x S88 Tan, 1 @ 74" x 2 @ 98"	\$91.30	ea
HSS2000xS44V3696	HSS x S44 White, 1 @ 38" x 2 @ 98"	\$77.70	ea	HSS2000xS88TAN8484	HSS x S88 Tan, 3 @ 86"	\$87.10	ea
HSS2000xS44V4884	HSS x S44 White, 1 @ 50" x 2 @ 86"	\$73.60	ea	HSS2000xS88TAN9696	HSS x S88 Tan, 3 @ 98"	\$99.60	ea
HSS2000xS44V4896	HSS x S44 White, 1 @ 50" x 2 @ 98"	\$81.70	ea	HSS2000xS88TAN120120	HSS x S88 Tan, 3 @ 122"	\$124.50	ea
HSS2000xS44V7284	HSS x S44 White, 1 @ 74" x 2 @ 86"	\$81.70	ea	HSS2000xS88W3684	HSS x S88 White, 1 @ 38" x 2 @ 86"	\$70.50	ea
HSS2000xS44V7296	HSS x S44 White, 1 @ 74" x 2 @ 98"	\$89.90	ea	HSS2000xS88W3696	HSS x S88 White, 1 @ 38" x 2 @ 98"	\$78.80	ea
HSS2000xS44V8484	HSS x S44 White, 3 @ 86"	\$85.80	ea	HSS2000xS88W4884	HSS x S88 White, 1 @ 50" x 2 @ 86"	\$74.70	ea
HSS2000xS44V9696	HSS x S44 White, 3 @ 98"	\$98.10	ea	HSS2000xS88W4896	HSS x S88 White, 1 @ 50" x 2 @ 98"	\$83.00	ea
HSS2000xS44W120120	HSS x S44 White, 3 @ 122"	\$122.60	ea	HSS2000xS88W7284	HSS x S88 White, 1 @ 74" x 2 @ 86"	\$83.00	ea
HSS2000xS88BL3684	HSS x S88 Black, 1 @ 38" x 2 @ 86"	\$70.50	ea	HSS2000xS88W7296	HSS x S88 White, 1 @ 74" x 2 @ 98"	\$91.30	ea
HSS2000xS88BL3696	HSS x S88 Black, 1 @ 38" x 2 @ 98"	\$78.80	ea	HSS2000xS88W8484	HSS x S88 White, 3 @ 86"	\$87.10	ea
HSS2000xS88BL4884	HSS x S88 Black, 1 @ 50" x 2 @ 86"	\$74.70	ea	HSS2000xS88W9696	HSS x S88 White, 3 @ 98"	\$99.60	ea
HSS2000xS88BL4896	HSS x S88 Black, 1 @ 50" x 2 @ 98"	\$83.00	ea	HSS2000xS88W120120	HSS x S88 White, 3 @ 122"	\$124.50	ea
HSS2000xS88BL7284	HSS x S88 Black, 1 @ 74" x 2 @ 86"	\$83.00	ea	P88BL17	Bulb Seal, Perforated, Black, 1/4", 17ft	\$32.30	ea
HSS2000xS88BL7296	HSS x S88 Black, 1 @ 74" x 2 @ 98"	\$91.30	ea	P88BL18	Bulb Seal, Perforated, Black, 1/4", 18ft	\$34.20	ea
HSS2000xS88BL8484	HSS x S88 Black, 3 @ 86"	\$87.10	ea	P88BL20	Bulb Seal, Perforated, Black, 1/4", 20ft	\$38.00	ea
HSS2000xS88BL9696	HSS x S88 Black, 3 @ 98"	\$99.60	ea	P88BL21	Bulb Seal, Perforated, Black, 1/4", 21ft	\$39.90	ea
HSS2000xS88BL120120	HSS x S88 Black, 3 @ 122"	\$124.50	ea	P88BL25	Bulb Seal, Perforated, Black, 1/4", 25ft	\$47.50	ea
HSS2000xS88C3684	HSS x S88 Clear, 1 @ 38" x 2 @ 86"	\$80.00	ea	P88BL30	Bulb Seal, Perforated, Black, 1/4", 30ft	\$57.00	ea
HSS2000xS88C3696	HSS x S88 Clear, 1 @ 38" x 2 @ 98"	\$89.40	ea	P88BL204	Bulb Seal, Perforated, Black, 1/4", 204ft	\$380.00	ea
HSS2000xS88C4884	HSS x S88 Clear, 1 @ 50" x 2 @ 86"	\$84.70	ea	P88BL510	Bulb Seal, Perforated, Black, 1/4", 510ft	\$940.00	ea
HSS2000xS88C4896	HSS x S88 Clear, 1 @ 50" x 2 @ 98"	\$94.10	ea	P88D17	Bulb Seal, Perforated, Dark, 1/4", 17ft	\$32.30	ea

! = Only available in sizes shown.

Product Number	Description	List Price	Per Unit	Product Number	Description	List Price	Per Unit
P88D18	Bulb Seal, Perforated, Dark, 1/4", 18ft	\$34.20	ea	PK55D18	Bulb Seal, 3/16", 18ft, Dark Brown	\$22.68	ea
P88D20	Bulb Seal, Perforated, Dark, 1/4", 20ft	\$38.00	ea	PK55D20	Bulb Seal, 3/16", 20ft, Dark Brown	\$24.80	ea
P88D21	Bulb Seal, Perforated, Dark, 1/4", 21ft	\$39.90	ea	PK55D21	Bulb Seal, 3/16", 21ft, Dark Brown	\$26.46	ea
P88D25	Bulb Seal, Perforated, Dark, 1/4", 25ft	\$47.50	ea	PK55D25	Bulb Seal, 3/16", 25ft, Dark Brown	\$31.50	ea
P88D30	Bulb Seal, Perforated, Dark, 1/4", 30ft	\$57.00	ea	PK55D30	Bulb Seal, 3/16", 30ft, Dark Brown	\$37.80	ea
P88D204	Bulb Seal, Perforated, Dark, 1/4", 204ft	\$380.00	ea	PK55D510	Bulb Seal, 3/16", 510ft, Dark Brown	\$610.00	ea
P88D510	Bulb Seal, Perforated, Dark, 1/4", 510ft	\$940.00	ea	PK55W17	Bulb Seal, 3/16", 17ft, White	\$21.00	ea
P88D510/2	Bulb Seal, Perforated, Dark, 1/4", 1020ft	\$1,880.00	ea	PK55W18	Bulb Seal, 3/16", 18ft, White	\$22.68	ea
P88GR17	Bulb Seal, Perforated, Gray, 1/4", 17ft	\$32.30	ea	PK55W20	Bulb Seal, 3/16", 20ft, White	\$24.80	ea
P88GR18	Bulb Seal, Perforated, Gray, 1/4", 18ft	\$34.20	ea	PK55W21	Bulb Seal, 3/16", 21ft, White	\$26.46	ea
P88GR20	Bulb Seal, Perforated, Gray, 1/4", 20ft	\$38.00	ea	PK55W25	Bulb Seal, 3/16", 25ft, White	\$31.50	ea
P88GR21	Bulb Seal, Perforated, Gray, 1/4", 21ft	\$39.90	ea	PK55W30	Bulb Seal, 3/16", 30ft, White	\$37.80	ea
P88GR25	Bulb Seal, Perforated, Gray, 1/4", 25ft	\$47.50	ea	PK55W204/S	Bulb Seal, 3/16", 204ft, White	\$270.00	ea
P88GR30	Bulb Seal, Perforated, Gray, 1/4", 30ft	\$57.00	ea	PK55W510	Bulb Seal, 3/16", 510ft, White	\$610.00	ea
P88GR204	Bulb Seal, Perforated, Gray, 1/4", 204ft	\$380.00	ea	PK55W510/S	Bulb Seal, 3/16", 510ft, White	\$650.00	ea
P88GR510	Bulb Seal, Perforated, Gray, 1/4", 510ft	\$940.00	ea	S1125D-7	Adhesive Silicone Astragal Seal	\$30.10	ea
P88W17	Bulb Seal, Perforated, White, 1/4", 17ft	\$32.30	ea	S1125D-8	Adhesive Silicone Astragal Seal	\$34.40	ea
P88W18	Bulb Seal, Perforated, White, 1/4", 18ft	\$34.20	ea	S1125D-510	Adhesive Silicone Astragal Seal	\$1,590.00	ea
P88W20	Bulb Seal, Perforated, White, 1/4", 20ft	\$38.00	ea	S44BL17	Single Fin "V" Seal, 17ft, Black	\$22.00	ea
P88W21	Bulb Seal, Perforated, White, 1/4", 21ft	\$39.90	ea	S44BL18	Single Fin "V" Seal, 18ft, Black	\$23.60	ea
P88W25	Bulb Seal, Perforated, White, 1/4", 25ft	\$47.50	ea	S44BL20	Single Fin "V" Seal, 20ft, Black	\$26.00	ea
P88W30	Bulb Seal, Perforated, White, 1/4", 30ft	\$57.00	ea	S44BL21	Single Fin "V" Seal, 21ft, Black	\$27.50	ea
P88W204	Bulb Seal, Perforated, White, 1/4", 204ft	\$380.00	ea	S44BL25	Single Fin "V" Seal, 25ft, Black	\$32.70	ea
P88W510	Bulb Seal, Perforated, White, 1/4", 510ft	\$940.00	ea	S44BL30	Single Fin "V" Seal, 30ft, Black	\$39.30	ea
PK33BL17	Bulb Seal, 3/8" 17ft, Black	\$21.00	ea	S44BL204	Single Fin "V" Seal, 204ft, Black	\$260.00	ea
PK33BL18	Bulb Seal, 3/8" 18ft, Black	\$22.68	ea	S44BL510	Single Fin "V" Seal, 510ft, Black	\$640.00	ea
PK33BL20	Bulb Seal, 3/8" 20ft, Black	\$24.80	ea	S44C17	Single Fin "V" Seal, 17ft, Clear	\$32.30	ea
PK33BL21	Bulb Seal, 3/8" 21ft, Black	\$26.46	ea	S44C18	Single Fin "V" Seal, 18ft, Clear	\$34.20	ea
PK33BL25	Bulb Seal, 3/8" 25ft, Black	\$31.50	ea	S44C20	Single Fin "V" Seal, 20ft, Clear	\$38.00	ea
PK33BL30	Bulb Seal, 3/8" 30ft, Black	\$37.80	ea	S44C21	Single Fin "V" Seal, 21ft, Clear	\$39.90	ea
PK33BL510	Bulb Seal, 3/8" 510ft, Black	\$610.00	ea	S44C25	Single Fin "V" Seal, 25ft, Clear	\$47.50	ea
PK33D17	Bulb Seal, 3/8", 17ft, Dark Brown	\$21.00	ea	S44C30	Single Fin "V" Seal, 30ft, Clear	\$57.00	ea
PK33D18	Bulb Seal, 3/8", 18ft, Dark Brown	\$22.68	ea	S44C204	Single Fin "V" Seal, 204ft, Clear	\$380.00	ea
PK33D20	Bulb Seal, 3/8", 20ft, Dark Brown	\$24.80	ea	S44C510	Single Fin "V" Seal, 510ft, Clear	\$935.00	ea
PK33D21	Bulb Seal, 3/8", 21ft, Dark Brown	\$26.46	ea	S44D100M	Single Fin "V" Seal, 100M, Dark Brown	\$418.00	ea
PK33D25	Bulb Seal, 3/8", 25ft, Dark Brown	\$31.50	ea	S44D17	Single Fin "V" Seal, 17ft, Dark Brown	\$22.00	ea
PK33D30	Bulb Seal, 3/8", 30ft, Dark Brown	\$37.80	ea	S44D18	Single Fin "V" Seal, 18ft, Dark Brown	\$23.60	ea
PK33D510	Bulb Seal, 3/8", 510ft, Dark Brown	\$610.00	ea	S44D20	Single Fin "V" Seal, 20ft, Dark Brown	\$26.00	ea
PK33W17	Bulb Seal, 3/8", 17ft, White	\$21.00	ea	S44D21	Single Fin "V" Seal, 21ft, Dark Brown	\$27.50	ea
PK33W18	Bulb Seal, 3/8", 18ft, White	\$22.68	ea	S44D25	Single Fin "V" Seal, 25ft, Dark Brown	\$32.70	ea
PK33W20	Bulb Seal, 3/8", 20ft, White	\$24.80	ea	S44D30	Single Fin "V" Seal, 30ft, Dark Brown	\$39.30	ea
PK33W21	Bulb Seal, 3/8", 21ft, White	\$26.46	ea	S44D204	Single Fin "V" Seal, 204ft, Dark Brown	\$260.00	ea
PK33W25	Bulb Seal, 3/8", 25ft, White	\$31.50	ea	S44D510	Single Fin "V" Seal, 510ft, Dark Brown	\$640.00	ea
PK33W30	Bulb Seal, 3/8", 30ft, White	\$37.80	ea	S44GR100M	Single Fin "V" Seal, 100M, Gray	\$418.00	ea
PK33W510	Bulb Seal, 3/8", 510ft, White	\$610.00	ea	S44GR17	Single Fin "V" Seal, 17ft, Gray	\$22.00	ea
PK55BL17	Bulb Seal, 3/16", 17ft, Black	\$21.00	ea	S44GR18	Single Fin "V" Seal, 18ft, Gray	\$23.60	ea
PK55BL18	Bulb Seal, 3/16", 18ft, Black	\$22.68	ea	S44GR20	Single Fin "V" Seal, 20ft, Gray	\$26.00	ea
PK55BL20	Bulb Seal, 3/16", 20ft, Black	\$24.80	ea	S44GR21	Single Fin "V" Seal, 21ft, Gray	\$27.50	ea
PK55BL21	Bulb Seal, 3/16", 21ft, Black	\$26.46	ea	S44GR25	Single Fin "V" Seal, 25ft, Gray	\$32.70	ea
PK55BL25	Bulb Seal, 3/16", 25ft, Black	\$31.50	ea	S44GR30	Single Fin "V" Seal, 30ft, Gray	\$39.30	ea
PK55BL30	Bulb Seal, 3/16", 30ft, Black	\$37.80	ea	S44GR204	Single Fin "V" Seal, 204ft, Gray	\$260.00	ea
PK55BL510	Bulb Seal, 3/16", 510ft, Black	\$610.00	ea	S44GR510	Single Fin "V" Seal, 510ft, Gray	\$640.00	ea
PK55BL510/S	Bulb Seal, 3/16", 1020ft, Black	\$650.00	ea	S44W100M	Single Fin "V" Seal, 100M, Gray	\$418.00	ea
PK55D17	Bulb Seal, 3/16", 17ft, Dark Brown	\$21.00	ea	S44W17	Single Fin "V" Seal, 17ft, White	\$22.00	ea

Product Number	Description	List Price	Per Unit	Product Number	Description	List Price	Per Unit
S44W18	Single Fin "V" Seal, 18ft, White	\$23.60	ea	S77D30	Single Fin "T" Seal, 30ft, Dark Brown	\$58.00	ea
S44W20	Single Fin "V" Seal, 20ft, White	\$26.00	ea	S77D510	Single Fin "T" Seal, 510ft, White	\$952.00	ea
S44W21	Single Fin "V" Seal, 21ft, White	\$27.50	ea	S77W17	Single Fin "T" Seal, 17ft, White	\$32.50	ea
S44W25	Single Fin "V" Seal, 25ft, White	\$32.70	ea	S77W18	Single Fin "T" Seal, 18ft, White	\$34.80	ea
S44W30	Single Fin "V" Seal, 30ft, White	\$39.30	ea	S77W20	Single Fin "T" Seal, 20ft, White	\$38.60	ea
S44W204	Single Fin "V" Seal, 204ft, White	\$260.00	ea	S77W21	Single Fin "T" Seal, 21ft, White	\$40.60	ea
S44W510	Single Fin "V" Seal, 510ft, White	\$640.00	ea	S77W25	Single Fin "T" Seal, 25ft, White	\$48.30	ea
S442BL17	Adhesive Silicone Seal Black	\$45.90	ea	S77W30	Single Fin "T" Seal, 30ft, White	\$58.00	ea
S442BL18	Adhesive Silicone Seal Black	\$49.50	ea	S77W510	Single Fin "T" Seal, 510ft, White	\$952.00	ea
S442BL20	Adhesive Silicone Seal Black	\$54.00	ea	S77W510/2	Single Fin "T" Seal, 1020ft, White	\$1,904.00	ea
S442BL21	Adhesive Silicone Seal Black	\$57.75	ea	S88BL100M	Bulb Seal, 1/4", 100M, Black	\$438.00	ea
S442BL25	Adhesive Silicone Seal Black	\$68.75	ea	S88BL17	Bulb Seal, 1/4", 17ft, Black	\$23.12	ea
S442BL30	Adhesive Silicone Seal Black	\$82.50	ea	S88BL18	Bulb Seal, 1/4", 18ft, Black	\$25.20	ea
S442BL510	Adhesive Silicone Seal Black	\$1,330.00	ea	S88BL20	Bulb Seal, 1/4", 20ft, Black	\$27.20	ea
S442D17	Adhesive Silicone Seal Dark Brown	\$45.90	ea	S88BL21	Bulb Seal, 1/4", 21ft, Black	\$29.40	ea
S442D18	Adhesive Silicone Seal Dark Brown	\$49.50	ea	S88BL25	Bulb Seal, 1/4", 25ft, Black	\$35.00	ea
S442D20	Adhesive Silicone Seal Dark Brown	\$54.00	ea	S88BL30	Bulb Seal, 1/4", 30ft, Black	\$42.00	ea
S442D21	Adhesive Silicone Seal Dark Brown	\$57.75	ea	S88BL204	Bulb Seal, 1/4", 204ft, Black	\$274.00	ea
S442D25	Adhesive Silicone Seal Dark Brown	\$68.75	ea	S88BL204/S	Bulb Seal, 1/4", 204ft, Black	\$298.00	ea
S442D30	Adhesive Silicone Seal Dark Brown	\$82.50	ea	S88BL510	Bulb Seal, 1/4", 510ft, Black	\$678.00	ea
S442D510	Adhesive Silicone Seal Dark Brown	\$1,330.00	ea	S88BL510/2	Bulb Seal 1/4", 1020ft, Black	\$1,356.00	ea
S442GR17	Adhesive Silicone Seal Gray	\$45.90	ea	S88BL510/S	Bulb Seal 1/4", 510ft, Black	\$730.00	ea
S442GR18	Adhesive Silicone Seal Gray	\$49.50	ea	S88C17	Bulb Seal, 1/4", 17ft, Clear	\$31.60	ea
S442GR20	Adhesive Silicone Seal Gray	\$54.00	ea	S88C18	Bulb Seal, 1/4", 18ft, Clear	\$34.20	ea
S442GR21	Adhesive Silicone Seal Gray	\$57.75	ea	S88C20	Bulb Seal, 1/4", 20ft, Clear	\$37.20	ea
S442GR25	Adhesive Silicone Seal Gray	\$68.75	ea	S88C21	Bulb Seal, 1/4", 21ft, Clear	\$39.90	ea
S442GR30	Adhesive Silicone Seal Gray	\$82.50	ea	S88C25	Bulb Seal, 1/4", 25ft, Clear	\$47.50	ea
S442GR510	Adhesive Silicone Seal Gray	\$1,330.00	ea	S88C30	Bulb Seal, 1/4", 30ft, Clear	\$57.00	ea
S442W17	Adhesive Silicone Seal White	\$45.90	ea	S88C204	Bulb Seal, 1/4", 204ft, Clear	\$372.00	ea
S442W18	Adhesive Silicone Seal White	\$49.50	ea	S88C510	Bulb Seal, 1/4", 510ft, Clear	\$920.00	ea
S442W20	Adhesive Silicone Seal White	\$54.00	ea	S88D100M	Bulb Seal, 1/4", 100M, Dark Brown	\$438.00	ea
S442W21	Adhesive Silicone Seal White	\$57.75	ea	S88D17	Bulb Seal, 1/4", 17ft, Dark Brown	\$23.12	ea
S442W25	Adhesive Silicone Seal White	\$68.75	ea	S88D18	Bulb Seal, 1/4", 18ft, Dark Brown	\$25.20	ea
S442W30	Adhesive Silicone Seal White	\$82.50	ea	S88D20	Bulb Seal, 1/4", 20ft, Dark Brown	\$27.20	ea
S442W510	Adhesive Silicone Seal White	\$1,330.00	ea	S88D21	Bulb Seal, 1/4", 21ft, Dark Brown	\$29.40	ea
S77BL17	Single Fin "T" Seal, 17ft, Black	\$32.50	ea	S88D25	Bulb Seal, 1/4", 25ft, Dark Brown	\$35.00	ea
S77BL18	Single Fin "T" Seal, 18ft, Black	\$34.80	ea	S88D30	Bulb Seal, 1/4", 30ft, Dark Brown	\$42.00	ea
S77BL20	Single Fin "T" Seal, 20ft, Black	\$38.60	ea	S88D204	Bulb Seal, 1/4", 204ft, Dark Brown	\$274.00	ea
S77BL21	Single Fin "T" Seal, 21ft, Black	\$40.60	ea	S88D510	Bulb Seal, 1/4", 510ft, Dark Brown	\$678.00	ea
S77BL25	Single Fin "T" Seal, 25ft, Black	\$48.30	ea	S88D510/2	Bulb Seal 1/4", 1020ft, Dark Brown	\$1,356.00	ea
S77BL30	Single Fin "T" Seal, 30ft, Black	\$58.00	ea	S88D510/S	Bulb Seal, 1/4", 510ft, Dark Brown	\$730.00	ea
S77C100M	Single Fin "T" Seal, 100M, Clear	\$696.00	ea	S88GR100M	Bulb Seal, 1/4", 100M, Gray	\$438.00	ea
S77C17	Single Fin "T" Seal, 17ft, Clear	\$36.80	ea	S88GR17	Bulb Seal, 1/4", 17ft, Gray	\$23.12	ea
S77C18	Single Fin "T" Seal, 18ft, Clear	\$39.60	ea	S88GR18	Bulb Seal, 1/4", 18ft, Gray	\$25.20	ea
S77C20	Single Fin "T" Seal, 20ft, Clear	\$44.00	ea	S88GR20	Bulb Seal, 1/4", 20ft, Gray	\$27.20	ea
S77C21	Single Fin "T" Seal, 21ft, Clear	\$46.20	ea	S88GR21	Bulb Seal, 1/4", 21ft, Gray	\$29.40	ea
S77C25	Single Fin "T" Seal, 25ft, Clear	\$55.00	ea	S88GR25	Bulb Seal, 1/4", 25ft, Gray	\$35.00	ea
S77C30	Single Fin "T" Seal, 30ft, Clear	\$66.00	ea	S88GR30	Bulb Seal, 1/4", 30ft, Gray	\$42.00	ea
S77C510	Single Fin "T" Seal, 510ft, Clear	\$1,082.00	ea	S88GR204	Bulb Seal, 1/4", 204ft, Gray	\$274.00	ea
S77D17	Single Fin "T" Seal, 17ft, Dark Brown	\$32.50	ea	S88GR510	Bulb Seal, 1/4", 510ft, Gray	\$678.00	ea
S77D18	Single Fin "T" Seal, 18ft, Dark Brown	\$34.80	ea	S88TAN17	Bulb Seal, 1/4", 17ft, Tan	\$23.80	ea
S77D20	Single Fin "T" Seal, 20ft, Dark Brown	\$38.60	ea	S88TAN18	Bulb Seal, 1/4", 18ft, Tan	\$25.20	ea
S77D21	Single Fin "T" Seal, 21ft, Dark Brown	\$40.60	ea	S88TAN20	Bulb Seal, 1/4", 20ft, Tan	\$28.00	ea
S77D25	Single Fin "T" Seal, 25ft, Dark Brown	\$48.30	ea	S88TAN21	Bulb Seal, 1/4", 21ft, Tan	\$29.40	ea

ADHESIVE GASKETING

Product Number	Description	List Price	Per Unit	Product Number	Description	List Price	Per Unit
S88TAN25	Bulb Seal, 1/4", 25ft, Tan	\$35.00	ea	S772D9	Double Fin, Meeting Stile, 9ft, Dk Brown	\$22.80	ea
S88TAN30	Bulb Seal, 1/4", 30ft, Tan	\$42.00	ea	S772D10	Double Fin, Meeting Stile, 10ft, Dk Brown	\$25.20	ea
S88TAN204	Bulb Seal, 1/4", 204ft, Tan	\$274.00	ea	S772D17	Double Fin, Meeting Stile, 17ft, Dk Brown	\$42.50	ea
S88TAN204/S	Bulb Seal, 1/4", 204ft, Tan	\$298.00	ea	S772D18	Double Fin, Meeting Stile, 18ft, Dk Brown	\$45.00	ea
S88TAN510	Bulb Seal, 1/4", 510ft, Tan	\$678.00	ea	S772D21	Double Fin Seal, 21ft, Dk Brown	\$52.50	ea
S88TAN510/2	Bulb Seal 1/4", 1020ft, Tan	\$1,356.00	ea	S772D30	Double Fin Seal, 30ft, Dk Brown	\$75.00	ea
S88TAN510/S	Bulb Seal 1/4", 510ft, Tan	\$730.00	ea	S772GR7	Double Fin, Meeting Stile, 7ft, Gray	\$18.00	ea
S88W100M	Bulb Seal, 1/4", 100M, White	\$438.00	ea	S772GR8	Double Fin, Meeting Stile, 8ft, Gray	\$20.40	ea
S88W17	Bulb Seal, 1/4", 17ft, White	\$23.12	ea	S772GR9	Double Fin, Meeting Stile, 9ft, Gray	\$22.95	ea
S88W18	Bulb Seal, 1/4", 18ft, White	\$25.20	ea	S772GR10	Double Fin, Meeting Stile, 10ft, Gray	\$25.20	ea
S88W20	Bulb Seal, 1/4", 20ft, White	\$27.20	ea	S772GR17	Double Fin, Meeting Stile, 17ft, Gray	\$42.50	ea
S88W21	Bulb Seal, 1/4", 21ft, White	\$29.40	ea	S772GR18	Double Fin, Meeting Stile, 18ft, Gray	\$45.00	ea
S88W25	Bulb Seal, 1/4", 25ft, White	\$35.00	ea	S772GR21	Double Fin Seal, 21ft, Gray	\$52.50	ea
S88W30	Bulb Seal, 1/4", 30ft, White	\$42.00	ea	S772GR30	Double Fin Seal, 30ft, Gray	\$75.00	ea
S88W204	Bulb Seal, 1/4", 204ft, White	\$274.00	ea	S772W7	Double Fin, Meeting Stile, 7ft, White	\$18.00	ea
S88W204/S	Bulb Seal, 1/4", 204ft, White	\$298.00	ea	S772W8	Double Fin, Meeting Stile, 8ft, White	\$20.40	ea
S88W510	Bulb Seal, 1/4", 510ft, White	\$678.00	ea	S772W9	Double Fin, Meeting Stile, 9ft, White	\$22.80	ea
S88W510 /S	Bulb Seal, 1/4", 510ft, White	\$730.00	ea	S772W10	Double Fin, Meeting Stile, 10ft, White	\$25.20	ea
S771BL7	Single Fin, Meeting Stile, 7ft, Black	\$15.40	ea	S772W17	Double Fin, Meeting Stile, 17ft, White	\$42.50	ea
S771BL8	Single Fin, Meeting Stile, 8ft, Black	\$17.60	ea	S772W18	Double Fin, Meeting Stile, 18ft, White	\$45.00	ea
S771BL9	Single Fin, Meeting Stile, 9ft, Black	\$19.80	ea	S772W21	Double Fin Seal, 21ft, White	\$52.50	ea
S771BL10	Single Fin, Meeting Stile, 10ft, Black	\$21.50	ea	S772W30	Double Fin Seal, 30ft, White	\$75.00	ea
S771C7	Single Fin, Meeting Stile, 7ft, Clear	\$16.50	ea	S773BL17	Triple Fin Seal, 17ft, Black	\$45.60	ea
S771C8	Single Fin, Meeting Stile, 8ft, Clear	\$18.80	ea	S773BL18	Triple Fin Seal, 18ft, Black	\$49.50	ea
S771C9	Single Fin, Meeting Stile, 9ft, Clear	\$21.10	ea	S773BL20	Triple Fin Seal, 20ft, Black	\$54.00	ea
S771C10	Single Fin, Meeting Stile, 10ft, Clear	\$23.40	ea	S773BL21	Triple Fin Seal, 21ft, Black	\$57.80	ea
S771D7	Single Fin, Meeting Stile, 7ft, Dk Brown	\$15.40	ea	S773BL25	Triple Fin Seal, 25ft, Black	\$68.80	ea
S771D8	Single Fin, Meeting Stile, 8ft, Dk Brown	\$17.60	ea	S773BL30	Triple Fin Seal, 30ft, Black	\$82.50	ea
S771D9	Single Fin, Meeting Stile, 9ft, Dk Brown	\$19.80	ea	S773BL250	Triple Fin Seal, 250ft, Black	\$670.00	ea
S771D10	Single Fin, Meeting Stile, 10ft, Dk Brown	\$22.00	ea	S773BL500	Triple Fin Seal, 500ft, Black	\$1,320.00	ea
S771GR7	Single Fin, Meeting Stile, 7ft, Gray	\$15.40	ea	S773D17	Triple Fin Seal, 17ft, Dark Brown	\$45.60	ea
S771GR8	Single Fin, Meeting Stile, 8ft, Gray	\$17.60	ea	S773D18	Triple Fin Seal, 18ft, Dark Brown	\$49.50	ea
S771GR9	Single Fin, Meeting Stile, 9ft, Gray	\$19.80	ea	S773D20	Triple Fin Seal, 20ft, Dark Brown	\$54.00	ea
S771GR10	Single Fin, Meeting Stile, 10ft, Gray	\$22.00	ea	S773D21	Triple Fin Seal, 21ft, Dark Brown	\$57.80	ea
S771W7	Single Fin, Meeting Stile, 7ft, White	\$15.40	ea	S773D25	Triple Fin Seal, 25ft, Dark Brown	\$68.80	ea
S771W8	Single Fin, Meeting Stile, 8ft, White	\$17.60	ea	S773D30	Triple Fin Seal, 30ft, Dark Brown	\$82.50	ea
S771W9	Single Fin, Meeting Stile, 9ft, White	\$19.80	ea	S773D250	Triple Fin Seal, 250ft, Dark Brown	\$670.00	ea
S771W10	Single Fin, Meeting Stile, 10ft, White	\$22.00	ea	S773D500	Triple Fin Seal, 500ft, Dark Brown	\$1,320.00	ea
S771x6BL	S771 Profile with 6 Fins Black	\$5.50	ft	S773GR17	Triple Fin Seal, 17ft, Gray	\$45.60	ea
S771x6C	S771 Profile with 6 Fins Clear	\$6.10	ft	S773GR18	Triple Fin Seal, 18ft, Gray	\$49.50	ea
S771x6D	S771 Profile with 6 Fins Dark	\$5.50	ea	S773GR20	Triple Fin Seal, 20ft, Gray	\$54.00	ea
S772BL7	Double Fin, Meeting Stile, 7ft, Black	\$18.00	ea	S773GR21	Triple Fin Seal, 21ft, Gray	\$57.80	ea
S772BL8	Double Fin, Meeting Stile, 8ft, Black	\$20.40	ea	S773GR25	Triple Fin Seal, 25ft, Gray	\$68.80	ea
S772BL9	Double Fin, Meeting Stile, 9ft, Black	\$22.80	ea	S773GR30	Triple Fin Seal, 30ft, Gray	\$82.50	ea
S772BL10	Double Fin, Meeting Stile, 10ft, Black	\$25.20	ea	S773GR250	Triple Fin Seal, 250ft, Gray	\$670.00	ea
S772BL17	Double Fin, Meeting Stile, 17ft, Black	\$42.50	ea	S773GR500	Triple Fin Seal, 500ft, Gray	\$1,320.00	ea
S772BL18	Double Fin, Meeting Stile, 18ft, Black	\$45.00	ea	S773W17	Triple Fin Seal, 17ft, White	\$45.60	ea
S772BL21	Double Fin Seal, 21ft, Black	\$52.50	ea	S773W18	Triple Fin Seal, 18ft, White	\$49.50	ea
S772BL25	Double Fin Seal, 25ft, Black	\$62.50	ea	S773W20	Triple Fin Seal, 20ft, White	\$54.00	ea
S772BL30	Double Fin Seal, 30ft, Black	\$75.00	ea	S773W21	Triple Fin Seal, 21ft, White	\$57.80	ea
S772C7	S77 Meeting Stile with 2 fins	\$20.30	ea	S773W25	Triple Fin Seal, 25ft, White	\$68.80	ea
S772C8	S77 Meeting Stile with 2 fins	\$23.00	ea	S773W30	Triple Fin Seal, 30ft, White	\$82.50	ea
S772C9	S77 Meeting Stile with 2 fins	\$25.90	ea	S773W250	Triple Fin Seal, 250ft, White	\$670.00	ea
S772C10	S77 Meeting Stile with 2 Fins, Clear	\$28.00	ea	S773W500	Triple Fin Seal, 500ft, White	\$1,320.00	ea
S772D7	Double Fin, Meeting Stile, 7ft, Dk Brown	\$18.00	ea	S776BL	S77 Profile with 6 Fins, Black	\$5.50	ft
S772D8	Double Fin, Meeting Stile, 8ft, Dk Brown	\$20.40	ea				

Product Number	List Price	Per Unit	Product Number	List Price	Per Unit	Product Number	List Price	Per Unit
223ANB	\$8.88	ft	18100DNB	\$8.00	ft	35061CNB	\$4.00	ft
223DNB	\$12.90	ft	18100GNB	\$8.00	ft	35061DNB	\$6.80	ft
223GNB	\$14.76	ft	18100PWNB	\$6.30	ft	35061GNB	\$6.80	ft
290ANB	\$6.90	ft	18100WNB36	\$19.00	ea !	45041CNB	\$3.50	ft
290DNB	\$8.40	ft	18137CNB	\$6.00	ft	45041CSB	\$3.50	ft
309CNB	\$2.82	ft	18137DNB	\$8.60	ft	45041DNB	\$5.00	ft
345ANB	\$6.00	ft	18137GNB	\$8.60	ft	45041DSB	\$5.00	ft
345BDGNB	\$8.52	ft	18137PWNB	\$6.90	ft	45041GNB	\$5.00	ft
345DNB	\$8.52	ft	18175CNB	\$9.70	ft	45041GSB	\$5.00	ft
345GNB	\$8.52	ft	18175DNB	\$14.10	ft	45041SNNB	\$5.20	ft
345PWNB	\$7.08	ft	18175GNB	\$14.10	ft	45061CNB	\$3.80	ft
2230ANB	\$5.10	ft	18250CNB	\$11.20	ft	45061DNB	\$5.40	ft
2230DNB	\$6.96	ft	18250DNB	\$16.00	ft	45061GNB	\$5.40	ft
2230GNB	\$8.00	ft	18250GNB	\$16.00	ft	45061SNNB	\$5.70	ft
2891ANB	\$8.00	ft	18400CNB	\$16.70	ft	45062CNB	\$4.40	ft
2891DNB	\$9.60	ft	18400DNB	\$20.60	ft	45062DNB	\$7.30	ft
3452BDGNB	\$6.96	ft	18400GNB	\$20.60	ft	45062GNB	\$7.30	ft
3452CNB	\$5.60	ft	18600CNB	\$25.70	ft	45062PWNB	\$5.00	ft
3452DNB	\$6.60	ft	18600DNB	\$32.50	ft	45100CNB	\$5.60	ft
3452GNB	\$6.60	ft	18600GNB	\$32.50	ft	45100DNB	\$8.00	ft
3452PWNB	\$6.50	ft	18950CNB	\$21.10	ft	45100GNB	\$8.00	ft
3452SNNB	\$6.80	ft	18950DNB	\$24.60	ft	45100PWNB	\$6.10	ft
5025ANB	\$2.50	ft	28945ANB	\$8.10	ft	45137CNB	\$6.00	ft
5025ASB	\$2.40	ft	28945DNB	\$10.00	ft	45137DNB	\$8.60	ft
5041ANB	\$2.40	ft	28945GNB	\$10.90	ft	45137PWNB	\$7.00	ft
5041ASB	\$2.40	ft	29045ANB	\$7.10	ft	45175CNB	\$10.00	ft
5061ANB	\$2.60	ft	29045DNB	\$9.00	ft	45175DNB	\$14.40	ft
5100ANB	\$2.80	ft	29045GNB	\$9.80	ft	45175GNB	\$14.40	ft
18041CNB	\$3.50	ft	29324CNB	\$5.80	ft	45250CNB	\$11.50	ft
18041CSB	\$3.50	ft	29324CSB	\$5.80	ft	45250DNB	\$15.60	ft
18041DNB	\$5.00	ft	29324DNB	\$8.30	ft	45250GNB	\$15.60	ft
18041DSB	\$5.00	ft	29324DSB	\$8.30	ft	45400CNB	\$14.80	ft
18041GNB	\$5.00	ft	29324GNB	\$8.00	ft	45400DNB	\$20.30	ft
18041GSB	\$5.00	ft	29324SNNB	\$9.40	ft	45600CNB	\$25.80	ft
18041PWNB	\$4.10	ft	29326CNB	\$6.00	ft	90041CNB	\$4.90	ft
18041SNNB	\$5.30	ft	29326DNB	\$8.80	ft	90041CSB	\$4.90	ft
18041SNSB	\$7.10	ft	29326GNB	\$8.80	ft	90041DNB	\$5.50	ft
18050CNB	\$3.50	ft	29344CNB	\$5.80	ft	90041DSB	\$5.50	ft
18061CNB	\$3.70	ft	29344CSB	\$5.80	ft	90062CNB	\$4.90	ft
18061DNB	\$5.40	ft	29344DNB	\$8.30	ft	90062DNB	\$5.70	ft
18061GNB	\$5.40	ft	29344DSB	\$8.30	ft	90062GNB	\$5.70	ft
18061SNNB	\$5.70	ft	29346CNB	\$6.00	ft	90100CNB	\$5.70	ft
18062CNB	\$4.30	ft	29346DNB	\$8.80	ft	90100DNB	\$8.00	ft
18062DNB	\$6.20	ft	35041CNB	\$3.60	ft	90100GNB	\$8.00	ft
18062GNB	\$6.30	ft	35041CSB	\$3.60	ft	90137CNB	\$6.00	ft
18062PWNB	\$4.90	ft	35041DNB	\$6.40	ft	90137DNB	\$8.80	ft
18062SNNB	\$6.50	ft	35041DSB	\$6.40	ft	90137GNB	\$8.80	ft
18062WNB36	\$14.60	ea !	35041GNB	\$6.40	ft	293100CNB	\$7.00	ft
18100CNB	\$5.60	ft	35041GSB	\$6.40	ft	293100DNB	\$10.00	ft
						293100GNB	\$11.00	ft

! = Only available in sizes shown.

Product Number	List Price	Per Unit	Product Number	List Price	Per Unit	Product Number	List Price	Per Unit	Product Number	List Price	Per Unit
PDB411AE36	\$80.00	ea @	412SRL48	\$109.00	ea @	OS434ANBL72	\$190.00	ea @	4131SNBL36	\$65.00	ea @
PDB411AE48	\$101.00	ea @	412SSL36	\$89.00	ea @	OS434APKL38	\$107.00	ea @	4131SNBL48	\$87.00	ea @
411ANBL36	\$43.00	ea @	412SSL48	\$119.00	ea @	OS434APKL60	\$159.00	ea @	4131SNPKL36	\$65.00	ea @
411ANBL48	\$54.00	ea @	415CV36	\$40.00	ea @	OS434APKL72	\$189.00	ea @	4131SNPKL48	\$87.00	ea @
411ANBL72	\$97.00	ea @	415CV48	\$46.00	ea @	OS434ARL36	\$92.00	ea @	4131SNRL36	\$69.00	ea @
411APKL36	\$43.00	ea @	415DV36	\$48.00	ea @	OS434ARL48	\$116.00	ea @	4131SNRL48	\$91.00	ea @
411APKL48	\$54.00	ea @	415DV48	\$55.00	ea @	OS434ARL60	\$169.00	ea @	4131SNSL36	\$78.00	ea @
411APKL72	\$97.00	ea @	420APKL36	\$46.00	ea @	OS434ARL72	\$201.00	ea @	4131SNSL72	\$186.00	ea @
411ARL36	\$47.00	ea @	420APKL48	\$58.00	ea @	PDB4131CE36	\$87.00	ea @	4301CNBL36	\$88.00	ea @
411ARL48	\$58.00	ea @	420APKL60	\$86.00	ea @	PDB4131CE048	\$110.00	ea @	4301CNBL48	\$110.00	ea @
411ARL72	\$104.00	ea @	420APKL72	\$106.00	ea @	PDB4131DE36	\$97.00	ea @	4301CPKL36	\$88.00	ea @
411ASL36	\$55.00	ea @	420ASL36	\$52.00	ea @	PDB4131DE48	\$120.00	ea @	4301CPKL48	\$110.00	ea @
411ASL48	\$69.00	ea @	420ASL48	\$64.00	ea @	4131BDGNBL36	\$65.00	ea @	4301CRL36	\$93.00	ea @
411ASL72	\$124.00	ea @	420ASL72	\$115.00	ea @	4131BDGPKL36	\$70.00	ea @	4301CRL48	\$116.00	ea @
412BPKL36	\$78.00	ea @	420AVL36	\$46.00	ea @	4131BDGPKL48	\$93.00	ea @	4301DNBL36	\$98.00	ea @
412BPKL48	\$103.00	ea @	420AVL48	\$58.00	ea @	4131BDGRL36	\$73.00	ea @	4301DNBL48	\$122.00	ea @
412BRL36	\$81.00	ea @	420AVL72	\$106.00	ea @	4131BDGRL48	\$92.00	ea @	4301DPKL36	\$98.00	ea @
412BRL48	\$109.00	ea @	430CMPKL36	\$93.00	ea @	4131BDGRL60	\$137.00	ea @	4301DPKL48	\$122.00	ea @
412BSL36	\$89.00	ea @	430CMPKL48	\$117.00	ea @	4131BDGSL36	\$83.00	ea @	4301DRL36	\$102.00	ea @
412BSL48	\$119.00	ea @	430CMRL36	\$98.00	ea @	4131BDGSL48	\$103.00	ea @	4301DRL48	\$128.00	ea @
412CPKL36	\$55.00	ea @	430CMRL48	\$122.00	ea @	4131CNBL36	\$54.00	ea @	OS4301CNBL72	\$206.00	ea @
412CPKL48	\$68.00	ea @	430CMRL60	\$184.00	ea @	4131CNBL48	\$67.00	ea @	OS4301CPKL60	\$173.00	ea @
412CPKL72	\$122.00	ea @	430CPKL36	\$93.00	ea @	4131CNBL72	\$120.00	ea @	OS4301CPKL72	\$206.00	ea @
412CRL36	\$58.00	ea @	430CPKL48	\$117.00	ea @	4131CPKL36	\$54.00	ea @	OS4301CRL36	\$99.00	ea @
412CRL48	\$72.00	ea @	430CPKL60	\$175.00	ea @	4131CPKL48	\$67.00	ea @	OS4301CRL48	\$132.00	ea @
412CRL72	\$130.00	ea @	430CPKL72	\$210.00	ea @	4131CPKL72	\$120.00	ea @	OS4301CRL60	\$181.00	ea @
412CSL36	\$67.00	ea @	430CRL36	\$98.00	ea @	4131CRL36	\$57.00	ea @	OS4301CRL72	\$216.00	ea @
412CSL48	\$84.00	ea @	430CRL48	\$122.00	ea @	4131CRL48	\$71.00	ea @	OS4301DNBL72	\$227.00	ea @
412CSL72	\$151.00	ea @	430CRL60	\$184.00	ea @	4131CRL60	\$107.00	ea @	OS4301DPKL60	\$191.00	ea @
412DPKL36	\$62.00	ea @	430CRL72	\$220.00	ea @	4131CRL72	\$128.00	ea @	OS4301DRL60	\$199.00	ea @
412DPKL48	\$78.00	ea @	430DMPKL36	\$104.00	ea @	4131CSL36	\$66.00	ea @			
412DPKL72	\$140.00	ea @	430DMPKL48	\$129.00	ea @	4131CSL48	\$82.00	ea @			
412DRL36	\$66.00	ea @	430DMRL36	\$108.00	ea @	4131DNBL36	\$62.00	ea @			
412DRL48	\$82.00	ea @	430DMRL48	\$135.00	ea @	4131DNBL48	\$77.00	ea @			
412DRL72	\$148.00	ea @	430DMRL72	\$243.00	ea @	4131DNBL72	\$139.00	ea @			
412DSL36	\$76.00	ea @	430DPKL36	\$104.00	ea @	4131DPKL36	\$62.00	ea @			
412DSL48	\$94.00	ea @	430DPKL48	\$130.00	ea @	4131DPKL48	\$77.00	ea @			
412DSL72	\$170.00	ea @	430DPKL72	\$232.00	ea @	4131DPKL60	\$116.00	ea @			
412GPKL36	\$70.00	ea @	430DRL36	\$108.00	ea @	4131DRL36	\$65.00	ea @			
412GPKL48	\$87.00	ea @	430DRL48	\$135.00	ea @	4131DRL48	\$82.00	ea @			
412GRL36	\$74.00	ea @	430DRL72	\$243.00	ea @	4131DRL72	\$147.00	ea @			
412GRL48	\$92.00	ea @	434ANBL36	\$82.00	ea @	4131DSL36	\$74.00	ea @			
412GSL36	\$85.00	ea @	434ANBL48	\$102.00	ea @	4131DSL48	\$92.00	ea @			
412GSL48	\$92.00	ea @	434APKL36	\$82.00	ea @	4131DSL60	\$137.00	ea @			
412SPKL36	\$78.00	ea @	434APKL48	\$102.00	ea @	4131GNBL36	\$70.00	ea @			
412SPKL48	\$103.00	ea @	434ARL36	\$86.00	ea @	4131GPKL36	\$70.00	ea @			
412SPKL60	\$160.00	ea @	434ARL48	\$108.00	ea @	4131GRL36	\$73.00	ea @			
412SRL36	\$82.00	ea @	OS434ANBL60	\$159.00	ea @	4131GRL48	\$92.00	ea @			

@ = Sizes ordered other than shown priced at the next available size.

FOAM TAPE

GARAGE WEATHERSTRIP

REPLACEMENT VINYL

Product Number	List Price	Per Unit	Product Number	List Price	Per Unit	Product Number	List Price	Per Unit
P39C17	\$10.60	ea !	301AV	\$8.40	ea	PV9BL36	\$3.80	ea !
P39C180	\$93.60	ea !	P361V9	\$15.90	ea	PV9GR36	\$3.80	ea !
P240	\$2.80	ea	P361V16	\$28.30	ea	PV9W36	\$3.80	ea !
P241	\$4.40	ea	P364R9	\$16.00	ea	PV11BL36	\$9.80	ea !
P241-30	\$7.70	ea	P364R16	\$29.20	ea	PV11GR36	\$4.20	ea !
P242	\$5.00	ea	P364R100	\$172.70	ea	PV13BL36	\$3.80	ea !
P243	\$6.70	ea	R364-100	\$146.00	ea !	PV13GR36	\$3.60	ea !
P244	\$8.60	ea	P365V9	\$11.50	ea	PV15GR36	\$3.80	ea !
P260	\$3.70	ea	P365V16	\$20.30	ea	PV22BL36	\$3.80	ea !
P261	\$3.80	ea	V365	\$1.30	ft	PV22GR36	\$3.60	ea !
P262	\$7.80	ea	P366V16	\$14.50	ea	PV22GR72	\$7.20	ea !
P263	\$3.20	ea				PV64BL36	\$3.50	ea !
P264	\$6.30	ea				PV64BL72	\$7.00	ea !
P265	\$4.40	ea				PV64GR36	\$3.50	ea !
P266	\$8.40	ea				PV64GR72	\$7.00	ea !
P267	\$7.40	ea				PV83TN36	\$3.40	ea !
P380	\$3.80	ea				PV83TN72	\$6.80	ea !
P380R50	\$17.70	ea						
P381	\$4.50	ea						
P381R50	\$20.80	ea						
P382	\$9.40	ea						
P382R50	\$42.70	ea						
P383R50	\$18.90	ea						
P384	\$12.50	ea						
P384R25	\$28.10	ea						
P385	\$5.00	ea						
P386	\$8.40	ea						
P387	\$6.90	ea						
P387R50	\$32.30	ea						
P388	\$6.00	ea						
P388R50	\$28.10	ea						
P389R25	\$16.70	ea						
P390	\$5.00	ea						
P391	\$5.30	ea						
P392	\$7.20	ea						
P393	\$9.40	ea						
P394	\$13.60	ea						
P396	\$5.90	ea						
P397	\$5.00	ea						
P398	\$12.90	ea						
P480	\$18.80	ea						
P484	\$6.30	ea						
P485	\$19.80	ea						
P489R50	\$28.10	ea						
P490	\$5.70	ea						
P490R50	\$27.10	ea						
P491	\$5.20	ea						
P491R50	\$25.00	ea						
P493	\$8.20	ea						
P493R50	\$38.50	ea						
P497	\$10.90	ea						
P497R50	\$52.00	ea						

! = Only available in sizes shown.

Product Number	List Price	Price Unit	Description	Product Number	List Price	Price Unit	Description
1. REPLACEMENT SILICONSEAL							
S3BL	1.86	ft	(For 290, 297, 303, 316, 1842, 2891), Black	P14075GR	2.29	ft	Black (For 3452, 411, 4131, 4301, 434, 530), Gray
S3VW	1.86	ft	(For 297, 303), White	P14100BL	2.56	ft	(For 345), Black
S4BL	1.48	ft	(For 351, 354, 355, 369, 420, 3443, 3444, 3491, 3492, 3493, 3494, 29310), Black	P14100GR	2.56	ft	(For 345), Gray
S4GR	1.48	ft	(For 351, 354, 355, 369, 420, 3443, 3444, 3491, 3492, 3493, 3494, 29310), Gray	P38062BL	2.96	ft	(For 18062, 45062), Black
2. REPLACEMENT THERMOSEAL				P38062GR	2.96	ft	(For 18062, 45062), Gray
T5BL	1.88	ft	(For Panic Saddles & Bumper Thresholds)	P38100BL	5.26	ft	(For 18100, 45100), Black
3. REPLACEMENT PEMKOPRENE				P38100GR	5.26	ft	(For 18100, 45100), Gray
PK4BL500	397.00	ea	(For 420, 3443, 3444, 29310), Black	P38137BL	6.10	ft	(For 18137, 45137), Black
PK9BL	2.16	ft	(For 210, 211, 215, 216, 217, 220, 221, 222, 234, 2211), Black	P38137GR	6.10	ft	(For 18137, 45137), Gray
PK9GR	2.16	ft	(For 210, 211, 215, 216, 217, 220, 221, 222, 234, 2211), Gray	P58175BL	9.30	ft	(For 18175, 45175), Black
PK47BL	0.81	ft	(For 290, 297, 303, 316, 1842, 2891), Black	P58175GR	9.30	ft	(For 18175, 45175), Gray
PK47GR	0.81	ft	(For 290, 297, 303, 316, 1842, 2891), Gray	P58250BL	10.80	ft	(For 18250, 45250), Black
PK54BL	2.14	ft	(For 307, 345), Black	P58250GR	10.80	ft	(For 18250, 45250), Gray
PK54GR	2.20	ft	(For 307, 345), Gray	P58400BL	13.60	ft	(For 18400, 18950, 45400), Black
PK65BL	1.80	ft	(For 308, 3452), Black	P58400GR	13.60	ft	(For 18400, 18950, 45400), Gray
PK65GR	1.80	ft	(For 308, 3452), Gray	P58600BL	15.40	ft	(For 18600, 45600), Black
PK74BL-152	35.20	ea	Moisture Barrier Seal (For Narrow Fixed Vinyl Top Thresholds), Black	P58600GR	15.40	ft	(For 18600, 45600), Gray
PK381BL	2.08	ft	(For 2006, 2007, 2008), Black	P516041BL	2.43	ft	(For 18041, 29324, 29344, 35041, 45041, 5041, 90041), Black
PK772BL	1.30	ft	(For 3692_PK772), Black	P516041GR	2.43	ft	(For 18041, 29324, 29344, 35041, 45041, 5041), Gray
PK772GR	1.30	ft	(For 3692_PK772), Gray	P516062BL	2.56	ft	(For 18061, 29326, 29346, 35061, 45061, 5061, 2230), Black
PK773BL-37	3.86	ea	(For 3692_PK773), Black	P516062GR	2.56	ft	(For 18061, 29326, 29346, 35061, 45061, 5061, 2230), Gray
PK773BL-49	5.14	ea	(For 3692_PK773), Black	P516100BL	4.45	ft	(For 90100, 293100), Black
PK773GR-37	3.86	ea	(For 3692_PK773), Gray	P516100GR	4.45	ft	(For 90100, 293100), Gray
PK773GR-49	5.15	ea	(For 3692_PK773), Gray	P516137BL	5.26	ft	(For 18137, 90137), Black
PK4132BL	1.21	ft	(For 296, 379, 411, 412, 4131), Black	P516137GR	5.26	ft	(For 18137, 90137), Gray
PK4304BL	2.29	ft	(For 434, 4301, 430, 350), Black	8. REPLACEMENT PILE WEATHERSTRIP			
4. REPLACEMENT NEOPRENE, SOLID AND SPONGE				P2BL	0.81	ft	(For Meeting Stiles, Astragals, Panic Saddles), Black
R4BL	1.76	ft	3/8x1-1/4" (For 375), Black	P2GR	0.81	ft	(For Meeting Stiles, Astragals, Panic Saddles), Gray
R5BL	1.35	ft	(For 335, 68), Black	P3BL	0.81	ft	(For 309), Black
R8BL	4.45	ft	(For 352), Black	P3GR	0.81	ft	(For 309), Gray
R11BL	1.08	ft	(For 322SSR), Black	P4BL	0.68	ft	(For 369-P4), Black
N8BL	2.36	ft	(For 321_N, 315_N), Black	P4GR	0.68	ft	(For 369-P4), Gray
N8GR	8.14	ft	(For 315_N), Gray	P6GR	0.33	ft	(For 434), Gray
N10BL	4.71	ft	(For 368_N), Black	9. REPLACEMENT VINYL			
5. REPLACEMENT EPDM INSERT				EV7BL	0.26	ft	(For 355), Black
E1BL	2.14	ft	(For 313_N, 317_N), Black	EV7GR	0.26	ft	(For 355), Gray
E1GR	2.14	ft	(For 313_N, 317_N), Gray	EV7W	0.26	ft	(For 355), White
ER1BL	1.35	ft	(For 305_R), Black	EV9BL	1.08	ft	(For 210, 211, 215, 216, 217, 220, 221, 222, 234, 2211), Black
E2BL	3.21	ft	(For 305_N, 329_N), Black	EV9GR	1.08	ft	(For 210, 211, 215, 216, 217, 220, 221, 222, 234, 2211), Gray
E2GR	3.21	ft	(For 305_N, 329_N), Gray	EV9W	1.08	ft	(For 210, 215, 216, 217), White
ER2BL	1.18	ft	(For 315_R, 3151_R), Black	EV11BL	2.36	ft	(For 203, 204), Black
E3BL	5.36	ft	(For 314_N), Black	EV11GR	2.36	ft	(For 203, 204), Gray
E3GR	5.36	ft	(For 314_N), Gray	EV12GR	0.41	ft	(For Threshold Foot Vinyl), Gray Only
E6BL	8.57	ft	(For 358_N), Black	EV13BL	1.08	ft	(For 208), Black
E6GR	8.57	ft	(For 358_N), Gray	EV13GR	1.08	ft	(For 208), Gray
E7BL	2.57	ft	(For 277, 296, 379, 412, 4131, 411), Black	EV15GR	1.08	ft	(For 209), Gray Only
ER9BL	1.55	ft	(For 315_R, 3121_R), Black	EV17BL	0.54	ft	(For 356), Black
ER10BL	2.60	ft	(For 2009_E), Black	EV17GR	0.54	ft	(For 356), Gray
E11BL	2.36	ft	(For 319_N), Black	EV17W	0.54	ft	(For 356), White
E121BL	3.75	ft	(For 322_N), Black	EV22BL	1.08	ft	(For 206, 207), Black
E4304BL	3.68	ft	(For 4301, 430, 350, 434), Black	EV22GR	1.08	ft	(For 206, 207), Gray
6. REPLACEMENT FOAM INSERT				EV23GR	0.54	ft	(For 378), Gray
Q380x250BL	2.12	ft	(For 2006STC, 2007STC, 2008STC), Black	EV28BL	0.19	ft	(For 322, 350), Gray
7. REPLACEMENT NYLON BRUSH WEATHERSTRIP				EV38	0.16	ft	(For 377), Tan
P14025BL	2.16	ft	Black	EV43GR	0.86	ft	(For 405), Gray
P14041BL	2.16	ft	Black	EV41BL	0.68	ft	(For Panic Saddles & Bumper Thresholds), Black
P14050BL	2.16	ft	(For 290, 2891), Black	EV41GR	0.68	ft	(For Panic Saddles & Bumper Thresholds), Gray
P14075BL	2.29	ft	(For 3452, 411, 4131, 4301, 434, 530), Black	EV47BL	0.68	ft	(For 297, 303, 316, 1842, 2891, 290), Black
				EV47GR	0.68	ft	(For 297, 303, 316, 1842, 2891, 290), Gray

Product Number	List Price	Price Unit	Description
EV47W	0.68	ft	(For 297, 303), White
EV54BL	0.68	ft	(For 307, 345), Black
EV54GR	0.68	ft	(For 307, 345), Gray
EV56BL	1.35	ft	(For 56), Black
EV56GR	1.35	ft	(For 56), Gray
EV57BL	1.35	ft	(For 57), Black
EV58BL	2.16	ft	(For 318), Black
EV58GR	2.16	ft	(For 318), Gray
EV59BL	0.68	ft	(For 306, 2902, 2892), Black
EV59GR	0.68	ft	(For 306, 2902, 2892), Gray
EV59W	0.38	ft	(For 306, 2902, 2892), White
EV60GR	0.81	ft	(For 294, 2893, 2903), Gray
EV61BL	0.85	ft	(For 330), Black
EV61GR	0.85	ft	(For 330), Gray
EV64BL	0.95	ft	(For 249, 250), Black
EV64GR	1.08	ft	(For 249, 250), Gray
EV65BL	0.72	ft	(For 3452_V), Black
EV65GR	0.72	ft	(For 3452_V), Gray
EV65W	0.72	ft	(For 3452_V), White
EV94BL	2.33	ft	(For 2173, 2113, 2343, 2163), Black
10. FLAT-HEAD SLEEVE ANCHORS, #1/4-20x2"			
FHSL14200BP	1.88	ea	Brass Pl
FHSL14200BP3	5.54	bg	Brass Pl, 3pk
FHSL14200BP4	7.53	bg	Brass Pl, 4pk
FHSL14200D	1.88	ea	Bronze Pl
FHSL14200D3	5.54	bg	Bronze Pl, 3pk
FHSL14200Z	1.88	ea	Zinc Pl
FHSL14200Z3	5.54	bg	Zinc Pl, 3pk
FHSL14200Z4	7.53	bg	Zinc Pl, 4pk
11. WEATHERSTRIP NAILS			
NL1634BB	160.00	lb	#16x3/4", Solid Brass, Flat Hd
NL1634SS	75.00	lb	#16x3/4", Stainless Steel, Flat Hd
NL1678BL	38.00	lb	#16x7/8", Black Finish, Zinc, Flat Hd
NL1678BL	0.03	ea	#16x7/8", Black Finish, Zinc, Flat Hd, per each
NL1678BL20	0.70	bg	#16x7/8", Black Finish, Zinc, Flat Hd, 20pk
NL1678BP	38.00	lb	#16x7/8", Brass Pl, Flat Hd
NL1678BP	0.03	ea	#16x7/8", Brass Pl, Flat Hd, per each
NL1678Z	25.00	lb	#16x7/8", Zinc, Flat Hd
NL1678Z20	0.43	bg	#16x7/8", Zinc, Flat Hd, 20 pk
NL1678Z140	3.00	bg	#16x7/8", Zinc, Flat Hd, 140 pk
NL1678Z	0.02	ea	#16x7/8", Zinc, Flat Hd
NL13516BP	1.11	lb	#13x5/16", Brass Pl, Wafer Hd Drive Screw
NL13516Z	1.11	lb	#13x5/16", Zinc Pl, Wafer Hd Drive Screw
NL13516Z20	0.19	ea	#13x5/16", Zinc Pl, Wafer Hd Drive Screw, 20pk
12. SCREW NAILS, #5x7/8"			
SCNL578BP	0.30	ea	Brass Pl, Slotted
SCNL578BP7	2.11	ea	Brass Pl, Slotted, 7pk
SCNL578Z	0.23	ea	Zinc Pl, Slotted
SCNL578Z7	1.60	ea	Zinc Pl, Slotted, 7pk
13. SHEET METAL SCREWS, SPECIAL #8x1/2" TRUSS HEAD, STAINLESS STEEL			
SP8050SS	0.12	ea	with #6 Head x PSD2-2, SS
SP8050SS8	1.07	bg	with #6 Head x PSD2-2, SS, 8pk
SP8050SS36	4.60	bg	with #6 Head x PSD2-2, SS, 36pk
SP8050SSBL	0.15	ea	with #6 Head x PSD2-2, Black Zinc
SP8050SSBL8	1.20	bg	with #6 Head x PSD2-2, Black Zinc, 8pk
SP8050SSBL36	5.46	bg	with #6 Head x PSD2-2, Black Zinc, 36pk
SP8050SSBP	0.15	ea	with #6 Head x PSD2-2, Brass Pl
SP8050SSBP8	1.20	bg	with #6 Head x PSD2-2, Brass Pl, 8pk
SP8050SSBP36	5.46	bg	with #6 Head x PSD2-2, Brass Pl, 36pk
SP8050SSW	0.15	ea	with #6 Head x PSD2-2, White
SP8050SSW8	1.20	bg	with #6 Head x PSD2-2, White, 8pk
SP8050SSW36	5.46	bg	with #6 Head x PSD2-2, White, 36pk
14. TEK SCREWS, SPECIAL #8x3/4" TRUSS HEAD, STAINLESS STEEL			
TKSP8075SS	0.27	ea	with #6 Head x PSD2-2, SS
TKSP8075SS8	1.72	bg	with #6 Head x PSD2-2, SS, 8pk

Product Number	List Price	Price Unit	Description
TKSP8075SS36	7.72	bg	with #6 Head x PSD2-2, SS, 36pk
TKSP8075SSBL	0.32	ea	with #6 Head x PSD2-2, Black
TKSP8075SSBL8	2.14	bg	with #6 Head x PSD2-2, Black, 8pk
TKSP8075SSBL36	9.96	bg	with #6 Head x PSD2-2, Black, 36pk
TKSP8075SSBP	0.32	ea	with #6 Head x PSD2-2, Brass Pl
TKSP8075SSBP8	2.14	bg	with #6 Head x PSD2-2, Brass Pl, 8pk
TKSP8075SSBP36	9.96	bg	with #6 Head x PSD2-2, Brass Pl, 36 pk
TKSP8075SSW	0.32	ea	with #6 Head x PSD2-2, White
TKSP8075SSW8	2.14	bg	with #6 Head x PSD2-2, White, 8pk
TKSP8075SSW36	9.96	bg	with #6 Head x PSD2-2, White, 36 pk
15. SHEET METAL SCREWS, #10x1" PHILLIPS, FLAT HEAD			
SMS10100BL	0.15	ea	Black, SMS, Phil
SMS10100BL3	0.45	bg	Black, SMS, Phil, 3pk
SMS10100BP	0.18	ea	Brass Plate, SMS, Phil
SMS10100BP3	0.54	bg	Brass Plate, SMS, Phil, 3pk
SMS10100SS	0.28	ea	Stainless Steel, SMS, Phil
SMS10100SS3	0.84	bg	Stainless Steel, SMS, Phil, 3pk
SMS10100Z	0.11	ea	Zinc, SMS, Phil
SMS10100Z3	0.33	bg	Zinc, SMS, Phil, 3pk
16. SHEET METAL SCREWS, #10x2" FLAT HEAD			
SMS10200SSBL	2.18	ea	Black SS
SMS10200SSBL3	6.54	bg	Black SS, 3pk
SMS10200SS	0.79	ea	Stainless Steel
SMS10200SS3	2.37	bg	Stainless Steel, 3pk
17. WOOD SCREWS, #10x1-1/2" PHILLIPS, FLAT HEAD			
WS10150BB	0.55	ea	Brass, Slotted
WS10150BB3	1.65	bg	Brass, Slotted, 3pk
WS10150BL	0.19	ea	Black Zinc
WS10150BL3	0.57	bg	Black Zinc, 3pk
WS10150BP	0.30	ea	Brass Pl
WS10150BP3	0.90	bg	Brass Pl, 3pk
WS10150W	2.90	ea	White
WS10150W3	0.87	bg	White, 3pk
WS10150Z	0.14	ea	Zinc
WS10150Z3	0.42	bg	Zinc, 3pk
18. WOOD SCREWS, #10x2" PHILLIPS, FLAT HEAD			
WS10200BB	0.62	ea	Brass
WS10200BB3	1.86	bg	Brass, 3pk
WS10200BL	0.27	ea	Black
WS10200BL3	0.81	bg	Black, 3pk
WS10200BP	0.28	ea	Brass Pl
WS10200BP3	0.84	bg	Brass Pl, 3pk
WS10200W	0.22	ea	White
WS10200W3	0.66	bg	White, 3pk
WS10200Z	0.19	ea	Zinc
WS10200Z3	0.57	bg	Zinc, 3pk
19. WOOD SCREWS, #10x2-1/2" PHILLIPS, FLAT HEAD			
WS10250BB	1.19	ea	Brass
WS10250BB3	3.57	bg	Brass, 3pk
WS10250BL	0.27	ea	Black
WS10250BL3	0.81	bg	Black, 3pk
WS10250BP	0.28	ea	Brass Pl
WS10250BP3	0.84	bg	Brass Pl, 3pk
WS10250W	0.35	ea	White
WS10250W3	1.05	bg	White, 3pk
WS10250Z	0.19	ea	Zinc
WS10250Z3	0.57	bg	Zinc, 3pk
20. WOOD SCREWS, #10x3" PHILLIPS, FLAT HEAD			
WS10300BB	1.33	ea	Brass
WS10300BB3	4.00	bg	Brass, 3pk
WS10300BL	0.32	ea	Black
WS10300BL3	0.96	bg	Black, 3pk
WS10300BP	0.30	ea	Brass Pl
WS10300BP3	0.90	bg	Brass Pl, 3pk
21. WOOD SCREWS, #10x4" PHILLIPS, FLAT HEAD			
WS10400BL	0.47	ea	Black
WS10400Z	0.47	ea	Zinc Pl

Product Number	List Price	Price Unit	Description
22. Wood Screws #12-8x1-1/2x#10 FLAT HEAD			
PBS12150SP10BL24	2.18	bg	Black, 24pk
PBS12150SP10BLR21	5.20	bg	Black Ruspert, 21pk
PBS12150SP10R21	6.24	bg	Ruspert, 21pk
PBS12150SP10SS24	7.50	bg	Stainless Steel, 24pk
23. MACHINE SCREWS, #10-24x1-1/2" PHILLIPS, FLAT HEAD			
MS10150BB	1.09	ea	Brass
MS10150BB3	3.27	bg	Brass, 3pk
MS10150BB4	4.36	bg	Brass, 4pk
MS10150BL	0.23	ea	Black
MS10150BL3	0.69	bg	Black, 3pk
MS10150BL4	0.92	bg	Black, 4pk
MS10150BP	0.31	ea	Brass Pl
MS10150BP3	0.93	bg	Brass Pl, 3pk
MS10150BP4	1.24	bg	Brass Pl, 4pk
MS10150SS	0.78	ea	Stainless Steel
MS10150SS3	2.34	bg	Stainless Steel, 3pk
MS10150SSBL	0.78	ea	Black, Stainless Steel
MS10150SSBL3	2.34	bg	Black, Stainless Steel, Black, 3pk
MS10150Z	0.20	ea	Zinc
MS10150Z3	0.60	bg	Zinc, 3pk
MS10150Z4	0.80	bg	Zinc, 4pk
24. MACHINE SCREWS, #1/4x20 PHILLIPS			
MS14056Z	0.48	ea	1/4-20x9/16", Zinc, Pancake Hd
MS14075TSS	1.29	ea	1/4-20x3/4", Stainless Steel, Truss Hd
MS14075TZ	0.22	ea	1/4-20x3/4", Zinc, Truss Hd
MS14150BL	0.37	ea	1/4-20x1-1/2", Black, Flat Hd
MS14150BL3	1.11	bg	1/4-20x1-1/2", Black, Flat Hd, 3pk
25. WOOD SCREWS, FLAT HEAD			
PBS12150SP10SS24	7.50	bg	12-8 x 1-1/2 x #10 FH, Stainless Steel
PBS12175Z21	1.21	bg	12-8 x 1-3/4, Phil/Roberson, Zinc
26. MACHINE SCREWS, #6-32x1/2" PHILLIPS, TRUSS HEAD			
MS63250SS	0.16	ea	Stainless Steel
MS63250SSBL	0.29	ea	Black Stainless Steel
MS63250SSBP	0.42	ea	Brass Pl, Stainless Steel
MS63225Z	0.17	ea	#6-32x1/4" Zinc, Phil, Pan Hd
27. MACHINE SCREWS, #8-32x1/2" PHILLIPS, FLAT HEAD			
MS850BP	0.09	ea	Brass Pl
MS850Z	0.06	ea	Zinc
28. LEAD SHIELDS			
LS10L	0.54	ea	#10-12-14x1
LS10L3	1.62	bg	#10-12-14x1, 3pk
LS10L4	2.16	bg	#10-12-14x1, 4pk
LS10L100	54.00	bx	#10-12-14x1, Box of 100
29. EXPANSION SHIELDS			
ES10L	0.54	ea	#10-24x3/8"
ES10L3	1.62	bg	#10-24x3/8", 3pk
ES10L4	2.16	bg	#10-24x3/8", 4pk
ES10L100	54.00	bx	#10-24x3/8", Box of 100
ES14L	0.85	ea	#1/4-20x7/8"
ES14L3	2.55	bg	#1/4-20, 3pk
30. PLASTIC ANCHORS/EXPANSION SHIELDS			
PLA580	0.15	ea	#10-12x1
PLA580-3	0.45	bg	#10-12x1, 3pk
PLA580-4	0.60	bg	#10-12x1, 4pk
31. TAPCON SCREWS, #10 (3/16) PHILLIPS, FLAT HEAD			
TC316125	1.00	ea	3/16 x 1-1/4" Silver
TC316175	1.00	ea	3/16 x 1-3/4" Silver
TC316225	1.00	ea	3/16 x 2-1/4" Silver
TC316275	1.37	ea	3/16 x 2-3/4" Silver
32. TEK SCREWS, #8x1-1/4" OVAL HEAD			
TKS8125BP	3.00	ea	Brass Pl
TKS8125BP8	4.40	bg	Brass Pl, 8pk
TKS8125D	0.55	ea	Black Zinc
TKS8125D8	4.40	bg	Black Zinc, 8pk

Product Number	List Price	Price Unit	Description
TKS8125Z	0.55	ea	Zinc
TKS8125Z8	4.40	bg	Zinc, 8pk
33. SHEET METAL SCREWS, #8x1" PHILLIPS, FLAT HEAD			
SMS8100UCBL	0.33	ea	Black Zinc, per each
SMS8100UCBL8	2.66	bg	Black Zinc, 8pk
SMS8100UCBP	0.15	ea	Brass Pl
SMS8100UCBP8	1.16	bg	Brass Pl, 8pk
SMS8100UCW	0.10	ea	White
SMS8100UCW8	0.83	bg	White, 8pk
SMS8100UCZ	0.07	ea	Zinc Pl
SMS8100UCZ8	0.58	bg	Zinc Pl, 8pk
SMS8100BL	0.08	ea	Black Zinc, per each
SMS8100W	27.00	c	White
SMS8100Z	0.62	ea	Zinc
SMS8100Z8	0.50	bg	Zinc, 8pk
34. SHEET METAL SCREWS, #8x1-1/4"			
SMS8125BP	0.17	ea	Brass Pl, Phil Flat Hd
SMS8125BP8	1.33	bg	Brass Pl, Phil Flat Hd, 8pk
SMS8125D	0.11	ea	Black, Phil Flat Hd
SMS8125D8	0.92	bg	Black, Phil Flat Hd, 8pk
SMS8125TBL	0.14	ea	Black, Phil Truss Hd
SMS8125TBP	0.09	ea	Brass Pl, Phil Truss Hd
SMS8125TZ	0.08	ea	Zinc, Phil Truss Hd
SMS8125Z	0.08	ea	Zinc, Phil Flat Hd
SMS8125Z8	0.67	bg	Zinc, Phil Flat Hd, 8pk
35. THRU BOLT, #1/4-20x1-5/8"			
TB1420BL	2.00	ea	Black Zinc
TB1420BL4	7.95	bg	Black Zinc, 4pk
TB1420SS	9.36	ea	Stainless Steel
TB1420Z	1.77	ea	Zinc
TB1420Z4	7.07	bg	Zinc, 4pk
36. FASTENER KITS FOR AUTOMATIC DOOR BOTTOMS			
K411	1.60	ea	Kit for 411A and PDB411A
K412PA	1.25	ea	Kit for 412C
K412PD	1.25	ea	Kit for 412D
K412PG	1.25	ea	Kit for 412G
K412PS	2.10	ea	Kit For 412 for Stainless Steel
K4133C	4.00	ea	Kit for 4131C and PDB4131C
K4133D	4.00	ea	Kit for 4131D and PDB4131D
K4133G	4.00	ea	Kit for 4131G
K420	1.25	ea	Kit for 420A
K434	3.00	ea	Kit for OS434A
K435	3.00	ea	Kit for 434A
K436	4.00	ea	Kit for 4301A
K437	6.00	ea	Kit for 430C and 430D, Surface
K437SM	6.00	ea	Kit for 430CM and 430DM, Semi-mortised
KSA2A	0.60	ea	Kit for SA1, SA2, SA3, SA4
KSA2D	0.60	ea	Kit for SA1D, SA2D, SA3D, SA4D
K435-PREM	11.00	ea	Kit for Special End Support Mounting of 434
37. FASTENER KITS FOR PEMKOHINGE™			
KCBP	32.00	ea	Kit for Full Surface Balanced Pivot, Clear
KDBP	32.00	ea	Kit for Full Surface Balanced Pivot, Dark
KCCP	22.00	ea	Kit for Full Surface Center Pivot, Clear
KDCP	22.00	ea	Kit for Full Surface Center Pivot, Dark
KCFSR1	22.00	ea	Kit for Full Surface, Clear
KDFSR1	22.00	ea	Kit for Full Surface, Dark
38. REPLACEMENT SNAP COVERS FOR WEATHERSTRIP			
C29316	2.00	ft	Clear Anodized Aluminum
D29316	2.50	ft	Dark Bronze Anodized Aluminum
G29316	2.80	ft	Gold Anodized Aluminum
PW29316	2.50	ft	Painted White Aluminum
SN29316	2.80	ft	Satin Nickel Anodized Aluminum

How To Order (Hinge Part Designations)

Example: **D|SPFM|85|SLI|HD1**

Finishes	Hinge Types	Lengths	Hinge Options	Capacity
BL Black Anodized	AL_FM Aluminum Full-Mortise	79	"blank" Standard "blank"	Standard Duty
C Clear Anodized	AL_HS Aluminum Half-Surface	83	CP Center Pivot	HD1 Heavy Duty, Grade 1
D Dark Bronze Anodized	FM Full-Mortise	85	RG Raised Gear	HD3 Heavy Duty, Grade 3
G Gold Anodized	FS Full-Surface	95	SF Safety	
PW Painted White	HS Half-Surface	120	SL Short Leaf (residential only)	
SN Satin Nickel Anodized	RS138 Full-Mortise Residential: 1-3/8"		SLF Short Leaf Flush	
	RS175 Full-Mortise Residential: 1-3/4"		SLI Short Leaf Inset	
	SPFM Special Full-Mortise			
	WT_FM Wide Throw Full-Mortise			
	WT_HS Half-Surface			

Replacement / Specialty Items

- All hinges are supplied with standard fastener kits. Replacement kits / individual fasteners may be purchased separately
- TEK/TORX fasteners may be purchased separately: a full-mortise hinge requires 40 each; a half-surface hinge requires 20 each; a full-surface hinge requires 12 each
- All half-surface and full-surface hinges are supplied with a snap cover for the door leaf. Replacement snap covers may be purchased separately
- Rain caps are being redeveloped; contact Customer Service for more details.

Description	Product #	List Price
Snap Cover for CFS83 & CHS83	C1-83	32.00 ea
Snap Cover for CFS85 & CHS85	C1-85	32.00 ea
Snap Cover for CFS95 & CHS95	C1-95	36.00 ea
Snap Cover for CFS120 & CHS120	C1-120	45.00 ea
Snap Cover for DFS83 & DHS83	D1-83	48.00 ea
Snap Cover for DFS85 & DHS85	D1-85	48.00 ea
Snap Cover for DFS95 & DHS95	D1-95	55.00 ea
Snap Cover for DFS120 & DHS120	D1-120	70.00 ea
Teflon Spray Lubricant	GT85	31.50 ea
Fastener Kit for CFS, CFSHD, CHS, & CHSHD	KCFSR1	22.00 ea
Fastener Kit for DFS, DFSHD, CHS, & DHSHD	KDFSR1	22.00 ea

Description	Product #	List Price
Fastener Kit for CFSCP, CFSCPHD	KCCP	22.00 ea
Fastener Kit for DFSCP, DFSCPHD	KDCP	22.00 ea
Fastener Kit for CFSBP	KCBP	32.00 ea
Fastener Kit for DFSBP	KDBP	32.00 ea
Fastener Kit for Hinge Product #'s which include the letters "C & FM"	MS1244SP10R21	8.00 ea
Fastener Kit for Hinge Product #'s which include the letters "D & FM"	MS1244SP10BLR21	8.00 ea
#12 x 1-1/2" Particle Board Screw Flat Hd Phil Black 21pk	PBS12150SP10BLR21	4.00 ea
#12 x 1-1/2" Particle Board Screw Flat Hd Phil Silver 21pk	PBS12150SP10R21	4.00 ea
TEK #12 x 3/4" FHUC #3 Phillips Black 21pk	TKS1267SP10BLR21	8.00 ea
TEK #12 x 3/4" FHUC #3 Phillips Silver 21pk	TKS1267SP10R21	8.00 ea
TORX #12-24 x 1/2" FHUC T-25 SS Black 20pk	TORX-MS12050SSBL20	32.00 ea
TORX #12-24 x 1/2" FHUC T-25 Silver 20pk	TORX-MS1244SP10R21	21.00 ea
Custom Length Cut Charge	CUT TO __	18.00 ea

Electrical Modifications

PEMKO has vastly improved the cycle performance of the electrically modified hinge. Performance testing has shown that 3,000,000+ cycles can now be achieved using PEMKO's exclusive polyurethane-coated 4, 8, or 12 TRI-FLEX titanium copper alloy cables. Each cable is capable of carrying 7 amps continuous or 16 amps in-rush @ 24 volts in-rush for 820 milliseconds. When ordering, please use the "shorthand code". For example, if you require a Clear Anodized standard Full-Mortise hinge at 83" with Quick Connect transfer - 4-wire, modified 36-1/4" from the top, right hand, you would order a CFM83 with QC4 at 36-1/4" from top - RH.

IMPORTANT NOTE: A 4 amp in-line fuse must be used between the hinge cable and the power supply or warranty will be voided. PEMKO does not include the fuse as it is usually supplied with the power supply.

Transfer For FM Hinges	Transfer For FS and HS Hinges	Transfer For FM Hinges - Accessible	Transfer For FM Hinges Serviceable & Removable	Transfer For DSH Hinges Serviceable & Removable	Serviceable/ Removeable Section for FM Hinges (8" Section Only)*:	Electrical Power Transfer Units
QC4 = 380.00	QC4S = 780.00	ACC4 = 380.00	SER4 = 360.00	SER4 = 780.00	SER4 = 430.00	EL-CEPTx10B = 980.00 ea
QC8 = 510.00	QC8S = 910.00	ACC8 = 510.00	SER8 = 490.00	SER8 = 910.00	SER8 = 560.00	EL-CEPTx32D = 510.00 ea
QC12 = 790.00	QC12S = 1190.00	ACC12 = 790.00	SER12 = 770.00	SER12 = 1150.00	SER12 = 840.00	EL-EPT = 202.00 ea
						EL-EPTL = 262.00 ea
						EL-EPT-SC = 350.00 ea

All prices are shown as List
 Note: QC = Quick Connect

*When ordering, please note model and finish of hinge

Electrical Modifications	Code	List Price
Adj. Concealed Magnetic Monitoring	CM	390.00
Power Transfer - Prep Only	PT	90.00

FirePins For Fire Rated Assemblies

FirePins are required only on 3 Hour (A-Label) assemblies.



Kit Descriptions	Code	List Price
Kit: 4 each FirePins, Zinc Pl clear, for 80" to 95" Hinges	FIREPIN-C4	75.00 kit
Kit: 5 each FirePins, Zinc Pl clear, for 96" to 120" Hinges	FIREPIN-C5	94.00 kit

Hospital Tips

A special modification available for certain hinges which provides an extra bearing at the top of the gear cap, leaving no opening. A 45° angled cut only on the gear cap provides a safe environment for hospitals and correctional facilities.

Kit Descriptions	Code	List Price
Hospital Tip - Standard	HT	90.00

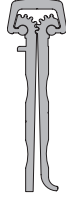
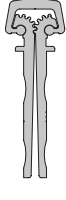
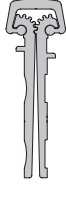
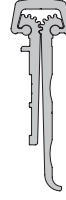
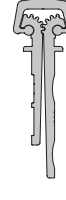
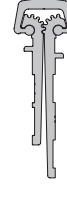
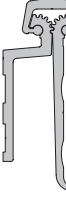
Full Mortise Hinges

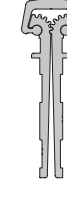
									Prices apply to all nine (9) full mortise hinges shown here.
Standard	Short Leaf Flush	Short Leaf Inset	Special	Special Short Leaf Flush	Special Short Leaf Inset	Safety	Safety Short Leaf Inset	Kawneer	List Price
STANDARD DUTY HINGES with bearing spacing at 6 inch centers									
CFM83	CFM83SLF	CFM83SLI	CSPFM83	CSPFM83SLF	CSPFM83SLI	CFM83SF	CFM83SLISF	KCFM83	150.00 ea
CFM85	CFM85SLF	CFM85SLI	CSPFM85	CSPFM85SLF	CSPFM85SLI	CFM85SF	CFM85SLISF	KCFM85	150.00 ea
CFM95	CFM95SLF	CFM95SLI	CSPFM95	CSPFM95SLF	CSPFM95SLI	CFM95SF	CFM95SLISF	KCFM95	180.00 ea
CFM120	CFM120SLF	CFM120SLI	CSPFM120	CSPFM120SLF	CSPFM120SLI	CFM120SF	CFM120SLISF		265.00 ea
DFM83	DFM83SLF	DFM83SLI	DSPFM83	DSPFM83SLF	DSPFM83SLI	DFM83SF	DFM83SLISF	KDFM83	194.00 ea
DFM85	DFM85SLF	DFM85SLI	DSPFM85	DSPFM85SLF	DSPFM85SLI	DFM85SF	DFM85SLISF	KDFM85	194.00 ea
DFM95	DFM95SLF	DFM95SLI	DSPFM95	DSPFM95SLF	DSPFM95SLI	DFM95SF	DFM95SLISF	KDFM95	233.00 ea
DFM120	DFM120SLF	DFM120SLI	DSPFM120	DSPFM120SLF	DSPFM120SLI	DFM120SF	DFM120SLISF	KDFM120	350.00 ea
GFM83	GFM83SLF	LIMITED	LIMITED	LIMITED	LIMITED	LIMITED	LIMITED	LIMITED	200.00 ea
GFM85	GFM85SLF	LIMITED	LIMITED	LIMITED	LIMITED	LIMITED	LIMITED	LIMITED	200.00 ea
GFM95	GFM95SLF	LIMITED	LIMITED	LIMITED	LIMITED	LIMITED	LIMITED	LIMITED	240.00 ea
GRADE 3 HEAVY DUTY HINGES with bearing spacing at 3 inch centers									
CFM83HD3	CFM83SLF-HD3	CFM83SLI-HD3	CSPFM83HD3	CSPFM83SLF-HD3	CSPFM83SLI-HD3	CFM83SF-HD3	CFM83SLISF-HD3	KCFM83HD3	170.00 ea
CFM95HD3	CFM95SLF-HD3	CFM95SLI-HD3	CSPFM95HD3	CSPFM95SLF-HD3	CSPFM95SLI-HD3	CFM95SF-HD3	CFM95SLISF-HD3	KCFM95HD3	204.00 ea
CFM120HD3	CFM120SLF-HD3	CFM120SLI-HD3	CSPFM120HD3	CSPFM120SLF-HD3	CSPFM120SLI-HD3	CFM120SF-HD3	CFM120SLISF-HD3	KCFM120HD3	300.00 ea
DFM83HD3	DFM83SLF-HD3	DFM83SLI-HD3	DSPFM83HD3	DSPFM83SLF-HD3	DSPFM83SLI-HD3	DFM83SF-HD3	DFM83SLISF-HD3	KDFM83HD3	220.00 ea
DFM95HD3	DFM95SLF-HD3	DFM95SLI-HD3	DSPFM95HD3	DSPFM95SLF-HD3	DSPFM95SLI-HD3	DFM95SF-HD3	DFM95SLISF-HD3	KDFM95HD3	264.00 ea
DFM120HD3	DFM120SLF-HD3	DFM120SLI-HD3	DSPFM120HD3	DSPFM120SLF-HD3	DSPFM120SLI-HD3	DFM120SF-HD3	DFM120SLISF-HD3	KDFM120HD3	400.00 ea
GRADE 1 HEAVY DUTY HINGES with bearing spacing at 3 inch centers									
CFM83HD1	CFM83SLF-HD1	CFM83SLI-HD1	CSPFM83HD1	CSPFM83SLF-HD1	CSPFM83SLI-HD1	CFM83SF-HD1	CFM83SLISF-HD1	KCFM83HD1	185.00 ea
CFM85HD1	CFM85SLF-HD1	CFM85SLI-HD1	CSPFM85HD1	CSPFM85SLF-HD1	CSPFM85SLI-HD1	CFM85SF-HD1	CFM85SLISF-HD1	KCFM85HD1	185.00 ea
CFM95HD1	CFM95SLF-HD1	CFM95SLI-HD1	CSPFM95HD1	CSPFM95SLF-HD1	CSPFM95SLI-HD1	CFM95SF-HD1	CFM95SLISF-HD1	KCFM95HD1	221.00 ea
CFM108HD1	CFM108SLF-HD1	CFM108SLI-HD1	CSPFM108HD1	CSPFM108SLF-HD1	CSPFM108SLI-HD1	CFM108SF-HD1	CFM108SLISF-HD1	KCFM108HD1	333.00 ea
CFM120HD1	CFM120SLF-HD1	CFM120SLI-HD1	CSPFM120HD1	CSPFM120SLF-HD1	CSPFM120SLI-HD1	CFM120SF-HD1	CFM120SLISF-HD1	KCFM120HD1	333.00 ea
DFM83HD1	DFM83SLF-HD1	DFM83SLI-HD1	DSPFM83HD1	DSPFM83SLF-HD1	DSPFM83SLI-HD1	DFM83SF-HD1	DFM83SLISF-HD1	KDFM83HD1	240.00 ea
DFM85HD1	DFM85SLF-HD1	DFM85SLI-HD1	DSPFM85HD1	DSPFM85SLF-HD1	DSPFM85SLI-HD1	DFM85SF-HD1	DFM85SLISF-HD1	KDFM85HD1	240.00 ea
DFM95HD1	DFM95SLF-HD1	DFM95SLI-HD1	DSPFM95HD1	DSPFM95SLF-HD1	DSPFM95SLI-HD1	DFM95SF-HD1	DFM95SLISF-HD1	KDFM95HD1	287.00 ea
DFM108HD1	DFM108SLF-HD1	DFM108SLI-HD1	DSPFM108HD1	DSPFM108SLF-HD1	DSPFM108SLI-HD1	DFM108SF-HD1	DFM108SLISF-HD1	KDFM108HD1	450.00 ea
DFM120HD1	DFM120SLF-HD1	DFM120SLI-HD1	DSPFM120HD1	DSPFM120SLF-HD1	DSPFM120SLI-HD1	DFM120SF-HD1	DFM120SLISF-HD1	KDFM120HD1	450.00 ea
GFM83HD1	GFM83SLF-HD1	GFM83SLI-HD1	LIMITED	LIMITED	LIMITED	LIMITED	LIMITED	LIMITED	244.00 ea
GFM85HD1	GFM85SLF-HD1	GFM85SLI-HD1	LIMITED	LIMITED	LIMITED	LIMITED	LIMITED	LIMITED	244.00 ea
GFM95HD1	GFM95SLF-HD1	GFM95SLI-HD1	LIMITED	LIMITED	LIMITED	LIMITED	LIMITED	LIMITED	293.00 ea
GFM120HD1	GFM120SLF-HD1	GFM120SLI-HD1	LIMITED	LIMITED	LIMITED	LIMITED	LIMITED	LIMITED	465.00 ea
SNFM83HD1	SNFM83SLF-HD1	LIMITED	LIMITED	LIMITED	LIMITED	LIMITED	LIMITED	LIMITED	280.00 ea
SNFM85HD1	SNFM85SLF-HD1	LIMITED	LIMITED	LIMITED	LIMITED	LIMITED	LIMITED	LIMITED	280.00 ea
SNFM95HD1	SNFM95SLF-HD1	SNFM95SLI-HD1	LIMITED	LIMITED	LIMITED	LIMITED	LIMITED	LIMITED	340.00 ea
GRADE 1 HEAVY DUTY HINGES with bearing spacing at 1-1/2 inch centers									
LIMITED	CFM83SLF-1100	CFM83SLI-1100	LIMITED	LIMITED	LIMITED	LIMITED	LIMITED	LIMITED	235.00 ea
LIMITED	CFM95SLF-1100	CFM95SLI-1100	LIMITED	LIMITED	LIMITED	LIMITED	LIMITED	LIMITED	280.00 ea
LIMITED	CFM108SLF-1100	CFM108SLI-1100	LIMITED	LIMITED	LIMITED	LIMITED	LIMITED	LIMITED	420.00 ea
LIMITED	CFM120SLF-1100	CFM120SLI-1100	LIMITED	LIMITED	LIMITED	LIMITED	LIMITED	LIMITED	420.00 ea



NOTE:

- Products listed as "LIMITED" may not be available for immediate shipment and may require 6 weeks lead time. Please check with PEMKO's customer service for availability.
- Hinges may be supplied with PAINTED WHITE CAPS (PWC-OPTION) for a NET up charge as follows; \$18.00 - 83" & 85" / \$20.00 - 95" / \$30.00 - 120".
- BLACK ANODIZED FINISH (BL) is available for a 20% NET add over Dark Bronze Anodize in most models for immediate shipment.
- PEMKO will substitute HD3 or HD1 models at no additional up charge if the Standard Model is not available.

Full Surface

Half Surface

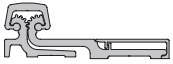
Half Mortise

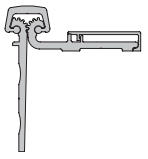
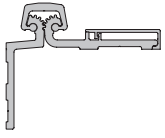
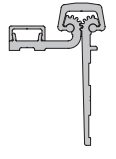
					Prices apply to full surface, half surface and half mortise hinges shown here.
Full Surface	Full Surface Center Pivot	Half Surface	Half Surface Safety	Half Mortise	
STANDARD DUTY HINGES with bearing spacing at 6 inch centers					
CFS83	CFS83CP	CHS83	CHS83SF	CHM83	221.00 ea
CFS85	CFS85CP	CHS85	CHS85SF	CHM85	221.00 ea
CFS95	CFS95CP	CHS95	CHS95SF	CHM95	265.00 ea
CFS120	CFS120CP	CHS120	CHS120SF	CHM120	393.00 ea
DFS83	DFS83CP	DHS83	DHS83SF	DHM83	286.00 ea
DFS85	DFS85CP	DHS85	DHS85SF	DHM85	286.00 ea
DFS95	DFS95CP	DHS95	DHS95SF	DHM95	342.00 ea
DFS120	DFS120CP	DHS120	DHS120SF	DHM120	518.00 ea
GRADE 3 HEAVY DUTY HINGES with bearing spacing at 3 inch centers					
CFS83HD3	CFS83CP-HD3	CHS83HD3	CHS83SF-HD3	CHM83HD3	250.00 ea
CFS95HD3	CFS95CP-HD3	CHS95HD3	CHS95SF-HD3	CHM95HD3	300.00 ea
DFS83HD3	DFS83CP-HD3	DHS83HD3	DHS83SF-HD3	DHM83HD3	325.00 ea
DFS95HD3	DFS95CP-HD3	DHS95HD3	DHS95SF-HD3	DHM95HD3	390.00 ea
GRADE 1 HEAVY DUTY HINGES with bearing spacing at 3 inch centers					
CFS83HD1	CFS83CP-HD1	CHS83HD1	CHS83SF-HD1	CHM83HD1	276.00 ea
CFS85HD1	CFS85CP-HD1	CHS85HD1	CHS85SF-HD1	CHM85HD1	276.00 ea
CFS95HD1	CFS95CP-HD1	CHS95HD1	CHS95SF-HD1	CHM95HD1	330.00 ea
CFS120HD1	CFS120CP-HD1	CHS120HD1	CHS120SF-HD1	CHM120HD1	498.00 ea
DFS83HD1	DFS83CP-HD1	DHS83HD1	DHS83SF-HD1	DHM83HD1	356.00 ea
DFS85HD1	DFS85CP-HD1	DHS85HD1	DHS85SF-HD1	DHM85HD1	356.00 ea
DFS95HD1	DFS95CP-HD1	DHS95HD1	DHS95SF-HD1	DHM95HD1	428.00 ea
DFS120HD1	DFS120CP-HD1	DHS120HD1	DHS120SF-HD1	DHM120HD1	660.00 ea
GFS83HD1	GFS83CP-HD1	GHS83HD1	LIMITED	LIMITED	360.00 ea
GFS85HD1	GFS85CP-HD1	GHS85HD1	LIMITED	LIMITED	360.00 ea
GFS95HD1	LIMITED	GHS95HD1	LIMITED	LIMITED	430.00 ea

Offset

Full Surface Balance Pivot

Full Mortise

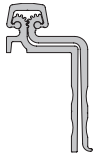
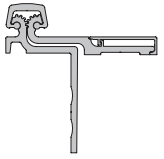
		Prices apply to full mortise & half surface hinges shown
Offset Full Mortise	Offset Half Surface	
COS83FM-HD1	COS83HS-HD1	342.00 ea
COS85FM-HD1	COS85HS-HD1	342.00 ea
COS95FM-HD1	COS95HS-HD1	410.00 ea
COS120FM-HD1	COS120HS-HD1	620.00 ea
DOS83FM-HD1	DOS83HS-HD1	446.00 ea
DOS85FM-HD1	DOS85HS-HD1	446.00 ea
DOS95FM-HD1	DOS95HS-HD1	530.00 ea
DOS120FM-HD1	DOS120HS-HD1	800.00 ea

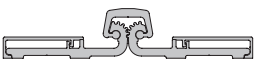
	
Balanced Pivot	List Price
CFS83BP-HD1	290.00 ea
CFS85BP-HD1	290.00 ea
CFS95BP-HD1	348.00 ea
CFS120BP-HD1	520.00 ea
DFS83BP-HD1	378.00 ea
DFS85BP-HD1	378.00 ea
DFS95BP-HD1	450.00 ea
DFS120BP-HD1	670.00 ea

	
Short Leaf Offset	List Price
CFM83SLO-HD1	186.00 ea
CFM85SLO-HD1	186.00 ea
CFM95SLO-HD1	223.00 ea
CFM120SLO-HD1	333.00 ea
DFM83SLO-HD1	242.00 ea
DFM85SLO-HD1	242.00 ea
DFM95SLO-HD1	288.00 ea
DFM120SLO-HD1	448.00 ea

NOTE:

- Products listed as "LIMITED" may not be available for immediate shipment and may require 6 weeks lead time. Please check with PEMKO's customer service for availability.
- Hinges may be supplied with PAINTED WHITE CAPS (PWC-OPTION) for a NET up charge as follows; \$18.00 - 83" & 85" / \$20.00 - 95" / \$30.00 - 120".
- BLACK ANODIZED FINISH (BL) is available for a 20% NET add over Dark Bronze Anodize in most models for immediate shipment.
- PEMKO will substitute HD3 or HD1 models at no additional up charge if the Standard Model is not available.

Full Mortise Residential Hinges

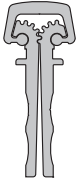
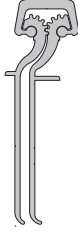
		Prices apply to all full mortise residential hinges shown here.
(FM) Residential (1-3/8" Doors)	(FM) Residential (1-3/4" Doors)	
List Price	List Price	
CRS138-79	CRS175-79	148.00 ea
DRS138-79	DRS175-79	182.00 ea
GRS138-79	GRS175-79	166.00 ea
CRS138-83	CRS175-83	148.00 ea
DRS138-83	DRS175-83	182.00 ea
GRS138-83	GRS175-83	166.00 ea

Full Mortise Raised Gear

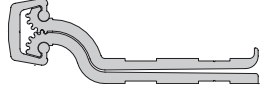
	
Raised Gear	List Price
Standard Duty	
CFM83RG	170.00 ea
CFM85RG	170.00 ea
CFM95RG	203.00 ea
CFM120RG	302.00 ea
DFM83RG	220.00 ea
DFM85RG	220.00 ea
DFM95RG	263.00 ea
DFM120RG	392.00 ea
Grade 1 Heavy Duty	
CFM83RG-HD1	215.00 ea
CFM85RG-HD1	215.00 ea
CFM95RG-HD1	258.00 ea
CFM120RG-HD1	380.00 ea
DFM83RG-HD1	276.00 ea
DFM85RG-HD1	276.00 ea
DFM95RG-HD1	330.00 ea
DFM120RG-HD1	510.00 ea

Wide Throw Full Mortise

	
Wide Throw Full Mortise	List Price
WTCFM83HD1	328.00 ea
WTCFM95HD1	390.00 ea
WTCFM120HD1	660.00 ea
WTDFM83HD1	428.00 ea
WTDFM95HD1	500.00 ea
WTDFM120HD1	860.00 ea
WTGFM83HD1	430.00 ea
WTGFM95HD1	500.00 ea

Wide Throw Half Surface

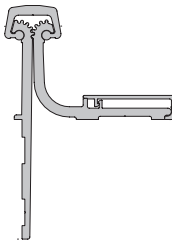
	
Wide Throw Half Surface	List Price
WTCHS83HD1	448.00 ea
WTCHS95HD1	548.00 ea
WTDHS83HD1	570.00 ea
WTDHS95HD1	684.00 ea

Full Mortise Short Leaf Flush for 1-3/8" Commercial Door

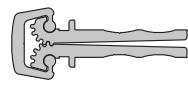
	
Short Leaf Flush	List Price
CFM83SLF138	150.00 ea
CFM85SLF138	150.00 ea
CFM95SLF138	180.00 ea
DFM83SLF138	192.00 ea
DFM85SLF138	192.00 ea
DFM95SLF138	230.00 ea

NOTE:

- Hinges may be supplied with PAINTED WHITE CAPS (PWC-OPTION) for a NET up charge as follows; \$18.00 - 83" & 85" / \$20.00 - 95" / \$30.00 - 120".
- BLACK ANODIZED FINISH (BL) is available for a 20% NET add over Dark Bronze Anodize in most models for immediate shipment.
- PEMKO will substitute HD3 or HD1 models at no additional up charge if the Standard Model is not available.

Behavioral Health Hinges

Standard finish is Clear Anodized Aluminum. Dark Bronze hinges are available upon request; contact the factory for a quote.

Emergency Release Stop for use with 3-3/4" min. backset

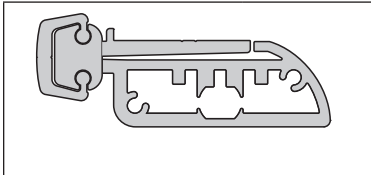

Emergency Release Stop	List Price
ERS84CxHT-LH	860.00 ea
ERS84CxHT-RH	860.00 ea
ERS96CxHT-LH	1,030.00 ea
ERS96CxHT-RH	1,030.00 ea
ERS120CxHT-RH	1,540.00 ea
ERS120CxHT-LH	1,540.00 ea

*Order form required

Emergency Release Stop (with NOTCH*) for use with 2-3/4" min. backset

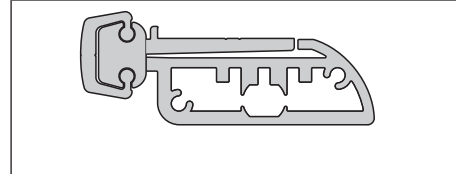

Emergency Release Stop with NPL	List Price
ERS84C-NOTCHxHT-LH	1,140.00 ea
ERS84C-NOTCHxHT-RH	1,140.00 ea
ERS96C-NOTCHxHT-LH	1,310.00 ea
ERS96C-NOTCHxHT-RH	1,310.00 ea
ERS120C-NOTCHxHT-LH	1,820.00 ea
ERS120C-NOTCHxHT-RH	1,820.00 ea

*Order form required

Double Swing Hinge

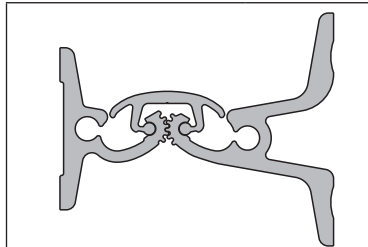

Double Swing Hinge	List Price
DSHP01C-84	740.00 ea
DSHP01C-96	888.00 ea
DSHP01C-120	1,320.00 ea

X-Series Hinges

Full Mortise

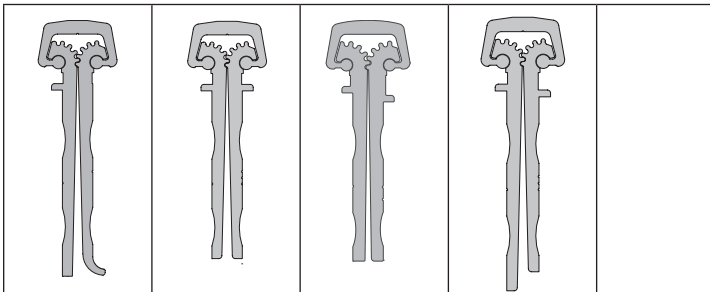

Standard	Short Leaf Flush	Short Leaf Inset	Special Inset	List Price
XM83C	XF83C	XI83C	XL83C	220.00 ea
XM85C	XF85C	XI85C	XL85C	220.00 ea
XM95C	XF95C	XI95C	XL95C	263.00 ea
XM120C	XF120C	XI120C	XL120C	398.00 ea
XM83D	XF83D	XI83D	XL83D	276.00 ea
XM85D	XF85D	XI85D	XL85D	276.00 ea
XM95D	XF95D	XI95D	XL95D	330.00 ea
XM120D	XF120D	XI120D	XL120D	498.00 ea

Full Mortise For 2-1/2" Doors

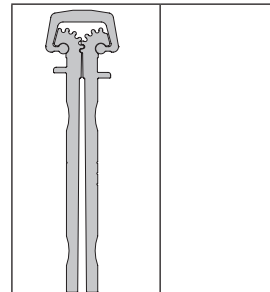

1/16" Inset	List Price
X25M84C-1100	680.00 ea
X25M96C-1100	810.00 ea
X25M120C-1100	1,230.00 ea
X25M84D-1100	880.00 ea
X25M96D-1100	1,050.00 ea
X25M120D-1100	1,590.00 ea

Components - Prices are List

Part Number	Width	Material Price/Ft.	Pemkote Price/Ft.	Combo Price/Ft.	Combo Price/In.	36"	48"	60"	72"	84"	96"
RR1	5-5/8"	\$36.89		\$36.89		\$110.67	\$147.56	\$184.45	\$221.34	\$258.23	\$295.12
RR2	6-3/8"	\$90.31		\$90.31		\$270.93	\$361.24	\$451.55	\$541.86	\$632.17	\$722.48
RAMP1A	7"	\$20.86		\$20.86	\$1.74	\$62.58	\$83.44	\$104.30	\$125.16	\$146.02	\$166.88
RAMP1AK	7"	\$20.86	\$23.66	\$44.52	\$3.71	\$133.56	\$178.08	\$222.60	\$267.12	\$311.64	\$356.16
RAMP2A	10"	\$36.25		\$36.25	\$3.02	\$108.75	\$145.00	\$181.25	\$217.50	\$253.75	\$290.00
RAMP2AK	10"	\$36.25	\$40.25	\$76.50	\$6.38	\$229.50	\$306.00	\$382.50	\$459.00	\$535.50	\$612.00
RAMP3A	6-1/8"	\$15.39		\$15.39	\$1.28	\$46.17	\$61.56	\$76.95	\$92.34	\$107.73	\$123.12
RAMP3AK	6-1/8"	\$15.39	\$18.19	\$33.58	\$2.80	\$100.74	\$134.32	\$167.90	\$201.48	\$235.06	\$268.64
RAMP4A	3-1/8"	\$10.94		\$10.94	\$0.91	\$32.82	\$43.76	\$54.70	\$65.64	\$76.58	\$87.52
RAMP4AK	3-1/8"	\$10.94	\$12.54	\$23.48	\$1.96	\$70.44	\$93.92	\$117.40	\$140.88	\$164.36	\$187.84
RAMP5A	6-1/4"	\$20.35		\$20.35	\$1.70	\$61.05	\$81.40	\$101.75	\$122.10	\$142.45	\$162.80
RAMP5AK	6-1/4"	\$20.35	\$23.15	\$43.50	\$3.63	\$130.50	\$174.00	\$217.50	\$261.00	\$304.50	\$348.00
RAMP6A	3-1/8"	\$14.37		\$14.37	\$1.20	\$43.11	\$57.48	\$71.85	\$86.22	\$100.59	\$114.96
RAMP6AK	3-1/8"	\$14.37	\$15.97	\$30.34	\$2.53	\$91.02	\$121.36	\$151.70	\$182.04	\$212.38	\$242.72
RAMP7A	1-15/16"	\$8.40		\$8.40	\$0.70	\$25.20	\$33.60	\$42.00	\$50.40	\$58.80	\$67.20
RAMP7AK	1-15/16"	\$8.40	\$9.20	\$17.60	\$1.47	\$52.80	\$70.40	\$88.00	\$105.60	\$123.20	\$140.80
RAMP8A	3-1/2"	\$13.10		\$13.10	\$1.09	\$39.30	\$52.40	\$65.50	\$78.60	\$91.70	\$104.80
RAMP8AK	3-1/2"	\$13.10	\$14.70	\$27.80	\$2.32	\$83.40	\$111.20	\$139.00	\$166.80	\$194.60	\$222.40
RAMP9A	6-1/4"	\$24.17		\$24.17	\$2.01	\$72.51	\$96.68	\$120.85	\$145.02	\$169.19	\$193.36
RAMP9AK	6-1/4"	\$24.17	\$26.97	\$51.14	\$4.26	\$153.42	\$204.56	\$255.70	\$306.84	\$357.98	\$409.12
RAMP10A	3-1/8"	\$17.30		\$17.30	\$1.44	\$51.90	\$69.20	\$86.50	\$103.80	\$121.10	\$138.40
RAMP10AK	3-1/8"	\$17.30	\$18.90	\$36.20	\$3.02	\$108.60	\$144.80	\$181.00	\$217.20	\$253.40	\$289.60
RAMP11A	6-1/4"	\$26.71		\$26.71	\$2.23	\$80.13	\$106.84	\$133.55	\$160.26	\$186.97	\$213.68
RAMP11AK	6-1/4"	\$26.71	\$29.51	\$56.22	\$4.69	\$168.66	\$224.88	\$281.10	\$337.32	\$393.54	\$449.76
RAMP12A	3-1/8"	\$19.59		\$19.59	\$1.63	\$58.77	\$78.36	\$97.95	\$117.54	\$137.13	\$156.72
RAMP12AK	3-1/8"	\$19.59	\$21.19	\$40.78	\$3.40	\$122.34	\$163.12	\$203.90	\$244.68	\$285.46	\$326.24
RAMP13A	3-1/8"	\$7.00		\$7.00	\$0.58	-	-	-	-	-	-
RAMP14A	6-1/4"	\$11.19		\$11.19	\$0.93	-	-	-	-	-	-

Miter Returns

Generally sold in pairs (i.e. 1 ea. WING10LH + 1 ea. WING10RH = 1 pair). Part numbers with "MR" include 1 pair of miter returns, & (where applicable) 1 pair of miter return extenders (i.e. WING EXT's).

Part Number	Length	List Price/ea	List Price/pair
RR12LH	12"	\$38.25	\$76.50
RR12RH	12"		
WING10LH	10"	\$68.50	\$137.00
WING10RH	10"		
WING10LH(AK)	10"	\$76.50	\$153.00
WING10RH(AK)	10"		
WING16LH	16"	\$110.25	\$220.50
WING16RH	16"		
WING16LH(AK)	16"	\$122.00	\$244.00
WING16RH(AK)	16"		
WING EXT LH	12"	\$113.50	\$227.00
WING EXT RH	12"		
WING EXT LH(AK)	12"	\$123.00	\$246.00
WING EXT RH(AK)	12"		

Special Order Fasteners

Assemblies are supplied with #10 stainless steel wood screws. Stainless steel machine screws and expansion shields (SS/MS&ES10 or SS/MS&ES25) or flat head sleeve anchors (FHSL25) are available at an extra cost.

Assemblies which are 7" or wider require more than 1 row of fasteners. Therefore, fastener prices double, triple, quadruple, etc. depending upon the number of rows of fasteners across the width of a given assembly. A list of fastener options are shown on page 4 of this price list. The following chart shows SS/MS&ES25:

Threshold Width	# of Fastener Rows	List Price Add
2" to 6-7/8"	1 Row	1.68 / ft
7" to 12-7/8"	2 Rows	3.36 / ft
13" to 18-7/8"	3 Rows	5.04 / ft
19" to 24-7/8"	4 Rows	6.72 / ft
25" to 30-7/8"	5 Rows	8.40 / ft
31" to 36-7/8"	6 Rows	10.04 / ft

Therefore, the List Price Adder for SS/MS&ES25 for a R1.75OSSA36 is: **\$8.40** (5 rows at \$1.68 / ft) x 3 (3 feet) = **\$25.20**

Assemblies - Prices are List

Part Number	Width	Material Price/Ft.	Pemkote Price/Ft.	Combo Price/Ft.	Miter Price/Pair	36"	48"	60"	72"	84"	96"
SBR.5F	5-5/8"	\$36.89		\$36.89		\$110.67	\$147.56	\$184.45	\$221.34	\$258.23	\$295.12
SBR.5FMR	5-5/8"	\$36.89		\$36.89	\$72.00	\$182.67	\$219.56	\$256.45	\$293.34	\$330.23	\$367.12
SBR1F	11-5/8"	\$127.20		\$127.20		\$381.60	\$508.80	\$636.00	\$763.20	\$890.40	\$1,017.60
SBR1FMR	11-5/8"	\$127.20		\$127.20	\$72.00	\$453.60	\$580.80	\$708.00	\$835.20	\$962.40	\$1,089.60
RR1.25FMR	12"			\$52.80		\$158.40	\$211.20	\$264.00	\$316.80	\$369.60	\$422.40
R.25OSA	13-1/8"	\$36.25		\$36.25		\$108.75	\$145.00	\$181.25	\$217.50	\$253.75	\$290.00
R.25OSMRA	13-1/8"	\$36.25		\$36.25	\$129.00	\$237.75	\$274.00	\$310.25	\$346.50	\$382.75	\$419.00
R.25OSMRAK	13-1/8"	\$36.25	\$41.85	\$78.10	\$144.00	\$378.30	\$456.40	\$534.50	\$612.60	\$690.70	\$768.80
R.25OSSA	9-5/8"	\$28.49		\$28.49		\$85.47	\$113.96	\$142.45	\$170.94	\$199.43	\$227.92
R.25OSSAK	9-5/8"	\$28.49	\$32.89	\$61.38		\$184.14	\$245.52	\$306.90	\$368.28	\$429.66	\$491.04
R.25OSSMRA	9-5/8"	\$28.49		\$28.49	\$129.00	\$214.47	\$242.96	\$271.45	\$299.94	\$328.43	\$356.92
R.25OSSMRAK	9-5/8"	\$28.49	\$32.89	\$61.38	\$144.00	\$328.14	\$389.52	\$450.90	\$512.28	\$573.66	\$635.04
R.5FA	6-1/8"	\$15.39		\$15.39		\$46.17	\$61.56	\$76.95	\$92.34	\$107.73	\$123.12
R.5FAK	6-1/8"	\$15.39	\$18.19	\$33.58		\$100.74	\$134.32	\$167.90	\$201.48	\$235.06	\$268.64
R.5FMRA	6-1/8"	\$15.39		\$15.39	\$129.00	\$175.17	\$190.56	\$205.95	\$221.34	\$236.73	\$252.12
R.5FMRAK	6-1/8"	\$15.39	\$18.19	\$33.58	\$144.00	\$244.74	\$278.32	\$311.90	\$345.48	\$379.06	\$412.64
R.5OSA	16-1/4"	\$47.19		\$47.19		\$141.57	\$188.76	\$235.95	\$283.14	\$330.33	\$377.52
R.5OSAK	16-1/4"	\$47.19	\$54.39	\$101.58		\$304.74	\$406.32	\$507.90	\$609.48	\$711.06	\$812.64
R.5OSMRA	16-1/4"	\$47.19		\$47.19	\$129.00	\$270.57	\$317.76	\$364.95	\$412.14	\$459.33	\$506.52
R.5OSMRAK	16-1/4"	\$47.19	\$54.39	\$101.58	\$144.00	\$448.74	\$550.32	\$651.90	\$753.48	\$855.06	\$956.64
R.5OSSA	12-3/4"	\$39.43		\$39.43		\$118.29	\$157.72	\$197.15	\$236.58	\$276.01	\$315.44
R.5OSSAK	12-3/4"	\$39.43	\$45.43	\$84.86		\$254.58	\$339.44	\$424.30	\$509.16	\$594.02	\$678.88
R.5OSSMRA	12-3/4"	\$39.43		\$39.43	\$129.00	\$247.29	\$286.72	\$326.15	\$365.58	\$405.01	\$444.44
R.5OSSMRAK	12-3/4"	\$39.43	\$45.43	\$84.86	\$144.00	\$398.58	\$483.44	\$568.30	\$653.16	\$738.02	\$822.88
R.75FA	9-1/4"	\$26.33		\$26.33		\$78.99	\$105.32	\$131.65	\$157.98	\$184.31	\$210.64
R.75FAK	9-1/4"	\$26.33	\$30.73	\$57.06		\$171.18	\$228.24	\$285.30	\$342.36	\$399.42	\$456.48
R.75FMRA	9-1/4"	\$26.33		\$26.33	\$129.00	\$207.99	\$234.32	\$260.65	\$286.98	\$313.31	\$339.64
R.75FMRAK	9-1/4"	\$26.33	\$30.73	\$57.06	\$144.00	\$315.18	\$372.24	\$429.30	\$486.36	\$543.42	\$600.48
R.75OSA	19-3/8"	\$56.60		\$56.60		\$169.80	\$226.40	\$283.00	\$339.60	\$396.20	\$452.80
R.75OSAK	19-3/8"	\$56.60	\$65.00	\$121.60		\$364.80	\$486.40	\$608.00	\$729.60	\$851.20	\$972.80
R.75OSMRA	19-3/8"	\$56.60		\$56.60	\$208.00	\$377.80	\$434.40	\$491.00	\$547.60	\$604.20	\$660.80
R.75OSMRAK	19-3/8"	\$56.60	\$65.00	\$121.60	\$230.00	\$594.80	\$716.40	\$838.00	\$959.60	\$1,081.20	\$1,202.80
R.75OSSA	15-7/8"	\$48.84		\$48.84		\$146.52	\$195.36	\$244.20	\$293.04	\$341.88	\$390.72
R.75OSSAK	15-7/8"	\$48.84	\$56.04	\$104.88		\$314.64	\$419.52	\$524.40	\$629.28	\$734.16	\$839.04
R.75OSSMRA	15-7/8"	\$48.84		\$48.84	\$208.00	\$354.52	\$403.36	\$452.20	\$501.04	\$549.88	\$598.72
R.75OSSMRAK	15-7/8"	\$48.84	\$56.04	\$104.88	\$230.00	\$544.64	\$649.52	\$754.40	\$859.28	\$964.16	\$1,069.04
R1FA	12-3/8"	\$35.74		\$35.74		\$107.22	\$142.96	\$178.70	\$214.44	\$250.18	\$285.92
R1FAK	12-3/8"	\$35.74	\$41.34	\$77.08		\$231.24	\$308.32	\$385.40	\$462.48	\$539.56	\$616.64
R1FMRA	12-3/8"	\$35.74		\$35.74	\$208.00	\$315.22	\$350.96	\$386.70	\$422.44	\$458.18	\$493.92
R1FMRAK	12-3/8"	\$35.74	\$41.34	\$77.08	\$230.00	\$461.24	\$538.32	\$615.40	\$692.48	\$769.56	\$846.64
R1OSA	22-1/2"	\$70.97		\$70.97		\$212.91	\$283.88	\$354.85	\$425.82	\$496.79	\$567.76
R1OSAK	22-1/2"	\$70.97	\$80.97	\$151.94		\$455.82	\$607.76	\$759.70	\$911.64	\$1,063.58	\$1,215.52
R1OSMRA	22-1/2"	\$70.97		\$70.97	\$208.00	\$420.91	\$491.88	\$562.85	\$633.82	\$704.79	\$775.76
R1OSMRAK	22-1/2"	\$70.97	\$80.97	\$151.94	\$230.00	\$685.82	\$837.76	\$989.70	\$1,141.64	\$1,293.58	\$1,445.52
R1OSSA	19"	\$63.21		\$63.21		\$189.63	\$252.84	\$316.05	\$379.26	\$442.47	\$505.68
R1OSSAK	19"	\$63.21	\$72.01	\$135.22		\$405.66	\$540.88	\$676.10	\$811.32	\$946.54	\$1,081.76
R1OSSMRA	19"	\$63.21		\$63.21	\$208.00	\$397.63	\$460.84	\$524.05	\$587.26	\$650.47	\$713.68
R1OSSMRAK	19"	\$63.21	\$72.01	\$135.22	\$230.00	\$635.66	\$770.88	\$906.10	\$1,041.32	\$1,176.54	\$1,311.76
R1.25FA	15-1/2"	\$50.11		\$50.11		\$150.33	\$200.44	\$250.55	\$300.66	\$350.77	\$400.88
R1.25FAK	15-1/2"	\$50.11	\$57.31	\$107.42		\$322.26	\$429.68	\$537.10	\$644.52	\$751.94	\$859.36
R1.25FMRA	15-1/2"	\$50.11		\$50.11	\$208.00	\$358.33	\$408.44	\$458.55	\$508.66	\$558.77	\$608.88
R1.25FMRAK	15-1/2"	\$50.11	\$57.31	\$107.42	\$230.00	\$552.26	\$659.68	\$767.10	\$874.52	\$981.94	\$1,089.36
R1.25OSA	25-5/8"	\$80.77		\$80.77		\$242.31	\$323.08	\$403.85	\$484.62	\$565.39	\$646.16
R1.25OSAK	25-5/8"	\$80.77	\$91.97	\$172.74		\$518.22	\$690.96	\$863.70	\$1,036.44	\$1,209.18	\$1,381.92

Assemblies - Prices are List

Part Number	Width	Material Price/Ft.	Pemkote Price/Ft.	Combo Price/Ft.	Miter Price/Pair	36"	48"	60"	72"	84"	96"
R1.25OSMRA	25-5/8"	\$80.77		\$80.77	\$422.00	\$664.31	\$745.08	\$825.85	\$906.62	\$987.39	\$1,068.16
R1.25OSMRAK	25-5/8"	\$80.77	\$91.97	\$172.74	\$462.00	\$980.22	\$1,152.96	\$1,325.70	\$1,498.44	\$1,671.18	\$1,843.92
R1.25OSSA	22-1/8"	\$73.01		\$73.01		\$219.03	\$292.04	\$365.05	\$438.06	\$511.07	\$584.08
R1.25OSSAK	22-1/8"	\$73.01	\$83.01	\$156.02		\$468.06	\$624.08	\$780.10	\$936.12	\$1,092.14	\$1,248.16
R1.25OSSMRA	22-1/8"	\$73.01		\$73.01	\$422.00	\$641.03	\$714.04	\$787.05	\$860.06	\$933.07	\$1,006.08
R1.25OSSMRAK	22-1/8"	\$73.01	\$83.01	\$156.02	\$462.00	\$930.06	\$1,086.08	\$1,242.10	\$1,398.12	\$1,554.14	\$1,710.16
R1.5FA	18-5/8"	\$59.91		\$59.91		\$179.73	\$239.64	\$299.55	\$359.46	\$419.37	\$479.28
R1.5FAK	18-5/8"	\$59.91	\$68.31	\$128.22		\$384.66	\$512.88	\$641.10	\$769.32	\$897.54	\$1,025.76
R1.5FMRA	18-5/8"	\$59.91		\$59.91	\$422.00	\$601.73	\$661.64	\$721.55	\$781.46	\$841.37	\$901.28
R1.5FMRAK	18-5/8"	\$59.91	\$68.31	\$128.22	\$462.00	\$846.66	\$974.88	\$1,103.10	\$1,231.32	\$1,359.54	\$1,487.76
R1.5OSA	28-3/4"	\$98.07		\$98.07		\$294.21	\$392.28	\$490.35	\$588.42	\$686.49	\$784.56
R1.5OSAK	28-3/4"	\$98.07	\$110.87	\$208.94		\$626.82	\$835.76	\$1,044.70	\$1,253.64	\$1,462.58	\$1,671.52
R1.5OSMRA	28-3/4"	\$98.07		\$98.07	\$422.00	\$716.21	\$814.28	\$912.35	\$1,010.42	\$1,108.49	\$1,206.56
R1.5OSMRAK	28-3/4"	\$98.07	\$110.87	\$208.94	\$462.00	\$1,088.82	\$1,297.76	\$1,506.70	\$1,715.64	\$1,924.58	\$2,133.52
R1.5OSSA	25-1/4"	\$90.31		\$90.31		\$270.93	\$361.24	\$451.55	\$541.86	\$632.17	\$722.48
R1.5OSSAK	25-1/4"	\$90.31	\$101.91	\$192.22		\$576.66	\$768.88	\$961.10	\$1,153.32	\$1,345.54	\$1,537.76
R1.5OSSMRA	25-1/4"	\$90.31		\$90.31	\$422.00	\$692.93	\$783.24	\$873.55	\$963.86	\$1,054.17	\$1,144.48
R1.5OSSMRAK	25-1/4"	\$90.31	\$101.91	\$192.22	\$462.00	\$1,038.66	\$1,230.88	\$1,423.10	\$1,615.32	\$1,807.54	\$1,999.76
R1.75FA	21-3/4"	\$77.21		\$77.21		\$231.63	\$308.84	\$386.05	\$463.26	\$540.47	\$617.68
R1.75FAK	21-3/4"	\$77.21	\$87.21	\$164.42		\$493.26	\$657.68	\$822.10	\$986.52	\$1,150.94	\$1,315.36
R1.75FMRA	21-3/4"	\$77.21		\$77.21	\$422.00	\$653.63	\$730.84	\$808.05	\$885.26	\$962.47	\$1,039.68
R1.75FMRAK	21-3/4"	\$77.21	\$87.21	\$164.42	\$462.00	\$955.26	\$1,119.68	\$1,284.10	\$1,448.52	\$1,612.94	\$1,777.36
R1.75OSA	31-7/8"	\$107.48		\$107.48		\$322.44	\$429.92	\$537.40	\$644.88	\$752.36	\$859.84
R1.75OSAK	31-7/8"	\$107.48	\$121.48	\$228.96		\$686.88	\$915.84	\$1,144.80	\$1,373.76	\$1,602.72	\$1,831.68
R1.75OSMRA	31-7/8"	\$107.48		\$107.48	\$422.00	\$744.44	\$851.92	\$959.40	\$1,066.88	\$1,174.36	\$1,281.84
R1.75OSMRAK	31-7/8"	\$107.48	\$121.48	\$228.96	\$462.00	\$1,148.88	\$1,377.84	\$1,606.80	\$1,835.76	\$2,064.72	\$2,293.68
R1.75OSSA	28-3/8"	\$99.72		\$99.72		\$299.16	\$398.88	\$498.60	\$598.32	\$698.04	\$797.76
R1.75OSSAK	28-3/8"	\$99.72	\$112.52	\$212.24		\$636.72	\$848.96	\$1,061.20	\$1,273.44	\$1,485.68	\$1,697.92
R1.75OSSMRA	28-3/8"	\$99.72		\$99.72	\$422.00	\$721.16	\$820.88	\$920.60	\$1,020.32	\$1,120.04	\$1,219.76
R1.75OSSMRAK	28-3/8"	\$99.72	\$112.52	\$212.24	\$462.00	\$1,098.72	\$1,310.96	\$1,523.20	\$1,735.44	\$1,947.68	\$2,159.92
R2FA	24-7/8"	\$86.62		\$86.62		\$259.86	\$346.48	\$433.10	\$519.72	\$606.34	\$692.96
R2FAK	24-7/8"	\$86.62	\$97.82	\$184.44		\$553.32	\$737.76	\$922.20	\$1,106.64	\$1,291.08	\$1,475.52
R2FMRA	24-7/8"	\$86.62		\$86.62	\$422.00	\$681.86	\$768.48	\$855.10	\$941.72	\$1,028.34	\$1,114.96
R2FMRAK	24-7/8"	\$86.62	\$97.82	\$184.44	\$462.00	\$1,015.32	\$1,199.76	\$1,384.20	\$1,568.64	\$1,753.08	\$1,937.52
R2OSA	35"	\$127.07		\$127.07		\$381.21	\$508.28	\$635.35	\$762.42	\$889.49	\$1,016.56
R2OSAK	35"	\$127.07	\$142.67	\$269.74		\$809.22	\$1,078.96	\$1,348.70	\$1,618.44	\$1,888.18	\$2,157.92
R2OSMRA	35"	\$127.07		\$127.07	\$422.00	\$803.21	\$930.28	\$1,057.35	\$1,184.42	\$1,311.49	\$1,438.56
R2OSMRAK	35"	\$127.07	\$142.67	\$269.74	\$462.00	\$1,271.22	\$1,540.96	\$1,810.70	\$2,080.44	\$2,350.18	\$2,619.92
R2OSSA	31-1/2"	\$119.31		\$119.31		\$357.93	\$477.24	\$596.55	\$715.86	\$835.17	\$954.48
R2OSSAK	31-1/2"	\$119.31	\$133.71	\$253.02		\$759.06	\$1,012.08	\$1,265.10	\$1,518.12	\$1,771.14	\$2,024.16
R2OSSMRA	31-1/2"	\$119.31		\$119.31	\$422.00	\$779.93	\$899.24	\$1,018.55	\$1,137.86	\$1,257.17	\$1,376.48
R2OSSMRAK	31-1/2"	\$119.31	\$133.71	\$253.02	\$462.00	\$1,221.06	\$1,474.08	\$1,727.10	\$1,980.12	\$2,233.14	\$2,486.16
R2.25FA	28"	\$106.21		\$106.21		\$318.63	\$424.84	\$531.05	\$637.26	\$743.47	\$849.68
R2.25FAK	28"	\$106.21	\$119.01	\$225.22		\$675.66	\$900.88	\$1,126.10	\$1,351.32	\$1,576.54	\$1,801.76
R2.25FMRA	28"	\$106.21		\$106.21	\$422.00	\$740.63	\$846.84	\$953.05	\$1,059.26	\$1,165.47	\$1,271.68
R2.25FMRAK	28"	\$106.21	\$119.01	\$225.22	\$462.00	\$1,137.66	\$1,362.88	\$1,588.10	\$1,813.32	\$2,038.54	\$2,263.76
R2.25OSA	35"	\$145.38		\$145.38		\$436.14	\$581.52	\$726.90	\$872.28	\$1,017.66	\$1,163.04
R2.25OSAK	35"	\$145.38	\$150.99	\$296.37		\$889.11	\$1,185.48	\$1,481.85	\$1,778.22	\$2,074.59	\$2,370.96
R2.25OSMRA	35"	\$145.38		\$145.38	\$422.00	\$858.14	\$1,003.52	\$1,148.90	\$1,294.28	\$1,439.66	\$1,585.04
R2.25OSMRAK	35"	\$145.38	\$150.99	\$296.37	\$462.00	\$1,351.11	\$1,647.48	\$1,943.85	\$2,240.22	\$2,536.59	\$2,832.96
R2.25OSSA	31-1/2"	\$137.62		\$137.62		\$412.86	\$550.48	\$688.10	\$825.72	\$963.34	\$1,100.96
R2.25OSSAK	31-1/2"	\$137.62	\$142.03	\$279.65		\$838.95	\$1,118.60	\$1,398.25	\$1,677.90	\$1,957.55	\$2,237.20
R2.25OSSMRA	31-1/2"	\$137.62		\$137.62	\$422.00	\$834.86	\$972.48	\$1,110.10	\$1,247.72	\$1,385.34	\$1,522.96
R2.25OSSMRAK	31-1/2"	\$137.62	\$142.03	\$279.65	\$462.00	\$1,300.95	\$1,580.60	\$1,860.25	\$2,139.90	\$2,419.55	\$2,699.20

Assemblies - Prices are List

Part Number	Width	Material Price/Ft.	Pemkote Price/Ft.	Combo Price/Ft.	Miter Price/Pair	36"	48"	60"	72"	84"	96"
R2.5FA	31-1/8"	\$124.52		\$124.52		\$373.56	\$498.08	\$622.60	\$747.12	\$871.64	\$996.16
R2.5FAK	31-1/8"	\$124.52	\$127.33	\$251.85		\$755.55	\$1,007.40	\$1,259.25	\$1,511.10	\$1,762.95	\$2,014.80
R2.5FMRA	31-1/8"	\$124.52		\$124.52	\$422.00	\$795.56	\$920.08	\$1,044.60	\$1,169.12	\$1,293.64	\$1,418.16
R2.5FMRAK	31-1/8"	\$124.52	\$127.33	\$251.85	\$462.00	\$1,217.55	\$1,469.40	\$1,721.25	\$1,973.10	\$2,224.95	\$2,476.80
R2.5OSA	41-1/4"	\$171.97		\$171.97		\$515.91	\$687.88	\$859.85	\$1,031.82	\$1,203.79	\$1,375.76
R2.5OSAK	41-1/4"	\$171.97	\$172.18	\$344.15		\$1,032.45	\$1,376.60	\$1,720.75	\$2,064.90	\$2,409.05	\$2,753.20
R2.5OSMRA	41-1/4"	\$171.97		\$171.97	\$422.00	\$937.91	\$1,109.88	\$1,281.85	\$1,453.82	\$1,625.79	\$1,797.76
R2.5OSMRAK	41-1/4"	\$171.97	\$142.67	\$314.64	\$462.00	\$1,405.92	\$1,720.56	\$2,035.20	\$2,349.84	\$2,664.48	\$2,979.12
R2.5OSSA	37-3/4"	\$164.21		\$164.21		\$492.63	\$656.84	\$821.05	\$985.26	\$1,149.47	\$1,313.68
R2.5OSSAK	37-3/4"	\$164.21	\$163.22	\$327.43		\$982.29	\$1,309.72	\$1,637.15	\$1,964.58	\$2,292.01	\$2,619.44
R2.5OSSMRA	37-3/4"	\$164.21		\$164.21	\$422.00	\$914.63	\$1,078.84	\$1,243.05	\$1,407.26	\$1,571.47	\$1,735.68
R2.5OSSMRAK	37-3/4"	\$164.21	\$163.22	\$327.43	\$462.00	\$1,444.29	\$1,771.72	\$2,099.15	\$2,426.58	\$2,754.01	\$3,081.44
R2.75FA	34-3/4"	\$151.11		\$151.11		\$453.33	\$604.44	\$755.55	\$906.66	\$1,057.77	\$1,208.88
R2.75FAK	34-3/4"	\$151.11	\$148.52	\$299.63		\$898.89	\$1,198.52	\$1,498.15	\$1,797.78	\$2,097.41	\$2,397.04
R2.75FMRA	34-3/4"	\$151.11		\$151.11	\$422.00	\$875.33	\$1,026.44	\$1,177.55	\$1,328.66	\$1,479.77	\$1,630.88
R2.75FMRAK	34-3/4"	\$151.11	\$148.52	\$299.63	\$462.00	\$1,360.89	\$1,660.52	\$1,960.15	\$2,259.78	\$2,559.41	\$2,859.04
R2.75OSA	44-3/8"	\$194.47		\$194.47		\$583.41	\$777.88	\$972.35	\$1,166.82	\$1,361.29	\$1,555.76
R2.75OSAK	44-3/8"	\$194.47	\$180.50	\$374.97		\$1,124.91	\$1,499.88	\$1,874.85	\$2,249.82	\$2,624.79	\$2,999.76
R2.75OSMRA	44-3/8"	\$194.47		\$194.47	\$422.00	\$1,005.41	\$1,199.88	\$1,394.35	\$1,588.82	\$1,783.29	\$1,977.76
R2.75OSMRAK	44-3/8"	\$194.47	\$180.50	\$374.97	\$462.00	\$1,586.91	\$1,961.88	\$2,336.85	\$2,711.82	\$3,086.79	\$3,461.76
R2.75OSSA	40-7/8"	\$186.71		\$186.71		\$560.13	\$746.84	\$933.55	\$1,120.26	\$1,306.97	\$1,493.68
R2.75OSSAK	40-7/8"	\$186.71	\$171.54	\$358.25		\$1,074.75	\$1,433.00	\$1,791.25	\$2,149.50	\$2,507.75	\$2,866.00
R2.75OSSMRA	40-7/8"	\$186.71		\$186.71	\$422.00	\$982.13	\$1,168.84	\$1,355.55	\$1,542.26	\$1,728.97	\$1,915.68
R2.75OSSMRAK	40-7/8"	\$186.71	\$171.54	\$358.25	\$462.00	\$1,536.75	\$1,895.00	\$2,253.25	\$2,611.50	\$2,969.75	\$3,328.00
R3FA	37-5/16"	\$173.61		\$173.61		\$520.83	\$694.44	\$868.05	\$1,041.66	\$1,215.27	\$1,388.88
R3FMRA	37-5/16"	\$173.61		\$173.61	\$422.00	\$942.83	\$1,116.44	\$1,290.05	\$1,463.66	\$1,637.27	\$1,810.88
R3FMRAK	37-5/16"	\$173.61	\$156.84	\$330.45	\$462.00	\$1,453.35	\$1,783.80	\$2,114.25	\$2,444.70	\$2,775.15	\$3,105.60
R3OSA	47-1/2"	\$228.06		\$228.06		\$684.18	\$912.24	\$1,140.30	\$1,368.36	\$1,596.42	\$1,824.48
R3OSMRA	47-1/2"	\$228.06		\$228.06	\$422.00	\$1,106.18	\$1,334.24	\$1,562.30	\$1,790.36	\$2,018.42	\$2,246.48
R3OSMRAK	47-1/2"	\$228.06	\$201.69	\$429.75	\$462.00	\$1,751.25	\$2,181.00	\$2,610.75	\$3,040.50	\$3,470.25	\$3,900.00
R3OSSA	44"	\$220.30		\$220.30		\$660.90	\$881.20	\$1,101.50	\$1,321.80	\$1,542.10	\$1,762.40
R3OSSMRA	44"	\$220.30		\$220.30	\$422.00	\$1,082.90	\$1,303.20	\$1,523.50	\$1,743.80	\$1,964.10	\$2,184.40
R3OSSMRAK	44"	\$220.30	\$192.73	\$413.03	\$462.00	\$1,701.09	\$2,114.12	\$2,527.15	\$2,940.18	\$3,353.21	\$3,766.24
R3.25FA	40-1/2"	\$207.20		\$207.20		\$621.60	\$828.80	\$1,036.00	\$1,243.20	\$1,450.40	\$1,657.60
R3.25FMRA	40-1/2"	\$207.20		\$207.20	\$422.00	\$1,043.60	\$1,250.80	\$1,458.00	\$1,665.20	\$1,872.40	\$2,079.60
R3.25FMRAK	40-1/2"	\$207.20	\$178.03	\$385.23	\$462.00	\$1,617.69	\$2,002.92	\$2,388.15	\$2,773.38	\$3,158.61	\$3,543.84
R3.25OSSA	47-9/16"	\$246.99		\$246.99		\$740.97	\$987.96	\$1,234.95	\$1,481.94	\$1,728.93	\$1,975.92
R3.5FA	43-9/16"	\$233.89		\$233.89		\$701.67	\$935.56	\$1,169.45	\$1,403.34	\$1,637.23	\$1,871.12
R3.5FAK	43-9/16"	\$233.89	\$186.35	\$420.24		\$1,260.72	\$1,680.96	\$2,101.20	\$2,521.44	\$2,941.68	\$3,361.92
R3.5FMRA	43-9/16"	\$233.89		\$233.89	\$422.00	\$1,123.67	\$1,357.56	\$1,591.45	\$1,825.34	\$2,059.23	\$2,293.12
R3.5FMRAK	43-9/16"	\$233.89	\$186.35	\$420.24	\$462.00	\$1,722.72	\$2,142.96	\$2,563.20	\$2,983.44	\$3,403.68	\$3,823.92
R3.5OSSA	50-9/16"	\$260.87		\$260.87		\$782.61	\$1,043.48	\$1,304.35	\$1,565.22	\$1,826.09	\$2,086.96
R3.5OSSMRA	50-9/16"	\$260.87		\$260.87	\$422.00	\$1,204.61	\$1,465.48	\$1,726.35	\$1,987.22	\$2,248.09	\$2,508.96
R3.5OSSMRAK	50-9/16"	\$260.87	\$192.73	\$453.60	\$462.00	\$1,822.80	\$2,276.40	\$2,730.00	\$3,183.60	\$3,637.20	\$4,090.80
R3.75FA	43-9/16"	\$274.48		\$274.48		\$823.44	\$1,097.92	\$1,372.40	\$1,646.88	\$1,921.36	\$2,195.84
R4FA	49-13/16"	\$332.07		\$332.07		\$996.21	\$1,328.28	\$1,660.35	\$1,992.42	\$2,324.49	\$2,656.56
R4FAK	49-13/16"	\$332.07	\$245.37	\$577.44		\$1,732.32	\$2,309.76	\$2,887.20	\$3,464.64	\$4,042.08	\$4,619.52
R4FMRA	49-13/16"	\$332.07		\$332.07	\$422.00	\$1,418.21	\$1,750.28	\$2,082.35	\$2,414.42	\$2,746.49	\$3,078.56
R4FMRAK	49-13/16"	\$332.07	\$245.37	\$577.44	\$462.00	\$2,194.32	\$2,771.76	\$3,349.20	\$3,926.64	\$4,504.08	\$5,081.52
RVARI/A	17"	\$65.51		\$65.51		\$196.53	\$262.04	\$327.55	\$393.06	\$458.57	\$524.08
RVARI/AK	17"	\$65.51	\$73.11	\$138.62		\$415.86	\$554.48	\$693.10	\$831.72	\$970.34	\$1,108.96
RVARIOSS/A	13-1/2"	\$57.75		\$57.75		\$173.25	\$231.00	\$288.75	\$346.50	\$404.25	\$462.00
RVARIOSS/AK	13-1/2"	\$57.75	\$64.15	\$121.90		\$365.70	\$487.60	\$609.50	\$731.40	\$853.30	\$975.20

**TYPE 11 CENTER HUNG,
without MITERED ENDS**

NOTE: Supplied 1/2" over on lengths through 47", and 1" over on lengths 48" and longer

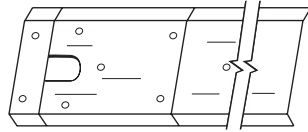

Type 11

**TYPE 13 OFFSET HUNG,
BOTH ENDS MITERED**

NOTE: Supplied 1/2" over on lengths through 47", and 1" over on lengths 48" and longer

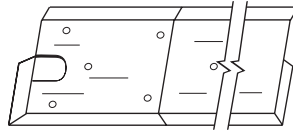

Type 13

**TYPE 14 CENTER HUNG,
BOTH ENDS MITERED**

NOTE: Supplied 1/2" over on lengths through 47", and 1" over on lengths 48" and longer

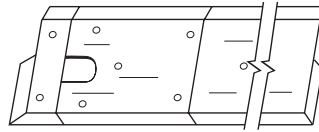

Type 14

**TYPE 15 OFFSET HUNG,
BOTH ENDS MITERED**

NOTE: Supplied NET length because of factory cut miters

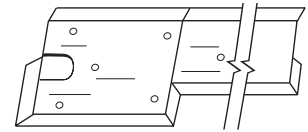

Type 15

Type	Size	Threshold	Material	Single Door 36"	Double Door 72"	Additional Length Add per Inch
11	1/2 x 7	176A	Aluminum	\$118.69	\$237.38	\$1.35
11	1/2 x 7	176B	Brass (Bronze)	\$662.80	\$1,325.60	\$16.47
11	1/2 x 7	176D	Dark Bronze Anodized Aluminum	\$133.66	\$267.32	\$1.77
11	1/4 x 7	276A	Aluminum	\$118.69	\$237.38	\$1.35
11	1/4 x 7	276B	Brass (Bronze)	\$619.12	\$1,238.24	\$15.25
11	1/4 x 7	276D	Dark Bronze Anodized Aluminum	\$132.55	\$265.10	\$1.74
11	1/2 x 8	2548A	Aluminum	\$132.91	\$265.82	\$1.75
11	1/2 x 8	254X4B	Brass (Bronze)	\$859.36	\$1,718.72	\$21.93
11	1/2 x 8	2548D	Dark Bronze Anodized Aluminum	\$153.52	\$307.04	\$2.32
11	1/4 x 8	2748A	Aluminum	\$128.41	\$256.82	\$1.62
11	1/4 x 8	274X4B	Brass (Bronze)	\$706.48	\$1,412.96	\$17.68
11	1/4 x 8	2748D	Dark Bronze Anodized Aluminum	\$147.13	\$294.26	\$2.14
11	1/4 x 9	2749A	Aluminum	\$137.02	\$274.04	\$1.86
11	1/4 x 9	2749D	Dark Bronze Anodized Aluminum	\$156.88	\$313.76	\$2.41
11	1/4 x 10	2750A	Aluminum	\$148.27	\$296.54	\$2.17
11	1/4 x 10	2750D	Dark Bronze Anodized Aluminum	\$172.96	\$345.92	\$2.86
11	1/2 x 8-3/4	193AX2/195A	Aluminum	\$210.55	\$421.10	\$3.90
11	1/2 x 8-3/4	193BX2/195B	Brass (Bronze)	\$1,003.84	\$2,007.68	\$25.94
11	1/2 x 8-3/4	193DX2/195D	Dark Bronze Anodized Aluminum	\$241.99	\$483.98	\$4.78
11	1/2 x 9	2549A	Aluminum	\$140.77	\$281.54	\$1.97
11	1/2 x 9	2549D	Dark Bronze Anodized Aluminum	\$163.99	\$327.98	\$2.61
11	1/2 x 10	2550A	Aluminum	\$148.63	\$297.26	\$2.18
11	1/2 x 10	2550D	Dark Bronze Anodized Aluminum	\$174.10	\$348.20	\$2.89
13	1/2 x 7	176A	Aluminum	\$188.69	\$377.38	\$1.35
13	1/2 x 7	176B	Brass (Bronze)	\$732.80	\$1,465.60	\$16.47
13	1/2 x 7	176D	Dark Bronze Anodized Aluminum	\$203.66	\$407.32	\$1.77
13	1/4 x 7	276A	Aluminum	\$188.69	\$377.38	\$1.35
13	1/4 x 7	276B	Brass (Bronze)	\$689.12	\$1,378.24	\$15.25
13	1/4 x 7	276D	Dark Bronze Anodized Aluminum	\$202.55	\$405.10	\$1.74
13	1/2 x 8	2548A	Aluminum	\$202.91	\$405.82	\$1.75
13	1/2 x 8	254X4B	Brass (Bronze)	\$929.36	\$1,858.72	\$21.93
13	1/2 x 8	2548D	Dark Bronze Anodized Aluminum	\$223.52	\$447.04	\$2.32
13	1/4 x 8	2748A	Aluminum	\$198.41	\$396.82	\$1.62
13	1/4 x 8	274X4B	Brass (Bronze)	\$776.48	\$1,552.96	\$17.68
13	1/4 x 8	2748D	Dark Bronze Anodized Aluminum	\$217.13	\$434.26	\$2.14
13	1/4 x 9	2749A	Aluminum	\$207.02	\$414.04	\$1.86
13	1/4 x 9	2749D	Dark Bronze Anodized Aluminum	\$226.88	\$453.76	\$2.41
13	1/4 x 10	2750A	Aluminum	\$218.27	\$436.54	\$2.17
13	1/4 x 10	2750D	Dark Bronze Anodized Aluminum	\$242.96	\$485.92	\$2.86
13	1/2 x 8-3/4	193AX2/195A	Aluminum	\$280.55	\$561.10	\$3.90
13	1/2 x 8-3/4	193BX2/195B	Brass (Bronze)	\$1,073.84	\$2,147.68	\$25.94
13	1/2 x 8-3/4	193DX2/195D	Dark Bronze Anodized Aluminum	\$311.99	\$623.98	\$4.78
13	1/2 x 9	2549A	Aluminum	\$210.77	\$421.54	\$1.97
13	1/2 x 9	2549D	Dark Bronze Anodized Aluminum	\$233.99	\$467.98	\$2.61

Type	Size	Threshold	Material	Single Door 36"	Double Door 72"	Additional Length Add per Inch
13	1/2 x 10	2550A	Aluminum	\$218.63	\$437.26	\$2.18
13	1/2 x 10	2550D	Dark Bronze Anodized Aluminum	\$244.10	\$488.20	\$2.89
13	3/4 x 16 x 1/2	R.5OSMRA	Aluminum	\$410.57	\$692.14	\$3.93
13	1 x 19 x 3/4	R.75OSMRA	Aluminum	\$517.80	\$827.60	\$4.72
13	1-1/4 x 22 x 1	R1OSMRA	Aluminum	\$560.91	\$913.82	\$5.91
14	1/2 x 7	176A	Aluminum	\$198.69	\$397.38	\$1.35
14	1/2 x 7	176B	Brass (Bronze)	\$742.80	\$1,485.60	\$16.47
14	1/2 x 7	176D	Dark Bronze Anodized Aluminum	\$213.66	\$427.32	\$1.77
14	1/4 x 7	276A	Aluminum	\$198.69	\$397.38	\$1.35
14	1/4 x 7	276B	Brass (Bronze)	\$699.12	\$1,398.24	\$15.25
14	1/4 x 7	276D	Dark Bronze Anodized Aluminum	\$212.55	\$425.10	\$1.74
14	1/2 x 8	2548A	Aluminum	\$212.91	\$425.82	\$1.75
14	1/2 x 8	254X4B	Brass (Bronze)	\$939.36	\$1,878.72	\$21.93
14	1/2 x 8	2548D	Dark Bronze Anodized Aluminum	\$233.52	\$467.04	\$2.32
14	1/4 x 8	2748A	Aluminum	\$208.41	\$416.82	\$1.62
14	1/4 x 8	274X4B	Brass (Bronze)	\$786.48	\$1,572.96	\$17.68
14	1/4 x 8	2748D	Dark Bronze Anodized Aluminum	\$227.13	\$454.26	\$2.14
14	1/4 x 9	2749A	Aluminum	\$217.02	\$434.04	\$1.86
14	1/4 x 9	2749D	Dark Bronze Anodized Aluminum	\$236.88	\$473.76	\$2.41
14	1/4 x 10	2750A	Aluminum	\$228.27	\$456.54	\$2.17
14	1/4 x 10	2750D	Dark Bronze Anodized Aluminum	\$252.96	\$505.92	\$2.86
14	1/2 x 8-3/4	193AX2/195A	Aluminum	\$290.55	\$581.10	\$3.90
14	1/2 x 8-3/4	193BX2/195B	Brass (Bronze)	\$1,083.84	\$2,167.68	\$25.94
14	1/2 x 8-3/4	193DX2/195D	Dark Bronze Anodized Aluminum	\$321.99	\$643.98	\$4.78
14	1/2 x 9	2549A	Aluminum	\$220.77	\$441.54	\$1.97
14	1/2 x 9	2549D	Dark Bronze Anodized Aluminum	\$243.99	\$487.98	\$2.61
14	1/2 x 10	2550A	Aluminum	\$228.63	\$457.26	\$2.18
14	1/2 x 10	2550D	Dark Bronze Anodized Aluminum	\$254.10	\$508.20	\$2.89
14	3/4 x 16 x 1/2	R.5OSMRA	Aluminum	\$420.57	\$712.14	\$3.93
14	1 x 19 x 3/4	R.75OSMRA	Aluminum	\$527.80	\$847.60	\$4.72
14	1-1/4 x 22 x 1	R1OSMRA	Aluminum	\$570.91	\$933.82	\$5.91
15	1/2 x 7 x 4	176A x 170A	Aluminum	\$268.00	\$536.05	\$0.65
15	1/2 x 7 x 4	176B x 170B	Brass (Bronze)	\$658.28	\$1,316.56	\$8.67
15	1/2 x 7 x 4	176D x 170D	Dark Bronze Anodized Aluminum	\$280.62	\$561.22	\$0.94
15	1/4 x 7 x 4	276A x 270A	Aluminum	\$265.86	\$531.71	\$0.56
15	1/4 x 7 x 4	276B x 270B	Brass (Bronze)	\$616.64	\$1,233.28	\$7.63
15	1/4 x 7 x 4	276D x 270D	Dark Bronze Anodized Aluminum	\$278.33	\$556.66	\$0.86
15	1/2 x 7 x 5	176A x 171A	Aluminum	\$272.91	\$545.82	\$0.83
15	1/2 x 7 x 5	176B x 171B	Brass (Bronze)	\$725.98	\$1,451.97	\$11.27
15	1/2 x 7 x 5	176D x 171D	Dark Bronze Anodized Aluminum	\$287.10	\$574.20	\$1.19
15	1/4 x 7 x 5	276A x 271A	Aluminum	\$272.08	\$544.17	\$0.80
15	1/4 x 7 x 5	276B x 271B	Brass (Bronze)	\$661.77	\$1,323.55	\$9.36
15	1/4 x 7 x 5	276D x 271D	Dark Bronze Anodized Aluminum	\$286.73	\$573.46	\$1.19
15	1/2 x 7 x 6	176B x 172B	Brass (Bronze)	\$784.66	\$1,569.32	\$13.52
15	1/2 x 8 x 4	2548A x 170A	Aluminum	\$272.77	\$545.53	\$0.65
15	1/2 x 8 x 4	254X4B x 170B	Brass (Bronze)	\$723.80	\$1,447.60	\$8.67
15	1/2 x 8 x 4	2548D x 170D	Dark Bronze Anodized Aluminum	\$287.23	\$574.46	\$0.94
15	1/2 x 8 x 5	2548A x 171A	Aluminum	\$277.65	\$555.30	\$0.83
15	1/2 x 8 x 5	254X4B x 171B	Brass (Bronze)	\$791.50	\$1,583.00	\$11.27
15	1/2 x 8 x 5	2548D x 171D	Dark Bronze Anodized Aluminum	\$293.72	\$587.44	\$1.19
15	1/2 x 8 x 6	2548A x 172A	Aluminum	\$281.99	\$563.98	\$1.00
15	1/4 x 8 x 4	2748A x 270A	Aluminum	\$269.10	\$538.19	\$0.56
15	1/4 x 8 x 4	274X4B x 270B	Brass (Bronze)	\$645.76	\$1,291.52	\$7.63
15	1/4 x 8 x 4	2748D x 270D	Dark Bronze Anodized Aluminum	\$283.19	\$566.38	\$0.86
15	1/4 x 8 x 5	2748A x 271A	Aluminum	\$275.32	\$550.65	\$0.80
15	1/4 x 8 x 5	274X4B x 271B	Brass (Bronze)	\$690.89	\$1,381.79	\$9.36
15	1/4 x 8 x 5	2748D x 271D	Dark Bronze Anodized Aluminum	\$291.59	\$583.18	\$1.19

Product Number	Description	List Price/ea	Product Number	Description	List Price/ea
1/13	Adjustable Sidewall Bracket	\$184.98	3/307/S	Bracket Steel	\$122.48
1/290/S	Steel Sidewall Bracket	\$10.74	3/307/SC	Bracket Steel	\$137.20
1/290/SLC	Steel Left Closed	\$11.78	3/900	Bracket Overhead Steel	\$14.85
1/290/SRC	Steel Right Closed	\$11.78	3A/290	Bracket Open Aluminum	\$23.20
1/290/SS	Stainless Steel Sidewall Bracket	\$121.51	3A/301	Bracket Open Aluminum	\$48.60
1/301/EC	End Clip 301 Track	\$2.29	3A/305	Bracket Open Aluminum	\$89.62
1/301/S	Steel Sidewall Bracket	\$16.66	3A/305/C	Bracket Closed Aluminum	\$93.66
1/301/SS	Stainless Steel Sidewall Bracket	\$199.24	3AX/290	Joining Bracket Aluminum	\$31.62
1/307/S	Bracket Steel	\$70.23	3AX/301	Joining Bracket Aluminum	\$60.51
1/307/SLC	Bracket Left Closed	\$87.09	3S	Bottom Roller	\$388.59
1/307/SRC	Bracket Right Closed	\$87.09	3S/550	Overhead Bracket Flexirol Track	\$238.55
1/900	Bracket Steel	\$14.42	3X/290/SS	Stainless Steel Joining Bracket	\$236.96
1A/290	Bracket Aluminum	\$9.61	3X/301/SS	Stainless Steel Joining Bracket	\$267.23
1A/290/EC	End Clip 290 Track	\$1.40	FIF4/275A/12	Folding Door Kit, 275lbs/panel, 10 ft	\$1,792.47
1A/301	Bracket Aluminum	\$18.32	FIF4/275A/16	Folding Door Kit, 275lbs/panel, 12 ft	\$1,892.11
1A/301/EC	Bracket End Clip	\$2.20	FIF4/275A/6	Folding Door Kit, 275lbs/panel, 6 ft	\$1,705.66
1A/305	Bracket Aluminum	\$32.04	FIF4/275A/8	Folding Door Kit, 275lbs/panel, 8 ft	\$1,749.06
1A/305/LC	Bracket Left Closed	\$44.14	HF4/100/8	Track & Hardware Pack for Folding Doors	\$169.64
1A/305/RC	Bracket Right Closed	\$44.14	HF4/100A/4	Track & Hardware Pack for Folding Doors	\$154.33
1A/550	Sidewall Bracket Flexirol Track	\$83.50	HF4/100A/6	Track & Hardware Pack for Folding Doors	\$191.05
1AX/290	Joining Bracket Aluminum	\$12.34	HF4/100A/8	Track & Hardware Pack for Folding Doors	\$191.05
1AX/301	Joining Bracket Aluminum	\$31.62	PIF4/165A/12	Folding Door Kit, 165lbs/panel, 12 ft	\$1,554.51
1AX/305	Joining Bracket Aluminum	\$43.04	PIF4/165A/6	Folding Door Kit, 165lbs/panel, 6 ft	\$1,343.55
1B	Face Fix Bracket Aluminum	\$6.41	PIF4/165A/8	Folding Door Kit, 165lbs/panel, 8 ft	\$1,343.12
1BX	Joining Bracket Aluminum	\$16.09	4/290/SS	Stainless Steel Overhead Bracket	\$136.83
1S	Bottom Roller	\$222.26	4/301/S	Bracket Steel	\$34.13
1X/290/S	Joining Bracket Steel	\$17.62	4/301/SS	Stainless Steel Overhead Bracket	\$214.00
1X/290/SS	Stainless Steel Joining Bracket	\$196.64	4/307/S	Bracket Open	\$122.48
1X/301/S	Joining Bracket Steel	\$18.53	4/307/SC	Bracket Closed	\$137.20
1X/301/SS	Stainless Steel Joining Bracket	\$238.38	4A/290	Bracket Open Aluminum	\$27.23
1X/307/S	Joining Bracket Steel	\$67.49	4A/301	Bracket Open Aluminum	\$49.94
2	Bottom Roller	\$236.07	4A/305	Bracket Open Aluminum	\$121.57
FIF2/275A/6	Folding Door Kit, 275lbs/panel, 6 ft	\$976.44	4A/305/C	Bracket Closed	\$130.48
FIF2/275A/8	Folding Door Kit, 275lbs/panel, 8 ft	\$986.99	4AX/290	Joining Bracket	\$38.30
HF2/100/4	Steel Track & Hardware Pack	\$94.00	4AX/301	Joining Bracket	\$60.44
HF2/100A/2	Track & Hardware Pack	\$96.46	4AX/305	Joining Bracket	\$136.28
HF2/100A/3	Track & Hardware Pack	\$96.46	4R/280/SS	Stainless Steel Overhead Bracket	\$131.26
HF2/100A/4	Aluminum Track & Hardware Pack	\$96.46	4R/290/S	Bracket Steel	\$14.42
HF2/100PACK	Hardware Pack Only	\$64.41	4R/290/SS	Stainless Steel Overhead Bracket	\$146.14
PIF2/165A/6	Folding Door Kit, 165lbs/panel, 6 ft	\$757.28	4R/301/S	Bracket Steel	\$64.89
EPD3BL-36	36 in Polypropylene Channel Insert	\$15.48	4R/301/SB	Bracket Body Only	\$7.52
EPD3BL-48	48 in Polypropylene Channel Insert	\$20.64	4R/301/SS	Stainless Steel Overhead Bracket	\$167.25
3	Bottom Roller	\$379.22	4R/305/S	Bracket Steel	\$70.55
3/290/SS	Stainless Steel Overhead Bracket	\$136.83	4R/305/SB	Bracket Body Only	\$43.15
HH3/290	Track Stop	\$44.23	4R/307/FS	Fixing Screw	\$15.46
HH3/290/SS	Stainless Steel In-track Stop	\$76.60	4R/307/S	Bracket Steel	\$67.41
3/301/SS	Stainless Steel Overhead Bracket	\$355.94	4R/307/SB	Bracket Body Only	\$41.30
3/301S	Bracket, Steel	\$26.31	4R/307/SC	Bracket Closed	\$88.30
HH3/301	In-track Stop for 301 Track	\$81.12	4RX/290/S	Bracket Joining	\$29.80
HH3/301/SS	Stainless Steel In-track Stop	\$90.45	4RX/301/SS	Stainless Steel Bracket	\$188.97

Product Number	Description	List Price/ea	Product Number	Description	List Price/ea
4RX/301/TS	Track Sleeve	\$44.23	K28C-SWEP	Clear End Plate Kit	\$25.22
4RX/305	Joining Bracket	\$87.18	K28D-SWEP	Dark End Plate Kit	\$38.97
4X/290/SS	Stainless Steel Joining Bracket	\$209.17	31	Bracket	\$27.33
4X/301/SS	Stainless Steel Joining Bracket	\$253.09	31D	Wall Guide-Double	\$43.18
4X/307/S	Joining Bracket Steel	\$113.44	31S	Wall Guide-Single	\$29.80
5	Bottom Roller	\$124.96	31S/SS	Guide Stainless Steel	\$223.73
5S	Bottom Roller	\$122.35	52A/N	Hanger for 301 Nylon Wheels	\$101.32
5/290	Bracket Open Aluminum	\$47.08	52A/S	Hanger for 301 Steel Wheels	\$104.38
5/301	Bracket Open Aluminum	\$51.17	52B	Hanger Wood Door	\$106.75
5/305	Bracket Open Aluminum	\$181.45	52C/S	Hanger for 305 Steel Wheel	\$113.64
5/305/LC	Bracket Left Closed	\$243.09	52K/APRON	Apron for 290 Track	\$30.90
5/305/RC	Bracket Right Closed	\$243.09	52K/N	Hanger for 290 Nylon Wheels	\$40.11
5/307/S	Bracket Open Steel	\$278.07	52K/S	Hanger for 290 Steel Wheels	\$42.00
5/307/SC	Bracket Closed Steel	\$308.74	53/99	Top Guide Hanger	\$30.78
5/900	Bracket Steel	\$37.54	53/290/SS	Stainless Steel Hanger	\$1,045.19
6/301	Bracket Open Aluminum	\$85.23	53/301/SS	Stainless Steel Hanger	\$2,119.28
S7-SPACER	S/7-Spacer	\$24.31	53A/N	Hanger for 301 Nylon	\$110.43
7/301/S	Bracket Open Steel	\$209.16	53A/S	Hanger for 301 Steel	\$98.65
8/10/75HUSKY	Husky Glass Clamp Kit 8/10 mm	\$558.97	53C/S	Hanger for 305 Steel	\$128.89
8/301/S	Bracket Open Steel	\$80.64	53FJ/S	Hanger Steel	\$376.28
9/301/S	Bracket Open Steel	\$35.51	53FJ/S/APRON	Apron Only	\$51.88
9/307/S	Bracket Open Steel	\$104.87	53K/N	Hanger for 290 Nylon	\$51.94
9A/290	Bracket Open Aluminum	\$27.58	53K/S	Hanger for 290 Steel	\$52.99
9AX/290	Joining Bracket Aluminum	\$37.68	53K/S200	Hanger for 290	\$57.74
9AX/305	Joining Bracket Aluminum	\$229.64	54/900	Guide (Wood)	\$32.53
9X/301/S	Joining Bracket Steel	\$41.78	56/290/SS	Stainless Steel Hanger	\$567.19
9X/307/S	Joining Bracket Steel	\$131.18	56/301/SS	Stainless Steel Hanger	\$1,634.95
13	Top Guide Channel 9 Ft 10 In.	\$358.59	56A/N	Hanger for 301	\$62.68
FRE12	End Cap	\$39.35	56A/S	Hanger for 301	\$64.34
FRE14	End Cap	\$39.35	56AX/N	Hanger for 301 Nylon	\$83.56
FRE15	End Cap	\$39.35	56AX/S	Hanger for 301 Steel	\$72.91
FRE16	End Cap	\$39.35	56B	Hanger Straight Sliding	\$78.07
21/550/P	Pivot Assembly	\$282.70	56BX	Hanger Straight Sliding	\$84.54
21A/4S	Hanger	\$131.04	56C/S	Hanger for 305 Steel	\$87.06
21A/P	Pivot Set	\$182.78	56CX/S	Hanger for 305 Steel	\$92.95
21A/PBOLT	Bolt	\$1.29	56FJ/S	Hanger for 307 Steel	\$337.50
21A/S	Hanger	\$126.09	56FJX/S	Hanger for 307 Steel	\$438.46
21B	Hanger Internal Folding	\$98.18	56FX/S	Hanger for 307 Steel	\$315.07
21B/4	Hanger End Folding	\$119.91	56K/N	Hanger for 290 Nylon	\$20.83
21B/P	End Pivot Assembly	\$111.83	56K/N200	Hanger for 290 Nylon	\$42.27
21BO/4	Hanger Pacer Off-Set	\$361.03	56K/S	Hanger for 290 Steel	\$23.89
21C/4S	Hanger 305	\$152.31	56K/S200	Hanger for 290 Steel	\$43.39
21C/S	Hanger 305	\$177.12	56KX/N	Hanger for 290 Nylon	\$34.24
21K/4N	Hanger 4 Wheel	\$53.90	56KX/S	Hanger for 290 Steel	\$31.41
21K/N	Hanger 290	\$61.35	56KX/S200	Hanger for 290 Steel	\$76.26
21K/P	Pivot Set	\$94.07	57/290/SS	Stainless Steel Hanger	\$876.06
21K/S	Hanger 290	\$61.83	57/301/SS	Stainless Steel Hanger	\$2,134.74
21KR/94	Guide	\$24.93	57A	Mounting Plate Only	\$13.80
21N/94	Guide	\$34.54	57A/N	Hanger for 301	\$104.17
21R/94	Guide	\$30.50	57A/S	Hanger for 301	\$108.42

Product Number	Description	List Price/ea	Product Number	Description	List Price/ea
57B	Hanger	\$84.05	SHS80/6	Spring Hill Suites Sliding Door Kit	\$114.69
57C/S	Hanger for 305	\$119.34	SHS80/8	Spring Hill Suites Sliding Door Kit	\$130.43
57K/APRON	Apron for 290 Track	\$33.43	SHS80/PACK	Hardware Pack for SHS80 Kit	\$83.89
57K/N	Hanger for 290	\$42.34	PFAS84	Aluminum Stud Pair, 84 inch	\$60.32
57K/S	Hanger for 290	\$47.28	PFAS88	Aluminum Stud Pair, 88 inch	\$73.58
57K/SSAPRON	Stainless Steel Mounting Plate	\$118.30	89/2N	Torpedo Guide	\$56.12
57SS/APRON	Stainless Steel Apron	\$118.30	89/2N/SS	Stainless Steel Guide	\$114.75
58K/N	Hanger & Hook for 290	\$36.56	89/6	Guide Channel	\$28.77
58K/S	Hanger & Hook for 290	\$38.80	89/2000	Channel, Steel 2 Meters	\$35.77
60B	Aluminum Hinge Mounting Kit	\$78.76	89/2000/SS	Stainless Guide Channel 2 Meters	\$323.50
61A/N	Hanger for 301 Nylon	\$117.89	89/3000	Channel Steel 3 Meters	\$53.62
61A/S	Hanger for 301 Steel	\$119.85	89/3000/SS	Stainless Guide Channel 3 Meters	\$485.31
61B	Hanger Centerfold	\$86.70	94/1500	Brass Guide Channel 1.5 Meters	\$192.82
61B/4	Hanger	\$108.42	94/3000	Brass Guide Channel 3 Meters	\$374.92
61B/GUIDE	Guide	\$9.41	94A72	Aluminum Guide Channel 6 Ft	\$22.36
61C/S	Hanger for 305 Steel	\$165.83	94A96	Aluminum Guide Channel 8 Ft	\$28.94
61K/N	Hanger for 290 Nylon	\$54.67	94A144	Aluminum Guide Channel 12 Ft	\$43.40
61K/S	Hanger for 290 Steel	\$54.95	97/2000	Guide Channel Steel 2 Meters	\$60.53
62A	Hanger for 301	\$96.86	97/2500	Guide Channel Steel 2.5 Meters	\$73.39
62B	Hanger	\$274.97	97/3000	Guide Channel Steel 3 Meters	\$89.99
62BA/148	Hanger	\$104.87	99/3000	Guide Channel Steel 3 Meters	\$98.67
62BA/250	Hanger	\$319.60	SIM100	Simultaneous Action Unit	\$281.20
62C	Hanger for 305	\$609.18	H100/200PACK	H100/200Pack	\$42.85
62K	Hanger for 290	\$57.17	LH100	Low Profile Hardware Pack	\$287.50
63A	Hanger for 301	\$74.17	PFAS100	Aluminum Stud Pair, 100 inch	\$81.12
63BA/104	Hanger	\$88.71	102N	Guide for Husky	\$1.40
63BA/205	Hanger	\$280.82	102WA	Mortise Side Wall Mount Bottom Guide Steel	\$20.80
63BOA/114	Hanger	\$288.06	102WN	Side Wall Mount Nylon Mortise Guide	\$26.52
63C	Hanger for 305	\$175.19	102/97	Guide Self-Cleaning	\$60.81
63K	Hanger for 290	\$50.00	104/13	Top Guide Roller	\$74.51
65	Hinge	\$19.64	104/99	Top Guide Roller	\$28.56
65B/20	Pacer External Hinge	\$196.10	104/900	Top Guide Roller	\$28.34
65B/20/1	Hinge	\$108.86	104N/94	Guide for Pacer	\$35.24
65B/20-40	Hinge	\$215.67	104P/89	Guide For No 89 Channel	\$23.68
65B/40	Hinge	\$218.78	104P/97	Guide For No 97 Channel	\$24.65
65B/40/1	Hinge	\$97.00	104NX/94	Guide-Extended	\$37.40
65C	Hinge Face Mount	\$218.43	104PX/89	Guide-Extended	\$24.37
67/89	Guide	\$45.75	104PX/97	Guide-Extended	\$29.11
67/97	Guide	\$97.76	105R/89	Guide Roller	\$41.73
67BA/150	Guide	\$45.34	105R/97	Guide Roller	\$50.81
67BA/220	Guide	\$184.80	106HF/94	Guide Roller	\$24.94
67C/97	Guide	\$228.48	106N/94	Guide for Pacer	\$26.78
68/89	Guide	\$28.08	106R/94	Guide Roller	\$12.47
68/97	Guide	\$31.22	106R/97	Guide Roller	\$21.60
68BA/110	Guide End	\$33.43	107	Wall Stop	\$53.34
68BA/180	Guide	\$170.25	107E	Rubber Bumper	\$3.35
68C/97	Guide	\$88.38	108L	Stop	\$291.18
71P/301	Trolley (Curtains)	\$272.05	108R	Stop	\$291.18
76/305	Overhead Runways	\$565.46	109	Floor Stop	\$29.63
77J	Flush Bolt Steel	\$258.54	109SS	Stop Stainless Steel	\$84.19
78	Flush Bolt Painted Steel	\$296.76	113R/94	Top Guide Roller	\$11.70

Product Number	Description	List Price/ea	Product Number	Description	List Price/ea
115	Corner Plate	\$8.71	SIM200A/12	Sliding Door Kit 12 Ft	\$500.59
126	Stay Roller	\$29.19	SIM200A/16	Sliding Door Kit 16 Ft	\$522.84
126H	Stay Roller	\$96.50	SIM200A/6	Sliding Door Kit 6 Ft	\$467.20
126HD/A	Stay Roller	\$107.27	SIM200A/8	Sliding Door Kit 8 Ft	\$478.33
126HL	Stay Roller-Extended	\$101.24	203/900	Guide Double Roller	\$49.37
128	Floor Mount Guide/Stop	\$256.08	H222-45	Hanger	\$26.00
F134C48	Husky Fascia For 1-3/4 Inch Doors 4 Ft	\$28.08	280A48	Track Aluminum 4 Ft	\$22.26
F134C72	Husky Fascia For 1-3/4 Inch Doors 6 Ft	\$42.12	280A72	Track Aluminum 6 Ft	\$33.39
F134C84	Husky Fascia For 1-3/4 Inch Doors 7 Ft	\$49.14	280A96	Track Aluminum 8 Ft	\$44.52
F134C96	Husky Fascia For 1-3/4 Inch Doors 8 Ft	\$56.16	280A120	Track Aluminum 10 Ft	\$62.32
F134C120	Husky Fascia For 1-3/4 Inch Doors 10 Ft	\$77.90	280A144	Track Aluminum 12 Ft	\$66.77
F134C144	Husky Fascia For 1-3/4 Inch Doors 12 Ft	\$83.46	280D72	Track Dark Bronze Aluminum 6 ft	\$46.80
F134D72	Husky Dark Bronze Fascia For 1-3/4 Doors 6 Ft	\$52.42	280D96	Track Dark Bronze Aluminum 8 ft	\$62.40
F134D96	Husky Dark Bronze Fascia For 1-3/4 Doors 8 Ft	\$69.89	280D120	Track Dark Bronze Aluminum 10 ft	\$78.00
F134D120	Husky Dark Bronze Fascia For 1-3/4 Doors 10 Ft	\$87.36	280A-SWT60	Sidewall Track Clear 60 In	\$52.31
F134D144	Husky Dark Bronze Fascia For 1-3/4 Doors 12 Ft	\$104.84	280A-SWT72	Sidewall Track Clear 72 In	\$56.76
K134EP	End Plate Kit for 1-3/4 Inch Doors	\$36.33	280A-SWT96	Sidewall Track Clear 96 In	\$75.68
K134DEP	F134 End Plate Kit Dark Bronze Aluminum	\$46.51	280A-SWT144	Sidewall Track Clear 144 In	\$113.51
F160C48	Fascia	\$85.15	280C-SWF60	Sidewall Fascia Clear 60 In	\$50.08
F160C72	Fascia	\$110.17	280C-SWF72	Sidewall Fascia Clear 72 In	\$53.42
F160C96	Fascia	\$213.62	280C-SWF144	Sidewall Fascia Clear 144 In	\$106.83
F160C144	Fascia	\$220.34	280C-SWF96	Sidewall Fascia Clear 96 In	\$71.22
F160ECP	Fascia End Clip	\$117.19	280C-SWTKIT/5	Sidewall Track Kit Clear 5 Ft	\$174.85
H180A/10	Sliding Door Kit, 180lb/panel, 10 Ft	\$133.33	280C-SWTKIT/6	Sidewall Track Kit Clear 6 Ft	\$182.64
H180A/12	Sliding Door Kit, 180lb/panel, 12 Ft	\$144.46	280C-SWTKIT/8	Sidewall Track Kit Clear 8 Ft	\$219.36
H180A/6	Sliding Door Kit, 180lb/panel, 6 Ft	\$108.65	280C-SWTKIT/12	Sidewall Track Kit Clear 12 Ft	\$380.02
H180A/8	Sliding Door Kit, 180lb/panel, 8 Ft	\$120.58	280D-SWF60	Sidewall Fascia Dark 60 In	\$66.69
JS180	Jointing Strip	\$9.90	280D-SWF72	Sidewall Fascia Dark 72 In	\$71.45
F200C48	Fascia	\$100.16	280D-SWF96	Sidewall Fascia Dark 96 In	\$111.84
F200C72	Fascia	\$150.23	280D-SWF144	Sidewall Fascia Dark 144 In	\$142.89
F200C96	Fascia	\$234.11	280D-SWT60	Sidewall Track Dark 60 In	\$77.40
F200C144	Fascia	\$300.46	280D-SWT72	Sidewall Track Dark 72 In	\$82.16
F200ECP	Fascia End Clip	\$117.19	280D-SWT96	Sidewall Track Dark 96 In	\$109.55
H200/6	Steel Track & Hardware Pack	\$67.63	280D-SWT144	Sidewall Track Dark 144 In	\$164.32
H200/8	Steel Track & Hardware Pack	\$68.78	280D-SWTKIT/5	Sidewall Track Kit Dark 5 Ft	\$221.54
H200A/4	Aluminum Track & Hardware Pack	\$66.54	280D-SWTKIT/6	Sidewall Track Kit Dark 6 Ft	\$231.06
H200A/5-4	Aluminum Track & Hardware Pack	\$81.37	280D-SWTKIT/8	Sidewall Track Kit Dark 8 Ft	\$287.25
H200A/6	Aluminum Track & Hardware Pack	\$81.37	280D-SWTKIT/12	Sidewall Track Kit Clear 12 Ft	\$452.85
H200A/7	Aluminum Track & Hardware Pack	\$92.50	280TC	Track Curve Steel	\$70.75
H200A/8	Aluminum Track & Hardware Pack	\$92.50	280/3	Husky Track Steel 3 Ft	\$14.76
H200A/10	Track & Hardware Pack	\$106.46	280/4	Track Steel 4 Ft	\$17.21
H200A/12	Track & Hardware Pack	\$106.46	280/6	Track Steel 6 Ft	\$23.33
HBP200A/4	Track & Hardware Pack for ByPass	\$150.86	280/8	Track Steel 8 Ft	\$23.33
HBP200A/5-4	Track & Hardware Pack for ByPass	\$178.32	280/10	Track Steel 10 Ft	\$29.80
HBP200A/6	Track & Hardware Pack for ByPass	\$178.32	280/12	Track Steel 12 Ft	\$36.56
HBP200A/7	Track & Hardware Pack for ByPass	\$205.03	280/2000/SS	Stainless Steel Track 2 Meters	\$661.96
HBP200A/8	Track & Hardware Pack for ByPass	\$205.03	280/3000/SS	Stainless Steel Track 3 Meters	\$893.69
HBP200A/10	Track & Hardware Pack for ByPass	\$259.56	281/SS	Stainless Steel Sidewall Bracket	\$23.91
HBP200A/12	Track & Hardware Pack for ByPass	\$259.56	282HD	Hinge for Husky	\$2.23
LP200A/10	Low Profile Hardware Pack, 10 Ft	\$349.82	283	Husky Hanger	\$32.59
LP200A/6	Low Profile Hardware Pack, 6 Ft	\$320.89	284/SS	Hanger Assembly, SS	\$182.65

Product Number	Description	List Price/ea	Product Number	Description	List Price/ea
284N/SS	Hanger Stainless Steel	\$128.06	430	Lock Bar Detachable	\$130.77
284N/SS/APRON	Stainless Steel Apron	\$39.41	431	Lock Bar Swivel	\$112.47
284TP	Husky Top Plate for 284 & 284N	\$1.47	H440A-OH/10	Overhead Mount Track, 440lb/panel, 10 Ft	\$607.86
287/SS	In-Track Bumper Stop, SS	\$49.79	H440A-OH/12	Overhead Mount Track, 440lb/panel, 12 Ft	\$646.30
286	Clip Stop	\$16.30	H440A-OH/6	Overhead Mount Track, 440lb/panel, 6 Ft	\$435.32
287E	Wall Stop	\$1.26	H440A-OH/8	Overhead Mount Track, 440lb/panel, 8 Ft	\$434.90
287HD	Track Bumper Stop for 280 and 280A	\$9.65	H440A-SW/10	Side Wall Mount Track, 440lb/panel, 10 Ft	\$639.41
288H	Hanger & Hook Curtains	\$14.00	H440A-SW/12	Side Wall Mount Track, 440lb/panel, 12 Ft	\$641.62
289B	Husky Bottom Pivot	\$19.08	H440A-SW/6	Side Wall Mount Track, 440lb/panel, 6 Ft	\$454.54
289T	Husky Top Pivot	\$14.85	H440A-SW/8	Side Wall Mount Track, 440lb/panel, 8 Ft	\$460.52
290/6	Track Steel 6 Ft	\$43.25	454	Flush Bolt Aluminum	\$84.67
290/6/SS	Stainless Steel Track 6 Ft	\$509.90	463	Bow Handle	\$20.21
290/8	Track Steel 8 Ft	\$57.74	464	Bow Handle	\$59.33
290/8/SS	Stainless Steel Track 8 Ft	\$679.85	550A72	Flexirol Track Aluminum 6 Ft	\$253.72
290/10	Track Steel 10 Ft	\$72.08	550A90ELBOW	90° Elbow Aluminum	\$356.10
290/12	Track Steel 12 Ft	\$86.55	550A96	Flexirol Track Aluminum 8 Ft	\$338.30
295E	Dead Lock	\$121.44	550A120	Flexirol Track Aluminum 10 Ft	\$525.74
298/3000	Bottom Rail Steel 3 Meters	\$133.79	550A135ELBOW	135° Elbow Aluminum	\$262.63
299/3000	Bottom Rail Steel 3 Meters	\$91.19	550A197	Flexirol Track Aluminum 16 Ft 5 In	\$676.59
H300S-OH/10	Overhead Mount Track, 300lb/panel, 10 Ft	\$420.00	550ACROSS	Cross Section Aluminum	\$534.15
H300S-OH/12	Overhead Mount Track, 300lb/panel, 12 Ft	\$457.68	550ALEFT	Y-Left Aluminum	\$445.12
H300S-OH/6	Overhead Mount Track, 300lb/panel, 6 Ft	\$344.81	550ARIGHT	Y-Right Aluminum	\$445.12
H300S-OH/8	Overhead Mount Track, 300lb/panel, 8 Ft	\$382.48	550ASWEPT	Swept Elbow Aluminum	\$400.61
H300S-SW/10	Side Wall Mount Track, 300lb/panel, 10 Ft	\$352.12	550AT	T-Junction Aluminum	\$445.12
H300S-SW/12	Side Wall Mount Track, 300lb/panel, 12 Ft	\$376.21	555	90° Hanger 220 lbs	\$521.94
H300S-SW/6	Side Wall Mount Track, 300lb/panel, 6 Ft	\$304.08	555/21	90° Hanger 220 lbs	\$594.71
H300S-SW/8	Side Wall Mount Track, 300lb/panel, 8 Ft	\$328.17	555/61	90° Hanger 220 lbs	\$536.35
301/6	Track Steel 6 Ft	\$74.99	556	45° Hanger 1100 lbs	\$264.11
301/6/SS	Track Stainless Steel 6 Ft	\$1,007.17	556/21	Hanger Folding 275 lbs	\$333.46
301/8	Track Steel 8 Ft	\$85.17	556/52	Hanger Assembly	\$285.34
301/8/SS	Track Stainless Steel 8 Ft	\$1,367.61	556/57	Hanger Assembly	\$277.48
301/10	Track Steel 10 Ft	\$162.26	556/61	45° Hanger 1100 lbs	\$312.99
301/12	Track Steel 12 Ft	\$126.59	556A/221	Folding Hanger	\$675.47
301H/6	Track Steel 6 Ft	\$83.69	600A72	PacerTrack Aluminum 6 Ft	\$160.25
301H/8	Track Steel 8 Ft	\$131.04	600A96	PacerTrack Aluminum 8 Ft	\$213.66
301H/10	Track Steel 10 Ft	\$163.91	600A120	PacerTrack Aluminum 10 Ft	\$287.58
301H/12	Track Steel 12 Ft	\$167.47	600A197	PacerTrack Aluminum 16 Ft 5 In	\$427.32
301H/6000	Track Steel 6 Meters	\$269.60	600B	Track Curve for 301 Steel	\$119.21
305/6	Track Steel 6 Ft	\$102.91	600BH	Track Curve for 301H Steel	\$178.25
305/8	Track Steel 8 Ft	\$137.04	600C	Pacer Curve Aluminum	\$435.18
305/10	Track Steel 10 Ft	\$171.29	600D	Track Curve for 305 Steel	\$280.40
307/2500	Track Steel 2.5 Meters	\$535.99	600K	Track Curve for 290 Steel	\$92.19
307/3000	Track Steel 3 Meters	\$816.54	H600S-OH/10	Overhead Mount Track, 600lb/panel, 10 Ft	\$788.75
333	Flush Bolt Aluminum	\$77.02	H600S-OH/12	Overhead Mount Track, 600lb/panel, 12 Ft	\$857.40
400	Flush Pull Aluminum	\$22.28	H600S-OH/6	Overhead Mount Track, 600lb/panel, 6 Ft	\$649.08
403/1	Butt Hinge Aluminum	\$20.47	H600S-OH/8	Overhead Mount Track, 600lb/panel, 8 Ft	\$718.78
403/2	Butt Hinge Aluminum	\$22.64	H600S-SW/10	Side Wall Mount Track, 600lb/panel, 10 Ft	\$637.32
403/3	Butt Hinge Aluminum	\$28.42	H600S-SW/12	Side Wall Mount Track, 600lb/panel, 12 Ft	\$675.67
413	Flush Pull Steel	\$76.00	H600S-SW/6	Side Wall Mount Track, 600lb/panel, 6 Ft	\$558.21
414	Flush Pull Aluminum	\$16.23	H600S-SW/8	Side Wall Mount Track, 600lb/panel, 8 Ft	\$597.63

Product Number	Description	List Price/ea	Product Number	Description	List Price/ea
601H	Husky Track Stop	\$20.06	915A144	Bottom Rail Aluminum 12 Ft	\$22.93
601P	Pacer Track Stop	\$20.06	916	Bottom Roller Brass	\$292.31
601/89	Channel Curve	\$103.61	917/918CUP	Concrete Fixing Coupler	\$0.98
601/97	Channel Curve	\$126.45	917/918LUG	Concrete Fixing Lug	\$2.23
608	Guide 5/16 Inch Glass	\$28.21	917/1500	Bottom Rail Brass 1.5 Meters	\$275.74
610	Guide 3/8 Inch Glass	\$28.21	917/3000	Bottom Rail Brass 3 Meters	\$554.21
612	Guide 1/2 Inch Glass	\$28.21	918/1500	Bottom Rail Brass	\$186.85
618BRASS	Lock Polished Brass	\$967.63	918/3000	Bottom Rail Brass 3 Meters	\$364.51
618CHROME	Lock Chrome	\$939.99	919H	Bottom Roller	\$2,601.35
618SATIN	Lock Satin Chrome	\$939.99	920	Bottom Roller Steel	\$230.82
618SILVER	Lock Silver	\$911.44	922	Bottom Roller Steel	\$244.56
618WHITE	Lock White	\$1,429.89	923	Bottom Roller Steel	\$141.70
619BRASS	Receiving Lock Polished Brass	\$967.63	971A36	Threshold for Henderson Guide Track	\$27.54
619CHROME	Receiving Lock Chrome	\$939.99	971A48	Threshold for Henderson Guide Track	\$36.73
619SATIN	Receiving Lock Satin Chrome	\$939.99	971A72	Threshold for Henderson Guide Track	\$55.37
619SILVER	Receiving Lock Silver	\$911.44	971A84	Threshold for Henderson Guide Track	\$68.96
700/20	Track for Titan 20 Ft	\$935.74	971A96	Threshold for Henderson Guide Track	\$73.45
701	End Guide for Titan	\$182.30	971A144	Threshold for Henderson Guide Track	\$110.67
702	End Guide for Titan	\$80.84	971A197	Threshold for Henderson Guide Track	\$153.49
703	Top Guide for Titan	\$200.55	994	Bolt Steel 15 In	\$70.46
703C	Top Guide for Titan	\$170.25	994FBS	Flush Bolt Socket	\$21.24
704	Bottom Roller 4 Wheel	\$839.44	994R/89	Bolt Guide Steel	\$71.54
708	Bottom Roller 8 Wheel	\$1,455.79	994R/97	Bolt Guide Steel	\$76.11
710/20	Track for Titan 20 Ft	\$2,077.99	994S	Locking Bolt Steel 15 In	\$157.16
712	End Guide for Titan	\$119.15	1075C120	Side Wall Track Bracket 10 Ft	\$107.33
720	Bottom Roller 8 Wheel	\$2,875.65	1075C144	Side Wall Track Bracket 12 Ft	\$128.80
H800S-OH/10	Overhead Mount Track, 800lb/panel, 10 Ft	\$780.25	1075C72	Side Wall Track Bracket 6 Ft	\$65.44
H800S-OH/12	Overhead Mount Track, 800lb/panel, 12 Ft	\$848.90	1075C96	Side Wall Track Bracket 8 Ft	\$85.87
H800S-OH/6	Overhead Mount Track, 800lb/panel, 6 Ft	\$640.58	1076A120	Side Wall Track 10 Ft	\$67.40
H800S-OH/8	Overhead Mount Track, 800lb/panel, 8 Ft	\$710.28	1076A144	Side Wall Track 12 Ft	\$80.88
H800S-SW/10	Side Wall Mount Track, 800lb/panel, 10 Ft	\$628.82	1076A72	Side Wall Track 6 Ft	\$40.44
H800S-SW/12	Side Wall Mount Track, 800lb/panel, 12 Ft	\$667.18	1076A96	Side Wall Track 8 Ft	\$53.92
H800S-SW/6	Side Wall Mount Track, 800lb/panel, 6 Ft	\$549.73	K1077C-SWEP	Side Wall End Plate Kit	\$26.00
H800S-SW/8	Side Wall Mount Track, 800lb/panel, 8 Ft	\$589.13	H1100A-OH/10	Overhead Mount Track, 1100lb/panel, 10 Ft	\$1,341.03
815/1500	Bottom Rail Brass 1.5 Meters	\$231.22	H1100A-OH/12	Overhead Mount Track, 1100lb/panel, 12 Ft	\$1,345.80
815/3000	Bottom Rail Brass 3 Meters	\$559.08	H1100A-OH/16	Overhead Mount Track, 1100lb/panel, 16 Ft	\$1,345.80
817/1500	Bottom Rail Brass 1.5 Meters	\$176.10	H1100A-OH/6	Overhead Mount Track, 1100lb/panel, 6 Ft	\$1,006.87
817/3000	Bottom Rail Brass 3 Meters	\$352.04	H1100A-OH/8	Overhead Mount Track, 1100lb/panel, 8 Ft	\$1,056.70
900/2000	Top Guide Channel 2 Meters	\$126.87	H1100A-SW/10	Side Wall Mount Track, 1100lb/panel, 10 Ft	\$1,761.97
900/2500	Top Guide Channel 2.5 Meters	\$158.67	H1100A-SW/12	Side Wall Mount Track, 1100lb/panel, 12 Ft	\$1,834.74
900/3000	Top Guide Channel 3 Meters	\$190.31	H1100A-SW/16	Side Wall Mount Track, 1100lb/panel, 16 Ft	\$1,918.22
901/919H	Top Guide Roller	\$403.93	H1100A-SW/6	Side Wall Mount Track, 1100lb/panel, 6 Ft	\$1,257.33
901/919HD	Top Guide Roller	\$308.81	H1100A-SW/8	Side Wall Mount Track, 1100lb/panel, 8 Ft	\$1,390.63
901/919L	Top Guide Roller	\$33.35	2802A72	Dual Track Aluminum 6 Ft	\$82.35
902	Top Guide Roller	\$64.62	2802A96	Dual Track Aluminum 8 Ft	\$109.06
909H	Bottom Roller	\$1,235.00	2802A144	Dual Track Aluminum 12 Ft	\$163.59
913N	Bottom Roller Nylon	\$18.94	2802BT72	Dual Bottom Guide Channel 6 Ft	\$42.99
913XB	Bottom Roller Brass	\$72.42	2802BT96	Dual Bottom Guide Channel 8 Ft	\$57.32
915A72	Bottom Rail Aluminum 6 Ft	\$11.47	2802BT120	Dual Bottom Guide Channel 10 Ft	\$71.64
915A96	Bottom Rail Aluminum 8 Ft	\$15.29	2802BT144	Dual Bottom Guide Channel 12 Ft	\$85.97

Product Number	Description	List Price/ea	Product Number	Description	List Price/ea
2802D72	Dual Track Dark Bronze Aluminum 6 Ft	\$125.84	PF28200A7296-2x6	Pocket Frame Kit, 2 x 6 Wall	\$327.60
2802D96	Dual Track Dark Bronze Aluminum 8 Ft	\$166.40	PF28200A7296-SP6	Pocket Frame for Full 6" Net Stud	\$356.72
2802D180	Dual Track Dark Bronze Aluminum 15 Ft	\$251.68	PF28200A9680	Pocket Frame Kit	\$228.80
2803C144	Triple Track Aluminum 12 Ft	\$237.12	PF28200A9680-2x6	Pocket Frame Kit, 2 x 6 Wall	\$319.28
2803C180	Triple Track Aluminum 15 Ft	\$296.40	PF28200A9680-SP6	Pocket Frame for Full 6" Net Stud	\$343.88
2803D180	Triple Track Dark Bronze Aluminum 15 Ft	\$381.68	PF28200A9684	Pocket Frame Kit	\$227.76
2812KIT	Dual Sidewall Bracket Kit	\$15.90	PF28200A9684-2x6	Pocket Frame Kit, 2 x 6 Wall	\$319.28
2815	Husky Sidewall Bracket 5-Pack	\$6.63	PF28200A9684-SP6	Pocket Frame for Full 6" Net Stud	\$342.27
F3715FB	Flush Bolt	\$114.58	PF28200A9696	Pocket Frame Kit	\$243.36
F3734	Flush Bolt Floor Plate	\$23.94	PF28200A9696-2x6	Pocket Frame Kit, 2 x 6 Wall	\$334.88
PF28200A6080	Pocket Frame Kit	\$217.36	PF28200A9696-SP6	Pocket Frame for Full 6" Net Stud	\$365.30
PF28200A6080-2x6	Pocket Frame Kit, 2 x 6 Wall	\$307.84	DELLH	Delayed Timer, Left Hand	\$767.52
PF28200A6080-SP6	Pocket Frame for Full 6" Net Stud	\$326.72	DELRH	Delayed Timer, Right Hand	\$767.52
PF28200A6084	Pocket Frame Kit	\$217.36	FASCIACLIP	Pacer Fascia Clips 6-Pack	\$39.35
PF28200A6084-2x6	Pocket Frame Kit, 2 x 6 Wall	\$307.84	HUSKYWRENCH	Husky Wrench	\$6.41
PF28200A6084-SP6	Pocket Frame for Full 6" Net Stud	\$326.72	PFBG-4	Pocket Frame Kit, Bottom Guide	\$4.58
PF28200A6096	Pocket Frame Kit	\$232.96	PFBG-8	Pocket Frame Kit, Bottom Guide	\$4.58
PF28200A6096-2x6	Pocket Frame Kit, 2 x 6 Wall	\$319.28	PFBS	Pocket Frame Bumper Stop	\$1.93
PF28200A6096-SP6	Pocket Frame for Full 6" Net Stud	\$350.28	PFCDKIT	Converging Pocket Door Kit	\$54.08
PF28200A7280	Pocket Frame Kit	\$221.52	PFFC-4	Pocket Frame Kit, Floor Cleat	\$4.59
PF28200A7280-2x6	Pocket Frame Kit, 2 x 6 Wall	\$313.04	PFFC-8	Pocket Frame Kit, Floor Cleat	\$4.59
PF28200A7280-SP6	Pocket Frame for Full 6" Net Stud	\$333.17	PFKIT-4	Pocket Frame Hardware Kit	\$68.64
PF28200A7284	Pocket Frame Kit	\$221.52	PFKIT-8	Pocket Frame Hardware Kit	\$68.64
PF28200A7284-2x6	Pocket Frame Kit, 2 x 6 Wall	\$313.04	SIRF/2500	Sirocco Fascia	\$756.99
PF28200A7284-SP6	Pocket Frame for Full 6" Net Stud	\$334.21	SIRLH	Sirocco Self-Closing System, Left Hand	\$2,703.40
PF28200A7296	Pocket Frame Kit	\$238.16	SIRRH	Sirocco Self-Closing System, Right Hand	\$2,703.40

Stainless Steel Sliding Track System

Product Number	DESCRIPTION	Door Type	Door Weight	Track Length	List Price
G60/6	Stainless Steel Sliding Track System	Glass	Up to 198lbs.	6' 6" Length Track	\$561.00
G60/8	Stainless Steel Sliding Track System	Glass	Up to 198lbs.	8' 2" Length Track	\$617.00
G70/6	Stainless Steel Sliding Track System	Glass	Up to 240lbs.	6' 6" Length Track	\$701.00
G70/8	Stainless Steel Sliding Track System	Glass	Up to 240lbs.	8' 2" Length Track	\$756.00
G80/6	Stainless Steel Sliding Track System	Glass	Up to 198lbs.	6' 6" Length Track	\$584.00
G80/8	Stainless Steel Sliding Track System	Glass	Up to 198lbs.	8' 2" Length Track	\$639.00
G90/6	Stainless Steel Sliding Track System	Glass	Up to 198lbs.	6' 6" Length Track	\$876.00
G90/8	Stainless Steel Sliding Track System	Glass	Up to 198lbs.	8' 2" Length Track	\$934.00
G100/6	Stainless Steel Sliding Track System	Glass	Up to 198lbs.	6' 6" Length Track	\$665.00
G100/8	Stainless Steel Sliding Track System	Glass	Up to 198lbs.	8' 2" Length Track	\$724.00
W60/6	Stainless Steel Sliding Track System	Wood	Up to 176lbs.	6' 6" Length Track	\$494.00
W60/8	Stainless Steel Sliding Track System	Wood	Up to 176lbs.	8' 2" Length Track	\$552.00
W70/6	Stainless Steel Sliding Track System	Wood	Up to 240lbs.	6' 6" Length Track	\$636.00
W70/8	Stainless Steel Sliding Track System	Wood	Up to 240lbs.	8' 2" Length Track	\$692.00
W80/6	Stainless Steel Sliding Track System	Wood	Up to 176lbs.	6' 6" Length Track	\$494.00
W80/8	Stainless Steel Sliding Track System	Wood	Up to 176lbs.	8' 2" Length Track	\$552.00
W90/6	Stainless Steel Sliding Track System	Wood	Up to 176lbs.	6' 6" Length Track	\$621.00
W90/8	Stainless Steel Sliding Track System	Wood	Up to 176lbs.	8' 2" Length Track	\$679.00
W100/6	Stainless Steel Sliding Track System	Wood	Up to 198lbs.	6' 6" Length Track	\$614.00
W100/8	Stainless Steel Sliding Track System	Wood	Up to 198lbs.	8' 2" Length Track	\$672.00
STOP1	Stop- Optional for Stainless Steel Track Systems G30 and W70				\$43.00

Dark Bronze Stainless Steel Sliding Track System

Product Number	DESCRIPTION	Door Type	Door Weight	Track Length	List Price
G60D/6	Dark Bronze Stainless Steel Sliding Track System	Glass	Up to 198lbs.	6' 6" Length Track	\$694.00
G60D/8	Dark Bronze Stainless Steel Sliding Track System	Glass	Up to 198lbs.	8' 2" Length Track	\$763.00
G70D/6	Dark Bronze Stainless Steel Sliding Track System	Glass	Up to 240lbs.	6' 6" Length Track	\$874.00
G70D/8	Dark Bronze Stainless Steel Sliding Track System	Glass	Up to 240lbs.	8' 2" Length Track	\$945.00
G80D/6	Dark Bronze Stainless Steel Sliding Track System	Glass	Up to 198lbs.	6' 6" Length Track	\$732.00
G80D/8	Dark Bronze Stainless Steel Sliding Track System	Glass	Up to 198lbs.	8' 2" Length Track	\$801.00
G90D/6	Dark Bronze Stainless Steel Sliding Track System	Glass	Up to 198lbs.	6' 6" Length Track	\$1,117.00
G90D/8	Dark Bronze Stainless Steel Sliding Track System	Glass	Up to 198lbs.	8' 2" Length Track	\$1,187.00
G100D/6	Dark Bronze Stainless Steel Sliding Track System	Glass	Up to 198lbs.	6' 6" Length Track	\$829.00
G100D/8	Dark Bronze Stainless Steel Sliding Track System	Glass	Up to 198lbs.	8' 2" Length Track	\$899.00
W60D/6	Dark Bronze Stainless Steel Sliding Track System	Wood	Up to 176lbs.	6' 6" Length Track	\$620.00
W60D/8	Dark Bronze Stainless Steel Sliding Track System	Wood	Up to 176lbs.	8' 2" Length Track	\$690.00
W70D/6	Dark Bronze Stainless Steel Sliding Track System	Wood	Up to 240lbs.	6' 6" Length Track	\$777.00
W70D/8	Dark Bronze Stainless Steel Sliding Track System	Wood	Up to 240lbs.	8' 2" Length Track	\$899.00
W80D/6	Dark Bronze Stainless Steel Sliding Track System	Wood	Up to 176lbs.	6' 6" Length Track	\$612.00
W80D/8	Dark Bronze Stainless Steel Sliding Track System	Wood	Up to 176lbs.	8' 2" Length Track	\$681.00
W90D/6	Dark Bronze Stainless Steel Sliding Track System	Wood	Up to 176lbs.	6' 6" Length Track	\$769.00
W90D/8	Dark Bronze Stainless Steel Sliding Track System	Wood	Up to 176lbs.	8' 2" Length Track	\$839.00
W100D/6	Dark Bronze Stainless Steel Sliding Track System	Wood	Up to 198lbs.	6' 6" Length Track	\$762.00
W100D/8	Dark Bronze Stainless Steel Sliding Track System	Wood	Up to 198lbs.	8' 2" Length Track	\$831.00
DSTOP1	Dark Bronze Stop- Optional for Dark Bronze Stainless Steel Track Systems G30 and W70				\$52.00

Polished Stainless Steel Sliding Track System

Product Number	DESCRIPTION	Door Type	Door Weight	Track Length	List Price
G60P/6	Polished Stainless Steel Sliding Track System	Glass	Up to 198lbs.	6' 6" Length Track	\$643.00
G60P/8	Polished Stainless Steel Sliding Track System	Glass	Up to 198lbs.	8' 2" Length Track	\$740.00
G70P/6	Polished Stainless Steel Sliding Track System	Glass	Up to 240lbs.	6' 6" Length Track	\$806.00
G70P/8	Polished Stainless Steel Sliding Track System	Glass	Up to 240lbs.	8' 2" Length Track	\$907.00
G80P/6	Polished Stainless Steel Sliding Track System	Glass	Up to 198lbs.	6' 6" Length Track	\$671.00
G80P/8	Polished Stainless Steel Sliding Track System	Glass	Up to 198lbs.	8' 2" Length Track	\$767.00
G90P/6	Polished Stainless Steel Sliding Track System	Glass	Up to 198lbs.	6' 6" Length Track	\$1,066.00
G90P/8	Polished Stainless Steel Sliding Track System	Glass	Up to 198lbs.	8' 2" Length Track	\$1,121.00
G100P/6	Polished Stainless Steel Sliding Track System	Glass	Up to 198lbs.	6' 6" Length Track	\$766.00
G100P/8	Polished Stainless Steel Sliding Track System	Glass	Up to 198lbs.	8' 2" Length Track	\$869.00
W60P/6	Polished Stainless Steel Sliding Track System	Wood	Up to 176lbs.	6' 6" Length Track	\$568.00
W60P/8	Polished Stainless Steel Sliding Track System	Wood	Up to 176lbs.	8' 2" Length Track	\$662.00
W70P/6	Polished Stainless Steel Sliding Track System	Wood	Up to 240lbs.	6' 6" Length Track	\$732.00
W70P/8	Polished Stainless Steel Sliding Track System	Wood	Up to 240lbs.	8' 2" Length Track	\$830.00
W80P/6	Polished Stainless Steel Sliding Track System	Wood	Up to 176lbs.	6' 6" Length Track	\$568.00
W80P/8	Polished Stainless Steel Sliding Track System	Wood	Up to 176lbs.	8' 2" Length Track	\$662.00
W90P/6	Polished Stainless Steel Sliding Track System	Wood	Up to 176lbs.	6' 6" Length Track	\$731.00
W90P/8	Polished Stainless Steel Sliding Track System	Wood	Up to 176lbs.	8' 2" Length Track	\$815.00
W100P/6	Polished Stainless Steel Sliding Track System	Wood	Up to 198lbs.	6' 6" Length Track	\$722.00
W100P/8	Polished Stainless Steel Sliding Track System	Wood	Up to 198lbs.	8' 2" Length Track	\$806.00
PSTOP1	Dark Bronze Stop- Optional for Polished Stainless Steel Track Systems G30 and W70				\$52.00

Simultaneous Acting Door System (SIM150)

Complete Kit Pricing:

List prices shown include clear anodized track. Optional dark bronze track is available at additional charge.

	Kit Includes	List Price
2-Door Non-locking	system, track (1 run @ 147"), hardware	\$1,870.00
2-Door Locking	system, track (1 run @ 147"), hardware	\$1,875.00
3-Door Non-locking	system, track (1 run @ 185"), hardware	\$2,240.00
3-Door Locking	system, track (1 run @ 185"), hardware	\$2,245.00
4-Door Non-locking	system, track (2 runs @ 147" each), hardware	\$3,740.00
4-Door Locking	system, track (2 runs @ 147" each), hardware	\$3,745.00
6-Door Non-locking	system, track (2 runs @ 185" each), hardware	\$4,480.00
6-Door Locking	system, track (2 runs @ 185" each), hardware	\$4,485.00

SIM150 Pulley System

	Product Number	List Price
Two Door	SIM150-2-LH/25-32	\$1,534.00
	SIM150-2-LH/33-40	\$1,534.00
	SIM150-2-LH/41-48	\$1,534.00
	SIM150-2-RH/25-32	\$1,534.00
	SIM150-2-RH/33-40	\$1,534.00
	SIM150-2-RH/41-48	\$1,534.00
Three Door	SIM150-3-LH/25-32	\$1,768.00
	SIM150-3-LH/33-40	\$1,768.00
	SIM150-3-LH/41-48	\$1,768.00
	SIM150-3-RH/25-32	\$1,768.00
	SIM150-3-RH/33-40	\$1,768.00
	SIM150-3-RH/41-48	\$1,768.00
Four Door	SIM150-4/25-32	\$3,067.00
	SIM150-4/33-40	\$3,067.00
	SIM150-4/41-48	\$3,067.00
Six Door	SIM150-6/25-32	\$3,535.00
	SIM150-6/33-40	\$3,535.00
	SIM150-6/41-48	\$3,535.00

SIM150 Track

	Product Number	List Price
Clear (C)	2802C144	\$164.00
	2803C180	\$296.00
Dark Bronze (D)	2802D180	\$252.00
	2803D180	\$382.00

Optional Hardware Kits (order full kit or individual parts)

	Product Number	List Price
Non-locking	SIM150-BOLTKIT	\$190.00
	570 -Dust-Proof Strike	\$31.00
	630-12 -Surface Bolt	\$123.00
	880 -Edge Pull	\$21.00
	503SF -Cup Pull	\$16.00
Locking	SIM150-LOCKKIT	\$195.00
	1422 -Lock with Edge Pull	\$162.00
	503SF -Cup Pull	\$16.00
	503CF -Cup Pull with Keyway	\$17.00

Lite Kits LT-B1

- Order size is Exposed Glass Size, W x H
- Min. Exposed Glass = 2". Max. Exposed Glass = 70"
- No Glazing Materials Included with any order

	← WIDTH →																
	3	4	5	6	8	10	12	14	16	18	20	22	24	26	28	30	
4	\$51																4
5	51	51	51														5
6	51	51	51	51													6
8	51	51	51	51	51												8
10	51	51	51	51	51	48											10
12	55	55	55	55	55	55	55										12
14	57	57	57	59	61	63	65	67									14
16	59	59	59	61	63	65	67	69	71								16
18	61	61	61	63	65	67	69	71	73	76							18
20	61	61	59	63	65	67	69	71	73	76	76						20
22	61	61	61	63	65	67	69	71	73	76	76	78					22
24	61	61	63	65	67	69	71	73	76	76	78	80	84				24
26	65	*64	69	71	73	76	78	80	82	82	83	83	85	87			26
28	69	69	71	71	73	76	78	80	82	82	83	83	85	87	90		28
30	69	69	71	71	75	78	81	82	82	84	87	90	92	96	96	102	30
32	69	71	73	76	78	80	82	84	86	88	90	92	96	96	102	104	32
33	71	73	76	78	80	82	84	86	88	90	92	93	96	96	102	104	33
34	71	73	76	78	80	82	84	86	88	90	92	94	96	96	102	104	34
36	75	77	79	82	83	85	88	89	91	93	96	96	100	104	106	106	36
38	82	85	88	90	91	92	93	93	94	96	97	97	98	104	106	106	38
40	89	92	96	98	99	100	102	102	103	104	105	105	106	107	108	109	40
42	97	100	104	106	107	108	109	109	110	111	112	112	113	114	115	116	42
44	106	109	112	114	115	116	118	118	119	120	121	121	122	123	124	125	44
46	113	116	120	122	123	124	125	125	126	127	128	128	129	130	131	132	46
48	121	124	127	129	130	131	132	132	133	134	135	135	136	137	139	140	48
50	128	131	134	136	137	139	140	140	141	142	143	143	144	145	146	147	50
52	135	139	142	144	145	146	147	147	148	149	150	150	151	152	153	154	52
54	143	146	149	151	152	153	154	154	155	156	157	157	158	160	161	162	54
56	150	153	156	158	160	161	162	162	163	164	165	165	166	167	168	170	56
58	157	161	164	166	167	168	170	170	171	172	173	173	174	175	176	177	58
60	163	166	170	172	173	174	175	176	177	177	178	178	179	180	182	183	60
62	167	171	174	176	177	178	179	180	182	182	183	183	184	185	186	187	62
64	172	175	178	180	182	183	184	185	186	186	187	187	188	189	190	191	64
66	173	176	179	182	183	184	185	186	187	187	188	188	189	190	191	192	66
	3	4	5	6	8	10	12	14	16	18	20	22	24	26	28	30	

* = 4 x 26 represents 4 x 25 stocked kit. ITEMS SHADED IN DARK GRAY ARE "IN STOCK" ITEMS

FINISH:

Stock - Beige Powder Coat (B), Dark Bronze Duranodic Powder Coat (D) and Gray Primer Powder Coat (G).....No Additional Charge

TORX FASTENERS:

Up to 24" x 24"\$12.50 List
 Over 24" x 24"\$24.50 List

OTHER SIZES:

Odd Inch Sizes.....Use Next Largest Even Inch
 Fractional Sizes.....Use Next Largest Even Inch

MATERIAL (Metal):

Stainless Steel #304, #4 finish (satin)List x 4

SECURITY GRILLS:

Welded to Exterior FrameContact Factory

CHANGE ORDER:.....\$35 NET processing charge after order is entered

Call PEMKO for lead time & price quote on items or finishes not shown.

Lite Kits CO-B1

- Order size is Cut Out Size, W x H
- No Glazing Materials Included with any order

		← WIDTH →																	
	5	6	7	8	10	12	14	16	18	20	22	24	26	28	30	32			
6	\$51																6		
7	51	51	51														7		
8	51	51	51	51													8		
10	51	51	51	51	51												10		
12	51	51	51	51	51	48											12		
14	55	55	55	55	55	55	55										14		
16	57	57	57	59	61	63	65	67									16		
18	59	59	59	61	63	65	67	69	71								18		
20	61	61	61	63	65	67	69	71	73	76							20		
22	61	61	59	63	65	67	69	71	73	76	76						22		
24	61	61	61	63	65	67	69	71	73	76	76	78					24		
26	61	61	63	65	67	69	71	73	76	76	78	80	84				26		
28	65	*64	69	71	73	76	78	80	82	82	83	83	85	87			28		
30	69	69	71	71	73	76	78	80	82	82	83	83	85	87	90		30		
32	69	69	71	71	75	78	81	82	82	84	87	90	92	96	96	102	32		
33	69	71	73	76	78	80	82	84	86	88	90	92	96	96	102	104	33		
34	71	73	76	78	80	82	84	86	88	90	92	93	96	96	102	104	34		
36	71	73	76	78	80	82	84	86	88	90	92	94	96	96	102	104	36		
38	75	77	79	82	83	85	88	89	91	93	96	96	100	104	106	106	38		
40	82	85	88	90	91	92	93	93	94	96	97	97	98	104	106	106	40		
42	89	92	96	98	99	100	102	102	103	104	105	105	106	107	108	109	42		
44	97	100	104	106	107	108	109	109	110	111	112	112	113	114	115	116	44		
46	106	109	112	114	115	116	118	118	119	120	121	121	122	123	124	125	46		
48	113	116	120	122	123	124	125	125	126	127	128	128	129	130	131	132	48		
50	121	124	127	129	130	131	132	132	133	134	135	135	136	137	139	140	50		
52	128	131	134	136	137	139	140	140	141	142	143	143	144	145	146	147	52		
54	135	139	142	144	145	146	147	147	148	149	150	150	151	152	153	154	54		
56	143	146	149	151	152	153	154	154	155	156	157	157	158	160	161	162	56		
58	150	153	156	158	160	161	162	162	163	164	165	165	166	167	168	170	58		
60	157	161	164	166	167	168	170	170	171	172	173	173	174	175	176	177	60		
62	163	166	170	172	173	174	175	176	177	177	178	178	179	180	182	183	62		
64	167	171	174	176	177	178	179	180	182	182	183	183	184	185	186	187	64		
66	172	175	178	180	182	183	184	185	186	186	187	187	188	189	190	191	66		
68	173	176	179	182	183	184	185	186	187	187	188	188	189	190	191	192	68		
	5	6	7	8	10	12	14	16	18	20	22	24	26	28	30	32			

* = 6 x 28 represents 6 x 27 stocked kit. ITEMS SHADED IN DARK GRAY ARE "IN STOCK" ITEMS

FINISH:

Stock - Beige Powder Coat (B), Dark Bronze Duranodic Powder Coat (D) and Gray Primer Powder Coat (G).....No Additional Charge

TORX FASTENERS:

Up to 26" x 26".....\$12.50 List
Over 26" x 26".....\$24.50 List

OTHER SIZES:

Odd Inch Sizes.....Use Next Largest Even Inch
Fractional Sizes.....Use Next Largest Even Inch

MATERIAL (Metal):

Stainless Steel #304, #4 finish (satin).....List x 4

SECURITY GRILLS:

Welded to Exterior Frame.....Contact Factory

CHANGE ORDER:

\$35 NET processing charge after order is entered

Call PEMKO for lead time & price quote on items or finishes not shown.

Lite Kits LT-B2 to LT-B4

- Order size is Exposed Glass Size, W x H
- Min. Exposed Glass = 2". Max. Exposed Glass = 70"
- No Glazing Materials Included with any order

	← WIDTH →																
	3	4	5	6	8	10	12	14	16	18	20	22	24	26	28	30	
4	\$77																4
5	77	77	77														5
6	77	77	77	77													6
8	77	77	77	77	77												8
10	77	77	77	77	77	77											10
12	82	82	82	82	82	82	82										12
14	85	85	85	88	91	94	98	102									14
16	88	88	88	91	94	98	102	105	108								16
18	91	91	91	94	98	102	105	108	111	114							18
20	91	91	91	94	98	102	105	108	111	114	114						20
22	91	91	91	94	98	102	105	108	111	114	114	118					22
24	91	91	94	98	102	105	108	111	114	114	118	121	127				24
26	98	102	105	108	111	114	118	121	124	124	125	125	128	131			26
28	105	105	108	108	111	114	118	121	124	124	125	125	128	131	136		28
30	105	105	108	108	112	118	122	124	124	127	131	136	140	144	144	152	30
32	105	108	111	114	118	121	124	127	130	133	136	140	144	144	152	155	32
33	108	111	114	118	121	124	127	130	133	136	140	141	144	144	152	155	33
34	108	111	114	118	121	124	127	130	133	136	140	143	144	144	152	155	34
36	112	115	119	124	125	128	133	134	137	141	144	144	150	155	158	158	36
38	124	128	133	136	137	140	141	141	143	144	146	146	147	155	158	158	38
40	134	140	144	147	149	150	152	152	153	155	156	156	158	160	162	163	40
42	146	150	155	158	160	162	163	163	165	166	168	168	170	172	173	175	42
44	158	163	168	172	173	175	176	176	178	179	182	182	183	185	186	188	44
46	170	175	179	183	185	186	188	188	189	191	192	192	194	195	197	198	46
48	182	186	191	194	195	197	198	198	200	201	204	204	205	207	208	210	48
50	192	197	201	205	207	208	210	210	211	213	214	214	216	217	219	220	50
52	204	208	213	216	217	219	220	220	222	224	226	226	227	229	230	232	52
54	214	219	224	227	229	230	232	232	233	235	236	236	239	240	242	243	54
56	226	230	235	239	240	242	243	243	246	247	249	249	250	252	253	255	56
58	236	242	247	250	252	253	255	255	256	258	259	259	261	262	264	265	58
60	246	250	255	258	259	261	262	264	265	265	268	268	269	271	272	274	60
62	252	256	261	264	265	268	269	271	272	272	274	274	275	277	278	280	62
64	258	262	268	271	272	274	275	277	278	278	280	280	281	283	284	286	64
66	259	264	269	272	274	275	277	278	280	280	281	281	283	284	286	288	66
	3	4	5	6	8	10	12	14	16	18	20	22	24	26	28	30	

HEIGHT

FINISH:

Stock - Beige Powder Coat (B), Dark Bronze Duranodic Powder Coat (D) and Gray Primer Powder Coat (G).....No Additional Charge

TORX FASTENERS:

Up to 24" x 24".....\$12.50 List
 Over 24" x 24".....\$24.50 List

OTHER SIZES:

Odd Inch Sizes.....Use Next Largest Even Inch
 Fractional Sizes.....Use Next Largest Even Inch

MATERIAL (Metal):

Stainless Steel #304, #4 finish (satin)List x 4

SECURITY GRILLS:

Welded to Exterior FrameContact Factory

CHANGE ORDER:.....\$35 NET processing charge after order is entered

Call PEMKO for lead time & price quote on items or finishes not shown.

Lite Kits LT-S2 to LT-S4

- Order size is Exposed Glass Size, W x H
- Min. Exposed Glass = 2". Max. Exposed Glass = 70"
- No Glazing Materials Included with any order

	← WIDTH →																
	3	4	5	6	8	10	12	14	16	18	20	22	24	26	28	30	
4	\$96																4
5	96	96	96														5
6	96	96	96	96													6
8	96	96	96	96	96												8
10	96	96	96	96	96	96											10
12	103	103	103	103	103	103	103										12
14	106	106	106	110	114	119	122	126									14
16	110	110	110	114	119	122	126	130	134								16
18	114	114	114	119	122	126	130	134	137	142							18
20	114	114	114	119	122	126	130	134	137	142	142						20
22	114	114	114	119	122	126	130	134	137	142	142	146					22
24	114	114	119	122	126	130	134	137	142	142	146	150	157				24
26	122	126	130	134	137	142	146	150	153	153	155	155	160	164			26
28	130	130	134	134	137	142	146	150	153	153	155	155	160	164	170		28
30	130	130	134	134	140	146	152	153	153	157	164	170	174	180	180	190	30
32	130	134	137	142	146	150	153	157	162	166	170	174	180	180	190	194	32
33	134	137	142	146	150	153	157	162	166	170	174	176	180	180	190	194	33
34	134	137	142	146	150	153	157	162	166	170	174	178	180	180	190	194	34
36	140	144	148	153	155	160	166	168	172	176	180	180	188	194	198	198	36
38	153	160	166	170	172	174	176	176	178	180	183	183	188	194	198	198	38
40	168	174	180	185	186	188	190	190	192	194	196	196	198	200	201	204	40
42	183	188	194	198	200	201	204	204	206	208	210	210	212	214	216	217	42
44	198	204	210	214	216	217	219	219	221	224	226	226	228	230	232	233	44
46	212	217	224	228	230	232	233	233	235	238	240	240	242	244	247	249	46
48	226	232	238	242	244	247	249	249	250	252	254	254	256	258	260	262	48
50	240	247	252	256	258	260	262	262	264	265	268	268	270	272	274	276	50
52	254	260	265	270	272	274	276	276	278	280	281	281	283	285	288	290	52
54	268	274	280	283	285	288	290	290	292	294	296	296	297	299	301	303	54
56	281	288	294	297	299	301	303	303	306	308	311	311	313	314	316	318	56
58	296	301	308	313	314	316	318	318	320	322	324	324	326	328	329	332	58
60	306	313	318	322	324	326	328	329	332	332	334	334	336	338	340	342	60
62	314	320	326	329	332	334	336	338	340	340	342	342	344	345	347	349	62
64	322	328	334	338	340	342	344	345	347	347	349	349	352	354	356	358	64
66	324	329	336	340	342	344	345	347	349	349	352	352	354	356	358	360	66
	3	4	5	6	8	10	12	14	16	18	20	22	24	26	28	30	

FINISH:

Stock - Beige Powder Coat (B), Dark Bronze Duranodic Powder Coat (D) and Gray Primer Powder Coat (G).....No Additional Charge

TORX FASTENERS:

Up to 24" x 24".....\$12.50 List
Over 24" x 24".....\$24.50 List

OTHER SIZES:

Odd Inch Sizes.....Use Next Largest Even Inch
Fractional Sizes.....Use Next Largest Even Inch

MATERIAL (Metal):

Stainless Steel #304, #4 finish (satin)List x 4

SECURITY GRILLS:

Welded to Exterior FrameContact Factory

CHANGE ORDER:

.....\$35 NET processing charge after order is entered

Call PEMKO for lead time & price quote on items or finishes not shown.

G-2

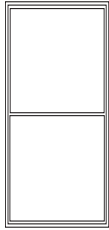

Vision Lites
 List x 2.5
 Muntins are
 1/2" x 1/2"

G-3



Vision Lites
 List x 3.5
 Muntins are
 1/2" x 1/2"

G-4

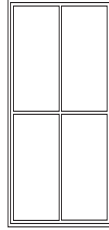

Vision Lites
 List x 3.5
 Muntins are
 1/2" x 1/2"

G-5



Vision Lites
 List x 4
 Muntins are
 1/2" x 1/2"

G-6

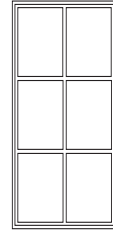

Vision Lites
 List x 4
 Muntins are
 1/2" x 1/2"

G-8

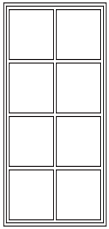

Vision Lites
 List x 4
 Muntins are
 1/2" x 1/2"

G-9

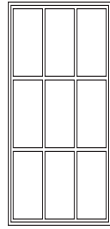

Vision Lites
 List x 4
 Muntins are
 1/2" x 1/2"

G-10

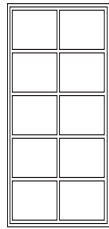

Vision Lites
 List x 4.5
 Muntins are
 1/2" x 1/2"

G-12

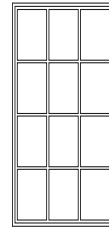

Vision Lites
 List x 5
 Muntins are
 1/2" x 1/2"

G-15

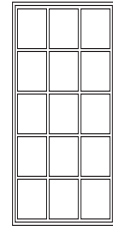

Vision Lites
 List x 6
 Muntins are
 1/2" x 1/2"

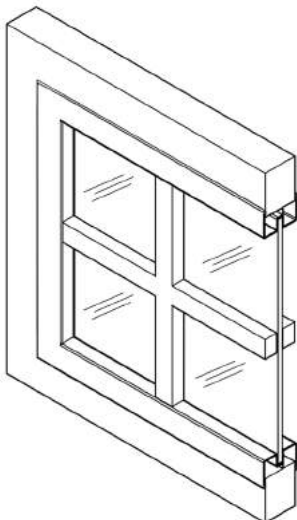

VISION LITES:

- Only for use in LT-S1 to LT-S4 ("S" Series).

FINISH:

Stock - Beige Powder Coat (B), Dark Bronze Duranodic Powder Coat (D) and Gray Primer Powder Coat (G).....No Additional Charge

FASTENERS:

Security Screws..... List + 10%

OTHER SIZES:

Odd Inch Sizes.....Use Next Largest Even Inch

Fractional Sizes..... List + 20%

CHANGE ORDER:.....\$35 NET processing charge after order is entered

Call PEMKO for lead time & price quote on items or finishes not shown.

Lite Kits LT-S1

- Order size is Exposed Glass Size, W x H
- Min. Exposed Glass = 2". Max. Exposed Glass = 70"
- No Glazing Materials Included with any order

	← WIDTH →																
	3	4	5	6	8	10	12	14	16	18	20	22	24	26	28	30	
4	\$64																4
5	64	64	64														5
6	64	64	64	64													6
8	64	64	64	64	64												8
10	64	64	64	64	64	64											10
12	68	68	68	68	68	68	68										12
14	70	70	70	73	76	79	81	84									14
16	73	73	73	76	79	81	84	86	89								16
18	76	76	76	79	81	84	86	89	91	94							18
20	76	76	76	79	81	84	86	89	91	94	94						20
22	76	76	76	79	81	84	86	89	91	94	94	97					22
24	76	76	79	81	84	86	89	91	94	94	97	100	106				24
26	81	84	86	89	91	94	97	100	103	103	105	105	107	110			26
28	86	86	89	89	91	94	97	100	103	103	105	105	107	110	113		28
30	86	86	89	89	93	97	102	103	103	106	110	113	116	121	121	127	30
32	86	89	91	94	97	100	103	106	108	111	113	116	121	121	127	129	32
33	89	91	94	97	100	103	106	108	111	113	116	118	121	121	127	129	33
34	89	91	94	97	100	103	106	108	111	113	116	119	121	121	127	129	34
36	93	96	99	103	105	107	111	112	115	118	121	121	126	129	132	132	36
38	103	107	111	113	115	116	118	118	119	121	122	122	126	129	132	132	38
40	112	116	121	123	124	126	127	127	128	129	131	131	132	133	134	136	40
42	122	126	129	132	133	134	136	136	137	139	140	140	142	143	144	145	42
44	132	136	140	143	144	145	147	147	148	149	150	150	152	153	154	155	44
46	142	145	149	152	153	154	155	155	157	158	160	160	161	163	164	165	46
48	150	154	158	161	163	164	165	165	166	168	170	170	171	172	174	175	48
50	160	164	168	171	172	174	175	175	176	177	179	179	180	182	183	185	50
52	170	174	177	180	182	183	185	185	186	187	188	188	190	191	192	193	52
54	179	183	187	190	191	192	193	193	195	196	197	197	198	200	201	203	54
56	188	192	196	198	200	201	203	203	204	206	207	207	208	209	211	212	56
58	197	201	206	208	209	211	212	212	213	214	216	216	217	218	219	221	58
60	204	208	212	214	216	217	218	219	221	221	222	222	224	225	227	228	60
62	209	213	217	219	221	222	224	225	227	227	228	228	229	230	232	233	62
64	214	218	222	225	227	228	229	230	232	232	233	233	234	235	238	239	64
66	216	219	224	227	228	229	230	232	233	233	234	234	235	238	239	240	66
	3	4	5	6	8	10	12	14	16	18	20	22	24	26	28	30	

FINISH:

Stock - Beige Powder Coat (B), Dark Bronze Duranodic Powder Coat (D) and Gray Primer Powder Coat (G).....No Additional Charge

TORX FASTENERS:

Up to 24" x 24"\$12.50 List
Over 24" x 24"\$24.50 List

OTHER SIZES:

Odd Inch Sizes.....Use Next Largest Even Inch
Fractional Sizes.....Use Next Largest Even Inch

MATERIAL (Metal):

Stainless Steel #304, #4 finish (satin)List x 4

SECURITY GRILLS:

Welded to Exterior FrameContact Factory

CHANGE ORDER:

.....\$35 NET processing charge after order is entered

Call PEMKO for lead time & price quote on items or finishes not shown.

Louvers (LV-FL)

ITEMS SHADED IN DARK GRAY ARE "IN STOCK" ITEMS

← WIDTH →

	12	18	24	
12	\$180	187	206	↑ HEIGHT ↓
18	258	220	239	
24	277	287	246	

Louvers (LV-IY)

Order size is Cutout Size, W x H

← WIDTH →

	6	8	10	12	14	16	18	20	22	24	26	28	30	
6	\$61	65	69	73	77	81	81	85	88	88	90	92	94	↑ H E I G H T ↓
8	61	65	69	73	77	81	81	85	88	88	90	92	94	
10	64	68	72	76	80	84	84	89	91	91	93	95	97	
12	67	71	75	79	83	85	85	89	91	91	95	98	102	
14	72	74	76	79	81	84	88	92	94	94	97	101	105	
16	77	79	81	84	87	90	91	95	97	97	100	104	108	
18	82	84	87	89	91	93	93	97	99	102	105	109	113	
20	88	90	92	94	96	97	99	101	103	105	110	114	118	
22	93	97	98	100	102	104	106	108	110	112	115	119	124	
24	97	100	103	106	109	113	116	119	122	124	127	130	133	
26	108	111	114	117	121	125	128	131	133	135	138	141	144	
28	119	123	126	129	132	136	139	142	144	145	148	151	155	
30	131	134	137	140	143	146	149	152	155	157	160	163	166	
32	142	144	147	150	153	158	161	164	166	168	171	174	177	
34	153	157	160	163	166	170	173	176	178	180	183	186	190	
36	165	168	171	174	177	181	184	187	190	192	194	197	200	
38	176	179	182	185	188	193	195	198	200	202	205	208	211	
40	188	192	194	197	200	204	207	210	212	214	217	220	224	
42	199	202	205	208	211	215	218	221	224	226	229	232	235	
44	210	213	216	219	222	227	230	233	235	237	240	242	245	
46	221	225	228	231	234	238	241	243	245	247	250	253	256	
48	234	237	240	242	245	249	252	255	258	260	263	266	269	
50	244	247	250	253	256	261	264	267	269	271	274	277	280	
52	255	259	262	265	268	272	275	278	280	282	285	288	290	
54	268	271	274	277	280	284	287	289	291	294	297	300	303	
56	279	282	285	288	290	295	298	301	303	305	308	311	314	
58	289	293	296	299	302	306	309	312	314	316	319	322	325	
60	301	304	307	310	313	317	320	323	325	329	331	334	337	
62	305	308	311	314	317	321	323	328	332	337	341	344	347	
64	309	312	315	318	321	325	327	333	338	344	352	355	358	
66	313	316	319	322	325	329	329	340	346	353	362	370	378	

FINISH:

Stock - Beige Powder Coat (B), Dark Bronze Duranodic Powder Coat (D) and Gray Primer Powder Coat (G).....No Additional Charge

TORX FASTENERS:

Up to 24" x 24".....\$12.50 List
 Over 24" x 24".....\$24.50 List

MATERIAL (Metal):

Stainless Steel #304, #4 finish (satin) (LY-IY Only).....List x 4

SECURITY GRILLS:

Welded to Exterior FrameContact Factory

INSECT SCREENS:

Non-removable Insect Screen.....Contact Factory

CHANGE ORDER:.....\$35 NET processing charge after order is entered

Call PEMKO for lead time & price quote on items or finishes not shown.

Windstorm Louvers (LV-WS)

Order size is Cutout Size, W x H

	WIDTH											
	12	14	16	18	20	22	24	26	28	30	32	34
12	198	203	214	240	214	234	229	245	266	245	260	281
14	203	219	203	224	219	245	266	250	266	286	307	276
18	240	224	229	255	245	271	297	271	292	312	333	354
20	214	219	250	245	271	302	276	302	323	344	370	390
22	234	245	240	271	302	281	307	328	354	380	406	432
24	229	266	260	297	276	307	333	359	385	416	442	468
26	245	250	286	271	302	328	359	390	422	448	479	510
28	266	266	307	292	323	354	385	422	453	484	515	448
30	245	286	276	312	344	380	416	448	484	515	453	479
32	260	307	297	333	370	406	442	479	515	453	484	510
34	281	276	312	354	390	432	468	510	448	479	510	546
36	297	292	333	375	416	458	500	536	474	510	541	578
38	266	307	349	396	437	479	526	463	500	536	572	609
40	276	323	370	416	458	505	453	489	526	562	604	640
42	292	338	385	437	484	531	474	515	552	593	630	598
44	307	354	406	458	505	458	500	536	578	619	588	624
46	318	370	422	479	531	479	520	562	604	650	614	656
48	333	385	442	500	453	500	541	588	630	604	640	682
50	344	401	458	515	468	515	562	609	656	624	666	708
52	359	422	479	536	489	536	588	635	609	650	697	739
54	375	437	500	458	510	557	609	588	630	676	723	765
56	385	453	515	474	526	578	630	609	656	702	749	796
58	401	468	536	489	546	598	656	630	676	728	775	822
60	416	484	453	510	562	619	604	650	702	749	801	853
62	427	500	468	526	583	640	624	671	723	775	827	879
64	442	515	484	541	604	588	640	697	749	801	853	910
66	458	531	500	557	619	609	661	718	770	827	879	936
68	468	448	510	578	640	624	682	739	796	853	910	962
70	396	463	526	593	656	645	702	760	817	874	936	994
72	406	474	541	609	604	661	723	780	843	900	962	1020
74	416	489	557	624	619	682	744	801	864	926	988	1051
76	432	500	572	645	635	697	760	827	890	952	1014	1077
78	442	515	588	588	650	718	780	848	910	978	1040	1108

FINISH:

Stock - Beige Powder Coat (B), Dark Bronze Duranodic Powder Coat (D) and Gray Primer Powder Coat (G) ... **No Additional Charge**

INSECT SCREENS:

Non-removable Insect Screen **Contact Factory**

CHANGE ORDER: .. **\$35 NET** processing charge after order is entered

Call PEMKO for lead time & price quote on items or finishes not shown.

Product Number	Description	Pack	List Price	Product Number	Description	Pack	List Price
BA5-50PK	Base anchor 4-3/4" and 5-3/4" masonry frames	50	\$97.24	LF6-25PK	Flushbolt door filler; 1" x 6-3/4"	25	\$201.50
BA6-50PK	Base anchor 6-3/4" and 7-3/4" masonry frames	50	\$143.26	MA4-25PK	4-3/4" mullion base anchor	25	\$185.64
BA8-50PK	Base anchor 8-3/4" masonry frames	50	\$117.78	MA5-25PK	5-3/4" mullion base anchor	25	\$114.04
CA1-50PK	Anchor for 4-3/4" and 5-3/4" masonry frames	50	\$81.12	MB1-50PK	Hinge mortar box	50	\$141.08
CA2-50PK	Anchor for 6-3/4" to 8-3/4" masonry frames	50	\$145.86	RF1-25PK	Reversible flushbolt strike reinforcing w/strike	25	\$328.90
CB1-50PK	2" face frame corner filler	50	\$42.38	SB1-25PK	4-7/8" strike filler	25	\$106.08
CB2-50PK	2-5/8" face frame corner filler	50	\$45.24	SB3-25PK	2-3/4" T-strike filler	25	\$95.42
CB3-50PK	4" face frame corner filler	50	\$47.84	SB4-25PK	Deadlock strike filler; 1-1/8 x 2-1/4"	25	\$90.22
CR2-5PK	Closer reinforcing 12" flat	5	\$15.86	SB5-25PK	Flushbolt strike filler	25	\$74.36
CR3-20PK	Closer reinforcing 14 gauge half closer sleeve	20	\$164.58	SR1-10PK	2-3/4" T-strike reinforcing	10	\$53.04
DC1-10PK	Door channel, 10'0"	10	\$179.40	SR2-10PK	4-7/8" ASA Strike reinforcing	10	\$53.04
DC2-10PK	Door channel, 8'0"	10	\$133.64	TC1-10PK	Screw-in flush top cap, 3'0"	10	\$159.12
DC3-10PK	Door cap with flushbolt guide, 4'0"	10	\$74.36	TC2-10PK	Screw-in flush top cap, 3'6"	10	\$171.86
DT1-50PK	Deadlock/spring latch bolt tab, for door	50	\$159.12	TC3-10PK	Screw-in flush top cap, 4'0"	10	\$171.86
DT2-50PK	Flushbolt guide tab, for door	50	\$159.12	WA1-100PK	Wire masonry anchors	100	\$106.08
DT3-50PK	Mortise lock tab	50	\$159.12	XT1-100PK	Twist-in existing wall anchors, 4-3/4" to 6-3/4"	100	\$212.16
DT4-50PK	Flushbolt tab - offset, for door	50	\$159.12	XW1-100PK	4-3/4" existing wall anchor; unequal rabbet	100	\$976.04
DT5-50PK	Flushbolt tab - not offset, for door	50	\$106.08	XW2-100PK	5-3/4" existing wall anchor; equal rabbet	100	\$947.28
EA1-25PK	Mortise lock edge to 4-7/8" strike adapter	25	\$728.78	XW3-100PK	5-3/4" existing wall anchor; unequal rabbet	100	\$1034.28
FT1-50PK	Deadlock/spring latch strike tab, for frame	50	\$159.12	XW4-100PK	6-3/4" existing wall anchor; equal rabbet	100	\$1034.28
FT2-50PK	4-7/8" ASA strike tab	50	\$159.12	XW5-100PK	6-3/4" existing wall anchor; unequal rabbet	100	\$1034.28
FT3-50PK	Flushbolt strike tab	50	\$106.08	XW6-100PK	7-3/4" existing wall anchor; equal rabbet	100	\$1034.28
FT4-50PK	5/16" offset electric strike tab	50	\$159.12	XW7-100PK	7-3/4" existing wall anchor; unequal rabbet	100	\$1034.28
FT5-50PK	Strike tab - no offset, for frame	50	\$159.12	XW8-100PK	8-3/4" existing wall anchor; equal rabbet	100	\$1034.28
GS1-20PK	8' glazing bead punched and countersunk #8	20	\$202.64	XW9-100PK	8-3/4" existing wall anchor; unequal rabbet	100	\$1034.28
GS2-20PK	10' glazing bead punched and countersunk #8	20	\$247.26	ZA5-100PK	Weld in Z anchor 4-3/4" to 5-3/4" masonry frames	100	\$132.60
GS3-20PK	10' glazing bead blank	20	\$228.02	ZA6-100PK	Weld in Z anchor 6-3/4" to 7-3/4" masonry frames	100	\$132.60
GS4-20PK	3' glazing bead blank	20	\$84.86	ZA8-100PK	Weld in Z anchor 8-3/4" masonry frames	100	\$137.80
HF1-25PK	4-1/2" hinge filler for bevelled doors	25	\$132.60				
HF2-25PK	4-1/2" hinge filler for non-handed doors	25	\$132.60				
HF3-25PK	4-1/2" hinge filler for frames	25	\$132.60				
HF4-25PK	5" hinge filler for bevelled doors	25	\$153.92				
HF5-25PK	5" hinge filler for non-handed doors	25	\$153.92				
HF6-25PK	5" hinge filler for frames	25	\$153.92				
HR1-50PK	4-1/2" hinge reinforcing standard weight .134	50	\$647.14				
HR2-50PK	4-1/2" hinge reinforcing heavy weight .180	50	\$647.14				
HR3-50PK	5" hinge reinforcing standard weight .146	50	\$663.00				
HR4-50PK	5" hinge reinforcing heavy weight .190	50	\$663.00				
HS1-50PK	4-1/2" hinge shim .028	50	\$64.74				
HS2-50PK	4-1/2" hinge shim .065	50	\$64.74				
HS3-50PK	5" hinge shim .028	50	\$79.56				
HS4-50PK	5" hinge shim .065	50	\$79.56				
LA1-25PK	Mortise lock to bored latch adapter	25	\$647.14				
LF1-25PK	2-1/8" screw-in hole cover	25	\$79.56				
LF2-25PK	Bored lock latch filler; 1-1/8" x 2-1/4"	25	\$148.46				
LF3-25PK	Mortise lock edge filler; 1-1/4" x 8"	25	\$331.50				
LF4-50PK	2-1/8" weld-in hole filler	50	\$61.10				
LF5-25PK	1-1/2" hole covers	25	\$137.90				
					Glazing Bead Fasteners (not provided with glazing bead)		
				TKS8125Z100	#8x1-1/4" Tek Screw, Oval Head	100	\$17.16

Call PEMKO for lead time & price quote on items or finishes not shown.

Product Number	List Price	Product Number	List Price	Product Number	List Price
PEMKOSTCSET-1A36x80BL	\$168.77	PEMKOSTCSET-1E36x84BL	\$189.15	PEMKOSTCSET-2D36x96BL	\$117.40
PEMKOSTCSET-1A36x84BL	\$168.77	PEMKOSTCSET-1E36x96BL	\$201.92	PEMKOSTCSET-2D48x80BL	\$122.92
PEMKOSTCSET-1A36x96BL	\$182.16	PEMKOSTCSET-1E48x80BL	\$215.10	PEMKOSTCSET-2D48x84BL	\$124.68
PEMKOSTCSET-1A48x80BL	\$196.33	PEMKOSTCSET-1E48x84BL	\$217.91	PEMKOSTCSET-2D48x96BL	\$132.84
PEMKOSTCSET-1A48x84BL	\$196.33	PEMKOSTCSET-1E48x96BL	\$229.24	PEMKOSTCSET-2D72x84BL	\$158.45
PEMKOSTCSET-1A48x96BL	\$205.26	PEMKOSTCSET-1E72x84BL	\$294.14	PEMKOSTCSET-2D72x96BL	\$170.93
PEMKOSTCSET-1A72x84BL	\$270.16	PEMKOSTCSET-1E72x96BL	\$309.80	PEMKOSTCSET-2D72x108BL	\$176.21
PEMKOSTCSET-1A72x96BL	\$292.49	PEMKOSTCSET-1E72x108BL	\$318.25	PEMKOSTCSET-2D84x96BL	\$186.38
PEMKOSTCSET-1A72x108BL	\$292.49	PEMKOSTCSET-1E84x96BL	\$360.22	PEMKOSTCSET-2D96x96BL	\$201.82
PEMKOSTCSET-1A84x96BL	\$338.69	PEMKOSTCSET-1E96x96BL	\$364.45	PEMKOSTCSET-2D96x120BL	\$219.59
PEMKOSTCSET-1A96x96BL	\$338.69	PEMKOSTCSET-1E96x120BL	\$388.55	PEMKOSTCSET-2E36x80BL	\$131.91
PEMKOSTCSET-1A96x120BL	\$361.02	PEMKOSTCSET-2A36x80BL	\$114.34	PEMKOSTCSET-2E36x84BL	\$134.72
PEMKOSTCSET-1B36x80BL	\$193.82	PEMKOSTCSET-2A36x84BL	\$114.34	PEMKOSTCSET-2E36x96BL	\$147.49
PEMKOSTCSET-1B36x84BL	\$193.82	PEMKOSTCSET-2A36x96BL	\$127.74	PEMKOSTCSET-2E48x80BL	\$150.37
PEMKOSTCSET-1B36x96BL	\$211.64	PEMKOSTCSET-2A48x80BL	\$131.61	PEMKOSTCSET-2E48x84BL	\$153.19
PEMKOSTCSET-1B48x80BL	\$222.86	PEMKOSTCSET-2A48x84BL	\$131.61	PEMKOSTCSET-2E48x96BL	\$164.52
PEMKOSTCSET-1B48x84BL	\$222.86	PEMKOSTCSET-2A48x96BL	\$140.54	PEMKOSTCSET-2E72x84BL	\$190.13
PEMKOSTCSET-1B48x96BL	\$234.74	PEMKOSTCSET-2A72x84BL	\$166.15	PEMKOSTCSET-2E72x96BL	\$205.78
PEMKOSTCSET-1B72x84BL	\$299.64	PEMKOSTCSET-2A72x96BL	\$188.48	PEMKOSTCSET-2E72x108BL	\$214.23
PEMKOSTCSET-1B72x96BL	\$329.34	PEMKOSTCSET-2A72x108BL	\$188.48	PEMKOSTCSET-2E84x96BL	\$222.81
PEMKOSTCSET-1B72x108BL	\$329.34	PEMKOSTCSET-2A84x96BL	\$201.28	PEMKOSTCSET-2E96x96BL	\$239.84
PEMKOSTCSET-1B84x96BL	\$375.54	PEMKOSTCSET-2A96x96BL	\$214.09	PEMKOSTCSET-2E96x120BL	\$263.94
PEMKOSTCSET-1B96x96BL	\$375.54	PEMKOSTCSET-2A96x120BL	\$236.42	PEMKOSTCSET-3A36x80BL	\$93.88
PEMKOSTCSET-1B96x120BL	\$405.24	PEMKOSTCSET-2B36x80BL	\$87.41	PEMKOSTCSET-3A36x84BL	\$93.88
PEMKOSTCSET-1C36x80BL	\$167.83	PEMKOSTCSET-2B36x84BL	\$87.41	PEMKOSTCSET-3A36x96BL	\$107.28
PEMKOSTCSET-1C36x84BL	\$167.83	PEMKOSTCSET-2B36x96BL	\$96.06	PEMKOSTCSET-3A48x80BL	\$104.28
PEMKOSTCSET-1C36x96BL	\$181.06	PEMKOSTCSET-2B48x80BL	\$103.10	PEMKOSTCSET-3A48x84BL	\$104.28
PEMKOSTCSET-1C48x80BL	\$195.34	PEMKOSTCSET-2B48x84BL	\$103.10	PEMKOSTCSET-3A48x96BL	\$113.22
PEMKOSTCSET-1C48x84BL	\$195.34	PEMKOSTCSET-2B48x96BL	\$108.86	PEMKOSTCSET-3A72x84BL	\$125.23
PEMKOSTCSET-1C48x96BL	\$204.16	PEMKOSTCSET-2B72x84BL	\$134.47	PEMKOSTCSET-3A72x96BL	\$147.56
PEMKOSTCSET-1C72x84BL	\$269.06	PEMKOSTCSET-2B72x96BL	\$148.88	PEMKOSTCSET-3A72x108BL	\$147.56
PEMKOSTCSET-1C72x96BL	\$291.12	PEMKOSTCSET-2B72x108BL	\$148.88	PEMKOSTCSET-3A84x96BL	\$159.44
PEMKOSTCSET-1C72x108BL	\$291.12	PEMKOSTCSET-2B84x96BL	\$161.68	PEMKOSTCSET-3A96x96BL	\$159.44
PEMKOSTCSET-1C84x96BL	\$337.32	PEMKOSTCSET-2B96x96BL	\$174.49	PEMKOSTCSET-3A96x120BL	\$181.77
PEMKOSTCSET-1C96x96BL	\$337.32	PEMKOSTCSET-2B96x120BL	\$188.90	PEMKOSTCSET-3B36x80BL	\$66.95
PEMKOSTCSET-1C96x120BL	\$359.37	PEMKOSTCSET-2C36x80BL	\$113.40	PEMKOSTCSET-3B36x84BL	\$66.95
PEMKOSTCSET-1D36x80BL	\$160.46	PEMKOSTCSET-2C36x84BL	\$113.40	PEMKOSTCSET-3B36x96BL	\$75.60
PEMKOSTCSET-1D36x84BL	\$162.22	PEMKOSTCSET-2C36x96BL	\$117.81	PEMKOSTCSET-3B48x80BL	\$75.77
PEMKOSTCSET-1D36x96BL	\$171.82	PEMKOSTCSET-2C48x80BL	\$130.62	PEMKOSTCSET-3B48x84BL	\$75.77
PEMKOSTCSET-1D48x80BL	\$187.64	PEMKOSTCSET-2C48x84BL	\$130.62	PEMKOSTCSET-3B48x96BL	\$81.54
PEMKOSTCSET-1D48x84BL	\$189.40	PEMKOSTCSET-2C48x96BL	\$139.44	PEMKOSTCSET-3B72x84BL	\$93.55
PEMKOSTCSET-1D48x96BL	\$197.56	PEMKOSTCSET-2C72x84BL	\$165.05	PEMKOSTCSET-3B72x96BL	\$107.96
PEMKOSTCSET-1D72x84BL	\$262.46	PEMKOSTCSET-2C72x96BL	\$187.10	PEMKOSTCSET-3B72x108BL	\$107.96
PEMKOSTCSET-1D72x96BL	\$274.95	PEMKOSTCSET-2C72x108BL	\$187.10	PEMKOSTCSET-3B84x96BL	\$119.84
PEMKOSTCSET-1D72x108BL	\$280.23	PEMKOSTCSET-2C84x96BL	\$199.91	PEMKOSTCSET-3B96x96BL	\$119.84
PEMKOSTCSET-1D84x96BL	\$323.79	PEMKOSTCSET-2C96x96BL	\$212.71	PEMKOSTCSET-3B96x120BL	\$134.25
PEMKOSTCSET-1D96x96BL	\$326.43	PEMKOSTCSET-2C96x120BL	\$234.77	PEMKOSTCSET-3D36x80BL	\$85.57
PEMKOSTCSET-1D96x120BL	\$344.19	PEMKOSTCSET-2D36x80BL	\$106.03	PEMKOSTCSET-3D36x84BL	\$87.33
PEMKOSTCSET-1E36x80BL	\$186.33	PEMKOSTCSET-2D36x84BL	\$107.79	PEMKOSTCSET-3D36x96BL	\$96.94

Call PEMKO for lead time & price quote on items or finishes not shown.

Product Number	List Price	Product Number	List Price	Product Number	List Price
PEMKOSTCSET-3D48x80BL	\$95.59	PEMKOSTCSET-4C48x84BL	\$133.26	PEMKOSTCSET-5B48x96BL	\$108.86
PEMKOSTCSET-3D48x84BL	\$97.35	PEMKOSTCSET-4C48x96BL	\$142.08	PEMKOSTCSET-5B72x84BL	\$134.47
PEMKOSTCSET-3D48x96BL	\$105.52	PEMKOSTCSET-4C72x84BL	\$169.01	PEMKOSTCSET-5B72x96BL	\$148.88
PEMKOSTCSET-3D72x84BL	\$117.53	PEMKOSTCSET-4C72x96BL	\$191.06	PEMKOSTCSET-5B72x108BL	\$148.88
PEMKOSTCSET-3D72x96BL	\$130.01	PEMKOSTCSET-4C72x108BL	\$191.06	PEMKOSTCSET-5B84x96BL	\$161.68
PEMKOSTCSET-3D72x108BL	\$135.29	PEMKOSTCSET-4C84x96BL	\$204.53	PEMKOSTCSET-5B96x96BL	\$174.49
PEMKOSTCSET-3D84x96BL	\$144.53	PEMKOSTCSET-4C96x96BL	\$217.99	PEMKOSTCSET-5B96x120BL	\$188.90
PEMKOSTCSET-3D96x96BL	\$147.17	PEMKOSTCSET-4C96x120BL	\$240.05	PEMKOSTCSET-5C36x80BL	\$113.40
PEMKOSTCSET-3D96x120BL	\$164.94	PEMKOSTCSET-4D36x80BL	\$108.01	PEMKOSTCSET-5C36x84BL	\$113.40
PEMKOSTCSET-3E36x80BL	\$111.45	PEMKOSTCSET-4D36x84BL	\$109.77	PEMKOSTCSET-5C36x96BL	\$126.64
PEMKOSTCSET-3E36x84BL	\$114.26	PEMKOSTCSET-4D36x96BL	\$119.38	PEMKOSTCSET-5C48x80BL	\$130.62
PEMKOSTCSET-3E36x96BL	\$127.03	PEMKOSTCSET-4D48x80BL	\$125.56	PEMKOSTCSET-5C48x84BL	\$130.62
PEMKOSTCSET-3E48x80BL	\$123.05	PEMKOSTCSET-4D48x84BL	\$127.32	PEMKOSTCSET-5C48x96BL	\$139.44
PEMKOSTCSET-3E48x84BL	\$125.87	PEMKOSTCSET-4D48x96BL	\$135.48	PEMKOSTCSET-5C72x84BL	\$165.05
PEMKOSTCSET-3E48x96BL	\$137.20	PEMKOSTCSET-4D72x84BL	\$162.41	PEMKOSTCSET-5C72x96BL	\$187.10
PEMKOSTCSET-3E72x84BL	\$149.21	PEMKOSTCSET-4D72x96BL	\$174.89	PEMKOSTCSET-5C72x108BL	\$187.10
PEMKOSTCSET-3E72x96BL	\$164.86	PEMKOSTCSET-4D72x108BL	\$180.17	PEMKOSTCSET-5C84x96BL	\$199.91
PEMKOSTCSET-3E72x108BL	\$173.31	PEMKOSTCSET-4D84x96BL	\$191.00	PEMKOSTCSET-5C96x96BL	\$212.71
PEMKOSTCSET-3E84x96BL	\$180.97	PEMKOSTCSET-4D96x96BL	\$207.10	PEMKOSTCSET-5C96x120BL	\$234.77
PEMKOSTCSET-3E96x96BL	\$185.19	PEMKOSTCSET-4D96x120BL	\$224.87	PEMKOSTCSET-5D36x80BL	\$106.03
PEMKOSTCSET-3E96x120BL	\$209.29	PEMKOSTCSET-4E36x80BL	\$133.89	PEMKOSTCSET-5D36x84BL	\$107.79
PEMKOSTCSET-4A36x80BL	\$116.32	PEMKOSTCSET-4E36x84BL	\$136.70	PEMKOSTCSET-5D36x96BL	\$117.40
PEMKOSTCSET-4A36x84BL	\$116.32	PEMKOSTCSET-4E36x96BL	\$149.47	PEMKOSTCSET-5D48x80BL	\$122.92
PEMKOSTCSET-4A36x96BL	\$129.72	PEMKOSTCSET-4E48x80BL	\$153.01	PEMKOSTCSET-5D48x84BL	\$124.68
PEMKOSTCSET-4A48x80BL	\$134.25	PEMKOSTCSET-4E48x84BL	\$155.83	PEMKOSTCSET-5D48x96BL	\$132.84
PEMKOSTCSET-4A48x84BL	\$134.25	PEMKOSTCSET-4E48x96BL	\$167.16	PEMKOSTCSET-5D72x84BL	\$158.45
PEMKOSTCSET-4A48x96BL	\$143.18	PEMKOSTCSET-4E72x84BL	\$194.09	PEMKOSTCSET-5D72x96BL	\$170.93
PEMKOSTCSET-4A72x84BL	\$170.11	PEMKOSTCSET-4E72x96BL	\$209.74	PEMKOSTCSET-5D72x108BL	\$176.21
PEMKOSTCSET-4A72x96BL	\$192.44	PEMKOSTCSET-4E72x108BL	\$218.19	PEMKOSTCSET-5D84x96BL	\$186.38
PEMKOSTCSET-4A72x108BL	\$192.44	PEMKOSTCSET-4E84x96BL	\$227.43	PEMKOSTCSET-5D96x96BL	\$201.82
PEMKOSTCSET-4A84x96BL	\$205.90	PEMKOSTCSET-4E96x96BL	\$245.12	PEMKOSTCSET-5D96x120BL	\$219.59
PEMKOSTCSET-4A96x96BL	\$219.37	PEMKOSTCSET-4E96x120BL	\$269.22	PEMKOSTCSET-5E36x80BL	\$131.91
PEMKOSTCSET-4A96x120BL	\$241.70	PEMKOSTCSET-5A36x80BL	\$114.34	PEMKOSTCSET-5E36x84BL	\$134.72
PEMKOSTCSET-4B36x80BL	\$89.39	PEMKOSTCSET-5A36x84BL	\$114.34	PEMKOSTCSET-5E36x96BL	\$147.49
PEMKOSTCSET-4B36x84BL	\$89.39	PEMKOSTCSET-5A36x96BL	\$127.74	PEMKOSTCSET-5E48x80BL	\$150.37
PEMKOSTCSET-4B36x96BL	\$98.04	PEMKOSTCSET-5A48x80BL	\$131.61	PEMKOSTCSET-5E48x84BL	\$153.19
PEMKOSTCSET-4B48x80BL	\$105.74	PEMKOSTCSET-5A48x84BL	\$131.61	PEMKOSTCSET-5E48x96BL	\$164.52
PEMKOSTCSET-4B48x84BL	\$105.74	PEMKOSTCSET-5A48x96BL	\$140.54	PEMKOSTCSET-5E72x84BL	\$190.13
PEMKOSTCSET-4B48x96BL	\$111.50	PEMKOSTCSET-5A72x84BL	\$166.15	PEMKOSTCSET-5E72x96BL	\$205.78
PEMKOSTCSET-4B72x84BL	\$138.43	PEMKOSTCSET-5A72x96BL	\$188.48	PEMKOSTCSET-5E72x108BL	\$214.23
PEMKOSTCSET-4B72x96BL	\$152.84	PEMKOSTCSET-5A72x108BL	\$188.48	PEMKOSTCSET-5E84x96BL	\$222.81
PEMKOSTCSET-4B72x108BL	\$152.84	PEMKOSTCSET-5A84x96BL	\$201.28	PEMKOSTCSET-5E96x96BL	\$239.84
PEMKOSTCSET-4B84x96BL	\$166.30	PEMKOSTCSET-5A96x96BL	\$214.09	PEMKOSTCSET-5E96x120BL	\$263.94
PEMKOSTCSET-4B96x96BL	\$179.77	PEMKOSTCSET-5A96x120BL	\$236.42		
PEMKOSTCSET-4B96x120BL	\$194.18	PEMKOSTCSET-5B36x80BL	\$87.41		
PEMKOSTCSET-4C36x80BL	\$115.38	PEMKOSTCSET-5B36x84BL	\$87.41		
PEMKOSTCSET-4C36x84BL	\$115.38	PEMKOSTCSET-5B36x96BL	\$96.06		
PEMKOSTCSET-4C36x96BL	\$128.62	PEMKOSTCSET-5B48x80BL	\$103.10		
PEMKOSTCSET-4C48x80BL	\$133.26	PEMKOSTCSET-5B48x84BL	\$103.10		

Call PEMKO for lead time & price quote on items or finishes not shown.

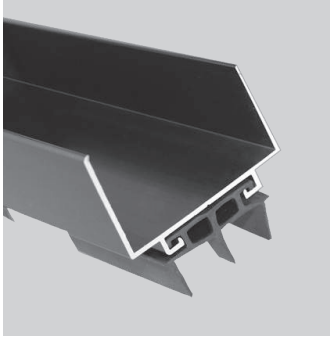

MEMPHIS, TN USA
phone: 800 824-3018
fax: 800 243-3656

VENTURA, CA USA
phone: 800 283-9988
fax: 800 283-4050

VANCOUVER, BC CANADA
phone: 877 535-7888
fax: 877 535-7444

TORONTO, ON CANADA
phone: 877 535-7888
fax: 877 535-7444