

Rockwood Price List

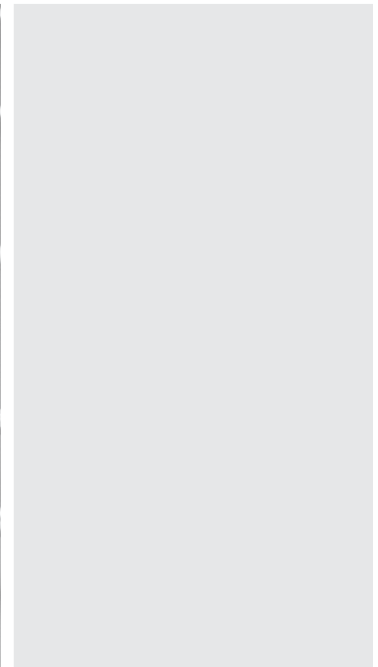
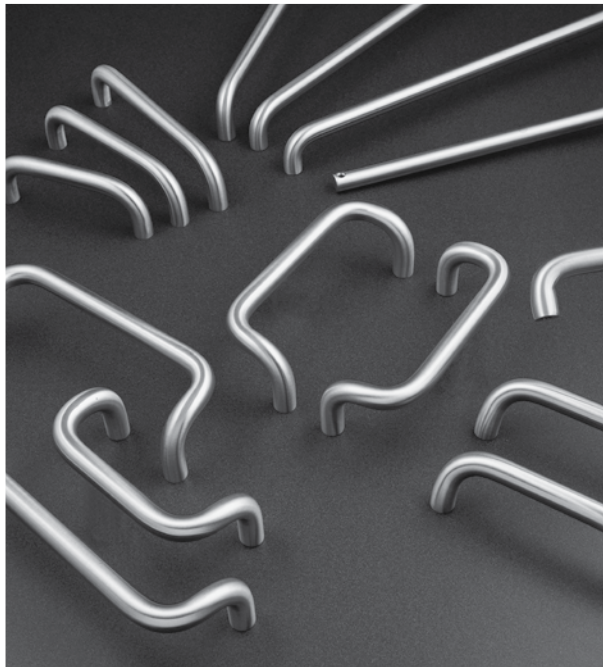
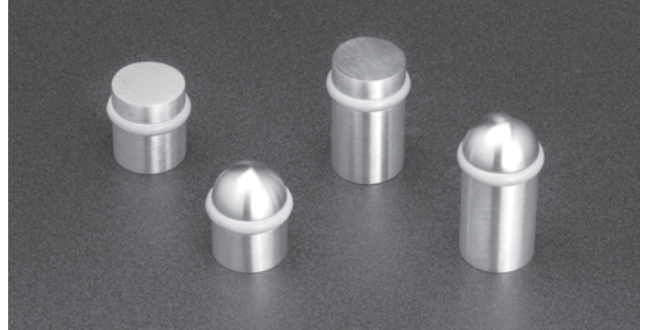
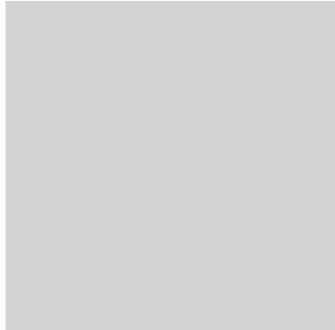

© 1999-2015 Rockwood Manufacturing Company

Prices Effective January 1, 2015

ROCKWOOD®
ASSA ABLOY

ASSA ABLOY, the global leader
in door opening solutions

General Information.....	4
Architectural Finishes.....	5
Mounting Details	
Series 47 Push & Pull Bars.....	6
Straight Door Pulls.....	7
Offset Door Pulls.....	8
Push & Pull Bars.....	9
RM200/300 Series.....	9
Fasteners - Spare Parts.....	10-13
Mounting Kits.....	14
Numeric Index.....	74-77
FULL LINE ARCHITECTURAL HARDWARE	
Push and Pull Bars.....	15
Series 47 Push Bars.....	16
Series 47 Tubular Push & Pull Bars.....	17
Push Plate Ordering Information.....	18
Push Plates.....	19
Pull Plate Sets/Push Plates.....	20
Push Pulls/Flush Pulls.....	21
Door Pulls.....	22-26
Pull Plates.....	26-27
Corner Guards.....	27
Door Edges.....	27-28
Latch Protectors.....	28
Door Stops.....	29
Flush Bolts - Manual.....	30
Gravity Door Coordinators.....	30
Roller Latches.....	30
Hospital Latches.....	30
Door Guards.....	31
Door Knockers & Viewers.....	31
Surface Bolts.....	31
Flush Bolts - Residential.....	31
Card Holder.....	31
Signs.....	32
Auxiliary Hardware.....	33
Hand Rail Brackets	
Coat Hooks	
Ball Knob	
Utility,Wire, Flush, Edge & Pocket Door Pulls	
Magnetic & Adjustable Ball Catches	
Coordinators.....	33
Flush Bolts.....	33
Overhead Holders & Stops.....	34
Latch Guard Covers.....	34
Vertical Rod Covers.....	34
Pivots.....	35
Custom Strikes.....	35
Filler Plates & Shims.....	35
Angle Plates.....	35
Trim Protector Bars.....	35
Door Plates - Kick Plates/Armor Plates.....	36-38

ARCHITECTURAL PULLS

Mid-Post Guidelines.....	39
Tubular (1¼" x 1½" diameter pulls).....	40
RightAngles (with or without GripZone).....	41
Small Pulls (cabinets, casework & closet doors).....	41
Edge Pulls (for closet doors).....	42
Coat Hooks.....	42
Door Stops.....	42
Push Plates Pull Plates & Signage.....	43
Small PostMount Pulls.....	43
(for cabinets, case work & closet doors)	
Small PostMount GripZone Pulls.....	44
(for cabinets, casework & closet doors)	
Small PostMount Pulls (Noirmet, ArborMet,.....	45
IberMet (cabinets, casework & closet doors)	
MegaCurve (long curved pulls).....	45
MezzoTek (necked post pulls).....	46
BandWidth (collar mount pulls).....	47
OvalTek (true oval grip).....	48
OvalTek (flat oval grip).....	48
SoftMet (*Santoprene™ grip).....	48
SoftTek (Santoprene™ grip).....	49
IberMet (cork grips).....	49
BronzeAge (copper rich grip).....	50
NeoMetrix (with GripZone).....	51
PostMount (straight & offset pulls).....	51
Groove (straight & offset pulls).....	51
NeoTek (post mounted GripZone).....	53
MegaTek (long door pulls).....	54
NeoMax (long pulls with GripZone).....	55
LineaMet (contrasting grooved pulls).....	56
LineaTek (fully grooved pulls).....	57
LineaMax (long grooved pulls).....	58
NoirMet (black anodized grip).....	59
NoirTek (black anodized grip).....	60-61
ArborMet (wood grip pulls).....	62
ArborTek (wood grip pulls).....	63
SkewTek (angled end pulls & big pulls).....	64
Centek (1" radius pulls).....	64
Centrex (1" radius pulls & large radius pulls).....	65
SculpTrex (shaped cast pulls).....	66
PlanTek (flat front pulls).....	66
Traditional (decorative pulls & plates).....	67
Classic (finial door pulls).....	67
MariTek (straight door pulls).....	67
English Bridle Leather (straight & offset pulls).....	68
Upholstery Leather (straight & offset pulls).....	69
Leather Oval (ergonomic pulls).....	70
Flush Leather Wrapped Pulls.....	70
Upholstery Leather GeoMetek Pulls.....	71
Small Leather Pulls.....	71
NeoCylinder (with or without GripZone).....	71
NeoMitre (with or without GripZone).....	72
GeoMetek (narrow profile pulls).....	72
Locking Door Pull System.....	73-74

*Santoprene™ is a registered trademark of the Exxon Mobil Corporation.

Ordering Information

- This price list cancels and supersedes all prior listings.
- Orders are accepted with the understanding that they will be billed at prices in effect at time of shipment.
- Prices are subject to change without notice.
- We reserve the right to decline the whole or part of orders in which the price or quantity of goods is not acceptable to us.

Easy Order Placement

By Phone: 1-800-458-2424 Monday through Thursday 8:00 am ET to 7:00 pm ET, Friday 8:00 am ET to 4:30 pm ET

By Fax: Orders may be faxed to 1-800-922-9212

By Email: orderediting@rockwoodmfg.com

By Internet: <http://extranet.assaabloydss.com/> and select Order Entry under the Customer Service Menu

Terms and Conditions of Sale

Terms: 1% 15 days, net 30 days

Minimum Order: \$50 (If less, add \$20 processing fee to order.)

Remit Payment To: Rockwood Manufacturing Company, P.O. Box 644489 Pittsburgh, PA 15264-4489

Freight Policy

Freight Allowance: All prices are F.O.B. Rockwood, Pennsylvania. Full freight will be allowed on shipments of \$1,000 net and over within the continental limits of the United States (excluding Alaska and Hawaii). All shipments are routed cheapest route of our choice. We reserve the right to designate the carrier.

Special Order Material

Special items made to your specifications are not returnable. These items are not subject to cancellation without consideration of expense involved at the cancellation date.

Samples

Salable samples will be charged at regular prices.

Returned Goods

Return no merchandise without written permission from the factory. Authorization will insure your receiving proper credit. Errors in shipping may occasionally occur. If this is the case immediately notify the factory, and we will gladly make the proper adjustments. If the error is at the customer's end, a minimum charge of 25% plus freight will be incurred for handling. Unauthorized claims for labor or charges will not be allowed. No credit will be allowed beyond six months after invoice date.

Shortages

Claims for shortages must be made within 30 days of invoice date.

Templates

Upon request we will furnish templates for any of our standard items of manufacture. Commonly used templates are available on our website at www.rockwoodmfg.com.

Product Weight Information

NOTE: Weights indicated throughout the price list are approximate for brass, bronze or stainless steel base material. Aluminum base materials weigh approximately 1/3 the listed weights.

Engraving

Engraving may be added on many pulls. Call factory for pricing.

Most of Rockwood's products are available in all of the following architectural finishes. The catalog indicates exceptions. This finish list is grouped by base metal.

Finish Codes

Base Metal	Description	Price Book Code	Rockwood Code	BHMA Code
Aluminum	Satin	27	US27	627
Aluminum	Clear Anodized	28	US28	628
Aluminum	Light Bronze Anodized	311	311	—
Aluminum	Medium Bronze Anodized	312	312	—
Aluminum	Dark Bronze Anodized	313	313	710
Aluminum	Extra Dark Bronze Anodized	314	314	—
Aluminum	Black Anodized	315	315	711
Aluminum	White Powder Coat	WPC	WPC	—
Aluminum	Red Powder Coat	RPC	RPC	—
Aluminum	Black Powder Coat	BPC	BPC	—
Brass	Polished Clear Coated	3	US3	605
Brass	Polished No Coating	3NL	US3NL	—
Brass	Satin Clear Coated	4	US4	606
Brass	Satin Oxidized Relieved	5	US5	609
Brass	Satin Nickel Plated Clear Coated	15	US15	619
Brass	Satin Nickel Blackened Relieved Clear Coated	15A	US15A	620
Brass	Flat Black Powder Coated	19	US19	622
Brass	Polished Chrome Plated	26	US26	625
Brass	Satin Chrome Plated	26D	US26D	626
Bronze*	Polished Clear Coated	9	US9	611
Bronze*	Satin Clear Coated	10	US10	612
Bronze*	Satin Black Oxidized Oil Rubbed	10A	US10A	—
Bronze*	Satin Oxidized Oil Rubbed	10B	US10B	613
Bronze*	Satin Oxidized Clear Coated	10BL	US10BL	614
Bronze*	Satin Dark Statuary	20A	US20A	624
Stainless Steel	Polished	32	US32	629
Stainless Steel	Satin	32D	US32D	630
Special Finishes (see descriptions)				
Stainless Steel	Satin MicroShield® Coated	32DMS***	US32DMS***	—
Stainless Steel	Polished 316 Alloy	32316***	US32316***	—
Stainless Steel	Satin 316 Alloy	32D316***	US32D316***	—
	PVD Polished Brass	3LIFETIME	US3LIFETIME	—
	Dark Oxidized Satin Bronze, Equivalent	10BE	US10BE	(613E)

Special Finishes Description

32DMS (MicroShield®): As part of its promise to provide innovative solutions to their customers, ASSA ABLOY Group companies offer the MicroShield® technology, a silver-based antimicrobial coating designed to inhibit the spread of germs and bacteria.

32316 and 32D316 are made from alloy 316 stainless steel containing molybdenum and extra nickel giving it substantially higher corrosion resistance than the standard stainless steels typically used in door hardware. This finish is ideal for use in coastal, urban, and industrial areas that have harsh environmental conditions.

3LIFETIME is a PVD (physical vapor deposition) finish. The finish is a thin hard metallic film of extreme durability that looks like polished brass. **3LIFETIME** brass finish will not tarnish and is ideal for use in exterior and marine environments.

10BE Dark Oxidized Satin Bronze equivalent: This new finish provides the richness and warmth of the 10B/613 "living" finish, but maintains its original color and appearance and will not fade or wear over time. The 10BE finish is offered by Corbin Russwin, McKinney, Norton, Rixson, Rockwood, SARGENT and Yale, providing visual consistency between ASSA ABLOY Group brands.

* On most bronze finishes we will supply solid bronze material. Where solid bronze material is not available, we will use brass as a base material in its place.

*** Available on select items as indicated by the finish icon throughout the catalog.



Agion has achieved:



Agion's silver antimicrobial has been certified for its material content, recyclability, and manufacturing characteristics. Cradle To Cradle Certified^{CM} products meet established standards for human health, environmental health and recyclability.

Cradle To Cradle Certified^{CM} is a certification mark of MBDC.



MicroShield® is a registered trademark of Yale Security Inc., an ASSA ABLOY Group company.

Set Mounting Charges

Mounting Spec #	Door Type	Pull Type	Mounting Type			Add On
			Pull Free End	Push Free End	Common End	
T1	Metal & Wood	Straight or Offset	12	12	5	23
T1HD	Metal & Wood	Straight or Offset	12HD	12HD	5HD	29
T2	Glass	Straight or Offset	15	15	13	27
T2HD	Glass	Straight or Offset	15HD	15HD	13HD	34
T3*	Metal & Wood	Straight or Offset	1	1	5	Included
T3HD	Metal & Wood	Straight or Offset	1HD	1HD	5HD	16
T4	Metal	Straight	6	6	5	11
T4HD	Metal	Straight	6HD	6HD	5HD	25
T4	Metal	Offset	17	17	16	20
T4HD	Metal	Offset	17HD	17HD	16HD	27
T5	Wood	Straight or Offset	8	8	5	20

*T3 is the standard mounting method for Metal and Wood Doors.

NOTE: Heavy Duty (HD) mounting features hex drive for positive tightening and large overall size for superior strength. Recommended for high frequency and rough service openings.

FREE END DETAILS

Wood or Metal Door - Type 1

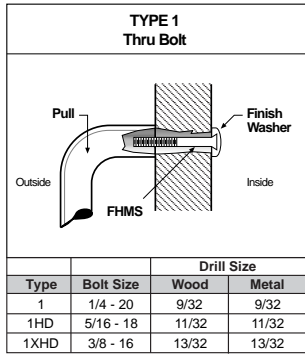

Thru Bolt

Wood or Metal Door - Type 12

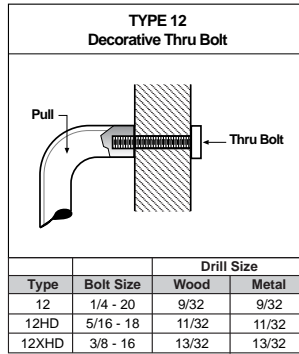

Glass Door - Type 15

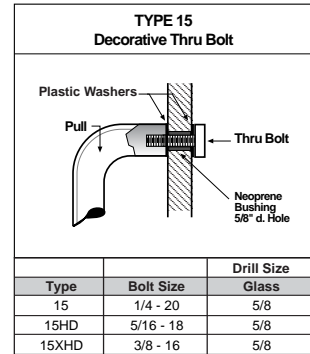

Metal Door - Type 6

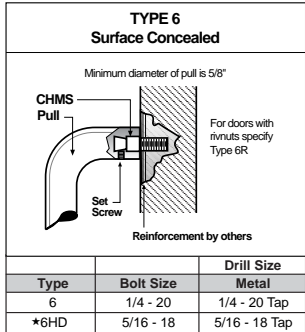

Surface Concealed

Wood Door - Type 8

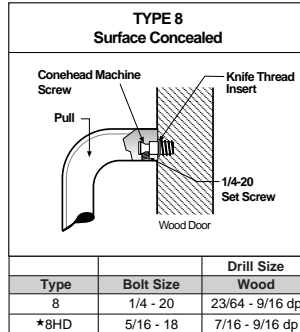

Metal Door - Type 17

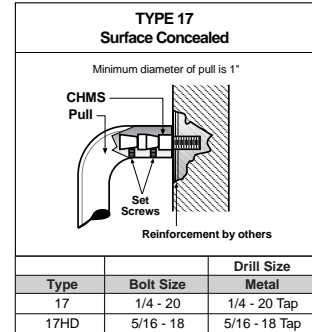

*HD mountings feature 2 set screws 180° apart.

*8HD mountings feature 2 set screws 180° apart.

COMMON END DETAILS

Wood or Metal Door - Type 5

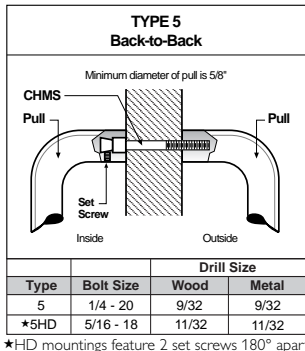

*HD mountings feature 2 set screws 180° apart.

Glass Door - Type 13

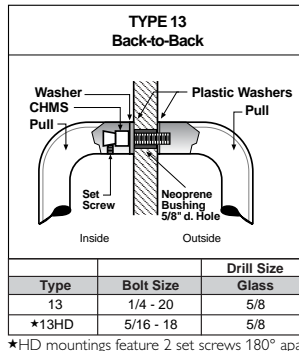

*HD mountings feature 2 set screws 180° apart.

TYPICAL MOUNTING

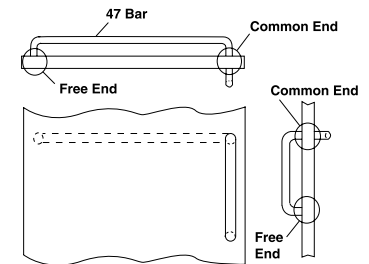

NOTE: Heavy Duty (HD) mounting features hex drive for positive tightening and large overall size for superior strength. Recommended for high frequency and rough service openings.

Thru Bolt

Wood or Metal Door - Type 1

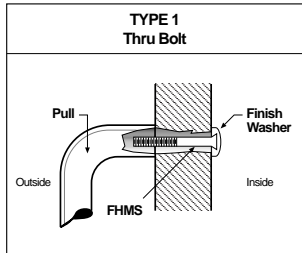

Type	Bolt Size	Drill Size		Price
		Wood	Metal	
1	1/4 - 20	3/32	3/32	Included
1HD	3/16 - 18	11/32	11/32	\$4.20/Pull
1XHD	3/8 - 16	13/32	13/32	\$8.40/Pull

Wood or Metal Door - Type 12

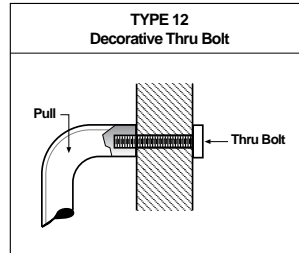

Type	Bolt Size	Drill Size		Price
		Wood	Metal	
12	1/4 - 20	3/32	3/32	\$21/Pull
12HD	3/16 - 18	11/32	11/32	\$25.20/Pull
12XHD	3/8 - 16	13/32	13/32	\$25.20/Pull

Glass Door - Type 15

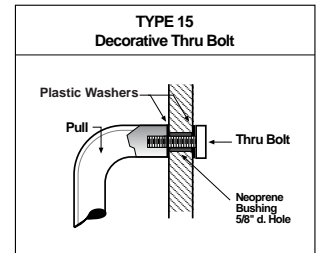

Type	Bolt Size	Drill Size		Price
		Glass		
15	1/4 - 20	3/8		\$23.10/Pull
15HD	3/16 - 18	3/8		\$27.30/Pull
15XHD	3/8 - 16	3/8		\$27.30/Pull

Back to Back

Wood or Metal Door - Type 5

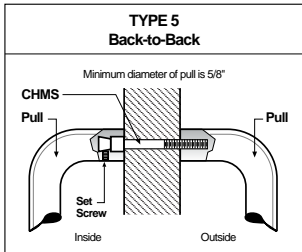

Type	Bolt Size	Drill Size		Price
		Wood	Metal	
5	1/4 - 20	3/32	3/32	\$8.40/Pair
*5HD	3/16 - 18	11/32	11/32	\$12.60/Pair

*HD mountings feature 2 set screws 180° apart.

Any Door Type - Type 9

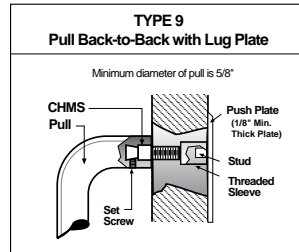

Type	Bolt Size	Drill Size		Price
		Wood	Metal	
9	1/4 - 20	N/A		\$23.10/Set

Glass Door - Type 13

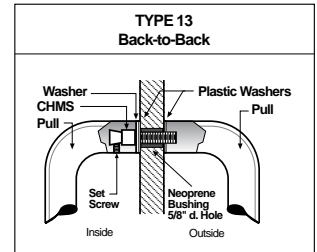

Type	Bolt Size	Drill Size		Price
		Glass		
13	1/4 - 20	3/8		\$14.70/Pair
*13HD	3/16 - 18	3/8		\$18.90/Pair

*HD mountings feature 2 set screws 180° apart.

Surface Concealed

Metal Door - Type 6

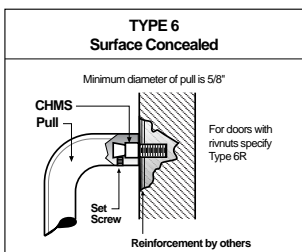

Type	Bolt Size	Drill Size		Price
		Wood	Metal	
6	1/4 - 20	1/4 - 20 Tap		\$8.40/Pull
*6HD	3/16 - 18	3/16 - 18 Tap		\$12.60/Pull

*HD mountings feature 2 set screws 180° apart.

Metal Door - Type 6R

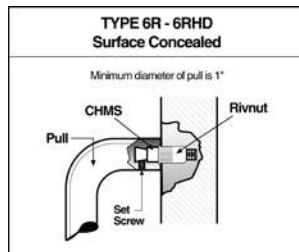

Type	Bolt Size	Drill Size		Price
		Wood	Metal	
6R	1/4 - 20	N/A		\$10.50/Pull
*6RHD	3/16 - 18	N/A		\$14.70/Pull

*HD mountings feature 2 set screws 180° apart.

Wood Door - Type 8

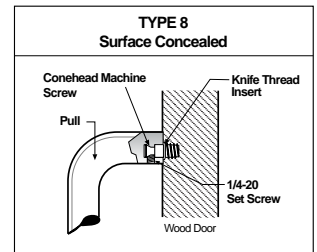

Type	Bolt Size	Drill Size		Price
		Wood		
8	1/4 - 20	23/64 - 3/16 dp		\$8.40/Pull
*8HD	3/16 - 18	7/16 - 3/16 dp		\$12.60/Pull

*HD mountings feature 2 set screws 180° apart.

Flush Pull Mounting

Wood or Metal Door - Type 10

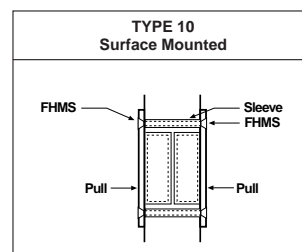

Type	Bolt Size	Drill Size		Price
		Wood	Metal	
10	8 - 32	3/32	3/32	\$1.58/Sleeve

Type 10 Mounting applies to the 94 Series Flush Pulls

Wire or Small Post Mount Pull Mounting

NOTE: This mounting should only be used on pulls with mounting points that are 1/2" in diameter.

Wood or Metal Door - Type 5S

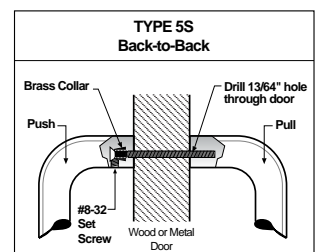

Type	Bolt Size	Drill Size		Price
		Wood	Metal	
5S	8 - 32	13/64	13/64	\$8.40/Pair

NOTE: Y base plates are recommended on wood or glass doors to make a stable and durable mounting (see page 9 for details).
NOTE: Heavy Duty (HD) mounting features hex drive for positive tightening and large overall size for superior strength. Recommended for high frequency and rough service openings.

Thru Bolt

Wood or Metal Door - Type 1

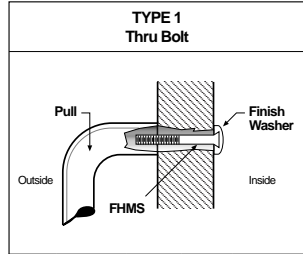

Type	Bolt Size	Drill Size		Price
		Wood	Metal	
1	1/4 - 20	3/32	9/32	Included
1HD	5/16 - 18	11/32	11/32	\$4.20/Pull
1XHD	3/8 - 16	13/32	13/32	\$8.40/Pull

Wood or Metal Door - Type 12

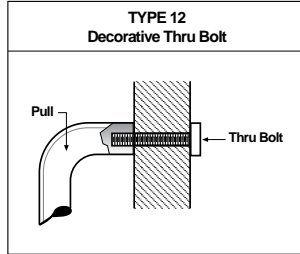

Type	Bolt Size	Drill Size		Price
		Wood	Metal	
12	1/4 - 20	3/32	9/32	\$21/Pull
12HD	5/16 - 18	11/32	11/32	\$25.20/Pull
12XHD	3/8 - 16	13/32	13/32	\$25.20/Pull

Glass Door - Type 15

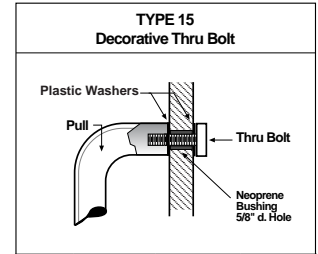

Type	Bolt Size	Drill Size		Price
		Glass		
15	1/4 - 20	5/8		\$23.10/Pull
15HD	5/16 - 18	5/8		\$27.30/Pull
15XHD	3/8 - 16	5/8		\$27.30/Pull

Back to Back

Wood or Metal Door - Type 16

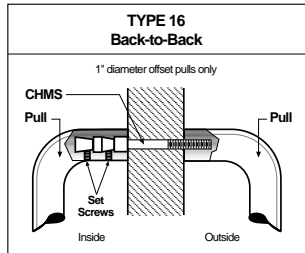

Type	Bolt Size	Drill Size		Price
		Wood	Metal	
16	1/4 - 20	3/32	9/32	\$12.60/Pair
16HD	5/16 - 18	11/32	11/32	\$16.80/Pair

Glass Door - Type 18

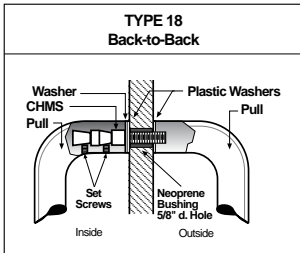

Type	Bolt Size	Drill Size		Price
		Glass		
18	1/4 - 20	5/8		\$18.90/Pair
18HD	5/16 - 18	5/8		\$23.10/Pair

Concealed

Metal Door - Type 17

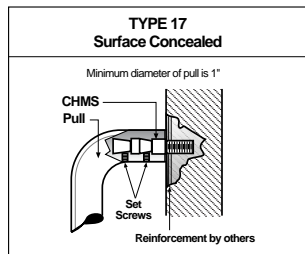

Type	Bolt Size	Drill Size		Price
		Metal		
17	1/4 - 20	1/4 - 20 Tap		\$12.60/Pull
17HD	5/16 - 18	5/16 - 18 Tap		\$16.80/Pull

Metal Door - Type 17R

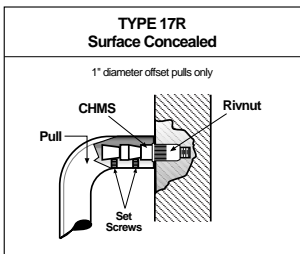

Type	Bolt Size	Drill Size		Price
		Metal		
17R	1/4 - 20	N/A		\$14.70/Pull

Push and Pull Bar Mounting Details

Sizing of Push Bars

Flush Doors

- Door width: • minus 5" for bent end bars
- minus 5" for square end post mount bars
- minus 7" for round end post mount bars

Stile and Rail Doors or Doors with Lites

- Door width: • minus width of one stile

CAUTION: Always confirm bars will not interfere with jamb or cause pinching hazard.

CAUTION: On narrow stile doors, be sure push bar base fits on the stile and bar does not interfere with the stop.

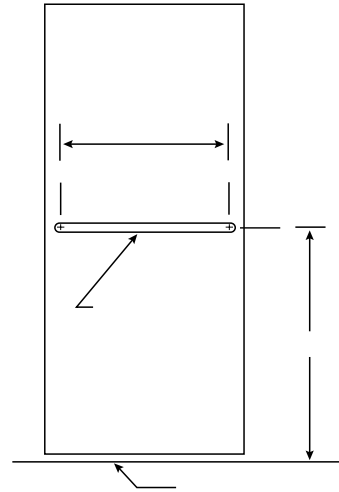

Handing of Doors

The handing of a door is determined from the outside of the opening.

Standing outside the door:

- If the hinges are on the right, it is a right hand door.
- If the hinges are on the left, it is a left hand door.
- If the door opens away from you, it is a regular bevel door.
- If the door opens toward you, it is a reverse bevel door.

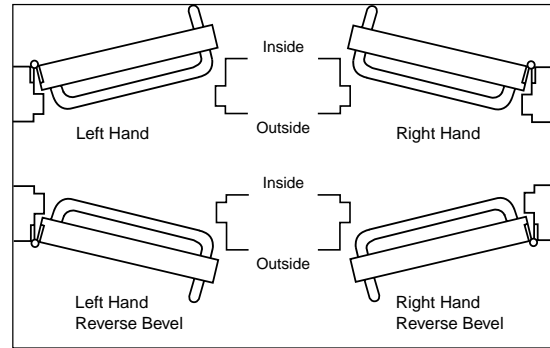

RM200/RM300 Series Mounting Details

Thru Bolt

Wood or Metal Door - Type 1

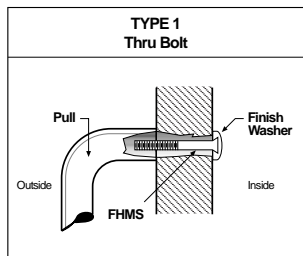

		Drill Size		Price
Type	Bolt Size	Wood	Metal	
1XH	3/8 - 16	13/32	13/32	\$8.40/Pull

Wood or Metal Door - Type 12

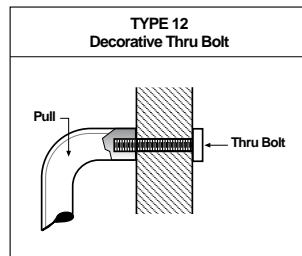

		Drill Size		Price
Type	Bolt Size	Wood	Metal	
12XH	3/8 - 16	13/32	13/32	\$25.20/Pull

Glass Door - Type 15

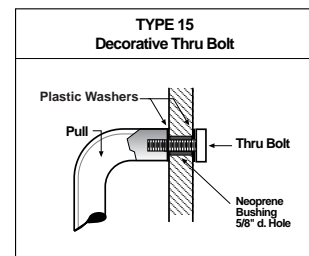

		Drill Size		Price
Type	Bolt Size	Glass		
15XH	3/8 - 16	5/8		\$27.30/Pull

Back to Back

Wood or Metal Door - Type 11

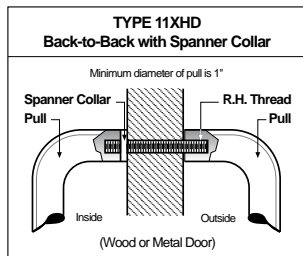

		Drill Size		Price
Type	Bolt Size	Wood	Metal	
11XH	3/8 - 16	13/32	13/32	\$25.20/Pair

Glass Door - Type 14

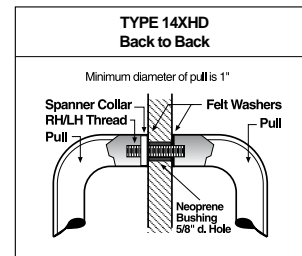

		Drill Size		Price
Type	Bolt Size	Glass		
14XH	3/8 - 16	5/8		\$27.30/Pair

Thru Bolt Mounting - For 1 3/4" Wood and Metal Doors

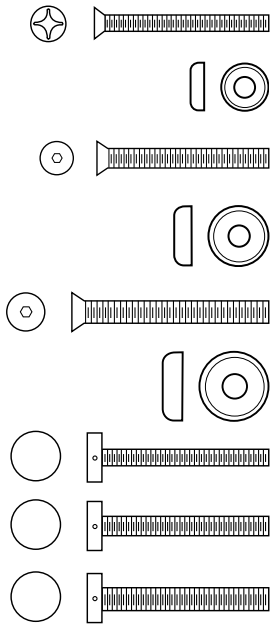

Part	Description	Mounting Type	Price
SP1004	1/4 - 20 x 2 1/4" FH MS Thru Bolt	1	1.30
SP1005	1/4 - 20 Finishing Washer	1	0.80
SP1053	5/16 - 18 x 2 1/2" Socket FH MS Thru Bolt	1HD	2.80
SP1054	5/16 - 18 Finishing Washer	1HD	1.00
SP1001	3/8 - 16 x 2 1/2" Socket FH MS Thru Bolt	1XHD	4.40
SP1002	3/8 - 16 Finishing Washer	1XHD	1.30
SP1003	1" Diameter Decorative Thru Bolt 1/4 - 20 x 2 1/4"	12	12.00
SP1055	1" Diameter Decorative Thru Bolt 5/16 - 18 x 2 1/4"	12HD	14.20
SP1041	1 1/4" Diameter Decorative Thru Bolt 3/8 - 16 x 2 1/4"	12XHD	14.20

Back to Back Mounting - For 1 3/4" Wood and Metal Doors

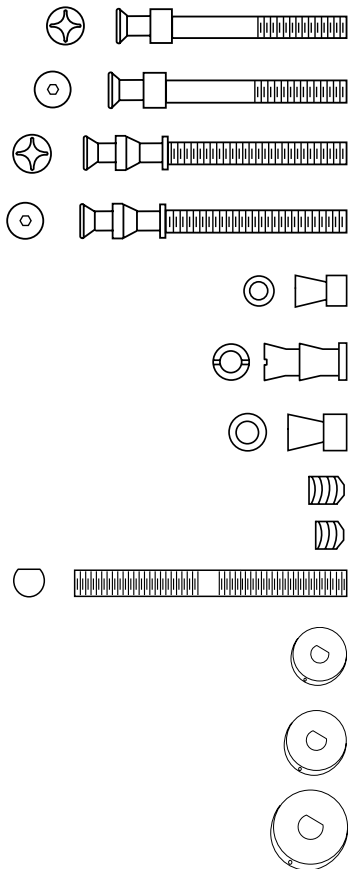

Part	Description	Mounting Type	Price
SP1025	1/4 - 20 x 2 1/4" Cone Head MS	5	3.10
SP1056	5/16 - 18 x 2 1/4" Cone Head MS	5HD	4.90
SP1052	1/4 - 20 x 2 1/4" Double Cone Head MS (for use with offset pulls)	16	3.70
SP1057	5/16 - 18 x 2 1/4" Double Cone Head MS (for use with offset pulls)	16HD	6.00
SP1027	1/4 - 20 Cone Head Union (Used to Convert Cone Head to Thru Bolt Hole)	N/A	3.10
SP1079	1/4 - 20 Double Cone Head Union (Used to Convert Double Cone Head to Thru Bolt Hole)	N/A	5.50
SP1068	5/16 - 18 Cone Head Union (Used to Convert Cone Head to Thru Bolt Hole)	N/A	4.90
SP1026	1/4 - 20 x 5/16" Set Screws (Standard)	N/A	0.80
SP1065	1/4 - 20 x 3/16" Set Screw (Short)	N/A	0.90
SP1032	3/8 - 16 x 3 1/2" LH/RH Bolt	11	6.50
SP1071	Spanner Collar 1" Diameter for LH/RH Bolt	11	9.80
SP1033	Spanner Collar 1 1/4" Diameter for LH/RH Bolt	11	9.80
SP1072	Spanner Collar 1 1/2" Diameter for LH/RH Bolt	11	10.90

Concealed Mounting - For 1 3/4" Wood and Metal Doors

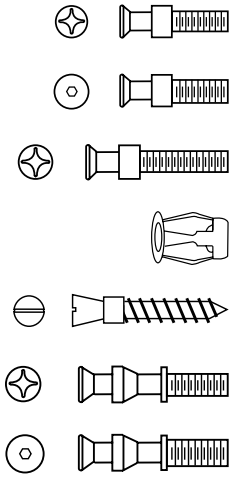

Part	Description	Mounting Type	Price
SP1039	1/4 - 20 x 1/2" Cone Head MS	6 / 6R	3.10
SP1058	5/16 - 18 x 1/2" Cone Head MS	6HD	4.90
SP1021	1/4 - 20 x 1 1/8" Cone Head MS; For Use with Jack Nut - Type 7 Mount	7	3.10
SP1030	1/4 - 20 Jack Nut Insert; Mounting Anchor for Concealed Mounting on Hollow Doors	7	3.30
SP1029	1/4 - 20 Cone Head WS	8	5.50
SP1051	1/4 - 20 x 1/2" Double Cone Head MS	17 / 17R	4.90
SP1059	5/16 - 18 x 1/2" Double Cone Head MS	17HD	6.00

Bushings & Washers - For 1/2" Glass Doors

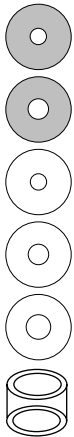

Part	Description	Mounting Type	Price
SP1022	Stainless Steel Washer for 1/4 - 20 Cone Head MS .032" Thick	13	1.30
SP1060	Stainless Steel Washer for 5/16 - 18 Cone Head MS .060" Thick	13HD	1.30
SP1023	Plastic Washer for 1/4 - 20 Bolt; Specify Size	13	1.10
SP1061	Plastic Washer for 5/16 - 18 Bolt; Specify Size	13HD	1.20
SP1062	Plastic Washer for 3/8 - 16 Bolt; Specify Size	14	1.20
SP1024	Glass Door Bushing for 5/8" Hole in Glass; Specify Size	13 / 13HD / 14	1.30

Thru Bolt Mounting - For 1/2" Glass Doors

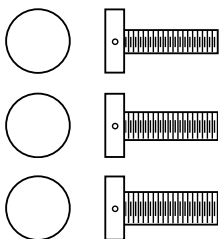

Part	Description	Mounting Type	Price
SP1020	1" Diameter Decorative Thru Bolt; 1/4 - 20 x 1 1/8"	15	12.00
SP1063	1" Diameter Decorative Thru Bolt; 5/16 - 18 x 1 1/8"	15HD	14.20
SP1040	1 1/4" Diameter Decorative Thru Bolt; 3/8 - 16 x 1 1/8"	15XHD	14.20

Back to Back Mounting - For 1/2" Glass Doors

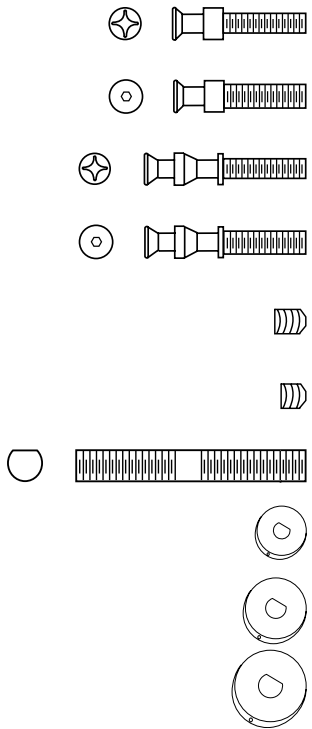

Part	Description	Mounting Type	Price
SP1021	1/4 - 20 x 1 1/8" Cone Head MS	13	3.10
SP1064	5/16 - 18 x 1 1/8" Cone Head MS	13HD	4.90
SP1067	1/4 - 20 x 1 1/8" Double Cone Head MS	18	4.90
SP1066	5/16 - 18 x 1 1/8" Double Cone Head MS	18HD	6.00
SP1026	1/4 - 20 x 3/16" Set Screw (Standard)	N/A	0.80
SP1065	1/4 - 20 x 3/16" Set Screw (Short)	N/A	0.90
SP1031	3/8 - 16 x 2 1/4" LH/RH Bolt	14	6.50
SP1071	Spanner Collar 1" Diameter for LH/RH Bolt	14	9.80
SP1033	Spanner Collar 1 1/4" Diameter for LH/RH Bolt	14	9.80
SP1072	Spanner Collar 1 1/2" Diameter for LH/RH Bolt	14	10.90

Y Base Plates

Specify bolt hole size and finish. Standard pulls require two plates.

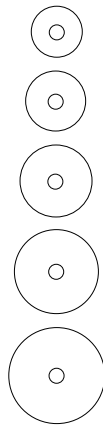

Part	Description	For Use With	Price
SP1073	1/8" Thick x 1 1/16" Diameter	3/8" Diameter Pulls	12.00
SP1074	1/8" Thick x 1 1/4" Diameter	1" Diameter Pulls and Posts	12.00
SP1075	1/8" Thick x 1 1/2" Diameter	1" Diameter Pulls and Posts	12.00
SP1076	1/8" Thick x 1 3/4" Diameter	1" Diameter Pulls and Posts	12.00
SP1077	1/8" Thick x 2" Diameter	1" Diameter Pulls and Posts	12.00

Flush Pull Fasteners

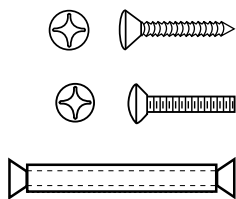

Part	Description	Door Type	Price
SP1006	#8 x 7/8" Oval Head SMS	Wood or Metal	0.60
SP1007	#8 - 32 x 3/4" Oval Head MS	Metal	0.60
SP1034	#8 - 32 x 1 5/8" Brass Sleeve MS	Wood or Metal	3.30

Plate Fasteners

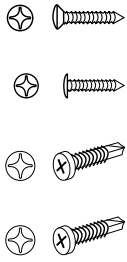

Part	Description	For Use With	Price
SP1008	#6 x 5/8" Oval Head SMS	Push and Pull Plates; Kick Plates	15.20/c
SP1009	#6 x 5/8" Truss Head SMS	Kick Plates	15.20/c
SP1050	#6 x 5/8" Pan Head (TEK) Self-Drilling Screw - Stainless Steel	Stainless Steel Kick Plates	38.00/c
SP1069	#6 x 5/8" Pan Head (TEK) Self-Drilling Screw - Brass Plated	Brass Kick Plates	70.40/c

Sex Nuts

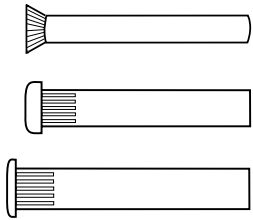

Part	Description	For Use With	Price
SP1018	#8 - 32 FH Sex Nut	#94 Series Flush Pulls	4.40
SP1019	#10 - 24 x 1 1/8" Sex Nut	#580 Surface Bolts	2.50
SP1070	1/4 - 20 x 1 1/8" Sex Nut	#585 Surface Bolts	6.00

Tamperproof Torx® Head Security Fasteners

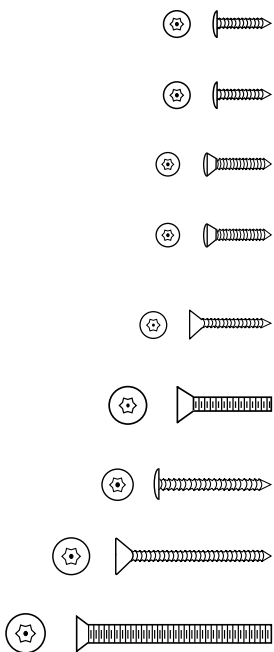

Part	Description	For Use With	Price
SP1016	#6 x 1/2" Button Head SMS	Kick Plates (Stainless Steel)	0.80
SP1016B	#6 x 1/2" Button Head SMS Brass Plated	Kick Plates (Stainless Steel)	2.20
SP1042	#6 x 5/8" OH SMS	Push and Pull Plates (Stainless Steel)	0.80
SP1042B	#6 x 5/8" OH SMS Brass Plated	Push and Pull Plates (Stainless Steel)	2.70
SP1017	#8 x 3/4" FH SMS	#94 Flush Pulls, #131 Door Pulls, and #555 Flush Bolts	1.80
SP1035	#8 - 32 x 3/4" FH MS	#94 Flush Pulls, #131 Door Pulls, and #555 Flush Bolts	1.80
SP1036	#8 x 1" Button Head SMS	#409 Wall Stops	1.70
SP1037	#12 x 1 1/2" FH WS	#440/442 Door Stops	2.20
SP1038	1/4 - 20 x 2 1/2" FH MS	Door Pulls Type 1 Mount	3.30

*Torx® is a registered trademark of Textron Inc.

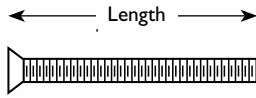

Standard Thru-Bolt Screw
for Countersunk Holes

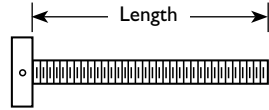

Decorative Thru Bolt for
Wood or Metal Doors

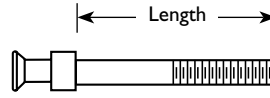

Cone Head Bolt for Back-To-Back
Wood or Metal Doors

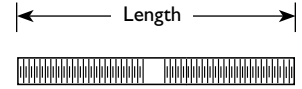

LH/RH Bolts Without Heads

Mounting Kits for Door Pulls

Part	Mounting Type	Description	Price
KIT1	1	2 ea. ¼-20 x 2¼" Thru Bolts and 2 ea. Finish Washers; Specify Finish	3.60
KIT1HD	1HD	2 ea. ⅝-18 x 2¼" Thru Bolts and 2 ea. Finish Washers; Specify Finish	7.20
KIT1XHD	1XHD	2 ea. ⅝-16 x 2½" Thru Bolts and 2 ea. Finish Washers; Specify Finish	10.50
KIT5	5	2 ea. ¼-20 x 2¼" Cone Head Bolts and 2 ea. Set Screws	7.20
KIT5HD	5HD	2 ea. ⅝-18 x 2¼" Cone Head Bolts and 4 ea. Set Screws	10.70
KIT6	6	2 ea. ¼-20 x ½" Cone Head Bolts and 2 ea. Set Screws	7.20
KIT6HD	6HD	2 ea. ⅝-18 x ½" Cone Head Bolts and 4 ea. Set Screws	10.70
KIT11	11	2 ea. ⅝-16 x 3½" LH/RH Bolt and 2 ea. Spanner Collars for 1¼" Doors; Specify Pull Diameter and Finish	27.30
KIT12-1	12	2 ea. ¼-20 x 2¼" Decorative Thru Bolts; 1" Dia.; Specify Finish	24.00
KIT12-1HD	12HD	2 ea. ⅝-18 x 2¼" Decorative Thru Bolts; 1" Dia.; Specify Finish	28.70
KIT12-1.25XHD	12XHD	2 ea. ⅝-16 x 2¼" Decorative Thru Bolts; 1¼" Dia.; Specify Finish	31.30
KIT12-1.5XHD	12XHD	2 ea. ⅝-16 x 2¼" Decorative Thru Bolts; 1½" Dia.; Specify Finish	36.40
KIT13	13	2 ea. ¼-20 x 1⅝" Cone Head Bolts; 2 ea. Metal Washers; 4 ea. Plastic Washers; 2 ea. Bushings for ½" Glass Doors; 2 ea. Set Screws; Specify if other than ½" Glass	13.20
KIT13HD	13HD	2 ea. ⅝-18 x 1⅝" Cone Head Bolts; 2 ea. Metal Washers; 4 ea. Plastic Washers; 2 ea. Bushings for ½" Glass Doors; 4 ea. Set Screws; Specify if other than ½" Glass	16.70
KIT14	14	2 ea. ⅝-16 x 2¼" LH/RH Bolt; 2 ea. Spanner Collars; 2 ea. Bushings; 4 ea. Washers for ½" Glass Doors; Specify Pull Diameter and Finish	32.50
KIT15	15	2 ea. ¼-20 x 1⅝" Decorative Thru Bolts; 1" Dia.; 2 ea. Bushings; 4 ea. Plastic Washers; Specify Finish and Glass Thickness/Hole Size	28.70
KIT15HD	15HD	2 ea. ⅝-18 x 1⅝" Decorative Thru Bolts; 1" Dia.; 2 ea. Bushings; 4 ea. Plastic Washers; Specify Finish and Glass Thickness/Hole Size	33.60
KIT15-1.25XHD	15XHD	2 ea. ⅝-16 x 1⅝" Decorative Thru Bolts; 1¼" Dia.; 2 ea. Bushings; 4 ea. Plastic Washers; Specify Finish and Glass Thickness/Hole Size	36.40
KIT15-1.5XHD	15XHD	2 ea. ⅝-16 x 1⅝" Decorative Thru Bolts; 1½" Dia.; 2 ea. Bushings; 4 ea. Plastic Washers; Specify Finish and Glass Thickness/Hole Size	41.70
KIT16	16	2 ea. ¼-20 x 2¼" Double Cone Head Bolts and 4 ea. Set Screws	10.70
KIT16HD	16HD	2 ea. ⅝-18 x 2¼" Double Cone Head Bolts and 4 ea. Set Screws	13.20

Part	Mounting Type	Description	Price
KIT17	17	2 ea. ¼-20 x ½" Double Cone Head Bolts and 4 ea. Set Screws	10.70
KIT17HD	17HD	2 ea. ⅝-18 x ½" Double Cone Head Bolts and 4 ea. Set Screws	13.20
KIT18	18	2 ea. ¼-20 x 1⅝" Double Cone Head Bolts; 2 ea. Metal Washers; 4 ea. Plastic Washers; 2 ea. Bushings for ½" Glass Doors; Specify if other than ½" Glass and 4 ea. Set Screws	18.30
KIT18HD	18HD	2 ea. ⅝-18 x 1⅝" Double Cone Head Bolts; 2 ea. Metal Washers; 4 ea. Plastic Washers; 2 ea. Bushings for ½" Glass Doors; Specify if other than ½" Glass and 4 ea. Set Screws	20.90
KIT-T1	T1	1 ea. ¼-20 X 2¼" Cone Head Bolt; 1 ea. ¼-20 Cone Head Union; 2 ea. Set Screws; 2 ea. ¼-20 x 2¼" — 1" Dia. Decorative Thru Bolts; Specify Finish	31.20
KIT-T2	T2	1 ea. ¼-20 X 1⅝" Cone Head Bolt; 1 ea. ¼-20 Cone Head Union; 2 ea. Set Screws; 2 ea. ¼-20 x 1⅝" — 1" Dia. Decorative Thru Bolts; 1 ea. Metal Washer; 6 ea. Plastic Washers; 3 ea. Bushings; Specify Finish	38.90
KIT-T3	T3	1 ea. ¼-20 X 2¼" Cone Head Bolt; 1 ea. ¼-20 Cone Head Union; 2 ea. Set Screws; 2 ea. ¼-20 x 2¼" Thru Bolts; 2 ea. Finish Washers; Specify Finish	10.70
KIT-T4	T4	1 ea. ¼-20 X 2¼" Cone Head Bolt; 2 ea. ¼-20 x ½" Cone Head Bolts; 3 ea. Set Screws	10.70
KIT-T5	T5	1 ea. ¼-20 X 2¼" Cone Head Bolt; 2 ea. ¼-20 x ½" Cone Head Wood Screws; 3 ea. Set Screws	10.70
KITRM1.25	11x1XHD	2 ea. ⅝-16 x 2½" Thru-Bolts; 2 ea. Finish Washers; 1 ea. ⅝-16 x 3½" LH/RH Bolt; 1 ea. 1¼" Spanner Collar; Specify Finish	24.20
KITRM360	11x12XHD	2 ea. ⅝-16 x 2¼" Decorative Thru Bolts 1¼" Dia.; 1 ea. ⅝-16 x 3½" LH/RH Bolt; 1 ea. 1¼" Spanner Collar; Specify Finish	44.90
KITRM360G	14x15XHD	2 ea. ⅝-16 x 2¼" Decorative Thru Bolts 1¼" Dia.; 1 ea. ⅝-16 x 2¼" LH/RH Bolt; 1 ea. 1¼" Spanner Collar; 3 ea. Bushings; 6 ea. Plastic Washers; Specify Finish	52.70
KITRM1.5	11x1XHD	2 ea. ⅝-16 x 2½" Thru Bolts; 2 ea. Finish Washers; 1 ea. ⅝-16 x 3½" LH/RH Bolt; 1 ea. 1¼" Spanner Collar; Specify Finish	26.70
KITRM380	11x12XHD	2 ea. ⅝-16 x 2¼" Decorative Thru Bolts 1½" Dia.; 1 ea. ⅝-16 x 3½" LH/RH Bolt; 1 ea. 1¼" Spanner Collar; Specify Finish	52.70
KITRM380G	14x15XHD	2 ea. ⅝-16 x 2¼" Decorative Thru Bolts 1½" Dia.; 1 ea. ⅝-16 x 1¼" LH/RH Bolt; 1 ea. 1¼" Spanner Collar; 3 ea. Bushings; 6 ea. Plastic Washers; Specify Finish	60.40

Push and Pull Bars

Page	Part	28/628	3/605 4/606	10/612 10B/613	10BE	26/625 26D/626	32D/630	32DMS
A2	10		331	331	328	320		
A2	10BO		107	107	106	104		
A2	11	134	272	311	166	301	145	166
A2	12	134	272	311	166	301	145	166
A3	14	134	311	349	182	338	158	182
A3	15	134	311	349	182	338	158	182
A3	18	134	311	349	182	338	158	182
A3	19	134	311	349	182	338	158	182
A4	20	326			399		347	399
A4	21	369	773	948	445	920	387	445
A4	22	376			460		400	460
A4	23	399	872	1044	483	1013	420	483
A5	25	128			144		125	144
A5	26	134	292	349	151	338	131	151
A5	27	575			687		597	687
A5	28	634	1352	1643	746	1595	649	746
A5	29	627			746		649	746
A5	30	663	1449	1739	785	1687	682	785

Page	Part	28/628	3/605 4/606	10/612 10B/613	10BE	26/625 26D/626	32D/630	32DMS
A6	31	327			499		434	499
A6	32	344	785	880	511	854	444	511
A6	33	283			390		339	390
A6	34	300	635	711	402	690	349	402
A6	35	484			889		773	889
A6	36	497	1419	1588	913	1540	794	913
A7	40		287	287	256	278		
A7	41		203	203	181	196		
A7	42		147	147	131	142		
A8	43	151	455	545	322	528	280	322
A8	44	140	425	510	304	495	264	304
A8	45	132	386	463	287	449	250	287
A9	50		380	416	371	403		
A9	51		152	167	150	162		
A9	51BO		30	34	30	33		
A9	52		679	747	666	725		
A9	53		130	146	131	141		

Push & Pull Extra Length Bars

Bars over 36" add per inch the following additional cost.

Description	28/628	3/605 4/606	10/612 10B/613	10BE	26/625 26D/626	32D/630
Over ¾" thru 1½"	3	6	7	7	6	5
Over 1½" thru 3"	4	8	9	9	8	7

Mounting Types for Push Bars #10 through #45 and #50, #51, #52

Mounting charge included in list price.

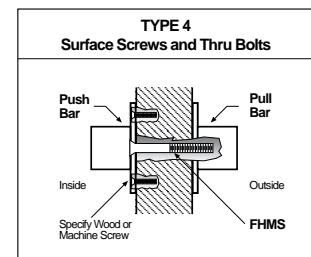
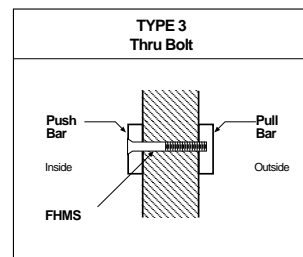
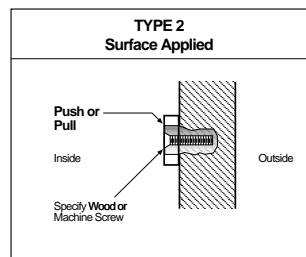
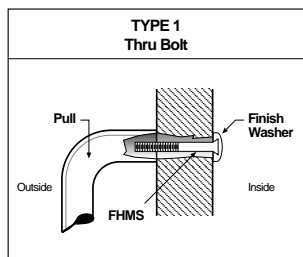

See page 6 for detailed mounting drawings. Engraving "Push" or "Pull" on 1" Series 47 Push Bars add \$94.50 (½" Letter Height).

Page	Part	28/628	313/710 314 315/711 Pwdr Coat	3/605 4/606	10/612 10B/613	26/625 26D/626	32D/630	32/629	10BE 32DMS	32D316	32316
A11	SP47	74	89	223	279	215	203	233	230	256	275
A11	47	63	77	210	210	204	186	209	212	239	250
A11	47-2	124	151	420	420	407	371	418	423	476	499
A11	47-3	185	226	629	629	610	557	627	634	713	749
A11	48	63	74	165	195	160	109	147	134	153	175
A12	BP47	99	112	246	246	238	218	244	246	274	285
A12	BP47-2	198	224	526	526	510	470	523	527	580	603
A12	BP47-3	259	299	747	747	725	667	743	750	830	865
Straight Single Bar Sets											
A13	11047	90	107	299	322	290	252	285	288	328	350
A13	111A47	91	108	302	337	293	254	291	290	332	355
A13	11147	91	108	302	337	293	260	297	297	338	361
A13	11247	92	110	314	348	305	267	303	305	348	372
A13	11847	102	122	357	394	347	291	332	330	382	405
Straight Double Bar Sets											
A14	11047-2	151	182	508	532	492	437	494	498	565	599
A14	111A47-2	153	183	511	546	496	440	499	501	569	603
A14	11147-2	153	183	511	546	496	446	505	508	575	610
A14	11247-2	154	185	524	557	508	452	511	515	587	621
Straight Triple Bar Sets											
A15	11047-3	212	256	717	741	696	623	703	709	802	849
A15	111A47-3	213	257	720	755	699	625	708	711	806	853
A15	11147-3	213	257	720	755	699	631	713	719	812	859
A15	11247-3	215	260	733	767	711	639	720	726	825	870
Offset Single Bar Sets											
A16	BF15647	106	128	335	360	324	276	314	316	375	399
A16	BF157A47	110	133	343	369	333	280	317	320	380	404
A16	BF15747	110	133	343	369	333	284	321	326	385	410
A16	BF15847	117	139	351	378	340	292	331	335	395	420
A16	BF15947	132	154	381	404	370	317	357	361	428	453
Offset Double Bar Sets											
A17	BF15647-2	167	202	545	570	528	462	523	527	613	648
A17	BF157A47-2	172	208	552	579	536	466	526	531	617	653
A17	BF15747-2	172	208	552	579	536	470	530	538	622	658
A17	BF15847-2	178	213	561	586	544	477	540	545	633	669
Offset Triple Bar Sets											
A18	BF15647-3	229	277	754	779	732	647	731	738	850	898
A18	BF157A47-3	233	283	762	788	739	651	734	743	854	902
A18	BF15747-3	233	283	762	788	739	655	739	748	861	908
A18	BF15847-3	240	288	770	796	747	664	748	756	870	917
Series 47 Extra Length Bars - Bars over 36" add per inch the following additional cost per bar.											
		3	3	4	4	3	3	5	5	5	6

Engraving "Push" or "Pull" on 1" Series 47 Push Bars add \$94.50 (½" Letter Height).

Series 47 Tubular Push Bars									
Page	Part	3/605	4/606	10/612	10B/613	10BE	32D/630	32/629	32DMS
A19	T47	171	171	181	181	139	121	140	139
A19	T47-2	340	340	362	362	277	241	281	277
A19	T47-3	511	511	541	541	415	361	420	415
Series 47 Tubular Straight Single Bar Sets									
A20	T11047	261	261	273	273	201	175	211	201
A20	T111A47	265	265	280	280	204	177	213	204
A20	T11147	265	265	280	280	204	177	213	204
A20	T11247	271	271	284	284	206	179	215	206
A20	T11847	284	284	296	296	217	189	228	217
Series 47 Tubular Offset Single Bar Sets									
A21	TBF15647	289	289	300	300	209	181	233	209
A21	TBF157A47	292	292	305	305	212	185	235	212
A21	TBF15747	292	292	305	305	212	185	235	212
A21	TBF15847	296	296	309	309	215	187	238	215
A21	TBF15947	311	311	326	326	230	200	252	230

Set Mounting Charges

Mounting Spec #	Door Type	Pull Type	Mounting Type			Add On
			Pull Free End	Push Free End	Common End	
T1	Metal & Wood	Straight or Offset	12	12	5	23
T1HD	Metal & Wood	Straight or Offset	12HD	12HD	5HD	29
T2	Glass	Straight or Offset	15	15	13	27
T2HD	Glass	Straight or Offset	15HD	15HD	13HD	34
T3*	Metal & Wood	Straight or Offset	1	1	5	Included
T3HD	Metal & Wood	Straight or Offset	1HD	1HD	5HD	16
T4	Metal	Straight	6	6	5	11
T4HD	Metal	Straight	6HD	6HD	5HD	25
T4	Metal	Offset	17	17	16	20
T4HD	Metal	Offset	17HD	17HD	16HD	27
T5	Wood	Straight or Offset	8	8	5	20

*T3 is the standard mounting method for Metal and Wood Doors.

NOTE: Heavy Duty (HD) mounting features hex drive for positive tightening and large overall size for superior strength. Recommended for high frequency and rough service openings.

TYPICAL MOUNTING

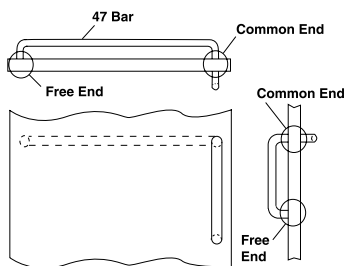

Location Standards

Positioning Applications:

- door pulls to plates
- engraving on plates
- cutouts on plates
- cutout and engraving on plates

NOTE: Be sure the pull you choose will fit on the plate, allowing for cutouts and/or engraving.

Sizing:

- 1 1/4" standard cylinder hole cutout size
- 3/8" diameter standard turn knob hole
- other cutout sizes and styles are readily available

Pull Positioning On Plates 4" Or Less In Width

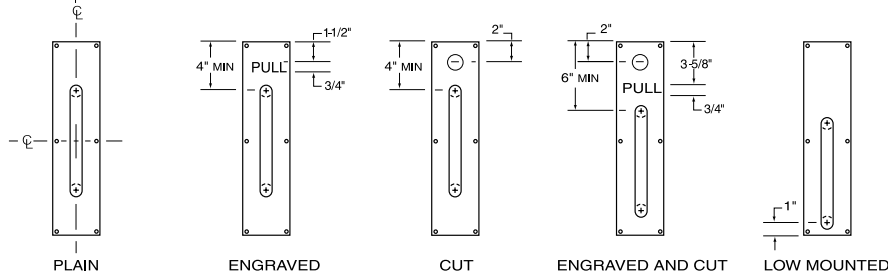

Pull Positioning On Plates Wider Than 4" (Handing Required)

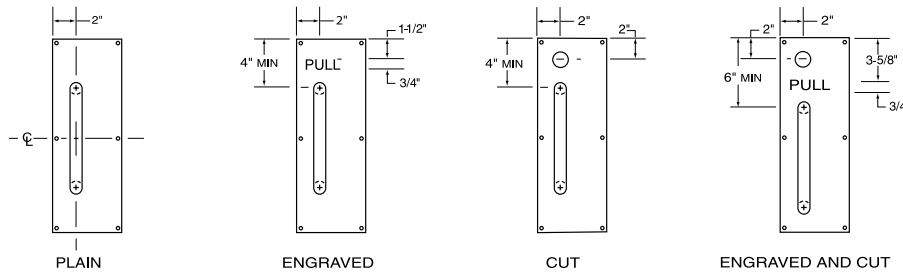

Recommended Locations On Door

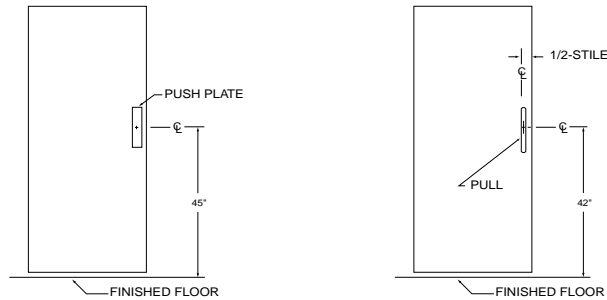

Engraving: 3/4" high condensed block letters with black enamel fill; other letter sizes and styles are readily available.

Description	Price
Engraving "Push", "Pull", "Men" or "Women"	20 (24 for Stainless Steel)
Push Plate Adhesive Mounting	8

Additional Charges Per Thickness of Push Plate

Part	Description	70	71	73	74
CFC	Cut for Cylinder	2	3	5	9
CFTT	Cut for Turn Knob	2	3	5	9

ADA Accessibility Guidelines for Buildings and Facilities (ADAAG) as amended through January 1998

4.13.9 Door Hardware. Handles, pulls, latches, locks, and other operating devices on accessible doors shall have a shape that is easy to grasp with one hand and does not require tight grasping, tight pinching, or twisting of the wrist to operate. Lever-operated mechanisms, push-type mechanisms, and U-shaped handles are acceptable designs. When sliding doors are fully open, operating hardware shall be exposed and usable from both sides. Hardware required for accessible door passage shall be mounted no higher than 48 in. (1220 mm) above finished floor.

See page 18 for standard locations and sizes of Cylinder Cutouts (CFC) and Turn Knob Cutouts (CFTT), engraving and pricing.

Push Plates - .050" Thick

No. 70 - Square Ends											
Page	Part	28/628	3/605 4/606	10/612 10B/613	26/625 26D/626	32D/630	32/629	10BE 32DMS	32D316	32316	.040" Thick 3Lifetime
B2	70A	12	22	23	22	12	16	14	20	29	32
B2	70B	13	23	27	26	15	20	17	20	29	32
B2	70C	13	27	30	29	16	22	18	22	34	37
B2	70E	19	41	47	45	27	36	31	34	53	58
B2	70F	21	47	55	53	29	40	33	42	63	69
B2	70G	15	31	38	36	19	25	22	27	45	50
No. 70RC - Round Corners											
B2	70RCA	15	25	26	25	15	19	17	23	32	36
B2	70RCB	17	27	31	30	18	23	21	23	32	36
B2	70RCC	17	30	34	33	20	25	23	25	39	43
B2	70RCE	22	44	50	48	30	40	35	40	57	63
B2	70RCF	24	51	59	57	33	44	38	45	66	73
B2	70RCG	19	34	41	39	22	28	25	30	48	53
No. 70RE - Round Ends											
B2	70REA	21	30	32	31	21	25	24	29	39	44
B2	70REB	22	32	38	36	23	28	26	29	39	44
B2	70REC	23	36	41	39	25	30	29	30	44	50

Push Plates - .062" Thick

No. 71 - Square Corners			
Page	Part	10BE 32DMS	32D/630
B3	71A	22	19
B3	71B	24	21
B3	71C	28	24
B3	71E	37	32
B3	71F	43	37
B3	71G	32	28
No. 71RC - Round Corners			
B3	71RCA	26	23
B3	71RCB	29	25
B3	71RCC	32	28
B3	71RCE	43	37
B3	71RCF	46	40
B3	71RCG	37	32
No. 71RE - Round Ends			
B3	71REA	35	30
B3	71REB	37	32
B3	71REC	39	34

Concealed Mount Pull Plate Sets

See page 18 for standard locations and sizes of Cylinder Cutouts (CFC) and Turn Knob Cutouts (CFTT), engraving and pricing. See page 7 for detail drawing of Type 9 mounting.

Pull Plate x Plate with Lug				
Page	Part	32D/630	32DMS	10BE
B16	107x73B/73BL	147	169	171
B16	110x73C/73CL	193	222	224
B16	111x73C/73CL	200	230	232

Pull (only) x Plate with Lug				
Page	Part	32D/630	32DMS	10BE
B16	107x73BL	103	118	120
B16	110x73CL	144	166	167
B16	111x73CL	153	176	178

Push Plates

See page 18 for standard locations and sizes of Cylinder Cutouts (CFC) and Turn Knob Cutouts (CFTT), engraving and pricing.

No. 73 - Square Corners (.125" Thick)										
Page	Part	28/628	3/605 4/606	10/612 10B/613	10BE 32DMS	26/625 26D/626	32D/630	32/629	32D316	32316
B4	73A	24	67	80	47	77	41	58	52	67
B4	73B	28	73	84	51	81	44	60	56	73
B4	73C	29	80	89	55	86	48	66	62	79
B4	73E	35	107	117	76	113	66	84	91	103
B4	73F	42	133	144	93	139	81	95	102	116
B4	73G	31	95	107	62	103	54	76	73	88
No. 73RC - Round Corners (.125" Thick)										
B4	73RCA	35	77	88	56	85	49	70	61	78
B4	73RCB	37	82	93	60	90	52	71	65	82
B4	73RCC	40	88	97	64	94	56	78	71	87
B4	73RCE	47	116	125	86	121	75	96	100	114
B4	73RCF	54	144	153	104	148	90	107	112	125
B4	73RCG	43	103	116	71	112	62	87	82	97
No. 73RE - Round Ends (.125" Thick)										
B4	73REA	53	92	103	74	100	64	85	77	92
B4	73REB	56	97	109	77	105	67	87	81	96
B4	73REC	57	103	114	83	110	72	93	87	102
Laminate and Clear Plastic - Square Corners (.125" Thick)										
Page	Part	Black	Brown	Gray	Beige	Clear				
B5	75A	12	12	12	12	12				
B5	75B	13	13	13	13	13				
B5	75C	13	13	13	13	14				
B5	75E	16	16	16	16	17				
B5	75F	18	18	18	18	19				
B5	75G	15	15	15	15	16				
Decorative (.050" Thick)										
Page	Part	3/605 4/606	10/612 10B/613	10BE	26/625 26D/626	.040" Thick 3Lifetime				
B6	76B	39	43	39	41	54				
B6	76C	42	46	42	44	57				
B6	77B	39	43	39	41	54				
B6	77C	42	46	42	44	57				

Push Plates (con't)

See page 18 for standard locations and sizes of Cylinder Cutouts (CFC) and Turn Knob Cutouts (CFTT), engraving and pricing.

.050" Thick										
Page	Part	28/628	3/605 4/606	10/612 10B/613	26/625 26D/626	32D/630	32/629	10BE 32DMS	32D316	32316
B6	80	35	60	66	64	38	50	44	54	89
B6	81	37	63	68	66	42	54	48	57	94
B6	82	40	67	75	72	45	57	52	60	102
B6	84	62	107	115	111	76	89	87	89	140
B7	85	23	45	46	44	30		35		
B7	86	33	52	54	52	37		43		
.125" Thick										
B7	87	58	123	132	128	89	107	102		

Flush Pulls

Heavy Duty Security - Cast Brass											
Page	Part	4/606	26D/626	10BE							
B8	D89	88	57	65							
Cylinder Pulls - .125" Thick											
Page	Part	28/628	3/605 4/606	10/612 10B/613	10BE	26/625 26D/626	32D/630	32/629	32DMS	32D316	32316
B8	90	44	49	55	52	53	43		52		
B8	90B	37	47	49	46	47	40		46		
Combination Pulls - .125" Thick - See page 18 for standard locations and sizes of Cylinder Cutouts (CFC) and Turn Knob Cutouts (CFTT), engraving and pricing.											
B8	91	42	78	82	60	79	53		60		
B8	92	46	81	85	64	82	56		64		
B8	93	68	143	152	117	147	102		117		
Flush Pulls - .125" Thick											
B9	94		67	72	40	69	35	52	40	45	62
B9	94BTB (pair)		140	148	88	143	76	105	88	95	129
B9	94C		69	75	44	72	38	54	44	47	64
B10	94L		78	81	51	78	44	60	51	55	72
B10	94P		69	75	44	72	38	54	44	47	64
B10	94P x 94L		146	153	94	148	81	112	94	100	134
Dead Lock Pulls - For Barrier Free grip specify BF94DLL or BF94DLS. Used with dead bolt lock. 1¼" cylinder hole is standard.											
B9	94DLL		118	118	95	114	82	102	95	102	121
B9	94DLS		99	99	75	96	65	85	75	85	102
Cast Brass - Fasteners concealed in cup.											
B11	95A		30	31	34	30					
B11	95B		31	33	37	32					
B11	95R		41	43	47	41					
Flush Pull - .125" Thick - See page 18 for standard locations and sizes of Cylinder Cutouts (CFC) and Turn Knob Cutouts (CFTT), engraving and pricing.											
B12	96		97	104	72	101	63		72		
Barrier Free - .125" Thick											
B12	BF97		124	131	101	127	88		101		
B12	BF97L		146	155	127	149	110		127		

Straight Door Pulls & Door Pull Sets

See page 7 for mounting selection and charges. **NOTE:** For BF Barrier Free projection on applicable straight door pulls add: \$8.40 each list. Add \$52.50 for knurling — round pulls only.

Page	Part	28/628	313/710 315/711 Powder Coat	3/605 4/606	10/612 10B/613	10BE	26/625 26D/626	32D/630	32/629	32DMS	32D316	32316
B14	102	20	24	42	51	30	40	26	41	30		
B14	105	21	25	47	58	33	45	28	42	32	47	57
B14	106	21	25	48	60	34	46	29	44	33	48	59
B14	107	23	28	53	65	37	50	31	45	36	50	60
B14	108	25	30	61	77	46	59	40	52	45	57	68
B14	109	28	31	66	85	51	64	44	57	50	61	74
B14	110	29	32	89	114	77	86	66	78	75	89	101
B14	111A	30	33	92	127	80	89	69	83	79	94	105
B14	111	30	33	92	127	88	89	75	88	86	100	111
B14	112	31	35	104	138	95	101	81	94	93	111	124
B14	118	42	47	148	185	123	143	105	124	121	145	156
Straight Door Pull Sets — Type 5 Back-to-Back Mount for 1¾" Door.												
B14	107BTB5	55	63	111	139	83	107	71	97	81	105	129
B14	108BTB5	59	67	130	159	102	126	87	110	100	123	146
B14	110BTB5	65	72	186	235	165	180	140	161	161	187	209
B14	111BTB5	67	74	194	263	185	188	158	184	182	207	231
B14	112BTB5	69	81	216	285	200	210	171	197	196	231	254
Straight Door Pull Sets — Type 13 Back-to-Back Mount for ½" Glass Door.												
B14	110BTB13	72	81	194	243	172	188	147	168	169	194	217
B14	111BTB13	74	84	201	269	193	194	164	192	189	214	238
B14	112BTB13	78	88	224	292	208	216	178	203	205	238	262

Security Door Pull

For use on security hollow metal doors with reinforcing plate and access hole cover plate with TORX - security torx screws — all to be supplied by door manufacturer.

Page	Part	10BE	32D/630	32DMS
B16	110-6SP	193	164	189

Tubular Door Pulls & Door Pull Sets

Tubular Straight Door Pulls — Type 1 Thru-Bolt Mount for 1¾" Door.									
Page	Part	3/605	4/606	10/612	10B/613	10BE	32D/630	32/629	32DMS
B15	T110	92	92	94	94	66	57	70	66
B15	T111A	96	96	99	99	68	59	72	68
B15	T111	96	96	99	99	68	59	72	68
B15	T112	101	101	104	104	71	62	77	71
B15	T118	113	113	115	115	81	70	89	81
Tubular Straight Door Pull Sets — Type 5 Back-to-Back Mount for 1¾" Door.									
B15	T110BTB5	190	190	196	196	142	123	151	142
B15	T111BTB5	202	202	207	207	147	127	157	147
B15	T112BTB5	212	212	216	216	152	132	161	152
Tubular Straight Door Pull Sets — Type 13 Back-to-Back Mount for 1¾" Glass.									
B15	T110BTB13	198	198	205	205	149	130	159	149
B15	T111BTB13	209	209	214	214	154	134	163	154
B15	T112BTB13	218	218	223	223	159	138	167	159

Door Pulls with Base Plates

Page	Part	28/628	313/710 315/711 Powder Coat	3/605 4/606	10/612 10B/613	26/625 26D/626	32D/630	32/629	32DMS	32D316	32316	10BE
B17	Y102	35	40	62	75	60	43	58	49			50
B17	Y105	35	40	67	82	65	46	59	53	64	77	54
B17	Y106	35	42	68	84	66	47	61	54	66	79	55
B17	Y107	37	43	74	89	70	49	62	56	67	80	57
B17	Y108	42	45	83	99	80	57	69	66	77	87	67
B17	Y109	43	47	88	107	85	61	77	71	81	92	72
B17	Y110	44	47	110	137	106	83	96	96	107	121	98
B17	Y111A	45	48	114	151	110	85	101	98	113	125	100
B17	Y111	45	48	114	151	110	93	106	106	120	130	108
B17	Y112	46	51	126	162	122	99	113	114	130	141	116
B17	Y118	56	62	169	208	164	123	141	141	162	174	144

Door Pulls

Pulls - Engraving available vertically. See page 18 for pricing.									
Page	Part	28/628	3/605 4/606	10/612 10B/613	10BE	26/625 26D/626	32D/630	32DMS	3Lifetime
B18	120	84			122		106	122	
B18	121	89			131		114	131	
B18	122	24	55	73	38	70	33	38	
B18	123	28			46		40	46	
B19	125	28	59	63	51	61	44	51	
B19	126	30	69	77	57	74	49	57	
Cast Pulls									
B19	130	24	42	44	50	42	43	50	
B19	131	24	42	44	50	42	43	50	
B20	132	24	35	40	47	38	41	47	51
B20	D133		54		57		49	57	
B20	134		53	57	63	55			
B21	137		43	47	52	45	43		
B21	137L		87	87	96	83			
B21	138	36	61	67	75	65			
B21	139	36	61	67	75	65			
Cast Pulls - See page 7 for mounting selection and charges.									
B22	147		69	69	77	67			88
B22	147L		116	138	154	134			185
B22	148		104	104	116	101			136
B22	149		128	128	142	124			168

90° Offset Door Pulls & Door Pull Sets

See page 8 for mounting selection and charges.

Page	Part	28/628	313/710 315/711 Powder Coat	3/605 4/606	10/612 10B/613	26/625 26D/626	32D/630	32/629	32DMS	32D316	32316	10BE
B28	BF150	37	47	91	111	88	63	85	73	92	104	74
B28	BF151	42	50	98	121	95	68	88	78	96	107	79
B28	BF152	45	53	103	128	100	72	94	83	101	115	84
B28	BF156	45	53	126	152	122	90	105	104	136	151	106
B28	BF157A	50	58	133	160	129	95	109	109	141	155	111
B28	BF157	50	58	133	160	129	99	114	114	148	160	116
B28	BF158	56	64	141	168	137	106	123	122	158	171	124
B28	BF159	69	80	171	195	166	131	150	151	192	204	154
Offset Door Pulls Sets - Type 16 Back-to-Back Mount for 1¾" Door. (Double Cone Head)												
B28	BF156BTB16	102	117	265	315	256	192	225	221	287	312	226
B28	BF157ABTB16	111	130	279	332	271	202	231	232	296	320	236
B28	BF157BTB16	111	130	279	332	271	210	240	242	308	334	246
B28	BF158BTB16	124	141	296	348	287	226	256	260	329	354	265
B28	BF159BTB16	154	171	355	402	344	276	310	317	395	421	323
Offset Door Pulls - Type 17 Concealed Mount for 1¾" Aluminum Door. (Double Cone Head)												
B28	BF156C17	59	66	139	165	134	103	121	118	152	163	121
B28	BF157AC17	64	72	148	173	143	107	124	123	156	168	126
B28	BF157C17	64	72	148	173	143	112	128	129	161	174	132
B28	BF158C17	69	80	156	182	151	120	135	138	172	184	140
B28	BF159C17	86	94	185	208	179	145	162	166	205	218	169
Tubular Offset Door Pulls - Type 1 Thru-Bolt Mount for 1¾" Door.												
B29	TBF156			119	122		64	93	73			73
B29	TBF157A			123	125		66	95	76			76
B29	TBF157			123	125		66	95	76			76
B29	TBF158			127	130		68	97	78			78
B29	TBF159			141	146		83	111	96			96
Tubular Offset Door Pull Sets - Type 16 Back-to-Back Mount for 1¾" Door. (Double Cone Head)												
B29	TBF156BTB16			251	256		140	200	161			161
B29	TBF157ABTB16			259	263		146	204	168			168
B29	TBF157BTB16			259	263		146	204	168			168
B29	TBF158BTB16			265	271		151	208	174			174
B29	TBF159BTB16			296	306		178	238	205			205
Tubular Offset Door Pull - Type 17 Concealed Mount for 1¾" Aluminum Door. (Double Cone Head)												
B29	TBF156C17			134	137		79	107	91			91
B29	TBF157AC17			138	140		81	109	93			93
B29	TBF157C17			138	140		81	109	93			93
B29	TBF158C17			141	143		83	111	96			96
B29	TBF159C17			157	162		97	127	112			112

90° Offset Door Pulls with Base Plates

See page 8 for mounting selection and charges.

Page	Part	28/628	313/710 315/711 Powder Coat	3/605 4/606	10/612 10B/613	26/625 26D/626	32D/630	32/629	32DMS	32D316	32316	10BE
B30	YBF150	54	62	112	134	108	81	103	93	110	124	95
B30	YBF151	56	64	119	143	114	84	106	97	114	127	99
B30	YBF152	59	66	125	152	121	89	113	103	121	133	105
B30	YBF156	59	66	147	174	142	107	125	123	156	168	126
B30	YBF157A	64	72	155	183	150	112	128	129	160	173	132
B30	YBF157	64	72	155	183	150	116	132	134	166	178	137
B30	YBF158	69	80	163	192	158	124	139	142	176	190	145
B30	YBF159	86	94	193	218	187	149	167	171	209	224	174

45° Offset Door Pulls

See page 8 for mounting selection and charges.

Page	Part	28/628	313/710 315/711 Powder Coat	3/605 4/606	10/612 10B/613	26/625 26D/626	32D/630	32/629	32DMS	32D316	32316	10BE
B31	BF160	37	47	91	111	88	63	85	73	92	104	74
B31	BF161	42	50	98	121	95	68	88	78	96	107	79
B31	BF162	45	53	103	128	100	72	94	83	101	115	84
B31	BF166	45	53	126	152	122	111	127	128	136	151	130
B31	BF167A	50	58	133	160	129	115	131	133	141	155	135
B31	BF167	50	58	133	160	129	120	134	138	148	160	140
B31	BF168	56	64	141	168	137	127	145	146	158	171	149
B31	BF169	69	80	171	195	166	153	170	176	192	204	179

Offset Door Pulls

Call factory for engraving and pricing.

Page	Part	28/628	313/710 315/711	3/605 4/606	10/612 10B/613	10BE	32D/630	32DMS
B32	176	121	125	328	368	212	181	208
B32	177	131	138	368	405	254	216	249
B32	185	142	163	515	515	466	397	457

Hospital Door Pull

Page	Part	3/605 4/606	10/612 10B/613	26/625 26D/626	32D/630	10BE 32DMS
B33	193	52	55	53	53	61

Wooden Door Pull

Wood available in Oiled or Clear Finish. See page 7 for mounting details.

Page	Part	28/628	313/710 315/711	3/605 4/606	10/612 10B/613	26/625 26D/626	32D/630	32/629	10BE 32DMS
B33	208	205	205	201	201	194	189	195	217

Tapered Door Pull

Larger sizes available upon request. See page 7 for mounting details.

Page	Part	28/628	313/710 315/711	3/605 4/606	10/612 10B/613	26/625 26D/626	32D/630	32/629	10BE 32DMS
B33	215	198	210	298	334	324	227	264	261
B33	215L	264	278	538	588	570	387	458	445

Heavy Duty Offset Pulls

Supplied with 3/8"-16 Thru Bolts.

Page	Part	28/628	313/710 315/711 Powder Coat	3/605 4/606	10/612 10B/613	26/625 26D/626	32D/630	32/629	32DMS	32D316	32316	10BE
B34	BF257	131	142	317	364	308	214	274	246	261	290	251
B34	BF258	142	155	341	387	331	233	293	268	278	309	273
B34	BF259	147	162	387	445	376	257	318	295	303	334	301
B34	BF260	162	173	445	516	432	282	345	324	328	357	330

Vandal Resistant Trim

Specify Exit Device make and model to thru bolt directly to device.

Page	Part	10BE 32DMS	32D/630
B34	VRT12	237	218
B35	VRT14	279	258
B35	VRT16	237	218
B34	VRT22		265
B35	VRT24		306
B35	VRT26		268

Pull Plates

Barrier Free - Available in 2 1/2" clearance add \$8.40 list.

Page	Part	28/628	3/605 4/606	10/612 10B/613	26/625 26D/626	32D/630	32/629	32DMS	32D316	32316	3Lifetime	10BE
B23	102 x 70B		64	80	77	39	58	45				46
B23	102 x 70C		67	83	80	41	60	47				48
B23	105 x 70B	31	69	86	83	41	59	47	65	85		48
B23	105 x 70C	32	75	89	86	43	61	50	67	91		51
B23	106 x 70B	31	70	88	85	42	61	49	66	88		50
B23	106 x 70C	32	77	91	88	44	63	51	68	93		52
B23	107 x 70B	34	77	93	90	44	62	51	67	89		52
B23	107 x 70C	34	80	97	93	46	64	53	69	94		54
B23	110 x 70B	40	112	141	137	79	95	91	108	129		93
B23	110 x 70C	40	117	144	140	80	97	92	110	134		94
B23	111 x 70B	42	117	155	150	88	105	101	118	138		103
B23	111 x 70C	42	121	159	153	90	108	103	118	144		105
B24	122 x 70B	34	80	102	99	45		52				53
B24	122 x 70C	35	83	105	102	47		54				56
B24	123 x 70B	37				53		60				62
B24	123 x 70C	37				54		62				63
B24	125 x 70B	37	84	92	89	57		65				66
B24	125 x 70C	37	87	96	92	58		66				68
B24	126 x 70B	42	95	105	102	61		70				71
B24	126 x 70C	42	99	108	105	63		72				74
B25	132 x 70B	34	60	67	65	56		64			80	65
B25	132 x 70C	35	63	70	68	57		65			86	66
B25	137 x 70B		66	77	74	58		66				68
B25	137 x 70C		69	80	77	59		68				69

Decorative Pull Plates

Page	Part	3/605 4/606	10/612 10B/613	10BE	26/625 26D/626	3Lifetime
B26	147 x 76B	108	113	126	109	139
B26	147 x 76C	112	116	129	112	142
B26	147 x 77B	108	113	126	109	139
B26	147 x 77C	112	116	129	112	142
B26	148 x 76B	141	146	162	141	187
B26	148 x 76C	146	150	167	145	191
B26	148 x 77B	141	146	162	141	187
B26	148 x 77C	146	150	167	145	191

Tubular Pull Plates

Part	3/605 4/606	10/612 10B/613	10BE 32DMS	32D/630	32/629
T110 x 70B	115	124	82	71	91
T110 x 70C	120	128	84	73	93
T111 x 70B	122	129	84	73	94
T111 x 70C	125	132	88	77	96

Corner Guards

Other lengths available up to 96" and leg widths up to 6". Part number 290 and 291 includes self-adhesive mounting.
Add 30% for less than 10 each.

Page	Part	Size	3/605 4/606	10/612 10B/613	32D/630
C24	290	2" x 2" x 40"	112	122	67
		2" x 2" x 48"	125	137	72
		3" x 3" x 40"	143	158	77
		3" x 3" x 48"	162	179	85
C24	291	2" x 2" x 40"	119	127	72
		2" x 2" x 48"	130	143	77
		3" x 3" x 40"	150	163	83
		3" x 3" x 48"	169	184	90

Page	Part	Size	3/605 4/606	10/612 10B/613	10BE 32DMS	32D/630
C24	295	2" x 2" x 40"	92	101	57	50
		2" x 2" x 48"	104	118	65	56
		3" x 3" x 40"	125	137	71	61
		3" x 3" x 48"	142	159	79	69
		3" x 3" x 48"	142	159	79	69
C24	296	2" x 2" x 40"	100	107	65	56
		2" x 2" x 48"	109	125	71	61
		3" x 3" x 40"	130	143	77	67
		3" x 3" x 48"	149	166	86	75
		3" x 3" x 48"	149	166	86	75

Mortised Door Edges (UL Approved)

Available in stainless steel, brass and bronze. UL Listed for fire rated doors. Add \$12.60 per edge - specify UL when ordering (300-UL). Includes Phillips Flat Head SMS Fasteners. **To defray set up costs, add 30% for less than 10 pieces.** Add an additional \$11.55 for each cutout.

Page	Part	Height	3/605 4/606	10/612 10B/613	32D/630	10BE 32DMS	32D316
C8	300	Up to 42"H	85	90	49	56	66
		43" - 66"H	129	141	74	85	99
		67" - 96"H	190	203	105	121	144
C8	301	Up to 42"H	85	90	49	56	66
		43" - 66"H	129	141	74	85	99
		67" - 96"H	190	203	105	121	144
C8	302	Up to 42"H	96	102	58	67	71
		43" - 66"H	141	153	87	100	111
		67" - 96"H	208	221	124	142	161
C8	302B	Up to 42"H	96	102	58	67	71
		43" - 66"H	141	153	87	100	111
		67" - 96"H	208	221	124	142	161

Non-Mortise Door Edges (UL Approved)

Available in stainless steel, brass and bronze. UL Listed for fire rated doors. Add \$12.60 per edge - specify UL when ordering (304-UL). Includes Phillips Flat Head SMS Fasteners. To defray set up costs, add 30% for less than 10 pieces. Add an additional \$11.55 for each cutout.

Page	Part	Height	3/605 4/606	10/612 10B/613	32D/630	10BE 32DMS	32D316
C9	304	Up to 42"H	85	90	49	56	66
		43"- 66"H	129	141	74	85	99
		67"- 96"H	190	203	105	121	144
C9	305	Up to 42"H	85	90	49	56	66
		43"- 66"H	129	141	74	85	99
		67"- 96"H	190	203	105	121	144
C9	306	Up to 42"H	96	102	58	67	71
		43"- 66"H	141	153	87	100	111
		67"- 96"H	208	221	124	142	161
C9	306-AST	Up to 96"H			364	419	
C9	306B	Up to 42"H	96	102	58	67	71
		43"- 66"H	141	153	87	100	111
		67"- 96"H	208	221	124	142	161
C9	306B-AST	Up to 96"H			364	419	
C9	307	Up to 42"H	109	117	72	83	87
		43"- 66"H	164	176	110	127	134
		67"- 96"H	244	255	157	181	198

Overlapping Door Edges (UL Approved)

Available in stainless steel, brass and bronze. UL Listed for fire rated doors. Add \$12.60 per edge - specify UL when ordering (308-UL). Includes Phillips Flat Head SMS Fasteners. **To defray set up costs, add 30% for less than 10 pieces.** Add an additional \$11.55 for each cutout. Custom sizes available. Please call for pricing.

Page	Part	Height	3/605 4/606	10/612 10B/613	32D/630	10BE 32DMS	32D316
C12	308	Up to 42"H	96	102	58	67	73
C12	309	Up to 42"H	96	102	58	67	73
C12	310	Up to 42"H	107	113	69	79	85
C12	310B	Up to 42"H	107	113	69	79	85
C12	310BS	Up to 42"H	107	113	69	79	85

Latch Protectors

Page	Part	2C/603	10BE	26D/626	32D/630
C25	320	17	35		30
C25	320C	17	35		30
C25	320CL	17	35		30
C25	320CXL	17	35		30
C26	321	20	30		26
C26	322	20	31		27
C26	325		51	44	
C26	330		48		42

Solid Cast Wall Stops - DuraFlex Bumpers							
Page	Part	3/605 4/606	10/612 10B/613	10BE	15/619	26/625 26D/626	
D1	400	13	14	15	13	13	
D1	401	13	14	15	13	13	
D1	402	13	14	15	13	13	
D1	403	13	14	15	13	13	
D1	404	13	14	15	13	13	
D1	405	13	14	15	13	13	
Wrought Wall Stops - DuraFlex Bumpers							
Page	Part	3/605 4/606	10/612 10B/613	15/619	26/625 26D/626	32D/630	
D2	406	8	8		7	6	
D2	409	8	8		7	6	
Solid Cast Wall Stops - DuraFlex Bumper							
Page	Part	3/605 4/606	10/612 10B/613	10BE	15/619	26/625 26D/626	
D1	412			23	20	20	
D1	415	31	31	34	30	30	
D2	416			23	20	20	
Wrought Wall Stops - DuraFlex Bumpers							
Page	Part	3/605	32D/630	10BE			
D3	426	8	6	7			
Solid Cast Wall Stop - DuraFlex Bumper							
Page	Part	3/605 4/606	10/612 10B/613	10BE	26/625 26D/626		
D3	430	10	10	11	9		
Wall Stops - DuraFlex Bumpers							
Page	Part	Gray	White				
D3	431	3					
D3	432W		3				
Light Duty Dome Stops - DuraFlex Bumper							
Page	Part		10B/613	10BE	26D/626		
D3	438		8	7	6		
D3	439		9	8	7		
Dome Stops							
Page	Part	3/605 4/606	10/612 10B/613	10BE	15/619	26/625 26D/626	
D4	440	9	10	11	8	9	
D4	441	11	12	12	9	10	
D4	441CU	13	14	15		13	
D4	441H	13	14	15	14	13	
D5	442	10	11	13	11	11	
D5	443	12	12	13	12	11	
Cast Riser (for #440 & 441 Dome Stops)							
D4	444	7	7	7		6	
Heavy Duty Door Stop							
Page	Part	3/605 4/606	10B/613 15/619	10BE	10/612	26D/626	26/625
D5	445	24	27	17	27	14	27
D5	445H	35	40	27	35	24	35
Door Stop							
D5	446	25	29	31	29	27	27
Riser (for #440 & 442 Dome Stops)							
Page	Part	Mill	Painted				
D5	449	8	8				

Curved Roller Stop - DuraFlex Bumper					
Page	Part	3/605 4/606	10/612 10B/613	10BE	26/625 26D/626
D6	455	34	34	38	33
Straight Roller Stop - DuraFlex Bumpers					
Page	Part	3/605 4/606	10/612 10B/613	10BE	26/625 26D/626
D6	456	34	34	38	33
D6	456B	4 Gray (replacement bumper)			
D6	456L	39	39	43	37
Kick Down Door Stop - DuraFlex Bumper					
Page	Part	Polished Brass (BRS)	Dull Bronze (BRZ)	Bright Chrome (CRM)	
D7	458	11	11	11	
Spring Loaded Plunger Stop - DuraFlex Bumper					
Page	Part	3/605 4/606	10/612 10B/613 15/619	10BE	26/625 26D/626
D7	459	39	42	46	40
Kick Down Door Stop - DuraFlex Bumper					
D7	460	15 ALM, BRS, BRZ, ORB			
D8	461	30	30	28	29
D8	461B	3 Gray (replacement bumper)			
D8	461L	41	40	45	39
Heavy Duty Door Stops					
Page	Part	2C/603	26D/626	32D/630	Black
D9	462	29			
D9	463			40	
D9	464		74		
D9	465		48		
D10	466				23
D10	467				29
D10	468				73
Door Stops - DuraFlex Bumpers					
Page	Part	3/605 4/606	10/612 10B/613	10BE	26/625 26D/626
D11	470	29	31	34	30
D11	471	29	31	34	30
D11	472	41	43	47	41
D11	473	41	43	47	41
D12	474	29	31	34	30
D12	475	29	31	34	30
D12	476	41	43	47	41
D12	477	41	43	47	41
D13	480	29	31	34	30
D13	480H	31	33	37	32
D13	481	35	39	43	37
D13	481H	39	41	45	39
D13	481MP	50 - Powder Coat Finish			
D14	482	30	33	37	32
D14	483	30	33	37	32
D14	485	43	49	54	47
Angle Door Stop - DuraFlex Bumper					
Page	Part	2C/603			
D15	486	12			
Heavy Duty Wall Stop - DuraFlex Bumper					
Page	Part	26D/626			
D15	487	32			

Door Stops (con't)

Door Stops					
Page	Part	3/605 4/606	10/612 10B/613	10BE	14/618 15/619
D15	488	41	45	52	45
D15	489	50	56	64	56
Door Holder & Stop					
Page	Part	26D/626			
D16	490	43			
Automatic Door Holder & Stop					
Page	Part	3/605 4/606	10/612 10B/613	10BE	26/625 26D/626
D16	491	67	73	81	70
D16	491R	72	77	85	74
D16	491S	78	82	91	79
D17	494	75	80	89	77
D17	494R	78	83	92	80
D17	494S	83	89	98	85
Door Stops - DuraFlex Bumpers					
D18	505	16	16	18	15
D18	508	26	26	28	25
D18	517	8 Polished Brass (BRS) 8 Burnished Aluminum (ALM)			
D18	518	19	19	20	18
D18	519	19	19	20	18
D18	520	3 White (replacement bumper)			
Page	Part	Antique Brass (ANT)	Polished Brass (BRS)	Bright Nickel (NP)	
D19	525	4	4	4	
D19	526		5	5	
D19	528	7	7	7	

Flush Bolts, Guides & Strikes

Page	Part	3/605 4/606	10/612 10B/613	10BE	26/625	26D/626
E1	550	40	42	45	40	40
E1	550G	6	6	6	5	5
E1	550S	6	6	6	5	5
E1	554	45	45	48	43	43
E1	554G	30	30	32	29	29
E1	554S	30	30	32	29	29
E2	555	29	31	35	31	31
E2	555B (1½" standard bolt head)		6			
E2	555B (extra long bolt head - specify length)		19			
E2	555G	5	5	5	4	4
E2	555S	5	5	5	4	4
E2	555ROD/per ft.	7	7		6	6
E2	555 x 18BFB					130
E3	556WS					79
E3	557	42	48	52	46	46
E3	557S	6	6	6	5	5
E4	557 x 19BFB					144
E4	570	23	24	26	24	24

Gravity Door Coordinators

Page	Part	3/605 4/606	10/612 10B/613	10BE	26/625 26D/626
E4	576	97	104	113	98
E4	576B	5 Gray			

Surface Bolts

Page	Part	3/605 10/612 10B/613 Painted	10BE	26D/626	32D/630
E5	580-8	31	38	34	57
E5	580-12	40	41	37	
E5	580-18	109	122	109	
E5	580-24	117	131	117	
E5	582-8				90
E5	582-12				112
Heavy Duty Surface Bolts					
E5	585-12			118	
E5	585-24			146	

Roller Latches

Page	Part	3/605 4/606	10/612 10B/613	10BE	26/625 26D/626
E6	590	44	46	49	44
E6	590DA	CALL FOR PRICING			
E6	590SO	15	15	16	14
E6	591	49	53	56	50
E6	591SO	18	18	18	16
E7	592	44	46	49	44
E7	592SO	15	15	16	14
E7	593	81	87	93	83
E7	593SO	15	15	16	14
E7	594	49	53	56	50
E7	594SO	15	15	16	14

Hospital Push/Pull Latch

Page	Part	32D/630	32DMS	10BE	Other Finishes
E8	596	230	261	253	Call
E8	596L	259	289	281	Call
E8	596S	230	261	253	Call
E8	596BS2	62			Call
E8	596BS5	64			
E8	596BS7	97			
	Engraving (set)	57			
	Lead Lining	79			
	Latchbolt Only	57			
	596STRK2 (Strike Only)	26			
	596STRK5 (Strike Only)	26			

Gate Latch

Page	Part	4/606	10/612 10B/613	10BE	26D/626
E9	602	39	39	41	37

Door Guards

Page	Part	Antique Brass (ANT)	Polished Brass (BRS)	Bright Chrome (CRM)	Dull Chrome (DCRM)
E9	603	11	11	11	11
E9	603 Shim	6 Clear Plastic			
Page	Part	3/605 4/606	10/612 10B/613	26/625	26D/626
E9	604	28	28	27	27
E9	604 Shim	6 Clear Plastic			

Door Guard Protection Plate

Page	Part	3/605 4/606	5/609	10/612 10B/613	26/625 26D/626
E9	605	10	10	11	10
E9	605SMS	10	9	11	10

Wall Guard

Page	Part	Clear
E10	606	59 - 55/sheet

Privacy Door Latch

Page	Part	BRS/DBRS	ORB	CRM, DCRM, STNN
E10	PDL (607)	45	45	43

Door Silencers

Page	Part	Clear	Gray Rubber
E10	608		16/c
E10	608CA	109 - 300/pack	
E10	609		16/c

Door Knockers

Page	Part	3/605 4/606	10/612 10B/613	10BE	26/625 26D/626
F1	611	64	64	69	62
F1	614	34	37	39	35
F1	614V	43	45	48	43

Door Viewers

Page	Part	Antique Bronze (ANT)	Polished Brass (BRS)	Bright Chrome (CRM)	Satin Nickel (STNN)
F1	619		12	12	
F1	620	10	10	10	
F1	621	11	11	11	
F2	622	12	12	12	13

Door Viewers with Covers

Page	Part	Antique Bronze (ANT)	Polished Brass (BRS)	Bright Chrome (CRM)	Dull Chrome (DCRM)
F1	620VC (10 Pack)	7	7	7	
F2	622VC (10 Pack)	8	8	7	
F1	624	13	13	13	
F2	626	17	10	17	14
F2	627			20	
F2	628			19	
F2	629			21	

Surface Bolts

Page	Part	3/605	10B/613	10BE	26D/626
E11	630-4	30	34	37	33
E11	630-8	54	59	58	52
E11	630-12	82	91	98	88
E11	630-24	155	171	185	166

Residential Flush Bolts

Page	Part	3/605	5/609	26D/626
E11	640	12	12	11
E11	640RE	12	12	11

Card Holder

Page	Part	3/605 4/606	10/612 10B/613	10BE	26D/626
F2	651	17	17	18	16

Decal

Page	Part	Price
F2	660	9
F2	661	9
F2	662	9

Available in .125" thick plastic or .050" thick metal. Pricing is per letter for Part 670—**minimum of 3 letters**; per sign for Part's 670M, 670W, 670R. Call for pricing on multi-line signs.

670 Series Engraved									
Page	Part	Black or Brown Plastic	28/628	3/605 4/606	10/612	10B/613	10BE	26/625 26D/626	32D/630
F3	670 (1"H Letters or smaller)	8	13	15	16	15	16	14	14
F3	670 (Over 1" up to 3")	12	18	19	19	19	22	18	20
F3	670M	16	29	32	33	36	39	31	35
F3	670W	18	39	43	45	45	54	41	48
F3	670R	20	57	60	61	62	79	58	71
F3	674H (PUSH)	19	24	34	35	39	41	33	37
F3	674L (PULL)	19	24	34	35	39	41	33	37

Standard 1" letter height. Grade 2 Braille translations. Available in .125" non-glare plastic or .050" thick metal. Screws provided. Pricing is per letter for Part BF680—**minimum of 3 letters**; per sign for Part's BF680M, BF680W, BF680R.

BF680 Series Barrier Free									
Page	Part	Black, Blue, Brown or Red Plastic	28/628	3/605 4/606	10/612	10BE	10BL/614	26/625 26D/626	32D/630
F4	BF680	13	25	24	24	32	26	23	29
F4	BF680M	28	63	59	60	81	61	57	72
F4	BF680W	40	92	87	89	125	91	83	112
F4	BF680R	56	134	126	129	193	134	122	173

Standard 1" letter height. Grade 2 Braille translations. Available in .125" non-glare plastic or .050" thick metal. Screws provided.

BF Series ADA Tactile									
Page	Part	Black, Blue, Brown or Red Plastic	28/628	3/605 4/606	10/612 10BL/614	10BE	26/625 26D/626	32D/630	
F5	BF683	49	155	145	145	156	140	140	
F5	BF684	49	155	145	145	156	140	140	
F5	BF685	49	155	145	145	156	140	140	
F5	BF686	58	179	168	168	182	163	163	
F5	BF687	52	167	157	157	169	151	151	
F5	BF688	52	167	157	157	169	151	151	
F5	BF689	58	179	168	168	182	163	163	

Standard 5/8" letter height. Grade 2 Braille translations. Self-adhesive mounting.

BFM Series ADA Molded Plastic			
Page	Part	Black	Blue
F6	BFM682	20	20
F6	BFM684	20	20
F6	BFM685	20	20
F6	BFM686	20	20
F6	BFM687	20	20
F6	BFM688	20	20
F6	BFM689	20	20

Auxiliary Hardware

Hand Rail Brackets - Specify Wood or Metal Rail							
Page	Part	3/605	4/606	10/612 10B/613	10BE	26D/626	
F7	700	59	67	67	70	65	
F7	701	56	63	63	66	61	
F7	702	52	59	59	61	57	
Coat Hooks							
Page	Part	3/605	4/606 10/612 10B/613 15/619	10BE	15A/620	26/625	26D/626
F8	790	11	15	13	18	15	11
F8	796	12	16	13	18	16	11
F8	802	12	18	14	19	18	12
F8	806	14	19	15	20	19	13
Ball Knob							
F9	841	11	15	12	16	11	10
Utility Pull							
Page	Part	3/605	4/606	10/612 10B/613	10BE	26/625 26D/626	Burnished Aluminum
F9	845	27	27	30	32	29	10
Wire Pulls - Specify Door Thickness							
Page	Part	3/605 4/606	10/612 10B/613	26/625 26D/626	32D/630	10BE	32DMS
F9	850	24	26	23		25	
F9	851	24	26	23		25	
F9	852	24	26	23		25	
F9	853	24	26	23	20	22	24
F9	856	27	28	26		29	
Flush Pulls							
Page	Part	3/605	10B/613	10BE	26D/626	32D/630	
F10	860	8	9	9		8	
F10	870	6	7	6		5	
F10	872	19	22	20	18		
Edge Pulls							
F11	880	17	18		17		
F11	885	41	46	48	44		
Pocket Door Pulls - For use on 1 3/8" to 1 3/4" Doors							
Page	Part	3/605	10B/613	26/625	26D/626		
F11	890	17	19	16	16		
F11	891	18	20	17	17		
Magnetic Catches							
Page	Part	Brass	Aluminum				
F12	900	10	10				
F12	901	12	12				
Adjustable Ball Catches							
Page	Part	3/605	26D/626				
F13	910	10	9				
F13	910RC	10	9				
F13	911	11	10				
F13	911RC	11	10				

Coordinators

Carry Bar for 2600 Series Coordinators					
Page	Part	Black Prime Coated	3/605 4/606	10/612 10B/613	26/625 26D/626
E13	1100	34	60	60	58
Mounting Brackets (For Soffit Applied Hardware)					
Page	Part	Black Prime Coated	28/689		
E13	2601AB	27	37		
E13	2601C	27	37		
2600 Series Coordinators w/Filler and Filler Bars					
E12	NX2648- NX2654	140	155		
E12	2655-2660	153	166		
E12	2661-2672	153	166		
E12	2673-2696	203	215		
	L2662- L26112	178	190		
E13	FB-1	27	33		
E13	FB-2	31	39		
1700 Universal Door Coordinator					
E13	1700	112	123		

Flush Bolts

Page	Part	3/605 4/606 10/612 10B/613	10BE	26/625	26D/626	32D/630
E14	2805	99	107	99	96	96
E14	2840	99	107	99	96	96
E14	2842	194	209	194	187	187
E14	2845	194	209	194	187	187
E16	2848	194	209	194	187	187
E19	2849	194	209	194	187	187
E15	2905	103	112	103	100	100
E15	2940	103	112	103	100	100
E15	2942	205	222	205	199	199
E15	2945	205	222	205	199	199
E16	2948	194	209	194	187	187
E19	2949	194	209	194	187	187
E18	2960	242	262	242	235	235
E18	2962	242	262	242	235	235
E17	BFB (wood or metal door)					99
E17	CPK2840	19	20	19	18	18

Overhead Holders & Stops

Heavy Duty Concealed - Stop Only							
Page	Part	3/605	4/606	10/612	10B/613	32D/630	32/629
D21	OH101S	431	322	322	322	302	356
D21	OH102S	431	322	322	322	302	356
D21	OH103S	431	322	322	322	302	356
D21	OH104S	431	322	322	322	302	356
D21	OH105S	431	322	322	322	302	356
D21	OH101H	431	322	322	322	302	356
D21	OH102H	431	322	322	322	302	356
D21	OH103H	431	322	322	322	302	356
D21	OH104H	431	322	322	322	302	356
D21	OH105H	431	322	322	322	302	356
Standard Duty Concealed - Multi-function							
D22	OH201M	307	205	210	182	138	244
D22	OH202M	307	205	210	182	138	244
D22	OH203M	307	205	210	182	138	244
D22	OH204M	307	205	210	182	138	244
D22	OH205M	307	205	210	182	138	244
Heavy Duty Surface Mounted - Stop Only							
D23	OH901S	448	323	323	305	269	431
D23	OH902S	448	323	323	305	269	431
D23	OH903S	448	323	323	305	269	431
D23	OH904S	448	323	323	305	269	431
D23	OH905S	448	323	323	305	269	431
D23	OH901H	516	323	323	305	269	431
D23	OH902H	516	323	323	305	269	431
D23	OH903H	516	323	323	305	269	431
D23	OH904H	516	323	323	305	269	431
D23	OH905H	516	323	323	305	269	431
Standard Duty Surface Mounted - Multi-function							
D24	OH1001M	408	267	261	216	149	281
D24	OH1002M	408	267	261	216	149	281
D24	OH1003M	408	267	261	216	149	281
D24	OH1004M	408	267	261	216	149	281
D24	OH1005M	408	267	261	216	149	281
Multi-Function Friction & Hold Open Kit							
	MFKIT					30	

Covers

Latch Guard Covers - .062" Thick (Specify Handing)						
Page	Part	3/605	10/612	10B/613	10BE	32D/630
C21	BFLG10	211	211	211	108	100
C21	BFLG12	226	226	226	113	104
C21	BFLG16	254	254	254	125	116
Vertical Rod Covers - .050" Thick						
C21	BFRC12	56	59	59	41	38
C21	BFRC24	89	95	95	58	53

Pivots

Prices are for 1¾" thick wood doors. Pivots for thicker doors are priced on application. Allow 4 weeks delivery. **NOTE:** Pivots are ¾" x 7/8" wide; HD (heavy duty) pivots are ½" x 1" wide.

Standard Head					
Page	Part	3/605 4/606	10/612 10B/613	10BE	26/625 26D/626
E23	CP10	250	274	285	265
E23	CP10HD	364	387	404	376
Standard Head Pivot					
E23	CP20	250	274	285	265
E23	CP20HD	364	387	404	376
Standard Floor					
E24	CP40	250	274	285	265
E24	CP40HD	364	387	404	376
Standard Floor Pivot					
E24	CP50	250	274	285	265
E21	CP50HD	364	387	404	376

Custom Strikes

.090" Thick (\$94.50 minimum charge. Made to your specifications.)

Page	Part	Quantity	3/605 4/606 10/612 10B/613	10BE	26/625 26D/626 32/629	32D/630	32/629
C22	CS-ASA1, CS-ASA2, CS-OM, CS-T, CS-DA	Up to 5	55	54	58	49	59
		6 to 10	51	53	54	48	55
		11 to 20	47	48	50	44	51
		21 +	45	46	47	42	48

Filler Plates & Shims

Sold in pack quantities only. Filler Plates - 25/Package; Hinge Shims - 50/Package.

Page	Part	Price Each
F14	DF86	6
F14	DFF4	4
F14	DFF5	5
F14	DHF4B	5
F15	DHF4S	5
F15	DHF5B	5
F15	DHF5S	5
F15	FBF48	5
F16	FBS48	4
F16	FC161	5
F16	FD160	5
F16	HS42	3
F17	HS44	3
F17	HS52	3

Page	Part	Price Each
F17	HS54	3
F17	LA86	11
F18	LF161	4
F18	SFASA	4
F18	SF160	4
F18	SFB160	5

Angle Plates

.050" Thick - Refer to page 13 for Angle Plate Fasteners. Add \$35 list per bend to plates price. Add \$30 list per plate for less than 5 pieces packing charge.

Page	Part	Pricing
C7	KB1150 Style A	Fax or Email Dimensions for Pricing
C7	KB1151 Style C	Fax or Email Dimensions for Pricing
C7	KB1152 Style B	Fax or Email Dimensions for Pricing

Trim Protector Bars

Heavy Duty - ¾" thick stainless for heavy traffic					
Page	Part	CTC	10BE	32D/630	
C17	HD2230	8"	102	94	
C17	HD2240		102	94	
C17	HD2250		102	94	
C17	HD2230M	Add / Inch	Call for Pricing	Call for Pricing	
C17	HD2240M				
C17	HD2250M				
Lever - ¾" thick for heavy traffic					
Page	Part	3/605	10/612 10B/613	10BE 32DMS	32D/630
C19	R101LPB	173	198	125	116
C19	R102LPB	210	259	163	151
C19	R111LPB	185	221	138	127
C19	R112LPB	221	271	187	173
C19	R115LPB	198	234	150	138
Exit Device - ¾" thick stainless for heavy traffic. Field cutting hinge end of exit device is required.					
C20	R116EDPL	406	406	288	265
C20	R116EDPH	406	406	288	265
Standard Duty - ¾" thick stainless for moderate traffic.					
C18	SD1230			51	47
C18	SD1240			51	47
C18	SD1250			51	47
C18	SD1260			51	47

PIVOTS / STRIKES / FILLER & ANGLE PLATES / PROTECTOR BARS

Door Plates Hundred Square Inch Size Chart

To calculate the list price of kick plate, use the hundred square inch number times the list price. Use the next higher even number for odd or fractional sizes. (Example: 9" x 33½" — price as 10" x 34" which is 3.40 square inches.) Take that number times the list price from the following page. (Example: 32D list \$20.00 x 3.40 = \$68.00)

H/W	24"	26"	28"	30	32"	34"	36"	38"	40"	42"	44"	46"	48"
4"	0.96	1.04	1.12	1.20	1.28	1.36	1.44	1.52	1.60	1.68	1.76	1.84	1.92
6"	1.44	1.56	1.68	1.80	1.92	2.04	2.16	2.28	2.40	2.52	2.64	2.76	2.88
8"	1.92	2.08	2.24	2.40	2.56	2.72	2.88	3.04	3.20	3.36	3.52	3.68	3.84
10"	2.40	2.60	2.80	3	3.20	3.40	3.60	3.80	4	4.20	4.40	4.60	4.80
12"	2.88	3.12	3.36	3.60	3.84	4.08	4.32	4.56	4.80	5.04	5.28	5.52	5.76
14"	3.36	3.64	3.92	4.20	4.48	4.76	5.04	5.32	5.60	5.88	6.16	6.44	6.72
16"	3.84	4.16	4.48	4.80	5.12	5.44	5.76	6.08	6.40	6.72	7.04	7.36	7.68
18"	4.32	4.68	5.04	5.40	5.76	6.12	6.48	6.84	7.20	7.56	7.92	8.28	8.64
20"	4.80	5.20	5.60	6	6.40	6.80	7.20	7.60	8	8.40	8.80	9.20	9.60
22"	5.28	5.72	6.16	6.60	7.04	7.48	7.92	8.36	8.80	9.24	9.68	10.12	10.56
24"	5.76	6.24	6.72	7.20	7.68	8.16	8.64	9.12	9.60	10.08	10.56	11.04	11.52
26"	6.24	6.76	7.28	7.80	8.32	8.84	9.36	9.88	10.40	10.92	11.44	11.96	12.48
28"	6.72	7.28	7.84	8.40	8.96	9.52	10.08	10.64	11.20	11.76	12.32	12.88	13.44
30"	7.20	7.80	8.40	9	9.60	10.20	10.80	11.40	12	12.60	13.20	13.80	14.40
32"	7.68	8.32	8.96	9.60	10.24	10.88	11.52	12.16	12.80	13.44	14.08	14.72	15.36
34"	8.16	8.84	9.52	10.20	10.88	11.56	12.24	12.92	13.60	14.28	14.96	15.64	16.32
36"	8.64	9.36	10.08	10.80	11.52	12.24	12.96	13.68	14.40	15.12	15.84	16.56	17.28
38"	9.12	9.88	10.64	11.40	12.16	12.92	13.68	14.44	15.20	15.96	16.72	17.48	18.24
40"	9.60	10.40	11.20	12	12.80	13.60	14.40	15.20	16	16.80	17.60	18.40	19.20
42"	10.08	10.92	11.76	12.60	13.44	14.28	15.12	15.96	16.80	17.64	18.48	19.32	20.16
44"	10.56	11.44	12.32	13.20	14.08	14.96	15.84	16.72	17.60	18.48	19.36	20.24	21.12
46"	11.04	11.96	12.88	13.80	14.72	15.64	16.56	17.48	18.40	19.32	20.24	21.16	22.08
48"	11.52	12.48	13.44	14.40	15.36	16.32	17.28	18.24	19.20	20.16	21.12	22.08	23.04

Options

Option	Add	12"H or Less	Over 12" - 48"H
3BE	Three Beveled Edges	5	9
4BE	Four Beveled Edges	6	11
CSK	Countersunk Holes	6	11
SA	Self-Adhesive Mount	15	33
CFC	Cut for Cylinder	36	
	Notching for Armor Plate	52	
	Cutting for Louver	113	
	Extra Row of Screws	16 per plate	
	UL Listing	16 per plate	
	TEK - Self-Drilling Screws (SS)	38/c	
	TEK - Self-Drilling Screws (Brass)	71/c	
	TORX - Security Torx Screws	65/c	

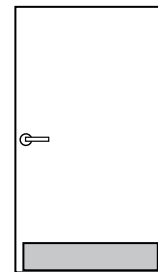

Mop Plate
Up to 8"H x 48"W

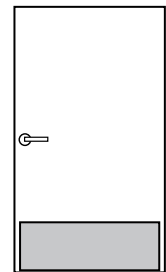

Kick Plate
6" to 12"H x 48"W

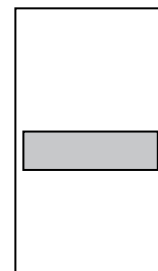

Stretcher Plate
6" to 12"H and up to 48"W

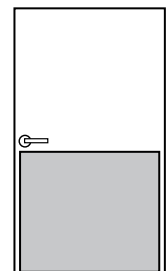

Armor Plate
Up to 48"H x 48"W

Screw Quantity Chart

Height/Length	17" - 24"	25" - 32"	33" - 40"	41" - 48"
4" - 12"	8	10	12	14
13" - 18"	10	12	14	16
19" - 24"	12	14	16	18
25" - 32"	16	18	20	22
33" - 40"	18	20	22	24
40" - 48"	20	22	24	26

NOTE: Door Plate list pricing below is per Hundred Square Inches. Refer to "Hundred Square Inch Size Chart" on page 36 to calculate the list price of each door plate and other available options. See page 13 for special kick plate fasteners.

K1038 Economy Duty Metal Door Plates - .038" Thick													
Page	Height	BRS LK/707				32D/630				3LIFETIME			
C1	Up to 16" high	15				16				38			
C1	> 16" up to 48" high	15				16				38			

K1050 & K1050F Custom Size Metal Plates - .050" Thick (UL Listed)													
See page 34 for other available options. For fire rated openings order K1050F and add \$15.75 per plate (maximum size 54"H x 46½"W). K1050F screw mounted plates are UL approved for steel fire doors and frames rated up to and including 3 hours; wood composite type fire doors rated up to 1½ hours.													
Page	Height	28/628	Powder Coat	3/605 4/606	9/611	10/612 10B/613	26/625 26D/626	32D/630	32/629	32DMS	32D316	32316	10BE
C1	Up to 8" high	13	22	43	58	49	49	22	33	26	46	60	25
C1	> 8" up to 16" high	11	16	38	53	43	43	20	31	24	43	55	23
C1	> 16" up to 36" high	11	16	43	67	53		20	31	24	43	55	23
C1	> 36" up to 48" high	11	16	49	76	60		20	31	24	43	55	23

Bulk Pack Kick Plates

Eco-Friendly Packs:

Extra packaging has been eliminated, making it faster to unpack and install, and friendlier to the environment. Packs of fasteners are included in the box.

No.	Size	Pack	Qty/Pack	Price per pack
E-8x34.32D	8" x 34"	Eco-friendly	10	443.83
E-10x34.32D	8" x 34"	Eco-friendly	10	554.88

- .050" thick brushed stainless steel kick plates
- Packaged 10 per pack with the face protected by plastic
- Part numbers are for a 10 pack. Order 1 of the part numbers to purchase 10 kick plates

Shelf Packs:

Perfect for resale! Kick plates are encased in heavy duty packing material which affords extra protection and makes it easier to remove and transport. Fasteners are conveniently attached to each package, ensuring the customer will receive the correct hardware.

No.	Size	Pack	Qty/Pack	Price per pack
S-8x34.32D	8" x 34"	Shelf Pack	10	496.13
S-10x34.32D	8" x 34"	Shelf Pack	10	620.16



K1050-1 - K1050-8 & K1050A-1 - K1050A-8 (.050" Thick) Shaped Metal Plates Add-On Chart

Add unit price below to list price for kick plate from above chart. Prices are based on same size and same shape.				
Page	Pieces	Up to 16"H 32D/630	>16" - 36"H 32D/630	>36" - 48"H 32D/630
C2-C3	1 - 10 Pieces	77	88	93
C2-C3	11 - 20 Pieces	57	68	74
C2-C3	21+ Pieces	50	61	67

To calculate Shapes™ metal plate price use the largest height x width dimension of the size required to make your design. Refer to "Hundred Square Inch Size Chart" on page 36 and the list price for 32D K1050 kick plates above. Then add the per plate charge using the appropriate row and column from the Shaped Metal Plates Add-On Chart on the left. See calculation example below.

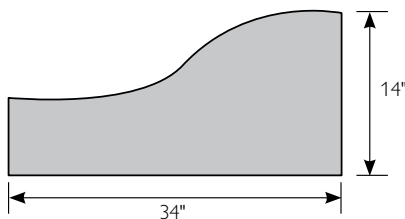

Example: 14" x 34" Per Plate Price Calculation:
4.76 (Plate size from page 36) x \$18.90 (K1050 List Price above) + \$70 (Shapes™ Add On Price) = \$159.96 each.

K1062 Heavy Duty Metal Plates - .062" Thick								
Page	Height	10BE	32D/630	32DMS				
C4	Up to 24"H	29	26	29				
C4	>24" up to 36"H	29	26	29				
C4	>36" up to 48"H		26	29				
K1125 Extra Heavy Duty Metal Plates - .125" Thick								
Page	Height	28/628	3/605 4/606	9/611	10/612 10B/613	10BE	32D/630	ALM DIA
C4	Up to 48"H	35	125	146	136	72	65	35
K2060 Heavy Duty Plastic Plates - .060" Thick								
Page	Part	Beige #72005	Calcutta Black #52000	Chocolate Brown #72010	Pewter Gray #52001			
C5	K2060 Up to 48"H	13	13	13	13			
C5	K2060SA Up to 48"H	17	17	17	17			
C5	K2060SA-F	UL approved for use on 90-minute wood doors and 3-hour metal doors; order K2060SA-F. Add \$15 additional per plate. Maximum size for UL label is 48"H x 42"W.						
K2125 Extra Heavy Duty Plastic Plates - .125" Thick								
C5	Up to 48"H	19	19	19	19			
K3125 Laminate Plastic Plates - .125" Thick								
Page	Height	Beige	Black	Brown	Pewter Gray	White		
C6	Up to 48"H	11	11	11	11	11		
K4125 Clear Plastic Plates - .125" Thick								
Page	Height	Clear						
C6	Up to 48"H	11						

Price List

Architectural Door Pulls

1-800-458-2424
www.rockwoodmfg.com

ROCKWOOD®
ASSA ABLOY

Prices Effective January 1, 2015

It is our goal that you get the best possible functional and aesthetic door pull from our wide selection. On long door pulls there will naturally be a small amount of flexing between mounting points that are far apart. We offer the following guidelines to help you determine when a mid-post is required or when you should consider altering the location of the mounting posts (by moving them closer together) in order to minimize the flexing of the grip. Making the grip rigid by adding a mid-post is the ideal condition for long pulls on all doors but is particularly important on all glass doors that have an inherent flexing in the door itself. The combined flexing of the door and the pull can loosen mechanical joints and stress the fasteners. Our recommendations for adding a mid-post to long door pulls is based on a theoretical pull load of 30 lbs. (foot pounds) maximum to open the door, which is a greater than the typical force required to open an average door. The maximum amount of deflection of the grip you will see at that force is 3/8". The conditions on your job site can vary due to door weight, wind loading, closer settings, locked doors being aggressively pulled and other circumstances. It is our recommendation that you add a mid-post if there is any question about heavy or hard to open doors; having an extra mounting point always makes for a more stable and durable installation.

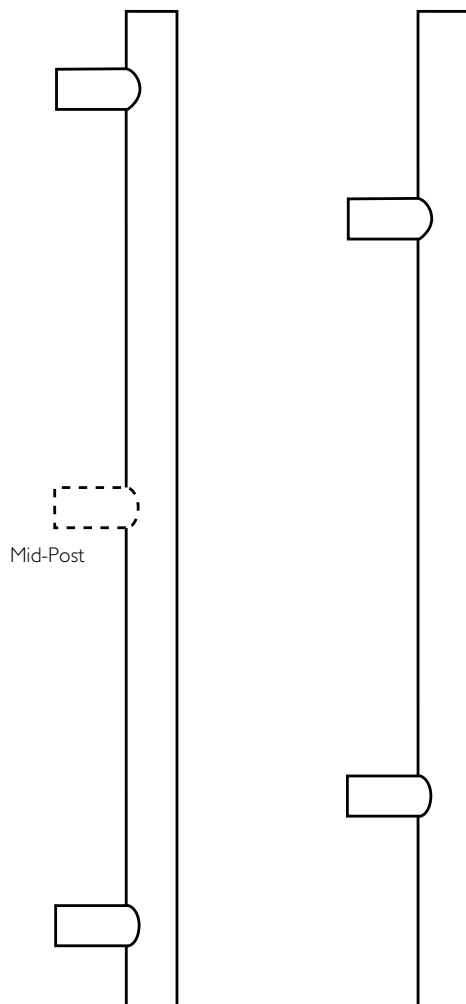

POST MOUNTED PULLS SHAPES AND SIZES			
SHAPE	MATERIAL	MATERIAL SIZE	MAXIMUM CTC
ROUND			
	Stainless Steel	1"	70"
		1 1/4"	90"
		1 1/2"	110"
	Brass/Bronze	1"	57"
		1 1/4"	73"
		1 1/2"	87"
Aluminum	1"	66"*	
	1 1/4"	90"*	
	1 1/2"	115"*	
OVAL			
	Stainless Steel	1" x 1 1/2"	100"
		1" x 1 7/8"	119"
FLAT OVAL			
	Stainless Steel	3/4" x 1 1/2"	93"
SQUARE			
	Stainless Steel	3/4" x 3/4"	62"
RECTANGULAR			
	Stainless Steel	1/2" x 1 1/4"	86"
		3/4" x 1 1/2"	110"
	Brass/Bronze	3/4" x 1 1/2"	89"
RECTANGULAR			
	Stainless Steel	1/2" x 1 1/4"	52"
		3/4" x 1 1/2"	75"
	Brass/Bronze	3/4" x 1 1/2"	60"

On long pulls, post can be positioned closer to each other and farther away from ends as a strategy to avoid mid-post if door condition permits.

*The maximum length of anodized aluminum pulls is 87" due to our tank size. Longer aluminum pulls are available in satin finish and clear coated or powder coat paint.

Tubular - 1¼" & 1½" Diameter Pulls

Straight Pulls												
Part	CTC	Dia.	28/628	313/710 315/711	3/605 4/606	10/612 10B/613	10BE	32D/630	32/629	32D316	32316	
RM301	12"	1¼"	84	95	173	192	161	125	140	153	165	
RM302	18"	1¼"	89	101	198	216	180	136	151	165	176	
RM303	24"	1¼"	101	113	229	241	201	146	163	176	188	
RM304	36"	1¼"	164	176	253	266	222	168	185	206	218	
RM321	12"	1½"	120	133	210	216	180	141	163			
RM322	18"	1½"	139	151	229	234	196	163	185			
RM323	24"	1½"	158	171	253	259	216	184	201			
RM324	36"	1½"	188	208	295	309	258	206	235			
90° Offset Pulls												
RM201	12"	1¼"	127	145	221	234	196	146	179	176	206	
RM202	18"	1¼"	139	158	246	259	216	163	196	195	224	
RM203	24"	1¼"	151	171	271	284	237	179	212	218	247	
RM204	36"	1¼"	176	196	326	339	283	201	235	241	271	
RM221	12"	1½"	164	176	266	284	237	168	212			
RM222	18"	1½"	176	188	295	309	258	190	235			
RM223	24"	1½"	188	201	333	345	288	211	258			
RM224	36"	1½"	213	226	393	406	339	238	285			
Push Bars - Add \$5.25 per inch per bar for extra length bars over 36".												
RM350	specify	1¼"	164	183	246	259	216	168	185	206	218	
RM370	specify	1½"	188	208	295	309	258	206	235			
Straight Push Pull Sets - Specify Push Bar CTC. Add \$5.25 per inch per bar for extra length bars over 36".												
RM351	12"	1¼"	260	292	433	463	387	306	338	372	396	
RM352	18"	1¼"	267	297	458	488	407	316	348	384	408	
RM371	12"	1½"	322	354	521	537	448	359	410			
RM372	18"	1½"	342	372	537	555	463	381	433			
Offset Push Pull Sets - Specify Push Bar CTC. Add \$5.25 per inch per bar for extra length bars over 36".												
RM251	12"	1¼"	305	342	482	507	423	328	376	396	437	
RM252	18"	1¼"	317	354	507	531	443	343	393	413	454	
RM271	12"	1½"	366	397	575	605	504	386	459			
RM272	18"	1½"	380	410	605	629	524	408	482			
Heavy Duty 30° Offset Pulls												
Part	CTC	Dia.	28/628	313/710 315/711	3/605 4/606	10/612 10B/613	10BE	26/625 26D/626	32D/630	32/629	32D316	32316
RM257	10"	1¼"	131	142	317	364	251	308	214	274	261	290
RM258	12"	1¼"	142	155	341	387	273	331	233	293	278	309
RM259	18"	1¼"	147	162	387	445	301	376	257	318	303	334
NOTE: Engraving "Push" or "Pull" add \$94.50 (½" letter height).												

RightAngles - with or without GripZone

Without GripZone (RM410-RM413 specify handing and height x width when ordering.)									
Part	28/628	313/710 315/711	3/605 4/606	10/612 10B/613	10BE	32D/630	32/629	32D316	32316
RM405-15	153	173	251	264	216	173	198	201	227
RM410 (leg up)	317	364	537	584	478	391	428	450	497
RM411 (leg down)	317	364	537	584	478	391	428	450	497
RM412 (leg up)	537	615	606	804	658	501	575	589	665
RM413 (leg down)	537	615	606	804	658	501	575	589	665
With GripZone (RM420-RM423 specify handing and height x width when ordering.)									
Part	3/605	9/611	32/629	32316					
RM415-15	345	399	299	319					
RM420 (leg up)	678	777	584	633					
RM421 (leg down)	678	777	584	633					
RM422 (leg up)	877	1008	746	811					
RM423 (leg down)	877	1008	746	811					

Small Pulls - for Cabinets, Casework and Closets

Wire Pulls - without base plates							
Part	Dia.	3/605 4/606	10B/613	10BE	26/625 26D/626	32D/630	32/629
RM710-4	3/8"	27	29	27	27	19	25
RM710-5	3/8"	28	30	28	28	20	26
RM710-6	3/8"	29	31	29	30	21	27
RM720-4	1/2"	32	33	32	32	21	27
RM720-5	1/2"	33	34	33	33	22	28
RM720-6	1/2"	34	36	34	34	24	29
RM730-5	5/8"	38	42	38	38	24	31
RM730-6	5/8"	39	43	39	39	25	32
RM730-7	5/8"	40	44	40	40	26	33
Wire Pulls - with base plates							
RM715-4	3/8"	42	44	42	42	34	40
RM715-5	3/8"	43	46	43	43	36	41
RM715-6	3/8"	44	47	44	46	37	42
RM725-4	1/2"	50	51	50	50	38	43
RM725-5	1/2"	51	52	51	51	39	44
RM725-6	1/2"	52	53	52	52	40	46
RM735-5	5/8"	55	59	55	55	40	48
RM735-6	5/8"	56	60	56	56	41	49
RM735-7	5/8"	57	61	57	57	42	50

Flush Pulls					
Part	Size	3/605 4/606	10B/613	10BE	26/625 26D/626
RM780	2 3/16" x 3 1/4"	30	31	30	31
RM782	2 1 1/16" x 4 3/16"	31	33	32	33
RM785	3 1/2" Dia.	40	42	42	42

Edge Pulls - for Closet Doors

Square Edge Door						
Part	3/605 4/606	10/612 10B/613	10BE	32D/630	32/629	
RM751	73	79	72	61	68	
RM752	75	81	73	63	71	
Bevel Edge Door						
RM753	77	83	75	65	73	
RM754	79	85	77	68	75	

Double Edge Pull - Square Edge						
Part	3/605 4/606	10/612 10B/613	10BE	32D/630	32/629	
RM755	143	156	141	122	135	
Concealed Edge Pull						
Part	Size	3/605 4/606	10/612 10B/613	10BE	26/625 26D/626	
RM760	1" x 4¼"	39	44	40	42	

Specifying Information

1. Select style pull number;
2. Select standard length [2", 2½", 3", 4", 5", 6", 12" (max)];
3. Specify door thickness
[Example: RM752-4" 32D 1¾" door]

Coat Hooks

Part	Size	3/605 4/606	10B/613	10BE	26/625 26D/626	32D/630
RM801	1¼" x 1¾"	45	48	44	48	39
RM802	1¼" x 2¾"	46	49	45	49	41
RM803	1" x 2"	45	48	44	48	
RM804	1" x 3"	46	49	45	49	
RM805	1" x 1¾"	57	61	55	61	
RM806	1" x 3"	61	67	59	67	
RM807	1¼" x 2¼"	69	74	67	74	
RM808	1¼" x 3½"	74	79	72	79	
RM809	1¾" x 1¾"	36	36	35	36	
RM810	1¾" x 2¾"	37	37	36	37	
RM811	¾" x 1½"	30	30	29	30	
RM812	1¼" x 2¼"	32	32	31	32	
Part	Size					15/619
RM817	Square 1¾", 2¼" Projection					41
Part	Size	3/605 4/606 10B/613	10BE	26/625 26D/626	32D/630	
RM820	½" x 1½"		38		30	
RM821	⅝" x 2½"		39		31	
RM822	½" x 1½"		28		21	
RM823	⅝" x 2"		29		22	
RM824	1" x 1½"	61	61	61		

Part	Size	3/605 4/606 10B/613	10BE	26/625 26D/626	32D/630	32/629
RM825	1¾" x 2½"	95	92	95		
RM826	1" x 1½"	122	118	122		
RM827	1¾" x 3½"	184	179	184		
RM828	¾" w x 2½"	53	46		39	53
RM829	¾" w x 1½"	49	44		36	49

LineaMet Coat Hooks

Part	Size	10BE	32D/630	32/629
RM830 (w/ base plate)	1¼" x 2¼"	53	46	49
RM831	⅝" x 2½"	53	46	49

ArborMet Coat Hooks

RM835 (w/ base plate)	1¼" x 2¼"	53	46	49
RM836	⅝" x 2½"	53	46	49

SoftMet Coat Hooks

RM838 (w/ base plate)	1¼" x 2¼"	53	46	49
RM839	⅝" x 2½"	53	46	49

Groove Coat Hooks

RM840 (w/ base plate)	½" x 1½"	43	36	
RM841 (w/ base plate)	⅝" x 2½"	45	38	
RM842	½" x 1½"	37	30	
RM843	⅝" x 2"	39	32	

Door Stops

Floor Mounted						
Part	Projection	3/605 4/606	10/612 10B/613	10BE	26/625 26D/626	32D/630
RM850	1½"	25	29	27	27	30
RM851	2½"	35	40	39	38	39
RM855	1¾"	30	33	32	31	34
RM856	2¾"	40	43	42	41	42
Part	Size					15/619
RM857	Square 1" Base, 2¾" Projection					49
Wall Mounted						
RM860	1½"	19	20	19	18	18
RM861	1¾"	19	20	19	18	18
Part	Size					15/619
RM867	Square 1¾" Base, ¾" Projection					42

Base Board Mounted						
Part	Projection	3/605 4/606	10/612 10B/613	10BE	26/625 26D/626	32D/630
RM870	1½"	27	27	24	25	20
RM871	3¼"	27	27	24	25	20
RM872	3¾"	27	27	24	25	20
RM875	1½"	39	39	35	37	31
RM876	3¼"	39	39	35	37	31
RM877	3¾"	39	39	35	37	31

Push Plates, Pull Plates and Signage

Square Corner - Adhesive Mount						
Part	Size	3/605 4/606	10/612 10B/613	10BE	32D/630	32/629
RM1010	4" x 22"				46	56
RM1010H	4" x 22"				69	80
RM1010L	4" x 22"				69	80
Square Corner - Screw Mount						
RM1020	4" x 22"	66	68	57	34	44
RM1020H	4" x 22"	92	94	79	58	67
RM1020L	4" x 22"	92	94	79	58	67
Radius End Corner - Adhesive Mount						
RM1030	4" x 22"				58	67
RM1030H	4" x 22"				82	91
RM1030L	4" x 22"				82	91
Radius End Corner - Screw Mount						
RM1040	4" x 22"	80	82	69	46	56
RM1040H	4" x 22"	105	107	90	69	80
RM1040L	4" x 22"	105	107	90	69	80

Indicator Plates - Adhesive Mount					
Part	Size	3/605 4/606	10/612 10B/613	32D/630	32/629
RM1110H	1" Dia.	54	63	49	54
RM1110L	1" Dia.	54	63	49	54
RM1120H	2½" Dia.	54	63	49	54
RM1120L	2½" Dia.	54	63	49	54
RM1150M	2" x 4"	58	68	54	58
RM1150W	2" x 5¾"	60	70	56	61
Indicator Plates - Screw Mount					
RM1160M	2" x 4"	58	68	54	58
RM1160W	2" x 5¾"	60	70	56	61

Small PostMount Pulls - for Cabinets, Casework & Closet Doors

Straight - Square Ends						
Part	Dia.	3/605 4/606	10B/613	32D/630	32/629	10BE 32DMS
RM1200-4	½"	43	46	20	23	30
RM1200-5	½"	43	46	21	25	31
RM1200-6	½"	43	46	30	35	38
RM1200-8	½"	46	53	33	38	41
RM1200-10	½"	49	55	36	40	45
RM1200-12	½"	55	59	39	45	50
RM1200-18	½"	73	84	42	50	56
RM1200-24	½"	84	97	50	56	62
RM1200-30	½"	100	111	58	65	73
RM1210-5	⅝"	55	57	30	32	38
RM1210-6	⅝"	55	57	32	34	40
RM1210-7	⅝"	57	59	37	42	47
RM1210-8	⅝"	59	61	39	45	50
RM1210-10	⅝"	65	68	40	48	51
RM1210-12	⅝"	71	76	42	50	53
RM1210-18	⅝"	97	102	54	60	67
RM1210-24	⅝"	111	116	62	70	77
RM1210-30	⅝"	133	140	67	78	81

Groove - Small Postmount Pulls

Straight - Square Ends						
Part	Dia.	3/605 4/606	10/612 10B/613	32D/630	32/629	10BE 32DMS
RM1211-5	⅝"	65	68	46	51	56
RM1211-6	⅝"	65	68	46	51	56
RM1211-7	⅝"	65	68	46	51	56
RM1211-8	⅝"	68	71	48	53	56
RM1211-10	⅝"	75	77	49	55	57
RM1211-12	⅝"	79	83	51	57	59
Offset - Square Ends						
RM1230-5	⅝"	84	87	63	69	75
RM1230-6	⅝"	84	87	63	69	75
RM1230-7	⅝"	87	90	66	72	77
RM1230-8	⅝"	90	92	69	74	79
RM1230-10	⅝"	97	100	70	76	80
RM1230-12	⅝"	102	106	72	78	82
RM1230-18	⅝"	128	133	82	89	98
RM1230-24	⅝"	142	147	92	98	107
RM1230-30	⅝"	164	171	96	107	111
Straight - Round Ends						
RM1240-4	½"	55	57	38	44	48
RM1240-5	½"	55	57	38	44	48
RM1240-6	½"	55	57	38	44	48
RM1240-8	½"	57	61	41	48	52
RM1240-10	½"	59	63	45	50	55
RM1240-12	½"	63	68	49	54	58
RM1240-18	½"	82	95	52	58	65
RM1240-24	½"	95	106	58	65	73
RM1240-30	½"	108	121	67	74	81

Small PostMount Pulls (con't)

Straight - Round Ends						
Part	Dia.	3/605 4/606	10B/613	32D/630	32/629	10BE 32DMS
RM1250-5	5/8"	63	65	47	52	56
RM1250-6	5/8"	63	65	47	52	56
RM1250-7	5/8"	65	68	47	52	56
RM1250-8	5/8"	68	71	49	54	58
RM1250-10	5/8"	76	78	50	56	59
RM1250-12	5/8"	80	84	52	58	61
RM1250-18	5/8"	106	111	62	70	77
RM1250-24	5/8"	121	126	72	78	86
RM1250-30	5/8"	142	149	76	87	91

Offset - Round Ends						
Part	Dia.	3/605 4/606	10B/613	32D/630	32/629	10BE 32DMS
RM1270-5	5/8"	95	97	73	77	83
RM1270-6	5/8"	95	97	73	77	83
RM1270-7	5/8"	97	100	75	80	86
RM1270-8	5/8"	100	102	77	82	88
RM1270-10	5/8"	106	108	78	84	89
RM1270-12	5/8"	111	116	80	87	92
RM1270-18	5/8"	137	142	92	98	107
RM1270-24	5/8"	151	157	100	107	116
RM1270-30	5/8"	173	180	104	116	121

GripZone - Small PostMount Pulls - for Cabinets, Casework & Closet Doors

Straight - Square Ends		
Part	Dia.	32/629
RM1300-4	1/2"	51
RM1300-5	1/2"	51
RM1300-6	1/2"	51
RM1300-8	1/2"	54
RM1300-10	1/2"	56
RM1300-12	1/2"	60
RM1300-18	1/2"	64
RM1300-24	1/2"	73
RM1300-30	1/2"	81
Straight - Square Ends		
RM1310-5	5/8"	58
RM1310-6	5/8"	58
RM1310-7	5/8"	58
RM1310-8	5/8"	60
RM1310-10	5/8"	62
RM1310-12	5/8"	64
RM1310-18	5/8"	77
RM1310-24	5/8"	85
RM1310-30	5/8"	95

Offset - Square Ends		
Part	Dia.	32/629
RM1330-5	5/8"	84
RM1330-6	5/8"	84
RM1330-7	5/8"	87
RM1330-8	5/8"	90
RM1330-10	5/8"	92
RM1330-12	5/8"	95
RM1330-18	5/8"	106
RM1330-24	5/8"	115
RM1330-30	5/8"	124
Straight - Round Ends		
RM1340-4	1/2"	59
RM1340-5	1/2"	59
RM1340-6	1/2"	59
RM1340-8	1/2"	62
RM1340-10	1/2"	64
RM1340-12	1/2"	70
RM1340-18	1/2"	75
RM1340-24	1/2"	81
RM1340-30	1/2"	90

Straight - Round Ends		
Part	Dia.	32/629
RM1350-5	5/8"	67
RM1350-6	5/8"	67
RM1350-7	5/8"	67
RM1350-8	5/8"	70
RM1350-10	5/8"	73
RM1350-12	5/8"	75
RM1350-18	5/8"	85
RM1350-24	5/8"	95
RM1350-30	5/8"	103
Offset - Round Ends		
RM1370-5	5/8"	94
RM1370-6	5/8"	94
RM1370-7	5/8"	97
RM1370-8	5/8"	99
RM1370-10	5/8"	101
RM1370-12	5/8"	103
RM1370-18	5/8"	115
RM1370-24	5/8"	124
RM1370-30	5/8"	133

NoirMet - Small PostMount Pulls

Straight - Square Ends						
Part	Dia.	3/605 4/606	10B/613	10BE	32D/630	32/629
RM1410-5	5/8"	91	91	69	55	57
RM1410-6	5/8"	94	94	71	57	59
Offset - Square Ends						
RM1430-5	5/8"	128	128	99	88	90
RM1430-6	5/8"	131	131	101	90	94
Straight - Round Ends						
RM1450-5	5/8"	108	108	81	69	72
RM1450-6	5/8"	110	110	83	72	75
Offset - Round Ends						
RM1470-5	5/8"	145	145	114	103	107
RM1470-6	5/8"	148	148	115	107	109

ArborMet - Small PostMount Pulls

Straight - Square Ends						
Part	Dia.	3/605 4/606	10B/613	10BE	32D/630	32/629
RM1510-5	5/8"	96	96	72	59	62
RM1510-6	5/8"	98	98	74	62	64
Offset - Square Ends						
RM1530-5	5/8"	134	134	103	94	96
RM1530-6	5/8"	137	137	105	96	99
Straight - Round Ends						
RM1550-5	5/8"	113	113	85	75	78
RM1550-6	5/8"	116	116	88	78	81
Offset - Round Ends						
RM1570-5	5/8"	150	150	106	109	111
RM1570-6	5/8"	152	152	118	111	113

MegaCurve - Long Curved Pulls

Mid Bow								
Part	Size	3/605 4/606	10/612 10B/613	10BE	32D/630	32/629	32D316	32316
RM2000	6' - 8'	1169	1169	877	841	910	1134	1204
RM2004	6' - 8'	1242	1242	932	910	980		
Long Bow Pulls								
RM2010	6' - 8'	1532	1532	1,379	1190	1260	1609	1679
RM2014	6' - 8'	1606	1606	1,445	1260	1331		
45° Pulls								
RM2020	6' - 8'	1242	1242	1,118	910	980	1232	1302
RM2024	6' - 8'	1315	1315	1,184	980	1050		
Triangle Pulls								
RM2030	6' - 8'	1242	1242	1,118	910	980	1232	1302
RM2034	6' - 8'	1315	1315	1,184	980	1050		

Add \$63/Ft. over 8'.

IberMet - Cork Small PostMount Pulls

Natural Cork Straight - Square End						
Part	Dia.	3/605 4/606	10B/613	10BE	32D/630	32/629
RM1610N-5	5/8"	137	137	123	103	107
RM1610N-6	5/8"	139	139	125	107	109
Natural Cork Offset - Square Ends						
RM1630N-5	5/8"	174	174	157	138	140
RM1630N-6	5/8"	176	176	158	140	143
Natural Cork Straight - Round Ends						
RM1650N-5	5/8"	152	152	137	120	123
RM1650N-6	5/8"	156	156	140	123	125
Natural Cork Offset - Round Ends						
RM1670N-5	5/8"	191	191	172	154	157
RM1670N-6	5/8"	193	193	174	157	160
Rubber Cork Straight - Square Ends						
RM1610R-5	5/8"	121	121	103	84	86
RM1610R-6	5/8"	124	124	105	86	88
Rubber Cork Offset - Square Ends						
RM1630R-5	5/8"	160	160	134	118	120
RM1630R-6	5/8"	162	162	136	120	123
Rubber Cork Straight - Round Ends						
RM1650R-5	5/8"	139	139	126	99	101
RM1650R-6	5/8"	143	143	129	101	103
Rubber Cork Offset - Round Ends						
RM1670R-5	5/8"	176	176	157	133	135
RM1670R-6	5/8"	179	179	160	135	138

MezzoTek - Necked Post Pulls

Straight Pulls without GripZone								
Part	Dia.	3/605 4/606	10/612 10B/613	10BE	32D/630	32/629	32D316	32316
RM2110-8	1¼"	322	322	264	188	199	312	324
RM2110-11	1¼"	336	336	275	188	199	312	324
RM2110-16	1¼"	336	336	275	188	199	312	324
RM2110 (3'-4')	1¼"	508	508	416	321	343	488	513
RM2110 (4'-6')	1¼"	564	564	462	343	365	530	555
RM2110 (6'-8')	1¼"	724	724	593	409	453	634	682
RM2120-11	1½"	376	388	318	199	221		
RM2120-16	1½"	388	403	330	210	221		
RM2120-20	1½"	403	416	341	210	233		
RM2120 (3'-4')	1½"	523	523	428	331	353		
RM2120 (4'-6')	1½"	617	617	505	365	397		
RM2120 (6'-8')	1½"	777	777	636	431	497		
Push Bars without GripZone (specify handing)								
RM2112	1¼"	443	443	363	268	291		
RM2122	1½"	482	482	395	291	314		
Push Pull Sets without GripZone (specify handing)								
RM2115	1¼"	791	791	648	453	486		
RM2125	1½"	884	897	734	497	530		
Straight Pulls with GripZone								
Part	Dia.	3/605	9/611	32/629	32316			
RM2130-8	1¼"	356	388	227	353			
RM2130-11	1¼"	370	403	227	353			
RM2130-16	1¼"	370	403	227	353			
RM2130 (3'-4')	1¼"	576	644	397	573			
RM2130 (4'-6')	1¼"	630	697	419	615			
RM2130 (6'-8')	1¼"	791	858	508	743			
RM2140-11	1½"	409	455	249				
RM2140-16	1½"	424	470	249				
RM2140-20	1½"	436	482	260				
RM2140 (3'-4')	1½"	591	658	409				
RM2140 (4'-6')	1½"	684	750	453				
RM2140 (6'-8')	1½"	844	911	552				
Push Bars with GripZone (specify handing)								
RM2132	1¼"	476	508	304				
RM2142	1½"	517	550	326				

- Add \$63/Ft. over 8'.
- MP (Mid Post) - Add \$63 each (Recommended for maximum rigidity on long door pulls. See page 40 for guidelines.)

BandWidth - Collar Mount Pulls

Straight Pulls - Square Ends						
Part	Dia.	3/605 4/606	10/612 10B/613	10BE	32D/630	32/629
RM2200-8	1"	388	388	318	252	289
RM2200-10	1"	388	388	318	252	289
RM2200-12	1"	403	403	330	265	301
RM2200 (3'-4')	1"	591	591	484	401	450
RM2200 (4'-6')	1"	658	658	539	440	489
RM2200 (6'-8')	1"	831	831	680	501	577
RM2210-8	1¼"	416	416	341	265	301
RM2210-11	1¼"	429	429	351	265	301
RM2210-16	1¼"	429	429	351	265	301
RM2210 (3'-4')	1¼"	604	604	495	415	464
RM2210 (4'-6')	1¼"	658	658	539	440	489
RM2210 (6'-8')	1¼"	844	844	691	514	589
Offset Pulls - Square Ends						
RM2230-8	1"	424	455	373	283	321
RM2230-10	1"	424	455	373	283	321
RM2230-12	1"	436	470	385	295	333
RM2230 (3'-4')	1"	623	658	539	434	484
RM2230 (4'-6')	1"	690	724	593	470	519
RM2230 (6'-8')	1"	865	897	734	534	608
RM2240-8	1¼"	450	482	395	295	333
RM2240-11	1¼"	464	496	406	295	333
RM2240-16	1¼"	464	496	406	295	333
RM2240 (3'-4')	1¼"	637	670	549	445	495
RM2240 (4'-6')	1¼"	690	724	593	470	519
RM2240 (6'-8')	1¼"	878	911	746	544	620
Straight Pulls - Round Ends						
RM2204-8	1"	464	464	380	289	326
RM2204-10	1"	464	464	380	289	326
RM2204-12	1"	476	476	390	301	339
RM2204 (3'-4')	1"	663	663	543	440	489
RM2204 (4'-6')	1"	730	730	598	475	527
RM2204 (6'-8')	1"	905	905	741	539	615
RM2214-8	1¼"	491	491	402	301	339
RM2214-11	1¼"	503	503	412	301	339
RM2214-16	1¼"	503	503	412	301	339
RM2214 (3'-4')	1¼"	677	677	554	450	501
RM2214 (4'-6')	1¼"	730	730	598	475	527
RM2214 (6'-8')	1¼"	917	917	751	552	626

Offset Pulls - Round Ends						
Part	Dia.	3/605 4/606	10/612 10B/613	10BE	32D/630	32/629
RM2234-8	1"	496	529	433	321	357
RM2234-10	1"	496	529	433	321	357
RM2234-12	1"	508	543	445	333	370
RM2234 (3'-4')	1"	697	730	598	470	519
RM2234 (4'-6')	1"	765	796	652	509	558
RM2234 (6'-8')	1"	937	970	794	570	646
RM2244-8	1¼"	523	557	456	333	370
RM2244-11	1¼"	537	570	467	333	370
RM2244-16	1¼"	537	570	467	333	370
RM2244 (3'-4')	1¼"	711	744	609	484	534
RM2244 (4'-6')	1¼"	765	796	652	509	558
RM2244 (6'-8')	1¼"	952	985	806	583	658
Push Bars - Square Ends						
RM2202	1"	496	496	406	314	365
RM2212	1¼"	537	537	440	339	390
Push Bars - Round Ends						
RM2206	1"	570	570	467	351	401
RM2216	1¼"	611	611	500	376	426

- Add \$63/Ft. over 8'.
- MP (Mid Post) - Add \$94.50 each (Recommended for maximum rigidity on long door pulls. See page 40 for guidelines.)
- Specify finish of grip and collar.

OvalTek - True Oval Grip

Straight Pulls				
Part	Size	10BE	32D/630	32/629
RM2300-8	1" x 1½"	320	278	303
RM2300-11	1" x 1½"	320	278	316
RM2300-16	1" x 1½"	335	291	329
RM2300 (3'-4')	1" x 1½"	469	408	447
RM2300 (4'-6')	1" x 1½"	560	487	513
RM2300 (6'-8')	1" x 1½"	682	593	672
Offset Pulls				
RM2320-8	1" x 1½"	352	306	330
RM2320-11	1" x 1½"	359	312	343
RM2320-16	1" x 1½"	366	318	355
RM2320 (3'-4')	1" x 1½"	496	431	468
RM2320 (4'-6')	1" x 1½"	583	507	531
RM2320 (6'-8')	1" x 1½"	697	606	680
Straight Pulls				
RM2310-11	1" x 1⅞"	335	291	329
RM2310-16	1" x 1⅞"	363	316	343
RM2310-20	1" x 1⅞"	378	329	355
RM2310 (3'-4')	1" x 1⅞"	500	435	473
RM2310 (4'-6')	1" x 1⅞"	606	527	554
RM2310 (6'-8')	1" x 1⅞"	743	646	724
Offset Pulls				
RM2330-11	1" x 1⅞"	366	318	355
RM2330-16	1" x 1⅞"	394	343	368
RM2330-20	1" x 1⅞"	408	355	380
RM2330 (3'-4')	1" x 1⅞"	526	457	492
RM2330 (4'-6')	1" x 1⅞"	623	542	567
RM2330 (6'-8')	1" x 1⅞"	754	656	731
Push Bars				
RM2302	1" x 1½"	560	461	487
RM2312	1" x 1⅞"	544	473	513
Push Pull Sets				
RM2305	1" x 1½"	937	751	815
RM2315	1" x 1⅞"	922	802	868

OvalTek - Flat Oval Grip

Straight Pulls - Small Round Posts				
Part	Size	10BE	32D/630	32/629
RM2400-8	¾" x 1½"	363	316	343
RM2400-11	¾" x 1½"	378	329	369
RM2400-16	¾" x 1½"	394	343	381
RM2400 (3'-4')	¾" x 1½"	560	487	527
RM2400 (4'-6')	¾" x 1½"	651	566	619
RM2400 (6'-8')	¾" x 1½"	848	737	802
Straight Pulls - Large Round Posts				
RM2410-8	¾" x 1½"	394	343	369
RM2410-11	¾" x 1½"	408	355	395
RM2410-16	¾" x 1½"	424	369	408
RM2410 (3'-4')	¾" x 1½"	590	513	554
RM2410 (4'-6')	¾" x 1½"	682	593	646
RM2410 (6'-8')	¾" x 1½"	876	762	828
Straight Pulls - Oblong Posts				
RM2420-8	¾" x 1½"	514	447	473
RM2420-11	¾" x 1½"	530	461	499
RM2420-16	¾" x 1½"	544	473	513
RM2420 (3'-4')	¾" x 1½"	712	619	658
RM2420 (4'-6')	¾" x 1½"	803	698	751
RM2420 (6'-8')	¾" x 1½"	998	868	934
Push Bar - Large Round Posts				
RM2402	¾" x 1½"	651	566	580

- RM2310 & RM2410 pulls add \$63/Ft. over 8'.
- MP (Mid Post) - Add \$63 each (Recommended for maximum rigidity on long door pulls. See page 40 for guidelines.)

SoftMet - Santoprene™ Grip

Straight Pulls - Square Ends						
Part	Dia.	3/605 4/606	10/612 10B/613	10BE	32D/630	32/629
RM2510-8	1¼"	296	309	289	251	264
RM2510-11	1¼"	309	323	304	264	277
RM2510-16	1¼"	335	349	327	284	297
RM2510 (up to 3')	1¼"	469	482	469	408	421
Offset Pulls - Square Ends						
RM2540-8	1¼"	329	375	327	284	297
RM2540-11	1¼"	343	389	342	297	310
RM2540-16	1¼"	370	416	365	317	329
RM2540 (up to 3')	1¼"	503	550	507	441	455
Straight Pulls - Round Ends						
RM2514-8	1¼"	329	343	327	284	297
RM2514-11	1¼"	343	356	342	297	310
RM2514-16	1¼"	370	382	365	317	329
RM2514 (up to 3')	1¼"	503	516	507	441	455

Offset Pulls - Round Ends						
Part	Dia.	3/605 4/606	10/612 10B/613	10BE	32D/630	32/629
RM2544-8	1¼"	362	409	365	317	329
RM2544-11	1¼"	375	422	378	329	343
RM2544-16	1¼"	402	449	403	350	363
RM2544 (up to 3')	1¼"	535	582	544	473	486
Push Bars						
RM2512	Sq. End	482	495	483	420	434
RM2516	Rd. End	516	529	522	454	467
Straight Push Pull Sets						
RM2515	Sq. End	803	830	802	697	723
RM2517	Rd. End	869	896	875	761	789
Offset Push Pull Sets						
RM2545	Sq. End	837	896	836	729	755
RM2547	Rd. End	904	963	887	796	822

SoftTek - Santoprene™ Grip

Straight Pulls						
Part	Dia.	3/605 4/606	10/612 10B/613	10BE	32D/630	32/629
RM2610-8	1¼"	288	301	294	256	270
RM2610-11	1¼"	301	315	311	270	283
RM2610-16	1¼"	328	342	332	289	304
RM2610 (up to 36")	1¼"	464	478	478	416	429
Offset Pulls						
RM2640-8	1¼"	321	368	332	289	304
RM2640-11	1¼"	336	383	349	304	316
RM2640-16	1¼"	363	410	370	322	336
RM2640 (up to 36")	1¼"	500	547	517	450	464
Push Bar						
RM2612	1¼"	478	491	442	429	443

IberMet - Cork Grip

Natural Cork Straight Pulls - Square Ends						
Part	Dia.	3/605 4/606	10/612 10B/613	10BE	32D/630	32/629
RM2710N-8	1¼"	381	421	379	334	359
RM2710N-11	1¼"	381	421	379	334	359
RM2710N-16	1¼"	461	487	438	410	435
RM2710N (up to 22")	1¼"	513	540	486	460	485
Rubber Compound Cork Straight Pulls - Square Ends						
RM2710R-8	1¼"	381	421	379	334	359
RM2710R-11	1¼"	381	421	379	334	359
RM2710R-16	1¼"	461	487	438	410	435
RM2710R (up to 22")	1¼"	513	540	486	460	485
Natural Cork Offset Pulls - Square Ends						
RM2740N-8	1¼"	416	487	438	365	391
RM2740N-11	1¼"	416	487	438	365	391
RM2740N-16	1¼"	494	554	499	443	468
RM2740N (up to 22")	1¼"	546	606	545	494	519
Rubber Compound Cork Offset Pulls - Square Ends						
RM2740R-8	1¼"	416	487	438	365	391
RM2740R-11	1¼"	416	487	438	365	391
RM2740R-16	1¼"	494	554	499	443	468
RM2740R (up to 22")	1¼"	546	606	545	494	519
Natural Cork Straight Pulls - Round Ends						
RM2714N-8	1¼"	416	456	410	365	391
RM2714N-11	1¼"	416	456	410	365	391
RM2714N-16	1¼"	494	519	467	443	468
RM2714N (up to 22")	1¼"	546	572	515	494	519
Rubber Compound Cork Straight Pulls - Round Ends						
RM2714R-8	1¼"	416	456	410	365	391
RM2714R-11	1¼"	416	456	410	365	391
RM2714R-16	1¼"	494	519	467	443	468
RM2714R (up to 22")	1¼"	546	572	515	494	519
Natural Cork Offset Pulls - Round Ends						
RM2744N-8	1¼"	447	519	467	397	423
RM2744N-11	1¼"	447	519	467	397	423
RM2744N-16	1¼"	527	585	527	474	499
RM2744N (up to 22")	1¼"	580	638	574	525	550
Rubber Compound Cork Offset Pulls - Round Ends						
RM2744R-8	1¼"	447	519	467	397	423
RM2744R-11	1¼"	447	519	467	397	423
RM2744R-16	1¼"	527	585	527	474	499
RM2744R (up to 22")	1¼"	580	638	574	525	550

SOFTTEK / IBERMET

BronzeAge - Copper Rich Grip

Straight Pulls - Square Ends			
Part	Dia.	32D/630	32/629
RM2810-8	1¼"	357	370
RM2810-11	1¼"	362	375
RM2810-16	1¼"	370	383
RM2810 (up to 36")	1¼"	456	469
RM2820-11	1½"	403	416
RM2820-16	1½"	423	436
RM2820-20	1½"	436	449
RM2820 (up to 36")	1½"	522	537
Offset Pulls - Square Ends			
RM2840-8	1¼"	389	403
RM2840-11	1¼"	396	410
RM2840-16	1¼"	403	416
RM2840 (up to 36")	1¼"	490	503
RM2850-11	1½"	436	449
RM2850-16	1½"	456	469
RM2850-20	1½"	469	482
RM2850 (up to 36")	1½"	557	569
Straight Pulls - Round Ends			
RM2814-8	1¼"	389	403
RM2814-11	1¼"	396	410
RM2814-16	1¼"	403	416
RM2814 (up to 36")	1¼"	490	503
RM2824-11	1½"	436	449
RM2824-16	1½"	456	469
RM2824-20	1½"	469	482
RM2824 (up to 36")	1½"	557	569
Offset Pulls - Round Ends			
RM2844-8	1¼"	423	436
RM2844-11	1¼"	429	443
RM2844-16	1¼"	436	449
RM2844 (up to 36")	1¼"	522	537
RM2854-11	1½"	469	482
RM2854-16	1½"	490	503
RM2854-20	1½"	503	517
RM2854 (up to 36")	1½"	590	604

Push Bars - Square Ends			
Part	Dia.	32D/630	32/629
RM2812	1¼"	469	482
RM2822	1½"	537	550
Push Bars - Round Ends			
RM2816	1¼"	503	517
RM2826	1½"	569	583

- Specify lacquered or unlacquered grip.

NOTE: Post location on push bars can be located ⅛" from end for narrow & medium stile doors and 1" from end for flush and wide stile doors.

NeoMetrix - with GripZone

Straight Pulls					
Part	Dia.	3/605	9/611	32/629	32316
RM3010-12	1"	157	221	120	159
RM3010-18	1"	204	274	145	188
RM3020-12	1¼"	225	270	181	218
RM3020-18	1¼"	252	298	192	231
RM3020-24	1¼"	280	324	204	245
RM3030-12	1½"	265	298	204	
RM3030-18	1½"	284	316	227	
RM3030-24	1½"	310	343	255	
Offset Pulls					
RM3040-12	1"	199	254	143	
RM3040-18	1"	231	284	175	
RM3050-12	1¼"	276	316	221	
RM3050-18	1¼"	303	343	238	
RM3050-24	1¼"	329	369	255	
RM3060-12	1½"	324	369	255	
RM3060-18	1½"	355	395	278	
RM3060-24	1½"	395	435	301	

Push Bars - 7" Grip					
Part	Dia.	3/605	9/611	32/629	32316
RM3012	1"	276	302	186	282
RM3022	1¼"	303	343	227	276
RM3032	1½"	355	395	278	

PostMount - Straight & Offset Pulls

Straight Pulls - Square Ends										
Part	Dia.	28/628	313/710 315/711	3/605 4/606	10/612 10B/613	10BE	32D/630	32/629	32D316	32316
RM3100-8	1"	116	129	222	222	179	128	139		
RM3100-10	1"	122	134	222	222	179	128	139		
RM3100-12	1"	129	142	234	234	189	139	151		
RM3110-8	1¼"	134	147	248	248	199	139	151	223	237
RM3110-11	1¼"	142	154	261	261	210	139	151	223	237
RM3110-16	1¼"	147	160	261	261	210	139	151	223	237
RM3120-11	1½"	154	167	299	312	252	151	174		
RM3120-16	1½"	160	173	312	325	261	162	174		
RM3120-20	1½"	173	179	325	338	272	162	185		
Offset Pulls - Square Ends										
RM3130-8	1"			253	287	231	156	168		
RM3130-10	1"			253	287	231	156	168		
RM3130-12	1"			267	299	241	168	179		
RM3140-8	1¼"			280	312	252	168	179		
RM3140-11	1¼"			293	325	261	168	179		
RM3140-16	1¼"			293	325	261	168	179		
RM3150-11	1½"			333	376	303	179	202		
RM3150-16	1½"			345	390	314	191	202		
RM3150-20	1½"			358	403	324	191	215		

Groove PostMount - Straight & Offset Pulls

Straight Pulls - Square Ends						
Part	Dia.	3/605 4/606	10/612 10B/613	10BE	32D/630	32/629
RM3101-8	1"	259	259	208	168	180
RM3101-10	1"	259	259	208	168	180
RM3101-12	1"	271	271	218	180	194
Offset Pulls - Square Ends						
RM3131-8	1"	291	324	261	199	211
RM3131-10	1"	291	327	263	199	211
RM3131-12	1"	304	337	271	211	223

PostMount - Straight & Offset Pulls (con't)

Straight Pulls - Round Ends								
Part	Dia.	28/628	313/710 315/711	3/605 4/606	10/612 10B/613	10BE	32D/630	32/629
RM3104-8	1"	147	160	293	293	236	162	174
RM3104-10	1"	154	167	293	293	236	162	174
RM3104-12	1"	160	173	306	306	246	174	185
RM3114-8	1¼"	167	179	319	319	257	174	185
RM3114-11	1¼"	173	185	333	333	268	174	185
RM3114-16	1¼"	179	193	333	333	268	174	185
RM3124-11	1½"	185	198	376	390	314	197	220
RM3124-16	1½"	193	205	390	403	324	208	220
RM3124-20	1½"	205	211	403	416	334	208	231
Offset Pulls - Round Ends								
RM3134-8	1"			325	358	288	191	202
RM3134-10	1"			325	358	288	191	202
RM3134-12	1"			338	371	298	202	215
RM3144-8	1¼"			351	384	309	202	215
RM3144-11	1¼"			364	396	319	202	215
RM3144-16	1¼"			364	396	319	202	215
RM3154-11	1½"			410	455	366	226	249
RM3154-16	1½"			422	467	376	238	249
RM3154-20	1½"			436	480	387	238	261
Push Bars - Square Ends								
RM3102	1"	202	221	410	455	366	226	249
RM3112	1¼"	216	235	422	467	376	238	249
RM3122	1½"	226	245	436	480	387	238	261
Push Bars - Round Ends								
RM3106	1"	193	211	396	396	319	220	243
RM3116	1¼"	205	237	436	436	351	243	266
RM3126	1½"	237	268	480	480	387	277	300
Straight Push Pull Sets - Square Ends (not shown in catalog)								
RM3105	1"	294	327	559	559	450	323	359
RM3115	1¼"	327	370	637	637	513	359	393
RM3125	1½"	377	421	727	740	595	405	439
Offset Push Pull Sets - Square Ends (not shown in catalog)								
RM3135	1"			591	624	502	353	387
RM3145	1¼"			669	701	564	387	422
RM3155	1½"			759	805	648	433	469
Straight Push Pull Sets - Round Ends (not shown in catalog)								
RM3107	1"	358	389	701	701	564	393	428
RM3117	1¼"	389	433	780	780	627	428	462
RM3127	1½"	441	484	883	896	720	497	531
Offset Push Pull Sets - Round Ends (not shown in catalog)								
RM3137	1"			734	766	616	422	457
RM3147	1¼"			812	843	678	457	492
RM3157	1½"			915	960	772	526	561

NOTE: Post location on push bars can be located ½" from end for narrow & medium stile doors and 1" from end for flush and wide stile doors.

NeoTek - Post Mounted GripZone

Straight Pulls - Square Ends					
Part	Dia.	3/605	9/611	32/629	32316
RM3200-8	1"	257	291	161	
RM3200-10	1"	257	291	161	
RM3200-12	1"	270	303	172	
RM3210-8	1¼"	284	314	172	257
RM3210-11	1¼"	298	329	172	257
RM3210-16	1¼"	298	329	172	257
RM3220-11	1½"	337	381	194	
RM3220-16	1½"	350	395	194	
RM3220-20	1½"	363	408	205	
Offset Pulls - Square Ends					
RM3230-8	1"	291	355	188	
RM3230-10	1"	291	355	188	
RM3230-12	1"	303	369	199	
RM3240-8	1¼"	316	381	199	
RM3240-11	1¼"	329	395	199	
RM3240-16	1¼"	329	395	199	
RM3250-11	1½"	369	447	221	
RM3250-16	1½"	381	461	221	
RM3250-20	1½"	395	473	233	
Straight Pulls - Round Ends					
RM3204-8	1"	329	363	194	
RM3204-10	1"	329	363	194	
RM3204-12	1"	343	376	205	
RM3214-8	1¼"	355	390	205	
RM3214-11	1¼"	369	402	205	
RM3214-16	1¼"	369	402	205	
RM3224-11	1½"	416	461	238	
RM3224-16	1½"	428	473	238	
RM3224-20	1½"	442	487	249	
Offset Pulls - Round Ends					
RM3234-8	1"	363	428	221	
RM3234-10	1"	363	428	221	
RM3234-12	1"	376	442	233	
RM3244-8	1¼"	390	456	233	
RM3244-11	1¼"	402	468	233	
RM3244-16	1¼"	402	468	233	
RM3254-11	1½"	447	527	265	
RM3254-16	1½"	461	540	265	
RM3254-20	1½"	473	554	277	

Push Bars - Square Ends (7" Grip)				
Part	Dia.	3/605	9/611	32/629
RM3202	1"	363	395	238
RM3212	1¼"	402	435	262
RM3222	1½"	442	473	285
Push Bars - Round Ends (7" Grip)				
RM3206	1"	435	468	273
RM3216	1¼"	473	508	297
RM3226	1½"	519	554	331

NOTE: Post location on push bars can be located ⅛" from end for narrow & medium stile doors and 1" from end for flush and wide stile doors.

MegaTek - Long Door Pulls

Straight Pulls - Square Ends (87" max overall in aluminum, specify CTC and overall length.)											
Part	OA	Dia.	28/628	313/710 315/711	3/605 4/606	10/612 10B/613	10BE	32D/630	32/629	32D316	32316
RM3300	3'-4"	1"	205	243	408	408	334	242	263		
	4'-6"	1"	294	332	472	472	387	273	294		
	6'-8"	1"	370	408	638	638	522	326	368		
RM3301	3'-4"	1¼"	243	282	421	421	345	252	273	371	394
	4'-6"	1¼"	332	370	472	472	387	273	294	412	435
	6'-8"	1¼"	447	484	651	651	533	336	378	511	557
RM3302	3'-4"	1½"			433	433	355	263	284		
	4'-6"	1½"			524	524	429	294	326		
	6'-8"	1½"			677	677	554	357	420		
Offset Pulls - Square Ends (Specify CTC and overall length.)											
RM3310	3'-4"	1"			441	472	387	268	289		
	4'-6"	1"			504	537	440	300	321		
	6'-8"	1"			669	702	575	352	394		
RM3311	3'-4"	1¼"			453	484	396	279	300		
	4'-6"	1¼"			504	537	440	300	321		
	6'-8"	1¼"			682	714	585	363	405		
RM3312	3'-4"	1½"			466	497	407	289	310		
	4'-6"	1½"			554	587	481	321	352		
	6'-8"	1½"			707	739	605	384	447		
Straight Pulls - Round Ends (90" max overall in aluminum, specify CTC and overall length.)											
RM3320	3'-4"	1"	237	275	479	479	392	273	294		
	4'-6"	1"	327	364	542	542	444	305	326		
	6'-8"	1"	403	441	707	707	579	357	399		
RM3321	3'-4"	1¼"	275	314	492	492	403	284	305		
	4'-6"	1¼"	364	403	542	542	444	305	326		
	6'-8"	1¼"	479	517	721	721	590	368	410		
RM3322	3'-4"	1½"			510	510	418	305	326		
	4'-6"	1½"			600	600	491	336	368		
	6'-8"	1½"			752	752	616	399	462		
Offset Pulls - Round Ends (Specify CTC and overall length.)											
RM3330	3'-4"	1"			510	542	444	300	321		
	4'-6"	1"			574	606	496	331	352		
	6'-8"	1"			739	771	631	384	426		
RM3331	3'-4"	1¼"			524	554	454	310	331		
	4'-6"	1¼"			574	606	496	331	352		
	6'-8"	1¼"			752	784	642	394	436		
RM3332	3'-4"	1½"			542	574	470	331	352		
	4'-6"	1½"			631	663	543	363	394		
	6'-8"	1½"			784	816	668	426	489		
Straight Pulls - Bent Ends (86" max CTC in aluminum, specify CTC.)											
RM3340	3'-4"	1"	179	218	358	370	303	231	252		
	4'-6"	1"	396	433	421	433	355	263	284		
	6'-8"	1"	421	459	574	587	481	326	368		
RM3341	3'-4"	1¼"	243	268	408	421	345	242	263	354	377
	4'-6"	1¼"	358	396	472	484	396	273	294	401	424
	6'-8"	1¼"	459	510	638	651	533	336	378	476	522
RM3342	3'-4"	1½"			472	484	396	273	294		
	4'-6"	1½"			537	549	450	294	326		
	6'-8"	1½"			689	702	575	357	420		

- Add \$63/Ft. over 8'
- MP (Mid Post) - Add \$63 each (Recommended for maximum rigidity on long door pulls. See page 40 for guidelines.)

NeoMax - Long Pulls with GripZone

Straight Pulls - Square Ends (Specify CTC and overall length.)						
Part	OA	Dia.	3/605	9/611	32/629	32316
RM3400	3'-4'	1"	487	554	331	
	4'-6'	1"	554	619	365	
	6'-8'	1"	724	789	441	
RM3401	3'-4'	1¼"	499	566	343	475
	4'-6'	1¼"	554	619	365	518
	6'-8'	1¼"	737	802	453	646
RM3402	3'-4'	1½"	513	580	353	
	4'-6'	1½"	606	672	397	
	6'-8'	1½"	762	828	497	
Offset Pulls - Square Ends (Specify CTC and overall length.)						
RM3410	3'-4'	1"	519	619	360	
	4'-6'	1"	585	685	392	
	6'-8'	1"	756	854	470	
RM3411	3'-4'	1¼"	534	632	370	
	4'-6'	1¼"	585	685	392	
	6'-8'	1¼"	769	868	480	
RM3412	3'-4'	1½"	546	646	382	
	4'-6'	1½"	638	737	426	
	6'-8'	1½"	796	894	524	
Straight Pulls - Round Ends (Specify CTC and overall length.)						
RM3420	3'-4'	1"	559	625	365	
	4'-6'	1"	625	690	397	
	6'-8'	1"	796	862	475	
RM3421	3'-4'	1¼"	572	638	375	
	4'-6'	1¼"	625	690	397	
	6'-8'	1¼"	809	875	486	
RM3422	3'-4'	1½"	593	658	397	
	4'-6'	1½"	685	751	441	
	6'-8'	1½"	842	907	541	
Offset Pulls - Round Ends (Specify CTC and overall length.)						
RM3430	3'-4'	1"	593	690	392	
	4'-6'	1"	658	756	426	
	6'-8'	1"	828	927	502	
RM3431	3'-4'	1¼"	606	703	404	
	4'-6'	1¼"	658	756	426	
	6'-8'	1¼"	842	941	514	
RM3432	3'-4'	1½"	625	724	426	
	4'-6'	1½"	717	815	470	
	6'-8'	1½"	875	972	569	
Straight Pulls - Bent Ends (Specify CTC.)						
RM3440	3'-4'	1"	435	513	321	
	4'-6'	1"	499	580	353	
	6'-8'	1"	658	737	441	
RM3441	3'-4'	1¼"	487	566	331	457
	4'-6'	1¼"	554	632	365	506
	6'-8'	1¼"	724	802	453	609
RM3442	3'-4'	1½"	554	632	365	
	4'-6'	1½"	619	698	397	
	6'-8'	1½"	777	854	497	

- Add \$63/Ft. over 8'
- MP (Mid Post) - Add \$63 each (Recommended for maximum rigidity on long door pulls. See page 40 for guidelines.)

LineaMet - Contrasting Grooved Pulls

Straight Pulls - Square Ends						
Part	Dia.	3/605 4/606	10/612 10B/613	10BE	32D/630	32/629
RM3510-8	1¼"	437	451	339	276	276
RM3510-11	1¼"	437	451	339	276	290
RM3510-16	1¼"	451	467	351	305	305
RM3520-11	1½"	526	541	406	305	318
RM3520-16	1½"	541	557	418	318	332
RM3520-20	1½"	587	601	451	332	345
Offset Pulls - Square Ends						
RM3540-8	1¼"	474	526	395	311	311
RM3540-11	1¼"	474	526	395	311	326
RM3540-16	1¼"	490	541	406	339	339
RM3550-11	1½"	565	618	464	339	353
RM3550-16	1½"	578	634	476	353	366
RM3550-20	1½"	624	677	508	366	381
Straight Pulls - Round Ends						
RM3514-8	1¼"	474	490	368	311	311
RM3514-11	1¼"	474	490	368	311	326
RM3514-16	1¼"	490	504	378	339	339
RM3524-11	1½"	565	578	434	339	353
RM3524-16	1½"	578	594	446	353	366
RM3524-20	1½"	624	640	480	366	381
Offset Pulls - Round Ends						
RM3544-8	1¼"	511	565	424	345	345
RM3544-11	1¼"	511	565	424	345	359
RM3544-16	1¼"	526	578	434	373	373
RM3554-11	1½"	601	654	491	373	386
RM3554-16	1½"	618	670	503	386	400
RM3554-20	1½"	662	714	536	400	414

Push Bars - Square Ends						
Part	Dia.	3/605 4/606	10/612 10B/613	10BE	32D/630	32/629
RM3512	1¼"	587	618	464	345	373
RM3522	1½"	677	708	531	386	414
Push Bars - Round Ends						
RM3516	1¼"	624	654	491	381	408
RM3526	1½"	714	744	558	421	449

NOTE: Post location on push bars can be located ¼" from end for narrow & medium stile doors and 1" from end for flush and wide stile doors.

LineaTek - Fully Grooved Pulls

Straight Pulls - Square Ends						
Part	Dia.	3/605 4/606	10/612 10B/613	10BE	32D/630	32/629
RM3610-8	1¼"	332	347	261	208	237
RM3610-11	1¼"	332	347	261	222	249
RM3610-16	1¼"	347	362	272	222	263
RM3620-11	1½"	362	377	283	237	263
RM3620-16	1½"	377	391	294	237	276
RM3620-20	1½"	391	407	306	249	276
Offset Pulls - Square Ends						
RM3640-8	1¼"	370	421	316	242	270
RM3640-11	1¼"	370	421	316	256	285
RM3640-16	1¼"	385	437	328	256	298
RM3650-11	1½"	400	451	339	270	298
RM3650-16	1½"	415	467	351	270	311
RM3650-20	1½"	431	482	362	285	311
Straight Pulls - Round Ends						
RM3614-8	1¼"	415	431	324	249	276
RM3614-11	1¼"	415	431	324	263	290
RM3614-16	1¼"	431	445	334	263	305
RM3624-11	1½"	451	467	351	290	318
RM3624-16	1½"	467	482	362	290	332
RM3624-20	1½"	482	497	373	305	332
Offset Pulls - Round Ends						
RM3644-8	1¼"	451	504	378	285	311
RM3644-11	1¼"	451	504	378	298	326
RM3644-16	1¼"	467	520	390	298	339
RM3654-11	1½"	490	541	406	326	353
RM3654-16	1½"	504	557	418	326	366
RM3654-20	1½"	520	571	429	339	366

Push Bars - Square Ends						
Part	Dia.	3/605 4/606	10/612 10B/613	10BE	32D/630	32/629
RM3612	1¼"	437	451	339	290	318
RM3622	1½"	467	482	362	305	345
Push Bars - Round Ends						
RM3616	1¼"	520	535	402	332	359
RM3626	1½"	557	571	429	359	400

LineaMax - Long Grooved Pulls

Straight Pulls - Solid Square Ends							
Part	OA	Dia.	3/605 4/606	10/612 10B/613	10BE	32D/630	32/629
RM3701	3'-4'	1 1/4"	662	662	596	482	551
	4'-6'	1 1/4"	781	781	703	551	635
	6'-8'	1 1/4"	1051	1051	946	690	910
RM3702	3'-4'	1 1/2"	827	827	744	538	607
	4'-6'	1 1/2"	931	931	838	607	704
	6'-8'	1 1/2"	1187	1187	1068	758	936
Offset Pulls - Solid Square Ends							
RM3711	3'-4'	1 1/4"	700	738	664	518	586
	4'-6'	1 1/4"	820	857	771	586	668
	6'-8'	1 1/4"	1090	1127	1014	724	944
RM3712	3'-4'	1 1/2"	864	901	811	572	641
	4'-6'	1 1/2"	970	1007	906	641	737
	6'-8'	1 1/2"	1224	1264	1138	792	972
Straight Pulls - Fully Grooved Square Ends							
RM3721	3'-4'	1 1/4"	511	511	460	400	482
	4'-6'	1 1/4"	634	634	571	482	551
	6'-8'	1 1/4"	888	888	799	593	814
RM3722	3'-4'	1 1/2"	541	541	487	455	551
	4'-6'	1 1/2"	662	662	596	551	607
	6'-8'	1 1/2"	947	947	852	649	854
Offset Pulls - Fully Grooved Square Ends							
RM3731	3'-4'	1 1/4"	550	587	528	435	518
	4'-6'	1 1/4"	670	708	637	518	586
	6'-8'	1 1/4"	925	962	866	628	848
RM3732	3'-4'	1 1/2"	578	618	556	491	586
	4'-6'	1 1/2"	700	738	664	586	641
	6'-8'	1 1/2"	985	1021	919	682	889
Straight Pulls - Solid Round Ends							
RM3751	3'-4'	1 1/4"	700	700	630	518	586
	4'-6'	1 1/4"	820	820	738	586	668
	6'-8'	1 1/4"	1090	1090	981	724	944
RM3752	3'-4'	1 1/2"	864	864	778	572	641
	4'-6'	1 1/2"	970	970	873	641	737
	6'-8'	1 1/2"	1224	1224	1102	792	972
Offset Pulls - Solid Round Ends							
RM3761	3'-4'	1 1/4"	738	774	697	551	620
	4'-6'	1 1/4"	857	894	805	620	704
	6'-8'	1 1/4"	1127	1165	1049	758	978
RM3762	3'-4'	1 1/2"	901	941	847	607	677
	4'-6'	1 1/2"	1007	1045	941	677	772
	6'-8'	1 1/2"	1264	1300	1170	826	1005

Straight Pulls - Fully Grooved Round Ends							
Part	OA	Dia.	3/605 4/606	10/612 10B/613	10BE	32D/630	32/629
RM3771	3'-4'	1 1/4"	594	594	535	442	524
	4'-6'	1 1/4"	714	714	643	524	593
	6'-8'	1 1/4"	970	970	873	635	854
RM3772	3'-4'	1 1/2"	634	634	571	510	607
	4'-6'	1 1/2"	752	752	677	607	662
	6'-8'	1 1/2"	1037	1037	933	704	910
Offset Pulls - Fully Grooved Round Ends							
RM3781	3'-4'	1 1/4"	634	670	603	476	559
	4'-6'	1 1/4"	752	790	711	559	628
	6'-8'	1 1/4"	1007	1045	941	668	889
RM3782	3'-4'	1 1/2"	670	708	637	545	641
	4'-6'	1 1/2"	790	827	744	641	696
	6'-8'	1 1/2"	1075	1112	1001	737	944

- Add \$73.50/Ft. over 8'
- MP (Mid Post) - Add \$63 each (Recommended for maximum rigidity on long door pulls. See page 40 for guidelines).

NoirMet - Black Anodized Grip

Straight Pulls - Square Ends						
Part	Dia.	3/605 4/606	10/612 10B/613	10BE	32/629	32316
RM3800-8	1"	264	304	249	207	213
RM3800-10	1"	277	304	249	213	219
RM3800-12	1"	277	317	260	219	226
RM3810-8	1¼"	277	317	260	213	219
RM3810-11	1¼"	290	317	260	219	226
RM3810-16	1¼"	304	329	270	226	232
RM3820-11	1½"	343	369	302	251	257
RM3820-16	1½"	355	382	313	263	271
RM3820-20	1½"	382	408	334	271	276
Offset Pulls - Square Ends						
RM3830-8	1"	297	369	302	239	244
RM3830-10	1"	310	369	302	244	251
RM3830-12	1"	310	382	313	251	257
RM3840-8	1¼"	310	382	313	244	251
RM3840-11	1¼"	323	382	313	251	257
RM3840-16	1¼"	337	395	324	257	263
RM3850-11	1½"	375	435	356	283	288
RM3850-16	1½"	389	447	366	295	300
RM3850-20	1½"	415	473	387	300	308
Straight Pulls - Round Ends						
RM3804-8	1"	297	337	276	239	244
RM3804-10	1"	310	337	276	244	251
RM3804-12	1"	310	350	287	251	257
RM3814-8	1¼"	310	350	287	244	251
RM3814-11	1¼"	323	350	287	251	257
RM3814-16	1¼"	337	363	297	257	263
RM3824-11	1½"	375	402	329	283	288
RM3824-16	1½"	389	415	340	295	300
RM3824-20	1½"	415	441	361	300	308
Offset Pulls - Round Ends						
RM3834-8	1"	329	402	329	271	276
RM3834-10	1"	343	402	329	276	283
RM3834-12	1"	343	415	340	283	288
RM3844-8	1¼"	343	415	340	276	283
RM3844-11	1¼"	355	415	340	283	288
RM3844-16	1¼"	369	428	351	288	295
RM3854-11	1½"	408	468	383	314	320
RM3854-16	1½"	421	481	394	326	332
RM3854-20	1½"	447	507	415	332	338

Push Bars - Square Ends						
Part	Dia.	3/605 4/606	10/612 10B/613	10BE	32/629	32316
RM3802	1"	297	337	276	239	244
RM3812	1¼"	329	355	291	251	257
RM3822	1½"	415	441	361	300	308
Push Bars - Round Ends						
RM3806	1"	329	369	302	271	276
RM3816	1¼"	363	389	319	283	288
RM3826	1½"	447	473	387	332	338

NOTE: Post location on push bars can be located ⅛" from end for narrow & medium stile doors and 1" from end for flush and wide stile doors.

NoirTek - Black Anodized Grip

Straight Pulls - Square Ends								
Part	Dia.	28/628	313/710 315/711	3/605 4/606	10/612 10B/613	10BE	32D/630	32/629
RM3900-8	1"	133	133	157	157	141	132	132
RM3900-10	1"	133	133	157	157	141	132	132
RM3900-12	1"	133	133	157	157	141	132	132
RM3910-8	1¼"	146	146	170	170	153	144	144
RM3910-11	1¼"	146	146	170	170	153	144	144
RM3910-16	1¼"	146	146	170	170	153	144	144
RM3920-11	1½"	173	173	181	181	163	156	156
RM3920-16	1½"	185	185	181	195	176	156	168
RM3920-20	1½"	185	185	195	195	176	168	168
Offset Pulls - Square Ends								
RM3930-8	1"			188	220	198	162	162
RM3930-10	1"			188	220	198	162	162
RM3930-12	1"			188	220	198	162	162
RM3940-8	1¼"			201	233	210	173	173
RM3940-11	1¼"			201	233	210	173	173
RM3940-16	1¼"			201	233	210	173	173
RM3950-11	1½"			214	246	221	186	186
RM3950-16	1½"			214	259	233	186	197
RM3950-20	1½"			227	259	233	197	197
Straight Pulls - Round Ends								
RM3904-8	1"	165	165	188	188	169	162	162
RM3904-10	1"	165	165	188	188	169	162	162
RM3904-12	1"	165	165	188	188	169	162	162
RM3914-8	1¼"	178	178	201	201	181	173	173
RM3914-11	1¼"	178	178	201	201	181	173	173
RM3914-16	1¼"	178	178	201	201	181	173	173
RM3924-11	1½"	205	205	214	214	193	186	186
RM3924-16	1½"	218	218	214	227	204	186	197
RM3924-20	1½"	218	218	227	227	204	197	197
Offset Pulls - Round Ends								
RM3934-8	1"			220	252	227	192	192
RM3934-10	1"			220	252	227	192	192
RM3934-12	1"			220	252	227	192	192
RM3944-8	1¼"			233	267	240	204	204
RM3944-11	1¼"			233	267	240	204	204
RM3944-16	1¼"			233	267	240	204	204
RM3954-11	1½"			246	279	251	215	215
RM3954-16	1½"			246	292	263	215	228
RM3954-20	1½"			259	292	263	228	228

NOTE: Post location on push bars can be located ½" from end for narrow & medium stile doors and 1" from end for flush and wide stile doors.

NoirTek - Black Anodized Grip (con't)

Push Bars - Square Ends								
Part	Dia.	28/628	313/710 315/711	3/605 4/606	10/612 10B/613	10BE	32D/630	32/629
RM3902	1"	173	173	181	195	176	156	168
RM3912	1¼"	185	185	195	207	186	168	180
RM3922	1½"	251	251	259	272	245	228	239
Push Bars - Round Ends								
RM3906	1"	205	205	214	227	204	186	197
RM3916	1¼"	218	218	227	240	216	197	209
RM3926	1½"	284	284	292	305	275	258	270

NOTE: Post location on push bars can be located ½" from end for narrow & medium stile doors and 1" from end for flush and wide stile doors.

ArborMet - Wood Grip Pulls

Straight Pulls - Square Ends						
Part	Dia.	3/605 4/606	10/612 10B/613	10BE	32D/630	32/629
RM4000-8	1"	318	345	311	270	296
RM4000-10	1"	332	360	324	270	296
RM4000-12	1"	332	360	324	282	309
RM4010-8	1¼"	332	360	324	270	296
RM4010-11	1¼"	332	360	324	282	309
RM4010-16	1¼"	345	373	336	296	309
RM4020-11	1½"	387	414	373	322	350
RM4020-16	1½"	400	428	385	335	362
RM4020-20	1½"	414	442	398	350	376
Offset Pulls - Square Ends						
RM4030-8	1"	353	414	373	303	330
RM4030-10	1"	366	428	385	303	330
RM4030-12	1"	366	428	385	316	343
RM4040-8	1¼"	366	428	385	303	330
RM4040-11	1¼"	366	428	385	316	343
RM4040-16	1¼"	380	442	398	330	343
RM4050-11	1½"	421	483	435	356	383
RM4050-16	1½"	435	496	446	370	397
RM4050-20	1½"	448	510	459	383	410
Straight Pulls - Round Ends						
RM4004-8	1"	394	421	379	309	335
RM4004-10	1"	408	435	392	309	335
RM4004-12	1"	408	435	392	322	350
RM4014-8	1¼"	408	435	392	309	335
RM4014-11	1¼"	408	435	392	322	350
RM4014-16	1¼"	421	448	403	335	350
RM4024-11	1½"	469	496	446	376	402
RM4024-16	1½"	483	510	459	389	416
RM4024-20	1½"	496	523	471	402	429
Offset Pulls - Round Ends						
RM4034-8	1"	428	490	441	343	370
RM4034-10	1"	442	504	454	343	370
RM4034-12	1"	442	504	454	356	383
RM4044-8	1¼"	442	504	454	343	370
RM4044-11	1¼"	442	504	454	356	383
RM4044-16	1¼"	456	517	465	370	383
RM4054-11	1½"	504	566	509	410	436
RM4054-16	1½"	517	580	522	423	449
RM4054-20	1½"	531	593	534	436	464

Push Bars - Square Ends						
Part	Dia.	3/605 4/606	10/612 10B/613	10BE	32D/630	32/629
RM4002	1"	400	442	398	362	376
RM4012	1¼"	414	456	410	376	389
RM4022	1½"	483	510	459	429	456
Push Bars - Round Ends						
RM4006	1"	477	517	465	402	416
RM4016	1¼"	490	531	478	416	429
RM4026	1½"	566	593	534	482	508
Straight Pulls - Square Grip						
Part	Grip				32D/630	32/629
RM4060-10	¾" x ¾"				331	364
RM4060-12	¾" x ¾"				344	379
Offset Pulls - Square Grip						
RM4062-10	¾" x ¾"				381	421
RM4062-12	¾" x ¾"				396	435
Straight Pulls - Rectangular Grip						
RM4064-11	¾" x 1½"				404	446
RM4064-16	¾" x 1½"				419	460
Offset Pulls - Rectangular Grip						
RM4066-11	¾" x 1½"				458	504
RM4066-16	¾" x 1½"				473	520
Straight Pulls - Square Grip						
RM4068-11	1¼" x 1¼"				446	491
RM4068-16	1¼" x 1¼"				467	515
RM4068-20	1¼" x 1¼"				480	528

Long pull lengths available. Call factory for pricing.

NOTE: Post location on push bars can be located ⅛" from end for narrow & medium stile doors and 1" from end for flush and wide stile doors.

ArborTek - Wood Grip Pulls

Straight Pulls - Square Ends						
Part	Dia.	3/605 4/606	10/612 10B/613	10BE	32D/630	32/629
RM4100-8	1"	221	235	212	189	203
RM4100-10	1"	235	248	223	189	203
RM4100-12	1"	235	248	223	203	215
RM4110-8	1¼"	235	248	223	203	215
RM4110-11	1¼"	235	248	223	215	229
RM4110-16	1¼"	248	264	238	229	242
RM4120-11	1½"	278	305	275	229	242
RM4120-16	1½"	305	318	286	256	270
RM4120-20	1½"	318	332	299	270	282
Offset Pulls - Square Ends						
RM4130-8	1"	256	305	275	223	235
RM4130-10	1"	269	318	286	223	235
RM4130-12	1"	269	318	286	235	249
RM4140-8	1¼"	269	318	286	235	249
RM4140-11	1¼"	269	318	286	249	261
RM4140-16	1¼"	284	332	299	261	276
RM4150-11	1½"	312	373	336	261	276
RM4150-16	1½"	339	387	348	289	303
RM4150-20	1½"	353	400	360	303	316
Straight Pulls - Round Ends						
RM4104-8	1"	256	269	242	223	235
RM4104-10	1"	269	284	256	223	235
RM4104-12	1"	269	284	256	235	249
RM4114-8	1¼"	269	284	256	235	249
RM4114-11	1¼"	269	284	256	249	261
RM4114-16	1¼"	284	297	267	261	276
RM4124-11	1½"	312	339	305	261	276
RM4124-16	1½"	339	353	318	289	303
RM4124-20	1½"	353	366	329	303	316
Offset Pulls - Round Ends						
RM4134-8	1"	291	339	305	256	270
RM4134-10	1"	305	353	318	256	270
RM4134-12	1"	305	353	318	270	282
RM4144-8	1¼"	305	353	318	270	282
RM4144-11	1¼"	305	353	318	282	296
RM4144-16	1¼"	318	366	329	296	309
RM4154-11	1½"	345	408	367	296	309
RM4154-16	1½"	373	421	379	322	335
RM4154-20	1½"	387	435	392	335	350

Push Bars - Square Ends						
Part	Dia.	3/605 4/606	10/612 10B/613	10BE	32D/630	32/629
RM4112	1¼"	332	345	311	296	309
RM4122	1½"	360	373	336	322	335
Push Bars - Round Ends						
RM4116	1¼"	366	380	342	330	343
RM4126	1½"	394	408	367	356	370

NOTE: Post location on push bars can be located ½" from end for narrow & medium stile doors and 1" from end for flush and wide stile doors.

SkewTek - Angled End Pulls & Big Pulls

Straight Pull - Forward Segment								
Part	Dia.	28/628	313/710 315/711	3/605 4/606	10/612 10B/613	10BE	32D/630	32/629
RM4200	1½"			489	489	440	383	417
Offset Pulls - Forward Segment								
RM4210LH	1½"			519	519	467	412	447
RM4210RH	1½"			519	519	467	412	447
Straight Pulls - Rectangular Posts								
RM4270-12	2"	537	574	814		693	603	649
RM4270-24	2"	587	626	890		773	672	718
Offset Pulls - Rectangular Posts								
RM4272-12	2"	663	702	940		826	718	764
RM4272-24	2"	714	752	1014		906	788	834
Straight Pulls - Round Posts								
RM4274-12	2"	537	574	814		693	603	649
RM4274-24	2"	587	626	890		773	672	718

CenTek - 1" Radius Pulls

Part	CTC	3/605 4/606	10/612 10B/613	10BE	32D/630	32/629
RM4300	42"	655	724	652	496	564
RM4301	42"	697	750	675	537	591
RM4302	42"	886	941	847	697	750
RM4303	42"	724	778	700	564	617
RM4304	42"	724	778	700	564	617
RM4305	42"	886	941	847	697	750

CenTrex - 1" Radius Pulls

Curved Pulls									
Part	CTC	28/628	313/710 315/711	3/605 4/606	10/612 10B/613	10BE	26/625 26D/626	32D/630	32/629
RM4400-12	12"	270	283	395	451	363	395	282	307
RM4400-20	20"	270	283	437	478	385	437	294	319
Double Curved Pulls									
RM4402LH	12"	309	322	437	478	385	437	319	344
RM4402RH	12"	309	322	437	478	385	437	319	344
Straight Radius Pulls									
RM4410-12	12"	229	242	395	451	363	395	243	282
RM4410-18	18"	242	256	437	478	385	437	256	294
RM4410-24	24"	256	270	478	517	416	478	282	307
Offset Radius Pulls									
RM4412-12	12"	283	296	451	505	406	451	294	332
RM4412-18	18"	296	309	491	532	428	491	307	344
RM4412-24	24"	309	322	532	575	462	532	332	358
Semi-Circular Pulls									
RM4420	9"	176	189	328	356	287	328	193	218
RM4422	12"	176	189	328	356	287	328	193	218
Radius Push Bars									
RM4440LH	specify	336	350	601	628	505	601	447	484
RM4440RH	specify	336	350	601	628	505	601	447	484
Compound Radius Push Bars									
RM4450LH	specify	670	711	859	900	724	859	702	739
RM4450RH	specify	670	711	859	900	724	859	702	739

CenTrex - Large Radius Pulls

Semi-Circular Pulls									
Part	CTC	28/628	313/710 315/711	3/605 4/606	10/612 10B/613	10BE	26/625 26D/626	32D/630	32/629
RM4500	11"	270	283	547	575	462	547	344	383
RM4502	11"	270	283	547	575	462	547	344	383
RM4506	12"			356	451	363		268	294
Side Radius Pull									
RM4510	12"	296	322	410	451	363		319	344
Projecting Radius Pull									
RM4512	12"	350	376	601	697	560		408	433
Radius Push Bars									
RM4516LH	specify	362	388	532	560	450		370	408
RM4516RH	specify	362	388	532	560	450		370	408
Semi-Circular Pulls									
RM4550	12"			913	913	815	913		
RM4552	14"			737	737	658	737		

NOTE: Post location on push bars can be located 1/8" from end for narrow & medium stile doors and 1" from end for flush and wide stile doors.

SculpTrex - Shaped Cast Pulls

Part	CTC	3/605 4/606	10/612 10B/613	10BE	26/625 26D/626
RM5000	12"	455	455	414	455
RM5002	20"	508	508	462	508
RM5010	12"	455	455	414	455
RM5012	20"	508	508	462	508
RM5020LH	20"	550	550	500	550
RM5020RH	20"	550	550	500	550
RM5030	12"	470	470	427	470
RM5032	20"	523	523	475	523
RM5040	12"	470	470	427	470
RM5042	20"	523	523	475	523
RM5050LH	20"	564	564	513	564
RM5050RH	20"	564	564	513	564

PlanTek - Flat Front Pulls

Straight Cast Pulls							
Part	Grip Size	3/605 4/606	10/612 10B/613	10BE	26/625 26D/626	32D/630	32/629
RM5200-7	1"	192	192	160	192		
RM5200-12	1"	221	221	184	221		
RM5202	1¼"	280	280	233	280		
Offset Cast Pulls							
RM5204-8	1"	192	192	160	192		
RM5204-12	1"	221	221	184	221		
Radius End Pulls							
RM5210-10	½" x 1¼"	395	395	297		265	343
RM5210-12	½" x 1¼"	410	410	308		278	355
RM5220-12	¾" x 1½"	526	526	395		303	408
RM5220-18	¾" x 1½"	586	586	440		343	447
Square End Pulls							
RM5230-10	½" x 1¼"	366	366	275		199	278
RM5230-12	½" x 1¼"	382	382	287		212	291
RM5240-12	¾" x 1½"	484	484	363		225	316
RM5240-18	¾" x 1½"	541	541	406		238	343
Bent End Pulls							
RM5250-10	½" x 1¼"	294	294	221		186	238
RM5250-12	½" x 1¼"	308	308	232		199	252
RM5260-12	¾" x 1½"	395	395	297		238	303
RM5260-18	¾" x 1½"	468	468	351		265	343
Radius End Pulls							
RM5270-10	½" x ¾"			253		252	305
RM5270-12	½" x ¾"			263		262	316
RM5270-16	½" x ¾"			285		286	340
Straight Cast Pull							
RM5280	½" x ½"	90	96	80	90		
Push Bars - Radius Ends							
RM5212	½" x 1¼"	541	541	406		329	461
RM5222	¾" x 1½"	818	818	614		461	606
Push Bars - Square Ends							
RM5232	½" x 1¼"	541	541	406		278	447
RM5242	¾" x 1½"	804	804	603		343	593

Traditional - Decorative Pulls & Plates

Add pull price to plate price to make pull plate.

Cast Pulls								
Part	CTC	Base Plate	3/605 4/606	10/612 10B/613	10BE	15/619 15A/620	26/625 26D/626	3LIFETIME
RM5500	6"	no	76	76	67	87	76	87
RM5502	6 7/8"	yes	124	136	114	143	136	136
RM5510	12"	no	124	148	134	161	148	185
RM5512	12 7/8"	yes	173	198	165	221	198	234
Cast Pulls								
RM5520	8"	no	111	111	101	124	111	124
RM5522	8"	yes	136	136	124	148	136	156
Cast Pulls								
RM5530	5 1/2"		39	42	39	48	39	51
RM5532	7 1/2"		56	60	56	65	60	
RM5534	12"		167	167	155	179	167	
Heavy Decorative Plates - .090" Thick								
RM5590A	3" x 12"		66	80	67	80	72	
RM5590B	3 1/2" x 15"		72	85	72	85	80	
RM5590C	4" x 16"		80	92	77	92	85	
Heavy Decorative Plates - .090" Thick								
RM5592A	3" x 12"		66	80	67	80	72	
RM5592B	3 1/2" x 15"		72	85	72	85	80	
RM5592C	4" x 16"		80	92	77	92	85	
Heavy Decorative Plates - .090" Thick								
RM5594B	3 1/2" x 15"		131	144	121	144	136	
Rope Border Cast Plates								
RM5596A	3" x 12"		80	85	74	85	80	83
RM5596B	3 1/2" x 15"		92	98	85	98	92	
Plain Cast Plate - 5/16" Thick								
RM5598B	3 1/2" x 15"		105	110	97	110	105	

Classic - Finial Door Pulls

3/4" Door Pulls							
Part	Grip	Base Plate	3/605 4/606	10/612 10B/613	10BE	15/619 15A/620	26/625 26D/626
RM5600	Plain	no	233	261	261	288	261
RM5602	Rope	no	233	261	261	288	261
RM5604	Fluted	no	233	261	261	288	261
RM5610	Plain	yes	265	292	292	319	292
RM5612	Rope	yes	265	292	292	319	292
RM5614	Fluted	yes	265	292	292	319	292
1" Door Pulls							
RM5650	Plain	no	261	288	288	315	288
RM5652	Rope	no	261	288	288	315	288
RM5654	Fluted	no	261	288	288	315	288
RM5660	Plain	yes	292	319	319	348	319
RM5662	Rope	yes	292	319	319	348	319
RM5664	Fluted	yes	292	319	319	348	319
1" Offset Door Pull							
RM5670	Plain		295	321	321	336	321

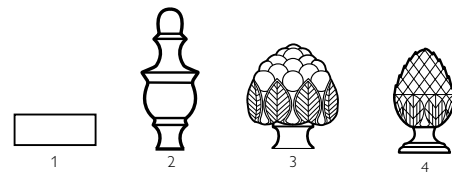

Finial Style Number (example: RM5650-4)

Suffix Finial Style:

- 1 Plain
- 2 Urn
- 3 Berry
- 4 Pinecone

- To order suffix finial style number
- Add \$4.20/inch for longer pulls up to 36"

MariTek - PostMount Pulls

Straight Door Pulls						
Part	CTC	3/605 4/606	10B/613	10BE	14/618 15/619	26/625 26D/626
RM5700	6"	193	215	193	204	204
RM5702	12"	204	226	204	215	215

English Bridle Leather Pulls

Straight Pulls - Square Ends						
Part	Dia.	3/605 4/606	10/612 10B/613	10BE	32D/630	32/629
RM6000-10	1"	620	620	508	489	515
RM6000-12	1"	677	677	554	542	567
RM6010-12	1¼"	690	690	565	567	593
RM6010-16	1¼"	771	771	631	632	658
RM6020-12	1½"	785	785	643	632	670
RM6020-16	1½"	882	882	722	696	734
Offset Pulls - Square Ends						
RM6030-10	1"	656	690	565	523	549
RM6030-12	1"	710	745	610	575	600
RM6040-12	1¼"	723	759	621	600	625
RM6040-16	1¼"	806	840	688	664	690
RM6050-12	1½"	820	855	700	664	703
RM6050-16	1½"	916	950	778	728	767
Straight Pulls - Round Ends						
RM6004-10	1"	695	695	569	529	554
RM6004-12	1"	751	751	615	580	606
RM6014-12	1¼"	765	765	626	606	632
RM6014-16	1¼"	848	848	694	670	696
RM6024-12	1½"	868	868	711	683	721
RM6024-16	1½"	964	964	789	747	786
Offset Pulls - Round Ends						
RM6034-10	1"	732	765	626	561	586
RM6034-12	1"	785	820	671	611	637
RM6044-12	1¼"	799	835	684	637	664
RM6044-16	1¼"	882	916	750	703	728
RM6054-12	1½"	903	937	767	716	754
RM6054-16	1½"	999	1033	846	780	819

- Add \$63/Ft. over 8'.
- MP (Mid Post) - Add \$63 each. (Recommended for maximum rigidity on long door pulls. See page 40 for guidelines.)
- FW (Full Wrap) available up to 72" overall length pull - Call for pricing.
- Specify leather color.

NOTE: All long pulls include charge for leather between mounting posts up to a maximum of 72" of leather cover.

Long Straight Pulls - Square Ends							
Part	OA	Dia.	3/605 4/606	10/612 10B/613	10BE	32D/630	32/629
RM6060	3'-4'	1"	1514	1514	1,363	1236	1301
	4'-6'	1"	2133	2133	1,920	1738	1866
	6'-8'	1"	2477	2477	2,229	1930	2058
RM6061	3'-4'	1¼"	1555	1555	1,400	1274	1326
	4'-6'	1¼"	2270	2270	2,043	1892	1995
	6'-8'	1¼"	2614	2614	2,353	2123	2252
RM6062	3'-4'	1½"	1720	1720	1,548	1416	1543
	4'-6'	1½"	2477	2477	2,229	2058	2187
	6'-8'	1½"	2890	2890	2,601	2316	2444
Long Offset Pulls - Square Ends							
RM6070	3'-4'	1"	1550	1583	1,425	1268	1333
	4'-6'	1"	2167	2202	1,982	1770	1899
	6'-8'	1"	2512	2545	2,291	1963	2092
RM6071	3'-4'	1¼"	1591	1625	1,463	1307	1359
	4'-6'	1¼"	2306	2340	2,106	1923	2026
	6'-8'	1¼"	2650	2683	2,415	2155	2284
RM6072	3'-4'	1½"	1756	1790	1,611	1449	1578
	4'-6'	1½"	2512	2545	2,291	2092	2220
	6'-8'	1½"	2924	2959	2,663	2349	2478
Long Straight Pulls - Round Ends							
RM6080	3'-4'	1"	1591	1591	1,432	1274	1338
	4'-6'	1"	2209	2209	1,988	1776	1904
	6'-8'	1"	2553	2553	2,298	1970	2097
RM6081	3'-4'	1¼"	1631	1631	1,468	1312	1364
	4'-6'	1¼"	2345	2345	2,111	1930	2033
	6'-8'	1¼"	2691	2691	2,422	2162	2291
RM6082	3'-4'	1½"	1804	1804	1,624	1467	1596
	4'-6'	1½"	2560	2560	2,304	2110	2239
	6'-8'	1½"	2973	2973	2,676	2367	2496
Long Offset Pulls - Round Ends							
RM6090	3'-4'	1"	1625	1659	1,493	1307	1371
	4'-6'	1"	2244	2278	2,050	1808	1938
	6'-8'	1"	2587	2622	2,360	2001	2129
RM6091	3'-4'	1¼"	1667	1701	1,531	1346	1396
	4'-6'	1¼"	2382	2415	2,174	1963	2066
	6'-8'	1¼"	2725	2759	2,483	2195	2323
RM6092	3'-4'	1½"	1837	1871	1,684	1500	1629
	4'-6'	1½"	2594	2628	2,365	2143	2271
	6'-8'	1½"	3006	3040	2,736	2400	2529

Upholstery Leather Pulls

Straight Pulls - Square Ends						
Part	Dia.	3/605 4/606	10/612 10B/613	10BE	32D/630	32/629
RM6100-10	1"	552	552	497	437	463
RM6100-12	1"	607	607	546	477	503
RM6110-12	1¼"	620	620	558	489	515
RM6110-16	1¼"	732	732	659	580	606
RM6120-12	1½"	704	704	634	529	567
RM6120-16	1½"	827	827	744	632	670
Offset Pulls - Square Ends						
RM6130-10	1"	586	620	558	472	498
RM6130-12	1"	641	677	609	509	535
RM6140-12	1¼"	656	690	621	523	549
RM6140-16	1¼"	765	799	719	611	637
RM6150-12	1½"	737	771	694	561	600
RM6150-16	1½"	861	895	806	664	703
Straight Pulls - Round Ends						
RM6104-10	1"	628	628	565	477	503
RM6104-12	1"	682	682	614	515	542
RM6114-12	1¼"	695	695	626	529	554
RM6114-16	1¼"	806	806	725	619	645
RM6124-12	1½"	785	785	707	580	619
RM6124-16	1½"	910	910	819	683	721
Offset Pulls - Round Ends						
RM6134-10	1"	662	695	626	509	535
RM6134-12	1"	717	751	676	549	575
RM6144-12	1¼"	732	765	689	561	586
RM6144-16	1¼"	840	876	788	651	677
RM6154-12	1½"	820	855	770	611	651
RM6154-16	1½"	944	978	880	716	754

- Add \$63/Ft. over 8'.
- MP (Mid Post) - Add \$63 each. (Recommended for maximum rigidity on long door pulls. See page 40 for guidelines.)
- Specify leather color.

NOTE: All long pulls include charge for leather between mounting posts up to a maximum of 72" of leather cover.

Long Straight Pulls - Square Ends							
Part	OA	Dia.	3/605 4/606	10/612 10B/613	10BE	32D/630	32/629
RM6160	3'-4'	1"	1377	1377	1,239	1095	1159
	4'-6'	1"	1900	1900	1,710	1493	1622
	6'-8'	1"	2202	2202	1,982	1673	1801
RM6161	3'-4'	1¼"	1514	1514	1,363	1236	1301
	4'-6'	1¼"	2133	2133	1,920	1776	1904
	6'-8'	1¼"	2477	2477	2,229	1981	2110
RM6162	3'-4'	1½"	1720	1720	1,548	1416	1543
	4'-6'	1½"	2477	2477	2,229	2026	2155
	6'-8'	1½"	2890	2890	2,601	2284	2413
Long Offset Pulls - Square Ends							
RM6170	3'-4'	1"	1412	1445	1,301	1126	1191
	4'-6'	1"	1935	1968	1,771	1526	1655
	6'-8'	1"	2236	2270	2,043	1705	1834
RM6171	3'-4'	1¼"	1550	1583	1,425	1268	1333
	4'-6'	1¼"	2167	2202	1,982	1808	1938
	6'-8'	1¼"	2512	2545	2,291	2015	2143
RM6172	3'-4'	1½"	1756	1790	1,611	1449	1578
	4'-6'	1½"	2512	2545	2,291	2058	2187
	6'-8'	1½"	2924	2959	2,663	2316	2444
Long Straight Pulls - Round Ends							
RM6180	3'-4'	1"	1453	1453	1,308	1133	1198
	4'-6'	1"	1977	1977	1,779	1533	1660
	6'-8'	1"	2278	2278	2,050	1712	1841
RM6181	3'-4'	1¼"	1591	1591	1,432	1274	1338
	4'-6'	1¼"	2209	2209	1,988	1815	1944
	6'-8'	1¼"	2553	2553	2,298	2021	2149
RM6182	3'-4'	1½"	1804	1804	1,624	1467	1596
	4'-6'	1½"	2560	2560	2,304	2078	2208
	6'-8'	1½"	2973	2973	2,676	2336	2463
Long Offset Pulls - Round Ends							
RM6190	3'-4'	1"	1487	1521	1,369	1165	1230
	4'-6'	1"	2010	2044	1,840	1564	1693
	6'-8'	1"	2312	2345	2,111	1744	1873
RM6191	3'-4'	1¼"	1625	1659	1,493	1307	1371
	4'-6'	1¼"	2244	2278	2,050	1847	1975
	6'-8'	1¼"	2587	2622	2,360	2052	2181
RM6192	3'-4'	1½"	1837	1871	1,684	1500	1629
	4'-6'	1½"	2594	2628	2,365	2110	2239
	6'-8'	1½"	3006	3040	2,736	2367	2496

Leather Oval - Ergonomic Pulls

True Oval				
Part	Grip Size	10BE	32D/630	32/629
RM6200-12	1" x 1½"	779	677	710
RM6200-16	1" x 1½"	902	784	820
RM6200 (3'-4')	1" x 1½"	1865	1622	1757
RM6200 (4'-6')	1" x 1½"	2797	2432	2566
RM6200 (6'-8')	1" x 1½"	3107	2702	2837
Flat Oval - ¾" Diameter Posts				
RM6220-12	¾" x 1½"	817	710	745
RM6220-16	¾" x 1½"	965	839	873
RM6220 (3'-4')	¾" x 1½"	1942	1689	1825
RM6220 (4'-6')	¾" x 1½"	2874	2499	2634
RM6220 (6'-8')	¾" x 1½"	3107	2702	2837

Flat Oval - 1" Diameter Posts				
Part	Grip Size	10BE	32D/630	32/629
RM6230-12	¾" x 1½"	849	738	771
RM6230-16	¾" x 1½"	996	866	900
RM6230 (3'-4')	¾" x 1½"	1975	1717	1851
RM6230 (4'-6')	¾" x 1½"	2906	2527	2661
RM6230 (6'-8')	¾" x 1½"	3140	2730	2864
Flat Oval - ¾" x 1½" Diameter Posts				
RM6240-12	¾" x 1½"	973	846	879
RM6240-16	¾" x 1½"	1119	973	1009
RM6240 (3'-4')	¾" x 1½"	2099	1825	1959
RM6240 (4'-6')	¾" x 1½"	3029	2634	2770
RM6240 (6'-8')	¾" x 1½"	3263	2837	2972

- Add \$63/Ft. over 8'.
- MP (Mid Post) - Add \$63 each (Recommended for maximum rigidity on long door pulls. See page 40 for guidelines.)
- Specify leather color.

NOTE: All long pulls include charge for leather between mounting posts up to a maximum of 72" of leather cover.

Flush Leather Pulls

Straight Pulls - Square Ends						
Part	Dia.	3/605 4/606	10/612 10B/613	10BE	32D/630	32/629
RM6300-10	1"	690	690	621	570	636
RM6300-12	1"	732	732	659	609	677
RM6300 (up to 4')	1"	1790	1790	1611	1554	1689
RM6310-12	1¼"	827	827	744	677	745
RM6310-16	1¼"	895	895	806	745	812
RM6310 (up to 4')	1¼"	1927	1927	1734	1622	1757
RM6310 (4'-6')	1¼"	2477	2477	2229	2162	2297
RM6310 (6'-8')	1¼"	3302	3302	2972	2972	3107
RM6320-12	1½"	895	895	806	745	812
RM6320-16	1½"	964	964	868	812	879
RM6320 (up to 4')	1½"	2064	2064	1858	1757	1892
RM6320 (4'-6')	1½"	2614	2614	2353	2297	2432
RM6320 (6'-8')	1½"	3440	3440	3096	3107	3242
Offset Pulls - Square Ends						
RM6330-10	1"	723	759	683	603	670
RM6330-12	1"	765	799	719	644	710
RM6330 (up to 4')	1"	1824	1859	1673	1588	1724
RM6340-12	1¼"	861	895	806	710	778
RM6340-16	1¼"	931	964	868	778	846
RM6340 (up to 4')	1¼"	1962	1995	1796	1656	1791
RM6340 (4'-6')	1¼"	2512	2545	2291	2196	2331
RM6340 (6'-8')	1¼"	3336	3373	3036	3007	3142
RM6350-12	1½"	931	964	868	778	846
RM6350-16	1½"	999	1033	930	846	914
RM6350 (up to 4')	1½"	2100	2133	1920	1791	1927
RM6350 (4'-6')	1½"	2650	2683	2415	2331	2467
RM6350 (6'-8')	1½"	3474	3509	3158	3142	3276

Straight Pulls - Round Ends						
Part	Dia.	3/605 4/606	10/612 10B/613	10BE	32D/630	32/629
RM6304-10	1"	723	723	651	603	670
RM6304-12	1"	765	765	689	644	710
RM6304 (up to 4')	1"	1824	1824	1642	1588	1724
RM6314-12	1¼"	861	861	775	710	778
RM6314-16	1¼"	931	931	838	778	846
RM6314 (up to 4')	1¼"	1962	1962	1766	1656	1791
RM6314 (4'-6')	1¼"	2512	2512	2261	2196	2331
RM6314 (6'-8')	1¼"	3336	3336	3002	3007	3142
RM6324-12	1½"	931	931	838	778	846
RM6324-16	1½"	999	999	899	846	914
RM6324 (up to 4')	1½"	2100	2100	1890	1791	1927
RM6324 (4'-6')	1½"	2650	2650	2385	2331	2467
RM6324 (6'-8')	1½"	3474	3474	3127	3142	3276
Offset Pulls - Round Ends						
RM6334-10	1"	759	792	713	636	704
RM6334-12	1"	799	835	752	677	745
RM6334 (up to 4')	1"	1859	1892	1703	1622	1757
RM6344-12	1¼"	895	931	838	745	812
RM6344-16	1¼"	964	999	899	812	879
RM6344 (up to 4')	1¼"	1995	2031	1828	1689	1825
RM6344 (4'-6')	1¼"	2545	2581	2323	2229	2365
RM6344 (6'-8')	1¼"	3373	3406	3065	3040	3174
RM6354-12	1½"	964	999	899	812	879
RM6354-16	1½"	1033	1067	960	879	946
RM6354 (up to 4')	1½"	2133	2167	1950	1825	1959
RM6354 (4'-6')	1½"	2683	2717	2445	2365	2499
RM6354 (6'-8')	1½"	3509	3542	3188	3174	3311

- Add \$63/Ft. over 8'.
- Up to 96" available with mid-post (Recommended for maximum rigidity on long door pulls. See page 40 for guidelines.)
- Specify leather type and color.

Upholstery Leather GeoMetek Pulls

Straight Square End Pulls				
Part	Grip Size	10BE	32D/630	32/629
RM6400-11	¾" x ¾"	495	430	473
RM6400-16	¾" x ¾"	626	544	599
RM6400 (up to 48")	¾" x ¾"	1518	1320	
RM6440-11	1¼" x 1¼"	590	513	564
RM6440-16	1¼" x 1¼"	754	656	723
RM6440 (up to 48")	1¼" x 1¼"	1885	1639	
Straight Rectangular End Pulls				
RM6410-11	¾" x 1½"	596	518	570
RM6410-16	¾" x 1½"	744	647	710
RM6410-20	¾" x 1½"	788	685	754
RM6410 (up to 96")	¾" x 1½"	2607	2267	

Offset Square End Pulls				
Part	Grip Size	10BE	32D/630	32/629
RM6420-11	¾" x ¾"	535	465	513
RM6420-16	¾" x ¾"	667	580	637
RM6420 (up to 48")	¾" x ¾"	1570	1365	
Offset Rectangular End Pulls				
RM6430-11	¾" x 1½"	634	551	606
RM6430-16	¾" x 1½"	781	679	748
RM6430-20	¾" x 1½"	899	782	862
RM6430 (up to 96")	¾" x 1½"	2645	2300	

Small Leather Pulls - for Cabinets, Casework & Closet Doors

Straight Surface Wrapped - Square Ends						
Part	Dia.	3/605 4/606	10/612 10B/613	10BE 32DMS	32D/630	32/629
RM6500-4	½"	151	151	136	121	123
RM6500-5	½"	161	161	145	131	135
RM6510-5	⅝"	186	186	167	156	158
RM6510-6	⅝"	208	208	187	178	180
Offset Surface Wrapped - Square Ends						
RM6530-5	⅝"	231	231	207	199	202
RM6530-6	⅝"	252	252	226	220	224
Straight Surface Wrapped - Round Ends						
RM6540-4	½"	167	167	150	137	139
RM6540-5	½"	178	178	160	148	151
RM6550-5	⅝"	202	202	182	171	175
RM6550-6	⅝"	224	224	202	193	195
Offset Surface Wrapped - Round Ends						
RM6570-5	⅝"	246	246	221	215	217
RM6570-6	⅝"	267	267	240	237	240
Straight Flush Wrapped - Square Ends						
RM6610-5	⅝"	208	208	187	164	166
RM6610-6	⅝"	235	235	256	191	193
Offset Flush Wrapped - Square Ends						
RM6630-5	⅝"	244	244	219	199	202
RM6630-6	⅝"	272	272	244	227	229
Straight Flush Wrapped - Round Ends						
RM6650-5	⅝"	219	219	197	175	178
RM6650-6	⅝"	246	246	221	202	204
Offset Flush Wrapped - Round Ends						
RM6670-5	⅝"	255	255	229	210	212
RM6670-6	⅝"	282	282	253	237	240
Straight Full Wrapped - Square Ends						
RM6700-4	½"	173	173	166	157	159
RM6700-5	½"	195	195	188	178	180
RM6710-5	⅝"	213	213	205	195	199
RM6710-6	⅝"	238	238	228	220	224
Offset Full Wrapped - Square Ends						
RM6730-5	⅝"	249	249	238	231	233
RM6730-6	⅝"	274	274	265	256	258

- Any size made to order.
- Specify leather type and color.

NeoCylinder - with or without GripZone

Straight Pulls without GripZone				
Part	Dia.	10BE	32D/630	32/629
RM7210-11	1¼"	270	235	276
RM7210-16	1¼"	278	242	283
RM7210-20	1¼"	286	249	289
RM7210 (up to 3')	1¼"	363	316	424
Offset Pulls without GripZone				
RM7220-11	1¼"	332	289	330
RM7220-16	1¼"	340	296	336
RM7220-20	1¼"	350	304	343
RM7220 (up to 3')	1¼"	426	370	476
Straight Pulls with GripZone				
RM7230-11	1¼"			330
RM7230-16	1¼"			336
RM7230-20	1¼"			343
RM7230 (up to 3')	1¼"			476
Offset Pulls with GripZone				
RM7240-11	1¼"			383
RM7240-16	1¼"			388
RM7240-20	1¼"			397
RM7240 (up to 3')	1¼"			529
Push Bar without GripZone				
RM7212	1¼"	325	316	424
Push Bar with GripZone				
RM7232	1¼"			476

NeoMitre - with or without GripZone

Straight Pulls without GripZone				
Part	Dia.	10BE	32D/630	32/629
RM7300-8	1"	290	252	278
RM7300-11	1"	290	252	278
RM7300-16	1"	305	265	291
RM7300 (up to 3')	1"	424	369	421
RM7310-11	1¼"	408	355	381
RM7310-16	1¼"	424	369	395
RM7310-20	1¼"	424	369	395
RM7310 (up to 3')	1¼"	484	421	499
RM7320-11	1½"	484	421	447
RM7320-16	1½"	484	421	461
RM7320-20	1½"	500	435	461
RM7320 (up to 3')	1½"	560	487	566
Offset Pulls without GripZone				
RM7330-8	1"	363	316	343
RM7330-11	1"	363	316	343
RM7330-16	1"	378	329	355
RM7330 (up to 3')	1"	500	435	487
RM7340-11	1¼"	484	421	447
RM7340-16	1¼"	500	435	461
RM7340-20	1¼"	500	435	461
RM7340 (up to 3')	1¼"	560	487	566
RM7350-11	1½"	560	487	513
RM7350-16	1½"	560	487	527
RM7350-20	1½"	574	499	527
RM7350 (up to 3')	1½"	637	554	632
Push Bars without GripZone				
RM7302	1"	424	369	421
RM7312	1¼"	484	421	499
RM7322	1½"	560	487	566

Straight Pulls with GripZone		
Part	Dia.	32/629
RM7400-8	1"	329
RM7400-11	1"	329
RM7400-16	1"	343
RM7400 (up to 3')	1"	473
RM7410-11	1¼"	435
RM7410-16	1¼"	447
RM7410-20	1¼"	447
RM7410 (up to 3')	1¼"	554
RM7420-11	1½"	499
RM7420-16	1½"	513
RM7420-20	1½"	513
RM7420 (up to 3')	1½"	619
Offset Pulls with GripZone		
RM7430-8	1"	395
RM7430-11	1"	395
RM7430-16	1"	408
RM7430 (up to 3')	1"	540
RM7440-11	1¼"	499
RM7440-16	1¼"	513
RM7440-20	1¼"	513
RM7440 (up to 3')	1¼"	619
RM7450-11	1½"	566
RM7450-16	1½"	580
RM7450-20	1½"	580
RM7450 (up to 3')	1½"	685
Push Bars with GripZone		
RM7402	1"	473
RM7412	1¼"	554
RM7422	1½"	619

GeoMetek - Narrow Profile Pulls

Straight Square End Pulls				
Part	Grip Size	10BE	32D/630	32/629
RM7900-6	¾" x ¾"	184	160	185
RM7900-8	¾" x ¾"	192	167	192
RM7900-11	¾" x ¾"	198	172	198
RM7900-16	¾" x ¾"	207	180	205
RM7900 (up to 48")	¾" x ¾"	323	281	
RM7940-6	1¼" x 1¼"	242	210	231
RM7940-8	1¼" x 1¼"	245	213	236
RM7940-11	1¼" x 1¼"	251	218	240
RM7940-16	1¼" x 1¼"	261	227	250
RM7940 (up to 48")	1¼" x 1¼"	392	341	
Straight Square Bridge Pulls				
RM7902-6	¾" x ¾"	228	198	224
RM7902-8	¾" x ¾"	236	205	230
RM7902-11	¾" x ¾"	243	211	236
RM7902-16	¾" x ¾"	250	217	243
RM7902 (up to 48")	¾" x ¾"	367	319	

Straight Rectangular End Pulls				
Part	Grip Size	10BE	32D/630	32/629
RM7910-11	¾" x 1½"	228	198	224
RM7910-16	¾" x 1½"	236	205	230
RM7910-20	¾" x 1½"	243	211	236
RM7910 (up to 96")	¾" x 1½"	734	638	
Straight Rectangular Bridge Pulls				
RM7912-11	¾" x 1½"	271	236	263
RM7912-16	¾" x 1½"	279	243	269
RM7912-20	¾" x 1½"	286	249	275
RM7912 (up to 96")	¾" x 1½"	777	676	
Offset Pulls				
RM7920-6	¾" x ¾"	215	187	211
RM7920-8	¾" x ¾"	222	193	217
RM7920-11	¾" x ¾"	230	200	224
RM7920-16	¾" x ¾"	236	205	229
RM7920 (up to 48")	¾" x ¾"	347	302	
RM7930-11	¾" x 1½"	270	235	259
RM7930-16	¾" x 1½"	276	240	265
RM7930-20	¾" x 1½"	284	247	271
RM7930 (up to 96")	¾" x 1½"	751	653	

Locking Door Pulls

Plain Post Mount - Round						
Part	Description	3/605 4/606	10BE	10BL/614	32/629	32D/630
LP3301DBD	Half Height Pull - Bolts Down	1636	1364	1636	1050	968
LP3301DBU	Half Height Pull - Bolts Up	1636	1364	1636	1050	968
LP3301FHD	Full Height Pull - Bolts Down	1986	1656	1986	1229	1120
LP3301FHU	Full Height Pull - Bolts Up	1986	1656	1986	1229	1120
LP3301FHB	Full Height Pull - Bolts Up and Down	2186	1822	2186	1423	1315
Plain Post Mount - Square						
LP7901DBD	Half Height Pull - Bolts Down		1719		1260	1161
LP7901DBU	Half Height Pull - Bolts Up		1719		1260	1161
LP7901FHD	Full Height Pull - Bolts Down		2086		1474	1344
LP7901FHU	Full Height Pull - Bolts Up		2086		1474	1344
LP7901FHB	Full Height Pull - Bolts Up and Down		2295		1707	1577
NeoTek with GripZone - Round						
Part	Description	3/605	10BE	10BL/614	32/629	32D/630
LP3401DBD	Half Height Pull - Bolts Down	1753			1163	
LP3401DBU	Half Height Pull - Bolts Up	1753			1163	
LP3401FHD	Full Height Pull - Bolts Down	2103			1342	
LP3401FHU	Full Height Pull - Bolts Up	2103			1342	
LP3401FHB	Full Height Pull - Bolts Up and Down	2304			1536	
English Bridle Leather Wrapped - Round						
Part	Description	3/605 4/606	10BE	10BL/614	32/629	32D/630
LP6061DBD	Half Height Pull - Bolts Down	3835	3684	3835	3320	2296
LP6061DBU	Half Height Pull - Bolts Up	3835	3684	3835	3320	2296
LP6061FHD	Full Height Pull - Bolts Down	5319	5136	5319	4650	4542
LP6061FHU	Full Height Pull - Bolts Up	5319	5136	5319	4650	4542
LP6061FHB	Full Height Pull - Bolts Up and Down	5504	5302	5504	4835	4967
DBD and DBU priced as 51" overall. Add \$192 list per foot over 8' long for full height or 4' long for half height.						

NOTE: New square Locking Pulls only available in US10BE, US32, and US32D.

Locking Door Pulls (con't)

PostMount Upholstery Leather Wrapped - Round						
Part	Description	3/605 4/606	10BE	10BL/614	32/629	32D/630
LP6161DBD	Half Height Pull - Bolts Down	3675	3524	3524	3082	2260
LP6161DBU	Half Height Pull - Bolts Up	3675	3524	3524	3082	2260
LP6161FHD	Full Height Pull - Bolts Down	5079	4896	4896	4307	4410
LP6161FHU	Full Height Pull - Bolts Up	5079	4896	4896	4307	4410
LP6161FHB	Full Height Pull - Bolts Up and Down	5264	5062	5062	4492	4595
PostMount Upholstery Leather Wrapped - Square						
LP6440DBD	Half Height Pull - Bolts Down		4229		3698	2712
LP6440DBU	Half Height Pull - Bolts Up		4229		3698	2712
LP6440FHD	Full Height Pull - Bolts Down		5875		5168	5292
LP6440FHU	Full Height Pull - Bolts Up		5875		5168	5292
LP6440FHB	Full Height Pull - Bolts Up and Down		6074		5390	5514
MegaTek Dummy Pull - Round						
DP3301DBD	Half Height Pull - Bolts Down					
DP3301DBU	Half Height Pull - Bolts Up					
DP3301FHD	Full Height Pull - Bolts Down					
DP3301FHU	Full Height Pull - Bolts Up					
MegaTek Dummy Pull - Square						
DP7901DBD	Half Height Pull - Bolts Down		1601		1524	924
DP7901DBU	Half Height Pull - Bolts Up		1601		1524	924
DP7901FHD	Full Height Pull - Bolts Down		1711		1902	1122
DP7901FHU	Full Height Pull - Bolts Up		1711		1902	1122
DBD and DBU priced as 51" overall. Add 192 list per foot over 8' long for full height or 4' long for half height.						

NOTE: New square Locking Pulls only available in US10BE, US32, and US32D.

Locking Door Pull Accessories

Part	Description	FBPC	28	32D	OTHERS	
LPS01	Top Strike - ¾" x 1½" x 3"	34.00	34.00	59.00	128.00	
LPS02	Top Strike - w/Rubber Stop - ¾" x 2½" x 3"	34.00	34.00	59.00	128.00	
LPS03	Top Strike - Stainless Steel - .050" x 1½" x 2¼"			27.00	54.00	
LPS04	Transom Strike - 1¼"D x 4"H			80.00	96.00	
Part	Description	3/605 4/606	10/612 10BL/614	10BE	26/625 26D/626	15/619
570	Dust Proof Strike	23.00	24.00	24	24	25
Part	Description	3/605 4/606	10/612 10BL/614	10BE	26/625 26D/626	32D/630
RM850	Floor Mounted Stop 1½" projection	25.00	29.00	26	27.00	30.00
RM851	Floor Mounted Stop 2½" projection	35.00	40.00	36	38.00	39.00
Part	Description	3/605	4/606	10BL/614	10BE	32D/630
ADA (suffix)	ADA Large Thumbturn - 1½"	32	32	32	28	32

NOTE: Thumbturn design differs between the round and square versions.

No.	Description	Page	No.	Description	Page
10	Push Bar.....	15	110 x 70	Pull Plates.....	26
10BO	Bracket for #10.....	15	110 x 73C/73CL	Pull Plate Set.....	20
11 - 18	Push Bars.....	15	110BTB13 - 112BTB13	Straight Door Pull Sets.....	22
18BFB	Bottom Fire Bolt - Metal Door.....	33	110-6SP	Security Door Pull.....	22
19	Push Bar.....	15	111, 111A	Straight Door Pull.....	22
19BFB	Bottom Fire Bolt - Wood Door.....	33	111 x 70	Pull Plates.....	26
20 - 23	Pull Bars.....	15	111x73C/73CL	Pull Plate Set.....	20
25 - 26	Push Bars.....	15	112	Straight Door Pull.....	22
27 - 30	Push Pull Bar Sets.....	15	118	Straight Door Pull.....	22
31 - 32	Pull Bars.....	15	120 - 122	Door Pulls.....	23
33 - 34	Push Bars.....	15	122 x 70	Pull Plates.....	26
35 - 36	Push Pull Bar Sets.....	15	123	Door Pull.....	23
40 - 42	Screen Door Guards.....	15	123 x 70	Pull Plates.....	26
43 - 45	Push Bars.....	15	125	Door Pull.....	23
47, -2, -3	Series 47 Push Bars.....	16	125 x 70	Pull Plates.....	26
48	Series 47 Push Bar.....	16	126	Door Pull.....	23
50	Pull Bar.....	15	126 x 70	Pull Plates.....	26
51	Push Bar.....	15	130 - 132	Cast Door Pulls.....	23
51BO	Bracket for #50.....	15	132 x 70	Pull Plates.....	26
52	Push Pull Bar Set.....	15	134 - 137	Cast Door Pulls.....	23
53	Push Pull Bar Set.....	15	137 x 70	Pull Plates.....	26
70 Series	Push Plates - .050" Thick.....	19	138 - 139	Cast Door Pulls.....	23
71 Series	Push Plates - .062" Thick.....	19	147, 147L	Cast Door Pulls.....	23
73 Series	Push Plates - .125" Thick.....	20	147 x 76, 77	Decorative Pull Plates.....	27
75 Series	Push Plates - .125" Thick.....	20	148	Cast Door Pull.....	23
76 Series	Decorative Push Plates - .050" Thick.....	20	148 x 76, 77	Decorative Pull Plates.....	27
77 Series	Decorative Push Plates - .050" Thick.....	20	149	Cast Door Pull.....	23
80 - 86	Push Plates - .050" Thick.....	21	176 - 177	Offset Door Pulls.....	25
87	Push Plate - .125" Thick.....	21	185	Offset Door Pull.....	25
90, 90B	Cylinder Pulls.....	21	193	Hospital Door Pull.....	25
91 - 93	Combination Push Pull Plates.....	21	208	Wooden Door Pull.....	25
94, 94BTB	Flush Pulls.....	21	215, 215L	Tapered Door Pulls.....	25
94C	Flush Pull.....	21	290 - 296	Corner Guards.....	27
94DLL, 94DLS	Dead Lock Flush Pulls.....	21	300 - 302B	Mortise Door Edges.....	27
94L, 94P	Flush Pulls.....	21	304 - 307	Non-Mortise Door Edges.....	28
94P x 94L	Flush Pull Set.....	21	308 - 310B-BS	Overlapping Door Edges.....	28
95A, 95B	Flush Pulls.....	21	320 - 330	Latch Protectors.....	28
95R	Flush Pull - Round.....	21	400 - 405	Solid Cast Wall Stops.....	29
96	Flush Pull.....	21	406 - 411	Wrought Wall Stops.....	29
102	Straight Door Pull.....	22	412 - 416	Solid Cast Wall Stop.....	29
102 x 70	Pull Plates.....	26	426	Wall Stop.....	29
105	Straight Door Pull.....	22	430	Solid Cast Wall Stop.....	29
105 x 70	Pull Plates.....	26	431, 432W	Wall Stops.....	29
106	Straight Door Pull.....	22	438 - 439	Light Duty Dome Stops.....	29
106 x 70	Pull Plates.....	26	440 - 441	Low Dome Stops.....	29
107	Straight Door Pull.....	22	441CU	Dome Stop Combination Unit.....	29
107 x 70	Pull Plates.....	26	441H	Cast Universal Dome Stop.....	29
107 x 73B/73BL	Pull Plate Set.....	20	442 - 443	High Dome Stops.....	29
107BTB5 - 112BTB5	Straight Door Pull Sets.....	22	444	Cast Door Stop Riser.....	29
108 - 110	Straight Door Pull.....	22	445, 445H	Heavy Duty Door Stop.....	29

No.	Description	Page	No.	Description	Page
446	Door Stop.....	29	622	190° Door Viewer	31
449	Door Stop Riser.....	29	622VC	Viewer Cover for 622.....	31
455	Curved Roller Stop.....	29	624	620 Door Viewer with Cover.....	31
456, 456L	Straight Roller Stops.....	29	626 - 629	622 Door Viewers with Covers.....	31
458	Kick Down Door Stop.....	29	630 Series	Surface Bolts.....	31
459	Spring Loaded Plunger Stop.....	29	640, 640RE	Residential Flush Bolts	31
460 - 461L	Kick Down Door Stops.....	29	651	Card Holder.....	31
462 - 468	Heavy Duty Door Stops.....	29	660, 661, 662	Decal.....	31
470 - 481	Door Stops.....	29	670 Series	Engraved Signs.....	32
481MP	Heavy Duty Mounting Plate	29	674H	Engraved Signs.....	32
482 - 485	Door Stops.....	29	700 - 702	Hand Rail Brackets.....	33
486	Angle Door Stop.....	29	790	Small Coat Hook.....	33
487	Heavy Duty Wall Stop	29	796	Small Double Coat Hook.....	33
488 - 489	Door Stops.....	30	802, 806	Medium Coat Hooks.....	33
490	Door Holder & Stop.....	30	841	Ball Knob	33
491 - 494S	Automatic Door Holders & Stops	30	845	Utility Pull.....	33
505 - 508	Cast Brass Door Stops	30	850 - 856	Wire Pulls	33
517	Aluminum Door Stop.....	30	860	Flush Cup Pull.....	33
518 - 519	Cast Brass Door Stops	30	870	Wrought Flush Pull.....	33
520	Replacement Bumper.....	30	872	Cast Flush Pull.....	33
525 - 526	Spring Base Door Stops.....	30	880	Cast Lever Edge Pull.....	33
528	Hinge Pin Stop.....	30	885	Concealed Edge Pull	33
550 Series	Lever Ext. Flush Bolt, Guide & Strike	30	890 - 891	Pocket Door Pulls	33
554 Series	Rabbit Piece, Guide & Strike.....	30	900 - 901	Magnetic Catches.....	33
555 Series	Lever Ext. Flush Bolt, Bolt Head, Guide & Strike.....	30	910 - 911	Adjustable Ball Catches.....	33
555ROD	Optional Bolt Lengths.....	30	1100	Carry Bar.....	33
555 x 18BFB	Flush Bolt w/Bottom Fire Bolt.....	30	1700	Door Coordinator.....	33
556WS	Lever Ext. Wind Storm Flush Bolt.....	30	2600 Series	Door Coordinators	33
557 Series	Lever Ext. Flush Bolt & Strike.....	30	2805	Self Latching Flush Bolt (Top Only)	33
555 x 19BFB	Flush Bolt w/Bottom Fire Bolt.....	30	2840, 2842	Automatic Flush Bolt Set.....	33
570	Dust Proof Strike.....	30, 74	2845	Combination Flush Bolt Set.....	33
576, 576B	Gravity Door Coordinator.....	30	2905	Self Latching Flush Bolt (Top Only)	33
580 Series	Surface Bolts.....	30	2940, 2942	Automatic Flush Bolt Set.....	33
582 Series	Surface Bolts.....	30	2945	Combination Flush Bolt Set.....	33
585 Series	Heavy Duty Surface Bolts	30	11047, -2, -3	Straight Push Pull Bar Sets	16
590 - 594	Roller Latches.....	30	11147, -2, -3	Straight Push Pull Bar Sets	16
596 Series	Hospital Push Pull Latches.....	30	111A47, -2, -3	Straight Push Pull Bar Sets	16
602	Secret Gate Latch.....	30	11247, -2, -3	Straight Push Pull Bar Sets	16
603 - 604	Door Guards w/Shim.....	31	11847	Straight Push Pull Bar Set.....	16
605, 605SMS	Door Guard Protection Plates.....	31	ADA	ADA Large 1 ³ / ₄ " Thumbturn.....	74
606	Wall Guard	31	BF97, BF97L	Barrier Free Flush Pulls.....	21
607 (PDL)	Privacy Door Latch	31	BF150 - BF159	90° Offset Door Pulls.....	24
608 - 609	Door Silencers.....	31	BF156 - BF159 BTB16	90° Offset Door Pull Sets.....	24
611	Door Knocker.....	31	BF156 - BF159 C17	90° Offset Door Pull Sets.....	24
614, 614V	Door Knockers.....	31	BF160 - BF169	45° Offset Door Pulls.....	25
619	160° Door Viewer	31	BF257 - BF260	Heavy Duty Offset Door Pulls.....	26
620	160° Door Viewer	31	BF680 Series	Engraved Signs w/Braille.....	32
620VC	Viewer Cover for 619.....	31	BF683 - BF689	ADA Tactile Signs w/Braille.....	32
621	160° Door Viewer	31	BF15647, -2, -3	Offset Push Pull Bar Sets	16
			BF15747, -2, -3	Offset Push Pull Bar Sets	16

No.	Description	Page	No.	Description	Page
BF157A47, -2, -3	Offset Push Pull Bar Sets.....	16	KIT Series	Mounting Kits for Door Pulls.....	14
BF15847, -2, -3	Offset Push Pull Bar Sets.....	16	LA86	Latch Adapter Plate.....	35
BF15947	Offset Push Pull Bar Set.....	16	LF161	Door Edge Filler Plate.....	35
BFLG10 - BFLG16	Latch Guard Covers.....	34	LP3301	Locking Pull Plain Post Mount (round).....	73
BFM682 - BFM689	Tactile ADA Molded Plastic Signs w/Braille.....	32	LP3401	Locking Pull NeoTek with GripZone.....	73
BFRC12, BFRC24	Vertical Rod Covers.....	34	LP6061	Locking Pull English Bridle Leather Wrapped.....	73
BP47, -2, -3	Series 47 Push Bars w/Base Plate.....	16	LP6161	Locking Pull Upholstery Leather Wrapped (round).....	74
CP10 - CP10HD	Pivots - Standard Head.....	35	LP7901	Locking Pull Plain Post Mount (square).....	73
CP20 - CP20HD	Pivots - Standard Head Pivot.....	35	LP6440	Locking Pull Upholstery Leather Wrapped (square).....	74
CP40 - CP40HD	Pivots - Standard Floor.....	35	LPS01 - LPS04	Locking Pull Strikes.....	74
CP50 - CP50HD	Pivots - Standard Floor Pivot.....	35	OH100	HD Concealed Overhead Stops.....	34
CPK2840	Cover Plate Kit.....	33	OH200	Concealed Overhead Holders & Stops.....	34
CS Series	Custom Strikes.....	35	OH900	HD Surface Overhead Stops.....	34
D89	Security Flush Pull.....	21	OH1000	Surface Overhead Holders & Stops.....	34
D133	Security Loop Door Pull.....	23	PDL (607)	Privacy Door Latch.....	31
DP3301	MegaTek Dummy Pull (round).....	74	R101LPB	Trim Protector Bars.....	35
DP7901	MegaTek Dummy Pull (square).....	74	R102LPB	Trim Protector Bars.....	35
DF86	Door Edge Filler Plate.....	35	R111LPB	Trim Protector Bars.....	35
DFF4	Frame Hinge Filler Plates.....	35	R112LPB	Trim Protector Bars.....	35
DFF5	Frame Hinge Filler Plates.....	35	R115LPB	Trim Protector Bars.....	35
DHF4B	Door Hinge Filler Plates.....	35	R116EDPH	Exit Device Protector.....	35
DHF4S	Door Hinge Filler Plates.....	35	R116EDPL	Exit Device Protector.....	35
DHF5B	Door Hinge Filler Plates.....	35	RM201 - RM372	Tubular - 1¼" & 1½" Diameter Pulls.....	40
DHF5S	Door Hinge Filler Plates.....	35	RM405 - RM423	RightAngles GripZone Pulls.....	41
FB-1, -2	Filler Bars.....	33	RM710 - RM735	Small Pulls - Wire.....	41
FBF48	Flush Bolt Filler Plate.....	35	RM751 - RM760	Edge Pulls - for Closet Doors.....	42
FBS48	Flush Bolt Strike Filler Plate.....	35	RM780 - RM785	Small Pulls - Flush.....	41
FC161	Door Face Filler Plate.....	35	RM801 - RM843	Coat Hooks.....	42
FD160	Door Face Filler Plate.....	35	RM850 - RM877	Door Stops.....	42
HD2230	Heavy Duty Trim Protector Bars.....	35	RM850, RM851	Door Stops.....	74
HD2230M	Heavy Duty Trim Protector Bars.....	35	RM1010 - RM1040	Push Pull Plates.....	43
HD2240	Heavy Duty Trim Protector Bars.....	35	RM1110 - RM1160	Indicator Plates.....	43
HD2240M	Heavy Duty Trim Protector Bars.....	35	RM1200 - RM1270	Small PostMount Pulls.....	43-44
HD2250	Heavy Duty Trim Protector Bars.....	35	RM1300 - RM1370	Small PostMount GripZone Pulls.....	44
HD2250M	Heavy Duty Trim Protector Bars.....	35	RM1410 - RM1470	NoirMet Small PostMount Pulls.....	45
HS42	4 Hinge Shims.....	35	RM1510 - RM1570	ArborMet Small PostMount Pulls.....	45
HS44	4½" Hinge Shims.....	35	RM1610N - RM1670N	IberMet Small PostMount Pulls.....	45
HS52	5" Hinge Shims.....	35	RM1610R - RM1670R	IberMet Small PostMount Pulls.....	45
HS54	5" Hinge Shims.....	35	RM2000 - RM2034	MegaCurve (long door pulls).....	45
K1038	Metal Door Plate - .038" Thick.....	37	RM2110 - RM2142	MezzoTek (necked post pulls).....	46
K1050, K1050F	Metal Door Plates - .050" Thick.....	37	RM2200 - RM2247	BandWidth (collar mount pulls).....	47
K1050-1 - K1050-8	Shaped Metal Door Plates - .050" Thick.....	37	RM2300 - RM2330	OvalTek (true oval grip).....	48
K1050A-1 - K1050A-8	Shaped Metal Door Plates - .050" Thick.....	37	RM2400 - RM2420	OvalTek (flat oval grip).....	48
K1062	Metal Door Plate - .062" Thick.....	38	RM2510 - RM2547	SoftMet (Santoprene™ grip).....	48
K1125	Metal Door Plate - .125" Thick.....	38	RM2610 - RM2645	SoftTek (Santoprene™ grip).....	49
K2060 Series	Plastic Door Plates - .060" Thick.....	38	RM2710N - RM2744N	IberMet (natural cork grip).....	49
K2125 Series	Plastic Door Plates - .125" Thick.....	38	RM2710R - RM2744R	IberMet (rubber cork grip).....	49
K3125	Laminate Plastic Door Plate - .125" Thick.....	38	RM2810 - RM2857	BronzeAge (copper rich grip).....	50
K4125	Clear Plastic Door Plate - .125" Thick.....	38			
KB1150 - KB1152	Angle Plates - .050" Thick.....	35			

No.	Description	Page	No.	Description	Page
RM3010 - RM3065	NeoMetrix (with GripZone).....	51	T11847	Tubular Straight Push Pull Bar Set.....	17
RM3100 - RM3157	PostMount (straight & offset pulls).....	51-52	TBF156 - TBF159	Tubular 90° Offset Door Pulls.....	24
RM3101 - RM3131	Groove Postmount (straight & offset pulls).....	51	TBF156 - TBF159 BTB16	Tubular 90° Offset Door Pull Sets.....	24
RM3200 - RM3257	NeoTek (post mounted GripZone).....	53	TBF156 - TBF159 C17	Tubular 90° Offset Door Pull Sets.....	24
RM3300 - RM3342	MegaTek (long door pulls).....	54	TBF15647	Tubular Offset Push Pull Bar Sets.....	17
RM3400 - RM3442	NeoMax (long pulls with GripZone).....	55	TBF15747	Tubular Offset Push Pull Bar Sets.....	17
RM3510 - RM3557	LineaMet (contrasting grooved pulls).....	56	TBF157A47	Tubular Offset Push Pull Bar Sets.....	17
RM3610 - RM3657	LineaTek (fully grooved pulls).....	57	TBF15847	Tubular Offset Push Pull Bar Sets.....	17
RM3701 - RM3782	LineaMax (long grooved pulls).....	58	TBF15947	Tubular Offset Push Pull Bar Set.....	17
RM3800 - RM3857	NoirMet (black anodized grip).....	59	VRT12 - VRT26	Vandal Resistant Trim.....	26
RM3900 - RM3957	NoirTek (black anodized grip).....	60-61	Y102 - Y112	Straight Door Pulls w/Base Plates.....	23
RM4000 - RM4068	ArborMet (wood grip pulls).....	62	Y118	Straight Door Pulls w/Base Plate.....	23
RM4100 - RM4157	ArborTek (wood grip pulls).....	63	YBF150 - YBF159	90° Offset Door Pulls w/Base Plates.....	25
RM4200 - RM4274	SkewTek (angled end & big pulls).....	64			
RM4300 - RM4305	CenTek (1" radius pulls).....	64			
RM4400 - RM4450	CenTrex (1" radius pulls).....	65			
RM4500 - RM4552	CenTrex (large radius pulls).....	65			
RM5000 - RM5050	SculpTrex (shaped cast pulls).....	66			
RM5200 - RM5280	PlanTek (flat front pulls).....	66			
RM5500 - RM5598	Traditional Decorative Pulls & Plates.....	67			
RM5600 - RM5670	Classic Finial Door Pulls.....	67			
RM5700 - RM5702	MariTek Door Pulls.....	67			
RM6000 - RM6092	English Bridle Leather Pulls.....	68			
RM6100 - RM6192	Upholstery Leather Pulls.....	69			
RM6200 - RM6240	Leather Oval Ergonomic Pulls.....	70			
RM6300 - RM6354	Flush Leather Wrapped Pulls.....	70			
RM6400 - RM6440	Upholstery Leather GeoMetek Pulls.....	71			
RM6500 - RM6730	Small Leather Pulls.....	71			
RM7210 - RM7240	NeoCylinder (with or without GripZone).....	71			
RM7300 - RM7450	NeoMitre (with or without GripZone).....	72			
RM7900 - RM7940	GeoMetek (narrow profile pulls).....	72			
SD1230	Standard Duty Trim Protector Bar.....	35			
SD1240	Standard Duty Trim Protector Bar.....	35			
SD1250	Standard Duty Trim Protector Bar.....	35			
SD1260	Standard Duty Trim Protector Bar.....	35			
SF160	Strike Filler Plate.....	35			
SFASA	Strike Filler Plate.....	35			
SFB160	Strike Filler Plate.....	35			
SP47	Series 47 Push Bar.....	16			
SP1001 - SP1079	Fasteners - Spare Parts.....	10-13			
T47, -2, -3	Tubular Push Bars.....	17			
T110 - T118	Tubular Door Pulls.....	22			
T110 - T112 BTB5	Tubular Door Pulls Sets.....	22			
T110 - T112 BTB13	Tubular Door Pulls Sets.....	22			
T110 x 70	Tubular Pull Plates.....	27			
T111 x 70	Tubular Pull Plates.....	27			
T11047	Tubular Straight Push Pull Bar Sets.....	17			
T11147	Tubular Straight Push Pull Bar Sets.....	17			
T111A47	Tubular Straight Push Pull Bar Sets.....	17			
T11247	Tubular Straight Push Pull Bar Sets.....	17			



ROCKWOOD®
ASSA ABLOY

Copyright © 1999-2015. Rockwood Manufacturing Company, an ASSA ABLOY Group company. All rights reserved. Reproduction in whole or in part without the express written permission of Rockwood Manufacturing Company is prohibited.

ASSA ABLOY is the global leader in door opening solutions, dedicated to satisfying end-user needs for security, safety and convenience.

P.O. Box 79
Rockwood, PA 15557
Phone: 800.458.2424
Fax: 800.922.9212
www.rockwoodmfg.com

(In Canada)
Door Security Solutions Canada
160 Four Valley Drive
Vaughan, ON L4K 4T9
800-461-3007
www.assaabloy.ca

RM-101 Rev K 01/2015