



P516-226



TK400

Wireless test kit

Instructions for TK400 test kit

Contents

Overview	3
Getting started	4
TK400 test kit operation	5
Using the PIM400-TD2	5
WPR400-DT LED reference	6
Improving RF communication	7
Reprogramming the WPR400-DT using the Handheld Device (HHD)	7
Batteries	8
Charging WPR400-DT batteries	8
Installing or replacing WPR400-DT batteries	8
Troubleshooting	10
FCC/IC Statements	11

Overview

The TK400 Test Kit is used to determine the optimum mounting position (for radio frequency (RF) communication) of a Wireless Access Point Module (WAPM). The AD-400 Series locks, WPR400, WRI400 and WSM400 are examples of WAPMs.

The TK400 test kit consists of:

- A PIM400-TD2
 - used to determine a suitable location for the PIM400-TD2 or PIM400-485
 - powered with 12VDC power supply
- A WPR400-DT
 - a battery-powered device used with the PIM400-TD2
 - operates at half the transmission power of the equipment that will be installed

Note: The WPR400 can be used as a wireless signal tester when in "test" mode. The WPR400 is sold separately and is supplied with an attached functioning credential reader.
- A battery charger for the WPR400-DT
- A 12VDC power supply (part number 23843790)
- A carry case

Additional equipment required:

- Handheld Device (HHD) with Schlage Utility Software (SUS).

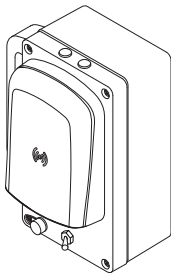

WPR400-DT

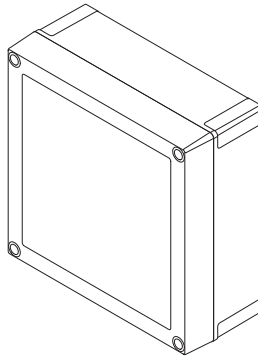

PIM400-TD2

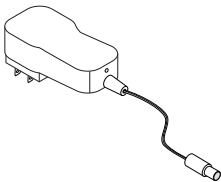

BATTERY CHARGER

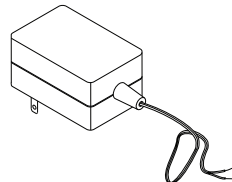

POWER SUPPLY

Getting started

Follow these steps when using a TK400 Test Kit:

1. Place the PIM400-TD2 in the same location where the PIM400-TD2 or PIM400-485 will be installed.
2. Place the WPR400-DT in the same location where the WAPM will be installed.
3. A successful link between the PIM400-TD2 and the WPR400-DT indicates a location for the WAPM that is capable of reliable transmissions. See *Troubleshooting* on page 10 for more information.
4. Familiarize yourself with the information contained in this user guide.

Save this user guide for future reference.

Using the PIM400-TD2

The PIM400-TD2 communicates with locks using radio frequency (RF) signals. RF signals are diminished by walls, metal objects or barriers. Consider the following when placing the PIM400-TD2:

- Mount the PIM400-TD2 within 200 horizontal feet (61 meters) of each WAPM. When clear line-of-sight is available, communication may be possible up to 1000 feet (305 meters).
- The PIM400-TD2 must be mounted on the same floor of the building as the WAPM to which it will be linked.
- Avoid mounting the PIM400-TD2 on a metal surface. A separation of at least one inch must be maintained in all directions from any metal.
- A signal will not pass through metal walls or metal mesh in the walls (stucco). Use a Remote antenna module (ANT400) located outside the room when necessary.
- Moving vehicles will interrupt the signal. Placement distance should be reduced by half when vehicles may temporarily block the signal.

Follow these steps to install and link the PIM400-TD2:

1. Mount the PIM400-TD2 to the wall (or ceiling) in the exact location that the PIM400-TD2 or PIM400-485 would be located.

① **Mount the PIM400-TD2 as the PIM400-TD2 or PIM400-485 would be mounted (mounting hardware not included).**

2. Remove the cover from the PIM400-TD2.
3. Connect the bare leads from the power supply to J2 (DC power) plug-in screw terminal on the PIM400-TD2. It is not necessary to observe polarity.
4. Connect the power supply to 120 VAC.
5. Press and release LINK 1 button (SW2) to link access point 1. The corresponding LED (LED1) blinks red and green. This indicates that the PIM400-TD2 is in link mode. To abort link mode, press the LINK 1 button again.

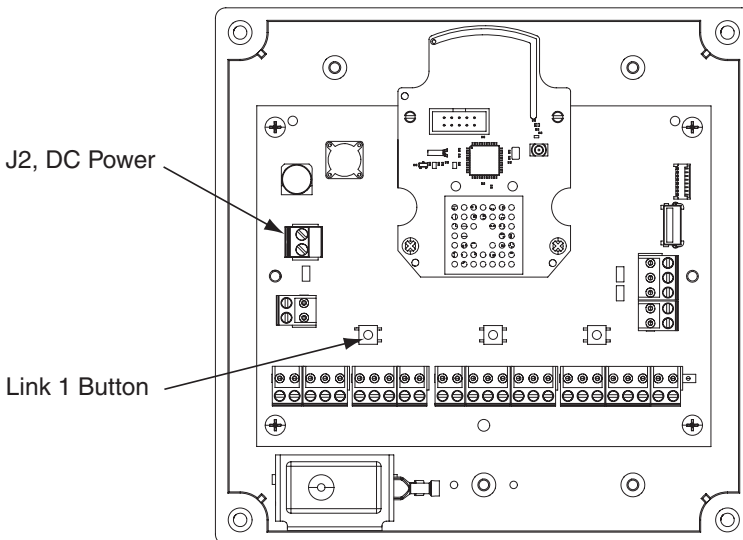

Using the WPR400-DT

- ① **Do not attempt a pre-installation test if the WPR400-DT batteries are low. See *Batteries* on page 8 for information on charging the batteries.**
- ① **Always locate the WPR400-DT in the intended mounting position before and during the linking process.**
 1. The WPR400-DT should be held in place at the exact spot where the WAPM (WPR400, WRI400, WSM400 or interior of the AD-400) will be installed. Always hold the WPR400-DT by the handle, not by the housing.
 2. Test on the intended door with the door open and with the door closed.
 3. Turn on the WPR400-DT. It will perform a power-on test and then automatically enter Tester mode. It will then send 200 test packets to check the quality of the RF link. A successful link will produce more green than red LED blinks during the link transmissions. See *WPR400-DT LED reference* below for details.
 4. To repeat the link test, turn the WPR400-DT off, then on again to cycle power. The WPR400-DT will enter Tester mode as described in step 3 above.

TIP

The first time you link the WPR400-DT to the PIM400-TD2, do so within close proximity so that you can observe a successful link result before linking at a remote distance.

WPR400-DT LED reference

The WPR400-DT LEDs will blink to indicate RF communication quality as follows:

LED	Condition
Solid green, fast green blinks, or very few red blinks	Good Link
Solid red or fast red blinks	Poor or No Link
10 fast red	Low battery, test incomplete (see <i>Batteries</i> on page 8)

If the RF transmission is poor or unsuccessful, attempt modifications to improve the transmission. See *Improving RF communication* on page 7.

Improving RF communication

If the WPR400-DT indicates a poor link or no link, try one of the following:

1. Ensure that the distance between the PIM400-TD2 and the WPR400-DT does not exceed 200 feet (61 meters). The PIM400-TD2 and the WPR400-DT should not be located on separate floors in a building.
2. If the linking problem still exists and the PIM400-TD2 is in a closet, move it outside the closet where a Schlage remote antenna could be located. This will eliminate the RF attenuation from the closet wall. If this allows linking, then the PIM400-TD2 or PIM400-485 should be mounted outside the closet. If it is not desirable to mount the PIM400-TD2 or PIM400-485 outside the closet, then mount it in the closet with a Schlage remote antenna module (ANT400) mounted outside the closet.
3. If the linking problem still exists, use a PIM400-TD2 with a Schlage directional (remote) antenna aimed at the non-linking WPR400-DT location.
4. Finally, move the PIM400-TD2 to another workable location nearer to the test site, then test again.

Reprogramming the WPR400-DT using the Handheld Device (HHD)

To reprogram the WPR400-DT, an active credential reader must be connected to the WPR400-DT with a reader cable. The HHD can then be used to program the WPR400-DT firmware.

- ① **Make sure power is connected before programming.**

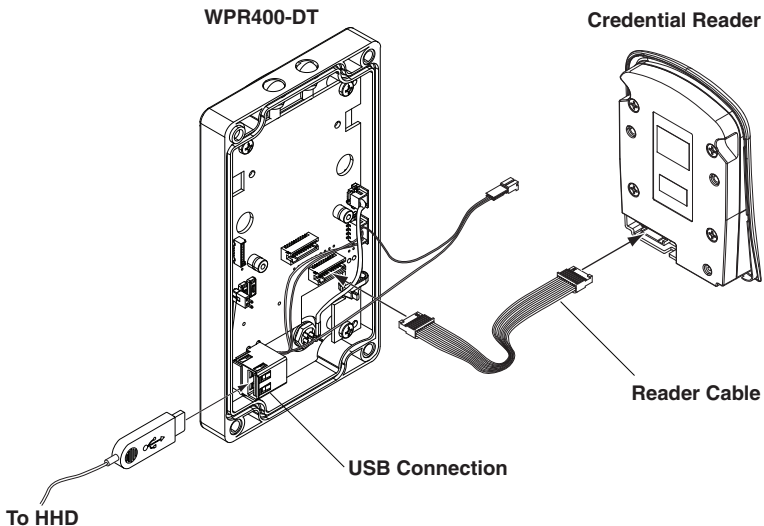

For information about the HHD and reprogramming firmware, see the Schlage Utility Software user guide.

Batteries

Charging WPR400-DT batteries

① **Turn off the WPR400-DT before charging the battery.**

1. Open the power jack cover.
2. Plug the battery charger in to the power jack.
3. Connect the battery charger to 120 VAC.

① **The battery charger's LED is red while charging, and green when fully charged. Red and green blinking indicates a bad connection.**

① **Battery charge will take approximately 4-8 hours.**

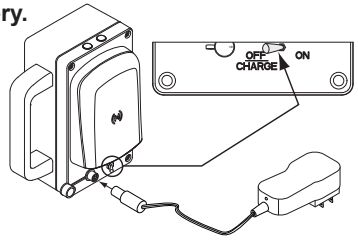

Installing or replacing WPR400-DT batteries

1. Remove the WPR400-DT cover.
2. Disconnect the battery pack.

1.

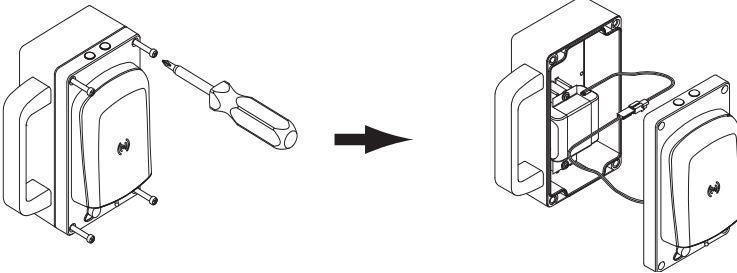

2.

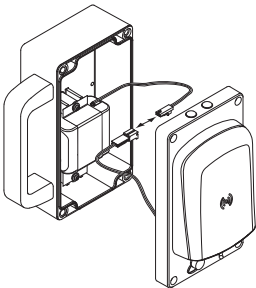

3. Remove the battery retainer and the old battery pack.
4. Position the new battery pack in the same location as the old battery pack.
5. Carefully pack the battery wires, and reattach the battery retainer.
6. Connect the new battery pack.
7. Reattach the WPR400-DT cover making sure no wires are pinched.

3.

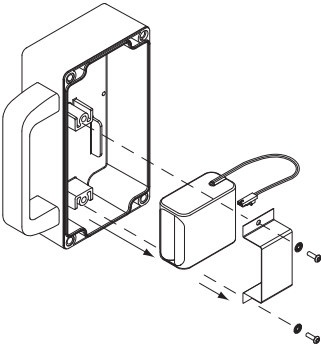

4.

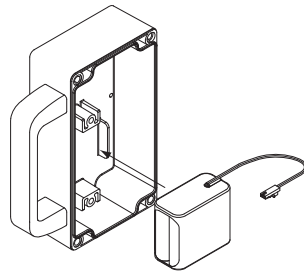

5.

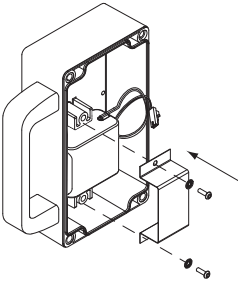

6.

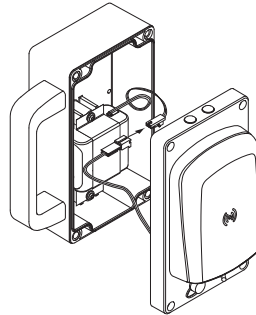

7.

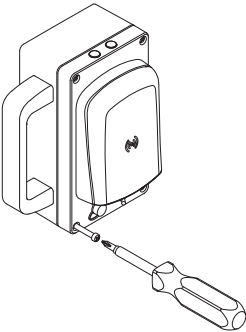

Troubleshooting

If the WPR400-DT is unable to link with the PIM400-TD2, or if there are a large number of red blinks on the WPR400-DT, follow these recommendations:

- Verify that the battery of the WPR400-DT is fully charged (LED on charger is green) and the power to the PIM400-TD2 is appropriate. See *Using the PIM400-TD2* on page 5 for more information.
- Verify that the PIM400-TD2 is in link mode with LED1 blinking red and green.
- Ensure that the PIM400-TD2 and the WAPM are properly located. Check for and remove if necessary any metal objects in the line-of-sight between the PIM400-TD2 and WAPM. Metal reinforcements in the walls will obstruct signal transmission. The distance between the PIM400-TD2 and the WAPM should not exceed 200 feet (61 meters), unless line-of-sight up to 1000 feet (305 meters) is completely unobstructed.
- Ensure that the PIM400-TD2 and WPR400-DT are on the same floor of the building — do not locate on separate floors.
- Look for other products and devices in the area that can cause RF interference (wireless phones, wireless security alarms, wireless speaker systems, etc.). If necessary, change the RF channel of the PIM400-TD2 and try again. Refer to the Schlage Utility Software (SUS) user guide for information on changing the PIM400-TD2 RF channel.

FCC/IC Statements

The communication module is a 900 MHz transceiver for electronic locks and non-lock devices. The communication module links the access device to the Access Control Management System, with feedback control to the Access Device via a wireless means. The module contains the embedded firmware implementing the radio physical and data layers. The antennas associated with this module are:

1. PCB trace inverted-L with a measured gain of 5.7dBi.
2. Omni, wall/post, indoors/outdoors.
3. Omni, ceiling, indoors.
4. Directional, wall/post, indoors/outdoors.
5. Bi-directional, ceiling, indoors.

Specifications of the radio module:

Power Output: 19.6 dBm

Operating Frequency: 906 -924 MHz

Modulation: BPSK

NOTE: The intended use of this module is not for the general public. It is generally for industry/commercial use only. This transceiver is to be professionally installed in the end product by Ingersoll Rand, and not by a third party. The Ingersoll Rand AD400 900 MHz Communication Board Module will not be sold to third parties via retail, general public or mail order. In the case of a repair, the transceiver will be replaced by a professional installer.

Federal Communication Commission interference statement

This equipment has been tested and found to comply with the limits for a Class B digital device, pursuant to Part 15 of the FCC Rules. These limits are designed to provide reasonable protection against harmful interference in a residential installation. This equipment generates uses and can radiate radio frequency energy and, if not installed and used in accordance with the instructions, may cause harmful interference to radio communication. However, there is no guarantee that interference will not occur in a particular installation. If this equipment does cause harmful interference to radio or television reception, which can be determined by turning the equipment off and on, the user is encouraged to try to correct the interference by one of the following measures:

- Reorient or relocate the receiving antenna.
- Increase the separation between the equipment and receiver.
- Connect the equipment into an outlet on a circuit different from that to which the receiver is connected.
- Consult the dealer or an experienced radio/TV technician for help.

This device complies with Part 15 of the FCC Rules. Operation is subject to the following two conditions: (1) This device may not cause harmful interference, and (2) this device must accept any interference received, including interference that may cause undesired operation.

FCC/IC caution

Any changes or modifications not expressly approved by the party responsible for compliance could void the user's authority to operate this equipment.

Industry Canada statements

Operation is subject to the following two conditions: (1) this device may not cause interference, and (2) this device must accept any interference, including interference that may cause undesired operation of the device.

To reduce potential radio interference to other users, the antenna type and its gain should be so chosen that the equivalent isotropically radiated power (e.i.r.p.) is not more than that permitted for successful communication.

This device has been designed to operate with the antennas listed below, and having a maximum gain of 9.3 dBi. Antennas not included in this list or having a gain greater than 9.3 dBi are strictly prohibited for use with this device. The required antenna impedance is 50 ohms.

Approved antenna list

Model number

23530553	1	Remote antenna, Omni, wall/post, indoors/outdoors
23530561	1	Remote antenna, Omni, ceiling, indoors
23530579	1	Remote antenna, Directional, wall/post, indoors/outdoors
23530587	1	Remote antenna, Bi-directional, ceiling, indoors

Customer Service

1-877-671-7011 www.allegion.com/us



© Allegion 2014
Printed in U.S.A.
P516-226 Rev. 03/14-d