

VON DUPRIN®

XP 98/99

Rim Exit Device



VON DUPRIN® XP98/99™ Rim Exit Device

Introduction

Balancing security and safety has always been a challenge with any panic exit device design. With the new XP98/99 Rim exit device, Von Duprin has engineered a device that reaches a new standard for security while enhancing the safety performance features. The new patented center case design takes the proven reliability of the 98/99 series and adds a new latch bolt concept that delivers the industry's highest level of latching security.

Additionally, upgrading for current 98/99 owners will be made easy and affordable. The new device will match the existing 98/99 device footprint, eliminating costly door prep changes. A new retrofit kit will allow conversion of existing 99 devices into the new XP99 function, making higher security an affordable function.

For over 100 years Von Duprin has set the standard for innovation and quality in the world of exit devices. The XP98/99 Rim device is another page in this long honored story of excellence.



Von Duprin push pad exit devices are available in two external surface styles, designated XP98 Series and XP99 Series. The two styles are mechanically and dimensionally identical and provide a wide selection of appearance options.

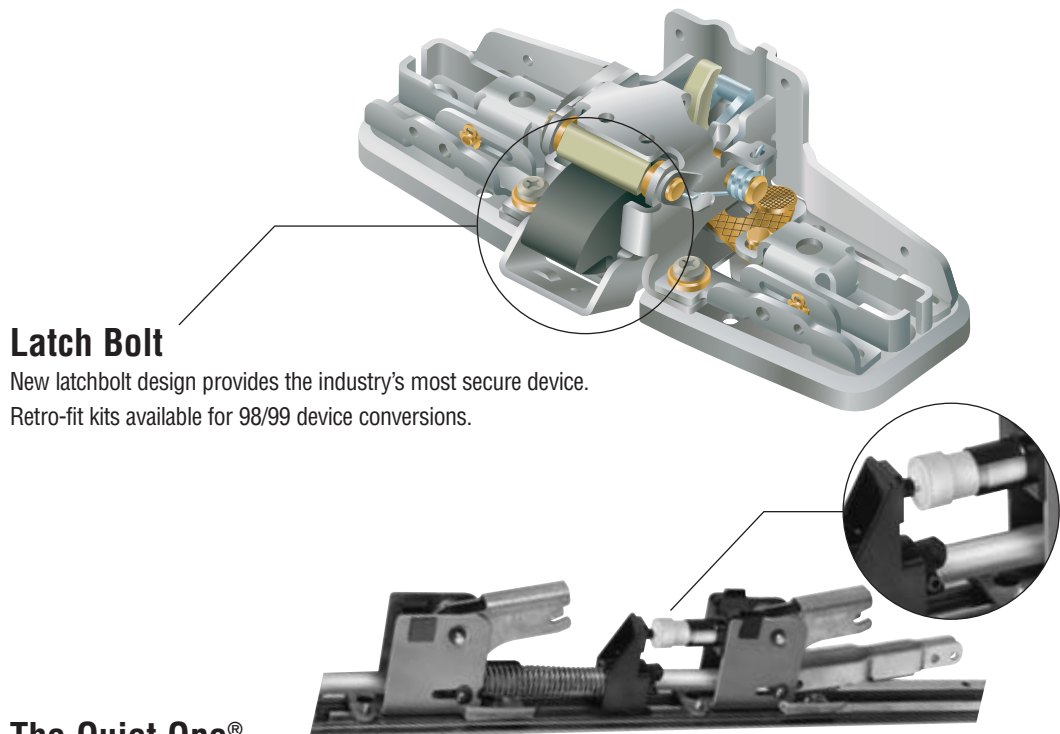

A fluid dampener decelerates the pushpad on its return stroke and eliminates most noise associated with exit device operations. Furnished on all XP98/99™ series exit devices.

VON DUPRIN® XP98/99™ Rim Exit Device



909 Strike



954 Strike
With 9854/9954
Mullion

XP98 and XP99 rim exit devices for all types of single and double doors with mullion, UL listed for accident hazard installations. Covers stock hollow metal doors with 86 or 161 cutouts.

XP98-F and XP99-F fire exit rim devices for all types of 4' x 10' (1219mm x 2438mm) single doors or 8' x 10' (2438mm x 2438mm) double doors with 9954 mullion, UL listed A, B, C, D, or E fire labeled installations.



Specifications





Device Functions	Device ships EO/DT/NL. Field selectable. For TP,K,or L remove NL drive screw from device
Device Lengths	3' 2'4" to 3' (711mm to 914 mm) Door Size 4' 2'10" to 4' (864 mm to 1219 mm) Door Size
Strikes	909 – Panic and Fire Single Door 954 — Mullion Fire
Dogging Feature	Hex key dogging standard
Dogging Options	CD Cylinder Dogging SD Special Center Case Dogging LD Less Dogging
Electric Options (Consult factory)	RX Pushpad Monitor Switch* RX2 Double Pushpad Monitor Switch* E Electric Locking & Unlocking ALK Alarm Exit Kit*
Miscellaneous Options	-2 Double Cylinder* GBK Glass Bead Kit
Fasteners & Sex Bolts (SNB)	Includes 1 3/4" (19mm) – 2 1/4" (57mm) Wood & Metal Doors Optional SNB available for device, see next page for quantities
Latch Bolt	Deadlocking, 3/4" (19mm) throw
Device Centerline from Finished Floor	39 13/16" (1011 mm) 39 11/16" (1008 mm) with Mullion
Center Case Dimensions	8" x 2 3/4" x 2 3/8" (203mm x 70mm x 60mm)
Mechanism Case Dimensions	2 1/4" x 2 1/4" (57mm x 57mm)
Projection	Pushbar Neutral – 3 13/16" (97 mm) Pushbar Depressed – 3 1/16" (78 mm)

See full-line product catalog for "How to Order" specification.

* Available Q3, 2006

VON DUPRIN® XP98/99™ Rim Exit Device Standard Trim

	Exit only	Dummy Trim Pull when Dogged	Night Latch Key Retracts Latchbolt	Night Latch Key Retracts Latchbolt Optional Pull Required
				
Product Description	XP98EO XP99EO	XP98DT XP99DT	XP98NL XP99NL	XP98NL-OP XP99NL-OP
Trim Description	—	990DT	990NL-R/V	110NL-MD 110NL-WD
Escutcheon Plate Size	—	3" x 14 ³ / ₁₆ " x ³ / ₃₂ " (76x360x2mm)	3" x 14 ³ / ₁₆ " x ³ / ₃₂ " (76x360x2mm)	—
Pull Center to Center	—	5 ¹ / ₂ " (140mm)	5 ¹ / ₂ " (140mm)	—
Projection	—	2" (51mm)	2" (51mm)	—
ANSI Function	01	02	03	03
Cylinder Type	—	—	Rim	Rim
Optional Trim (See pages 32 – 34)	x990EO x992EO x994EO x996EO	x991K-DT x992L-DT x994L-DT x996L-DT x696DT x697DT	x991K-NL x992L-NL x994L-NL x996L-NL x696NL x697NL	
Optional #425 Sex Bolt Quantity for Device	6	2	2	6

	Lever Key Locks & Unlocks	Lever – Night Latch Key Retracts Latchbolt	Lever – Blank Escutcheon Always operable (No Cylinder)	Lever Dummy Trim Pull when Dogged
				
Product Description	XP98L XP99L	XP98L-NL XP99L-NL	XP98L-BE XP99L-BE	XP98L-DT XP99L-DT
Trim Description	996L-R/V	996L-NL-R/V	996L-BE-R/V	996L-DT-R/V
Escutcheon Plate Size	2 ³ / ₄ " x 10 ³ / ₄ " x ²⁷ / ₃₂ " (70x273x21mm)	2 ³ / ₄ " x 10 ³ / ₄ " x ²⁷ / ₃₂ " (70x273x21mm)	2 ³ / ₄ " x 10 ³ / ₄ " x ²⁷ / ₃₂ " (70x273x21mm)	2 ³ / ₄ " x 10 ³ / ₄ " x ²⁷ / ₃₂ " (70x273x21mm)
Pull Center to Center	—	—	—	—
Projection	2 ⁷ / ₈ " (73mm)	2 ⁷ / ₈ " (73mm)	2 ⁷ / ₈ " (73mm)	2 ⁷ / ₈ " (73mm)
ANSI Function	08	09	—	02
Cylinder Type	Rim	Rim	—	—
Optional Trim (See pages 32 – 34)	x992L x994L	x992L-NL x994L-NL	x992L-BE x994L-BE	x992L-DT x994L-DT
Optional #425 Sex Bolt Quantity for Device	2	2	2	2