



# Innovative Access & Egress Solutions



### 1 Locking Device

- Electric Strike
- Delayed Egress Lock
- Electric Bolt Lock
- Electrified Lockset
- Exit Device
- Frame Actuator Lockset
- Magnetic Lock

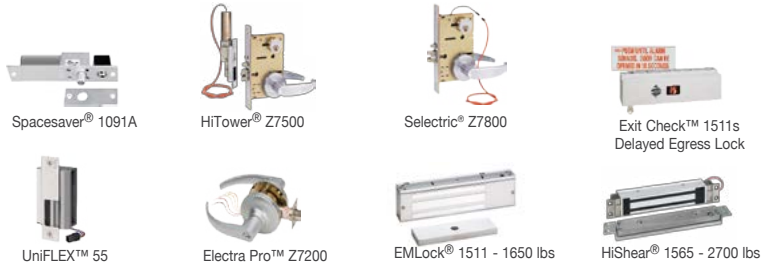

### 2 Access Control

- Standalone or Network
- Keyswitch
  - Digital Keypad
  - Card Reader



### 1 Exit Device

- Spectra® 6000
- LR100 Field Retrofit Latch Retraction & Dogging Kit
- Dual Latch Retraction & Dogging
  - Delayed Egress
  - Electric Mortise
  - Exit Alarm
  - HiTower® Actuator



### 3 Egress Control

- Exit Switch
- PIR Egress Sensor
- Exit Sense Bar
- Emergency Door Release



### 4 Hold & Release Control

- Magnetic Door Holder & Release Device

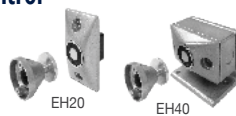

### 5 Power Transfer Devices

- Required With Locksets & Exit Devices
- Electric Power Hinge
  - Power Transfer Loop
  - Concealed Power Transfer

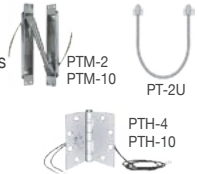

### 6 Power Supply & Door Controller

- 12/24VDC, Class 2 • Fire release input • System Status LED's • Multiple Fused Outputs • Multiple Relay Configurations • Universal Programmable Controllers

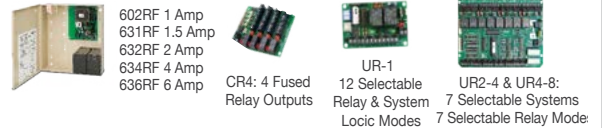

### 7 Annunciators & Controls



## shipQUICK

Over 100 SDC products are available for shipment the next business day from the SDC warehouse nearest you. Visit us at [www.SDCsecurity.com](http://www.SDCsecurity.com) and download your copy of the shipQUICK inventory so you know first hand which products SDC can expedite for you.



## Quality

SDC is a Progressive Quality Assurance™ manufacturer that practice a quality management program based on continued improvement of daily operations, product quality and customer satisfaction.

Our **Power over Ethernet (PoE) Capable Locking Hardware** is part of our earth-friendly line of low-power, energy efficient products, making them a great green solution to virtually any Access Control application. Look for the PoE Capable symbol throughout this brochure, see our separate PoE Capable Brochure, or find them at [www.SDCsecurity.com/PoE](http://www.SDCsecurity.com/PoE).

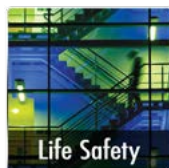
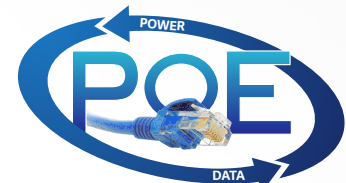

# IP-based Access Control

## Install - Expand - Control



- Embedded software
- Browser Accessible
- 1 to 32 doors



- FREE Access Control Software
- PC Accessible
- 1 to 100 doors

## IP Pro Series

- Controls one door directly, with expansion capabilities
- Entry & exit reader capability
- Supports industry standard proximity, smart card, and multi-technology readers (Wiegand output)
- Audit Trail – Up to 5,000 events may be exported as a .csv file

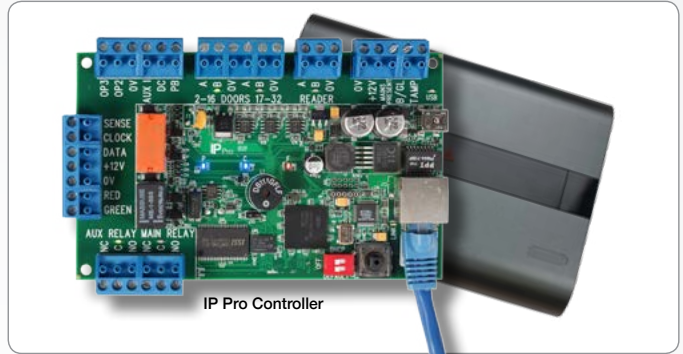

- IPDCE** IP Pro Controller board plus enclosure
- IPDC** IP Pro Controller board only
- IPDSE** IP Pro Door Station Expansion board plus enclosure
- IPDS** IP Pro Door Station Expansion board only
- IPI-30** IP Pro Injector 30W PoE+
- IPS-12** IP Pro Splitter 12VDC PoE+

**EMBEDDED**  
software managed  
via web browser



or Download **FREE**  
**SOFTWARE**  
for full Grid Access

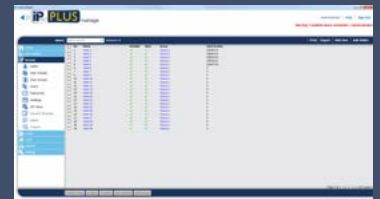

Our new PLUS PC-Client software is available as a free download to provide door access control for up to 100 doors from a single PC. PLUS is a role-based access control software suite with different interface modules, depending on user type.

**PLUS Hardware** is used by the installer to set up controllers, doors and user profiles

- Enable & edit IPPro controllers
- Create event filters
- Enable & edit door settings
- Enable e-mail notifications

**PLUS Manage** is used by system administrators to facilitate database changes required on a day-to-day basis, and offers various reporting tools

- Create, view, & edit users
- Generate user & event reports
- Add access & holiday schedules

**PLUS Server** is used by system administrators to perform specialized tasks, such as database backups, firmware updates, importing/exporting users

- Perform manual or schedule auto-matic backups
- Import/Export Users
- Perform IPPro firmware updates

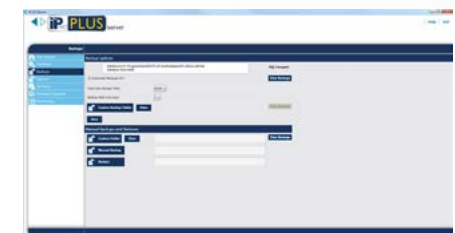
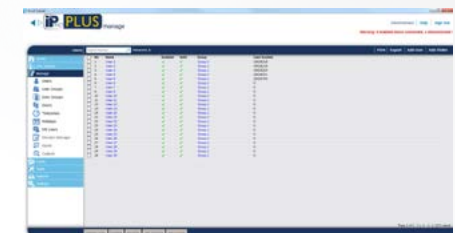
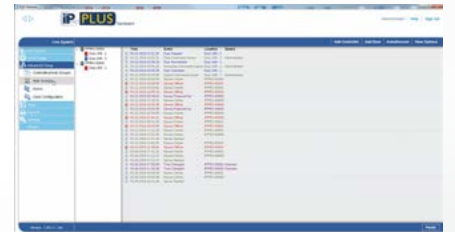

**Live System events can be monitored from either module!**

# EntryCheck® Series

The EntryCheck® series consists of stand alone digital keypads designed to control access of a single entry point for facilities. Each user is assigned a personal identification number (PIN) and/or credentials. Keypad entry of a valid four to six digit code activates one or both of the output relays which releases an electric door lock. Keypad programmable. Blue backlit cast metal keys. Prox and Wiegand options are available.

## 26-Bit Wiegand Keypads and Readers

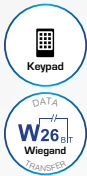

### 918W

- Indoor
- Single Gang
- Thick S.S. faceplate 3/32" (2mm)
- 3 x 4-3/4 x 1-1/2" (1/4" wall projection)
- 30mA @ 12VDC - 0.35 watts typical



### 920PW

- Indoor/Outdoor
- Surface Mount
- Heavy Cast Vandal Resistant Housing
- 3 x 5-3/4 x 1-7/16"
- 60mA @ 12VDC - 0.7 watts typical



### 923PW

- Indoor/Outdoor
- Surface Mount
- Heavy Cast Vandal Resistant Housing
- 1-3/4 x 7-3/8 x 1-7/16"
- 60mA @ 12VDC - 0.7 watts typical



### IPRW

- Indoor/Outdoor
- Surface Mount
- For Use with HID ProxCard, ProxKey Fob or Prox Tag
- 1-1/2 x 4-3/4 x 5/8"
- 40mA @ 12VDC - 0.48 watts



### IPRW300

- Indoor/Outdoor
- Mullion Mount
- Comes with choice of black and white cover
- For Use with HID ProxCard, ProxKey Fob or Prox Tag
- 1-1/8 x 3-1/4 x 5/8"
- 30mA @ 12VDC - 0.35 watts

## Standalone Keypads



### 918

- Indoor
- Single Gang
- Thick S.S. faceplate 3/32" (2mm)
- 3 x 4-3/4 x 1-1/2" (1/4" wall projection)



### 920

- Indoor/Outdoor
- Surface Mount
- Heavy Cast Vandal Resistant Housing
- 3 x 5-3/4 x 1-7/16"



### 923

- Indoor/Outdoor
- Surface Mount
- Heavy Cast Vandal Resistant Housing
- 1-3/4 x 7-3/8 x 1-7/16"

## Proximity Keypads



### 920P

- Indoor/Outdoor
- Surface Mount
- Heavy Cast Vandal Resistant Housing
- For Use with HID ProxCard or ProxKey Fob
- 3 x 5-3/4 x 1-7/16"

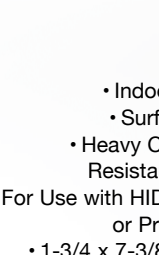

### 923P

- Indoor/Outdoor
- Surface Mount
- Heavy Cast Vandal Resistant Housing
- For Use with HID ProxCard or ProxKey Fob
- 1-3/4 x 7-3/8 x 1-7/16"

## 2-Piece Configuration



### 921P

- Indoor/Outdoor
- 2-piece, Surface Mount
- Heavy Cast Vandal Resistant Housing
- For Use with HID ProxCard or ProxKey Fob
- Keypad: 3 x 5-3/4 x 1-7/16"



### 924P

- Indoor/Outdoor
- 2-piece, Surface Mount
- Heavy Cast Vandal Resistant Housing
- For Use with HID ProxCard or ProxKey Fob
- Keypad: 1-3/4 x 7-3/8 x 1-7/16"



# EntryCheck® E70 Series Standalone Electronic Lockset

The EntryCheck® E70 Series is an indoor/outdoor standalone electronic battery powered solution, providing controlled access for basic and multi-level high security applications. Retrofits existing lock door prep with additional wire from keypad to lock. The E70 Series locksets are keypad or PC software programmable, and combine multiple access technology with efficient motorized locksets. PS version includes bluetooth enabled software.

## E75 with SDC Motorized Lock



### E70 Series Features:

- 3,000 Users
- 32 Temporary Users
- 3 Passage Mode Option
- 32 Access Groups, Schedules
- 32 Holidays
- 4 Authority Levels
- Keypad Tamper Lockout
- Mechanical Key Override
- Motorized, Battery Powered (4AA)
- Weather & Vandal Resistant
- Field Selectable Handing
- Key Latch Retraction



## E76 with SDC Motorized Mortise Lock



## E77 with SDC Rim Exit Device



### E77 Exit Device Features

- SDC S6000 Spectra series rim panic and fire rated exit device with motorized trim

## E75 with SCHLAGE Motorized Lock



### E75 SCHLAGE Lockset Features

- Motorized Schlage (ND80PD) Cylindrical Lockset with Athens Trim

# Electric Strikes



## UniFLEX™ 55 Series Universal Application Strike

For New or Retrofit Construction  
Retrofits Existing ANSI 4-7/8" Strike Prep  
No Centerline Relocation

UniFLEX™ 55 Series heavy duty electric strikes are designed for installation in hollow metal frames for access control of cylindrical and mortise locksets and mortise exit devices. The choice of 6 application faceplates eliminates the need for centerline relocation, making them ideal for new or retrofit, high security access control applications.

- 55-A** for cylindrical locksets and locksets with ANSI centerline latch entry with up to 3/4" latchbolt
- 55-B & 55-C** for mortise locksets with up to 3/4" latch
- 55-D & 55-E** for mortise locksets with deadbolt, with or without a deadlatch below the latchbolt
- 55-F** for mortise locksets with deadbolt and deadlatch located above the latchbolt



## UniFLEX™ Universal Strike 55-ABC

55-ABC Universal Strike for cylindrical locks, mortise locks without deadbolts and mortise exit devices, including:

- |                |         |
|----------------|---------|
| SDC            | Falcon  |
| Accurate       | Hager   |
| Arrow          | Marks   |
| Baldwin Best   | Sargent |
| Corbin Russwin | Schlage |
| Dorma          | Yale    |



## UniFLEX™ 45 Series Universal Strike

Multi-Application strike with three faceplates for wood, aluminum and hollow metal frames.

## UniFLEX™ 45 Series Multi-Frame-Application Electric Strike

- Centerline Electric Strike
- 4 Interchangeable Application Faceplates
- Full Monitoring is Standard, Including:
  - Latched and Unlatched Status
  - Keeper Closed and Deadlocked or Unlocked
  - Keeper Open Status Optional
- Reversible Failsafe/Failsecure, no disassembly
- 1/4" Horizontal Alignment Adjustment
- Plated Architectural Finishes Available

45F-4S Grade 1 Fire Rated Stainless Steel Strike



## 25 Series Electric Strike

The **25 Series Electric Strike** is a Centerline Latch Entry\* strike designed for use with Cylindrical lockset with up to 5/8" throw latchbolts. The compact low profile design with an internally mounted solenoid and factory supplied mounting tabs enable quick and easy installation where jamb space is limited. The heavy duty construction makes the 25 Series ideal for high traffic installations. **Not for wood applications.**



## 15 Series Electric Strike

The **15 Series Electric Strike** is a Centerline Latch Entry\* strike designed for use with Cylindrical lockset with up to 3/4" throw latchbolts. The 15 series electric strikes incorporates all stainless steel deadlocking mechanism and an internally mounted solenoid. **Not for wood applications.**

# Electrified Locksets

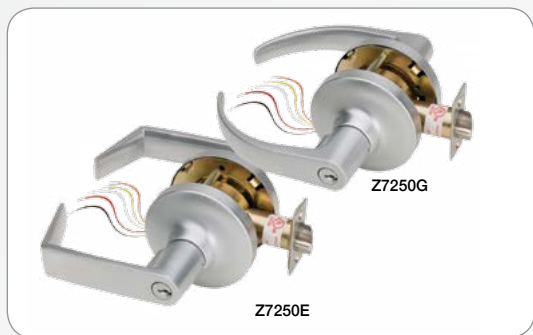

## Electra™ Pro Z7200 Series

Electra™ Pro Electrified Cylindrical Locksets are designed for the access control of openings in commercial, industrial and institutional facilities where code compliance, dependable operation and resistance to physical abuse is required, including:

- High-Rise Offices
- Hospitals
- Universities
- Museums
- Government Centers
- Airports
- Factories
- Conference Centers

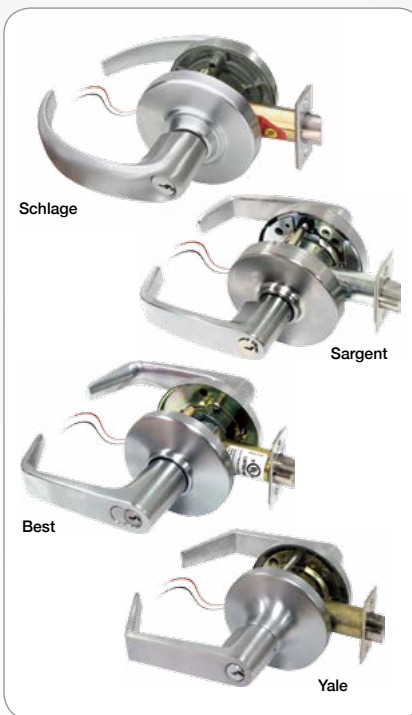

## Electra™ Mod 7200 Electrified Cylindrical Locks

Major Brand Mechanical Locks Electrified by SDC

- Schlage *ND80PD*
- Best *93K70*
- Sargent *10G04*
- Yale *5405LN*
- Dorma *C880*

The Electra™ Mod locksets are designed for the access control of openings in commercial, industrial and institutional facilities where code compliance, dependable operation and resistance to physical abuse is required.

Electrified Locksets

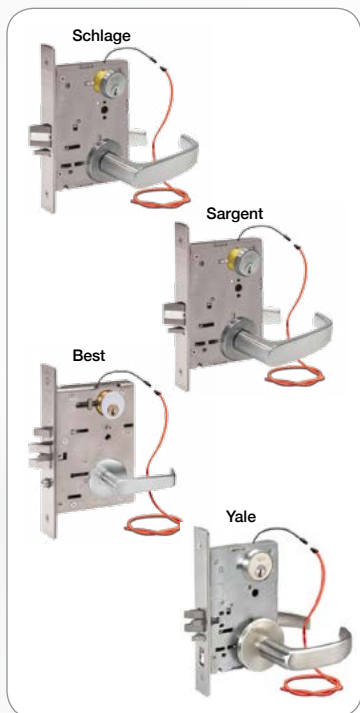

## Selectric® Mod 7800 Series

Schlage • Corbin Russwin • Best • Yale • Sargent  
Dorma • Marks • Cal Royal • Arrow • Falcon • PDQ

- For new construction or replacement of major brand mechanical locksets, your distributor simply sends the new mechanical locks to SDC for UL Listed electrification
- Field selectable mode
- Field selectable voltage
- Key latch retraction
- Field selectable handing and functions based on individual lock brand capabilities

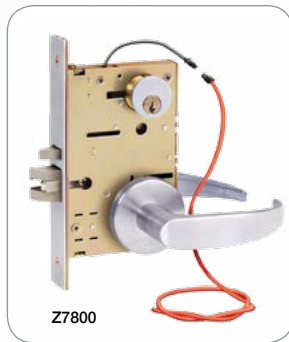

## Selectric® Pro

- Fully featured lockset with complete application flexibility for new construction or retrofit
- New or retrofit application, replaces most mechanical locks
- Field selectable mode
- Field selectable function
- Field selectable voltage
- Field selectable handing
- Key latch retraction
- Order with SDC trim or less trim. Compatible with Schlage trim provided by others.

## HiTower® 7500 Series

Frame Actuator Controlled Locksets  
Hardwire Control with no Electric Hinge and no Wires in the Door.

HiTower® locksets comply with all national and regional building codes for locking interior office, elevator lobby, exit and stairwell fire rated doors, where the use of electric strikes and magnetic locks is prohibited. HiTower® locksets also provide higher security and superior aesthetics compared to exposed and vulnerable electric strikes and magnetic locks, eliminating the need for request-to-exit devices. While providing controlled access and remote control capability the door stays latched even when unlocked, maintaining fire door integrity.

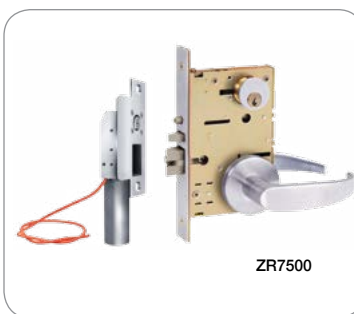

## HiTower® ZR7500 and R7500 Series

The ZR7500 HiTower® easily retrofits SDC's previous Model 5000 HiTower® door preparation or other major mortise lock brands with only a slight modification to the existing door preparation. The ZR/R7500 incorporates the same design features used on SDC's Model 7500 HiTower®.

# HiTOWER® 7500

## FRAME ACTUATOR CONTROLLED LOCKSET

### Multi-Brand Compatibility

Von Duprin • Yale • Corbin Russwin • Adams Rite • SDC • PHI  
Dor-O-Matic • IDC • Dorma • Hager • Cal-Royal • K2 • TownSteel  
Falcon • First Choice • Sargent • Arrow



### 3 Eliminate Parts & Labor

All expenses associated with power transfer hinges are eliminated, including costs for door wire chases that must be factory prepared to maintain the door's

### 4 Vandal Resistant

The built-in clutch permits the handles to operate without retracting the latch, reducing potential for damage.



### 5 Thousands

have been installed in buildings dominating city skylines worldwide.



### 1 Hardwire control with NO Electric Hinge



### 2 NO Wires thru Door



### 1973 SDC Pioneered & Patented

Since 1973 HiTower lock technology has established the standard for security, safety and performance for electric locksets.



### HiTower® Advantage

- Mechanical Lockset or Exit Device
- Electric Actuator
- Mortar Back Box available for Actuator

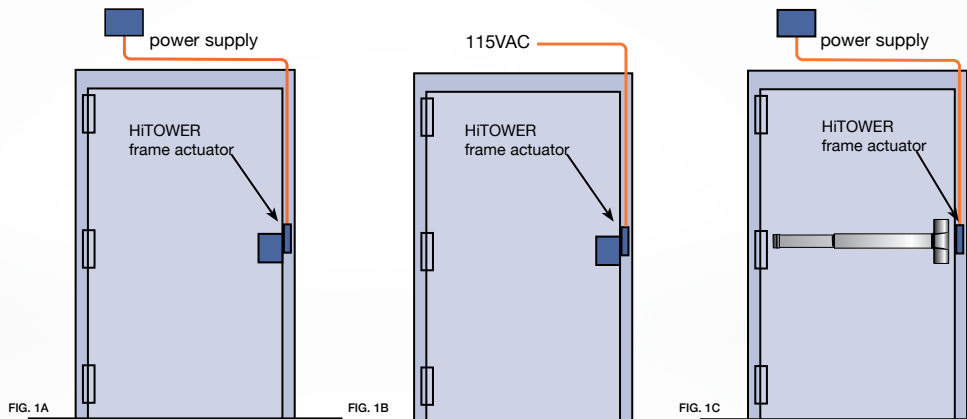

### Conventional Locksets

#### Other Conventional Electric Lockset Installation Requirements

- Electrified Lockset
- Electric Power Transfer Hinge
- Mortar Back Box for Hinge
- Wires Through Door
- Wire preparation must be made by door manufacturer to maintain fire listing.
- Lock and electric hinge must be removed for troubleshooting.

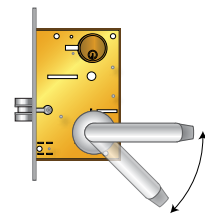
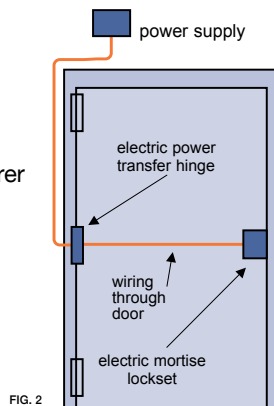

### Vandal Resistant Lever Handles Standard With SDC Brand Lockset

When locked, the built-in clutch permits the handles to operate without retracting the latch, reducing potential for damage.



# Magnetic Locks/Gate Locks

## EMLock® 1500 Series

The 1500 series EMLocks® include a lifetime warranty and are available in 650lbs, 1200lbs, and 1650lbs holding force. Compatible with any access control system, all EmLocks® are adaptable to virtually any application utilizing Top Jamb or Glass Door mounting kits. The epoxy-less design provides a superior appearance with a plated or anodized finish on all sides. The interlocking EZ mount assembly leaves hands free for wiring and securing of mounting screws. EMLocks® are UL Listed and ANSI Grade 1 compliant.

- Modular Design
- Modular Upgrade Kits
- Field Upgradable without removing from the frame
- Uniform Design & Installation
- Identical Housing, Template & Accessories
- Quick Mount Assembly



### 1510 Series Grade 1 1650 lb / 748 Kg Holding Force

- 1511 Single EMLock®
- 1512 Double EMLock®
- 1513 Single, split armature for pair of doors

Voltage: 12/24VDC Voltage Sensing Input

Single: 350mA @ 24VDC; 670mA @ 12VDC  
11" L x 2.75" H x 1-9/16"D

Double: 700mA @ 24VDC; 1.34A @ 12VDC  
22" L x 2-3/4" H x 1-9/16"D

### 1570 Series Grade 1 1200 lb / 544 Kg Holding Force 3 Watts Energy Saver

- 1571 Single EMLock®
- 1572 Double EMLock®
- 1573 Single, split armature for pair of doors

Voltage: 12/24VDC Voltage Sensing Input

Single: 125mA @ 24VDC; 250mA @ 12VDC  
11" L x 2-3/4" H x 1-9/16"D

Double: 250mA @ 24VDC; 500mA @ 12VDC  
22" L x 2-3/4" H x 1-9/16" D

### 1580 Series Grade 1 650 lb / 295 Kg Holding Force

- 1581 Single EMLock®
- 1582 Double EMLock®

Voltage: 12/24VDC Voltage Sensing Input

Single: 220mA @ 24VDC; 440mA @ 12VDC  
8-3/4" L x 2-1/8" H x 1-1/4" D

Double: 440mA @ 24VDC; 880mA @ 12VDC  
17-1/2" L x 2-1/8" H x 1-1/4" D

## EMLock® EZ Upgrade Kits

Field upgradeable by distributors, installers and maintenance staff. No need to remove a lock from the frame to upgrade or exchange internal components.

- Upgrade Modules Include:
- Relock Delay Timer
  - Door Status Sensors
  - Holding Force Upgrade
  - Magnetic Bond Sensor
  - Anti-Tamper Switch
  - Energy Saver Upgrade

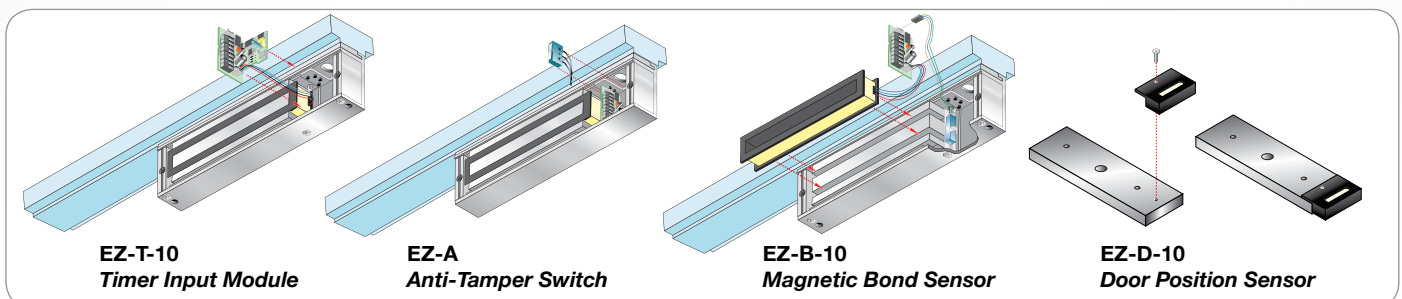

## Excel™ Series

The Excel™ product line is designed for system integrators, distributors, installers and building owners presently using low cost import or private label brand access control hardware.



**E1200**  
**Security Access Control & Mantraps**  
 1200 lb holding force magnetic lock for perimeter and interior door security. Door and lock status outputs included for remote monitoring, mantraps and system application needs.



**E600**  
**Traffic Control, Air-Locks & Communicating Bathrooms**  
 600 lb holding force magnetic lock for interior door traffic control. Door and lock status outputs included for remote monitoring, mantraps and system application needs.

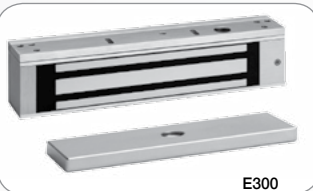

**E300**  
**Cabinets, Display Cases**  
 300 lb holding force magnetic lock for cabinets and display cases. Lock status output included for remote monitoring and system application needs.



### E6200 Magnetic Lock

**Security Access Control, & Mantraps, Indoor/Outdoor**  
 1200 lb holding force magnetic lock for exterior, perimeter and interior door security and access control. Magnetic bond sensor and door status outputs are included for remote monitoring, mantraps and system application needs.

### 350 Narrow Line Magnetic Door Lock



#### Retrofits Discontinued Locknetics 350+

350V Single Narrow Line EmLock, 1200lbs holding force  
 352V Double Narrow Line EmLock, 1200lbs holding force per door

The 350 Narrow Line Series EmLock provides 1200 lbs holding force for reliable failsafe access control of perimeter and interior doors that meets both building high security needs and fire life safety code requirements. The 350 series is specifically designed for high profile openings that require less obtrusive surface mount lock with architecturally superior appearance. LED Indicator, Magnetic Bond and Door Status outputs and Anodized Aluminum finish standard

### EP17624 EMLock Series Explosion Proof Magnetic Lock



Specifically designed for applications where flammable vapors are cause for concern, like clean room, chemical plant, or refinery environments by eliminating the sparks or arc in the magnetic lock.  
 UL listed for use in hazardous locations CLASS 1, DIVISION 2.

- Explosion Proof Epoxy Sealed to eliminate sparks
- No moving parts, virtually maintenance free
- Corrosion Proof
- Door Status Sensor
- 628 Clear Anodized Aluminum housing
- Classified for Class 1, Division 2 Hazardous Locations

EP17624 Push-side Explosion Proof EmLock® with conduit on side-block  
 EP17624TJ Pull-side Explosion Proof EmLock® with conduit on top panel includes Top Jamb mounting bracket

## Hi/Shear® Electromagnetic Lock

The Hi/Shear® is a totally concealed, high security, failsafe locking mechanism with superior appearance. The patented Hi/Shear® electromagnetic lock design incorporates a “floating” armature assembly and special alloy steel locking “tabs” on both the lock and armature assemblies, that may be adjusted both vertically and laterally to compensate for wide door gaps and warped or misaligned doors.

Hi/Shear® magnetic locks are ideal for use on commercial grade hollow metal or wood doors and frames or Herculite doors with top rails.

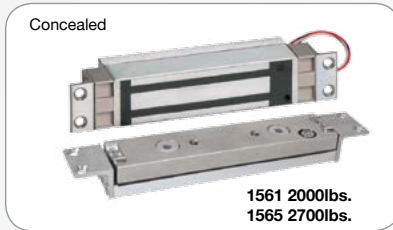

### Hi/Shear® w/ integrated electronics for standard 1¼ - 2" frames

1561 Integrated electronics, 1½" depth for 1¼" to 2" frames  
2000 Lbs Holding Force, 8" x 1-1/2" Lock

1565 Integrated electronics, 1½" depth for 1¼" to 2" frames  
2700 Lbs Holding Force, 10-7/16" x 1-1/2" Lock

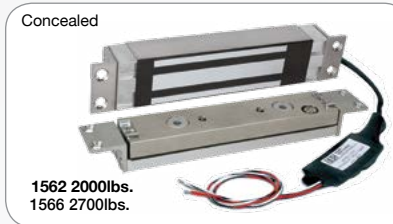

### Hi/Shear® w/ external electronics for narrow 1¼ - 1½" frames

1562 External electronics, 1¼" depth for 1¼" to 1½" frames  
2000 Lbs Holding Force, 8" x 1-1/2" Lock

1566 External electronics, 1¼" depth for 1¼" to 1½" frames  
2700 Lbs Holding Force, 10-7/16" x 1-1/2" Lock

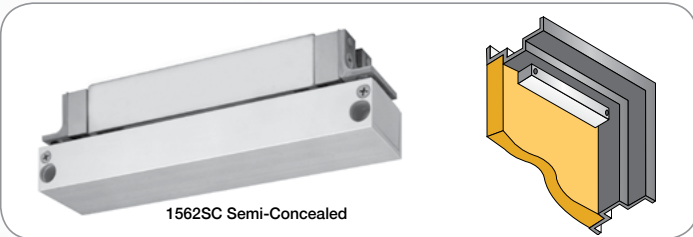
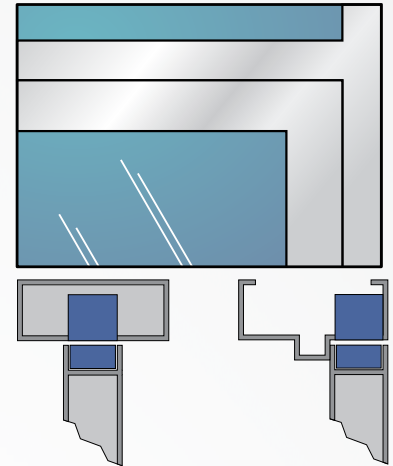

## Magnetic Door Holder



### EH Series Magnetic Door Holder & Releasing Device

EH Series magnetic door holders, are designed to hold doors open and release the door by remote switch or fire life safety command center activation. Primary application includes holding and releasing of fire rated doors that are required to provide a barrier for fire and smoke in an emergency or the convenience of door closure by remote control.

## Electric Bolt Locks

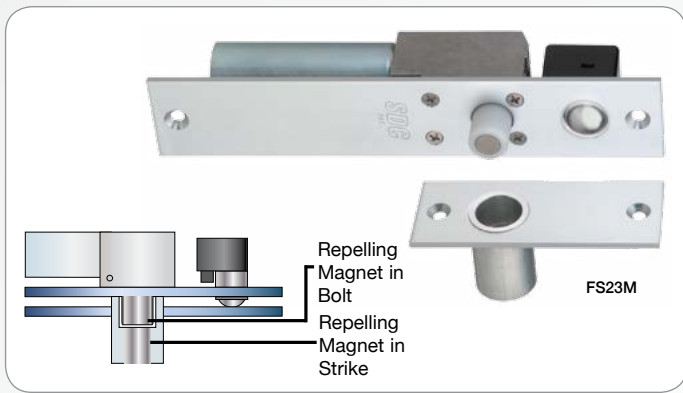

### FS23M Dual Failsafe Spacesaver® Bolt Lock

#### Dual Failsafe Spacesaver®

- CSFM Listed for locking of perimeter entry and emergency exit doors after business hours
- Tested to 1 Million Cycles
- Fully concealed and easily installed in 1.75" frame or door stile

### 1190 / 2090 Spacesaver® Bolt Locks

Heavy Duty Stainless Steel  
Fully concealed and easily installed in 1.75" (4.44cm) frame or door stile

The stainless steel bolt projects at right angles to the lock mechanism, allowing installation of Spacesaver® locks, by means of a simple cutout, in virtually any standard 1.75" frame, or in most door lock stiles. With the entire lock concealed, aesthetic acceptability is complete, security is greater and installation in old or new construction is fast, easy and economical.



### 1090 / 1290 Spacesaver® Bolt Locks

Fully concealed and easily installed in 1.75" (4.44cm) frame or door stile

The Spacesaver®, first designed and patented by SDC, is a fundamental innovation in electric locking technology for access control applications. The stainless steel bolt projects at right angles to the lock mechanism, allowing installation of Spacesaver® locks, by means of a simple cutout, in virtually any standard 1.75" frame, or in most door lock stiles. With the entire lock concealed, aesthetic acceptability is complete, security is greater and installation in old or new construction is fast, easy and economical.



### 1091ADMR / 1291ADMR Spacesaver® Bolt Locks

Electric Dead Bolt Lock PLUS Mechanical Release

The stainless steel bolt projects at right angles to the lock mechanism, allowing installation of Spacesaver® locks, by means of a simple cutout, in virtually any standard 1.75" frame, or in most door lock stiles. With the entire lock concealed, aesthetic acceptability is complete, security is greater and installation in old or new construction is fast, easy and economical.



### 100 / 200 Conventional Mortise Bolt Lock

The failsafe 110 and failsecure 210 are the most basic bolt locks available. The bolt assembly is adjustable forward up to 1" past the face plate to accommodate wide door gaps or special applications.

The failsafe 160 and failsecure 260 are equipped with an auto relock switch, that keeps the bolt retracted when the door is open and causes the door to lock when closed. The auto relock switch and the bolt assembly are both adjustable for wide door gaps.  
**NOT FOR USE IN WOOD FRAMES.**

## Cabinet Locks



### 295 Cabinet Lock

The 295 Cabinet Lock is designed to secure cabinets. The lock can be opened and closed with a key or a PIN code.

- Special Design Key locking clutch
- Red & Blue LED Status indicator
- 10 Button Keypad
- Multiple position install
- 8 digit master code & 4 digit user
- Low Battery indicator
- Battery failure override



### 290 Micro Cabinet Lock

The 290 Micro Cabinet Lock is designed to electronically secure cabinets and drawers. The need for keys is eliminated and the addition of a keypad or remote control of your choice provides true access control and convenience of use.

- Pharmaceutical cabinets and drawers
- Retail display cases and drawers
- Gun cabinets
- File cabinets
- Utility cabinets and drawers
- Museum display cases



### E300 Micro Cabinet Lock Security Made Easy

The E300 Micro Cabinet Lock is a compact specialized electromagnetic lock that produces 300lbs. of holding force. Interlocking Quick Mount Assembly makes installation easy. The E300 operating voltage is field selectable for either 12/24 VDC. Aluminum housing is standard.

## Specialty Locks



### GL160/GL260 GateLock

Electromechanical GateLock for Access Control of Tubular Steel and Wrought Iron Gates

- Higher Security than Electromagnetic Locks
- Solid Stainless Steel 0.625" diameter locking bolt
- Continuous duty operation
- Low current draw
- Auto relock switch



### Gate EMLock® 1570 Series

Electromagnetic Gate Locks  
Bond + Door Sensor Standard

SDC's Gate EMLock® provides 1200lbs of holding force and enables the access and egress control of pedestrian and vehicle gates. Access controls such as card readers, digital keypads and remote control stations provide gate and lock control.



### 180 / 280 Series Surface Mount Bolt Locks

Universal Mounting Capability  
Provides Controlled Access of  
Doors, Closets and Cabinets.

## Request-to-Exit Bars

### Sure Exit® PSB560 REX Pressure Sense Bar

Non-Latching Push Bar for

- Magnetic Lock Release
- Access Control Request-to-Exit
- Delayed Egress Trigger
- Alarm Shunt
- CCTV or Alarm Activation



### MSB550 Mechanical Switch Bar

Non-Latching Push Bar for

- Magnetic Lock Release
- Access Control Request-to-Exit
- Alarm Shunt
- CCTV or Alarm Activation

### MSB550W Weather Resistant Outdoor Mechanical Switch Bar

Non-Latching Push Bar for

- Magnetic Lock Release
- Access Control Request-to-Exit
- Alarm Shunt
- CCTV or Alarm Activation



### Outside 1575 Gate EMLock® Solutions

Inside

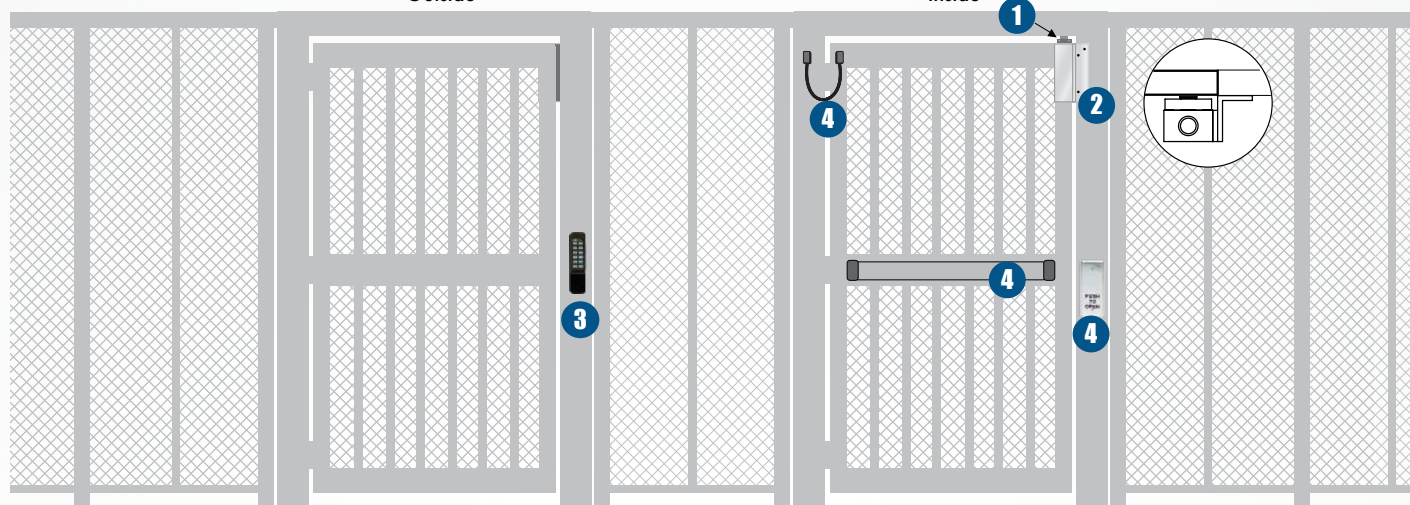

#### 1 GATE MAGNETIC LOCK

- 1575U** Gate Magnetic Lock
- 1576U** Gate Magnetic Lock with face drilled mounting

#### 3 OUTDOOR ACCESS CONTROL

- 923** Narrow Stand Alone Digital Keypad

#### 2 GATE MOUNT BRACKETS

- 1575BK / 1576-ZBV / 1576-AB / 1576-BK** Application Specific Brackets

#### 4 Request-To-Exit

- 48201U** ADA approved Narrow Mullion Push Plate Switch

### Outside 1576 Gate EMLock® Solutions

Inside

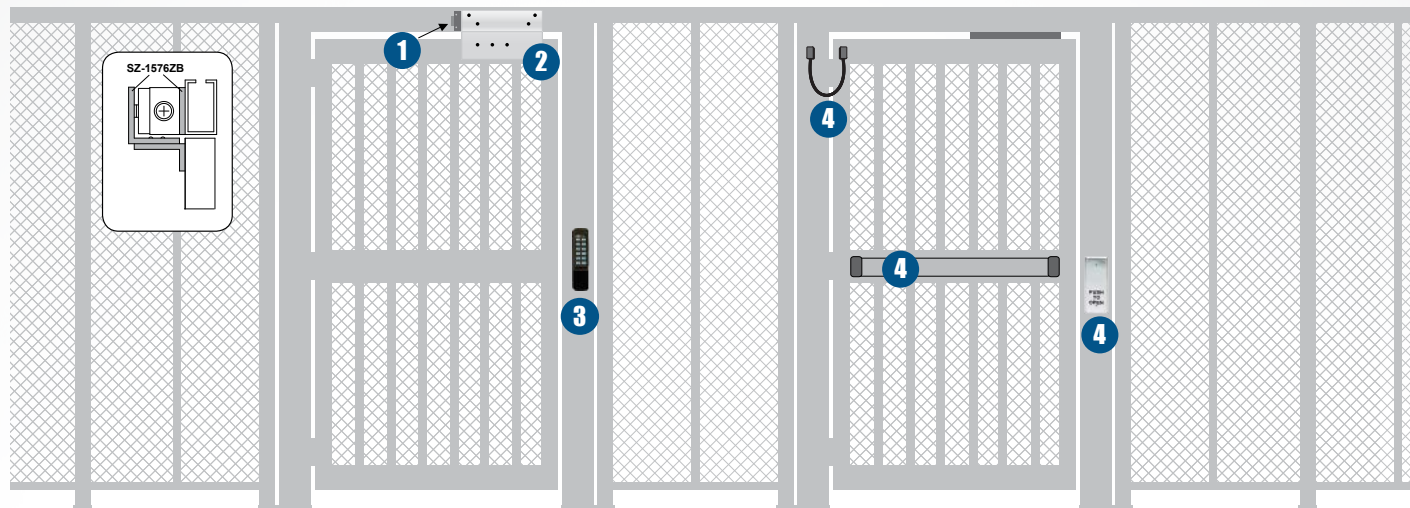

## Delayed Egress



### 1581S Delayed Egress Mini Exit Check®

- Small, Slim Design
- 650lb Holding Force

When unauthorized egress is initiated, the **Mini Exit Check®** delays egress through the door for 15 seconds. Meanwhile, the person exiting must wait while personnel or security respond. The door unlocks after 15 seconds have elapsed, permitting egress. A signal from the fire/life safety system will release the lock for uninhibited egress in an emergency.



### Exit Check® Integrated Delayed Egress Locks

- Voice and digital display provides informative annunciation for people without prior knowledge, including the blind and hearing impaired
- Field selectable voice & tone or tone only
- Voice provides warning or safety message, countdown and time of door release
- Digital countdown display also indicates if door was open after lock release.
- Fixed 15 second delay or selectable 15 or 30 second exit delay

## 101-KDE Exit Check® Delayed Egress Controller



- Stop Employee Theft
- Stop Retail Shoplifting
- Restrict Airport Patrons
- Restrict Wandering Patients

The integral verbal message, digital countdown display and sign provide comprehensive and clear instructions of the door operation for persons without prior knowledge of the exit delay, including the sight and hearing impaired. The digital keypad eliminates the need to carry and locate keys for reset and bypass functions.



## Annunciators

### Annunciators

Compatible with all Exit Check® systems, the **101 series** annunciators provide door status at a remote location such as a nurse's station, guard station or office. The tri-color LED provides precise delay mode status.



**101-1A**  
Single Door Annunciator

**101-4AM**  
Four Door Annunciator

**101-1AK**  
Single Door Annunciator with Key Control

**101-PAM**  
Single Door Annunciator with Push Switch Control

### Local Reset and Bypass

Used in lieu of the standard built-in reset and bypass, the wall mount controls provide a more accessible method of reset and bypass using the existing facility key system. All reset controls must be located adjacent to the door. (Key cylinder not included)



**708RU**  
On/Off Bypass and Reset Key Switch

**707RU**  
Momentary Bypass and Reset Key Switch

**702RU**  
Lock/Alarm Reset Key Switch

# Exit Devices

## S6000 Spectra™ Exit Devices

### Spectra Class - Specification Grade Exit Devices for superior Architectural Style & Performance

The mechanical S6000 Spectra™ series panic and fire rated exit devices are available in rim mount, mortise and surface vertical rod configurations. Spectra Class mechanical exit devices are UL listed and ANSI A156.3 Grade 1 compliant and comply with all national and state building and fire life safety codes. The SDC Spectra series exit devices have a modern look and quiet push pad operation and available in rim mount, mortise and surface vertical rod configurations.

### Rim Mount Exit Devices



- For use on single doors or pair of doors with mullion
- 1-3/4" door thickness standard. Specify thickness other than 1-3/4".
  - RHR or LHR hollow metal, wood and mineral core doors.
  - Minimum Stile Width : 4 1/2"

### Surface Vertical Rod Exit Devices



### LBR Devices - Less Bottom Rod available

S6200-LBR SVR

### Mortise Exit Device

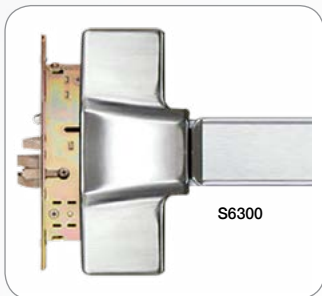

#### Mortise Lock Specifications

- Lock Case :**  
Steel plated 6-1/16" x 3-15/16" x 29/32"
- Anti-friction Latchbolt :** 3/4" throw
- Hand:** Reversible without removing the lock from the door
- Auxiliary Deadlocking Bolt :**  
Non-handed, stainless steel
- Faceplate:**  
Adjustable, 19/32" stainless steel or brass.
- Strike :** ANSI 4 7/8"

#### Device Specifications

- Device Head Cover:**  
Zinc alloy or stainless steel
- Chassis:** Steel, plated
- Housing:** Extruded aluminum
- Push Bar Base:** Extruded aluminum
- Touch Plate:** Stainless steel
- End Cap:** Zinc alloy
- Hand:** Non-handed

- Mounting:** Machine screws standard. Sex bolts optional. Order "SNB" for wood or non-reinforced metal doors
- Dogging:** Allen-type key furnished
- Finish:** Seven popular finishes
- Outside Trims:** Order separately
- UL Listed:** ANSI/BHMA Grade1 Panic Exit Hardware, 3-Hour Fire Exit Hardware.

### Electric Trim



#### Features

- Failsecure, field reversible to failsafe
- Audible tone
- 4 ft. cable and connectors
- Nightlatch function
- 12/24VDC @ 600/300 mA

### REMOVABLE MULLION

The removable Mullion is used with two Rim Devices on double doors.



### Latch and Deadbolt Monitoring Strikes

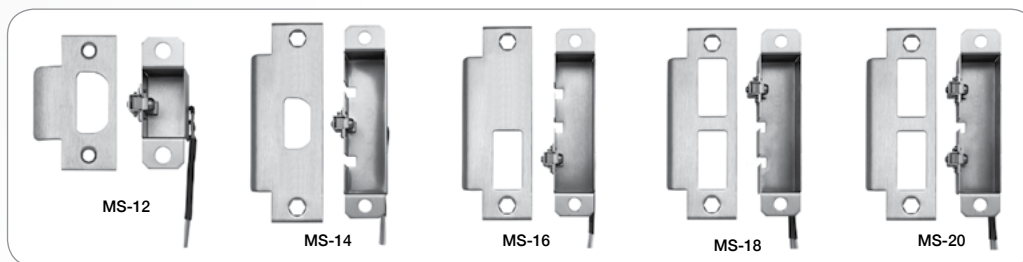

- Compatible with:**
- Cylindrical locksets
  - Mortise locksets
  - Deadbolts
  - Mortise locksets with deadbolts

#### Applications:

- Latchbolt status - Deadbolt status
- Alarm shunt - Alarm activation
- Mantrap communication
- Common bath door communication

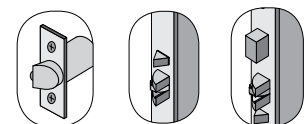



## Delayed Egress ALL-IN-ONE Option

When unauthorized egress is initiated by depressing the push pad of the S6000-101, an audible alarm will sound and an irreversible delay period of 15 seconds will begin. After the delay period has expired, the device unlocks, permitting egress until the device is reset. In a life safety emergency, the device will immediately unlock upon loss of power or when powered by a fire control supervised power supply.



### 101 Delayed Egress All-in-One

- Low Power consumption 540 mA @24VDC
- 15 second exit delay, 1 or 2 second nuisance delay
- Built-in Visual and Audible Annunciation
- Single or pair of doors
- Key reset, bypass
- Field-selectable 1 to 30 second request-to-exit, anti-tailgate and door prop alarm
- UL Listed

## Exit Alarm Option



- A** Exit Alarm, 9V battery powered
- B** Exit Alarm, 12-24V AC/DC input, 9V battery backup
- 100 dB alarm; visual and audible On/Off status: Armed - green LED blinks every 4 seconds, Alarm mode - red LED, Bypass - no LED
- Remote status output
- 15 or 60 second arming delay
- 2 modes: Continuous alarm with manual key reset; Automatic re-arm 2 minutes after door closes with any manual key reset before 2 minutes.

### Options

- REX and latch status outputs



## Electric Latch Retraction Option



### E Electric Latch Retraction

- Operation:** Momentary or maintained latch bolt and push pad retraction, with simultaneous dogging. Automatic re-triggering of latch retraction
- Voltage:** 24VDC @ 700 mA activation, 200 mA continuous
- Monitoring Available** Latch status and REX output available



## Delayed Egress Option



### DE Delayed egress exit device

Electrification of master exit device and wall mount controller with keypad control and reset

- User PIN codes may be assigned to 1, 2 or all control functions.
- Reset, sustained bypass and momentary bypass (REX)
- Selectable nuisance
- Audible alarm voice release time, warning or safety message
- Visual display countdown, locked/unlocked, egress executed

## Electric Dogging Option



### G Electric Dogging

When energized by optional built-in or remote switch manual, depressing the pushpad, causes the pushpad and latch to remain retracted (unlocked) providing push-pull door operation. When de-energized or signaled by a fire alarm, the pushpad and latch are released.

**Voltage** 170/100 mA @ 12/24VDC

**Monitoring Available** Latch status and REX output available

## HiTower Option

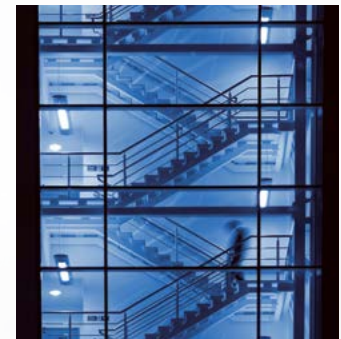
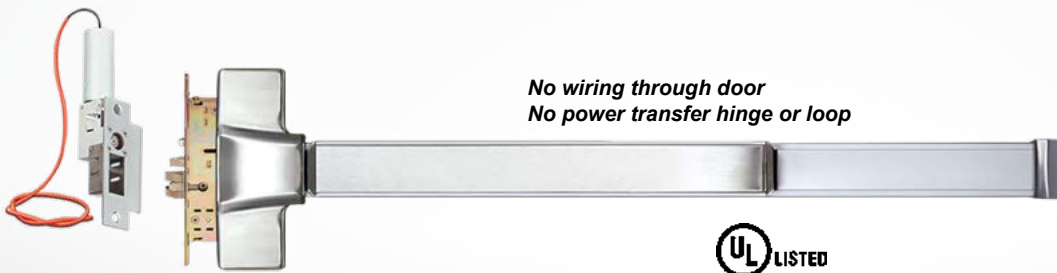

### H Hitower Pro Frame Actuator Controlled Fire Exit Device

Features include failsafe operation and unlocks by access control, power loss or signal from fire command center. Door stays latched even when unlocked. All wiring is maintained in the strike jamb. Complies with national building and fire codes

**Specify Handing and Voltage:** 24VDC, 24VAC, 115VAC

## Electric Mortise Option

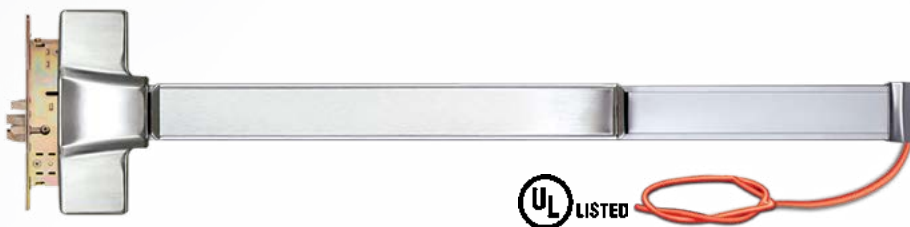

### M Electric Mortise Exit Device

- Field reversible failsecure/failsafe.
- Remains latched when unlocked for fire door integrity
- Failsafe (F) fire rated device for stairwell doors
- Power loss or signal from fire command center releases failsafe device immediately

**Voltage** 600/300 mA @ 12/24VDC

# Electrified Exit Devices

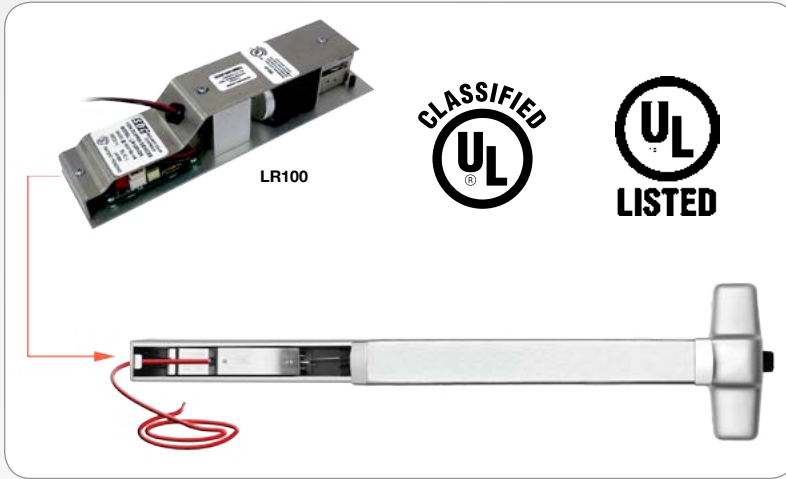

## Quiet DUO™ ELR Field Modification Kit

The SDC LR100 Series Electric Latch Retraction Kit enables electric access control and dogging of mechanical exit devices. When energized the motor retracts the exit device latch and pulls the pushpad into the dogged (depressed) position enabling momentary or sustained push and pull operation of the door.

The latch retraction mechanism may be activated by an access control, remote control device or building automation system. The exit device always provides uninhibited egress.

- Low 700 mA Inrush, 200 mA Continuous @ 24VDC
- For access control and sustained dogging applications
- Simultaneous latch retraction and dogging (pushpad depressed\*) for most exit devices
- Pushpad is depressed\* electrically for quieter push / pull operation
- Automatic re-trigger if device does not pull on first try

Retrofits most major brands:

- |              |        |                  |               |           |
|--------------|--------|------------------|---------------|-----------|
| • Von Duprin | • Yale | • Corbin Russwin | • Dor-O-Matic | • Hager   |
| • Stanley K2 | • IDC  | • TownSteel      | • Dorma       | • PHI     |
| • Detex      | • SDC  | • Tell           | • Cal Royal   | • Sargent |
| • Arrow      | • PDQ  | • Marshall Best  | • Adams Rite  | • Falcon  |

Also available: IP100 Series Electric Latch Retraction Kit - 12V version for IP use

(see PoE Solutions Catalog for more info)

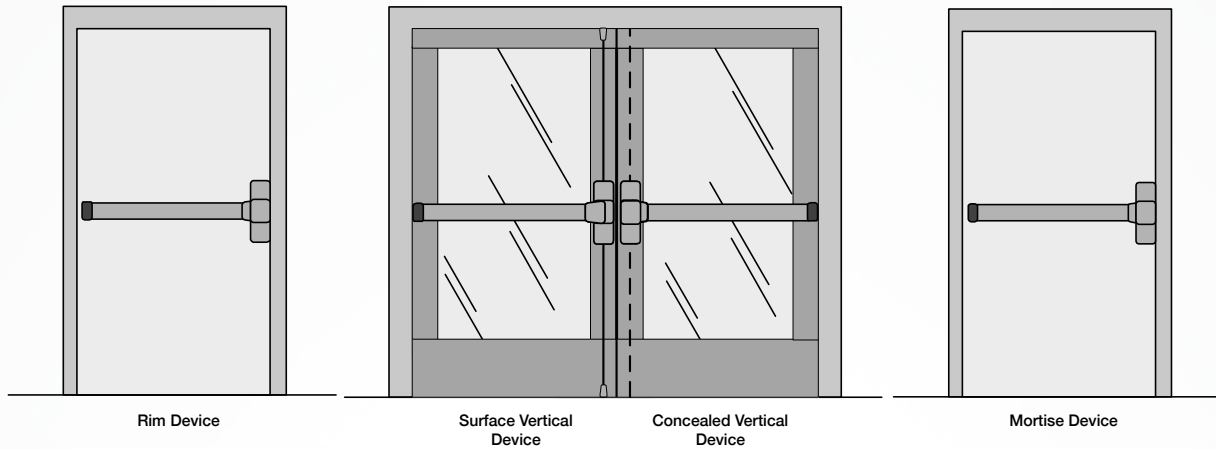

Electrified Exit Devices

## Power Transfer Accessories



### Concealed Electric Power Transfer

**PTM Heavy Duty Series**  
Electric Power Transfer Device

SDC's heavy duty Electric Power Transfer Device provides a concealed and secure means of transferring electric lock and exit device power and signal wires from the frame to the door. Completely concealed when the door is closed the PTM Electric Power Transfer Device is ideal for heavy traffic and applications requiring higher security to inhibit tampering and abuse.

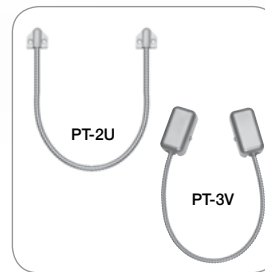

### Power Transfer Loops

18" stainless steel armored flex conduit with small plastic end caps or termination box. Recommended for use with hollow metal and aluminum frames.  
**PT-2U** With end caps  
**PT-3V** With aluminum wire termination box

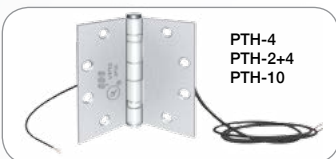

### Power Transfer Hinge

- UL10B Listed for 3 Hr Fire Doors. If the hinge you are presently using does not bear the F mark, it is not listed for use with fire doors.
- 500,000 cycles. 5 times UL test criteria
- Wire Replacement Warranty
- 5ft wire cable



### Fire Rated Concealed Mortise Power Transfer

**PT-5** Concealed Mortise Mount Power Transfer Loop Frame mortised steel dust box with flexible steel loop and chrome finish. Recommended for use with hollow metal frames. UL Listed

## Key Switches/Exit Switches



### 474U Touchless Exit Switch

The 474U uses IR Sensor technology, the device is active with the simple wave of a hand. Designed to control electric looks/ strikes, magnetic locks, or automatic door openers. It is ideal for use in sanitary applications, such as cleanrooms, bathrooms, food processing, hospitals and labs, and features a sensing range of up to 4". The Switch is mounted on a durable stainless steel plate, with dual LED illuminated sensors indicating the status. The quick connect screwless terminal block ensures easy installation.



### 463U Piezoelectric Exit Switch

The 463U is a heavy duty vandal resistant exit switch designed for indoor, outdoor, commercial and industrial egress applications. Constructed of stainless steel and utilizing piezoelectric technology, the 463U exit switch is ideal for harsh or high traffic conditions. The weather and vandal resistant design ensures superior performance in virtually any environment.



### 430 Series Mushroom Exit Switch

The 430 Heavy Duty Industrial series incorporates a 1 1/2" round mushroom button with heavy duty contacts. The assembly is capable of withstanding high impact and is ideal for heavy duty high frequency use. Green Button Standard.



### 410 & 420 Series



The illuminated switch button is two inches square for easy activation and is visually conspicuous. The high impact resistant material stands up to abuse. The "PUSH to EXIT" sign complies with NFPA requirements. The 422A is designed for access and egress applications for the disabled.

- 1 Gang:
- 2" Illuminated Button, Stainless Steel Narrow:
- 1 3/4" x 1" Illuminated Button, Stainless Steel

Key Switches/Exit Switches



### 450 Vandal Resistant Series

The 450 Series incorporates a 1/4" thick aluminum faceplate and an all stainless steel button. The assembly will resist the impact of a hammer blow. In addition, security spanner mounting screws are concealed by tamper resistant aluminum plugs to inhibit tampering.



### 440 Heavy Duty Series

The conspicuous 440 Heavy Duty Industrial series switch assemblies incorporates a 2 5/8" inch diameter mushroom button and heavy duty water resistant contacts. The large 2 gang mushroom assembly includes a heavy duty steel bezel around the button to guard against abuse. When utilized as an Exit or REX switch, the assembly is easy to activate and stands out for persons without prior knowledge of egress operation.

In addition to egress applications, the large assembly is ideal as an easy to activate Emergency/Panic Alarm switch.



### PIR Egress Sensor

The MD31D PIR request-to-exit sensor unlocks doors automatically when persons approaching door are detected. The MD31D complies with national fire and building code requirements for Access Controlled Egress Doors listed above. Code compliant failsafe mode releases locks when power to PIR sensor is interrupted.

## Key Switches

SDC key switch assemblies provide an economical method of providing authorized control for a variety of applications. A choice of several contact configurations ensure compatibility with virtually any system.

- Access Control
- Automatic Gate Operation
- Roll Up Door Operation
- Alarm Shunt
- Alarm Reset
- Machine Operation

### 700 Series Key Switches

- Spanner security screws and tool
- 20 Gauge stainless steel
- Optional plated finishes
- Cylinder not included

- 700** Single gang, wall mounted, anti-tamper recessed key cylinder
- 700N** Narrow 1.75" wide, frame mounted
- 700T** Two Gang, 4 Security screws, 20 Gauge stainless steel Two gang faceplate provides for the use of a larger junction box to accommodate time delays, audible annunciation and increased wiring.

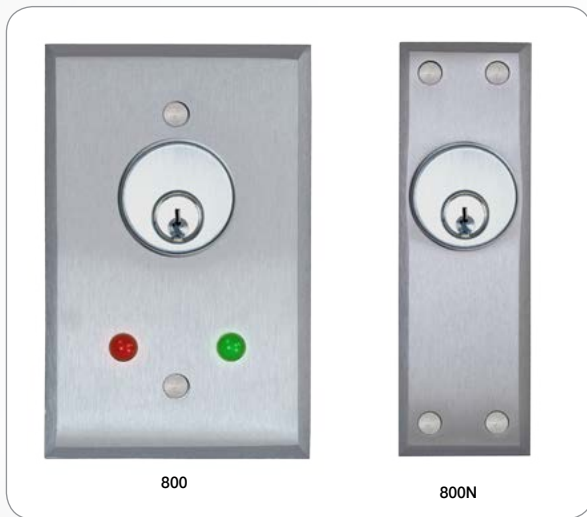

### 800 Series Heavy Duty Key Switches

- 0.25" Aluminum faceplate
- Spanner security screws and tool
- Anti-tamper plugs for mounting screws
- Anti-tamper recessed key cylinder
- Cylinder not included

- 800** Single gang, wall mounted
- 800N** Narrow, 1.75" wide frame mounted
- Four mounting screws provide increased integrity

## Consoles

### MODULAR CONSOLES FOR MANUAL CONTROL AND STATUS MONITORING

The **TCC** and **RCC** Series of Control Consoles provide a flexible, economical method of centrally supervising and controlling multiple openings within a facility. Available in several configurations, the TCC and RCC Consoles allow monitoring of door and lock status, as well as control of electromagnetic EMLocks, Bolt Locks, Electrified Mortise Locks, Shear Locks, Delayed Egress Systems, Electric Exit Devices and Electric Strikes. The modular design of the console allows for the selection of the specific functions required by simply selecting panels with the desired status and control features.

- DTMO** Mini slope front desk top console
- TCC** Slope front desk top console  
12 stations maximum when using 2 control panels. Base unit, less panel.
- RCC** Rack mount console.  
24 stations maximum when using three control panels. Base unit, less panels.



# Specialty Switches



## 491 Emergency Break Glass Station

The 491 Emergency Door Release Break Glass Station provides immediate unlocking of perimeter doors or interior doors that are equipped with fail-safe electric locks. The 491's built in alarm may be used as a local door annunciator.

The 491 is specifically designed for emergency door release and may influence the approval of an electric locking system. This type of Emergency Door Release may be preferred over a pull station since greater commitment is required to break the glass.

## 492 Emergency Pull Station

The 492 Emergency Door Release Pull Station provides immediate unlocking of perimeter doors or interior doors that are equipped with fail-safe electric locks. The 492's built in alarm may be used as a local door annunciator.

The 492 is specifically designed for emergency door release and may influence the approval of an electric locking system.



## Communicating Bathroom System Controls

For a common single bathroom shared by two patient rooms or dormitory rooms, the CB400A controls provides privacy and ensures that both doors are locked only when the bathroom is occupied and unlocked when the bathroom is not occupied. The CB400B controls provide emergency access by facility staff. Both doors unlock when signalled by the fire life safety system.

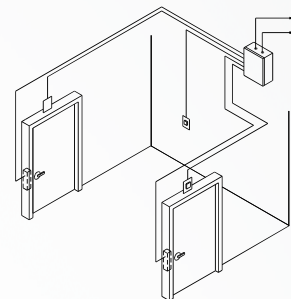

# Annunciators

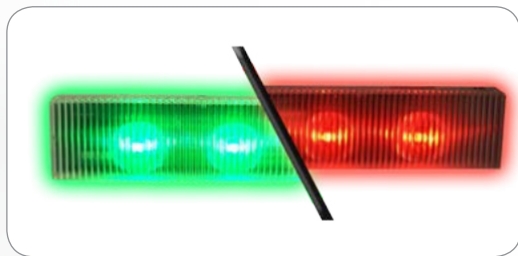

## EA100 Exit Annunciator™ Bar

The Exit Annunciator™ is a highly visible multi-color signal device, that interfaces with Delayed Egress or standard EMLocks and can be used as a wall, ceiling, or frame mount indicator.

**Dimensions:**  
8-3/4" x 1-1/2" x 3/4"  
**Electrical:**  
12/24 VDC @ 80/100mA max power,  
Long life LED output

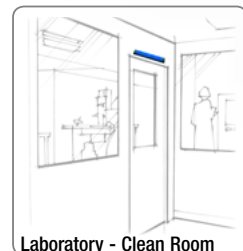
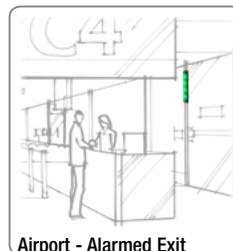
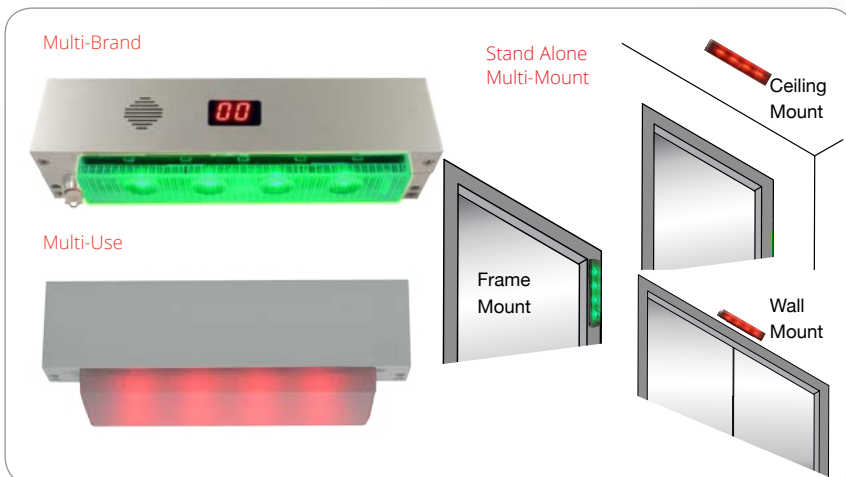
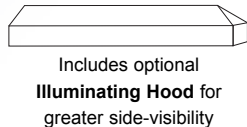



[SPDT] 48201U [DPDT] 48401U      482A1U [SPDT] 484A1U [DPDT]



[SPDT] 48202U [DPDT] 48402U      482A2U [SPDT] 484A2U [DPDT]



[SPDT] 48204U [DPDT] 48404U      482A4U [SPDT] 484A4U [DPDT]



[SPDT] 48206U [DPDT] 48406U      482A6U [SPDT] 484A6U [DPDT]



[SPDT] 48204RU [DPDT] 48404RU      482A4RU [SPDT] 484A4RU [DPDT]



[SPDT] 48206RU [DPDT] 48406RU      482A6RU [SPDT] 484A6RU [DPDT]



[SPDT] 482AA9 [DPDT] 484AA9

482AA36 [SPDT] 484AA36 [DPDT]

## 480 Series PUSH PLATE SWITCHES Wireless and Hardwired



For Handicap Access, Automatic Door Activation & Request-to-Exit Applications

- Door Opener Activation
- Access Control Request-to-Exit (RTE)
- Automatic Door Activation
- Door Sequencer Activation

**482A1U/482O1U** 1-11/16" Narrow Mullion Push Plate Switch – Recessed, Surface Box or Bollard Mount

**482A2U/482O2U** 2 3/4" x 4 1/2" Single (1) Gang Push Plate Switch

**482A4U/482O4U** 4 1/2" x 4 1/2" Square Push Plate Switches

**482A6U/482O6U** 6" x 6" Square Push Plate Switch

**482A4RU/482O4RU** 4 1/2" Round Push Plate Switch

**482A6RU/482O6RU** 6" Round Push Plate Switch

**482AA9/484AA9** 9" x 6" Ingress-R.E.X Touch Panel Column

**482AA36/484AA36** 36" x 6" Ingress-R.E.X Touch Panel Column

## Wireless Transmitter & Receiver



For Remote Control Versatility for Touch Panel Column and Push Plate Switches.

75 foot wireless range. Less barriers.

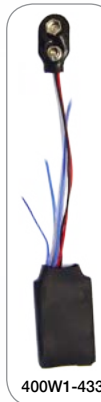

400W1-433

**400W1-433**  
**433MHz Micro Transmitter**

- Requires a non-metallic surface box or standard bollard cap (non-metallic)
- Pre-Wired for quick installation
- Antenna magnifies signal
- Dimensions: 1-9/64" x 15/16" x 7/32"
- Works with 400RC433

**400RC433**  
**433MHz 1 Channel Nano Receiver**

Designed to control automatic closing and features code-hopping technology for increased security.

- Carrier Frequency: 433.92 MHz
- Power Supply: 12/24 VAC/DC
- Relay Numbers: 1; Contacts: C-NO
- Dimensions: 1-1/4" x 2" x 3/4" Deep
- Works with 400W1-433



400RC433



## Bollard Post for Push Plate Or Touch Panel



Alternative to wall mounted access control or switches for entry doors. Bollard post provide visibility and meet accessibility guidelines. Practical solution for surface mount or in-ground installation.

- BPS6** 42" surface mount, 6" square post
- BPG6** 54" in-ground, 6" square post

## Low Energy Swing Door Operator

### Auto EntryControl™

SDC's Auto EntryControl™ Swinging Door Operator provides hands-free, low-power, point of entry door control with safe and reliable, electro-mechanical drive and slim-line design. The state-of-the-art microprocessor-based unit is self-tuning and self-learning while offering non-handed operation, full mechanical stops and a variety of interface options for sensors, push-plates, fire alarms and electrified locks.



- AUTO136V** PUSH Operator for 36" Door Opening, Alluminum
  - AUTO236V** PULL Operator for 36" Door Opening, Alluminum
  - AUTO336V** Operator for 36" Door Opening, (1) PULL arm, (1) PUSH arm, Alluminum
- Also available for 42" and 48" Door Openings as Single Operator - and 72", 84" and 96" Door Openings as Double Operator - Dark Bronze Powder Coat color option available

## Door Prop Alarm

### EA Series Door Prop Alarm

Improve security with a cost-effective door prop alarm. All SDC door prop alarms feature audible sirens with adjustable timer settings, two outputs, bypass status indicator light, and vandal-resistant aluminum construction. Available to install in single gang or double gang enclosures, SDC door prop alarms also offer optional Keylock and Mortise Cylinder Reset/Bypass Switches.



- EA-SN** Door Prop Alarm, Single Gang w/ integral Status LED & Audible Alarm
- EA-728V** Double Gang w/ integral Status LED, Audible Alarm & Keylock Switch for Reset/Bypass
- EA-708V** Double Gang w/ integral Status LED, Audible Alarm & Mortise Key Cylinder Switch for Reset/Bypass, Cylinder not included.

## Wireless Remote Control

### WRC Wireless Remote Control 2-Channel Transmitter & Receiver

SDC's WRC Series 2-Channel wireless transmitter/receiver solution is specifically designed to be used as a receptionist button or remote release for single or dual door access control applications. Receiver has the capacity to learn up to 30 fixed transmitter codes using the onboard learning button and status LED.



- WRC-R2** 433MHz Two-Channel Wireless Receiver
- WRC-2B** 433MHz Two-Button Pendant Wireless Transmitter

- Transmits and Receives at 433.92MHz Frequency
- Transmitter operates with WRC-R2
- Transmitter features Pendant Keychain type housing
- Receiver includes 12", 8-Wire Pigtail for Quick Installation
- Capacity to learn up to 30 Transmitters codes per Receiver unit via onboard Learning Button and Status LED
- 4 field-selectable Operation Modes:
  - Timed (3s): Remote button "A" activates relay "A" for 3 seconds (fixed); remote button "B" activates relay "B" for 3 seconds (fixed). Both relays may be activated at the same time.
  - Toggle: Pressing remote button "A" activates relay "A". Relay "A" remains active until remote button "A" is pressed again; Pressing remote button "B" activates relay "B". Relay "B" remains active until remote button "B" is pressed again. Both relays may be activated at the same time.
  - Manual (M) (default): Pressing remote button "A" activates relay "A". Relay "A" remains active only while remote button "A" is pressed; Pressing remote button "B" activates relay "B". Relay "B" remains active only while remote button "B" is pressed.
  - Latching (L): Pressing either remote button activates its respective relay. The relay remains active until the other remote button is pressed, activating its respective relay.



# Power Supplies Control Modules

## 600 Series Modular Access Control Power Supply

Field Selectable 12VDC or 24VDC Output - Standard  
 Fire Alarm Interface - Standard  
 Dual 12VDC and 24VDC Output - Optional  
 California Compliant Manual Release Optional

All SDC power supplies are equipped with a high performance transformer and highly reliable electronic components. Filtering and output voltage regulation provide protection and ensure the longevity of all system components. With the addition of SDC programmable controllers or relay modules, the user-friendly modular designs ensure versatility, interface capability and easy installation of electric locking devices, access controls and related safety equipment.

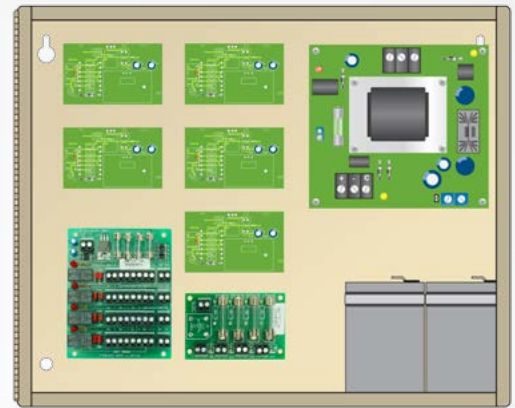

### 602RF 1 Amp Power Supply

602RF 1 Amp power supply  
 12"W x 12"H x 4"D cabinet



### 631RF 1.5 Amp Power Supply

631RF 1.5 Amp Power Supply, 12"W x 12"H x 4"D  
 631RFA 1.5 Amp Power Supply, 16"W x 14"H x 6.5"D

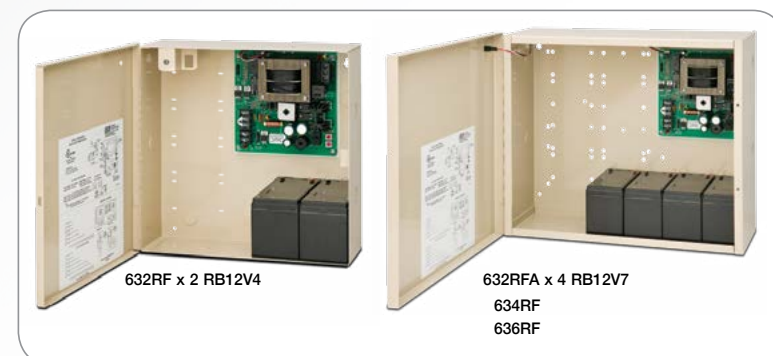

### 632RF 2 Amp Power Supply

632RF 2 Amp Power Supply, 12"W x 12"H x 4"D  
 632RFA 2 Amp Power Supply, 16"W x 14"H x 6.5"D

### 634RF 4 Amp Power Supply

634RF 4 Amp Power Supply, 16"W x 14"H x 6.5"D  
 One 4 Amp output and  
 two 2 Amp Class 2 outputs standard

### 636RF 6 Amp Power Supply

636RF 6 Amp Power Supply, 16"W x 14"H x 6.5"D  
 One 6 Amp output and  
 three 2 Amp Class 2 outputs standard

## Door Control Modules

Door control relay modules ensure compatibility of access hardware components and simplify system installation and troubleshooting. Different modules may be specified for one power supply.



FB-4 Multiple Fused Output



UR-1 Universal Relay Module



EMC Sequencer for pair of doors

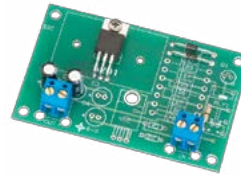

12VR Voltage Regulator



CR4 Four Station Relay Module



ACM-1 Access Control Module



PB-16 16 Amp Power Booster  
PB-8 8 Amp Power Booster



PSM Power Supply Remote Monitoring Module



### Seven Day Timer

14-2 (24V) or 14-2-12 (12v)  
Input: 30mA, specify 12V or 24V AC/DC  
• SPDT dry contact, 16 Amps @ 30VDC  
• 2.375"H x 2.375"W x 1.25"D



### Universal Module Enclosure

UME Single module enclosure  
Universal mounting standoffs will accommodate FB-4, UR-1, 12VR, ACM-1, PB-16, PB-8, PSM, 621B, or LR100EM boards.  
Box Dimensions: 5-5/8"H x 7-11/16"W x 3-3/8"D

## Universal Door Controller Modules



UR-1

### UR-1

Universal Controller for 1 or 2 doors.  
12 Field Selectable Relay & System Logic Modes.  
2 form "A" SPST, N.O. Inputs, 2 form "C" SPDT outputs 5 Amps, 12/24 @ 120/175mA.



UR2-4

### UR2-4

Universal Controller for 2 doors.  
Field select TD, LR, TD/LR, mantrap, interlock. Two fused SPDT outputs, 5 Amp @ 30VDC.  
Two SPDT outputs, 5 Amp @ 30VDC.  
Two inputs per station, four auxiliary inputs.

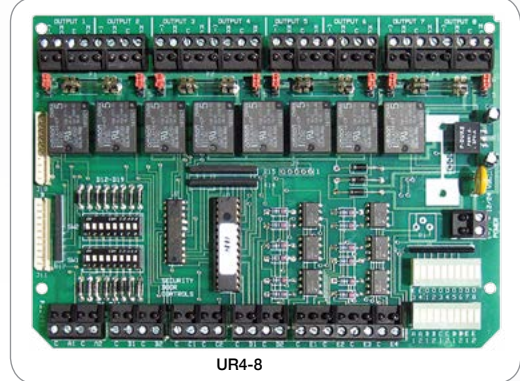

UR4-8

### UR4-8

Universal Controller for 4 doors.  
Field select TD, LR, CR, TD/LR, mantrap, interlock.  
Four fused SPDT outputs, 5 Amp @ 30VDC.  
Two inputs per station, four auxiliary inputs.

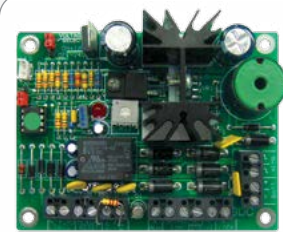

621B



621P



621PJ

## 621 Series 1 Amp Power Supply

### Economy Access Control Power Supply

The 621 Series access control power supplies are designed to support access controls and electric locking devices. Equipped with two power limited outputs, the modular design enables versatility for installations with or without battery back-up or fire command center interface for emergency lock release.

**621B** Power supply module, 1 Amp 12/24VDC, Class 2 Input requirements: 40VA @ 24VAC

**621P** Power supply module, 1 Amp, 12/24VDC, Class 2 with UL Listed plug-in transformer.

**621PJ** Power supply module, 1 Amp, 12/24VDC, Class 2 with UL Listed plug-in transformer and metal enclosure.

**621P-UME** Power supply module, 1 Amp, 12/24VDC, Class 2 with UL Listed plug-in transformer and Universal Module Enclosure (UME).

## System Design Services



SDC's Access & Egress Control Solutions have been known as *"The Locks Behind the System™."* With our System Design Services, we are also *"The System Behind Your Locks™."*

Comprehensive services are available with the purchase of SDC locks, controller and power supply for a minimum of 2 - 4 door openings, and a basic design fee. From the basic system to a complex multi-door project, you'll receive a proficient engineered system package detailed to fit your specific needs.

### Eliminate the Usual Problems

- Improperly planned or missing components
- Lack of system function detail
- Mismatched wiring spec's & diagrams
- No component identification and inventory list
- Mismatched components
- Guaranteed Integration Compatibility

### Communicating Bathroom Applications

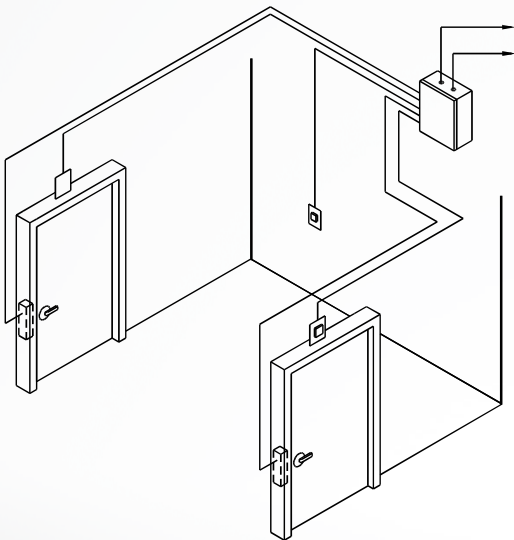

### Shared Patient Rooms or Dormitory Rooms

Provide privacy and ensure both doors are locked only when the bathroom is occupied and unlocked when the bathroom is not occupied. Emergency access control for facility staff is provided, and both doors unlock when signalled by the fire life safety system.

### Interlock & Mantrap Applications

#### Darkrooms, laboratories, clean rooms, x-ray or other treatment rooms, light and air trap rooms and more

All doors remain closed and unlocked. Opening any door causes the other doors to lock until the opened door returns to the closed position. A key switch is provided for system activation and deactivation.

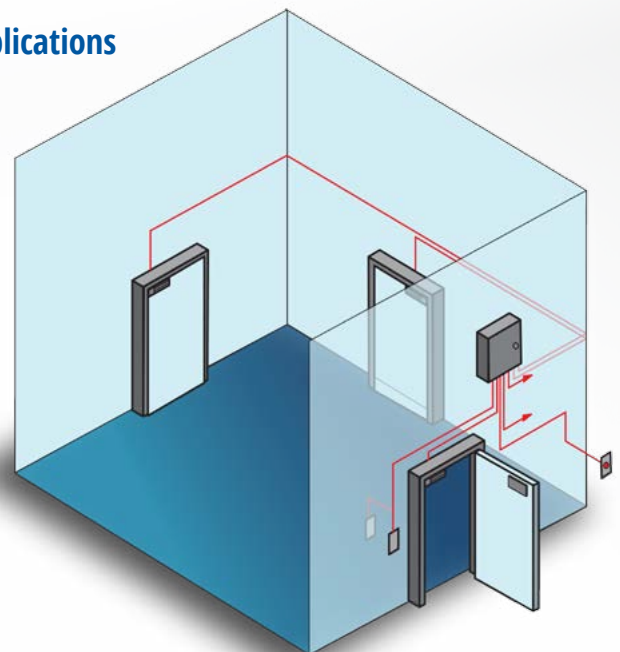

# DELIVERY



**Reduce Time-In-Transit & Shipping Costs:** The ShipQUICK inventory is available from two regional warehouses. Over 200 SDC products are available for shipment by the next business day.

# MODIFICATIONS



# RETROFIT



# SYSTEM DESIGN



# OEM



# LOCKING HARDWARE



# LIBRARY



Providing Quality Service To The Industry  
For Over 40 Years



Proud member of

