



Glass Solutions 2017 PRICE LIST

Brought to you by ASSA ABLOY

The global leader in
door opening solutions

ASSA ABLOY

Table of Contents

Door Rails

Top Rails	6
Bottom Rails	6
Door Rail Accessories	7

Sidelite Glazing Hardware

Sidelite Rails	8
U Channels	9-10
Sidelite / U Channel Accessories	11

Headers

2-Piece Headers	12
Solid Headers	12
Floating Headers	13
Header Accessories	13

Patch Fittings

For $\frac{3}{8}$ " Glass	14
For $\frac{1}{2}$ " and $\frac{9}{16}$ " Glass	16
Patch Accessories	17

Panic Devices

Panic Device	18
Panic Strikes	18-19
Accessories	19

Sliding Door Hardware

Sliding Systems	20
-----------------------	----

Door Pulls

Decorative Pulls	21-22
Standard Pulls	23

Door Controls

Floor Closers	24
Overhead Concealed Closers	25
Pivots	26
Operators	27

Mechanical Locking Hardware

Locking Pulls	28
Center Housings	29
Cylinders	29
Mortise Locks	30-31
Deadbolts	31

Electrified Hardware

Digital Lock	32
Mag Locks	32
Accessories	33
Readers	33
Power Supplies	33





The Beauty of Glass

As the industry leader in door security, innovation, and design, ASSA ABLOY offers a complete line of commercial hardware solutions for interior glass door applications including: patch fittings, door rails, architectural pulls, mechanical and electrified locking products. Our Glass Solutions program allows the convenience of placing a single order and dedicated technical and customer service experts.

Tested in our state-of-the art BHMA certified lab, our products meet the most rigorous testing standards.

Prices Effective June 1, 2017

Copyright © 2017, Rockwood Manufacturing Company, an ASSA ABLOY Group company. All rights reserved.
Reproduction in whole or in part without the express written permission of Rockwood Manufacturing Company is prohibited.

ASSA ABLOY

The global leader in
door opening solutions

Glass Solutions Program Information

The ASSA ABLOY Glass Solutions program allows the convenience of placing a single order from multiple ASSA ABLOY brands.

Customer Service/Technical Product Support
 For Glass Solutions questions please contact us via phone or email. Customer Service: 855-594-6989, CustomerService.GlassSolutions@assaabloy.com
 Technical Product Service: 855-594-6989, TechSupport.GlassSolutions@assaabloy.com

Orders

Orders can be submitted online, emailed, or faxed to:
 Online: <http://extranet.assaabloydss.com/> and select Order Entry under the Customer Service Menus
 Email: Orders.GlassSolutions@assaabloy.com
 Fax: 844-851-8665

Mixed Orders

For your convenience your Glass Solutions order can be combined with other Rockwood products. If your order contains items that are not included in either the Glass Solutions or Rockwood product line it will be omitted from your order and not shown on the acknowledgement.

Prices

This price list cancels and supersedes all prior listings. We reserve the right to decline portions or the entirety of an order. All accepted products will be shown on the order acknowledgement with the current pricing. Pricing is subject to change without notice.

Terms and Conditions of Sale

Terms: 1% 15 days, net 30 days
 Remit Payment To: PNC Bank/Rockwood, PO Box 644489, Pittsburgh, PA 15264-4489

Lead Time

Lead times will vary. Orders containing stock items will ship within 48 hours of order acknowledgment. Lead times for non-stock items will change based on complexity and quantity. Standard stock rails and headers will ship within 72 hours. Products such as the glass panic device will ship within approximately 10 days. Expected ship dates will be listed on the acknowledgment.

Part Numbers

Our part numbers were designed to facilitate ease of ordering and ensure all products are tied to the coordinating job. Each part number specifies the product family, glass thickness (if applicable) and finish.

Glass Thickness Codes

Part numbers include a letter which identifies glass thickness or range of thickness compatible with that item. For example part numbers containing "AC" can be used on glass thicknesses ranging from $\frac{3}{8}$ " to $\frac{9}{16}$ ".

Glass Thickness	Size Code	Finishes Codes**		
		US	ANSI/BHMA	Description
$\frac{3}{8}$ "	A	28	628	Clear Anodized Aluminum
$\frac{1}{2}$ "	B	314	N/A	Extra Dark Anodized Aluminum
$\frac{9}{16}$ "	C	(314E)	N/A	Extra Dark Anodized Equivalent
$\frac{5}{8}$ "	D*	32D	630	Satin Stainless Steel
$\frac{11}{16}$ "	E*	32	629	Bright Stainless Steel
$\frac{3}{4}$ "	F*			
$\frac{13}{16}$ "	G*			

*Currently not available. Product in development.

**Special finishes considered upon request.

Door Rail Deducts		
Rail	Deduct	Bite
2 $\frac{3}{4}$ "	2"	$\frac{3}{4}$ "
4"	3 $\frac{1}{8}$ "	$\frac{7}{8}$ "
6"	4 $\frac{5}{16}$ "	1 $\frac{11}{16}$ "
8"	8 $\frac{5}{16}$ "	1 $\frac{11}{16}$ "



The global leader in door opening solutions

Prices Effective June 1, 2017

Copyright © 2017, Rockwood Manufacturing Company, an ASSA ABLOY Group company. All rights reserved. Reproduction in whole or in part without the express written permission of Rockwood Manufacturing Company is prohibited.

TERMS AND CONDITIONS

Freight Policy

All prices are F.O.B. Rockwood, Pennsylvania. Full Freight prepaid will be allowed on shipments of \$1,000 net and over, within the continental United States. All shipments are routed least expensive method. All shipments that exceed 108" in packaged length must be shipped LTL. Shipments by Air, Parcel Post, Bus or Express are F.O.B. factory with no freight allowance. Handling charges on UPS, Air Freight, or common carrier shipments may apply. We reserve the right to designate the carrier.

Special Order Material

Items made to your specifications (not stock items) are not returnable. These items are not subject to cancellation without consideration of expense involved at the cancellation date.

Returned Goods

Return no merchandise without written permission from the factory. Authorization will insure proper credit. Errors in shipping may occasionally occur. If this is the case immediately notify the factory, and we will gladly make the proper adjustments. If the error is at the customers end, a minimum charge of 25% plus freight will be incurred. Unauthorized claims for labor or charges will not be allowed. No credit will be allowed beyond six months after invoice date.

Claims

Inspect before you sign! If there is a shortage or damage, accept the shipment only after freight agent makes a damage or shortage notation on your freight bill, bill of lading, or delivery receipt. If damage or loss is evident notify your freight agent and request inspection with 10 days of receipt of goods. Claims must be made within 30 days of shipment and are subject to approval. Claims made after 30 days are not honored. Responsibility for damage, visible, or concealed, ceases upon delivery to the transportation company.

Shortages

Claims for shortages must be made within 30 days of the invoice date.

Samples

Saleable samples will be charged at regular prices.

Templates

Commonly used templates are available on our website at www.assaabloypass.us

WARRANTY - ASSA ABLOY Rockwood & Glass Solutions Products

ASSA ABLOY (in Rockwood, PA) warrants that its products sold under the ASSA ABLOY trade name in the United States of America are free from defects in workmanship and materials under normal use and service. This warranty does not cover defects or damage arising from improper installation, lack of or improper maintenance, improper storage, corrosion, erosion, ordinary wear and tear, misuse, abuse, accident, unauthorized service, other causes beyond ASSA ABLOY's control, or use with unauthorized non-ASSA ABLOY products or parts.

The following instances void warranty:

- Expose to air pollutants including, but not limited to acid rain, chemicals, salt, or fumes.
- Failure or settling of the structure/building/ foundation.
- Repairing or re-finishing the hardware without consensus of the manufacturer.
- Any modification or dissembling of the warranty product, regardless of whether the modification causes or contributes to the alleged defect.

The only liability of ASSA ABLOY (in Rockwood, PA) in tort or contract whether under this warranty or otherwise, shall be limited to the repair, replacement, or refund of the original purchase price of the product or component that is alleged to be defective at ASSA ABLOY's discretion. The warranty period starts at the delivery date to the original purchaser and extends by the duration listed below. Any repair or replacement of a component does not extend the warranty period past the original period.

Items cross listed in ASSA ABLOY Glass Solutions fall under the original manufacturing company's warranty. Items listed solely in the Glass Solutions product offering have a two year limited warranty. The PDU8000 series features a three year limited warranty.

Purchaser should contact ASSA ABLOY (in Rockwood, PA) upon receipt of any product claimed to be defective. If an in-plant inspection is necessary, purchasers should obtain a Return Goods Authorization and then send the product freight paid to ASSA ABLOY (in Rockwood, PA.) If, upon inspection, the product is determined by ASSA ABLOY (in Rockwood, PA) to be defective within the guidelines of this warranty, ASSA ABLOY (Rockwood, PA) will promptly repair or replace the defective product.

In the event of an acceptance of Purchaser's Purchase Order by ASSA ABLOY (in Rockwood, PA), the Purchaser agrees that such acceptance is solely conditioned on Purchaser's acceptance of the terms and conditions set forth in this instrument, regardless of the terms and conditions specified in Purchaser's Purchase Order. The terms and conditions in Purchaser's Purchase Order which conflict with the terms and conditions of this instrument shall be disregarded and are hereby rejected, and this instrument shall constitute the entire agreement between ASSA ABLOY and the Purchaser.

THIS WARRANTY IS IN LIEU OF ALL OTHER EXPRESS WARRANTIES. TO THE EXTENT PERMITTED BY LAW, ALL IMPLIED WARRANTIES ARE LIMITED TO THE DURATION OF THIS WARRANTY. ASSA ABLOY (IN ROCKWOOD, PA) SHALL NOT BE LIABLE FOR ANY INCIDENTAL OR CONSEQUENTIAL DAMAGES. NO AGENT, SALES REPRESENTATIVE OR DEALER HAS THE AUTHORITY TO INCREASE OR ALTER THE OBLIGATIONS OF THIS WARRANTY.

ASSA ABLOY

The global leader in
door opening solutions

Door Rails



Door Top Rail with End Load OHC Arm (24" to 48")				Finish			
Part # (Add Finish)	Profile	Height	Glass Sizes	32D/630	32/629	28/628	314
DRS-275AC-TA	Square	2 3/4"	A - C	397.00	457.00	323.00	355.00
DRS-4AC-TA	Square	4"	A - C	323.00	372.00	210.00	231.00
DRT-4AC-TA	Tapered	4"	A - C	323.00	372.00	210.00	231.00
DRS-6AC-TA	Square	6"	A - C	436.00	501.00	418.00	460.00
DRS-10AC-TA	Square	10"	A - C	742.00	854.00	616.00	678.00

Door Top Rail with WB Pivot Insert (24" to 48")				Finish			
Part # (Add Finish)	Profile	Height	Glass Sizes	32D/630	32/629	28/628	314
DRS-275AC-TI	Square	2 3/4"	A - C	414.00	476.00	332.00	365.00
DRS-4AC-TI	Square	4"	A - C	302.00	347.00	188.00	207.00
DRT-4AC-TI	Tapered	4"	A - C	302.00	347.00	188.00	207.00
DRS-6AC-TI	Square	6"	A - C	447.00	514.00	397.00	437.00
DRS-10AC-TI	Square	10"	A - C	721.00	830.00	595.00	655.00

Door Bottom Rail with Adjustable End Load Bottom Pivot (24" to 48")				Finish			
Part # (Add Finish)	Profile	Height	Glass Sizes	32D/630	32/629	28/628	314
DRS-275AC-BP	Square	2 3/4"	A - C	372.00	428.00	298.00	328.00
DRS-4AC-BP	Square	4"	A - C	300.00	345.00	188.00	206.00
DRT-4AC-BP	Tapered	4"	A - C	300.00	345.00	188.00	206.00
DRS-6AC-BP	Square	6"	A - C	445.00	512.00	395.00	435.00
DRS-10AC-BP	Square	10"	A - C	719.00	827.00	616.00	678.00

Door Bottom Rail with 6275/6280 Floor Closer Arm (24" to 48")				Finish			
Part # (Add Finish)	Profile	Height	Glass Sizes	32D/630	32/629	28/628	314
DRS-275AC-BA*	Square	2 3/4"	A - C	388.00	446.00	314.00	345.00
DRS-4AC-BA	Square	4"	A - C	314.00	361.00	201.00	221.00
DRT-4AC-BA	Tapered	4"	A - C	314.00	361.00	201.00	221.00
DRS-6AC-BA	Square	6"	A - C	459.00	528.00	409.00	450.00
DRS-10AC-BA	Square	10"	A - C	731.00	841.00	628.00	691.00

Door Rail Cladding Only (24" to 48") (Price Per Piece)				Finish			
Part # (Add Finish)	Profile	Rail Height		32D/630	32/629	28/628	314
DRS-275-CL*	Square	2 3/4"		46.60	53.60		
DRS-4-CL	Square	4"		38.50	44.20		
DRT-4-CL	Tapered	4"		38.50	44.20		
DRS-6-CL	Square	6"		56.70	65.20		
DRS-10-CL	Square	10"		121.00	140.00	88.90	97.80
Add for Hole Prep for Lock, Pull, Panic Device, or Closer Alignment						25.00	
Add for Offset Pivot Prep						60.00	

Note: 35 3/4" (single) and 35 13/16" (double) length door rails are in stock.

*Not compatible with bottom rail lock.

ASSA ABLOY

The global leader in
door opening solutions

Prices Effective June 1, 2017

Copyright © 2017, Rockwood Manufacturing Company, an ASSA ABLOY Group company. All rights reserved.
Reproduction in whole or in part without the express written permission of Rockwood Manufacturing Company is prohibited.

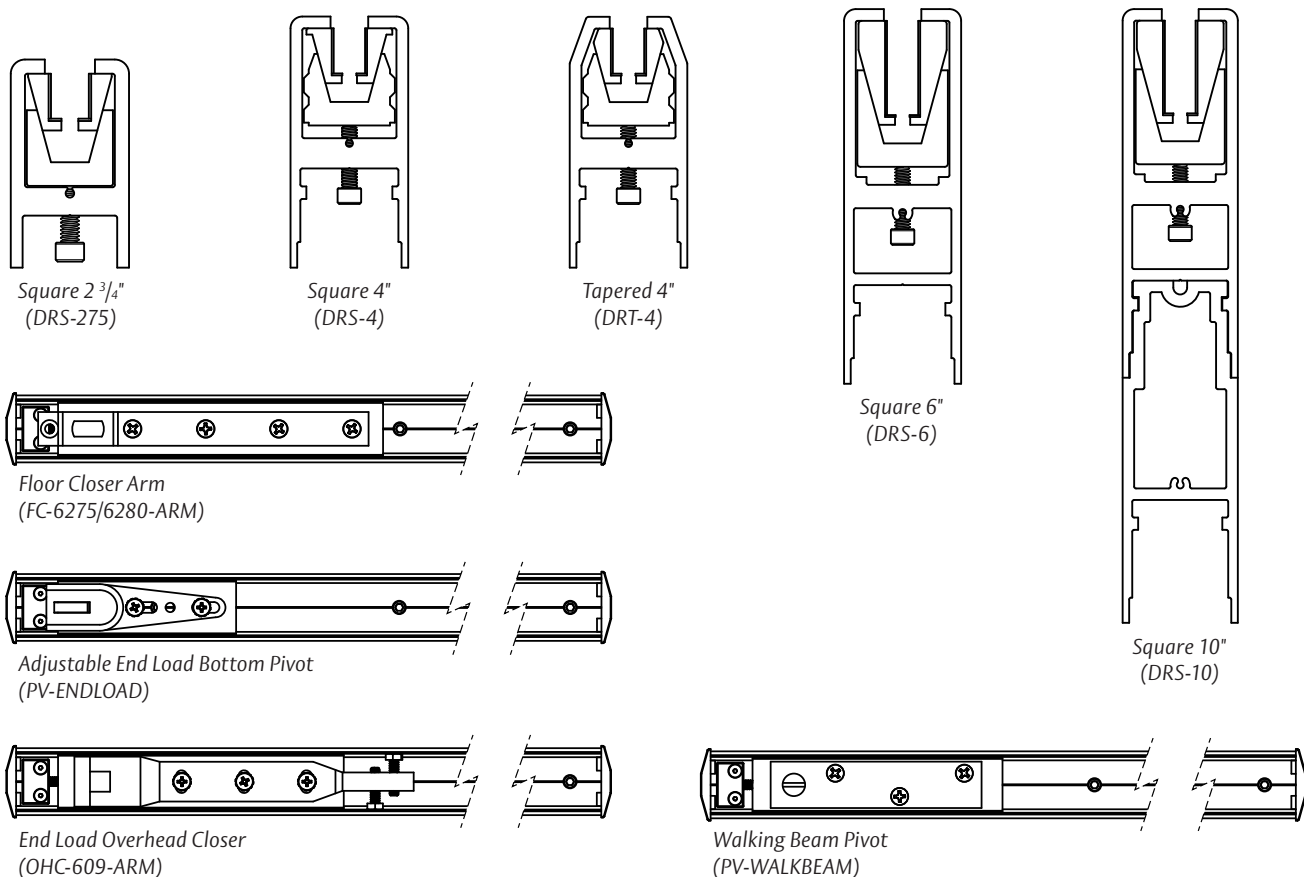

Door Rail End Caps Only		Finish				
Part # (Add Finish)	Profile	Height	32D/630	32/629	28/628	314
ECDS-275AC	Square	2 3/4"	32.70	37.60	16.30	18.00
ECDS-4AC	Square	4"	26.90	31.00	12.50	13.80
ECDT-4AC	Tapered	4"	26.90	31.00	12.50	13.80
ECDS-6AC	Square	6"	57.70	66.40	52.90	58.20
ECDS-10AC	Square	10"	78.90	90.70	65.40	72.00

Door Rail Compatible Parts		Finish			
Part # (Add Finish)	Description	32D/630	32/629	28/628	314
PV-WALKBEAM	Walking Beam Pivot	53.70	61.70	53.70	59.00
DR-BTMLOCK	Non-Installed Bottom Door Rail Lock	37.00			
DR-LOCKCYL	1" Cylinder	24.00	24.00	24.00	24.00
DR-LOCKTT	1" Thumbturn	24.00	24.00	24.00	24.00
PV-ENDLOAD	Adjustable End Load Bottom Pivot	38.50		Satin AL	
PV-ADJBLCK	Pivot Adjuster Block	24.00		Mill	
Part # (Add Finish)	Description		26D/626	26/625	314E
570	Dust Proof Strike		24.00	24.00	26.00

Adders (Price Per Rail)	32D/630	28/628
	32/629	314
Offset Pivot Prep	100.00	75.00
Panic Prep	75.00	75.00
SAM Mag Prep & Install	75.00	75.00
Competitor Mag Prep	160.00	160.00
Bottom Lock Prep & Install	60.00	50.00
Pull Prep	50.00	35.00
Rixson Alignment Hole Prep	50.00	35.00
Weather Strip Installed	125.00	125.00
Auto Operator Prep	175.00	160.00

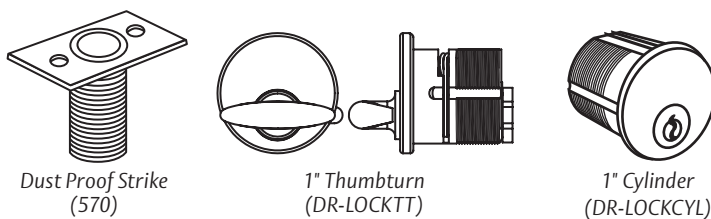

ASSA ABLOY

The global leader in door opening solutions

Prices Effective June 1, 2017

Copyright © 2017, Rockwood Manufacturing Company, an ASSA ABLOY Group company. All rights reserved. Reproduction in whole or in part without the express written permission of Rockwood Manufacturing Company is prohibited.

Sidelite Glazing Hardware



Bottom Sidelite Rails with Gasket (Price Per Foot)

Part # (Add Finish)	Profile	Height	Glass Sizes	Finish			
				32D/630	32/629	28/628	314
SRS-275AC-B	Square	2 3/4"	A - C	66.40	76.30	34.40	37.90
SRS-4AC-B	Square	4"	A - C	56.70	65.30	33.40	36.70
SRT-4AC-B	Tapered	4"	A - C	59.60	68.60	34.40	37.90
SRS-6AC-B	Square	6"	A - C	75.00	86.30	38.60	42.40
SRS-10AC-B	Square	10"	A - C	124.00	143.00	55.30	60.80

Pricing includes saddle, pre-fit gasket, and setting blocks – specify saddle height and glass thickness.

Top Sidelite Rails with Gasket (Price Per Foot)

Part # (Add Finish)	Profile	Height	Glass Sizes	Finish			
				32D/630	32/629	28/628	314
SRS-275AC-T	Square	2 3/4"	A - C	61.60	70.80	29.20	32.10
SRS-4AC-T	Square	4"	A - C	51.90	59.70	28.10	31.00
SRT-4AC-T	Tapered	4"	A - C	54.80	63.00	29.20	32.10
SRS-6AC-T	Square	6"	A - C	70.20	80.70	33.40	36.70
SRS-10AC-T	Square	10"	A - C	119.00	137.00	50.00	55.10

Pricing includes 1/8" saddle and pre-fit gaskets – specify glass thickness.

Sidelite End Caps (Each)

Part # (Add Finish)	Profile	Height	Finish			
			32D/630	32/629	28/628	314
ECSS-275AC	Square	2 3/4"	37.90	43.50	18.90	20.80
ECSS-4AC	Square	4"	31.20	35.90	14.50	15.90
ECST-4AC	Tapered	4"	31.20	35.90	14.50	15.90
ECSS-6AC	Square	6"	66.80	76.80	40.70	44.80
ECSS-10AC	Square	10"	91.30	105.00	75.70	83.30

Deduct 1/4" from rail length for each end cap.

Sidelite Saddles (Price Per Foot)

Part # (Add Finish)	Description	SL Rail Height	Saddle Height	Finish	
				Mill	314
SAR-1500x188/375	Reversible Saddle	2 3/4"	3/16", 3/8"	6.70	7.40
SAR-1500x250/750	Reversible Saddle	2 3/4"	1/4", 3/4"	6.70	7.40
SAR-1500x500/625	Reversible Saddle	2 3/4"	1/2", 5/8"	6.70	7.40
SAR-1875x188/375	Reversible Saddle	4", 6", 10"	3/16", 3/8"	6.70	7.40
SAR-1875x250/750	Reversible Saddle	4", 6", 10"	1/4", 3/4"	6.70	7.40
SAR-1875x500/625	Reversible Saddle	4", 6", 10"	1/2", 5/8"	6.70	7.40
SAS-1500x125	Saddle 1 1/2" x 1/8"	2 3/4"	1/8"	6.70	7.40
SAS-1875x125	Saddle 1 7/8" x 1/8"	4", 6", 10"	1/8"	6.70	7.40

Standard gasket is black. Gray is available in pre-fit — specify when ordering.

ASSA ABLOY

The global leader in
door opening solutions

Prices Effective June 1, 2017

Copyright © 2017, Rockwood Manufacturing Company, an ASSA ABLOY Group company. All rights reserved.
Reproduction in whole or in part without the express written permission of Rockwood Manufacturing Company is prohibited.

Sidelite Compatible Parts		
Part #	Description	Price
SBL-4PAD	4" Setting Block with Pad	1.90

Dry U-Channel (Price Per Foot)			Finish			
Part # (Add Finish)	Height	Width	32D/630	32/629	28/628	314
UCD-0687x1625	1 ¹¹ / ₁₆ "	1 ⁵ / ₈ "	15.60	17.90	8.90	9.80
UCD-1625x1625	1 ⁵ / ₈ "	1 ⁵ / ₈ "	24.90	28.60	11.70	12.90
UCD-1625x1875	1 ⁵ / ₈ "	1 ⁷ / ₈ "	25.20	28.90	13.50	14.90

Includes pre-fit gasket – specify "roll in" if you prefer this gasket.

Dry U-Channel End Caps (Each)			Finish			
Part # (Add Finish)	Height	Width	32D/630	32/629	28/628	314
ECU-0687x1625	1 ¹¹ / ₁₆ "	1 ⁵ / ₈ "	9.90	11.40	6.20	6.80
ECU-1625x1625	1 ⁵ / ₈ "	1 ⁵ / ₈ "	9.90	11.40	6.20	6.80
ECU-1625x1875	1 ⁵ / ₈ "	1 ⁷ / ₈ "	9.90	11.40	6.20	6.80

Dry U-Channel Gasketing (Price Per Roll)				
Part #	Glass Sizes	Roll Length	Price	
GD-PREFIT-A.BLACK	A	500'	1,443.00	
GD-PREFIT-B.BLACK	B, C	500'	1,443.00	
GD-PREFIT-B.GRAY	B, C	500'	1,443.00	
GD-ROLLIN-B.BLACK	B, C	500'	1,443.00	

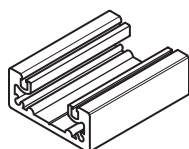

Dry U-Channel
(UCD-0687x1625)

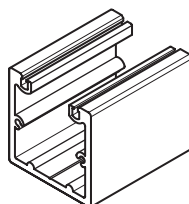

Dry U-Channel
(UCD-1625x1625)

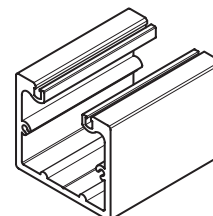

Dry U-Channel
(UCD-1625x1875)

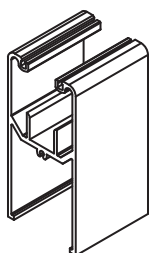

Square 4"
(SRS-4)

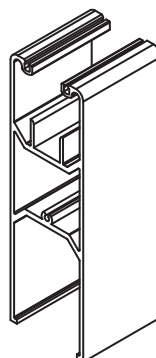

Square 6"
(SRS-6)

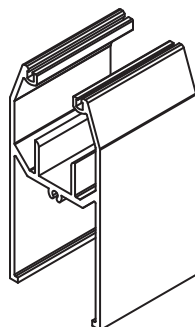

Tapered 4"
(SRT-4)

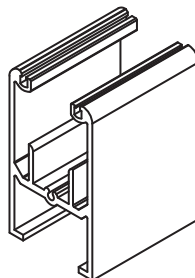

Square 2³/₄"
(SRS-275)

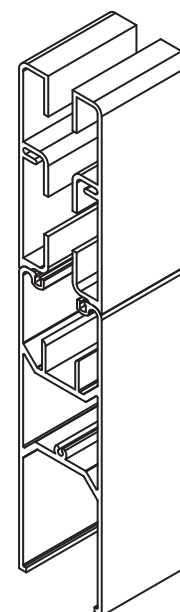

Square 10"
(SRS-10)

ASSA ABLOY

The global leader in
door opening solutions

Prices Effective June 1, 2017

Copyright © 2017, Rockwood Manufacturing Company, an ASSA ABLOY Group company. All rights reserved.
Reproduction in whole or in part without the express written permission of Rockwood Manufacturing Company is prohibited.

Sidelite Glazing Hardware (cont.)

Wet/Dry U-Channel (Price Per foot)			Finish			
Part # (Add Finish)	Height	Width	32D/630	32/629	28/628	314
UWD-1000x1000	1"	1"	6.70	7.70	5.30	5.90
UWD-1500x1000	1 1/2"	1"	8.10	9.40	7.70	8.50
UWD-2000x1000	2"	1"	10.00	11.50	7.40	8.20
UWD-HAT-1750x1000	1 3/4"	1"	111.00	White Powder Coat (10 ft Length Only)		

Wet/Dry U-Channel End Caps (Each)			Finish			
Part # (Add Finish)	Height	Width	32D/630	32/629	28/628	314
ECU-1000x1000	1"	1"	7.40	8.50	4.90	5.40
ECU-1500x1000	1 1/2"	1"	7.40	8.50	4.90	5.40
ECU-2000x1000	2"	1"	7.40	8.50	4.90	5.40

Wet/Dry U-Channel Gasketing - Black (Price Per Roll)			
Part #	Glass Sizes	Roll Length	Price
GD-WEDGE.BLACK	B, C	100'	289.00

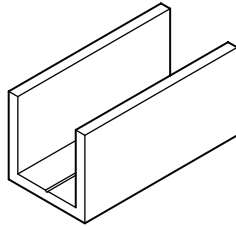

Wet/Dry U-Channel
(UWD-1000x1000)

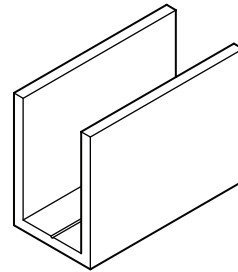

Wet/Dry U-Channel
(UWD-1500x1000)

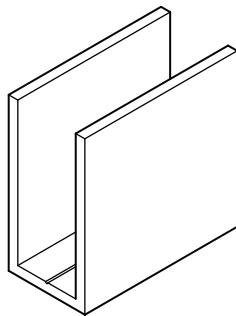

Wet/Dry U-Channel
(UWD-2000x1000)

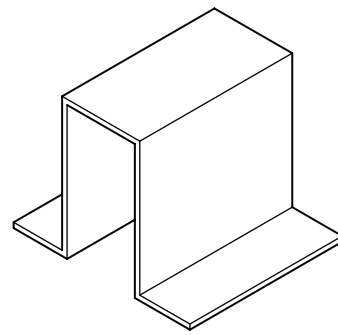

Wet/Dry U-Channel
(UWD-HAT-1750x1000)

ASSA ABLOY

The global leader in
door opening solutions

Prices Effective June 1, 2017

Copyright © 2017, Rockwood Manufacturing Company, an ASSA ABLOY Group company. All rights reserved.
Reproduction in whole or in part without the express written permission of Rockwood Manufacturing Company is prohibited.

Add for Miter Cuts	Finish	
	32D/32	28/314
Description		
2 3/4" Rail	50.00	35.00
4" Rail	60.00	45.00
6" Rail	75.00	60.00
10" Rail	100.00	85.00
Dry U-Channel (All Sizes)	45.00	30.00

Sidelite Rail Cladding Only (Price Per Piece, Per Foot)			Finish			
Part # (Add Finish)	Rail Height	Profile	32D/630	32/629	28/628	314
SRS-275-CL	2 3/4"	Square	23.30	26.80		
SRS-4-CL	4"	Square	19.20	22.10		
SRT-4-CL	4"	Tapered	19.20	22.10		
SRS-6-CL	6"	Square	28.30	32.60		
SRS-10-CL	10"	Square	60.70	69.90	44.50	48.90

U-Channel Cladding Only (Price Per Piece, Per Foot)			Finish	
Part # (Add Finish)	Channel Height	Channel Width	32D/630	32/629
UC-0687x1625-CL	1 1/16"	1 5/8"	7.40	8.50
UC-1625x1625-CL	1 5/8"	1 5/8"	12.30	14.20
UC-1625x1875-CL	1 5/8"	1 7/8"	14.80	17.00

Sidelite Rails = 9/16" Bite Top and Bottom

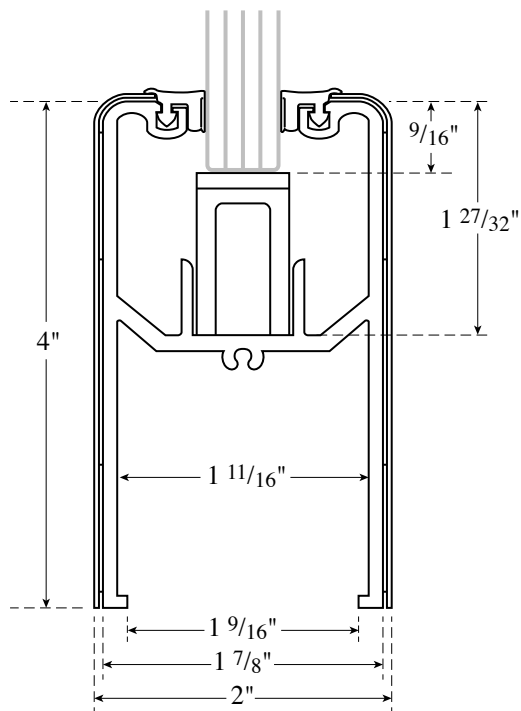

2 3/4" Rail has 1/2" bite.

ASSA ABLOY

The global leader in door opening solutions

Headers

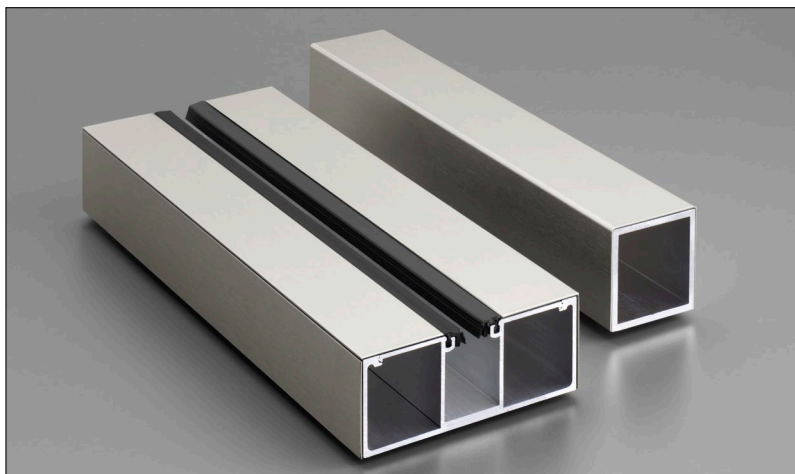

2-Piece Headers (Price Per Panel)					Finish			
Part # (Add Finish)	Prep Type	Height	Width	Std Lengths	32D/630	32/629	28/628	314
HDR-1750x4000-PIV	1 Pivot	1 3/4"	4"	24" to 48"	216.00	248.00	112.00	123.00
HDR-1750x4500-PIV	1 Pivot	1 3/4"	4 1/2"	24" to 48"	228.00	262.00	121.00	133.00
HDR-1750x4000-OHC	1 Closer	1 3/4"	4"	24" to 48"	209.00	240.00	108.00	119.00
HDR-1750x4500-OHC	1 Closer	1 3/4"	4 1/2"	24" to 48"	220.00	254.00	117.00	128.00
Add Per Foot (Custom Length)					26.00		12.00	
Add for Mag Lock Prep					100.00		75.00	

2-Piece Sidelite Headers with Gasket (Price Per Foot)					Finish			
Part # (Add Finish)	Prep Type	Height	Width	Std Lengths	32D/630	32/629	28/628	314
HDR-1750x4000-SDL	Center SL	1 3/4"	4"	Per Foot	45.20	52.00	23.10	25.40
HDR-1750x4500-SDL	Center SL	1 3/4"	4 1/2"	Per Foot	51.00	58.60	26.90	29.60

Solid Headers (Price Per Panel)					Finish			
Part # (Add Finish)	Prep Type	Height	Width	Std Lengths	32D/630	32/629	28/628	314
HDS-1750x4000-PIV	Pivot	1 3/4"	4"	24" to 48"	429.00	494.00	223.00	245.00
HDS-1750x4500-PIV	Pivot	1 3/4"	4 1/2"	24" to 48"	454.00	522.00	240.00	264.00
HDS-2000x2000-PIV	Pivot	2"	2"	24" to 48"	410.00	472.00	199.00	219.00
HDS-2000x6000-PIV	Pivot	2"	6"	24" to 48"	563.00	647.00	317.00	348.00
HDS-1750x4000-OHC	Closer	1 3/4"	4"	24" to 48"	610.00	702.00	352.00	387.00
HDS-1750x4500-OHC	Closer	1 3/4"	4 1/2"	24" to 48"	634.00	730.00	369.00	406.00
HDS-2000x6000-OHC	Closer	2"	6"	24" to 48"	744.00	855.00	446.00	490.00
Add Per Foot (Custom Length)					38.00		24.00	
Add Per Foot (Sidelite Prep)					30.00		20.00	
Add for Deadbolt Strike, Offset Pivot, or Panic Reinforce Prep					70.00		50.00	
Add for Mag Lock/Electric Strike Prep					100.00		75.00	
Add Miter Cut					60.00		45.00	
Add for Other Preps					200.00		150.00	

Custom Powder Coat available (call for price).
Double price for pair.

ASSA ABLOY

The global leader in
door opening solutions

Prices Effective June 1, 2017

Copyright © 2017, Rockwood Manufacturing Company, an ASSA ABLOY Group company. All rights reserved.
Reproduction in whole or in part without the express written permission of Rockwood Manufacturing Company is prohibited.

Floating Headers

Solid Floating Headers (Price Per Panel)					Finish			
Part # (Add Finish)	Prep Type	Height	Width	Std Lengths	32D/630	32/629	28/628	314
HDF-1750x4000-PIV	1 Pivot	1 3/4"	4"	36" to 60"	636.00	731.00	489.00	505.00
HDF-1750x4500-PIV	1 Pivot	1 3/4"	4 1/2"	36" to 60"	657.00	756.00	504.00	527.00
HDF-2000x6000-PIV	1 Pivot	2"	6"	36" to 60"	739.00	850.00	608.00	645.00
HDF-1750x4000-OHC	1 Closer	1 3/4"	4"	36" to 60"	636.00	731.00	489.00	505.00
HDF-1750x4500-OHC	1 Closer	1 3/4"	4 1/2"	36" to 60"	657.00	756.00	504.00	527.00
HDF-2000x6000-OHC	1 Closer	2"	6"	36" to 60"	739.00	850.00	608.00	645.00
Add Per Foot (Custom Length)					38.00		24.00	
Add for Deadbolt Strike, Offset Pivot, or Panic Reinforce Prep					70.00		50.00	
Add for Mag Lock/Electric Strike Prep					100.00		75.00	
Add for Other Preps					200.00		150.00	

Custom Powder Coat available (call for price).

Double price for pair.

Header Accessories			Finish			
Part # (Add Finish)	Description	Length	32D/630	32/629	28/628	314
ECH-1750x4000	1 3/4" x 4" End Cap		16.30	18.80	16.10	17.70
ECH-1750x4500	1 3/4" x 4 1/2" End Cap		16.30	18.80	16.10	17.70
ECFH-1750x1750	1 3/4" x 1 3/4" End Cap		9.90	11.40	6.20	6.80
DS-3000	Single Acting Door Stop (Single Dr)	3"	8.00	9.20	5.50	6.00
DS-6000	Single Acting Door Stop (Double Dr)	6"	14.90	17.10	8.50	9.40
GD-WEDGE	Solid Header Gasketing	100'	289.00	Black Only		

Header Cladding Only (Price Per Foot)				Finish	
Part # (Add Finish)	Header Type	Notes	32D/630	32/629	
HD-1750xSIDE-CL	Sides	2 Pieces	9.90	11.40	
HD-4000-BINS-CL	Blank Ins	1 Piece	9.90	11.40	
HD-4000-PINS-CL	Pocket Ins	2 Pieces	9.90	11.40	
HD-4500-BINS-CL	Blank Ins	1 Piece	9.90	11.40	
HD-4500-PINS-CL	Pocket Ins	2 Pieces	9.90	11.40	
HDS-1750x4000-CL	Solid	3 Pieces	22.20	25.60	
HDS-1750x4500-CL	Solid	3 Pieces	22.20	25.60	
HDS-2000x2000-CL	Solid	3 Pieces	17.30	19.90	
HDS-2000x6000-CL	Solid	3 Pieces	22.20	25.60	

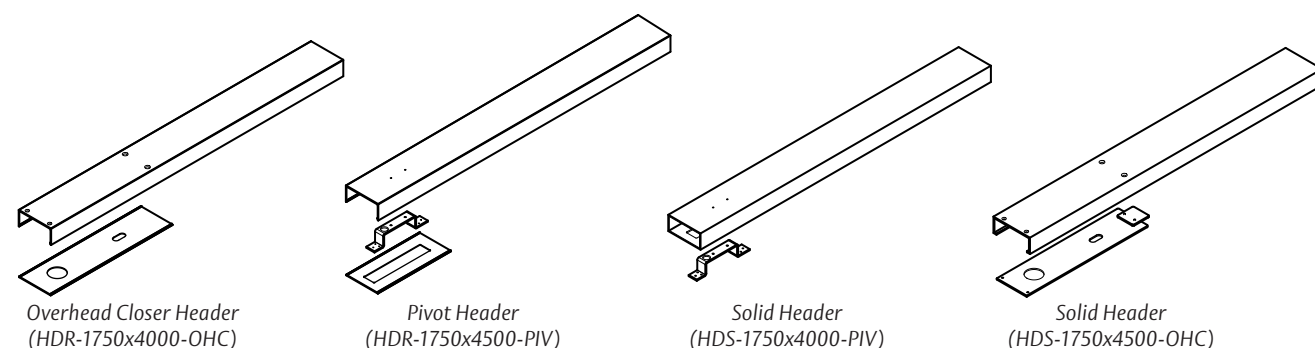
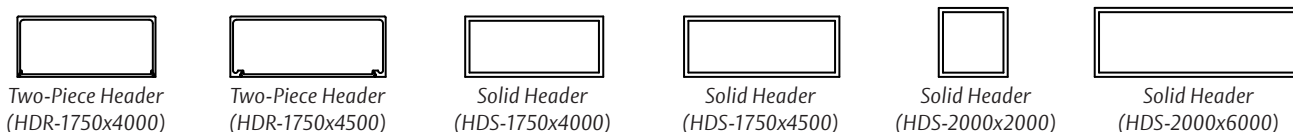

ASSA ABLOY

Prices Effective June 1, 2017

Copyright © 2017, Rockwood Manufacturing Company, an ASSA ABLOY Group company. All rights reserved. Reproduction in whole or in part without the express written permission of Rockwood Manufacturing Company is prohibited.

The global leader in
door opening solutions

Patch Fittings



Patch Fittings				Finish			
Part # (Add Finish)	Where Used	Glass Size	Incl Parts	32D/630	32/629	28/628	314
PFD-10A	Door Bottom	A	Pivot/Closer Ins	65.50	75.40	50.00	54.90
PFD-20A	Door Top	A	Pivot Ins	62.70	72.10	47.10	51.80
PFD-22A	Door Top	A	OHC Ins	67.70	77.80	52.80	58.10
PFT-34A-P	Transom Patch	A	Wall Bracket, Pivot	141.00	162.00	81.40	89.50
PFT-34A-S	Transom Patch	A	Wall Bracket, Stop	141.00	162.00	81.40	89.50
PFT-34A-B	Transom Patch	A	Wall Bracket, Blank	137.00	158.00	79.00	86.90
PFT-40A-P	Transom/SL	A	Pivot Ins	133.00	153.00	95.20	105.00
PFT-40A-S	Transom/SL	A	Stop Ins	133.00	153.00	95.20	105.00
PFT-40A-B	Transom/SL	A	Blank Ins	130.00	149.00	91.90	101.00
PFT-41A-LH	Transom/SL/Fin	A	Pivot or Stop or Blank	283.00	325.00	229.00	252.00
PFT-41A-RH	Transom/SL/Fin	A	Pivot or Stop or Blank	283.00	325.00	229.00	252.00
PFT-60A	Transom/SL	A	Stop, Blank	83.80	96.40	51.40	56.50
PFT-61A-LH	Transom/SL/Fin	A	Stop, Blank	182.00	210.00	153.00	168.00
PFT-61A-RH	Transom/SL/Fin	A	Stop, Blank	182.00	210.00	153.00	168.00
PFT-62A	Transom/SL/Stop	A	Stop	140.00	162.00	87.10	95.80
PFT-70A	Transom Stop	A	Stop, Blank	74.90	86.10	57.10	62.80
PFT-71A	Transom Connector	A	Fin Bracket	445.00	512.00	347.00	382.00
PFS-80A	Sidelite Connector	A		91.10	105.00	62.80	69.00
PFS-81A	Sidelite Connector/Fin	A	Fin Bracket	301.00	346.00	264.00	290.00
PFA-90A	SL 90° Angle	A		411.00	473.00	363.00	399.00
PFA-90A-SH	SL 90° Angle Short	A		378.00	435.00	299.00	329.00
PFD-100LA	Bottom Patch Lock	A		154.00	178.00	104.00	114.00

ASSA ABLOY

The global leader in
door opening solutions

Prices Effective June 1, 2017

Copyright © 2017, Rockwood Manufacturing Company, an ASSA ABLOY Group company. All rights reserved. Reproduction in whole or in part without the express written permission of Rockwood Manufacturing Company is prohibited.

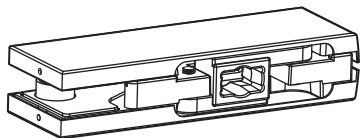

Bottom Patch
(PFD-10)

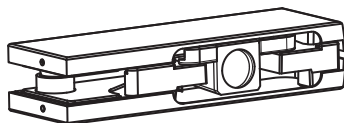

Top Patch
(PFD-20)

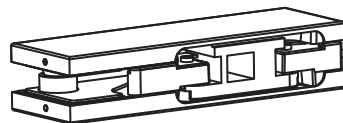

Top Patch
(PFD-22)

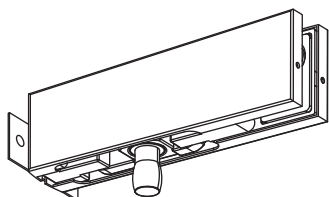

Transom Patch with Wall Bracket
(PFT-34)

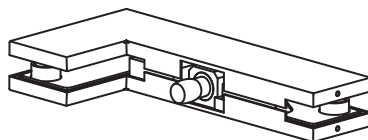

Sidelite Transom Patch
(PFT-40)

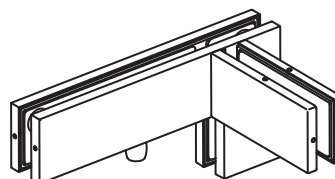

Sidelite Transom Fin Patch
(PFT-41)

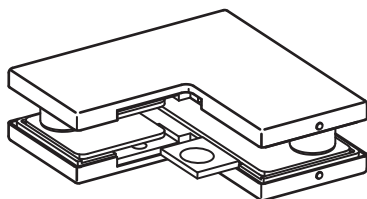

Sidelite Transom Patch
(PFT-60)

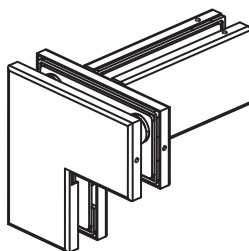

Sidelite Transom Fin Patch
(PFT-61)

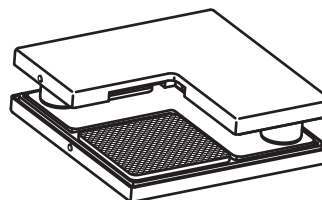

Sidelite Transom Stop Patch
(PFT-62)

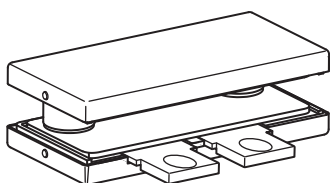

Transom Stop Patch
(PFT-70)

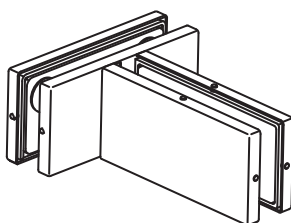

Transom Connector Fin Patch
(PFT-71)

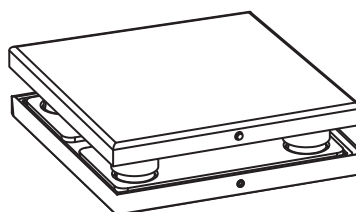

Sidelite Connector Patch
(PFS-80)

Patch Fittings (cont.)

Patch Fittings				Finish			
Part # (Add Finish)	Where Used	Glass Sizes	Incl Parts	32D/630	32/629	28/628	314
PFD-10BC	Door Bottom	B, C	Pivot/Closer Ins	61.70	70.90	46.10	50.70
PFD-20BC	Door Top	B, C	Pivot Ins	58.80	67.60	43.20	47.60
PFD-22BC	Door Top	B, C	OHC Ins	63.80	73.30	48.90	53.80
PFT-34BC-P	Transom Patch	B, C	Wall Bracket, Pivot	137.00	157.00	76.90	84.60
PFT-34BC-S	Transom Patch	B, C	Wall Bracket, Stop	137.00	157.00	76.90	84.60
PFT-34BC-B	Transom Patch	B, C	Wall Bracket, Blank	133.00	153.00	74.50	82.00
PFT-40BC-P	Transom/SL	B, C	Pivot Ins	129.00	148.00	90.70	100.00
PFT-40BC-S	Transom/SL	B, C	Stop Ins	129.00	148.00	90.70	100.00
PFT-40BC-B	Transom/SL	B, C	Blank Ins	126.00	144.00	87.50	96.20
PFT-41BC-LH	Transom/SL/Fin	B, C	Pivot or Stop or Blank	279.00	320.00	224.00	247.00
PFT-41BC-RH	Transom/SL/Fin	B, C	Pivot or Stop or Blank	279.00	320.00	224.00	247.00
PFT-60BC	Transom/SL	B, C	Stop, Blank	79.40	91.30	47.00	51.70
PFT-61BC-LH	Transom/SL/Fin	B, C	Stop, Blank	178.00	204.00	148.00	163.00
PFT-61BC-RH	Transom/SL/Fin	B, C	Stop, Blank	178.00	204.00	148.00	163.00
PFT-62BC	Transom/SL/Stop	B, C	Stop	136.00	156.00	82.60	90.90
PFT-70BC	Transom Stop	B, C	Stop, Blank	70.50	81.00	52.60	57.90
PFT-71BC	Transom Connector	B, C	Fin Bracket	443.00	509.00	345.00	380.00
PFS-80BC	Sidelite Connector	B, C		86.70	100.00	58.30	64.10
PFS-81BC	Sidelite Connector/Fin	B, C	Fin Bracket	296.00	341.00	259.00	285.00
PFA-90BC	SL 90° Angle	B, C		406.00	467.00	358.00	394.00
PFA-90BC-SH	SL 90° Angle Short	B, C		373.00	429.00	294.00	323.00
PFD-100LBC	Bottom Patch Lock	B, C		149.00	171.00	98.20	108.00

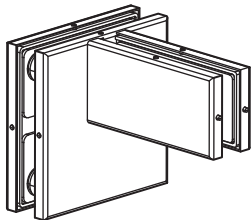

Sidelite Fin Patch
(PFS-81)

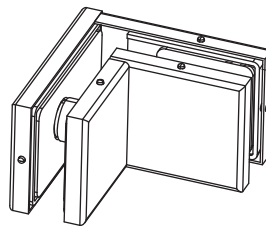

Sidelite 90° Short Angle Patch
(PFS-90A-SH)

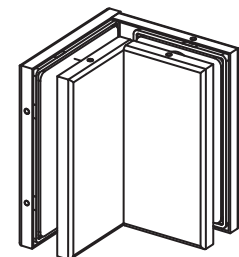

Sidelite 90° Angle Patch
(PFA-90)

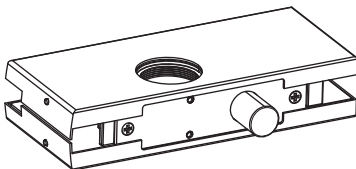

Patch Lock
(PFD-100L)

ASSA ABLOY

The global leader in
door opening solutions

Prices Effective June 1, 2017

Copyright © 2017, Rockwood Manufacturing Company, an ASSA ABLOY Group company. All rights reserved. Reproduction in whole or in part without the express written permission of Rockwood Manufacturing Company is prohibited.

Patch Inserts		
Part # (Add Finish)	Description	Price
PFD-10INS	Closer/Pivot Insert	18.80
PFD-20PIVINS	Pivot Insert	15.10
PFD-22OHCINS	Overhead Closer Insert	23.50
PFT-34/40/41-BLANKINS	Blank Insert	15.10

Patch Inserts		
Part # (Add Finish)	Description	Price
PFT-34/40/41-PIVINS	Pivot Insert	18.80
PFT-34/40/41-STOPINS	Stop Insert	18.80
PFT-60/70-STOPTAB	Stop Tab	13.00

Part # (Add Finish)	Description	Finish			
		32D/630	32/629	28/628	314
PFT-WALLBRACK-34	Wall Bracket for PFT-34 (replacement)			18.80	
PFD-LOCKCYL	1" Cylinder	24.00	24.00	24.00	24.00
PFD-LOCKTT	1" Thumbturn	24.00	24.00	24.00	24.00
Part # (Add Finish)	Description		26D/626	26/625	314E
570	Dust Proof Strike		24.00	24.00	26.00

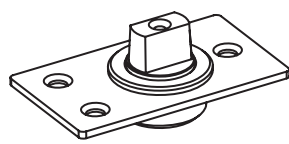

Floor Mount Pivot
(PF-FM-PIVOT)

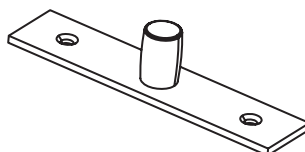

Surface Mount Pivot
(PF-SM-PIVOT)

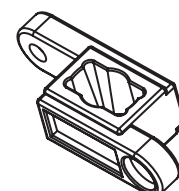

Closer/Pivot Insert
(PFD-10INS)

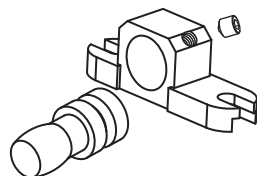

Pivot Insert
(PFT-34/40/41-PIVINS)

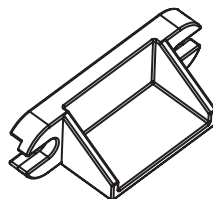

Blank Insert
(PFT-34/40/41-BLANKINS)

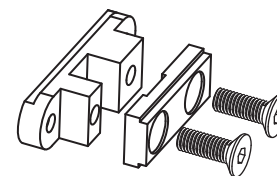

Overhead Closer Insert
(PFD-22OHCINS)

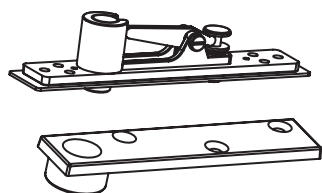

Walking Beam Pivot
(PV-WALKBEAM)

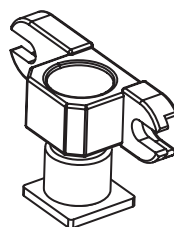

Pivot Insert
(PFD-20PIVINS)

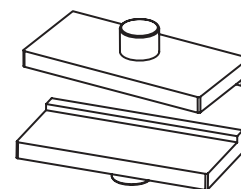

Blank Tab
(PFT-60/70BLANKTAB)

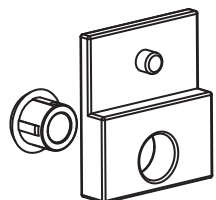

Stop Tab
(PFT-60/70-STOPTAB)

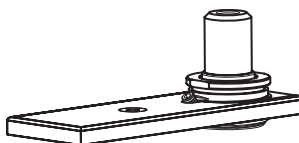

Adjustable Pivot
(PF-ADJ-PIV)

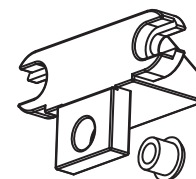

Stop Insert
(PFT-34/40/41-STOPINS)

ASSA ABLOY

The global leader in
door opening solutions

Prices Effective June 1, 2017

Copyright © 2017, Rockwood Manufacturing Company, an ASSA ABLOY Group company. All rights reserved.
Reproduction in whole or in part without the express written permission of Rockwood Manufacturing Company is prohibited.

Panic Devices



Sold Through: Authorized Channel Partner
ASSA ABLOY



Glass Panic Device				Finish			
Part # (Add Finish)	Latches	Mating Handle Shape	Mating Handle Length	32D/630	32/629	32/32D*	314E
PDU8000	Up	None	None				
PDU8000-1	Up	L-Shape	Full				
PDU8000-2	Up	L-Shape	Half				
PDU8000-3	Up	Vertical	Full				
PDU8000-4	Up	Vertical	Half				
PDU8000-5	Up	Vertical	Short				
PDU8000-6	Up	Horizontal	Full				

*Panic Pricing
only available to
Authorized Channel
Partners.*

Panic & Dummy Panic size adders: Add ⁵/₂₀inch for panic vertical bar heights over 59" or widths over 27 ¹/₂"; Add ⁵/₁₀inch mating vertical bar heights over 59" (half height); 96" (full height) or widths over 27 ¹/₂".

*Specify finish requested for "PUSH" region.

"PUSH" Infill Pricing	Price	Cylinder Options	Price
BLACK (Standard)		Mortise Cylinder (Standard)	
WHITE		7-pin SFIC Housing w/Constr Core	
CUSTOM		Special Order (Keyed Alike)	
NO FILL		Customer Supplied Cylinder	
		Dummy Cylinder Housing	
		Non-Keyed Function (Blank Escutcheon Plate Provided)	

NO FILL is not available in US32D.

Panic Strike Kits (Strike, Adapter Plate, Cover)					Finish		
Part # (Add Finish)	Description	Keeper Length	Voltage	Mode	32D/630	32/629	314E
ESK-SGL-24D	Single Door	³ / ₄ "	24V DC	Fail Secure	1,432.00	1,647.00	1,647.00
ESK-DBL-24D	Double Door	³ / ₄ "	24V DC	Fail Secure	2,506.00	2,882.00	2,882.00
ESK-SGL-12D	Single Door	³ / ₄ "	12V DC	Fail Secure	1,432.00	1,647.00	1,647.00
ESK-DBL-12D	Double Door	³ / ₄ "	12V DC	Fail Secure	2,506.00	2,882.00	2,882.00
ESK-SGL-24D-FS	Single Door	³ / ₄ "	24V DC	Fail Safe	1,432.00	1,647.00	1,647.00
ESK-DBL-24D-FS	Double Door	³ / ₄ "	24V DC	Fail Safe	2,506.00	2,882.00	2,882.00
ESK-SGL-12D-FS	Single Door	³ / ₄ "	12V DC	Fail Safe	1,432.00	1,647.00	1,647.00
ESK-DBL-12D-FS	Double Door	³ / ₄ "	12V DC	Fail Safe	2,506.00	2,882.00	2,882.00
MSK-SGL	Single Door				173.00	199.00	199.00
MSK-DBL	Double Door				247.00	284.00	284.00
AC-RECTIFIER	AC Converter for Electric Strike				78.00		

ASSA ABLOY

The global leader in door opening solutions

Prices Effective June 1, 2017

Copyright © 2017, Rockwood Manufacturing Company, an ASSA ABLOY Group company. All rights reserved. Reproduction in whole or in part without the express written permission of Rockwood Manufacturing Company is prohibited.

310-1 Electric Strikes (Body Only)

Part # (Add Finish)	Description	Keeper Length	Voltage	Mode	Price
ES-310-1-3/4-24D	Electric Strike	3/4"	24V DC	Fail Secure	760.00
ES-310-1-3/4-12D	Electric Strike	3/4"	12V DC	Fail Secure	760.00
ES-310-1-3/4-24D-FS	Electric Strike	3/4"	24V DC	Fail Safe	760.00
ES-310-1-3/4-12D-FS	Electric Strike	3/4"	12V DC	Fail Safe	760.00

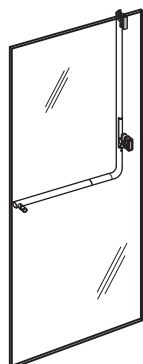

PDU-8000

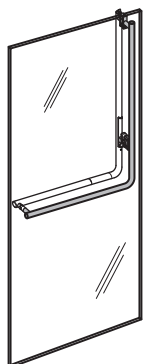

PDU-8000-1

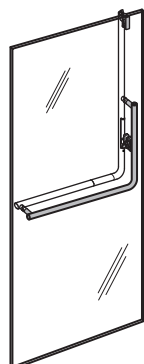

PDU-8000-2

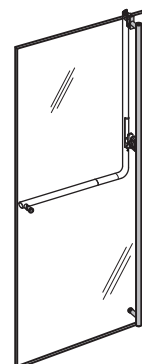

PDU-8000-3

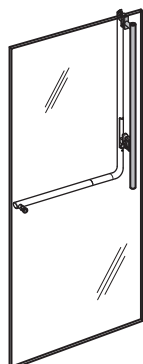

PDU-8000-4

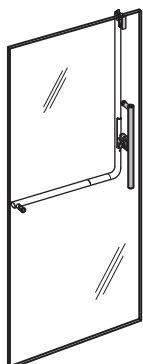

PDU-8000-5

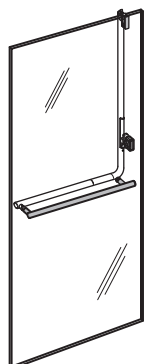

PDU-8000-6

Strike Options

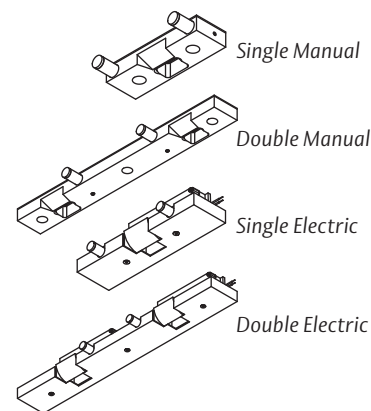

Right Angle Pulls - Dummy for Active Side of Panic				Finish			
Part # (Add Finish)	Leg	Mating Handle Shape	Mating Handle Length	32D/630	32/629	32/629 32/32D	314E
RM412	Up	None	None	624.00	714.00	714.00	814.00

Dummy Mating Pulls				Finish			
Part # (Add Finish)	Leg	Mating Handle Shape	Mating Handle Length	32D/630	32/629	32/629 32/32D	314E
RM412	Up	L-Shape	Full	624.00	714.00	714.00	814.00
RM410	Up	L-Shape	Half	624.00	714.00	714.00	814.00
RM3301		Vertical	Short	177.00	198.00	198.00	227.00
RM3301		Vertical	Half	252.00	282.00	282.00	332.00
RM3301		Vertical	Full	352.00	394.00	394.00	432.00
RM3112		Horizontal	Full	215.00	241.00	241.00	295.00

ASSA ABLOY

The global leader in door opening solutions

Prices Effective June 1, 2017

Copyright © 2017, Rockwood Manufacturing Company, an ASSA ABLOY Group company. All rights reserved. Reproduction in whole or in part without the express written permission of Rockwood Manufacturing Company is prohibited.

Sliding Door Hardware



Sliding Hardware			Finish		
Part # (Add Finish)	Track Length	Max Weight	32D/630	32/629	314E
STS-G60x78	6'6"	198	561.00	643.00	694.00
STS-G60x98	8'2"	198	617.00	740.00	763.00
STS-G70x78	6'6"	240	701.00	806.00	874.00
STS-G70x98	8'2"	240	756.00	907.00	945.00
STS-G80x78	6'6"	198	584.00	671.00	732.00
STS-G80x98	8'2"	198	639.00	767.00	801.00
STS-G90x78	6'6"	198	876.00	1,066.00	1,117.00
STS-G90x98	8'2"	198	934.00	1,121.00	1,187.00
STS-G100x78	6'6"	198	665.00	766.00	829.00
STS-G100x98	8'2"	198	724.00	869.00	899.00
STS-STOP1			43.00	52.00	52.00

Through Glass Flush Pulls for Sliding Glass Doors			Finish		
Part #	Dia.	Glass Size	32D/630	32/629	314E
FP-OPEN	2 1/4" Overall	A, B	190.00	219.00	219.00
FP-CLOSED	2 1/4" Overall	A, B	190.00	219.00	219.00

Requires 1 7/8" dia. hole in glass.

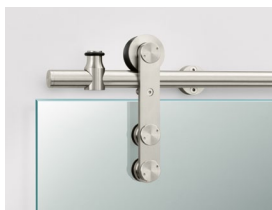

G60

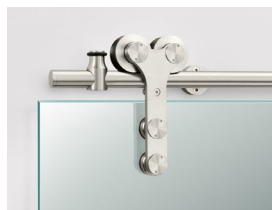

G70

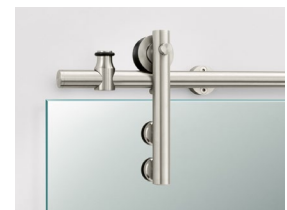

G80

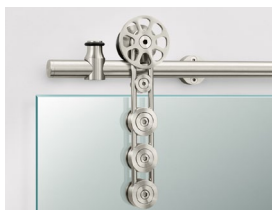

G90

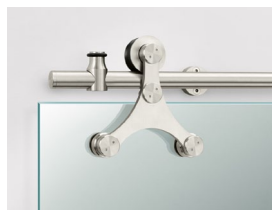

G100

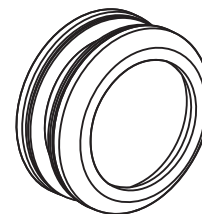

FP-CLOSED

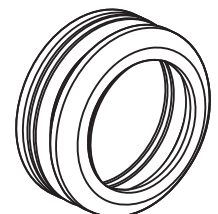

FP-OPEN

ASSA ABLOY

The global leader in door opening solutions

Prices Effective June 1, 2017

Copyright © 2017, Rockwood Manufacturing Company, an ASSA ABLOY Group company. All rights reserved. Reproduction in whole or in part without the express written permission of Rockwood Manufacturing Company is prohibited.

Door Pulls

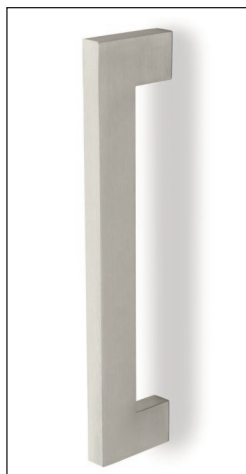

MezzoTek - Stepped Post Pulls — Straight - Square Ends			Finish		
Part #	Overall Length	Dia.	32D/630	32/629	314E
RM2110	14"	1 1/4"	200.00	224.00	280.00
RM2110	17"	1 1/4"	212.00	238.00	292.00
RM2110	22"	1 1/4"	225.00	251.00	305.00
RM2110	36" - 48"	1 1/4"	341.00	382.00	421.00
RM2110	48" - 72"	1 1/4"	364.00	407.00	444.00
RM2110	72" - 96"	1 1/4"	434.00	486.00	534.00

SoftMet - Santoprene™ Grip Pulls — Straight - Square Ends			Finish		
Part #	Overall Length	Dia.	32D/630	32/629	314E
RM2510	12"	1 1/4"	293.00	328.00	373.00
RM2510	15"	1 1/4"	307.00	345.00	387.00
RM2510	20"	1 1/4"	331.00	370.00	411.00
RM2510	up to 36" CTC	1 1/4"	476.00	533.00	576.00

MegaTek - Post Mount Pulls — Straight - Square Ends			Finish				
Part #	Overall Length	Dia.	28/628	314	32D/630	32/629	314E
RM3301	12"	1 1/4"	139.00	153.00	139.00	156.00	189.00
RM3301	24"	1 1/4"	177.00	191.00	177.00	198.00	227.00
RM3301	36"	1 1/4"	215.00	229.00	215.00	241.00	295.00
RM3301	48"	1 1/4"	253.00	293.00	252.00	282.00	332.00
RM3301	60"	1 1/4"	278.00	318.00	277.00	310.00	357.00
RM3301	72"	1 1/4"	303.00	343.00	302.00	338.00	382.00
RM3301	84"	1 1/4"	328.00	368.00	327.00	366.00	407.00
RM3301	96"	1 1/4"			352.00	394.00	432.00

87" max overall in aluminum, specify CTC and overall length.

ASSA ABLOY

Prices Effective June 1, 2017

Copyright © 2017, Rockwood Manufacturing Company, an ASSA ABLOY Group company. All rights reserved.
Reproduction in whole or in part without the express written permission of Rockwood Manufacturing Company is prohibited.

The global leader in
door opening solutions

Door Pulls (cont.)

NeoMax - Post Mount Pulls with GripZone — Straight - Square Ends			Finish	
Part #	Overall Length	Dia.	32/629	
RM3210	12"	1 1/4"	184.00	
RM3210	15"	1 1/4"	190.00	
RM3210	20"	1 1/4"	195.00	
RM3401	36" - 48"	1 1/4"	368.00	
RM3401	48" - 72"	1 1/4"	391.00	
RM3401	72" - 96"	1 1/4"	485.00	

English Bridle Leather Pulls — Straight - Square Ends			Finish		
Part #	Overall Length	Dia.	32D/630	32/629	314E
RM6010	16"	1 1/4"	624.00	668.00	724.00
RM6010	20"	1 1/4"	697.00	746.00	797.00
RM6061	36" - 48"	1 1/4"	1,404.00	1,501.00	1,524.00
RM6061	48" - 72"	1 1/4"	2,084.00	2,230.00	2,204.00
RM6061	72" - 96"	1 1/4"	2,339.00	2,503.00	2,459.00

Flush Leather Pulls — Straight - Square Ends			Finish		
Part #	Overall Length	Dia.	32D/630	32/629	314E
RM6310	16"	1 1/4"	746.00	798.00	846.00
RM6310	20"	1 1/4"	821.00	878.00	941.00
RM6310	up to 48"	1 1/4"	1,787.00	1,913.00	1,907.00
RM6310	48" - 72"	1 1/4"	2,382.00	2,548.00	2,502.00
RM6310	72" - 96"	1 1/4"	3,274.00	3,504.00	3,394.00

GeoMetek Narrow Profile Pulls — Straight - Rectangular Ends			Finish		
Part #	CTC	Grip Size	32D/630	32/629	314E
RM7910	11"	3/4" x 1 1/2"	225.00	254.00	305.00
RM7910	16"	3/4" x 1 1/2"	232.00	261.00	312.00
RM7910	20"	3/4" x 1 1/2"	240.00	268.00	320.00
RM7910	up to 48"	3/4" x 1 1/2"	724.00		824.00

Specify CTC and overall length.

See Rockwood Architectural Door Pull catalog for more options.

ASSA ABLOY

The global leader in
door opening solutions

Prices Effective June 1, 2017

Copyright © 2017, Rockwood Manufacturing Company, an ASSA ABLOY Group company. All rights reserved.
Reproduction in whole or in part without the express written permission of Rockwood Manufacturing Company is prohibited.

Through Glass Flush Pulls for Sliding Glass Doors			Finish		
Part #	Dia.	Glass Size	32D/630	32/629	314E
FP-OPEN	2 1/4" Overall	A, B	190.00	219.00	219.00
FP-CLOSED	2 1/4" Overall	A, B	190.00	219.00	219.00

Requires 1 7/8" dia. hole in glass.

Straight Solid Door Pulls			Finish				
Part #	CTC	Dia.	32D/630	32/639	314E	28/628	314
110-RKW	8"	1"	69.00	81.00	81.00	30.00	34.00
111-RKW	10"	1"	78.00	92.00	93.00	31.00	35.00
112	12"	1"	84.00	98.00	100.00	32.00	37.00
118	18"	1"	109.00	129.00	129.00	44.00	49.00

Straight Tubular Door Pulls			Finish				
Part #	CTC	Dia.	32D/630	32/639	314E	28/628	314
T110	8"	1"	62.00	76.00	74.00		
T111	10"	1"	64.00	78.00	76.00		
T112	12"	1"	67.00	83.00	80.00		
T118	18"	1"	76.00	96.00	91.00		

Straight Solid Single Bar Sets			Finish				
Part #	CTC	Dia.	32D/630	32/639	314E	28/628	314
11047	8"	1"	262.00	296.00	303.00	94.00	112.00
11147	10"	1"	270.00	309.00	312.00	95.00	113.00
11247	12"	1"	278.00	315.00	321.00	96.00	115.00
11847	18"	1"	303.00	345.00	347.00	107.00	128.00

Straight Tubular Single Bar Sets			Finish				
Part #	CTC	Dia.	32D/630	32/639	314E	28/628	314
T11047	8"	1"	189.00	228.00	225.00		
T11147	10"	1"	191.00	230.00	228.00		
T11247	12"	1"	193.00	232.00	231.00		
T11847	18"	1"	204.00	246.00	243.00		

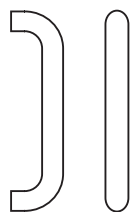

Straight Pulls

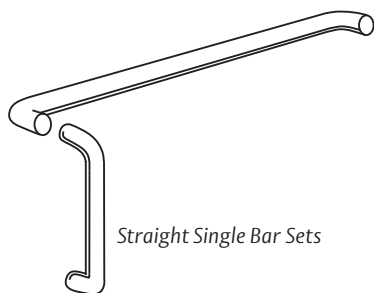

Straight Single Bar Sets

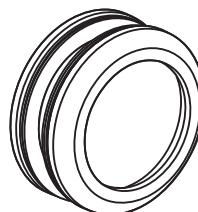

FP-CLOSED

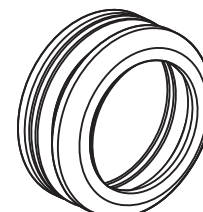

FP-OPEN

TYPE 13 - Back-to-Back Glass Door

Type	Bolt Size	Drill Size	Price
13	1/4"-20	5/8	17.00
13HD*	5/16"-18	5/8	21.00

TYPE 15 - Decorative Thru Bolt Glass Door

Type	Bolt Size	Drill Size	Price
15	1/4"-20	5/8	26.00
15HD	5/16"-18	5/8	31.00
15XHD	3/8"-16	5/8	31.00

*13HD mounting features 2 set screws 180 degrees apart.

Prices Effective June 1, 2017

Copyright © 2017, Rockwood Manufacturing Company, an ASSA ABLOY Group company. All rights reserved. Reproduction in whole or in part without the express written permission of Rockwood Manufacturing Company is prohibited.

ASSA ABLOY

The global leader in door opening solutions

Door Controls

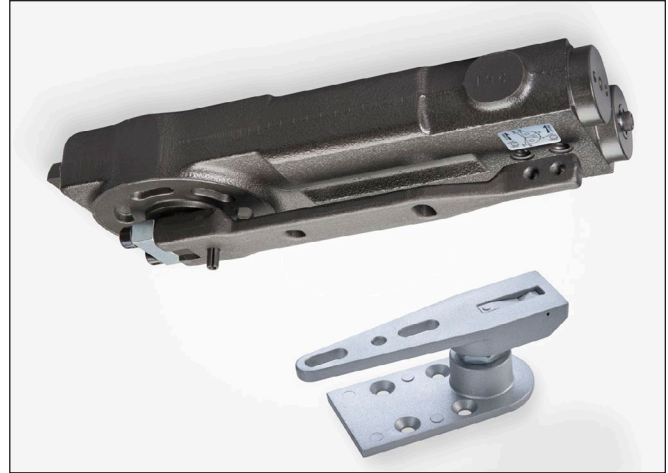

Rixson Floor Closers (Barrier Free)

Part #	Description	Hold Open	Spring	Price
FC-28-90S-RH	Heavy Duty Floor Closer	90	N/A	1,447.00
FC-28-105S-RH	Heavy Duty Floor Closer	105	N/A	1,447.00
FC-28-90S-LH	Heavy Duty Floor Closer	90	N/A	1,447.00
FC-28-105S-LH	Heavy Duty Floor Closer	105	N/A	1,447.00
FC-PH28-90S-RH	Heavy Duty Floor Closer	90	5 lb. Force	1,447.00
FC-PH28-105S-RH	Heavy Duty Floor Closer	105	5 lb. Force	1,447.00
FC-PH28-90S-LH	Heavy Duty Floor Closer	90	5 lb. Force	1,447.00
FC-PH28-105S-LH	Heavy Duty Floor Closer	105	5 lb. Force	1,447.00
FC-6280	Standard Duty Floor Closer	80 to 175	3-6	567.00
FC-6275-90HO	Standard Duty Floor Closer, ADA	90	1-3	548.00
FC-6275-105HO	Standard Duty Floor Closer, ADA	105	1-3	548.00
FC-6275-105NHO	Standard Duty Floor Closer, ADA	NHO	1-3	548.00

Selective hold opens (S) can be turned off. FC-28 and FC-PH28 floor closers include the 554 arm and 26D floor plate.

Floor Closers Accessories

Part #	Description	Style	Finish	Price
FC-6275/6280-CVR.32D	Cover Plate for 6275 & 6280	N/A	32D/630	91.40
FC-6275/6280-CVR.26	Cover Plate for 6275 & 6280	N/A	26/625	105.00
FC-6275/6280-CVR.314E	Cover Plate for 6275 & 6280	N/A	314E	105.00
FC-6275/6280-ARM	Centerhung Arm for 6275 & 6280	Standard	N/A	40.40
FC-6275/6280-OFFARM	3/4" Offset Arm for 6275 & 6280	Offset	N/A	68.30
FC-SPIND-375	Spindle 3/8" (Use for 3/8" Clearance)	Standard	N/A	43.30
FC-SPIND-625	Spindle 5/8"	Standard	N/A	43.30
FC-SPIND-750	Spindle 3/4"	Standard	N/A	43.30
FC-SPIND-1000	Spindle 1"	Standard	N/A	52.90
FC-SPIND-1188	Spindle 1 3/16"	Standard	N/A	52.90
FC-OFFSPIND-375	3° Offset Spindle 3/8" (Use for 3/8" Clearance)	Offset	N/A	43.30
FC-OFFSPIND-625	3° Offset Spindle 5/8"	Offset	N/A	43.30
FC-OFFSPIND-750	3° Offset Spindle 3/4"	Offset	N/A	43.30
FC-OFFSPIND-1000	3° Offset Spindle 1"	Offset	N/A	52.90
FC-OFFSPIND-1188	3° Offset Spindle 1 3/16"	Offset	N/A	52.90

Specify handing when ordering FC-OFFSPIND.

ASSA ABLOY

The global leader in
door opening solutions

Prices Effective June 1, 2017

Copyright © 2017, Rockwood Manufacturing Company, an ASSA ABLOY Group company. All rights reserved. Reproduction in whole or in part without the express written permission of Rockwood Manufacturing Company is prohibited.

Rixson Overhead Concealed Closers with Clips

Part #	Description	Hold Open	Spring	Price
OHC-609-90NHO	90° Back Stop, Non-Hold Open	NHO	1-3 Adj	194.00
OHC-609-105NHO	105° Back Stop, Non-Hold Open	NHO	1-3 Adj	194.00
OHC-609-90HO	90° Back Stop, Hold Open	90°	1-3 Adj	194.00
OHC-609-105HO	105° Back Stop, Hold Open	105°	1-3 Adj	194.00
OHC-609-MC	Mounting Clips 609019			10.30
OHC-609-ARM	End Load Overhead Closer Arm			43.00

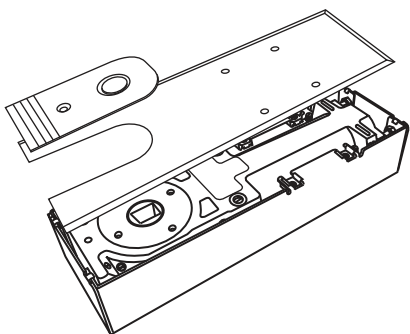

Standard Duty Floor Closer
(FC-6275)

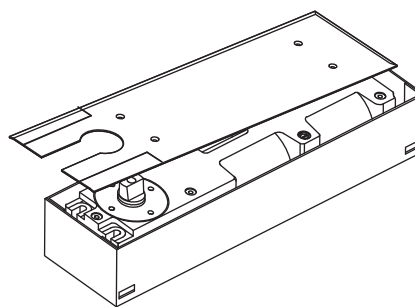

Standard Duty Floor Closer
(FC-6280)

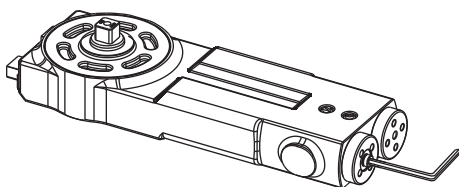

Rixson Overhead Closer
(OHC-609)

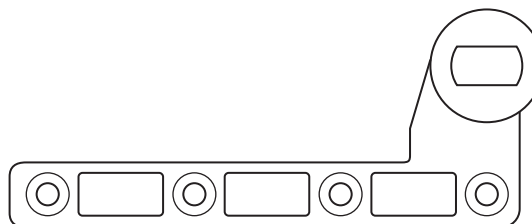

Floor Closer Offset Arm
(FC-6275/6280-OFFARM)



Floor Closer Arm
(FC-6275/6280-ARM)

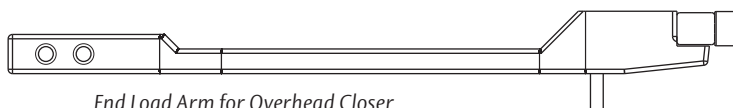

End Load Arm for Overhead Closer
(OHC-609-ARM)

ASSA ABLOY

The global leader in
door opening solutions

Prices Effective June 1, 2017

Copyright © 2017, Rockwood Manufacturing Company, an ASSA ABLOY Group company. All rights reserved.
Reproduction in whole or in part without the express written permission of Rockwood Manufacturing Company is prohibited.

Door Controls (cont.)

Pivots		Clearance		Finish			
Part # (Add Finish)	Description	Min	Max	32D/630	32/629	28/628	314
PV-WALKBEAM	Walking Beam Pivot	1/8"	3/8"	53.70	61.70	53.70	59.00
PF-FM-PIVOT	Floor Mount Pivot	7/16"	N/A	38.60			
PF-SM-PIVOT	Surface Mount Pivot	1/8"	1/4"	33.00			
PF-ADJ-PIV	Adjustable Pivot for Patch Fitting	5/16"	5/8"	85.00	97.80	80.00	88.00
PV-ENDLOAD	Adjustable End Load Bottom Pivot	3/8"	3/4"	38.50	Satin AL Finish		
PV-180	Top Offset Pivot	1/8"	3/16"	247.00			
PV-ADJBLCK	Pivot Adjuster Block			24.00	Mill Finish		
					26D/626	26/625	314E
PV-370	HD Center Hung Pivot Set				307.00	353.00	353.00

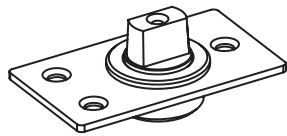

Floor Mount Pivot
(PF-FM-PIVOT)

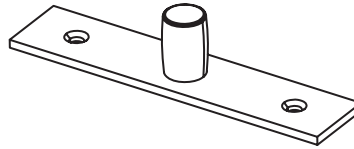

Surface Mount Pivot
(PF-SM-PIVOT)

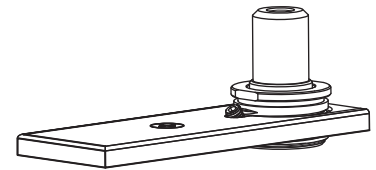

Adjustable Pivot
(PF-ADJ-PIV)

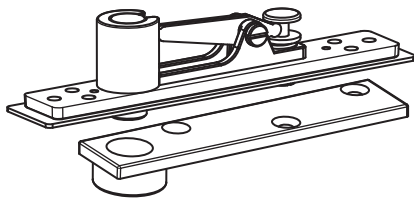

Walking Beam Pivot
(PV-WALKBEAM)

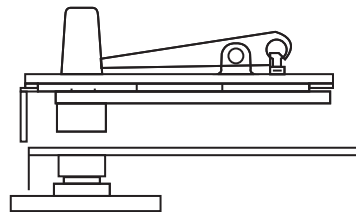

Center Hung Pivot Set
(PV-370)

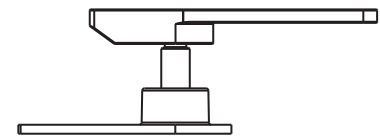

Adjustable End Load Bottom Pivot
(PV-ENDLOAD)

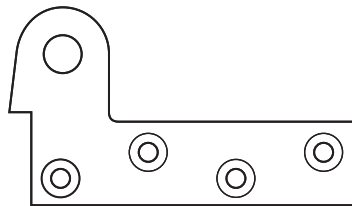

Top Offset Pivot
(PV-180)

ASSA ABLOY

The global leader in
door opening solutions

Prices Effective June 1, 2017

Copyright © 2017, Rockwood Manufacturing Company, an ASSA ABLOY Group company. All rights reserved.
Reproduction in whole or in part without the express written permission of Rockwood Manufacturing Company is prohibited.

Norton Low Energy Operators				
Part #	Description	Finish	Voltage	Price
OP-5710.689	Push/Pull Barrier Free Power Operator	689 (US28 eqv.)	120V	4,793.00
OP-5710.690	Push/Pull Barrier Free Power Operator	690 (US20 eqv.)	120V	5,512.00

Auto Operator Accessories			
Part #	Description	Finish	Price
OP-505-PB	6" Square, Hard Wired Push Button	32D	173.00
OP-506-PB	6" Round, Hard Wired Push Button	32D	173.00
OP-531-PB	6" Square, Wireless Push Button (requires 539 RFR)	32D	284.00
OP-533-PB	6" Round, Wireless Push Button (requires 539 RFR)	32D	284.00
OP-539-RFR	Radio Frequency Receiver (433 MHz)	Black	146.00
OP-700-SGL	Touchless Wall Switch - 2 3/4" wide	32D	463.00
OP-700-DBL	Touchless Wall Switch - 4 1/2" wide	32D	463.00



6" Square Push Button
(OP-505-PB, OP-531-PB)



6" Round Push Button
(OP-506-PB, OP-533-PB)



Touchless Wall Switch
(OP-700-SGL)



Touchless Wall Switch
(OP-700-DBL)



Radio Frequency Receiver
(OP-539-RFR)

Signage Kit (supplied standard)

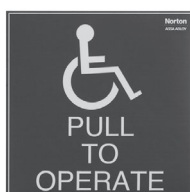

ASSA ABLOY

The global leader in door opening solutions

Prices Effective June 1, 2017

Copyright © 2017, Rockwood Manufacturing Company, an ASSA ABLOY Group company. All rights reserved. Reproduction in whole or in part without the express written permission of Rockwood Manufacturing Company is prohibited.

Mechanical Locking Hardware

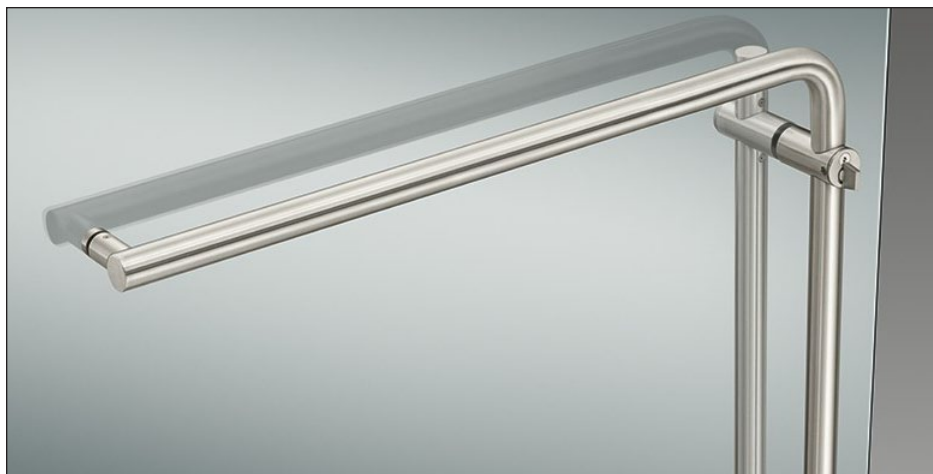

Locking Door Pulls		Finish		
Post Mount - Round		32D/630	32/629	314E
Part #	Description			
LP3301DBD	Half Height Pull - Bolts Down	1,017.00	1,138.00	1,378.00
LP3301DBU	Half Height Pull - Bolts Up	1,097.00	1,229.00	1,469.00
LP3301FHD	Full Height Pull - Bolts Down	1,176.00	1,317.00	1,557.00
LP3301FHU	Full Height Pull - Bolts Up	1,269.00	1,421.00	1,661.00
Post Mount - Round - Dummy Pull				
DP3301DBD	Half Height Pull - Bolts Down	814.00	870.00	1,054.00
DP3301DBU	Half Height Pull - Bolts Up	878.00	939.00	1,118.00
Horizontal Push/Pull Bar Option - Half Height – Bolts Down (DBD)				
LP3301DBDPMPB	Post Mount Both Sides	1,458.00	1,634.00	1,874.00
Horizontal Push/Pull Bar Option - Half Height – Bolts Up (DBU)				
LP3301DBUPMPB	Post Mount Both Sides	1,458.00	1,634.00	1,874.00

Locking Door Pull Accessories		Finish			
Part #	Description	28/628	32D/630	32/629	314E
LPS01	Top Strike - $\frac{3}{4}$ " x $1\frac{1}{2}$ " x 3"	39.00	67.00	67.00	39.00
LPS02	Top Strike - w/Rubber Stop - $\frac{3}{4}$ " x $2\frac{1}{2}$ " x 3"	39.00	67.00	67.00	39.00
LPS03	Top Strike - Stainless Steel - $\frac{1}{20}$ " x $1\frac{1}{8}$ " x $2\frac{1}{4}$ "		31.00	31.00	39.00
LPS04	Transom Strike - $1\frac{1}{4}$ " Dia. x $4\frac{1}{2}$ "		91.00	91.00	126.00
LPS05	Transom Strike - $1\frac{1}{4}$ " Sq. x $4\frac{1}{2}$ "		106.00	106.00	147.00
LPS06	Mortised Header Strike - 2" Dia.		167.00	187.00	230.00
Part #	Description		26/625	26D/626	314E
570	Dust Proof Strike		24.00	24.00	26.00

DBD and DBU priced as 51" overall. Add $\$12/\text{in.}$ over 96" long for full height or 51" long for half height. Horizontal push/pull option, add $\$12/\text{in}$ over 36".

ASSA ABLOY

The global leader in
door opening solutions

Prices Effective June 1, 2017

Copyright © 2017, Rockwood Manufacturing Company, an ASSA ABLOY Group company. All rights reserved. Reproduction in whole or in part without the express written permission of Rockwood Manufacturing Company is prohibited.



Center Housing (only) - Prepped for Yale Mortise Lock					Finish		
Part # (Add Finish)	Housing Prep	Size	Handing	Glass Sizes	32D/630	32/629	314E
CLH-PAS-BC	Passage	6" x 10"	N/A	B, C	432.00	497.00	497.00
CLH-ENT-LH-BC	Entry	6" x 10"	LH	B, C	432.00	497.00	497.00
CLH-ENT-LHR-BC	Entry	6" x 10"	LHR	B, C	432.00	497.00	497.00
CLH-ENT-RH-BC	Entry	6" x 10"	RH	B, C	432.00	497.00	497.00
CLH-ENT-RHR-BC	Entry	6" x 10"	RHR	B, C	432.00	497.00	497.00
CLH-OFF-LH-BC	Office	6" x 10"	LH	B, C	432.00	497.00	497.00
CLH-OFF-LHR-BC	Office	6" x 10"	LHR	B, C	432.00	497.00	497.00
CLH-OFF-RH-BC	Office	6" x 10"	RH	B, C	432.00	497.00	497.00
CLH-OFF-RHR-BC	Office	6" x 10"	RHR	B, C	432.00	497.00	497.00
CLK-BC	Keeper for Latch	6" x 10"	N/A	B, C	420.00	483.00	483.00
Add for Other Lock Preps (Net)					60.00	60.00	60.00

Cylinders					Finish		
Part # (Add Finish)	Keyway	Cyl Length	Collar	Keyed	15/619	14/618	314E
MC-PARA-250-KR	Para	1 1/8"	1/4"	Random	70.00	77.00	80.50
MC-SCHL-250-KR	Schlage C	1 1/8"	1/4"	Random	70.00	77.00	80.50
MC-PARA-250-0B	Para	1 1/8"	1/4"	Bitted	70.00	77.00	80.50

Prices Effective June 1, 2017

Copyright © 2017, Rockwood Manufacturing Company, an ASSA ABLOY Group company. All rights reserved.
 Reproduction in whole or in part without the express written permission of Rockwood Manufacturing Company is prohibited.

ASSA ABLOY

The global leader in
 door opening solutions

Mechanical Locking Hardware (cont.)

Entry Mortise Locks (Less Cylinder)				Finish		
Part # (Add Finish)	Lock Function	Lever Style	Rose	15/619	14/618	314E
ML-ENT-AUR3-LC	Entry	AU	R3	788.00	906.00	906.00
ML-ENT-CRR3-LC	Entry	CR	R3	788.00	906.00	906.00
ML-ENT-PBR3-LC	Entry	PB	R3	788.00	906.00	906.00
ML-ENT-JNR3-LC	Entry	JN	R3	905.00	1041.00	1041.00
ML-ENT-TBR3-LC	Entry	TB	R3	905.00	1041.00	1041.00
ML-ENT-TCR3-LC	Entry	TC	R3	905.00	1041.00	1041.00
ML-ENT-TNR3-LC	Entry	TN	R3	905.00	1041.00	1041.00
ML-ENT-TRR3-LC	Entry	TR	R3	905.00	1041.00	1041.00
ML-ENT-TSR3-LC	Entry	TS	R3	905.00	1041.00	1041.00
ML-ENT-UBR3-LC	Entry	UB	R3	905.00	1041.00	1041.00
ML-ENT-UCR3-LC	Entry	UC	R3	905.00	1041.00	1041.00

Passage Mortise Locks				Finish		
Part # (Add Finish)	Lock Function	Lever Style	Rose	15/619	14/618	314E
ML-PAS-AUR3	Passage	AU	R3	677.00	779.00	779.00
ML-PAS-CRR3	Passage	CR	R3	677.00	779.00	779.00
ML-PAS-PBR3	Passage	PB	R3	677.00	779.00	779.00
ML-PAS-JNR3	Passage	JN	R3	784.00	902.00	902.00
ML-PAS-TBR3	Passage	TB	R3	784.00	902.00	902.00
ML-PAS-TCR3	Passage	TC	R3	784.00	902.00	902.00
ML-PAS-TNR3	Passage	TN	R3	784.00	902.00	902.00
ML-PAS-TRR3	Passage	TR	R3	784.00	902.00	902.00
ML-PAS-TSR3	Passage	TS	R3	784.00	902.00	902.00
ML-PAS-UBR3	Passage	UB	R3	784.00	902.00	902.00
ML-PAS-UCR3	Passage	UC	R3	784.00	902.00	902.00



AU



CR



JN



PB



TB



TR



UB



TN



TC



TS



UC

ASSA ABLOY

The global leader in
door opening solutions

Prices Effective June 1, 2017

Copyright © 2017, Rockwood Manufacturing Company, an ASSA ABLOY Group company. All rights reserved.
Reproduction in whole or in part without the express written permission of Rockwood Manufacturing Company is prohibited.



Office Mortise Locks (Less Cylinder)				Finish		
Part # (Add Finish)	Lock Function	Lever Style	Rose	15/619	14/618	314E
ML-OFF-AUR3-LC	Office	AU	R3	800.00	920.00	920.00
ML-OFF-CRR3-LC	Office	CR	R3	800.00	920.00	920.00
ML-OFF-PBR3-LC	Office	PB	R3	800.00	920.00	920.00
ML-OFF-JNR3-LC	Office	JN	R3	917.00	1055.00	1055.00
ML-OFF-TBR3-LC	Office	TB	R3	917.00	1055.00	1055.00
ML-OFF-TCR3-LC	Office	TC	R3	917.00	1055.00	1055.00
ML-OFF-TNR3-LC	Office	TN	R3	917.00	1055.00	1055.00
ML-OFF-TRR3-LC	Office	TR	R3	917.00	1055.00	1055.00
ML-OFF-TSR3-LC	Office	TS	R3	917.00	1055.00	1055.00
ML-OFF-UBR3-LC	Office	UB	R3	917.00	1055.00	1055.00
ML-OFF-UCR3-LC	Office	UC	R3	917.00	1055.00	1055.00

Deadbolt Locks				Finish			
Part # (Add Finish)	Description	Size	Glass Sizes	32D/630	32/629	28/628	314
PF-DBLOCK-BC	Deadbolt	2 5/8" x 6"	B, C	346.00	397.00	251.00	277.00
PF-DBSTRIKE-BC	Strike for Deadbolt	2 5/8" x 6"	B, C	333.00	383.00	231.00	254.00
PFD-100LBC	Bottom Patch Lock	2 5/8" x 6"	B, C	149.00	171.00	98.20	108.00
PFD-LOCKCYL	1" Cylinder			24.00	24.00	24.00	24.00
PFD-LOCKTT	1" Thumbturn			24.00	24.00	24.00	24.00
Part # (Add Finish)	Description				26/625	26D/626	314E
570	Dust Proof Strike				24.00	24.00	26.00

Prices Effective June 1, 2017

Copyright © 2017, Rockwood Manufacturing Company, an ASSA ABLOY Group company. All rights reserved.
 Reproduction in whole or in part without the express written permission of Rockwood Manufacturing Company is prohibited.

ASSA ABLOY

The global leader in
 door opening solutions

Electrified Hardware



Digital Locks				Finish
Part # (Add Finish)	Lock Type	Location	Glass Size	Mirrored Black
DL-RT1050D	Digital Keypad	Indoor Only	B	778.00

M32 Magnalock		Finish			
Part # (Add Finish)	Description	32D/630	32/629	28/628	335
MAG-M32BD	M32 Magnalock - 600 lbs, 12/24VDC	686.00		Base Unit	
MAG-M32B-SS	M32 Magnalock - 12/24VDC w/Split Strike	758.00		Base Unit	
MAG-DC32	Dress Covers - M32		131.00	56.80	62.50

M370/M670 Magnalock		Finish		
Part # (Add Finish)	Description	28/628	335	313
MAG-M370	M370 Magnalock - 600 lbs, 12/24VDC	538.00	592.00	592.00
MAG-M670	M670 Magnalock - 1100 lbs, 12/24VDC	644.00	709.00	709.00

M380/M680 Magnalock		Finish		
Part # (Add Finish)	Description	28/628	335	313
MAG-M380BDX	M380 Magnalock w/REX - 600 lbs, 12/24VDC	840.00	923.00	923.00
MAG-M680BDX	M680 Magnalock w/REX - 1100 lbs, 12/24VDC	1,175.00	1,293.00	1,293.00

Securitron's 335 finish is satin black.
Securitron's 313 finish is dark bronze.

ASSA ABLOY

The global leader in
door opening solutions

Prices Effective June 1, 2017

Copyright © 2017, Rockwood Manufacturing Company, an ASSA ABLOY Group company. All rights reserved.
Reproduction in whole or in part without the express written permission of Rockwood Manufacturing Company is prohibited.

Accessories		Finish	
Part # (Add Finish)	Description	28/628	335
MAG-UHB-XX-8	Universal Header Bracket	93.80	103.00
MAG-UHB-XX-12	Universal Header Bracket	133.00	147.00
MAG-HEB-1-8	Header Extension Bracket 1" x 1", 8" Long	52.60	62.90
MAG-HEB-1-12	Header Extension Bracket 1" x 1", 12" Long	57.80	73.20
MAG-HEB-2-8	Header Extension Bracket 2" x 2", 8" Long	68.00	82.30
MAG-HEB-2-12	Header Extension Bracket 2" x 2", 12" Long	74.50	84.70
MAG-HEB-3-8	Header Extension Bracket 3" x 3", 8" Long	84.70	96.30
MAG-HEB-3-12	Header Extension Bracket 3" x 3", 12" Long	89.90	106.50
MAG-GDB	Glass Door Bracket	86.40	
MAG-AKG	Adhesive Kit for GDB	205.00	

Vista Magnetic Locks		Finish
Part # (Add Finish)	Description	28/628
MAG-V2M600DB	Vista Magnetic Lock - 600 lbs, 12/24VDC	254.00
MAG-V2M1200DB	Vista Magnetic Lock - 1200 lbs, 12/24VDC	373.00
MAG-GDB-V2M	Glass Door Bracket for V2M600 Locks	93.80
MAG-HEB-V2M600	Header Extension Bracket for V2M600	71.60
MAG-HEB-V2M1200	Header Extension Bracket for V2M1200	86.40

Concealed Magnetic Locks		Finish
Part # (Add Finish)	Description	32D/630
MAG-SAM-1224VDC	Shear Magnalock - 12/24VDC, Self Aligning	1,185.00
MAG-SAM2-24VDC	Shear Magnalock - 24VDC, Mini Version	934.00

Card Readers		Finish
Part # (Add Finish)	Description	Black
RD-R100-1H-PA	R100, Prox, Wireless Reader w/ 1:1 Hub	970.00
RD-R100-1H-SE	R100, iCLASS SE, Wireless Reader w/ 1:1 Hub	970.00
RD-R100-DCA	R100 Dress Cover, Aluminum	42.00 (US28)

Power Supplies		Finish
Part # (Add Finish)	Description	Beige
PS-AQD3-4C	Power Supply - 3/1.5A, 12/24VDC, 4 PTC Outputs	353.00
PS-AQD5-4C	Power Supply - 5/3A, 12/24VDC, 4 PTC Outputs	435.00
PS-BPS-12/24-1	Dual Voltage Power Supply - 12/24VDC, 1A	351.00

Securitron's 335 finish is satin black.

ASSA ABLOY

The global leader in
door opening solutions

Prices Effective June 1, 2017

Copyright © 2017, Rockwood Manufacturing Company, an ASSA ABLOY Group company. All rights reserved.
Reproduction in whole or in part without the express written permission of Rockwood Manufacturing Company is prohibited.

ASSA ABLOY is the global leader in door opening solutions, dedicated to satisfying end-user needs for security, safety and convenience

ASSA ABLOY

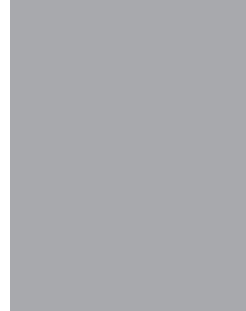
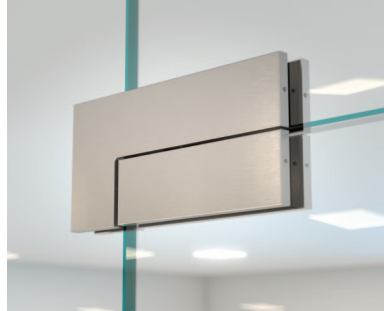

300 Main Street
Rockwood, Pennsylvania 15557
P: 855.594.6989 • F: 844.851.8665
www.assaabloyglass.us
orders.glassolutions@assaabloy.com

Prices Effective June 1, 2017

Copyright © 2017, Rockwood Manufacturing Company, an ASSA ABLOY Group company. All rights reserved.
Reproduction in whole or in part without the express written permission of Rockwood Manufacturing Company is prohibited.

GS-PB 06/2017