

IVES®

Price book 5

Effective August 12, 2017 • Rev. 8/17



This price list supersedes and cancels all previous price lists. Prices shown are subject to change without notice.

Administrative Offices

Allegion Administrative Office
11819 N. Pennsylvania St.
Carmel, IN 46032
allegion.com/us

Placing orders

You can place orders with Allegion via the fax number or email listed below:

Fax#: 1-877-424-8494
Email: Order_lves@allegion.com

Customer Care

Our Customer Care Representatives are available for questions or assistance.

You can reach them at **877-671-7011** (Press 1 for Sales Support | Press 2 for Product Support | Press 3 for SSC) or through the email addresses listed below:

Sales Support

Carolinas

(North Carolina, South Carolina, Virginia)
Carolinas_Sales_Support@allegion.com

Central

(Arkansas, Illinois, Iowa, Kansas, Missouri, Nebraska, Oklahoma)
Central_Sales_Support@allegion.com

Chicago

(Illinois-Northern, Wisconsin)
Chicago_Sales_Support@allegion.com

Florida

Florida_Sales_Support@allegion.com

Great Lakes

(New York, Pennsylvania)
Great_Lakes_Sales_Support@allegion.com

Metro New York

Metro_New_York_Sales_Support@allegion.com

Michigan

Michigan_Sales_Support@allegion.com

Mid Atlantic

(Delaware, Maryland, New Jersey)
Mid_Atlantic_Sales_Support@allegion.com

Midwest

(Indiana, Kentucky, Ohio, West Virginia)
Midwest_Sales_Support@allegion.com

Mountain States

(Colorado, Idaho, Montana, Nevada, Utah, Wyoming)
Mountain_States_Sales_Support@allegion.com

New England

(Connecticut, Main, Massachusetts, New Hampshire, Rhode Island, Vermont)
New_England_Sales_Support@allegion.com

North Central

(Minnesota, North Dakota, South Dakota)
North_Central_Sales_Support@allegion.com

Northern California

Northern_California_Sales_Support@allegion.com

Northwest

(Alaska, Oregon, Washington)
Northwest_Sales_Support@allegion.com

South

(Alabama, Georgia, Louisiana, Mississippi, Tennessee)
South_Sales_Support@allegion.com

Southern California

(California-Southern, Hawaii)
Southern_California_Sales_Support@allegion.com

Southwest

(Arizona, New Mexico)
Southwest_Sales_Support@allegion.com

Texas

Texas_Sales_Support@allegion.com

Technical Product Support

Hinges, O/H Stops, Accessories

Accessories_TechProdSupport@allegion.com

Request for Quote

Carolinas

(North Carolina, South Carolina, Virginia)
Carolinas.Quotes@allegion.com

Central

(Arkansas, Illinois, Iowa, Kansas, Missouri, Nebraska, Oklahoma)
Central.Quotes@allegion.com

Chicago

(Illinois-Northern, Wisconsin)
Chicago.Quotes@allegion.com

Florida

Florida.Quotes@allegion.com

Great Lakes

(New York, Pennsylvania)
GreatLakes.Quotes@allegion.com

Metro New York

Metro.Quotes@allegion.com

Michigan

Michigan.Quotes@allegion.com

Mid Atlantic

(Delaware, Maryland, New Jersey)
MidAtlantic.Quotes@allegion.com

Midwest

(Indiana, Kentucky, Ohio, West Virginia)
Midwest.Quotes@allegion.com

Mountain States

(Colorado, Idaho, Montana, Nevada, Utah, Wyoming)
Mtn.States.Quotes@allegion.com

New England

(Connecticut, Main, Massachusetts, New Hampshire, Rhode Island, Vermont)
NewEngland.Quotes@allegion.com

North Central

(Minnesota, North Dakota, South Dakota)
NorthCentral.Quotes@allegion.com

Northern California

NoCal.Quotes@allegion.com

Northwest

(Alaska, Oregon, Washington)
Northwest.Quotes@allegion.com

South

(Alabama, Georgia, Louisiana, Mississippi, Tennessee)
South.Quotes@allegion.com

Southern California

(California-Southern, Hawaii)
SoCal.Quotes@allegion.com

Southwest

(Arizona, New Mexico)
Southwest.Quotes@allegion.com

Texas

Texas.Quotes@allegion.com

Terms and Conditions ii-v
How to use this book vi
Index by Product Number vii
Keys to Finishes viii-ix
Hinges..... 1-15
Continuous Hinge..... 16-23
Pivots24-26
Architectural Hardware.....27-88
Warranty Inside Back Cover

BAA/ARRA

For a list of available BAA/ARRA compliant products please contact your local SSC or Customer Care at 877-671-7011

Allegion General Terms and Conditions of Sale and Service

1. GENERAL/ACCEPTANCE. (a) This Agreement contains the only terms and conditions by which Company will quote and sell Deliverables to Customer; (b) The terms "purchase order" or "order" for the purposes of this Agreement include the term "request for quotation," as appropriate; (c) This Agreement supersedes all pre-printed or boilerplate terms and conditions set forth in any purchase order issued by Customer; (d) No reference herein to Customer's purchase order will in any way incorporate different or additional terms and conditions, all of which Company hereby expressly objects to; (e) **ANY ACCEPTANCE BY COMPANY OF CUSTOMER'S PURCHASE ORDER IS EXPRESSLY CONDITIONED ON THE CUSTOMER'S ASSENT TO AND ACCEPTANCE OF THE TERMS AND CONDITIONS CONTAINED IN THIS AGREEMENT;** (f) Company reserves the right to decline any order, in whole or in part, for any reason.

2. ORDERS.

a. **Order Processing.** When Customer wishes to place an order for Deliverables, it will deliver to Company a purchase order. All such purchase orders must (i) be in a written format acceptable to Company, (ii) be legible, (iii) include a purchase order number, (iv) include Customer's account number, invoice address, ship to address, shipping method, shipper's letter of instruction for international shipments, part number, pricing, and designated contact information, (v) include, if applicable, any special configuration ID numbers, necessary programming information, special factory instructions, and requested specifications regarding a particular finish, handing, design, backset, or strike, (vi) reference any applicable pricing discounts under an ongoing buying program or based on a written quote from Company, along with the applicable buying program number or quotation number, and (vii) not combine buying program and quoted product on the same order.

b. **Minimum Orders.** In the event the order value does not meet any required minimum net Deliverable value, Company may, at its sole discretion, (i) increase the quantity of items in the order to meet the minimum net Deliverable value requirement; (ii) apply a minimum order charge; (iii) reject the order, or (iv) waive the requirement, provided that the waiver of a requirement for one order shall not constitute a waiver of the requirement for any future orders.

c. **Acceptance of Purchase Orders.** Company will endeavor to (i) acknowledge receipt of each purchase order issued in accordance with this Agreement, and (ii) notify Customer whether Company accepts or rejects the purchase order. If Company fails to accept or reject a purchase order within a reasonable time period, such failure to respond will be deemed a rejection of the entire order. Orders that combine buying program and quoted product on the same order will be routed back to your local SSC office in order to review subject purchase order.

d. **Changes to Order/ Cancellation of Orders.** Additional terms and conditions regarding order changes and cancellations are available on the Allegion customer website, **WHICH TERMS ARE EXPRESSLY INCORPORATED HEREIN BY REFERENCE.** Unless otherwise provided herein, Customer acknowledges that (i) requesting a Change Order may cause a delay in the scheduled shipment date, a longer lead time or result in a new scheduled shipment date; (ii) Orders may not be changed after 48 hours of Company's order acknowledgment; (iii) After 48 hours of Company's order acknowledgment, all changes to an accepted purchase order will be subject to a Change Order charge of 25% of the net Deliverable value, plus the cost of labor and fabrication or raw material that Company incurred prior to the receipt of the Change Order from Customer, or that may be required due to the Change Order; (iv) the requested change may result in additional charges for labor, fabrication, and raw material, and (v) if Customer cancels an order or portion of an order that includes Deliverables that have been manufactured and prepped for shipping, a 45% restocking fee will apply. Notwithstanding the foregoing, Customer cannot change or cancel credential orders, reader orders, biometrics orders or any non-cataloged, special, Custom or nonstandard items once they have been placed. All cancelled orders for a Non Recurring Expense (NRE), credential orders, reader orders, biometrics orders, and/or Custom orders will be subject to a cancellation charge of 100% of the acknowledged price.

e. **Add-ons.** Add-on orders will not be accepted. Additions to orders will be entered as separate stand-alone orders and must qualify for all terms of sale, including discounts, on an individual basis.

f. **Fast-Track Orders.** No changes or cancellations will be accepted on the 24-Hour Fast Track Program. For 3-day Fast Track orders, changes and cancellations may only be requested by Customer within 24 hours of Company's order acknowledgment if the order has not shipped. For 5-Day Fast Track orders, changes and cancellations may only be requested by Customer if the order has not shipped and if the request is made to Company within 48 hours of Company's order acknowledgment. Return Material Authorization (RMA) for Deliverables must be processed through Fast Track Customer Service.

g. **Steelcraft Orders.** For all Steelcraft orders, changes or cancellations are allowed without penalty only if made within 48 hours of Company's order acknowledgment, and provided that the order has not shipped. Some exceptions do apply – please consult the factory. Changes are not allowed on Rapid Program orders after the order has been entered and acknowledged. After 48 hours of Company's order acknowledgment, all changes or cancellations are subject to a charge of 25% of the order. Unless otherwise specified by Company in writing, any changes to orders acknowledged by Company that affect the delivery date will be deemed a new order and will require acknowledgement by Company as provided in this Section. Additional products, features, terms and conditions regarding the Rapid Program are available on the Allegion customer website, **WHICH TERMS ARE EXPRESSLY INCORPORATED HEREIN BY REFERENCE.**

3. PRICES, INVOICES AND PAYMENT.

a. **Prices.** The prices in Company's Price Book are subject to change at any time, without notice to Customer. Company may charge Customer additional amounts if Customer requests special packing, marking, shipment, product modification, or engineering services. Oral prices specified by Company are null and void. Quote numbers must be referenced on Customer's purchase order in order for the Company's quoted pricing to apply. Orders that do not reference a quote number will receive buy program pricing or book net pricing. Quoted prices are for those specific products quoted for a specified job, and are subject to the Price Book in effect at the time Company receives the order.

b. **Taxes.** Prices do not include any present or future federal, state or local property, license, privilege, sales, use, excise, gross receipts or other like taxes or assessments which may result from transactions or any services performed in connection therewith. Any taxes, charges, or duties imposed by any governmental authority on the sale of Deliverables will be paid by Customer, in addition to the selling price specified by Company.

c. **Payment Terms.** Company will deliver to Customer an invoice with each shipment of Deliverables hereunder. Customer will pay all invoiced amounts within 35 days of the invoice date (subject to any early pay discounts that may be offered to Customer by Company in its sole discretion). Customer will make all payments in United States dollars. Past due invoices will be subject to a late payment service charge of 1.5% per month on any overdue unpaid balance, equivalent to 18% per annum, or the maximum rate permitted by law, whichever is less. Customer shall reimburse Company for all costs of collection, including,

without limitation, reasonable attorneys' fees, for any overdue amount owed by Customer to Company, and such collection costs shall also be subject to interest charges.

4. QUOTATIONS.

a. **Project Quotations.** Project or new construction quotes are restricted to the specific project quoted for the quantities, finishes, and series of Deliverables referenced on the quote. Company reserves the right to require proof of sale of Company products for any quoted project.

b. **Stock Quotations.** Deliverables fulfilling stock quotations may only be used for the following: i) Stocking of the Customer's shelves for small, quick-turn, discretionary projects, or ii) Sale to a general contractor or installer for new construction. Stock quotations may not be used for any project containing any Company no-substitution, specified products. Deliverables purchased under Stock Quotations cannot be redistributed to other Customer branch locations or re-sold to other resellers or used for aftermarket sales, end-user annual contracts or sold over the counter to any walk in trade.

c. **General.** All quotes are subject to this Agreement, unless otherwise specified by Company, and are subject to change at any time prior to Company's acceptance of a purchase order referencing the applicable quote number. Company, its representatives and employees reserve the right, in their sole discretion and for any reason, to refuse a Customer's request to quote a price other than the standard list price, regardless of whether Company or its representatives or employees have previously quoted discounted prices to the Customer on some or all of its orders. Customer's failure to comply with this Section 4 will be considered a material breach of this Agreement, and will entitle Company to immediately terminate any purchase orders and/or Customer's ability to distribute Company's products.

5. SECURITY INTEREST. Customer grants Company, and Company retains, a purchase money security interest and lien on any and all of Customer's rights, title and interest in each Deliverable sold by Company to Customer, wherever located, until the invoice for the applicable Deliverable(s) is paid in full, including any late charges and costs of collection. Customer authorizes Company to, and will assist Company in, taking all necessary steps to perfect and maintain Company's interest in such Deliverables.

6. CREDIT TERMS. Unless Customer pre-pays all of its purchase orders in advance, its purchase orders will be subject to the credit limit and other terms of credit ("Credit Terms") set forth in Company's credit application, which Credit Terms Customer acknowledges are subject to change by Company at any time. Company reserves the right to request payment in advance of shipment or any order or to request adequate assurances for Customer's payment of an order and may withhold or stop shipment, without any liability to Company, until Customer submits payment or adequate assurance of payment.

7. RESALE OF DELIVERABLES. Customer agrees and warrants that it will offer Company products in support of Company-written specifications and will maintain sufficient inventory to adequately support End Users, installers, and/or general contractors' needs. Company may implement an MSRP or a resale pricing programs at any time in its sole discretion. Failure to comply with such program(s) will be considered a material breach of this Agreement, and will entitle Company to immediately terminate any purchase order and/or Customer's ability to distribute Company's products. Customer shall, at its own expense, gain and maintain sufficient knowledge of the industry and products competitive with Deliverables so as to be able to (a) explain in detail to End Users, installers, and/or general contractors the differences between the Deliverables and competing products, (b) ensure that an adequate number of trained, capable and qualified technical personnel with sufficient knowledge of the Deliverables and who have obtained all necessary licenses and permits are available to assist End Users, installers, and/or general contractors, and (c) respond to such End Users, installers, and/or general contractors with respect to the general operation and use of the Deliverables including, but not limited to, (1) acting as a liaison between the End Users, installers and/or general contractors and Company in matters requiring Company participation, (2) providing general product information and configuration support on standard protocols and features, (3) collecting relevant technical problem identification information, and (4) posting and distributing any warranty information concerning the Products in accordance with Company's instructions. Customer is responsible for all service and support resulting from the re-sale of any Deliverable to End-Users, installers and/or general contractors, examples of which may include, but are not limited to, support activities such as installation, initialization, software set-up, training, trouble-shooting, technical support and field service. In the event Customer is unwilling or unable to perform said support activities, Company reserves the right to recover from Customer any and all expenses incurred by Company to resolve the aforementioned End-User, installer and/or general contractor issues. Technical product training is recommended for Customer in order to fully service and support Deliverables purchased from Company that are resold to End-Users, installers and/or general contractors.

8. DEFAULT. If Customer is in default of payment or otherwise with respect to any purchase order or other contract with Company, Company shall have the right, in addition to all other legal remedies and without prejudice to any of its right hereunder, to defer further shipments under that or any other purchase order until such default is corrected and to declare all outstanding bills of Customer to be immediately due and payable.

9. INSPECTION AND DELIVERY.

a. **Inspection.** Customer will inspect all Deliverables immediately after receiving them. Customer will be deemed to have accepted the Deliverables unless Customer notifies Company in writing of any nonconformance within 10 days of delivery and provides Company written evidence reasonably documenting that nonconformance. Inspection of Deliverables at Company's facility is not permitted.

b. **Delivery.** Delivery schedules for Deliverables are based upon current production capacities, material or component availability, and inventory, and may be changed by Company as conditions require. Delivery schedules for services are based upon Company's prompt receipt of, and prompt access to, Customer's equipment and all information necessary to complete the services. In no event will any delivery date be construed as falling within the meaning of "time is of the essence." Partial delivery shall be accepted by Customer and paid for at the price and on the terms stated herein. Any partial delivery shall constitute a separate sale, and payment shall be separately made when due. If any part of a delivery hereunder is not delivered by Company in accordance with Customer's purchase order, this Agreement shall not be affected thereby.

10. TITLE & RISK OF LOSS. Unless otherwise specified by Company, (i) where the Customer is located in the United States, all Deliverables will be sold "Uniform Commercial Code, FOB Origin, Company's factory"; and (ii) where the Customer is located outside of the United States, all Products will be sold "Ex-works, Company's factory (Incoterms 2010)." In either instance, title and risk of loss will pass to Customer upon delivery to the carrier at Company's

factory, provided, however, as set forth herein, Company shall retain a security interest in the Deliverables until full payment has been made therefore, and Customer agrees, upon request, to do all things and acts necessary to protect Company's interest by adequately insuring the Deliverables against loss or damage from any cause and to have Company named as an additional insured. Customer will promptly provide Company with a copy of the relevant certificate of insurance upon Company's request.

11. SHIPPING.

a. **Freight Charges.** Company will ship all Deliverables in accordance with Company's freight shipment guidelines, which are set forth on the My Allegion Portal ("Freight Shipping Guidelines"), **WHICH TERMS ARE EXPRESSLY INCORPORATED HEREIN.**

b. **Rush Charges.** Expedited order options are available as set forth in Company's Freight Shipping Guidelines.

c. **Packing and Marking.** Company will pack, mark, and ship Deliverables according to its standard procedures for shipment, unless the parties agree, in writing, that Company will comply with any special instructions provided by Customer. Special instructions may result in an increased price.

d. **International Shipments.** For all international orders, a Shipper's letter of instruction must be submitted in writing with the order. Failure to do so will result in the order being rejected. Complete adherence to this order requirement will be strictly enforced. Company will not be held liable for any charges resulting from delays due to lack of complete required information being supplied.

e. Once received by the Company, a purchase order cannot be combined with any other order to increase average order size as it relates to Company's Freight Shipping Guidelines. However, for orders placed under Company's FastTrack 24 Hour/5 Day Program (available for Schlage, Von Duprin, LCN and Glynn-Johnson products); ii) FastTrack 24 Hour/3 Day Program (available for Ives products); or ProExpress (available for specific product lines stated in the ProExpress price book for Falcon, Ives, Glynn Johnson, LCN, Schlage and Von Duprin products), the applicable brands or product categories may, subject to certain order requirements identified by Company, be combined on a single order to increase average order size used in Company's Freight Shipping Guidelines.

12. CLAIMS. All claims must be submitted in writing to Company as follows: (i) All claims for prices must be submitted within thirty (30) days from the date of invoice; (ii) All claims regarding Deliverable quantity or incorrect orders must be submitted within ten (10) days from the date of delivery; (iii) All claims for damage to Deliverables (while in the care, custody, and control of Company) must be submitted within thirty (30) days from the date of invoice; (iv) All claims for loss or damage to Deliverables while in the care, custody, and/or control of a carrier will be the responsibility of Customer, unless otherwise agreed by the parties.

13. PRODUCT CHANGES. Company's product policy is one of ongoing update and revision, and accordingly, Company reserves the right to change, without notice, the design of, or the process of manufacturing, the Deliverables covered by this Agreement.

14. PRODUCT USAGE LIMITATION. Customer agrees: (i) not to sell or use a Deliverable in any manner contrary to the manner in which the Deliverable is intended to be used; and/or (ii) not to modify the design of any Deliverable for use with another product without the prior written consent of Company.

15. PRODUCT RETURNS. Unless otherwise agreed by the parties in writing, Deliverables that are correctly furnished by Company per the purchase order may not be returned unless Customer receives written authorization from Company. If returns are authorized by Company, a return merchandise authorization ("RMA") number must be provided by Company. Deliverables identified under such RMA must be returned to Company within 90 days of issuance of the RMA. Such RMA number and any accompanying RMA documents, the original invoice number, and a written explanation for the return must be included with the returned Deliverables in order for Company to inspect and approve a credit for the return. **For warranty returns,** a credit in the amount of the original purchase price will only be issued if, after Company's receipt and inspection of the returned Deliverables, Company confirms, in its sole discretion, the defect is valid and approves the return. **For non-warranty returns/convenience returns,** in the event Company approves such a return, in its sole discretion, the following shall apply: (a) the total amount of Deliverables requested to be returned shall be a minimum of \$250.00; (b) a credit will be made to Customer's account in the amount of the original purchase price less freight and a handling charge of 45% of the net material on the original invoice; and (c) only Deliverables that are new, current, standard, non-obsolete, non-specially manufactured, unused, in their original condition as at the time of sale by Company to Customer, in their original packaging and in Customer's inventory less than 180 days from the date of shipment by the Company, and not ordered as part of a master key solution may be considered by Company for return. Such credit will only be issued if, after Company's receipt and inspection of Deliverables, Company approves the return. The amount of final credit will be determined upon receipt at the factory and following Company's inspection and analysis of the condition of the returned material. Company retains the right to deny credit to anyone for any reason.

16. CONFIDENTIAL INFORMATION.

a. **Non-Use And Non-Disclosure.** Customer shall not use the Confidential Information of the Company except for the purpose of performing its obligations under this Agreement or exercising the rights granted herein (the "Purpose"). Customer shall protect Confidential Information of the Company from disclosure and unauthorized use in the same manner that it protects its own Confidential Information, but in no event shall such standard of care be less than reasonable care. Customer may disclose Confidential Information of the Company only to its employees who require such information for the Purpose and who are subject to confidentiality obligations at least as protective as those set forth herein.

b. **Proprietary Information and Advice.** (a) All designs, data, and specifications provided by Company are proprietary and may not be disclosed or reused by Customer without the prior written consent of Company; (b) Company assumes no obligation or liability for any advice given by Company, the results obtained, or damages incurred as a result of such advice, and all such advice is given and accepted at Customer's risk.

c. **Return.** Upon the termination or expiration of a purchase order or this Agreement or upon the request of the Company, the Customer agrees to end all further use of, to immediately return to the Company the original version of, and to delete or destroy all copies of, any and all Confidential Information of the Company.

17. TRADEMARKS. Except as agreed to by Company in writing, Customer agrees not to (a) use Company's name in any form of publicity; or (b) use, create, register or market, directly or indirectly, in whole or in part, Company's names, logos, brands, or any other trademarks, or names that are now or may hereafter be owned by Company, as part of Customer's corporate

or business name, as part of an internet domain name, uniform resource locator (URL), or in any way connected with Customer's business, trade address or other designations. Upon termination of this Agreement or upon the request of company for any reason, any use of Company's trademarks or names will be immediately discontinued.

18. LIMITED WARRANTY.

COMPANY MAKES NO OTHER WARRANTIES EXCEPT THOSE STATED IN COMPANY'S LIMITED WARRANTY IN EFFECT ON THE DATE COMPANY ACCEPTS EACH APPLICABLE PURCHASE ORDER ("LIMITED WARRANTY"). THE LIMITED WARRANTY MAY BE FOUND IN THE APPLICABLE PRICE BOOK AND ON THE ALLEGION CUSTOMER WEBSITE, WHICH TERMS ARE EXPRESSLY INCORPORATED HEREIN BY REFERENCE. COMPANY WILL MAIL CUSTOMER A HARD COPY OF THIS WARRANTY UPON CUSTOMER'S WRITTEN REQUEST. IN THE EVENT THAT CERTAIN DELIVERABLE WARRANTIES ARE NOT FURNISHED BY THE COMPANY TO CUSTOMER, COMPANY WARRANTS ONLY TO CUSTOMER THAT THE DELIVERABLES WILL BE FREE FROM DEFECTS IN MATERIAL AND WORKMANSHIP FOR A PERIOD OF 12 MONTHS FROM THE DATE OF SHIPMENT OF THE DELIVERABLES. COMPANY'S SOLE OBLIGATION UNDER THIS WARRANTY IS LIMITED TO REPAIRING OR REPLACING, AT COMPANY'S OPTION, THE DEFECTIVE DELIVERABLE, PROVIDED WRITTEN NOTICE OF THE DEFECT OR NONCONFORMANCE IS PROVIDED BY CUSTOMER WITHIN 30 DAYS OF DISCOVERY OF THE DEFECT OR NONCONFORMANCE. COMPANY DISCLAIMS ALL OTHER WARRANTIES, EXPRESS OR IMPLIED, WITH RESPECT TO THE DELIVERABLES, INCLUDING BUT NOT LIMITED TO, ANY IMPLIED WARRANTIES OF NON-INFRINGEMENT, MERCHANTABILITY, OR FITNESS FOR A PARTICULAR PURPOSE.

a. **Exclusions.** The provisions of this Limited Warranty do not apply to Deliverables that: (A) are not the proper size for the application; (B) are not installed in accordance with Company's published installation instructions; (C) are installed with improper or incorrect parts and/or are used for purposes for which they are not designed or intended; (D) have been repaired or altered without the Company's prior written consent; (E) have been subjected to misuse, abuse, negligence or accident; (F) have been improperly stored, installed, maintained or operated; (G) have been used in violation of written instructions provided by Company to Customer; (H) have been subjected to improper temperature, humidity, or other environmental conditions, or (I) have been affected by normal wear and tear. In addition, the provisions of this Limited Warranty do not apply to any defects or issues with the design or performance of equipment or products not manufactured by Company, nor does it apply to any code compliance or permit requirements for the assembly, installation, erection or construction of any goods. Company is not responsible for loss or damage resulting from use of Deliverables in conjunction with parts or systems not manufactured by Company. Accessories or products furnished by the Company, but manufactured by others, shall carry whatever warranty the manufacturers have conveyed to the Company and which can be passed to Customer.

b. **Services.** Company warrants that its services will be free from defects in material and workmanship for a period of 12 months from the date of completion of the particular items of service. Company's sole obligation under this service warranty is limited to repair or reperformance, at its option of the service, provided however, if repair or reperformance is either impractical or impossible, the Company will refund to Customer that portion of the price paid to Company for any defective service, provided written notice of the defect or nonconformance is provided by Customer within 30 days of discovery of the nonconformance.

c. **Notification.** Customer agrees to immediately notify Company in writing if any claim is made against Customer for any damages caused by any modules, parts, products, service or other Deliverables which may be the direct result of any defect in the manufacture of such aforementioned products. Customer agrees to cooperate with Company and its counsel in the defense of such claim and Customer agrees not to settle such claim without Company's written consent. If Customer fails to notify Company of such claim or fails to cooperate in such defense as aforesaid, then Company shall be discharged from any obligations under this Section and shall have no further liability to Customer.

d. **Exceptions.** The following costs and expenses are not covered by the provisions of these limited warranties: (i) labor costs for the removal and reinstallation of Deliverables or other manufacturer's products; (ii) shipping and freight expenses required to return Deliverables to Company; (iii) normal maintenance; and (iv) economic losses. In addition, the provisions of this warranty are not applicable to anything other than defects in Company's material (products only) or workmanship.

19. LIMITATION OF REMEDIES.

CUSTOMER'S EXCLUSIVE AND SOLE REMEDY ON ACCOUNT OF, OR IN RESPECT OF, THE FURNISHING OF NON-CONFORMING DELIVERABLES, SHALL BE TO (A) SECURE REPAIR OR REPLACEMENT OF THE PRODUCTS; OR (B) SECURE REPAIR OR RE-PERFORMANCE OF THE SERVICES OR TO OBTAIN A REFUND OF THE PRICE PAID FOR THE DEFECTIVE SERVICE, ALL AT COMPANY'S OPTION. IN NO EVENT WILL THE COMPANY'S MAXIMUM LIABILITY EXCEED THE SELLING PRICE FOR THE DELIVERABLE. THE WARRANTY, OBLIGATIONS AND LIABILITIES OF COMPANY (INCLUDING ITS SUPPLIERS) AND THE RIGHTS AND REMEDIES OF CUSTOMER ARE EXCLUSIVE AND ARE IN LIEU OF AND CUSTOMER HEREBY WAIVES AND RELEASES ALL OTHER WARRANTIES, OBLIGATIONS, REPRESENTATIONS OR LIABILITIES EXPRESS OR IMPLIED ARISING BY LAW, IN CONTRACT, TORT (INCLUDING NEGLIGENCE OR STRICT LIABILITY) OR OTHERWISE, INCLUDING BUT NOT LIMITED TO (I) ANY IMPLIED WARRANTY OF MERCHANTABILITY OR FITNESS FOR A PARTICULAR PURPOSE OR ANY WARRANTY IMPLIED THROUGH COURSE OF PERFORMANCE, COURSE OF DEALING, OR USAGE OF TRADE OR (II) CLAIMS ARISING OUT OF THE NEGLIGENCE OF COMPANY OR COMPANY'S SUPPLIERS OR (III) ANY OTHER CLAIM ARISING OUT OF, CONNECTED WITH, OR RESULTING FROM THE PERFORMANCE OF COMPANY OR FROM THE DESIGN, MANUFACTURE, SALE, REPAIR, LEASE OR USE OF THE DELIVERABLE, OR ANY COMPONENT THEREOF, DELIVERED OR RENDERED HEREUNDER OR OTHERWISE.

20. INDEMNIFICATION AND LIMITATION OF LIABILITY. a. Customer shall indemnify, defend and hold Company, and its officers, directors, employees, customers, Affiliates, suppliers, users and agents, (collectively the "Indemnitees") harmless from and against any and all damages, claims, losses, expenses, costs, obligations, liabilities, including without limiting the generality of the foregoing, liabilities for court costs and attorneys' fees, suffered directly or indirectly by an Indemnitee by reason of, or arising out of any injury, death or loss to any person, or injury to any property (collectively, "Damages"), received or sustained by any person(s) or property, arising out of, occasioned by, attributable or related to i) any breach of any representation or warranty made by Customer, its officers, directors, employees, affiliates, users, agents, representatives or customers to Company or any third party, (ii) any failure by Customer to perform or fulfill any of its covenants, acts and/or omissions to Company or to any third party, or (iii) any litigation, proceeding or claim by any

Terms and Conditions

third party relating in any way to the obligations of Customer and/or the Deliverables sold by Company to Customer hereunder. Customer shall not consummate any settlement of any indemnified claim without the Indemnitees' prior written consent. Customer's obligation to indemnify Indemnitees will continue in full force and effect notwithstanding the termination or expiration of any order under this Agreement. In any claim against an Indemnitee by an employee of Customer or any subcontractor or anyone directly or indirectly employed by any of them or anyone for whose acts they may be liable, the indemnification obligations set forth in this Section shall not be limited in any way by or for Customer or any subcontractor under any applicable worker's compensation act, disability or other employee benefit act, or insurance coverage. This provision shall survive termination of any order or Agreement. **IN NO EVENT WILL COMPANY, ITS OFFICERS, DIRECTORS, EMPLOYEES, CUSTOMERS, AFFILIATES, USERS AND AGENTS, (NOR COMPANY'S SUPPLIERS) BE LIABLE FOR ANY INCIDENTAL, CONSEQUENTIAL, INDIRECT, SPECIAL, OR PUNITIVE DAMAGES OF ANY KIND OR NATURE UNDER ANY CIRCUMSTANCES INCLUDING, BUT NOT LIMITED TO, LOSS OF USE OF THE PRODUCTS, SERVICE INTERRUPTION, LOSS OF PROFITS, LOSS OF REVENUE, LOSS OF INTEREST, LOST GOODWILL, LOSS OF DATA, WORK STOPPAGE, IMPAIRMENT OF OTHER GOODS, LOSS BY REASON OF SHUTDOWN OR NON-OPERATION, INCREASED EXPENSES OF OPERATION, OR CLAIMS OF CUSTOMER'S CUSTOMERS, OR ANY OTHER LOSSES OR DAMAGES ARISING OUT OF ANY LACK OR LOSS OF USE OF THE DELIVERABLES WHETHER BASED ON CONTRACT, WARRANTY, TORT (INCLUDING, BUT NOT LIMITED TO, STRICT LIABILITY OR NEGLIGENCE), PATENT INFRINGEMENT, OR OTHERWISE, EVEN IF ADVISED OF THE POSSIBILITY OF SUCH DAMAGES.**

b) **INTELLECTUAL PROPERTY INDEMNITY.** Company makes no representation or warranty to the Customer that the Deliverables shall not infringe any intellectual property rights including, without limitations, claims arising from patent, copyright, trademark, trade secret, or other intellectual property infringement. Customer agrees to hold Company harmless from and defend the Company against any such claim of intellectual property infringement, including any Damages resulting from that claim, the cost of complying with any preliminary or permanent injunction, and all other costs of defense (including the attorneys' fees and costs), in connection with the foregoing.

c) To the extent that applicable law does not permit any limitations set out in this Agreement, such limitation shall not be applied or invoked. Nothing in this Agreement will be interpreted to disclaim liability of Company or the Indemnitees for gross negligence or willful misconduct. The limitations of remedy and liability herein shall not be interpreted to affect Company's obligations, if any, for claims for (i) property damage, (ii) personal injury, or (iii) wrongful death asserted by persons who are not parties to or beneficiaries of this Agreement. Further, the limitations of remedy and liability herein shall not be interpreted to limit Company's or Customer's right, if permitted by applicable law, to assert a claim for contribution among joint tortfeasors in connection with a claim by a person who is not a party to this Agreement.

21. CERTIFICATIONS. Certification of Deliverables for compliance with UL and ANSI standards are tested and performed by third-party independent laboratories. Any field modification or alteration of certified Deliverables will void certification and Company is not liable to Customer to certify any modified or altered Deliverable.

22. TERM FOR CLAIMS. NO ACTION ARISING OUT OF ANY CLAIMED BREACH OF THIS AGREEMENT BY COMPANY MAY BE BROUGHT BY CUSTOMER MORE THAN ONE (1) YEAR AFTER THE CAUSE OF ACTION HAS ARISEN.

23. CONSUMER PRODUCTS WITH RESPECT TO "CONSUMER PRODUCTS" AS DEFINED UNDER THE MAGNUSON-MOSS WARRANTY ACT ("MMWA"), THE FOLLOWING STATEMENTS ARE MADE. (A) SOME STATES OR LOCAL LAWS DO NOT ALLOW LIMITATIONS ON HOW LONG AN IMPLIED WARRANTY LASTS, SO THE ABOVE LIMITATION MAY NOT APPLY TO YOU; (B) IF ANY IMPLIED WARRANTY IS PROVIDED UNDER THE MMWA, IT IS LIMITED TO THE DURATION OF THE WARRANTY PROVIDED IN SECTION 18 ABOVE. (C) SOME STATES OR LOCAL LAWS DO NOT ALLOW THE EXCLUSION OR LIMITATION OF INCIDENTAL OR CONSEQUENTIAL DAMAGES, SO THE ABOVE LIMITATION OR EXCLUSION MAY NOT APPLY TO YOU; AND (D) THIS WARRANTY GIVES YOU SPECIFIC LEGAL RIGHTS AND YOU MAY ALSO HAVE OTHER RIGHTS WHICH VARY FROM STATE TO STATE OR LOCATION TO LOCATION.

24. FORCE MAJEURE/EXCUSABLE DELAY. Any delay or failure of Company to perform its obligations hereunder will be excused to the extent that it is caused by an event or occurrence beyond Company's control such as, by way of example and not by way of limitation, acts of God, acts by any governmental authority (whether valid or invalid), governmental laws and regulations not presently in effect, fires, floods, windstorms, explosions, riots, natural disasters, wars, sabotage, accidents, labor problems (including, without limitation, lockouts, strikes, and slowdowns) at Company's facility, its source plant or their suppliers, inability to obtain power, material, labor equipment, or transportation, or court injunction or order. The delivery date will be extended for a time equal to that of the delay and the schedule for Company's performance will be deemed adjusted to that effect.

25. ENTIRE AGREEMENT AND AMENDMENT. This Agreement, together with the attachments, exhibits, webpages, or supplements specifically referenced and incorporated herein, constitute the entire agreement between Company and Customer with respect to the matters contained herein and supersede all previous communications, representations, or agreements, either oral or written between Company and Customer. No agreement or understanding varying or expanding this Agreement will be binding upon either party unless it is in writing and signed by a duly authorized representative of each party hereto.

26. CONFLICTS. In the event of any conflict or inconsistency between the terms of any agreement, or any part of an agreement or the various documents (including, but not limited to, electronic documents) between Company and Customer, unless the parties agree otherwise in writing, the various components of the agreements shall be given the following precedence (in descending order of precedence): a) any master agreement or long term agreement between Company and Customer; b) any specific terms, conditions and/or warranties of the individual products or Deliverables; c) the terms and conditions of this Agreement, and d) any purchase order.

27. UNSATISFACTORY CREDIT/TERMINATION FOR INSOLVENCY OR DEFAULT. Customer shall furnish Company with statements evidencing Customer's financial condition as Company may, from time to time, reasonably request, and shall notify Company immediately of any and all events that may have a material adverse effect on Customer's business or financial condition. If Company determines, in its sole discretion, that Customer's financial condition or creditworthiness is inadequate or unsatisfactory, then in addition to

Company's other rights, Company may without liability or penalty, take any of the following actions: (i) modify the payment terms for any outstanding and/or future purchases; (ii) cancel any previously accepted orders; (iii) delay any further shipment of Deliverables to Customer; or (iv) any combination of the above.

Company may immediately terminate an order from Customer by giving written notice to Customer in the event of the happening of any of the following or any other comparable event: (i) insolvency of the Customer; (ii) filing of a petition in bankruptcy by or against the Customer; (iii) appointment of a receiver or trustee for the Customer; (iv) execution of an assignment for the benefit of creditors by the Customer, all of which will allow Company to demand reclamation of all affected orders; (v) Customer ceases or threatens to cease to trade; (vi) Company determines that Customer does not meet or no longer meets the credit requirements of Company or Customer's credit account is closed; (vii) any Customer violation of law, specifically including, without limitation, those laws set forth in this Agreement.

In the event of termination in accordance with this section, Company will not be obligated to accept any existing or additional orders from Customer and Company will be released from its obligation to deliver under orders accepted prior to such termination. The rejection or termination of any order by Company will not entitle Customer to any termination or severance compensation, or to any payment in respect to any goodwill established by Customer, or render Company liable for damages on account of the loss of prospective profits, or on account of any loss, expenditure, investment or obligation incurred or made by Customer.

No action taken under this Section 27 by Company (nor any failure of Company to act under this Section 27) will constitute a waiver by Company of any of its rights to enforce Customer's obligations, including the obligation of Customer to make payments as required under this Agreement. Upon termination of any order, all amounts owed by Customer to Company will become immediately due and payable, whether or not otherwise then due or payable.

28. CREDIT RISK ON RESALE OF DELIVERABLES. Customer is responsible for all credit risks with respect to, and for collecting payment for, all Deliverables sold to third parties (including End Users, installers, and/or general contractors) whether or not Customer has made full payment to Company for such Deliverables. The inability of Customer to collect payment for any Deliverable shall not affect Customer's obligation to pay Company for any Deliverable.

29. GOVERNING LAW; VENUE; AND EXPENSES. Any dispute or claim relating to this Agreement shall be governed by and construed according to the laws of the State of Indiana (excluding its conflict of laws principles); and not by the provisions of the 1980 United Nations Convention on the International Sale of Goods. Any disputes or claims shall be instituted and maintained in the courts of the State of Indiana. Customer consents to the exercise of jurisdiction over it by such courts and agrees that Indiana is not an inconvenient forum for any action arising from or relating to this Agreement. Customer agrees to pay for all expenses (including, but not limited to, collection costs, court costs and attorneys' fees) incurred by Company in enforcing the obligations of Customer under this Agreement.

30. RELATIONSHIP OF THE PARTIES. Nothing in this Agreement or any other document creates an employment, partnership, joint venture, or agency relationship between Company and Customer, including that of franchisee/franchisor. No party will have any power or authority to enter into any commitment on behalf of or otherwise bind the any other party on any matter. No employee of Customer will be deemed to be an employee of Company. If any provision of this Agreement is deemed to create a franchise relationship or business opportunity between the Parties, then Company may terminate any purchase order or this Agreement or the Parties shall negotiate in good faith to modify this Agreement so as to effect the original intent of the Parties as closely as possible in a mutually acceptable manner in order that the transactions contemplated hereby are consummated as a reseller agreement and not a franchise or business opportunity agreement.

31. SETOFF. Customer does not have the right to setoff or to back charge against any amounts which become payable to Company under this Agreement or otherwise. Company will not accept responsibility for backcharges for the cost of material or labor by Customer or any third party.

32. ELECTRONIC COMMUNICATIONS AND ELECTRONIC SIGNATURES. Both parties expressly agree to electronic transactions and acknowledge that documents they sign electronically will bind them to the same extent as a paper signature. Customer represents and warrants to Company that only employees authorized to bind Customer legally shall electronically sign any document under this Agreement. Customer shall comply with any method of electronic communication/payment processing specified by Company, including electronic funds transfer, pay-on-receipt processes/systems, order transmission, releases, electronic signature, and electronic communication systems, including, without limitation, the use of electronic data interchange ("EDI") portals. Notwithstanding the foregoing, e-mails, even those containing a signature block of one of Company's representatives, shall not constitute a signed writing.

33. COMPLIANCE WITH APPLICABLE LAWS.

a. **General.** Company and Customer will comply with all applicable federal, state and municipal laws, regulations, codes, ordinances and orders that pertain to the Deliverables, including but not limited to full compliance with any applicable provisions of The Health Insurance Portability and Accountability Act. Where the Customer is located outside the United States, or where the customer intends to ship the product outside the United States, the Customer shall be responsible for compliance with all U.S. export laws, and for filing all U.S. Electronic Export Information, as applicable.

b. The Customer acknowledges and agrees that: (i) it shall not violate applicable laws and regulations in performing its duties under this Agreement; (ii) it does not and shall not engage in any conduct that shall violate any applicable anti-bribery or anti-corruption laws or regulations; (iii) it (and its owners, officers, directors, employees and agents) shall not pay, offer, promise or authorize the payment of, either directly or indirectly, anything of value (including but not limited to cash, gifts and entertainment) to (a) any government official or employee of any government; (b) any official or employee of any department, agency, or instrumentality of a government; (c) any employee of any corporation or entity owned or controlled by a government; (d) any family member of such officials or employees; (e) any political party, party official, or political candidate; or (f) any other persons, owners, officers, directors, employees and agents of any corporation or entity; to improperly or illegally assist in obtaining or retaining business (including but not limited to any contracts, avoidance of duties or reduction of tariffs, reduction of taxes or to obtain money owed, or to obtain regulatory approval) or for the purpose of causing, soliciting or inducing the sale and purchase

of the Deliverables by any party, and (iv) it has full knowledge of and will comply with the Company's Code of Conduct for Business Partners as set forth on the Allegion customer website, **WHICH IS HEREBY INCORPORATED BY REFERENCE.**

c. The Customer shall indemnify and hold the Company harmless from any claim, demand, expense or cost arising from any breach of this Article.

d. The Customer shall permit the Company to conduct an audit or review of the Customer's financial books and records and business operations at such other times that the Company considers it necessary to confirm compliance with this provision. Such audit may be conducted by representatives of the Company or, at the Company's sole discretion, by a certified public accounting firm selected by the Company. The Customer shall cooperate with any inquiries from the Company's Ethics & Compliance Group.

e. A violation of this provision constitutes a material breach of this Agreement and the Company may terminate any purchase order or this Agreement immediately, with no opportunity to cure, in accordance with Section 27 of this Agreement.

f. Notwithstanding the foregoing provisions of this Section 33, (i) Company is not responsible for obtaining or maintaining any permits for the performance of services or the verification or compliance with any code requirements relative to the performance of services, (ii) to the extent any sale of Deliverables pursuant to this Agreement may require approval of the U.S. Government, Company's obligations under this Agreement are conditioned upon the grant of such approval and upon compliance by Customer with any restrictions imposed by the U.S. Government in connection with such approval, and (iii) in the event the Deliverables are to be used in a nuclear facility, the Customer shall, prior to such use, arrange for insurance or governmental indemnity protecting Company against liability. The Customer hereby releases and agrees to indemnify Company and its suppliers for any nuclear damage including, but not limited to, loss of use, in any manner arising out of the nuclear incident, whether alleged to be due, in whole or in part by Company or its suppliers.

g. **No Inducements.** Each party represents to each other that neither it nor any person acting on its behalf has, in contravention of any applicable law, given or offered to give or will give or offer to give, any sum of money or other material consideration to any person, directly or indirectly, as an inducement to obtain business hereunder or to influence the granting of licenses or other governmental permissions to enter into this Agreement or perform obligations hereunder.

h. **Equal Employment Opportunity.** Company is a U.S. federal contractor that complies with Executive Order 11246, as amended, and applicable regulations in 41 CFR Parts 60-1 through 60-60, 29 U.S.C. § 793 and applicable regulations in 41 CFR § 60-741; and 38 U.S.C. § 4212 and applicable regulations in 41 CFR Part 60-250 and 60-300. **THE FOLLOWING PROVISIONS ARE INCORPORATED HEREIN BY REFERENCE:** Executive Order 11246, as amended by Executive Order 13672, and 41 CFR § 60-4.3(a); Executive Order 11701 and 41 CFR §§ 60-250.5(a), 60-300.5; Executive Order 11758 and 41 CFR § 60-741.5(a); U.S. Immigration laws, including the L-1 Visa Reform Act of 2004 and the H-1B Visa Reform Act of 2004; and Executive Order 13496.

i. **Ethical Business Conduct.** Customer shall adopt and comply with Company's Business Partner Code of Conduct which is **EXPRESSLY INCORPORATED HEREIN BY REFERENCE.**

34. REPRESENTATIONS AND WARRANTIES. Customer represents, warrants and covenants to Company that: (a) it has the right, power, and authority to enter into this Agreement and fully perform its obligations hereunder; (b) it has all necessary rights in and to its respective Content and Marks for use within the scope of this Agreement, including the licenses granted herein; and (c) it complies, and at all times shall comply, with all laws, rules, and regulations in effect that are applicable to its performance under this Agreement, including obtaining all such approvals and/or permits as may be required hereunder.

35. NO THIRD-PARTY BENEFICIARY. Each party is entering into this Agreement solely based on the representations contained herein for its own purposes and not for the benefit of any third party.

36. NOTICES AND CHANGE OF ADDRESS. All notices or other communications under this Agreement shall be in writing and delivered in person, or sent by receipted courier, express mail, e-mail, or postage prepaid certified or registered mail, addressed to the party for whom it is intended, at the addresses set forth in this Agreement. Either party may change its address for notice by giving written notice to the other party. Any notice or other communication shall be deemed given no later than the date actually received. Notice by courier, express mail, certified mail, or registered mail shall be deemed given on the date it is officially recorded as delivered and, in the absence of such record of delivery, it shall be rebuttably presumed to have been delivered on the third Business Day after it was deposited. Notices sent by e-mail require tangible confirmation of receipt from addressee.

37. ASSIGNMENT. Customer may not assign this Agreement without the prior written consent of Company. Company may assign its rights and delegate its duties under this Agreement, without the prior consent of Customer, to an Affiliate, or to a third party in the event of a spin-off, merger, business combination, consolidation or sale of all, or substantially all, of its assets or business that are related to this Agreement. The rights and duties in this Agreement shall bind and inure to the benefit of any such assignee.

38. SEVERABILITY. If any provision of this Agreement is held to be invalid, illegal, or unenforceable under any statute, regulation, ordinance, executive order, or other rule of law, that provision will be deemed severed to the extent necessary to comply with such statute, regulation, ordinance, order, or rule. In the event such provision is deemed severed, the parties will negotiate in good faith to arrive at an alternative arrangement approximating the original business objective of the parties. The remaining terms and conditions of this Agreement will remain in effect.

39. NO IMPLIED WAIVER. The failure of either party at any time to require performance by the other party of any provision of this Agreement will in no way affect the right to require such performance at any time thereafter, nor will the waiver of either party of a breach of any provision of this Agreement constitute a waiver of any succeeding breach of the same or any other provision.

40. MISCELLANEOUS. (a) This Agreement does not make either party the agent or legal representative of the other party. Neither party is authorized to create any obligation on behalf of the other party including, but not limited to, the obligation for payment of any service or warranty obligation hereunder; (b) The rights and remedies herein reserved to Company are cumulative and additional to any other rights and remedies provided at law or equity; (c) The official text of this Agreement is in the English language. If this Agreement is translated into another language, the English text will govern any question with respect to interpretation; (d) The headings in this Agreement are for convenience of reference only and do not affect the meaning of this Agreement in any manner.

DEFINITIONS.

Capitalized terms have the meanings set forth in this Section, or in the Section in which they first appear in this Agreement.

"Agreement" means these Allegion Terms and Conditions of Sale and Service, together with any applicable Country Supplement or Region Supplement provided by Company, and all of the documents referenced herein or therein.

"Affiliate" means any Person that directly or indirectly, through one or more intermediaries, controls, is controlled by, or is under common control with, the Company. The term "control" (including the terms "controlled by" and "under common control with") means the possession, directly or indirectly, of the power to direct or cause the direction of the management and policies of a Person, whether through the ownership of voting securities, by contract or otherwise.

"Business Day" means any day except Saturday, Sunday or any other day on which commercial banks located in the United States are authorized or required by Law to be closed for business.

"Company" means Schlage Lock Company, LLC or any subsidiary or affiliate thereof selling products that are part of the Allegion product portfolio. Schlage Lock Company and/or its subsidiary or affiliates will be severally but not jointly liable under the Agreement.

"Company Marks" refers to the Marks of Company.

"Confidential Information" shall mean any and all information provided by either party to the other party pertaining to the disclosing party's business. Confidential Information shall include, but not be limited to, any bidding lists, formulae for products, manufacturing processes, production techniques, packaging processes, methods, research materials, ideas, marketing plans and related materials, quality standards, test results and data, apparatus, engineering drawings, contract documents, computer software, hardware, or firmware, business activities information such as financial information, reports, projections, books and records, customer and supplier information, and operations, customer and supplier lists and data, specifications, know how, and other Proprietary Information or Trade Secrets (as defined herein) that either party may furnish to the other party. Confidential Information shall not include information that: (a) is or becomes publicly known if such public knowledge or disclosure is not the result of any act or failure to act on the part of the receiving party; (b) is, at the time of disclosure, already known to the Receiving Party without utilizing the Confidential Information; (c) is information disclosed to the Receiving Party by a third party which is not to the Receiving Party's knowledge, after inquiry of the third party, under a duty of confidentiality to the Disclosing Party; or (d) is independently developed by the Receiving Party without the use of Confidential Information. The Receiving Party shall have the burden of proof as to prior knowledge and absence of breach. Confidential Information may be furnished in any tangible or intangible form including, but not limited to, writings, drawings, computer and other electronic media, logic diagrams, component specifications, graphs, prototypes, samples, or verbal communications and regardless of whether such information is marked or designated as "confidential." For the avoidance of doubt, all information, knowledge or data disclosed by Company to Customer, regardless of whether disclosed in written, tangible, oral, visual or other form, including, without limitation, sample products, equipment, software, or other objects or material, provided by Company to Customer, and all information, knowledge or data which was obtained by Customer from visits to Company's facilities, shall be considered "Confidential Information" under this Agreement.

"Content" means all information (including without limitation any text, music, sound, photographs, video, graphics, data or software), in any medium, on a particular Company Web page or Website or in Marketing Materials.

"Customer" means the purchaser of Deliverables from Company.

"Deliverables" means any good or service or both purchased by Customer from Company under these General Terms and Conditions of Sale and Service.

"End Users" means the purchaser that (a) has acquired a Deliverable from Customer for (i) its own and its Affiliate's/Affiliates' internal use and not for resale, remarketing or distribution or (ii) incorporation into its own products and (b) is an individual or entity, other than any federal, state or local agency, office or division.

"IP" means all intellectual property and industrial property rights comprising or relating to/ of the following: (a) Patents; (b) Trademarks; (c) internet domain names, whether or not Trademarks, registered by any authorized private registrar or Governmental Authority, web addresses, web pages, website and URLs; (d) works of authorship, expressions, designs and design registrations, whether or not copyrightable, including copyrights and copyrightable works, software and firmware, application programming interfaces, architecture, files, records, schematics, data, data files, and databases and other specifications and documentation; (e) Trade Secrets; and (f) all other intellectual property and industrial property rights, and all rights, interests and protections that are associated with, equivalent or similar to, or required for the exercise of, any of the foregoing, however arising, in each case whether registered or unregistered and including all registrations and applications for, and renewals or extensions of, such rights or forms of protection pursuant to the Laws of any jurisdiction throughout in any part of the world.

"Marketing Materials" means all marketing brochures, buckslips, pamphlets, emails, text, call scripts or other material, whether in printed format, audio or audiovisual format, or in any other format, that contain any (i) Content relating to the Company Deliverables or (ii) Company Marks.

"Marks" means collectively the domain names, trademarks, trade names, service marks, trade dress, logos, and the like used or provided by either party for use in connection with this Agreement.

"Patents" means all patents (including all reissues, divisionals, provisionals, continuations and continuations-in-part, re-examinations, renewals, substitutions and extensions thereof), patent applications, and other patent rights and any other Governmental Authority-issued indicia of invention ownership (including inventor's certificates, petty patents and patent utility models).

"Person" means a person or entity.

"Price Books" mean Company's current Price Book in effect for the applicable Deliverable being purchased by Customer.

"Trade Secrets" means and includes business or technical information of either party, including processes, formulas, devices, techniques, compilations and other material that a party attempts to maintain in secret and that derive commercial value for such party from not being generally known to the public or readily ascertainable through independent development or reverse engineering.

How to use this book

Products are shown in four groups; Hinges, Continuous Hinges, Pivots and Architectural Hardware. Each group is organized in numerical order and no longer in alpha/numerical. Particularly in the Architectural Hardware group, the products are organized by the part number regardless of the prefix or suffix. Example WS33X Wall Stop will be in numerical sequence of 33; CS115 Crash Stop numerical sequence 115.

For convenience there are a few exceptions where an accessory follows the associated product; example, the COR72 Coordinator is followed by MBI Mounting Bracket.

The service parts section of previous books has been changed. Service parts for many products have been listed with the product. A full list of available service parts may be obtained from the Ives website. You may also contact your local sales representative or Ives customer service for more assistance on the availability of service parts.

Information contained in the list price table:

Model: Column contains model family description and general catalog information

Substrate: Column contains material substrate information (i.e. aluminum, brass, steel)

Model Number: Column contains the model number and additional prefix for other distinguishing features or packaging type. Package type prefixes (C, CGC, SC, SP, SPS) descriptions are as follows:

C – Carded

CGC – Commercial Grade Carded

SC – Schlage Branded Card

SP – Slim Pack

SPS – Schlage Branded Slim Pack

Item Number: Item number field is UPC number or sku number, where available.

Weight: Contains the total weight of product in box quantity. Not all weights shown.

Order Quantity: Contains the minimum order quantity for identified product, if required.

Box Quantity : Number of items in master carton or special package type.

Markings Cartons: Markings (e.g., door locations, stock reference numbers) on individual product cartons will be provided with no charge.

Products available to mark include the following:

Architectural Hinges	Push/Pull Plates
Continuous Hinges	Protection Plates
Pivots	Coordinators
8000 Series Pulls	Flush Bolts
9000 Series Push bars/Pull combinations	Vandal Resistant Trim

Numerical Index

Part No.	Page	Part No.	Page	Part No.	Page	Part No.	Page	Part No.	Page
hinges									
3PBI	1,2	DP2	27	FB52	36	FS446	48	VR914M-NL	57
3CBI	3,4	MB2F	27	FB53	36	WS447	49	919	57
3CBI HW	5	MB2V	27	054	36	FS448	49	950	57
3CBI WT	6,7	2	27	059	36	WS449	49	955	58
3SPI	7	LG7	27	59	37	FS450	49	960	58
5PBI	8,9	COR7G	27	60	37	FS452	49	962	58
5BBI	9,10	07	28	060	37	SB453	49-50	990	58
5BBI HW	11	COR9G	28	061	38	FS455	50	991	58
5BBI SC	12	FS9	28	61	38-39	FB457	50	RL1152	59
5BBI SCHW	12	LG10	28	FB61	39	FB458	50	FS1153	59
5BBI WT	13,14	CL11	28	FB62	39	RB470	50	FS1154	59
1010	15	LG11	28	63	39	RB471	50	SB1600M1	59
1011	15	WS11	28	64	39	RB472	50	SB1600M2	59
1012	15	WS11X	29	SR64	39	481	51	SB1630	60
1020	15	CL12	29	SR65	39	482	51	SB1640	60
1021	15	LG12	29	WS65	39	FS495	51	30X6	61
continuous hinges									
600	16	FS13	29	SR66	39	FS496	51	3107	62
602	16	LG13	29	066	40	FS497	51	3125	62
611	16	CL14	29	66	40	FS544	51	31251	62
700	16	LG14	29	69	40	FS555	51	31252	62
702	16	FS17	29	70	40-41	506	52	8102HD	66
705	16	R14	29	71	41	507	52	8103HD	66-67
711	16	AS18	29	72	41	507B	52	8103EZ	67
715	16	FS18	29	73	41	508	52	8105	67
700CS	18	WS20	29	90	41	508C	52	8111	68
711CS	18	WS20X	30	CS115	41	509C	52	8112	68
715CS	18	CL21	30	HB159	41	510C	52	8121	68
026XY	19	CL21A	30	218	42	510BC	52	8145EZHD	68
027XY	19	CL22	30	221	42	511BC	52	8169	69
040XY	19	22	30	222	42	543	52	8181	69
041XY	19	25	30	223	42	543B	52	8189	69
045HD	19	Q26	30-31	227	42	554	52	8190HD	69
046HD	19	RL30	31	230	42	558B	53	8190EZHD	70
053HD	20	RL30A	31	253	43	559B	53	8200	71
054HD	20	FB31	31	261	43	571	53	8281	72
112HD	20	COR32	31	262	43	572	53	8302	72-73
114XY	20	COR42	31	265	43	574	54	8303	74-75
157XY	20	COR52	32	299	43-44	575	54	8305	75-76
210HD	21	COR60	32	325	44	580	54	8311	77
224HD	21	COR72	32	326	44	581	54-55	8312	77
224XY	21	FL20	32	327	44	582	55	8320	77
pivots									
7212	24	FL32	32	330	44	585	55	8371	78
7212V	24	FL44	32	335	44	586	55	8372	78
7215	24	MB1	32	336	44	601	55	8373	78
7215F	24	MB1F & MB1V	32	345	45	620	56	8400	79-80
7222	24	MB2	32	347	45	STK685	56	8700	82
7226	24	MBVF & MB2V	32	349	45	STK685L	56	8800	82
7226F	25	MB3F & MB3V	32	FB358	45	U696	56	8848	82
7227	25	FB32	33	SB360	45	696-700	56	8975	82
7227F	25	RL32	33	WS401-CVX	45	698	56	9100HD	83
7230F	25	RL32A	33	WS401-CCV	45	700	56	9103EZ	83-84
7237F	25	FB33	33	WS402-CVX	45	701	56	9145EZHD	84-85
7244F	25	WS33	33	WS402-CCV	45	VR810DT	57	9190HD	85
7245F	26	WS33X	33	WS404	46	VR814DT	57	9190EZHD	86
7253	26	RL36	33	405	46	VR810NL	57	9264	87
7255	26	RL36A	33	WS406/407-CVX	46	VR814NL	57	9264F	87
7255J	26	RL38	33	WS406/407-CCV	46	VR810NL-V	57	9266	87
7256	26	40	33-34	FS410	47	VR814NL-V	57	9266F	87
7259	26	FS40	34	411	47	AS895	57		
9110F	26	WS40	34	430	47	VR900	57		
architectural hardware									
CBI	27	FB41	34	FS434	47	VR904	57		
DP1	27	FS41	34	R435	47	VR900LLP	57		
LG1	27	42	34	FS436	47	VR904LLP	57		
		FB42	35	R437	47	VR910DT	57		
		FS42	35	FS438	48	VR914DT	57		
		FS43	35	FS439	48	VR910NL	57		
		WS45	35	FS441	48	VR914NL	57		
		WS45X	35	WS443	48	VR910M-DT	57		
		S48	35	FS444	48	VR914M-DT	57		
		FB51	35	WS445	48	VR910M-NL	57		

Key to Finishes

	666	US3	Bright Brass, Clear Coat	Aluminum
	667	US4	Satin Brass, Clear Coat	Aluminum
		US5	Brass, Blackened, Satin Relieved	Aluminum
	668	US10	Satin Bronze, Clear Coat	Aluminum
	703	US10B	Dark Bronze, Oil Rubbed	Aluminum
	669	US14	Bright Nickel, Clear Coat	Aluminum
	670	US15	Satin Nickel, clear Coat	Aluminum
	671	US19	Flat Black Coated	Aluminum
	672	US26	Bright Chrome	Aluminum
	702	US26D	Satin Chrome	Aluminum
			Aged Bronze	Aluminum
	673		Aluminum Clear Coat	Aluminum
			Almond	Aluminum
			Black	Aluminum
			White	Aluminum
	627	US27	Satin Aluminum, Clear Coated	Aluminum
	441		Satin Stainless Anodized	Aluminum
	628	US28	Satin Aluminum, Clear Anodized	Aluminum
	688		Satin Brass Anodized	Aluminum
	709		Satin Bronze Anodized	Aluminum
	710	313AN	Dark Bronze Anodized	Aluminum
	711	315AN	Black Anodized	Aluminum
	712		Bright Chrome Anodized	Aluminum
	713		Satin Chrome Anodized	Aluminum
	605	US3	Bright Brass, Clear Coat	Brass/Bronze
	606	US4	Satin Brass, Clear Coat	Brass/Bronze
	609	US5	Satin Brass, Blackened, Satin Relieved	Brass/Bronze
	611	US9	Bright Bronze, Clear Coat	Brass/Bronze
	612	US10	Satin Bronze, Clear Coat	Brass/Bronze
	613	US10B	Dark Bronze, Oil Rubbed	Brass/Bronze
	614	US10A	Satin Bronze, Relieved, Clear Coated	Brass/Bronze
	616	US11	Satin Bronze, Blackened, Clear Coated	Brass/Bronze
	618	US14	Bright Nickel, Clear Coat	Brass/Bronze
	619	US15	Satin Nickel, Clear Coat	Brass/Bronze
	620	US15A	Satin Nickel, Blackened, Satin Relieved	Brass/Bronze
	625	US26	Bright Chrome	Brass/Bronze
	626	US26D	Satin Chrome	Brass/Bronze
			Aged Bronze	Brass/Bronze
	603	US2G	Zinc Plated	Steel
	604	US2C	Zinc Plated	Steel
	632	US3	Bright Brass, Clear Coat	Steel
	633	US4	Satin Brass, Clear Coat	Steel
	638	US5	Satin Brass, Blackened, Satin Relieved	Steel
	639	US10	Satin Bronze, Clear Coat	Steel
	640	US10B	Dark Bronze, Oil Rubbed	Steel
	641	US10A	Oxidized Satin Bronze, Relieved, Clear Coated	Steel
	643	US11	Satin Bronze, Blackened, Relieved, Clear Coated	Steel
	645	US14	Bright Nickel, Clear Coat	Steel
	646	US15	Satin Nickel, Clear Coated	Steel
	647	US15A	Satin Nickel, Blackened, Relieved, Clear Coated	Steel
	651	US26	Bright Chrome	Steel
	652	US26D	Satin Chrome	Steel
			Aged Bronze	Steel
			White	Steel
			Dull Brass Painted	All
	691		Dull Bronze Painted	All

Contact Ives Customer Service for pricing on additional sizes and finishes

Bold pricing indicates item is in stock and available for **Fast Track** and **ProXpress**

Key to Finishes

IVES FINISH	ANSI/BHMA	US Number	Finish Description	Base Material
SP28	689		Aluminum Painted	All
SP313	695		Dark Bronze Painted	All
SPBLK	622		Flat Black	All
USP	600	USP	Primed For Paint	All
US32	629	US32	Bright Stainless Steel	Stainless Steel
US32-316	629-316	US32-316	Bright Stainless Steel - 316 Series	Stainless Steel - 316
US32D	630	US32D	Satin Stainless Steel	Stainless Steel
US32D-316	630-316	US32D-316	Satin Stainless Steel - 316 Series	Stainless Steel - 316
US32D	654		Satin Stainless Steel	Stainless Steel
Z605	677	US3	Bright Brass, Clear Coat	Zinc
	678	US4	Satin Brass, Clear Coat	Zinc
Z609		US5	Satin Brass, Blackened, Satin Relieved	Zinc
Z613	704	US10B	Dark Bronze, Oil Rubbed	Zinc
Z619		US15	Satin Nickel, Clear Coat	Zinc
Z625	681	US26	Bright Chrome	Zinc
	682	US26D	Satin Chrome	Zinc
Z716			Aged Bronze	Zinc
Z-W			White	Zinc
CLR			Clear	Plastic
BLK			Black	Rubber or Plastic
WHT			White	Rubber or Plastic
GRY			Grey	Rubber
TAN			Tan	Rubber
BRN			Brown	Rubber

HINGES
 CONTINUOUS HINGES
 PIVOTS
 Numerical 1-059
 Numerical 59-437
 Numerical 438-1021
 Numerical 1152-8190
 Numerical 8200-9340

*Bold pricing indicates item is in stock and available for **Fast Track** and **ProXpress***

Notes

HINGES
CONTINUOUS HINGES
PIVOTS
Numerical 1-059
Numerical 59-437
Numerical 438-1021
Numerical 1152-8190
Numerical 8200-9340

Contact Ives Customer Service for pricing on additional sizes and finishes

Bold pricing indicates item is in stock and available for **Fast Track** and **ProXpress**

HINGES
 CONTINUOUS HINGES
 PIVOTS
 Numerical 1-059
 Numerical 59-437
 Numerical 438-1021
 Numerical 1152-8190
 Numerical 8200-9340

DESCRIPTION	SIZE	STEEL BASED		BRASS / STAINLESS BASED		US REFERENCE	BOX	CASE	NOTES	
		BHMA FINISH	LIST	BHMA FINISH	LIST					
 <p>Three Knuckle Plain Bearing Standard Weight</p> <p>For use on standard weight doors with medium frequency usage</p> <p>Available in: Steel w/Steel Pin Brass w/Brass Pin Stainless w/Stainless Pin</p> <p>Non-removable Pin (Steel and Stainless Steel Based 4.5 x 4.5 Hinges add \$3.75 all others add \$8.00 list)</p> <p>Packed with: Wood and machine screws</p> <p>Available options: SEC - Security Screws HT - Hospital tip RC - Round corners SH - Security Studs See page 14 for pricing</p>	3.5"x3.5" (89x89mm)	600	\$10.70	----	\$----	USP	3	24		
		632	15.70	605	54.80	US3	3	24		
		633	11.30	606	45.60	US4	3	24		
		639	11.90	612	42.50	US10	3	24		
		640	15.70	613	54.80	US10B	3	24		
		641	15.70	614	54.80	US10A	3	24		
		643	16.60	616	54.80	US11	3	24		
		646	16.60	619	54.80	US15	3	24		
		651	15.70	625	57.90	US26	3	24		
		652	13.10	626	51.70	US26D	3	24		
		----	----	629	62.60	US32	3	24		
		----	----	630	60.20	US32D	3	24		
		4"x4" (102x102mm)	600	11.80	----	----	USP	3	24	
			632	17.50	605	61.70	US3	3	24	
			633	12.40	606	51.30	US4	3	24	
	639		13.10	612	48.00	US10	3	24		
	640		17.50	613	61.80	US10B	3	24		
	641		17.50	614	61.80	US10A	3	24		
	643		18.30	616	61.80	US11	3	24		
	646		18.30	619	61.80	US15	3	24		
	651		17.50	625	65.10	US26	3	24		
	652		14.70	626	58.30	US26D	3	24		
	----		----	629	70.60	US32	3	24		
	----		----	630	67.80	US32D	3	24		
	4.5"x4" (114x102mm)		600	6.40	----	----	USP	3	24	
			632	12.60	605	35.60	US3	3	24	
			633	6.40	606	29.80	US4	3	24	
		639	7.70	612	27.70	US10	3	24		
		640	11.40	613	35.60	US10B	3	24		
		641	12.10	614	35.60	US10A	3	24		
		643	12.60	616	35.60	US11	3	24		
		646	12.60	619	35.60	US15	3	24		
		651	12.60	625	37.60	US26	3	24		
		652	9.60	626	33.60	US26D	3	24		
		----	----	629	40.70	US32	3	24		
		----	----	630	39.50	US32D	3	24		
		4.5"x4.5" (114x114mm)	600	6.40	----	----	USP	3	24	
			632	12.60	605	35.60	US3	3	24	
			633	6.40	606	29.80	US4	3	24	
	639		7.70	612	27.70	US10	3	24		
	640		12.60	613	35.60	US10B	3	24		
	641		12.60	614	35.60	US10A	3	24		
	643		12.60	616	35.60	US11	3	24		
	646		12.60	619	35.60	US15	3	24		
	651		12.60	625	37.60	US26	3	24		
652	7.30		626	33.60	US26D	3	24			
----	----		629	40.70	US32	3	24			
----	----		630	39.50	US32D	3	24			

Note: Specify BHMA finish code when ordering.

 Indicates products that have EPD documentation available and meet LEED v4.

Contact Ives Customer Service for pricing on additional sizes and finishes

*Bold pricing indicates item is in stock and available for **Fast Track** and **ProXpress***

HINGES

CONTINUOUS
HINGES

PIVOTS

Numerical
1-059Numerical
59-437Numerical
438-1021Numerical
1152-8190Numerical
8200-9340

STEEL BASED

BRASS / STAINLESS BASED

DESCRIPTION	SIZE	STEEL BASED		BRASS / STAINLESS BASED		US REFERENCE	BOX	CASE	NOTES
		BHMA FINISH	LIST	BHMA FINISH	LIST				
 <p>Three Knuckle Plain Bearing Standard Weight</p> <p>For use on standard weight doors with medium frequency usage</p>	5"x4.5" (127x114mm)	600	\$30.40	----	\$ ----	USP	3	24	
		632	45.50	605	83.50	US3	3	24	
		633	32.30	606	69.40	US4	3	24	
		639	34.10	612	64.80	US10	3	24	
		640	45.50	613	83.50	US10B	3	24	
		641	45.50	614	83.50	US10A	3	24	
		643	47.30	616	83.50	US11	3	24	
		646	47.30	619	83.50	US15	3	24	
		651	45.50	625	87.90	US26	3	24	
		652	37.90	626	78.80	US26D	3	24	
		----	----	629	95.40	US32	3	24	
		----	----	630	91.70	US32D	3	24	

Note: Specify BHMA finish code when ordering.

 Indicates products that have EPD documentation available and meet LEED v4.

Contact Ives Customer Service for pricing on additional sizes and finishes

Bold pricing indicates item is in stock and available for **Fast Track** and **ProXpress**

DESCRIPTION	SIZE	STEEL BASED		BRASS / STAINLESS BASED		US REFERENCE	BOX	CASE	NOTES
		BHMA FINISH	LIST	BHMA FINISH	LIST				
 <p>Three Knuckle Concealed Bearing Standard Weight</p> <p>For use on standard weight doors with medium frequency usage</p> <p>Available in: Steel w/Steel Pin Brass w/Brass Pin Stainless w/Stainless Pin</p> <p>Non-removable Pin (Steel and Stainless Steel Based 4.5 x 4.5 Hinges add \$3.75 all others add \$8.00 list)</p> <p>Packed with: Wood and machine screws</p> <p>Available options: SEC - Security Screws HT - Hospital tip RC - Round corners SH - Security Studs</p> <p>TW - Electric Thru Wire See page 14 for pricing and available sizes</p>	3.5"x3.5" (89x89mm)	600	\$24.50	----	\$ ----	USP	3	24	
		632	37.20	605	53.80	US3	3	24	
		633	26.30	606	44.70	US4	3	24	
		639	27.90	612	41.70	US10	3	24	
		640	37.20	613	53.80	US10B	3	24	
		641	37.20	614	53.80	US10A	3	24	
		643	38.80	616	53.80	US11	3	24	
		646	38.80	619	53.80	US15	3	24	
		651	37.20	625	56.80	US26	3	24	
		652	31.10	626	50.80	US26D	3	24	
		----	----	629	61.50	US32	3	24	
		----	----	630	59.10	US32D	3	24	
	4"x4" (102x102mm)	600	26.50	----	----	USP	3	24	
		632	39.90	605	60.60	US3	3	24	
		633	28.20	606	50.30	US4	3	24	
		639	30.00	612	47.10	US10	3	24	
		640	39.90	613	60.60	US10B	3	24	
		641	39.90	614	60.60	US10A	3	24	
		643	41.60	616	60.60	US11	3	24	
		646	41.60	619	60.60	US15	3	24	
		651	39.90	625	63.90	US26	3	24	
		652	33.30	626	57.20	US26D	3	24	
		----	----	629	69.30	US32	3	24	
		----	----	630	66.60	US32D	3	24	
	4.5"x4" (114x102mm)	600	15.00	----	----	USP	3	24	
		632	21.00	605	53.20	US3	3	24	
		633	15.00	606	44.30	US4	3	24	
		639	16.30	612	41.50	US10	3	24	
		640	15.00	613	53.20	US10B	3	24	
		641	15.00	614	53.20	US10A	3	24	
		643	21.00	616	53.20	US11	3	24	
		646	23.40	619	53.20	US15	3	24	
		651	21.00	625	56.40	US26	3	24	
		652	17.70	626	50.20	US26D	3	24	
		----	----	629	61.00	US32	3	24	
		----	----	630	54.20	US32D	3	24	
	4.5"x4.5" (114x114mm)	600	9.50	----	----	USP	3	24	
		632	21.00	605	59.20	US3	3	24	
		633	15.00	606	44.30	US4	3	24	
		639	16.30	612	41.50	US10	3	24	
		640	19.90	613	55.80	US10B	3	24	
		641	19.90	614	53.20	US10A	3	24	
		643	19.90	616	53.20	US11	3	24	
		646	19.90	619	44.10	US15	3	24	
		651	19.90	625	56.40	US26	3	24	
652		11.60	626	47.40	US26D	3	24	652 NRP in FT and ProX	
----		----	629	61.00	US32	3	24		
----		----	630	55.30	US32D	3	24	NRP also in FT and ProX	

Note: Specify BHMA finish code when ordering.

 Indicates products that have EPD documentation available and meet LEED v4.

Contact Ives Customer Service for pricing on additional sizes and finishes

Bold pricing indicates item is in stock and available for Fast Track and ProXpress

HINGES
 CONTINUOUS HINGES
 PIVOTS
 Numerical 1-059
 Numerical 59-437
 Numerical 438-1021
 Numerical 1152-8190
 Numerical 8200-9340

HINGES
 CONTINUOUS HINGES
 PIVOTS
 Numerical 1-059
 Numerical 59-437
 Numerical 438-1021
 Numerical 1152-8190
 Numerical 8200-9340

DESCRIPTION	SIZE	STEEL BASED		BRASS / STAINLESS BASED		US REFERENCE	BOX	CASE	NOTES
		BHMA FINISH	LIST	BHMA FINISH	LIST				
 <p>Full Mortise Three Knuckle Concealed Bearing Standard Weight</p> <p>For use on standard weight doors with medium frequency usage</p> <p>Available in: Steel w/Steel Pin Brass w/Brass Pin Stainless w/Stainless Pin</p> <p>Non-removable Pin (Steel and Stainless Steel Based 4.5 x 4.5 Hinges add \$3.75 all others add \$8.00 list)</p> <p>Packed with: Wood and machine screws</p> <p>Available options: SEC - Security Screws HT - Hospital tip RC - Round corners SH - Security Studs TW - Electric Thru Wire See page 14 for pricing</p>	5"x4.5" (127x114mm)	600	\$22.40	----	\$ ----	USP	3	24	
		632	33.50	605	66.20	US3	3	24	
		633	23.60	606	55.30	US4	3	24	
		639	25.20	612	51.60	US10	3	24	
		640	33.50	613	66.20	US10B	3	24	
		641	33.50	614	66.20	US10A	3	24	
		643	34.80	616	66.20	US11	3	24	
		646	34.80	619	66.20	US15	3	24	
		651	33.50	625	70.00	US26	3	24	
		652	26.30	626	62.60	US26D	3	24	
		----	----	629	76.00	US32	3	24	
		----	----	630	67.90	US32D	3	24	
	5"x5" (127x127mm)	600	40.00	----	----	USP	3	24	
		632	60.10	605	66.20	US3	3	24	
		633	42.60	606	55.30	US4	3	24	
		639	45.10	612	51.60	US10	3	24	
		640	60.10	613	66.20	US10B	3	24	
		641	60.10	614	66.20	US10A	3	24	
		643	62.60	616	66.20	US11	3	24	
		646	62.60	619	66.20	US15	3	24	
		651	60.10	625	70.00	US26	3	24	
		652	50.00	626	62.60	US26D	3	24	
		----	----	629	76.00	US32	3	24	
		----	----	630	73.10	US32D	3	24	

Note: Specify BHMA finish code when ordering.

 Indicates products that have EPD documentation available and meet LEED v4.

Contact Ives Customer Service for pricing on additional sizes and finishes

Bold pricing indicates item is in stock and available for **Fast Track** and **ProXpress**

HINGES
 CONTINUOUS HINGES
 PIVOTS
 Numerical 1-059
 Numerical 59-437
 Numerical 438-1021
 Numerical 1152-8190
 Numerical 8200-9340

DESCRIPTION	SIZE	STEEL BASED		BRASS / STAINLESS BASED		US REFERENCE	BOX	CASE	NOTES
		BHMA FINISH	LIST	BHMA FINISH	LIST				
 <p>Full Mortise Three Knuckle Concealed Bearing Heavy Weight</p> <p>For use on heavy weight doors with medium frequency usage</p> <p>Available in: Steel w/Steel Pin Brass w/Brass Pin Stainless w/Stainless Pin</p> <p>Non-removable Pin (Steel and Stainless Steel Based 4.5 x 4.5 Hinges add \$3.75 all others add \$8.00 list)</p> <p>Packed with: Wood and machine screws</p> <p>Available options: SEC - Security Screws HT - Hospital tip RC - Round corners SH - Security Studs TW - Electric Thru Wire See page 14 for pricing</p>	4.5"x4" (114x102mm)	600	\$38.80	----	\$ ----	USP	3	24	
		632	49.90	605	98.20	US3	3	24	
		633	38.80	606	68.10	US4	3	24	
		639	41.20	612	63.40	US10	3	24	
		640	50.90	613	81.50	US10B	3	24	
		641	50.90	614	81.50	US10A	3	24	
		643	49.90	616	81.50	US11	3	24	
		646	53.00	619	62.90	US15	3	24	
		651	49.90	625	86.10	US26	3	24	
		652	40.00	626	77.20	US26D	3	24	
		----	----	629	93.50	US32	3	24	
		----	----	630	84.80	US32D	3	24	
	4.5"x4.5" (114x114mm)	600	36.60	----	----	USP	3	24	
		632	49.90	605	98.20	US3	3	24	
		633	38.80	606	68.10	US4	3	24	
		639	41.20	612	63.40	US10	3	24	
		640	50.90	613	81.50	US10B	3	24	
		641	50.90	614	81.50	US10A	3	24	
		643	49.90	616	81.50	US11	3	24	
		646	47.10	619	62.90	US15	3	24	
		651	49.90	625	86.10	US26	3	24	
		652	40.00	626	77.20	US26D	3	24	NRP also in FT and ProX
		----	----	629	93.50	US32	3	24	
		----	----	630	84.80	US32D	3	24	630 NRP in FT and ProX
	5"x4.5" (127x114mm)	600	44.90	----	----	USP	3	24	
		632	58.70	605	111.00	US3	3	24	
		633	44.90	606	77.50	US4	3	24	
		639	47.40	612	72.30	US10	3	24	
		640	58.70	613	93.10	US10B	3	24	
		641	58.70	614	93.10	US10A	3	24	
		643	58.70	616	93.10	US11	3	24	
		646	60.80	619	74.50	US15	3	24	
		651	58.70	625	98.10	US26	3	24	
		652	46.00	626	88.10	US26D	3	24	
		----	----	629	106.50	US32	3	24	
		----	----	630	96.60	US32D	3	24	
	5"x5" (127x127mm)	600	44.90	----	----	USP	3	24	
		632	58.70	605	111.00	US3	3	24	
		633	44.90	606	77.50	US4	3	24	
		639	47.40	612	72.30	US10	3	24	
		640	58.70	613	93.10	US10B	3	24	
		641	58.70	614	93.10	US10A	3	24	
643		58.70	616	93.10	US11	3	24		
646		60.80	619	74.50	US15	3	24		
651		58.70	625	98.10	US26	3	24		
652		48.80	626	88.10	US26D	3	24		
----		----	629	106.50	US32	3	24		
----		----	630	102.40	US32D	3	24		

Note: Specify BHMA finish code when ordering.

 Indicates products that have EPD documentation available and meet LEED v4.

Contact Ives Customer Service for pricing on additional sizes and finishes

*Bold pricing indicates item is in stock and available for **Fast Track** and **ProXpress***

HINGES
 CONTINUOUS HINGES
 PIVOTS
 Numerical 1-059
 Numerical 59-437
 Numerical 438-1021
 Numerical 1152-8190
 Numerical 8200-9340

DESCRIPTION	SIZE	STEEL BASED		BRASS / STAINLESS BASED		US REFERENCE	BOX	CASE	NOTES	
		BHMA FINISH	LIST	BHMA FINISH	LIST					
 <p>Three Knuckle Concealed Bearing Wide Throw Standard Weight</p> <p>For use on standard weight doors with medium frequency usage</p> <p>Available in: Steel w/Steel Pin</p> <p>Non-removable Pin (add \$8.00 List)</p> <p>Packed with: Wood and machine screws</p> <p>Available options: SEC - Security Screws HT - Hospital tip RC - Round corners SH - Security Studs TW - Electric Thru Wire See page 14 for pricing</p>	4.5"x5" (127x114mm)	600	\$121.00	----	\$ ----	USP	3	24		
		632	181.40	605	----	US3	3	24		
		633	128.40	606	----	US4	3	24		
		639	135.90	612	----	US10	3	24		
		640	181.40	613	----	US10B	3	24		
		641	181.40	614	----	US10A	3	24		
		643	189.00	616	----	US11	3	24		
		646	189.00	619	----	US15	3	24		
		651	181.40	625	----	US26	3	24		
		652	151.00	626	----	US26D	3	24		
		----	----	629	----	US32	3	24		
		----	----	630	----	US32D	3	24		
		4.5"x6" (114x152mm)	600	127.80	----	----	USP	3	24	
			632	191.70	605	----	US3	3	24	
			633	135.70	606	----	US4	3	24	
	639		143.80	612	----	US10	3	24		
	640		191.70	613	----	US10B	3	24		
	641		191.70	614	----	US10A	3	24		
	643		199.90	616	----	US11	3	24		
	646		199.90	619	----	US15	3	24		
	651		191.70	625	----	US26	3	24		
	652		159.60	626	----	US26D	3	24		
	----		----	629	----	US32	3	24		
	----		----	630	----	US32D	3	24		
	5"x6" (127x152mm)		600	134.80	----	----	USP	3	24	
			632	202.10	605	----	US3	3	24	
			633	143.20	606	----	US4	3	24	
		639	151.40	612	----	US10	3	24		
		640	202.10	613	----	US10B	3	24		
		641	202.10	614	----	US10A	3	24		
		643	210.60	616	----	US11	3	24		
		646	210.60	619	----	US15	3	24		
		651	202.10	625	----	US26	3	24		
		652	168.40	626	----	US26D	3	24		
		----	----	629	----	US32	3	24		
		----	----	630	----	US32D	3	24		
		5"x7" (127x178mm)	600	138.20	----	----	USP	3	24	
			632	207.30	605	----	US3	3	24	
			633	146.80	606	----	US4	3	24	
	639		155.50	612	----	US10	3	24		
	640		207.30	613	----	US10B	3	24		
	641		207.30	614	----	US10A	3	24		
	643		215.70	616	----	US11	3	24		
	646		215.70	619	----	US15	3	24		
	651		207.30	625	----	US26	3	24		
652	172.80		626	----	US26D	3	24			
----	----		629	----	US32	3	24			
----	----		630	----	US32D	3	24			

Note: Specify BHMA finish code when ordering.

Shaded items may require extended lead time.

Contact Ives Customer Service for pricing on additional sizes and finishes

Bold pricing indicates item is in stock and available for **Fast Track** and **ProXpress**

DESCRIPTION	SIZE	STEEL BASED		BRASS / STAINLESS BASED		US REFERENCE	BOX	CASE	NOTES
		BHMA FINISH	LIST	BHMA FINISH	LIST				
3CB1 WT  Three Knuckle Concealed Bearing Wide Throw Standard Weight For use on standard weight doors with medium frequency usage	5"x8" (127x204mm)	600	\$148.30	----	\$ ----	USP	3	24	
		632	222.90	605	----	US3	3	24	
		633	157.90	606	----	US4	3	24	
		639	167.10	612	----	US10	3	24	
		640	222.90	613	----	US10B	3	24	
		641	222.90	614	----	US10A	3	24	
		643	232.00	616	----	US11	3	24	
		646	232.00	619	----	US15	3	24	
		651	222.90	625	----	US26	3	24	
		652	185.70	626	----	US26D	3	24	
		----	----	629	----	US32	3	24	
		----	----	630	----	US32D	3	24	

DESCRIPTION	SIZE	STEEL BASED		BRASS / STAINLESS BASED		US REFERENCE	BOX	CASE	NOTES
		BHMA FINISH	LIST	BHMA FINISH	LIST				
3SPI  Spring Hinge Standard Weight UL listed for use on fire-rated doors Available in: Steel w/ Steel Pin Stainless w/ Stainless Pin Packed with: Wood and machine screws Available options: SEC - Security Screws RC - Round corners See page 14 for pricing	4"x4" (102x102mm)	600	\$18.00	----	\$	USP	3	24	
		632	25.80	605	----	US3	3	24	
		633	20.70	606	----	US4	3	24	
		639	23.30	612	----	US10	3	24	
		640	29.60	613	----	US10B	3	24	
		641	28.30	614	----	US10A	3	24	
		643	25.80	616	----	US11	3	24	
		646	25.80	619	----	US15	3	24	
		651	25.80	625	----	US26	3	24	
		652	23.30	626	----	US26D	3	24	
		----	----	629	----	US32	3	24	
		----	----	630	61.8	US32D	3	24	
	4.5"x4" (114x102mm)	600	18.00	----	----	USP	3	24	
		632	25.80	605	----	US3	3	24	
		633	20.70	606	----	US4	3	24	
		639	23.30	612	----	US10	3	24	
		640	29.60	613	----	US10B	3	24	
		641	28.30	614	----	US10A	3	24	
		643	25.80	616	----	US11	3	24	
		646	25.80	619	----	US15	3	24	
		651	25.80	625	----	US26	3	24	
		652	23.30	626	----	US26D	3	24	
		----	----	629	----	US32	3	24	
		----	----	630	61.8	US32D	3	24	
	4.5"x4.5" (114x114mm)	600	17.30	----	----	USP	3	24	
		632	24.70	605	----	US3	3	24	
		633	19.80	606	----	US4	3	24	
		639	22.40	612	----	US10	3	24	
		640	28.40	613	----	US10B	3	24	
		641	27.10	614	----	US10A	3	24	
643		24.70	616	----	US11	3	24		
646		24.70	619	----	US15	3	24		
651		24.70	625	----	US26	3	24		
652		23.30	626	----	US26D	3	24		
----		----	629	67.6	US32	3	24		
----		----	630	65.50	US32D	3	24		

Note: Specify BHMA finish code when ordering.

Contact Ives Customer Service for pricing on additional sizes and finishes

Bold pricing indicates item is in stock and available for **Fast Track** and **ProXpress**

HINGES
 CONTINUOUS HINGES
 PIVOTS
 Numerical 1-059
 Numerical 59-437
 Numerical 438-1021
 Numerical 1152-8190
 Numerical 8200-9340

DESCRIPTION	SIZE	STEEL BASED		BRASS / STAINLESS BASED		US REFERENCE	BOX	CASE	NOTES
		BHMA FINISH	LIST	BHMA FINISH	LIST				
 <p>Five Knuckle Plain Bearing Standard Weight</p> <p>For use on standard weight doors with low frequency usage</p> <p>Available in: Steel w/Steel Pin Brass w/Brass Pin Stainless w/Stainless Pin</p> <p>Non-removable Pin (Steel and Stainless Steel Based 4.5 x 4.5 Hinges add \$3.75 All other add \$8.00 List)</p> <p>Packed with: Wood and machine screws</p> <p>Available options: SEC - Security Screws HT - Hospital tip RC - Round corners SH - Security Studs See page 14 for pricing</p>	3.5"x3.5" (89x89mm)	600	\$6.10	----	\$ ----	USP	3	24	
		632	8.80	605	23.20	US3	3	24	
		633	6.60	606	19.20	US4	3	24	
		639	9.20	612	18.10	US10	3	24	
		640	9.20	613	23.20	US10B	3	24	
		641	9.20	614	23.20	US10A	3	24	
		643	9.50	616	23.20	US11	3	24	
		646	9.50	619	23.20	US15	3	24	
		651	9.20	625	24.40	US26	3	24	
		652	7.30	626	21.80	US26D	3	24	
		----	----	629	26.40	US32	3	24	
		----	----	630	25.40	US32D	3	24	
	4"x4" (102x102mm)	600	\$7.00	----	----	USP	3	24	
		632	10.60	605	26.50	US3	3	24	
		633	7.30	606	21.90	US4	3	24	
		639	7.80	612	20.70	US10	3	24	
		640	10.60	613	26.50	US10B	3	24	
		641	10.60	614	26.50	US10A	3	24	
		643	11.00	616	26.50	US11	3	24	
		646	11.00	619	26.50	US15	3	24	
		651	10.60	625	27.90	US26	3	24	
		652	8.70	626	24.90	US26D	3	24	
		----	----	629	30.00	US32	3	24	
		----	----	630	29.00	US32D	3	24	
	4.5"x4" (114x102mm)	600	7.60	----	----	USP	3	24	
		632	12.50	605	36.00	US3	3	24	
		633	6.40	606	30.80	US4	3	24	
		639	7.60	612	30.80	US10	3	24	
		640	12.20	613	36.00	US10B	3	24	
		641	12.20	614	33.70	US10A	3	24	
		643	12.50	616	33.70	US11	3	24	
		646	12.50	619	36.00	US15	3	24	
		651	12.50	625	41.30	US26	3	24	
		652	9.80	626	31.80	US26D	3	24	
		----	----	629	38.30	US32	3	24	
		----	----	630	35.20	US32D	3	24	
	4.5"x4.5" (114x114mm)	600	4.80	----	----	USP	3	24	
		632	12.00	605	36.00	US3	3	24	
		633	6.10	606	30.80	US4	3	24	
		639	7.60	612	30.80	US10	3	24	
		640	10.90	613	34.60	US10B	3	24	
		641	10.90	614	33.70	US10A	3	24	
		643	12.50	616	33.70	US11	3	24	
		646	12.00	619	36.00	US15	3	24	
		651	12.00	625	41.30	US26	3	24	
		652	7.30	626	31.80	US26D	3	24	NRP also in FT and ProX
		----	----	629	38.30	US32	3	24	
		----	----	630	35.20	US32D	3	24	



Note: Specify BHMA finish code when ordering.

 Indicates products that have EPD documentation available and meet LEED v4.

Contact Ives Customer Service for pricing on additional sizes and finishes

Bold pricing indicates item is in stock and available for **Fast Track** and **ProXpress**

HINGES
 CONTINUOUS HINGES
 PIVOTS
 Numerical 1-059
 Numerical 59-437
 Numerical 438-1021
 Numerical 1152-8190
 Numerical 8200-9340

DESCRIPTION	SIZE	STEEL BASED		BRASS / STAINLESS BASED		US REFERENCE	BOX	CASE	NOTES
		BHMA FINISH	LIST	BHMA FINISH	LIST				
 Five Knuckle Plain Bearing Standard Weight For use on standard weight doors with low frequency usage	5"x4.5" (127x114mm)	600	\$11.30	----	\$ ----	USP	3	24	
		632	17.10	605	52.00	US3	3	24	
		633	12.10	606	43.60	US4	3	24	
		639	12.60	612	40.50	US10	3	24	
		640	17.10	613	52.00	US10B	3	24	
		641	17.10	614	52.00	US10A	3	24	
		643	17.90	616	52.00	US11	3	24	
		646	17.90	619	52.00	US15	3	24	
		651	17.10	625	55.10	US26	3	24	
		652	14.40	626	49.30	US26D	3	24	
		----	----	629	59.30	US32	3	24	
		----	----	630	57.00	US32D	3	24	
 Five Knuckle Ball Bearing Standard Weight For use on standard weight doors with medium frequency usage Available in: Steel w/Steel Pin Brass w/Brass Pin Stainless w/Stainless Pin Non-removable Pin (Steel and Stainless Steel Based 4.5 x 4.5 Hinges add \$3.75 All other add \$8.00 List) Packed with: Wood and machine screws Available options: SEC - Security Screws HT - Hospital tip RC - Round corners SH - Security Studs TW - Electric Thru Wire See page 14 for pricing and available sizes	3.5"x3.5" (89x89mm)	600	\$9.00	----	\$ ----	USP	3	24	
		632	13.70	605	33.20	US3	3	24	
		633	9.90	606	27.70	US4	3	24	
		639	10.30	612	25.90	US10	3	24	
		640	13.70	613	33.20	US10B	3	24	
		641	13.70	614	33.20	US10A	3	24	
		643	14.40	616	33.20	US11	3	24	
		646	14.40	619	33.20	US15	3	24	
		651	13.70	625	35.00	US26	3	24	
		652	10.70	626	31.30	US26D	3	24	
		----	----	629	37.60	US32	3	24	
		----	----	630	33.90	US32D	3	24	
	4"x4" (102x102mm)	600	8.50	----	----	USP	3	24	
		632	13.70	605	32.20	US3	3	24	
		633	9.90	606	26.70	US4	3	24	
		639	10.30	612	25.00	US10	3	24	
		640	13.70	613	32.20	US10B	3	24	
		641	13.70	614	32.20	US10A	3	24	
		643	14.40	616	32.20	US11	3	24	
		646	14.40	619	32.20	US15	3	24	
		651	13.70	625	34.00	US26	3	24	
		652	10.70	626	30.40	US26D	3	24	
		----	----	629	36.50	US32	3	24	
		----	----	630	35.00	US32D	3	24	
	4.5"x4" (114x102mm)	600	12.50	----	----	USP	3	24	
		632	17.80	605	42.60	US3	3	24	
		633	12.50	606	32.20	US4	3	24	
		639	14.10	612	32.20	US10	3	24	
		640	18.10	613	42.60	US10B	3	24	
		641	18.10	614	38.40	US10A	3	24	
		643	17.80	616	38.40	US11	3	24	
		646	18.90	619	42.60	US15	3	24	
		651	17.80	625	42.60	US26	3	24	
		652	14.40	626	34.00	US26D	3	24	NRP also in FT and ProX
		----	----	629	43.50	US32	3	24	
		----	----	630	39.30	US32D	3	24	

Note: Specify BHMA finish code when ordering.

 Indicates products that have EPD documentation available and meet LEED v4.

Contact Ives Customer Service for pricing on additional sizes and finishes

Bold pricing indicates item is in stock and available for Fast Track and ProXpress

HINGES
 CONTINUOUS HINGES
 PIVOTS
 Numerical 1-059
 Numerical 59-437
 Numerical 438-1021
 Numerical 1152-8190
 Numerical 8200-9340

DESCRIPTION	SIZE	STEEL BASED		BRASS / STAINLESS BASED		US REFERENCE	BOX	CASE	NOTES
		BHMA FINISH	LIST	BHMA FINISH	LIST				
 <p>Five Knuckle Ball Bearing Standard Weight</p> <p>For use on standard weight doors with medium frequency usage</p> <p>Available in: Steel w/Steel Pin Brass w/Brass Pin Stainless w/Stainless Pin</p> <p>Non-removable Pin (Steel and Stainless Steel Based 4.5 x 4.5 Hinges add \$3.75 All other add \$8.00 List)</p> <p>Packed with: Wood and machine screws</p> <p>Available options: SEC - Security Screws HT - Hospital tip RC - Round corners SH - Security Studs TW - Electric Thru Wire See page 14 for pricing</p>	4.5"x4.5" (114x114mm)	600	9.60	----	\$ ----	USP	3	24	NRP also in FT and ProX
		632	16.70	605	40.10	US3	3	24	
		633	10.70	606	30.40	US4	3	24	
		639	13.30	612	30.40	US10	3	24	
		640	16.70	613	40.10	US10B	3	24	NRP also in FT and ProX
		641	16.70	614	38.40	US10A	3	24	
		643	16.70	616	38.40	US11	3	24	
		646	20.30	619	40.10	US15	3	24	
		651	16.70	625	40.10	US26	3	24	
		652	10.70	626	34.00	US26D	3	24	NRP also in FT and ProX
		----	----	629	43.50	US32	3	24	
		----	----	630	39.30	US32D	3	24	NRP also in FT and ProX
	5"x4.5" (127x114mm)	600	19.10	----	----	USP	3	24	
		632	28.80	605	48.90	US3	3	24	
		633	20.50	606	40.50	US4	3	24	
		639	21.60	612	37.80	US10	3	24	
		640	28.80	613	48.90	US10B	3	24	
		641	28.80	614	48.90	US10A	3	24	
		643	30.00	616	48.90	US11	3	24	
		646	30.00	619	48.90	US15	3	24	
		651	28.80	625	51.40	US26	3	24	
		652	22.50	626	46.00	US26D	3	24	NRP also in FT and ProX
		----	----	629	55.20	US32	3	24	
		----	----	630	50.00	US32D	3	24	630 NRP also in FT and ProX
	5"x5" (127x127mm)	600	19.40	----	----	USP	3	24	
		632	29.30	605	50.50	US3	3	24	
		633	20.70	606	42.00	US4	3	24	
		639	21.80	612	39.20	US10	3	24	
		640	29.30	613	50.50	US10B	3	24	
		641	29.30	614	50.50	US10A	3	24	
		643	30.30	616	50.50	US11	3	24	
		646	30.30	619	50.50	US15	3	24	
		651	29.30	625	53.10	US26	3	24	
		652	24.20	626	47.50	US26D	3	24	
		----	----	629	57.10	US32	3	24	
		----	----	630	54.80	US32D	3	24	

Note: Specify BHMA finish code when ordering.

 Indicates products that have EPD documentation available and meet LEED v4.

Contact Ives Customer Service for pricing on additional sizes and finishes

Bold pricing indicates item is in stock and available for **Fast Track** and **ProXpress**

DESCRIPTION	SIZE	STEEL BASED		BRASS / STAINLESS BASED		US REFERENCE	BOX	CASE	NOTES
		BHMA FINISH	LIST	BHMA FINISH	LIST				
 <p>5BB1HW</p> <p>Five Knuckle Ball Bearing Heavy Weight</p> <p>For use on heavy weight doors with medium frequency usage</p> <p>Available in: Steel w/Steel Pin Brass w/Brass Pin Stainless w/Stainless Pin</p> <p>Non-removable Pin (Steel and Stainless Steel Based 4.5 x 4.5 Hinges add \$3.75 All other add \$8.00 List)</p> <p>Packed with: Wood and machine screws</p> <p>Available options: SEC - Security Screws HT - Hospital tip RC - Round corners SH - Security Studs TW - Electric Thru Wire See page 14 for pricing</p>	4.5"x4" (114x102mm)	600	\$22.30	----	\$ ----	USP	3.00	24	
		632	33.50	605	63.00	US3	3.00	24	
		633	23.60	606	52.40	US4	3.00	24	
		639	25.00	612	49.10	US10	3.00	24	
		640	33.50	613	63.00	US10B	3.00	24	
		641	33.50	614	63.00	US10A	3.00	24	
		643	34.80	616	63.00	US11	3.00	24	
		646	34.80	619	63.00	US15	3.00	24	
		651	33.50	625	66.60	US26	3.00	24	
		652	26.10	626	59.60	US26D	3.00	24	
		----	----	629	71.30	US32	3.00	24	
		----	----	630	64.30	US32D	3.00	24	
	4.5"x4.5" (114x114mm)	600	28.50	----	----	USP	3.00	24	
		632	36.90	605	63.00	US3	3.00	24	
		633	29.80	606	52.40	US4	3.00	24	
		639	31.10	612	49.10	US10	3.00	24	
		640	36.90	613	66.80	US10B	3.00	24	613 NRP also in FT and ProX
		641	36.90	614	63.00	US10A	3.00	24	
		643	36.90	616	63.00	US11	3.00	24	
		646	36.90	619	61.90	US15	3.00	24	
		651	36.90	625	66.60	US26	3.00	24	NRP also in FT and ProX
		652	31.10	626	56.10	US26D	3.00	24	
		----	----	629	71.30	US32	3.00	24	NRP also in FT and ProX
		----	----	630	64.30	US32D	3.00	24	
	5"x4.5" (127x114mm)	600	35.40	----	----	USP	3.00	24	
		632	50.60	605	73.20	US3	3.00	24	
		633	36.70	606	61.20	US4	3.00	24	
		639	35.80	612	57.00	US10	3.00	24	
		640	43.00	613	73.20	US10B	3.00	24	
		641	45.70	614	73.20	US10A	3.00	24	
		643	36.70	616	73.20	US11	3.00	24	
		646	36.70	619	73.20	US15	3.00	24	
		651	36.70	625	77.40	US26	3.00	24	
		652	35.80	626	65.20	US26D	3.00	24	NRP also in FT and ProX
		----	----	629	83.10	US32	3.00	24	
		----	----	630	75.10	US32D	3.00	24	630 NRP also in FT and ProX
	5"x5" (127x127mm)	600	36.50	----	----	USP	3.00	24	
		632	54.60	605	85.00	US3	3.00	24	
		633	38.80	606	70.70	US4	3.00	24	
		639	41.10	612	66.00	US10	3.00	24	
		640	54.60	613	85.00	US10B	3.00	24	
		641	54.60	614	85.00	US10A	3.00	24	
		643	57.10	616	85.00	US11	3.00	24	
		646	57.10	619	85.00	US15	3.00	24	
		651	54.60	625	89.50	US26	3.00	24	
652		44.00	626	80.10	US26D	3.00	24		
----		----	629	96.10	US32	3.00	24		
----		----	630	86.90	US32D	3.00	24		

Note: Specify BHMA finish code when ordering.



 Indicates products that have EPD documentation available and meet LEED v4.

Contact Ives Customer Service for pricing on additional sizes and finishes

Bold pricing indicates item is in stock and available for **Fast Track** and **ProXpress**

HINGES
 CONTINUOUS HINGES
 PIVOTS
 Numerical 1-059
 Numerical 59-437
 Numerical 438-1021
 Numerical 1152-8190
 Numerical 8200-9340

HINGES
 CONTINUOUS HINGES
 PIVOTS
 Numerical 1-059
 Numerical 59-437
 Numerical 438-1021
 Numerical 1152-8190
 Numerical 8200-9340

DESCRIPTION	SIZE	STEEL BASED		BRASS / STAINLESS BASED		US REFERENCE	BOX	CASE	NOTES
		BHMA FINISH	LIST	BHMA FINISH	LIST				
 <p>Five Knuckle Ball Bearing Swing Clear Standard Weight</p> <p>For use on standard weight doors with medium frequency usage</p> <p>Available in: Steel w/ Steel Pin Square or Beveled Edge</p> <p>Non-removable Pin (add \$8.00 List)</p> <p>Packed with: Wood and machine screws</p> <p>Available options: SEC - Security Screws HT - Hospital tip SH - Security Studs See page 14 for pricing</p>	4.5" (114mm) Standard	600	\$60.70	----	\$ ----	USP	3.00	24	
		632	71.30	605	----	US3	3.00	24	
		633	60.70	606	----	US4	3.00	24	
		639	63.20	612	----	US10	3.00	24	
		640	71.30	613	----	US10B	3.00	24	
		641	74.60	614	----	US10A	3.00	24	
		643	74.30	616	----	US11	3.00	24	
		646	74.30	619	----	US15	3.00	24	
		651	71.30	625	----	US26	3.00	24	
		652	56.10	626	----	US26D	3.00	24	
		----	----	629	----	US32	3.00	24	
		----	----	630	82.80	US32D	3.00	24	
	5" (127mm) Standard	600	60.70	----	----	USP	3.00	24	
		632	71.30	605	----	US3	3.00	24	
		633	60.70	606	----	US4	3.00	24	
		639	63.20	612	----	US10	3.00	24	
		640	71.30	613	----	US10B	3.00	24	
		641	74.60	614	----	US10A	3.00	24	
		643	74.30	616	----	US11	3.00	24	
		646	74.30	619	----	US15	3.00	24	
		651	71.30	625	----	US26	3.00	24	
		652	56.10	626	----	US26D	3.00	24	
		----	----	629	----	US32	3.00	24	
		----	----	630	96.50	US32D	3.00	24	
 <p>Five Knuckle Ball Bearing Swing Clear Heavyweight</p> <p>For use on heavy weight doors with medium frequency usage</p> <p>Available in: Steel w/ Steel Pin Square or Beveled Edge</p> <p>Non-removable Pin (add \$8.00 List)</p> <p>Packed with: Wood and machine screws</p> <p>Available options: SEC - Security Screws HT - Hospital tip SH - Security Studs TW - Electric Thru Wire See page 14 for pricing</p>	4.5" (114mm) Heavy	600	69.50	----	----	USP	3.00	24	
		632	86.50	605	----	US3	3.00	24	
		633	69.50	606	----	US4	3.00	24	
		639	77.00	612	----	US10	3.00	24	
		640	86.50	613	----	US10B	3.00	24	
		641	86.50	614	----	US10A	3.00	24	
		643	86.50	616	----	US11	3.00	24	
		646	90.20	619	----	US15	3.00	24	
		651	86.50	625	----	US26	3.00	24	
		652	67.90	626	----	US26D	3.00	24	652 HWBSC in FT and ProX
		----	----	629	----	US32	3.00	24	
		----	----	630	122.00	US32D	3.00	24	
	5" (127mm) Heavy	600	69.50	----	----	USP	3.00	24	
		632	86.50	605	----	US3	3.00	24	
		633	69.50	606	----	US4	3.00	24	
		639	77.00	612	----	US10	3.00	24	
		640	86.50	613	----	US10B	3.00	24	
		641	86.50	614	----	US10A	3.00	24	
		643	86.50	616	----	US11	3.00	24	
		646	90.20	619	----	US15	3.00	24	
		651	86.50	625	----	US26	3.00	24	
		652	67.90	626	----	US26D	3.00	24	652 HWBSC in FT and ProX
		----	----	629	----	US32	3.00	24	
		----	----	630	146.40	US32D	3.00	24	

Note: Specify BHMA finish code when ordering.

Contact Ives Customer Service for pricing on additional sizes and finishes

Bold pricing indicates item is in stock and available for **Fast Track** and **ProXpress**

DESCRIPTION	SIZE	STEEL BASED		BRASS / STAINLESS BASED		US REFERENCE	BOX	CASE	NOTES
		BHMA FINISH	LIST	BHMA FINISH	LIST				
5BB1 WT  Five Knuckle Ball Bearing Wide Throw Standard Weight For use on standard weight doors with medium frequency usage Available in: Steel w/Steel Pin Non-removable Pin (add \$8.00 List) Packed with: Wood and machine screws Available options: SEC - Security Screws HT - Hospital tip RC - Round corners SH - Security Studs TW - Electric Thru Wire See page 14 for pricing	4.5"x5" (114x127mm)	600	\$15.30	----	\$ ----	USP	3.00	24	
		632	22.90	605	----	US3	3.00	24	
		633	16.00	606	----	US4	3.00	24	
		639	17.10	612	----	US10	3.00	24	
		640	22.90	613	----	US10B	3.00	24	
		641	22.90	614	----	US10A	3.00	24	
		643	23.60	616	----	US11	3.00	24	
		646	23.60	619	----	US15	3.00	24	
		651	22.90	625	----	US26	3.00	24	
		652	18.90	626	----	US26D	3.00	24	
		----	----	629	----	US32	3.00	24	
		----	----	630	----	US32D	3.00	24	
	4.5"x6" (114x152mm)	600	40.50	----	----	USP	3.00	24	
		632	60.70	605	----	US3	3.00	24	
		633	43.00	606	----	US4	3.00	24	
		639	45.70	612	----	US10	3.00	24	
		640	60.70	613	----	US10B	3.00	24	
		641	60.70	614	----	US10A	3.00	24	
		643	63.20	616	----	US11	3.00	24	
		646	63.20	619	----	US15	3.00	24	
		651	60.70	625	----	US26	3.00	24	
		652	47.60	626	----	US26D	3.00	24	
		----	----	629	----	US32	3.00	24	
		----	----	630	----	US32D	3.00	24	
	5"x6" (127x152mm)	600	54.60	----	----	USP	3.00	24	
		632	81.80	605	----	US3	3.00	24	
		633	57.90	606	----	US4	3.00	24	
		639	61.60	612	----	US10	3.00	24	
		640	81.80	613	----	US10B	3.00	24	
		641	81.80	614	----	US10A	3.00	24	
		643	85.30	616	----	US11	3.00	24	
		646	85.30	619	----	US15	3.00	24	
		651	81.80	625	----	US26	3.00	24	
		652	68.30	626	----	US26D	3.00	24	
		----	----	629	----	US32	3.00	24	
		----	----	630	----	US32D	3.00	24	
	5"x7" (127x178mm)	600	54.60	----	----	USP	3.00	24	
		632	81.80	605	----	US3	3.00	24	
		633	57.90	606	----	US4	3.00	24	
		639	61.60	612	----	US10	3.00	24	
640		81.80	613	----	US10B	3.00	24		
641		81.80	614	----	US10A	3.00	24		
643		85.30	616	----	US11	3.00	24		
646		85.30	619	----	US15	3.00	24		
651		81.80	625	----	US26	3.00	24		
652		68.30	626	----	US26D	3.00	24		
----		----	629	----	US32	3.00	24		
----		----	630	----	US32D	3.00	24		

Note: Specify BHMA finish code when ordering.

Contact Ives Customer Service for pricing on additional sizes and finishes

Bold pricing indicates item is in stock and available for **Fast Track** and **ProXpress**

HINGES
 CONTINUOUS HINGES
 PIVOTS
 Numerical 1-059
 Numerical 59-437
 Numerical 438-1021
 Numerical 1152-8190
 Numerical 8200-9340

HINGES
 CONTINUOUS HINGES
 PIVOTS
 Numerical 1-059
 Numerical 59-437
 Numerical 438-1021
 Numerical 1152-8190
 Numerical 8200-9340

DESCRIPTION	SIZE	STEEL BASED		BRASS / STAINLESS BASED		US REFERENCE	BOX	CASE	NOTES
		BHMA FINISH	LIST	BHMA FINISH	LIST				
 <p>5BB1 WT Five Knuckle Ball Bearing Wide Throw Standard Weight For use on standard weight doors with medium frequency usage</p>	5"x8" (127x206mm)	600	\$54.60	----	\$----	USP	3.00	24	
		632	81.80	605	----	US3	3.00	24	
		633	57.90	606	----	US4	3.00	24	
		639	61.60	612	----	US10	3.00	24	
		640	81.80	613	----	US10B	3.00	24	
		641	81.80	614	----	US10A	3.00	24	
		643	85.30	616	----	US11	3.00	24	
		646	85.30	619	----	US15	3.00	24	
		651	81.80	625	----	US26	3.00	24	
		652	68.30	626	----	US26D	3.00	24	
		----	----	629	----	US32	3.00	24	
		----	----	630	----	US32D	3.00	24	

Note: Specify BHMA finish code when ordering.

BAA 5BB1 Five Knuckle Ball Bearing Standard Weight Build in America (BAA) Non-removable Pin (NRP) add \$3.75 List	4.5"x4.5" (114x114mm)	652	\$11.80	626	----	US26D	3.00	24	
		----	----	630	\$43.10	US32D	3.00	24	
BAA 5BB1 HW Five Knuckle Ball Bearing Heavy Weight Build in America (BAA) Non-removable Pin (NRP) add \$3.75 List	4.5"x4.5" (114x114mm)	652	\$34.00	626	----	US26D	3.00	24	
		----	----	630	\$70.30	US32D	3	24	
	5"x4.5" (127x114mm)	652	39.10	626	----	US26D	3	24	
		----	----	630	82.30	US32D	3	24	
BAA 5BB1 HW BSC Five Knuckle Ball Bearing Heavy Weight Build in America (BAA) Swing Clear - Beveled Edge	4.5" (114mm)	652	\$74.30	626	----	US26D	3	24	

Additional Options Available for Most Hinges

HINGE ADDITION/MODIFICATION	SPECIFY	LIST ADD PER HINGE
Non-Removable Pin	NRP	Reference each hinge type
Round Corners (specify 1/4" or 5/8" radius)	RC 1/4" or RC 5/8"	\$5.00
Security Studs (Includes NRP)	SH	7.50
Hospital Tips*	HT	9.50
Security Screws Machine Only	SEC	23.25

* Hospital Tips and Thru-Wire options include pins that are non-removable. Additional NRP option is not required.

Electric Thru-Wire Options*

Listed under UL 634

TW4 - 4 Wire Thru Wire
 TW8 - 8 Wire Thru Wire
 MON - Monitor
 TW4M - 4 Wire Thru Wire with Monitor
 TW8M - 8 Wire Thru Wire with Monitor
 CON - Allegion Connect
 Allegion Connect must be ordered with TW4, TW4M, TW8, TW8M

- TW and MON not available for 3.5X3.5 hinges, contact technical support.
- MON not available for 4X4 or smaller hinges, contact technical support.
- Not available on 3PB1, 3SPI, or 5PB1 models
- Not available with Security Stud (SH) option
- Packed one hinge per box with machine and wood screws
- Through-wire hinges cycle tested to ensure durability. Ives warranty applies-12 months from date of shipment

MODEL NO.	BOX QTY	STEEL BASED		BRASS / STAINLESS BASED		ALLEGION CONNECT (CON)
		FULL MORTISE	SWING CLEAR	FULL MORTISE	SWING CLEAR	
*MON	1	284.00	-	335.00	-	N/A
TW4	1	272.00	543.00	321.00	637.00	N/C
TW4M	1	517.00	-	623.00	-	N/C
TW8	1	410.00	693.00	489.00	977.00	N/C
TW8M	1	693.00	-	740.00	-	N/C

For Stocked Electric Thru Wire Hinges, see pricing in the table below. Options above are List Add per Hinge.

 Indicates products that have EPD documentation available and meet LEED v4. *Bold pricing indicates item is in stock and available for Fast Track and ProXpress*

Stocked Electric Thru-Wire Hinges

The hinges in the table below come standard with Allegion Connect (CON) at no extra charge.

DESCRIPTION	SIZE	TW OPTION	STEEL BASED BHMA FINISH	LIST	BRASS / STAINLESS BASED BHMA FINISH	LIST	US REFERENCE	BOX	CASE
3CB1	4.5X4	TW8 CON	652	\$405.10	626	---	US26D	1	12
			---	---	630	---	US32D	1	12
	4.5X4.5	TW4 CON	652	268.50	626	---	US26D	1	12
			---	---	630	---	US32D	1	12
		TW8 CON	652	399.00	626	---	US26D	1	12
			---	---	630	517.40	US32D	1	12
3CB1 HW	4.5X4.5	TW8 CON	652	427.90	626	---	US26D	1	12
			---	---	630	547.40	US32D	1	12
5BB1	4.5X4	TW8 CON	652	401.70	626	---	US26D	1	12
			---	---	630	501.10	US32D	1	12
	4.5X4.5	TW4 CON	652	267.50	626	337.80	US26D	1	12
			---	---	630	343.20	US32D	1	12
		TW8 CON	640	404.20	613	---	US10B	1	12
			646	407.80	619	---	US15	1	12
			652	398.00	626	495.70	US26D	1	12
	5X4.5		---	---	630	501.10	US32D	1	12
		TW8 CON	652	410.00	626	---	US26D	1	12
			---	---	630	---	US32D	1	12
5BB1 HW	4.5X4.5	TW4 CON	652	288.30	626	---	US26D	1	12
			---	---	630	368.70	US32D	1	12
		TW8 CON	652	418.80	626	---	US26D	1	12
	5X4.5		---	---	630	526.50	US32D	1	12
		TW4 CON	652	293.10	626	---	US26D	1	12
			---	---	630	---	US32D	1	12
		TW8 CON	652	423.60	626	---	US26D	1	12
			---	---	630	537.50	US32D	1	12

For all other Electric Thru Wire Hinges, see pricing in the table above.

Residential Hinges

*Non rising pin standard. Hinge pin stop not recommended.

MODEL	SUBSTRATE	MODEL NUMBER	BHMA FINISH	WEIGHT	ORDER QTY	BOX QTY	LIST PRICE
1010* Residential Hinge 3.5" Square Corner	Steel	SC3P1010F-605E	632		3	3	\$20.80
		SC3P1010F-609E	638		3	3	24.90
		SC3P1010F-619E	646		3	3	24.90
		SC3P1010F-716E	-		3	3	21.40
1011* Residential Hinge 3.5" 5/8" Radius Corner	Steel	1011F-605E	632			2	7.10
		1011F-619E	646			2	7.10
		1011F-625E	-			2	7.10
		1011F-716E	-			2	7.10
		SC3P1011F-605E	632		3	3	20.80
		SC3P1011F-609E	638		3	3	24.90
		SC3P1011F-619E	646		3	3	24.90
		SC3P1011F-620E	-		3	3	24.90
		SC3P1011F-716E	-		3	3	24.90
1012* Residential Hinge 3.5" 1/4" Radius Corner	Steel	SC3P1012F-605E	632		3	3	20.80
		SC3P1012F-609E	638		3	3	24.90
		SC3P1012F-619E	646		3	3	24.90
		SC3P1012F-716E	-		3	3	24.90
1020* Residential Hinge 4" Square Corner	Steel	SC3P1020F-605E	632		3	3	24.90
		SC3P1020F-609E	638		3	3	26.70
		SC3P1020F-619E	646		3	3	26.70
		SC3P1020F-716E	-		3	3	26.70
1021* Residential Hinge 4" 5/8" Radius Corner	Steel	SC3P1021F-619E	-		3	3	26.70
		SC3P1021F-620E	-		3	3	26.70
		SC3P1021F-716E	-		3	3	26.70

*Non rising pin standard. Hinge pin stop not recommended.







Contact Ives Customer Service for pricing on additional sizes and finishes

Bold pricing indicates item is in stock and available for **Fast Track** and **ProXpress**

HINGES
 CONTINUOUS HINGES
 PIVOTS
 Numerical 1-059
 Numerical 59-437
 Numerical 438-1021
 Numerical 1152-8190
 Numerical 8200-9340

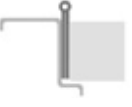
Continuous Hinges - Pin and Barrel

STEEL BASED

MODEL	DESCRIPTION	FINISH	LENGTH	BHMA FINISH	LIST	NOTES
600 UL Listed 	600 Concealed Hinge 1/8" Inset Non Handed	USP	83"	600	\$275.90	
			85"	600	346.80	
			95"	600	336.90	
			120"	600	416.40	
602 UL Listed 	602 Full Surface Flush Mount Handed when cut or modified	USP	83"	600	310.20	
			85"	600	361.90	
			95"	600	361.90	
			120"	600	487.60	
611 UL Listed 	611 Swing Clear No Inset, Handed when cut or modified Built in Edge Guard	USP	83"	600	487.20	
			85"	600	551.90	
			95"	600	551.90	
			120"	600	639.90	
700 UL Listed 	700 Concealed Hinge 1/8" Inset Non Handed	US32D	83"	630	488.50	
			85"	630	565.50	
			95"	630	565.50	
			120"	630	691.00	
702 UL Listed 	702 Full Surface Flush Mount Handed when cut or modified	US32D	83"	630	565.50	
			85"	630	671.30	
			95"	630	671.30	
			120"	630	921.90	
705 UL Listed 	705 Concealed Hinge Handed when cut or modified Adjusta-Stud Fasteners	US32D	83"	630	637.50	
			85"	630	718.00	
			95"	630	718.00	
			120"	630	877.00	
711 UL Listed 	711 Swing Clear Flush Mounted Surface Hinge No Inset, Handed when cut or modified Built in Edge Guard	US32D	83"	630	548.20	
			85"	630	647.30	
			95"	630	628.70	
			120"	630	788.70	
715 UL Listed 	715 Concealed Hinge Flush Mounted, Half Wrap Handed when cut or modified Built in Edge Guard	US32D	83"	630	594.60	
			85"	630	671.50	
			95"	630	671.50	
			120"	630	832.80	

HINGES

CONTINUOUS HINGES

PIVOTS

Numerical 1-059

Numerical 59-437

Numerical 438-1021

Numerical 1152-8190

Numerical 8200-9340

Contact Ives Customer Service for pricing on additional sizes and finishes

Bold pricing indicates item is in stock and available for **Fast Track** and **ProXpress**

Pin & Barrel Continuous Hinges - Additional Offerings

Custom Processing*

Custom cut to length	\$20.00	List add per hinge
Custom painting colors	Contact customer service for pricing and color approval. Additional lead time up to 6 weeks may be needed.	
	\$993.00	Flat rate for hinge quantity less than 12 for Tiger/Drylac paint
	\$83.00	List add per hinge for each hinge greater than 12.

Dutch Door Prep	\$122.00	List add per hinge
Hospital Tips	\$122.00	List add per hinge

* Return Policy - requires prior approval, consult factory

Electrical Modifications

EPT - Electrical Power Transfer prep 600, 700, 705, and 715	\$105.00	List add per hinge
TW8 - Electric Through-Wire 600, 700, 705, and 715	\$345.00	List add per hinge
CON - Allegion Connect 600, 700, 705, and 715	\$47.00	List add per hinge (Must order with TW8 and add CON List Adder)

Optional Mounting Hardware

Standard Mounting Hardware Hollow Metal Self Drilling / Self Tapping Screws (TEK) for Door and Frame 1/2 Wood Screws	\$0.00	No List Add
Security Screws Hollow Metal Door and Frame	\$36.00	List add per hinge Specify SECHM
Wood Screws Wood Door and Frame	\$20.00	List add per hinge Specify WD
Thread Forming Screws Hollow Metal Door and Frame <i>Recommended for grout filled frame. (Pilot holes required)</i>	\$20.00	List add per hinge Specify TF

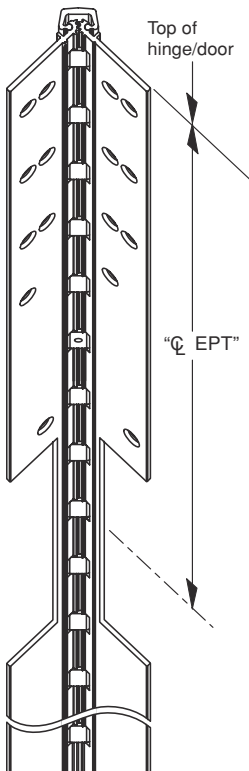

Ives Continuous Hinge - EPT Order Detail

(EPT's Measure from the top of the hinge to the centerline of the EPT Cutout)

Please supply the following information

_____ P/O Number

_____ Order #

_____ Length of Continuous Hinge

_____ Indicate RH or LH

_____ EPT Location

Note - EPT location is calculated from the TOP of the Hinge to the Centerline of the EPT cutout.

Model	Description	Lengths	List Price - Finishes Listed are for Aluminum Cover, Hinge leaves are Stainless Steel					
			441	600 (USP)	628 (US28)	688	709	710 (313AN)
			Satin Stainless Anodized	Primed Paint	Clear Anodized	Satin Brass Anodized	Satin Bronze Anodized	Dark Bronze Anodized
700CS	700CS Stainless Steel Full Mortise Hinge w/ AL Cover	83"	629.50	676.30	564.60	629.50	629.50	588.60
		85"	717.20	762.70	652.30	717.20	717.20	675.00
		95"	734.30	779.80	669.40	734.30	734.30	686.50
		120"	956.20	1002.90	891.30	956.20	956.20	914.10
	700CS w/TWP Stainless Steel Full Mortise Hinge w/ AL Cover, and Thru Wire Panel	83"	1234.10	1254.50	1204.50	1234.10	1234.10	1214.70
		85"	1234.10	1254.50	1204.50	1234.10	1234.10	1214.70
		95"	1234.10	1254.50	1204.50	1234.10	1234.10	1214.70
		120"	1234.10	1254.50	1204.50	1234.10	1234.10	1214.70
711CS	711CS Stainless Steel Swing Clear Hinge w/ AL Cover	83"	691.00	721.80	647.90	691.00	691.00	663.70
		85"	712.60	743.40	669.40	712.60	712.60	686.50
		95"	760.40	791.20	717.20	760.40	760.40	735.40
		120"	893.70	924.40	849.20	893.70	893.70	865.20
715CS	715CS Stainless Steel Full Mortise Hinge w/ Edge Guard and w/ AL Cover	83"	732.00	784.50	659.20	732.00	732.00	686.50
		85"	829.90	882.30	756.00	829.90	829.90	780.90
		95"	848.10	899.30	774.20	848.10	848.10	800.30
		120"	1105.30	1157.80	1031.30	1105.30	1105.30	1057.70

CS Series Continuous Hinges - Additional Offering

Custom Processing*

Custom cut to length \$40.00 List add per hinge
(All lengths = 13" from each end, TWP top only)

Custom painting colors Contact customer service for pricing and color approval.
Additional lead time up to 6 weeks may be needed.
\$993.00 Flat rate for hinge quantity less than 12 for Tiger/Drylac paint
\$83.00 List add per hinge for each hinge greater than 12.

* Return Policy - requires prior approval, consult factory

Dutch Door Prep N/A List add per hinge
Hospital Tips N/A List add per hinge

Electrical Modifications

EPT - Electrical Power Transfer prep \$105.00 List add per hinge
700CS and 715CS

TW8 - Electric Through-Wire N/A List add per hinge

CON - Allegion Connect \$47.00 List add per hinge (Must order with TW8 and add CON List Adder)
700CS only

Electrical Service Parts

700CS TWP Panel Service Kit \$808.00 List price

Optional Mounting Hardware



Standard Mounting Hardware \$0.00 No List Add
Hollow Metal Self Drilling / Self Tapping Screws (TEK) for Door and Frame

Security Screws \$36.00 List add per hinge
Hollow Metal Door and Frame Specify SECHM

Wood Screws \$20.00 List add per hinge
Wood Door and Frame Specify WD

Continuous Geared Hinges

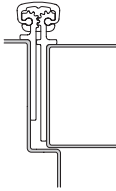
Aluminum Based

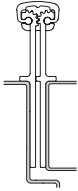
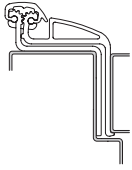
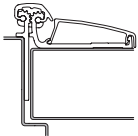
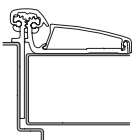
MODEL	DESCRIPTION	FINISH	LENGTH	BHMA FINISH	LIST	NOTES
026XY UL Listed 	026XY Heavy Duty Full Mortise - Narrow Frame Leaf, Wide Door Leaf 3/32" Inset Frame Leaf 1-9/16" Non Handed	US28	83"	628	\$223.40	
			85"	628	223.40	
			95"	628	271.70	
			119"	628	434.70	
		313AN	83"	710	277.70	
			85"	710	277.70	
			95"	710	356.30	
119"	710	555.50				
027XY UL Listed 	027XY Heavy Duty Full Mortise - Wide Door Leaf Flush mounted, No inset Frame Leaf 1-7/8 " Non Handed	US28	83"	628	229.40	
			85"	628	229.40	
			95"	628	265.70	
			119"	628	428.70	
		313AN	83"	710	301.90	
			85"	710	301.90	
			95"	710	350.20	
119"	710	549.50				
040XY UL Listed 	040XY Heavy Duty Full Mortise - Wide Throw Flush mounted, No inset Frame Leaf 1-11/16" Non Handed	US28	83"	628	392.50	
			85"	628	392.50	
			95"	628	483.00	
			119"	628	772.80	
		313AN	83"	710	513.20	
			85"	710	513.20	
			95"	710	615.80	
119"	710	990.20				
041XY UL Listed 	041XY Heavy Duty Full Mortise - Swing Clear 1/16" inset Frame Leaf 1-7/8" Non Handed	US28	83"	628	434.70	
			85"	628	434.70	
			95"	628	519.20	
			119"	628	797.00	
		313AN	83"	710	573.60	
			85"	710	573.60	
			95"	710	688.30	
119"	710	1,032.50				
045XY UL Listed 	045XY Heavy Duty Adjustable Half Surface 9/32" Inset Frame leaf 1-9/16" Non Handed	US28	83"	628	452.00	
			85"	628	452.00	
			95"	628	551.30	
			119"	628	826.90	
		313AN	83"	710	606.40	
			85"	710	606.40	
			95"	710	744.20	
119"	710	1,102.50				
046XY UL Listed 	046XY Heavy Duty Adjustable Half Surface 9/32" Inset Frame leaf 1-7/8" Non Handed	US28	83"	628	485.10	
			85"	628	485.10	
			95"	628	595.40	
			119"	628	887.60	
		313AN	83"	710	650.50	
			85"	710	650.50	
			95"	710	793.80	
119"	710	1,179.70				





HINGES
 CONTINUOUS HINGES
 PIVOTS
 Numerical 1-059
 Numerical 59-437
 Numerical 438-1021
 Numerical 1152-8190
 Numerical 8200-9340

Contact Ives Customer Service for pricing on additional sizes and finishes

Bold pricing indicates item is in stock and available for **Fast Track** and **ProXpress**

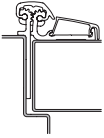
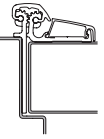
Continuous Geared Hinges

Aluminum Based

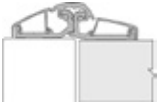

MODEL	DESCRIPTION	FINISH	LENGTH	BHMA FINISH	LIST	NOTES
053XY UL Listed 	053XY Heavy Duty Adjustable Half Surface 1/8" Inset Frame leaf 1-9/16" Non Handed	US28	83"	628	\$329.20	
			85"	628	329.20	
			95"	628	404.30	
			119"	628	623.70	
		313AN	83"	710	410.00	
			85"	710	410.00	
			95"	710	490.90	
054XY UL Listed 	054XY Heavy Duty Adjustable Half Surface 1/8" Inset Frame leaf 1-7/8" Non Handed	US28	83"	628	352.30	
			85"	628	352.30	
			95"	628	415.80	
			119"	628	652.60	
		313AN	83"	710	421.60	
			85"	710	421.60	
			95"	710	502.40	
112HD UL Listed 	112HD Heavy Duty Full Mortise No Inset, Non Handed Frame leaf 1-9/16"	US28	83"	628	163.50	
			85"	628	163.50	
			95"	628	203.80	
			120"	628	325.70	
		313AN	83"	710	211.10	
			85"	710	221.70	
			95"	710	263.60	
112XY UL Listed 	112XY Heavy Duty Full Mortise - Narrow Frame Leaf, Narrow Door Leaf No Inset, Frame Leaf 1-9/16" Non Handed	US28	83"	628	205.30	
			85"	628	205.30	
			95"	628	259.70	
			119"	628	410.60	
		313AN	83"	710	265.70	
			85"	710	265.70	
			95"	710	332.10	
114XY UL Listed 	114XY Heavy Duty Full Mortise - Narrow Frame Leaf, Door Edge Protector 1/16" inset Frame Leaf 1-9/16" Non Handed	US28	83"	628	217.40	
			85"	628	217.40	
			95"	628	265.70	
			119"	628	428.70	
		313AN	83"	710	271.70	
			85"	710	271.70	
			95"	710	350.20	
157XY UL Listed 	157XY Heavy Duty Adjustable Full Surface Center Pivot 1/16" Inset Non Handed	US28	83"	628	253.20	
			95"	628	332.20	
			119"	628	564.70	
		313AN	83"	710	303.70	
			95"	710	398.70	
			119"	710	623.80	

Contact Ives Customer Service for pricing on additional sizes and finishes

Bold pricing indicates item is in stock and available for **Fast Track** and **ProXpress**

Continuous Geared Hinges

Aluminum Based

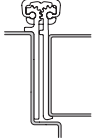
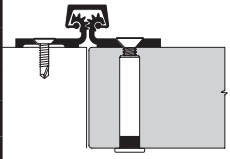
MODEL	DESCRIPTION	FINISH	LENGTH	BHMA FINISH	LIST	NOTES
210XY UL Listed 	210XY Heavy Duty Adjustable Full Surface Swing Clear 1/32" Inset Non Handed	US28	83"	628	\$300.30	
			85"	628	300.30	
			95"	628	352.30	
			119"	628	612.20	
		313AN	83"	710	352.30	
			85"	710	352.30	
			95"	710	433.10	
224HD UL Listed 	224HD Heavy Duty Full Mortise 1/16" Inset Non Handed	US28	83"	628	174.50	
			85"	628	174.50	
			95"	628	214.80	
			120"	628	338.00	
		313AN	83"	710	217.20	
			85"	710	228.10	
			95"	710	289.60	
224XY UL Listed 	224XY Heavy Duty Full Mortise - Door Edge Protector 1/16" inset Frame Leaf 1-7/8" Non Handed	US28	83"	628	217.40	
			85"	628	217.40	
			95"	628	265.70	
			119"	628	428.70	
		313AN	83"	710	271.70	
			85"	710	271.70	
			95"	710	350.20	
936HD UL Listed 	936HD Heavy Duty Full Surface Center Pivot No Inset Non Handed	US28	83"	628	227.90	
			85"	628	227.90	
			95"	628	299.00	
			120"	628	508.20	
		313AN	83"	710	296.20	
			85"	710	296.20	
			95"	710	388.70	
			120"	710	609.80	

HINGES
 CONTINUOUS HINGES
 PIVOTS
 Numerical 1-059
 Numerical 59-437
 Numerical 438-1021
 Numerical 1152-8190
 Numerical 8200-9340

Contact Ives Customer Service for pricing on additional sizes and finishes

Bold pricing indicates item is in stock and available for **Fast Track** and **ProXpress**

Continuous Geared Hinges

Geared Hinges - Additional Offerings

Custom Processing*

Custom cut to length	HD Models	\$20.00	List add per hinge
	XY Models	\$40.00	List add per hinge
Custom painting and anodized colors		Contact customer service for pricing and color approval. Additional lead time up to 6 weeks may be needed.	
		\$993.00	Flat rate for hinge quantity less than 12 for Tiger/Drylac paint
		\$83.00	List add per hinge for each hinge greater than 12.

* Return Policy - requires prior approval, consult factory

Hospital Tip (HT)

HT - Hospital Tip		\$122.00	List add per hinge
<i>026XY, 027XY, 040XY, 112XY, 114XY, 224XY, and 936HD only</i>			

School Option Tip (ST)

ST - School Option Tip		\$122.00	List add per hinge
<i>936HD only</i>			

Electrical Modifications

EPT - Electrical Power Transfer prep		\$105.00	List add per hinge
<i>026XY, 027XY, 112HD, 112XY, 114XY, 224HD, and 224XY only</i>			
TWP CON - Electric Through-Wire Panel with Allegion Connect		\$494.00	List add per hinge
<i>026XY, 027XY, 112XY, 114XY, and 224XY only</i>			

Electrical Service Parts

XY TWP Panel Service Kit		\$294.00	List price
<i>Same panel for all models (026XY, 027XY, 112XY, 114XY, 224XY)</i>			
<i>Use HGPART.1159 for US28, HGPART.1160 for 313AN</i>			
112HD TWP Panel Service Kit		\$249.00	List price
<i>Use 840737-28 for US28, 840737-42 for 313AN</i>			
224HD TWP Panel Service Kit		\$249.00	List price
<i>Use 840738-28 for US28, 84073842 for 313AN</i>			
6' Power Cable Kit for AL Geared TW8 and TWP		\$353.00	List price
<i>Contains LH & RH cable - 840738-00</i>			

Optional Mounting Hardware

Standard Mounting Hardware		\$0.00	No List add
Hollow Metal Self Drilling / Self Tapping Screws (TEK) for Door and Frame			
Security Screws - Hex Pin Drive		\$36.00	List add per hinge
Hollow Metal Door and Frame			Specify SECHM
1/2 Wood, 1/2 Hollow Metal			Specify SECWDHM
Wood Door and Frame			Specify SECWDWD
Wood Screws		\$20.00	List add per hinge
Wood Door and Frame			Specify WD
1/2 Self Drill, Self Tap, 1/2 Wood			Specify TEKWD
Thread Forming Screws		\$20.00	List add per hinge
Hollow Metal Door and Frame			Specify TF
1/2 Thread Forming, 1/2 Wood			Specify TFWD
(Pilot holes required. Recommended for grout filled frame)			

Contact Ives Customer Service for pricing on additional sizes and finishes

Bold pricing indicates item is in stock and available for **Fast Track** and **ProXpress**

HINGES
 CONTINUOUS HINGES
 PIVOTS
 Numerical 1-059
 Numerical 59-437
 Numerical 438-1021
 Numerical 1152-8190
 Numerical 8200-9340

MOUNTING HARDWARE

Standard Hardware Included - Hollow Metal Door and Frame

Full Mortise Hinges	12-24 x 3/4" Steel Self Drilling/Self Tapping, Flat Head, Phillips Screw (TEK)
Half Surface Hinges Includes 210XY	12-24 x 3/4" Steel Self Drilling/Self Tapping, Flat Head, Phillips Screw (TEK) 12-24 x 3/4" Steel Self Drilling/Self Tapping, Hex Head Screw (TEK)
Full Surface Hinges 157XY Only	12-24 x 3/4" Steel Self Drilling/Self Tapping, Hex Head Screw (TEK)

Security Screws - Hollow Metal Door and Frame (SECHM)

Full Mortise Hinges 112HD and 224HD Only	12-24 x 3/4" Stainless Steel, Flat Head, Hex Pin Security Machine Screw
Available as Accessory Parts Kit for Full Mortise XY Hinges (026XY, 027YX, 040XY, 041XY, 112XY, 112XY, 114XY, 224XY)	

Security Screws - 1/2 Wood, 1/2 Hollow Metal (SECWDHM)

Full Mortise Hinges 112HD and 224HD Only	12-24 x 3/4" Stainless Steel, Flat Head, Hex Pin Security Machine Screw 12-24 x 3/4" Stainless Steel Socket, Flat Head, Hex Pin Security Wood Screw
Available as Accessory Parts Kit for Full Mortise XY Hinges (026XY, 027YX, 040XY, 041XY, 112XY, 112XY, 114XY, 224XY)	

Security Screws - Wood Door and Frame (SECWDWD)

Full Mortise Hinges 112HD and 224HD Only	12 X 1 1/4" Stainless Steel, Flat Head, Hex Pin Security Wood Screw
Available as Accessory Parts Kit for Full Mortise XY Hinges (026XY, 027XY, 040XY, 041XY, 112XY, 114XY, 224XY)	

Wood Door and Frame (WD)

Full Mortise Hinges	12 x 1-1/4" Flat Head, Phillips Screw
Half Surface Hinges Includes 210XY	12 x 1-1/4" Flat Head, Phillips Screw 1/4 x 1-1/2" Hex Head Lag Screw
Full Surface Hinges 157XY Only	1/4 x 1-1/2" Hex Head Lag Screw

1/2 Self Drill, Self Tap 1/2 Wood (TEKWD)

Full Mortise Hinges	12-24 x 3/4" Steel Self Drilling/Self Tapping, Flat Head, Phillips Screw (TEK)	12 x 1-1/4" Flat Head, Phillips Wood Screw
Half Surface Hinges	12-24 x 3/4" Steel Self Drilling/Self Tapping, Flat Head, Phillips Screw (TEK)	1/4 x 1-1/2" Hex Head, Lag Screw
Full Surface Hinges	12-24 x 3/4" Steel Self Drilling/Self Tapping, Hex Head Screw (TEK)	1/4 x 1-1/2" Hex Head, Lag Screw

Thread Forming- Hollow Metal Door and Frame (TF)

Full Mortise Hinges 112HD and 224HD Only	12-24 x 3/4" Steel Thread Forming, Flat Head, Phillips Wood Screw
Available as Accessory Parts Kit for Full Mortise XY Hinges (026XY, 027YX, 040XY, 041XY, 112XY, 112XY, 114XY, 224XY)	

Thread Forming - 1/2 Thread Forming Hollow Metal, 1/2 Wood (TFWD)

Full Mortise Hinges 112HD and 224HD Only	12-24 x 3/4" Steel Thread Forming, Flat Head, Phillips Screw 12 x 1 1/4" Flat Head, Phillips Wood Screw
Available as Accessory Parts Kit for Full Mortise XY Hinges (026XY, 027XY, 040XY, 041XY, 112XY, 114XY, 224XY)	

HINGES
 CONTINUOUS HINGES
 PIVOTS
 Numerical 1-059
 Numerical 59-437
 Numerical 438-1021
 Numerical 1152-8190
 Numerical 8200-9340

Templates and installation instructions available on line at www.allegion.com/us

Contact Ives Customer Service for pricing on additional sizes and finishes

Pivots

	MODEL	PART DESCRIPTION	POUND RATING	BOX QTY	US3	US4	US10	US10B	US26 *US32	US26D *US32D	SP28	SP10	SPBLK	SP313	SP4
HINGES	7212 3/4" Offset Pivot	7212 SET	200	1	\$375.10	\$375.10	\$375.10	\$375.10	\$375.10	\$342.60	\$217.90	\$217.90	\$217.90	\$217.90	\$217.90
		7212 TOP	-	1	217.90	217.90	217.90	217.90	217.90	187.50	132.90	132.90	132.90	132.90	132.90
		7212 BTM	200	1	228.40	228.40	228.40	228.40	228.40	195.70	149.10	149.10	149.10	149.10	149.10
		7212 INT	100	1	250.40	250.40	250.40	250.40	250.40	217.90	172.50	172.50	172.50	172.50	172.50
CONTINUOUS HINGES	7212V 3/4" Offset Pivot, Jamb Mount	7212V SET	200	1	390.20	390.20	390.20	390.20	390.20	358.80	297.00	297.00	297.00	297.00	297.00
		7212V TOP	-	1	228.40	228.40	228.40	228.40	228.40	195.70	149.10	149.10	149.10	149.10	149.10
		7212V INT	100	1	250.40	250.40	250.40	250.40	250.40	217.90	172.50	172.50	172.50	172.50	172.50
PIVOTS	7215 3/4" Offset Pivot	7215 SET	500	1	405.50	405.50	405.50	405.50	405.50	375.10	327.40	327.40	327.40	327.40	327.40
		7215 TOP	-	1	217.90	217.90	217.90	217.90	217.90	187.50	132.90	132.90	132.90	132.90	132.90
		7215 BTM	500	1	250.40	250.40	250.40	250.40	250.40	234.20	255.10	255.10	255.10	255.10	255.10
		7215 INT	100	1	228.40	228.40	228.40	228.40	228.40	202.80	187.50	187.50	187.50	187.50	187.50
		7215PT(TW4) INT	-	1	816.90	816.90	816.90	816.90	816.90	633.80	593.50	593.50	593.50	593.50	593.50
Numerical 1-059	7215F Fire Rated 3/4" Offset Pivot	7215F SET	500	1	639.70	-	639.70	-	639.70	606.90	498.80	498.80	498.80	498.80	498.80
		7215F TOP	-	1	383.30	-	383.30	-	383.30	336.60	280.80	280.80	280.80	280.80	280.80
		7215F BTM	500	1	446.30	-	446.30	-	446.30	413.50	327.40	327.40	327.40	327.40	327.40
		7215F INT	100	1	358.80	-	358.80	-	358.80	342.60	290.10	290.10	290.10	290.10	290.10
Numerical 59-437	7222 3/4" Offset Pivot	7222 SET	200	1	327.40	327.40	327.40	327.40	327.40	297.00	217.90	217.90	217.90	217.90	217.90
		7222 TOP	-	1	217.90	217.90	217.90	217.90	217.90	187.50	132.90	132.90	132.90	132.90	132.90
		7222 BTM	200	1	212.10	212.10	212.10	212.10	212.10	180.50	125.80	125.80	125.80	125.80	125.80
		7222 INT	100	1	250.40	250.40	250.40	250.40	250.40	217.90	172.50	172.50	172.50	172.50	172.50
Numerical 438-1021	7226 3/4" Offset Pivot	7226 SET	600	1	390.20	390.20	390.20	390.20	390.20	358.80	280.80	280.80	280.80	280.80	280.80
		7226 TOP	-	1	217.90	217.90	217.90	217.90	217.90	187.50	132.90	132.90	132.90	132.90	132.90
		7226 BTM	600	1	234.20	234.20	234.20	234.20	234.20	217.90	195.70	195.70	195.70	195.70	195.70
		7226 INT	100	1	228.40	228.40	228.40	228.40	228.40	202.80	187.50	187.50	187.50	187.50	187.50
		7226PT(TW4) INT	-	1	816.90	816.90	816.90	816.90	816.90	633.80	593.50	593.50	593.50	593.50	593.50
Numerical 1152-8190															
Numerical 8200-9340															

Contact Ives Customer Service for pricing on additional sizes and finishes

Bold pricing indicates item is in stock and available for **Fast Track** and **ProXpress**

Pivots

MODEL	PART DESCRIPTION	POUND RATING	BOX QTY	US3	US4	US10	US10B	US26 *US32	US26D *US32D	SP28	SP10	SPBLK	SP313	SP4
7226F Fire Rated 3/4" Offset Pivot	7226F SET	600	1	\$561.60	-	\$561.60	-	\$561.60	\$531.30	\$452.10	\$452.10	\$452.10	\$452.10	\$452.10
	7226F TOP	-	1	383.30	-	383.30	-	383.30	336.60	280.80	280.80	280.80	280.80	280.80
	7226F BTM	600	1	398.50	-	398.50	-	398.50	342.60	321.60	321.60	321.60	321.60	321.60
	7226F INT	600	1	358.80	-	358.80	-	358.80	342.60	290.10	290.10	290.10	290.10	290.10
7227 3/4" Offset Pivot	7227 SET	700	1	655.90	655.90	655.90	655.90	655.90	624.60	546.40	546.40	546.40	546.40	546.40
	7227 TOP	-	1	217.90	217.90	217.90	217.90	217.90	187.50	132.90	132.90	132.90	132.90	132.90
	7227 BTM	700	1	593.00	593.00	593.00	593.00	593.00	531.30	491.70	491.70	491.70	491.70	491.70
	7227 INT	100	1	228.40	228.40	228.40	228.40	228.40	202.80	187.50	187.50	187.50	187.50	187.50
	7227PT(TW4) INT	-	1	816.90	816.90	816.90	816.90	816.90	633.80	593.50	593.50	593.50	593.50	593.50
7227F Fire Rated 3/4" Offset Pivot	7227F SET	700	1	826.00	-	826.00	-	826.00	794.70	701.40	701.40	701.40	701.40	701.40
	7227F TOP	-	1	383.30	-	383.30	-	383.30	336.60	280.80	280.80	280.80	280.80	280.80
	7227F BTM	700	1	593.00	-	593.00	-	593.00	531.30	491.70	491.70	491.70	491.70	491.70
	7227F INT	100	1	358.80	-	358.80	-	358.80	342.60	290.10	290.10	290.10	290.10	290.10
7230F Fire Rated 3/4" Offset Pivot	7230F SET	1000	1	701.40	-	701.40	-	701.40	669.90	593.00	593.00	593.00	593.00	593.00
	7230F TOP	-	1	358.80	-	358.80	-	358.80	336.60	290.10	290.10	290.10	290.10	290.10
	7230F BTM	1000	1	429.80	-	429.80	-	429.80	413.50	367.00	367.00	367.00	367.00	367.00
	7230F INT	100	1	390.20	-	390.20	-	390.20	375.10	321.60	321.60	321.60	321.60	321.60
7237F Fire Rated 3/4" Offset	7237F SET	1750	1	857.50	-	857.50	-	857.50	826.00	749.20	749.20	749.20	749.20	749.20
	7237F TOP	-	1	358.80	-	358.80	-	358.80	336.60	290.10	290.10	290.10	290.10	290.10
	7237F BTM	1750	1	593.00	-	593.00	-	593.00	576.70	538.40	538.40	538.40	538.40	538.40
	7237F INT	100	1	390.20	-	390.20	-	390.20	375.10	321.60	321.60	321.60	321.60	321.60
7244F Fire Rated 1-1/2" Offset Pivot	7244F SET	400	1	725.90	-	725.90	-	725.90	701.40	606.90	606.90	606.90	606.90	606.90
	7244F TOP	-	1	390.20	-	390.20	-	390.20	367.00	336.60	336.60	336.60	336.60	336.60
	7244F BTM	400	1	421.80	-	421.80	-	421.80	398.50	342.60	342.60	342.60	342.60	342.60
	7244F INT	100	1	421.80	-	421.80	-	421.80	398.50	351.80	351.80	351.80	351.80	351.80

HINGES

CONTINUOUS
HINGES

PIVOTS

Numerical
1-059

Numerical
59-437

Numerical
438-1021

Numerical
1152-8190

Numerical
8200-9340

Contact Ives Customer Service for pricing on additional sizes and finishes

Bold pricing indicates item is in stock and available for **Fast Track** and **ProXpress**

Pivots







MODEL	PART DESCRIPTION	POUND RATING	BOX QTY	US3	US4	US10	US10B	US26 *US32	US26D *US32D	SP28	SP10	SPBLK	SP313	SP4	USP
7245F Fire Rated 1-1/2" Offset Pivot	7245FSET	500	1	\$935.60	-	\$935.60	-	\$935.60	\$904.20	\$826.00	\$826.00	\$826.00	\$826.00	\$826.00	-
	7245F TOP	-	1	390.20	-	390.20	-	390.20	367.00	336.60	336.60	336.60	336.60	336.60	-
	7245F BTM	500	1	655.90	-	655.90	-	655.90	639.70	576.70	576.70	576.70	576.70	576.70	-
	7245FINT	100	1	421.80	-	421.80	-	421.80	398.50	351.80	351.80	351.80	351.80	351.80	-
7253 1-1/2" Pivot Center Hung	7253SET	300	1	297.00	297.00	297.00	297.00	297.00	297.00	258.60	258.60	258.60	258.60	258.60	-
	7253 TOP	-	1	180.50	180.50	180.50	180.50	180.50	180.50	164.30	164.30	164.30	164.30	164.30	-
	7253 BTM	300	1	164.30	164.30	164.30	164.30	164.30	142.10	118.90	118.90	118.90	118.90	118.90	-
7255 1-1/2" Pivot Center Hung	7255SET	500	1	327.40	327.40	327.40	327.40	327.40	327.40	305.30	305.30	305.30	305.30	305.30	-
	7255 TOP	-	1	180.50	180.50	180.50	180.50	180.50	180.50	164.30	164.30	164.30	164.30	164.30	-
	7255 BTM	500	1	187.50	187.50	187.50	187.50	187.50	187.50	180.50	180.50	180.50	180.50	180.50	-
7255J 1-1/2" Pivot Center Hung	7255JSET	600	1	327.40	327.40	327.40	327.40	327.40	327.40	305.30	305.30	305.30	305.30	305.30	-
	7255J TOP	-	1	180.50	180.50	180.50	180.50	180.50	180.50	164.30	164.30	164.30	164.30	164.30	-
	7255J BTM	500	1	187.50	187.50	187.50	187.50	187.50	187.50	180.50	180.50	180.50	180.50	180.50	-
7256 1 1/2" Pivot Center Hung	7256SET	600	1	546.40	546.40	546.40	546.40	546.40	515.10	491.70	491.70	491.70	491.70	491.70	-
	7256 TOP	-	1	180.50	180.50	180.50	180.50	180.50	180.50	164.30	164.30	164.30	164.30	164.30	-
	7256 BTM	600	1	446.30	446.30	446.30	446.30	446.30	421.80	398.50	398.50	398.50	398.50	398.50	-
7259 1 1/2" Pivot Center Hung	7259SET	1000	1	982.10	982.10	982.10	982.10	982.10	949.50	919.20	919.20	919.20	919.20	919.20	-
	7259 TOP	-	1	383.30	383.30	383.30	383.30	383.30	327.40	273.80	273.80	273.80	273.80	273.80	-
	7259 BTM	1000	1	810.90	810.90	810.90	810.90	810.90	779.40	756.10	756.10	756.10	756.10	756.10	-
91105F Pocket Pivot E = Power Transfer	91105F	90	1	442.40	-	442.40	442.40	442.40	401.50	-	-	-	401.50	-	\$401.50
	E91105F	90	1	1031.30	-	1031.30	-	1031.30	989.50	-	-	-	989.50	-	989.50

* Fire rated models US32 and US32D (stainless), all others US26 and US26D (brass)

Suffix Descriptions

- BTM** - Bottom Only
- F** - Fire Rated
- INT** - Intermediate Pivot Only
- PT** - Power Transfer, TW4 standard, TW* consult Factory for lead time.
- SET** - Top and Bottom Pivot
- TOP** - Top Only
- V** - Vertical Side Mount

(Weather Resistant) WP bearings available for 7215 26D and 7215F 32D bottom pivots at \$67 list add. Consult factory for lead time.

MODEL	SUBSTRATE	MODEL NUMBER	BHMA FINISH	WEIGHT	MUST BE ORDERED IN MULTIPLE QTY	MULTIPLE QTY	PACKED PER BOX	LIST PRICE	
								EACH	PACKAGE
CBI Carry Bar w/ Sex Bolts 	Steel	CBI USP	600	-	-	-	-	\$32.30	-
		CBI US3	632	-	-	-	-	49.40	-
		CBI US4	633	-	-	-	-	49.40	-
		CBI US10	639	-	-	-	-	49.40	-
		CBI US10B	640	-	-	-	-	49.40	-
		CBI US26	651	-	-	-	-	49.40	-
		CBI US26D	652	-	-	-	-	49.40	-
		CBI SPBLK	693	-	-	-	-	32.30	-
DPI Dust Proof Strike Threshold Only 	Brass	DPI US3	605	-	-	1	-	25.70	-
		DPI US4	606	-	-	1	-	25.70	-
		DPI US10	612	-	-	1	-	25.70	-
		DPI US10B	613	-	-	1	-	25.70	-
		DPI US26	625	-	-	1	-	25.70	-
		DPI US26D	626	-	-	1	-	25.70	-
LG1 Lock Guard with Security Pin Frame 	Steel	LG1 USP	600	-	-	1	-	21.70	-
		LG1 US2G	603	-	-	1	-	17.70	-
		LG1 SP313	695	-	-	1	-	20.50	-
	Brass	LG1 US4	606	-	-	1	-	45.10	-
		LG1 US10	612	-	-	1	-	45.10	-
Stainless	LG1 US32D	630	-	-	1	-	40.90	-	
MB1 Mounting Bracket	See Page 32								
DP2 Dust Proof Strike Floor and /or Threshold 	Brass	DP2 US3	605	-	-	1	-	32.40	-
		DP2 US4	606	-	-	1	-	32.40	-
		DP2 US10	612	-	-	1	-	32.40	-
		DP2 US10B	613	-	-	1	-	32.40	-
		DP2 US26	625	-	-	1	-	32.40	-
		DP2 US26D	626	-	-	1	-	32.40	-
MB2 Mounting Bracket	See Page 32								
2 Elbow Cabinet Catch 	Aluminum	2A3	666	0.9	-	1	20	4.00	-
		2A5	-	0.9	-	1	20	4.50	-
		2A14	669	0.9	-	1	20	4.50	-
		2A15	670	0.9	-	1	20	4.50	-
		2A92	673	0.9	-	1	20	4.00	-
		2A-716	-	0.9	-	1	20	4.50	-
		SP2A3	666	37.5	Yes	25	25	-	\$100.60
		SP2A14	669	37.5	Yes	25	25	-	109.20
SP2A92	673	37.5	Yes	25	25	-	100.60		
MB3 Mounting Bracket	See Page 32								
LG7 Lock Guard	Stainless	LG7 US32D	630	-	-	1	-	40.90	-
COR7G Coordinator Gravity Arm 7" arm UL Listed 	Brass	COR7G US3	605	-	-	1	-	81.10	-
		COR7G US4	606	-	-	1	-	81.10	-
		COR7G US10	612	-	-	1	-	81.10	-
		COR7G US10B	613	-	-	1	-	81.10	-
		COR7G US26	625	-	-	1	-	109.40	-
		COR7G US26D	626	-	-	1	-	67.40	-

HINGES

CONTINUOUS HINGES

PIVOTS

Numerical 1-059

Numerical 59-437

Numerical 438-1021





Numerical 1152-8190

Numerical 8200-9340













Contact Ives Customer Service for pricing on additional sizes and finishes

Bold pricing indicates item is in stock and available for **Fast Track** and **ProXpress**

HINGES
 CONTINUOUS HINGES
 PIVOTS
 Numerical 1-059
 Numerical 59-437
 Numerical 438-1021
 Numerical 1152-8190
 Numerical 8200-9340

MODEL	SUBSTRATE	MODEL NUMBER	BHMA FINISH	WEIGHT	MUST BE ORDERED IN MULTIPLE QTY	MULTIPLE QTY	PACKED PER BOX	LIST PRICE	
								EACH	PACKAGE
07 Window Lock 	Aluminum	07A3	666	1.7	-	1	20	\$2.70	-
		07A10B	703	1.7	-	1	20	3.00	-
		07A14	669	1.7	-	1	20	3.00	-
		07A15	670	1.7	-	1	20	3.00	-
		07A92	673	1.7	-	1	20	2.70	-
		07A-716	-	1.7	-	1	20	3.00	-
		07A-BLK	-	1.7	-	1	20	4.00	-
		07A-W	-	1.7	-	1	20	4.00	-
		SP07A3	666	65.0	Yes	25	25	-	\$67.60
		SP07A5	-	65.0	Yes	25	25	-	99.20
		SP07A14	669	65.0	Yes	25	25	-	76.20
		SP07A92	673	65.0	Yes	25	25	-	67.60
	SP07A-W	-	52.0	Yes	20	20	-	79.40	
	Brass	07B3	605	2.3	-	1	10	16.40	-
		07B15	619	2.3	-	1	10	20.70	-
07B26		625	2.3	-	1	10	20.00	-	
07B26D		626	2.3	-	1	10	20.00	-	
07B-716		-	2.6	-	1	10	20.00	-	
SPS07B-605		605	52.0	Yes	20	20	-	411.50	
SPS07B-609		609	52.0	Yes	20	20	-	411.50	
SPS07B-619		619	52.0	Yes	20	20	-	411.50	
SPS07B-620		620	52.0	Yes	20	20	-	411.50	
SPS07B-716		-	52.0	Yes	20	20	-	411.50	
COR9G Coordinator Gravity Arm 9" arm UL Listed	Brass	COR9G US3	605	-	-	1	-	91.70	-
		COR9G US4	606	-	-	1	-	91.70	-
		COR9G US10	612	-	-	1	-	91.70	-
		COR9G US10B	613	-	-	1	-	91.70	-
		COR9G US26	625	-	-	1	-	109.40	-
		COR9G US26D	626	-	-	1	-	77.30	-
FS9 Floor Stop 	Brass	FS9 US3	605	-	-	1	-	185.30	-
		FS9 US4	606	-	-	1	-	185.30	-
		FS9 US10	612	-	-	1	-	185.30	-
		FS9 US10B	613	-	-	1	-	185.30	-
		FS9 US26	625	-	-	1	-	185.30	-
		FS9 US26D	626	-	-	1	-	158.80	-
LG10 Lock Guard	Stainless	LG10 US32D	630	-	-	1	-	38.20	-
	Steel	LG10 USP	600	-	-	1	-	26.00	-
CL11 Cabinet Latch 	Brass	CL11 US3	605	-	-	1	-	41.70	-
		CL11 US4	606	-	-	1	-	32.90	-
		CL11 US10	612	-	-	1	-	32.90	-
		CL11 US26D	626	-	-	1	-	32.90	-
LG11 Lock Guard 	Stainless	LG11 US32D RH	630	-	-	1	-	45.10	-
		LG11 US32D LH	630	-	-	1	-	45.10	-
	Steel	LG11 SP313 RH	695	-	-	1	-	34.10	-
		LG11 SP313 LH	695	-	-	1	-	34.10	-
WS11 Wall Stop for Drywall Mounting 	Brass	WS11 US3	605	-	-	1	-	41.20	-
		WS11 US4	606	-	-	1	-	41.20	-
		WS11 US10	612	-	-	1	-	41.20	-
		WS11 US10B	613	-	-	1	-	41.20	-
		WS11 US26	625	-	-	1	-	41.20	-
		WS11 US26D	626	-	-	1	-	40.10	-

Bold pricing indicates item is in stock and available for **Fast Track** and **ProXpress**

MODEL	SUBSTRATE	MODEL NUMBER	BHMA FINISH	WEIGHT	MUST BE ORDERED IN MULTIPLE QTY	MULTIPLE QTY	PACKED PER BOX	LIST PRICE	
								EACH	PACKAGE
WS11X Wall Stop for Masonry Mounting 	Brass	WS11X US3	605	-	-	1	-	\$43.90	-
		WS11X US4	606	-	-	1	-	43.90	-
		WS11X US10	612	-	-	1	-	43.90	-
		WS11X US10B	613	-	-	1	-	43.90	-
		WS11X US26	625	-	-	1	-	43.90	-
		WS11X US26D	626	-	-	1	-	42.50	-
CL12 Cabinet Latch 	Brass	CL12 US3	605	-	-	1	-	48.20	-
		CL12 US4	606	-	-	1	-	42.60	-
		CL12 US10	612	-	-	1	-	42.60	-
		CL12 US26D	626	-	-	1	-	42.60	-
LG12 Lock Guard - Narrow 	Stainless	LG12 US32D	630	-	-	1	-	35.50	-
	Steel	LG12 USP	600	-	-	1	-	26.00	-
FS13 Floor Dome Stop 1" height 	Brass	FS13 US3	605	-	-	1	-	7.40	-
		FS13 US4	606	-	-	1	-	8.80	-
		FS13 US10	612	-	-	1	-	8.90	-
		FS13 US10B	613	-	-	1	-	8.90	-
		FS13 US26	625	-	-	1	-	8.80	-
		FS13 US26D	626	-	-	1	-	7.40	-
LG13 Lock Guard 	Stainless	LG13 US32D	630	-	-	1	-	34.10	-
	Steel	LG13 USP	600	-	-	1	-	22.40	-
CL14 Cabinet Latch 	Brass	CL14 US3	605	-	-	1	-	44.20	-
		CL14 US4	606	-	-	1	-	37.10	-
		CL14 US10	612	-	-	1	-	37.10	-
		CL14 US26D	626	-	-	1	-	37.10	-
LG14 Lock Guard 	Stainless	LG14 US32D	630	-	-	1	-	56.00	-
FS17 Floor Dome Stop 1-11/32" height 	Brass	FS17 US3	605	-	-	1	-	8.30	-
		FS17 US4	606	-	-	1	-	10.00	-
		FS17 US10	612	-	-	1	-	10.20	-
		FS17 US10B	613	-	-	1	-	10.20	-
		FS17 US26	625	-	-	1	-	10.00	-
		FS17 US26D	626	-	-	1	-	8.30	-
R14 Riser For FS13 and FS17 Dome Stops 5/16" Height 	Steel	R14 US3	605	-	-	1	-	6.30	-
		R14 US4	606	-	-	1	-	6.30	-
		R14 US10	612	-	-	1	-	7.00	-
		R14 US10B	613	-	-	1	-	7.00	-
		R14 US26	625	-	-	1	-	7.00	-
		R14 US26D	626	-	-	1	-	8.20	-
AS18 Applied Stop 	Brass	AS18 US3	605	-	-	1	-	51.00	-
		AS18 US4	606	-	-	1	-	46.90	-
		AS18 US10	612	-	-	1	-	46.90	-
		AS18 US10B	613	-	-	1	-	51.00	-
		AS18 US26	625	-	-	1	-	51.00	-
		AS18 US26D	626	-	-	1	-	51.00	-
FS18 Security Floor or Wall Stop 	Steel/	FS18S	-	-	-	1	-	11.00	-
	Rubber	FS18L	-	-	-	1	-	15.50	-
FL20 Filler Bar 	See page 32								
WS20 Manual Wall Stop and Holder for Drywall Mounting 	Brass	WS20 US3	605	-	-	1	-	74.60	-
		WS20 US4	606	-	-	1	-	74.60	-
		WS20 US10	612	-	-	1	-	74.60	-
		WS20 US10B	613	-	-	1	-	74.60	-
		WS20 US26	625	-	-	1	-	74.60	-
		WS20 US26D	626	-	-	1	-	62.60	-
	Aluminum	WS20 US28	628	-	-	1	-	59.70	-

Bold pricing indicates item is in stock and available for **Fast Track** and **ProXpress**

HINGES

CONTINUOUS
HINGES

PIVOTS

Numerical
1-059

Numerical
59-437

Numerical
438-1021

Numerical
1152-8190

Numerical
8200-9340

HINGES

CONTINUOUS HINGES

PIVOTS





Numerical 1-059

Numerical 59-437

Numerical 438-1021

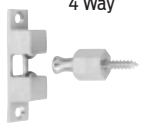



Numerical 1152-8190

Numerical 8200-9340

MODEL	SUBSTRATE	MODEL NUMBER	BHMA FINISH	WEIGHT	MUST BE ORDERED IN MULTIPLE QTY	MULTIPLE QTY	PACKED PER BOX	LIST PRICE	
								EACH	PACKAGE
WS20X Manual Wall Stop and Holder for Masonry Mounting 	Brass	WS20X US3	605	-	-	1	-	\$77.20	-
		WS20X US4	606	-	-	1	-	77.20	-
		WS20X US10	612	-	-	1	-	77.20	-
		WS20X US10B	613	-	-	1	-	77.20	-
		WS20X US26	625	-	-	1	-	77.20	-
		WS20X US26D	626	-	-	1	-	66.70	-
	Aluminum	WS20X US28	628	-	-	1	-	63.50	-
CL21/21A Ball Catch 4 Way 	Brass	CL21 US26D	626	-	-	1	-	44.10	-
		CL21A US3	605	-	-	1	-	46.90	-
		CL21A US4	606	-	-	1	-	31.70	-
		CL21A US10	612	-	-	1	-	31.70	-
		CL21A US26	625	-	-	1	-	46.90	-
		CL21A US26D	626	-	-	1	-	34.50	-
CL22 Ball Catch 3 Way 	Brass	CL22 US3	605	-	-	1	-	27.60	-
		CL22 US4	606	-	-	1	-	19.30	-
		CL22 US10	612	-	-	1	-	19.30	-
		CL22 US26	625	-	-	1	-	27.60	-
		CL22 US26D	626	-	-	1	-	23.30	-
22 Flush Pull 	Brass	22B3	605	1.1	-	1	20	3.10	-
		22B5	609	2.0	-	1	20	3.50	-
		22B10B	613	1.3	-	1	20	3.50	-
		22B15	619	1.6	-	1	20	3.40	-
		22B26	625	1.6	-	1	20	3.50	-
		22B26D	626	1.1	-	1	20	3.50	-
		SP22B3	605	50.0	Yes	25	25	-	\$78.70
25 Screen Door Pull 	Aluminum	25A3	666	1.2	-	1	20	1.80	-
		25A92	673	1.2	-	1	20	1.80	-
		25A-BLK	-	1.2	-	1	20	2.50	-
		25A-W	-	1.2	-	1	20	2.50	-
		SP25A3	666	30.0	Yes	25	25	-	43.80
		SP25A92	673	30.0	Yes	25	25	-	43.80
026 Bar Window Lift 	Aluminum	026A3	666	1.9	-	1	10	1.90	-
		026A5	-	1.1	-	1	10	2.40	-
		026A14	669	1.8	-	1	10	2.40	-
		026A15	670	1.9	-	1	10	2.40	-
		026A92	673	1.1	-	1	10	1.90	-
		026A-716	-	1.1	-	1	10	2.40	-
		026A-BLK	-	1.4	-	1	10	2.90	-
		026A-W	-	1.4	-	1	10	2.90	-
		SP026A3	666	45.0	Yes	25	25	-	46.60
		SP026A5	-	45.0	Yes	25	25	-	61.30
		SP026A14	669	45.0	Yes	25	25	-	61.30
		SP026A92	673	45.0	Yes	25	25	-	46.60
				SP026A-W	-	-	Yes	20	20

Continued on next page.

Bold pricing indicates item is in stock and available for **Fast Track** and **ProXpress**

MODEL	SUBSTRATE	MODEL NUMBER	BHMA FINISH	WEIGHT	MUST BE ORDERED IN MULTIPLE QTY	MULTIPLE QTY	PACKED PER BOX	LIST PRICE	
								EACH	PACKAGE
<i>Continued from previous page.</i> 026 Bar Window Lift 	Brass	026B3	605	-	-	1	10	\$8.50	
		026B5	609	-	-	1	10	10.30	
		026B15	619	-	-	1	10	10.50	
		026B26	625	-	-	1	10	10.50	
		026B26D	626	-	-	1	10	10.30	
		026B-716	-	-	-	1	10	10.50	
		SP026B26	625	-	Yes	10	10	-	\$104.50
		SPS026B-605	605	-	Yes	20	20	-	174.70
		SPS026B-609	609	-	Yes	20	20	-	209.10
		SPS026B-619	619	-	Yes	20	20	-	209.10
		SPS026B-620	620	-	Yes	20	20	-	209.10
SPS026B-716	-	-	Yes	20	20	-	209.10		
RL30 Nylon Roller 	Brass	RL30 US3	605	-	-	1	-	67.70	-
		RL30 US4	606	-	-	1	-	57.60	-
		RL30 US10	612	-	-	1	-	59.90	-
		RL30 US10B	613	-	-	1	-	70.10	-
		RL30 US26	625	-	-	1	-	67.70	-
		RL30 US26D	626	-	-	1	-	63.90	-
RL30A Nylon Roller w/ASA Stike 	Brass	RL30-A US3	605	-	-	1	-	75.80	-
		RL30-A US4	606	-	-	1	-	65.70	-
		RL30-A US10	612	-	-	1	-	68.40	-
		RL30-A US10B	613	-	-	1	-	78.50	-
		RL30-A US26	625	-	-	1	-	75.80	-
		RL30-A US26D	626	-	-	1	-	72.10	-
FB31 Automatic Flush Bolts, Metal Doors UL 3 Hour Top and Bottom Bolt P=Pair T=Top Bolt Only B=Bottom Bolt Only Optional Rod Lengths Available 18", 24", 36", 48" 11.10 List Add 	Steel	FB31P-12-MD US3	605	-	-	1	-	182.10	-
		FB31P-12-MD US4	606	-	-	1	-	182.10	-
		FB31P-12-MD US10	612	-	-	1	-	182.10	-
		FB31P-12-MD US10B	613	-	-	1	-	182.10	-
	Stainless	FB31P-12-MD US32	629	-	-	1	-	182.10	-
		FB31P-12-MD US32D	630	-	-	1	-	182.10	-
	Brass	FB31T-12-MD US3	605	-	-	1	-	96.10	-
		FB31T-12-MD US4	606	-	-	1	-	96.10	-
		FB31T-12-MD US10	612	-	-	1	-	96.10	-
		FB31T-12-MD US10B	613	-	-	1	-	96.10	-
	Stainless	FB31T-12-MD US32	629	-	-	1	-	96.10	-
		FB31T-12-MD US32D	630	-	-	1	-	96.10	-
	Brass	FB31B-12-MD US3	605	-	-	1	-	96.10	-
		FB31B-12-MD US4	606	-	-	1	-	96.10	-
		FB31B12-MD US10	612	-	-	1	-	96.10	-
		FB31B-12-MD US10B	613	-	-	1	-	96.10	-
	Stainless	FB31B-12-MD US32	629	-	-	1	-	96.10	-
		FB31B-12-MD US32D	630	-	-	1	-	96.10	-
COR32* Door Coordinator 32" Channel Length UL Listed *See note at page bottom for door prep charges.	Aluminum	COR32 US28	628	-	-	1	-	142.60	-
		COR32 315AN	711	-	-	1	-	190.40	-
		COR32 US26D	713	-	-	1	-	282.30	-
		COR32 US28w/FL20	628	-	-	1	-	156.30	-
COR42* Door Coordinator 42" Channel Length UL Listed *See note at page bottom for door prep charges.	Aluminum	COR42 US28	628	-	-	1	-	153.50	-
		COR42 315AN	711	-	-	1	-	202.70	-
		COR42 US26D	713	-	-	1	-	299.90	-
		COR42 US28w/FL20	628	-	-	1	-	167.20	-
		COR42 US28w/FL32	628	-	-	1	-	169.90	-
		COR42 US28w/FL44	628	-	-	1	-	174.10	-

*Special factory preparation for use with vertical rod exit devices available. **List Add \$122.00.** Bold pricing indicates item is in stock and available for **Fast Track** and **ProXpress**

HINGES

CONTINUOUS HINGES

PIVOTS

Numerical
1-059

Numerical
59-437

Numerical
438-1021

Numerical
1152-8190

Numerical
8200-9340

HINGES

CONTINUOUS HINGES

PIVOTS

Numerical 1-059

Numerical 59-437





Numerical 438-1021

Numerical 1152-8190

Numerical 8200-9340

MODEL	SUBSTRATE	MODEL NUMBER	BHMA FINISH	WEIGHT	MUST BE ORDERED IN MULTIPLE QTY	MULTIPLE QTY	PACKED PER BOX	LIST PRICE	
								EACH	PACKAGE
COR52* Door Coordinator 52" Channel Length UL Listed *See note at page bottom for door prep charges.	Aluminum	COR52 US28	628	-	-	1	-	\$145.20	-
		COR52 315AN	711	-	-	1	-	188.60	-
		COR52 US26D	713	-	-	1	-	297.60	-
		COR52 US28w/FL20	628	-	-	1	-	158.90	-
		COR52 US28w/FL32	628	-	-	1	-	161.60	-
		COR52 US28w/FL44	628	-	-	1	-	165.80	-
COR60* Door Coordinator 60" Channel Length UL Listed *See note at page bottom for door prep charges.	Aluminum	COR60 US28	628	-	-	1	-	169.40	-
		COR60 315AN	711	-	-	1	-	220.60	-
		COR60 US26D	713	-	-	1	-	320.40	-
		COR60 US28w/FL20	628	-	-	1	-	183.10	-
		COR60 US28w/FL32	628	-	-	1	-	185.80	-
		COR60 US28w/FL44	628	-	-	1	-	190.00	-
COR72* Door Coordinator 72" Channel Length UL Listed *See note at page bottom for door prep charges.	Aluminum	COR72 US28	628	-	-	1	-	192.70	-
		COR72 315AN	711	-	-	1	-	265.80	-
		COR72 US26D	713	-	-	1	-	383.30	-
		COR72 US28w/FL20	628	-	-	1	-	206.40	-
		COR72 US28w/FL32	628	-	-	1	-	209.10	-
		COR72 US28w/FL44	628	-	-	1	-	213.30	-
FL20 Filler Bar 20" Length	Aluminum	FL20 US28	628	-	-	1	-	13.70	-
		FL20 315AN	711	-	-	1	-	44.00	-
		FL20 US26D	713	-	-	1	-	64.50	-
FL32 Filler Bar 32" Length	Aluminum	FL32 US28	628	-	-	1	-	16.40	-
		FL32 315AN	711	-	-	1	-	46.60	-
		FL32 US26D	713	-	-	1	-	69.90	-
FL44 Filler Bar 44" Length	Aluminum	FL44 US28	628	-	-	1	-	20.60	-
		FL44 315AN	711	-	-	1	-	50.60	-
		FL44 US26D	713	-	-	1	-	82.20	-
MB1 Mounting Bracket Stop Widths Over 2-1/2"	Aluminum	MB1 USP	600	-	-	1	-	19.60	-
		MB1 SP28	689	-	-	1	-	28.00	-
		MB1 SPBLK	622	-	-	1	-	28.00	-
MB1F & MB1V Mounting Bracket Stop Widths 1-1/2" - 2-1/4"	Steel	MB1F USP	600	-	-	1	-	50.60	-
		MB1F SP28	689	-	-	1	-	50.60	-
		MB1F SPBLK	622	-	-	1	-	50.60	-
		MB1V USP	600	-	-	1	-	80.50	-
		MB1V SP28	689	-	-	1	-	80.50	-
		MB1V SPBLK	622	-	-	1	-	80.50	-
MB2 Mounting Bracket Stop Widths Up to 2-1/2"	Aluminum	MB2 USP	600	-	-	1	-	23.10	-
		MB2 SP28	689	-	-	1	-	31.60	-
		MB2 SPBLK	622	-	-	1	-	31.60	-
MB2F & MB2V Mounting Bracket Stop Widths 2-7/8" - 3-1/4"	Steel	MB2F USP	600	-	-	1	-	50.40	-
		MB2F SP28	689	-	-	1	-	50.40	-
		MB2F SPBLK	622	-	-	1	-	50.40	-
		MB2V USP	600	-	-	1	-	80.60	-
		MB2V SP28	689	-	-	1	-	80.60	-
		MB2V SPBLK	622	-	-	1	-	80.60	-
MB3F & MB3V Mounting Bracket Stop Widths Over 3-3/8"	Steel	MB3F USP	600	-	-	1	-	50.40	-
		MB3F SP28	689	-	-	1	-	50.40	-
		MB3F SPBLK	622	-	-	1	-	50.40	-
		MB3V USP	600	-	-	1	-	80.60	-
		MB3V SP28	689	-	-	1	-	80.60	-
		MB3V SPBLK	622	-	-	1	-	80.60	-

* Special factory preparation for use with vertical rod exit devices available. **List Add \$122.00.** Bold pricing indicates item is in stock and available for **Fast Track** and **ProXpress**

MODEL	SUBSTRATE	MODEL NUMBER	BHMA FINISH	WEIGHT	MUST BE ORDERED IN MULTIPLE QTY	MULTIPLE QTY	PACKED PER BOX	LIST PRICE	
								EACH	PACKAGE
FB32 Automatic Flush Bolts, Metal Doors UL 3 Hour Top Bolt w/Auxiliary Fire Latch 	Brass	FB32-12-MD US3	605	-	-	1	-	\$182.10	-
		FB32-12-MD US4	606	-	-	1	-	182.10	-
		FB32-12-MD US10	612	-	-	1	-	182.10	-
		FB32-12-MD US10B	613	-	-	1	-	182.10	-
	Stainless	FB32-12-MD US32	629	-	-	1	-	182.10	-
		FB32-12-MD US32D	630	-	-	1	-	182.10	-
COR32 Door Coordinator	See page 31								
FL32 Filler Bar	See page 32								
RL32 Nylon Roller 		RL32 US3	605	-	-	1	-	91.50	-
		RL32 US4	606	-	-	1	-	86.40	-
		RL32 US10	612	-	-	1	-	89.80	-
		RL32 US10B	613	-	-	1	-	95.00	-
		RL32 US26	625	-	-	1	-	91.50	-
		RL32 US26D	626	-	-	1	-	86.40	-
RL32A Nylon Roller w/ASA Strike 	Brass	RL32-A US3	605	-	-	1	-	99.50	-
		RL32-A US4	606	-	-	1	-	94.60	-
		RL32-A US10	612	-	-	1	-	98.30	-
		RL32-A US10B	613	-	-	1	-	103.50	-
		RL32-A US26	625	-	-	1	-	99.50	-
		RL32-A US26D	626	-	-	1	-	94.60	-
FB33 Top Auto Flush Bolt w/Auxiliary Fire Latch Retrofit Plate 	Brass	FB33-12-MD US3	605	-	-	1	-	188.10	-
		FB33-12-MD US4	606	-	-	1	-	188.10	-
		FB33-12-MD US10	612	-	-	1	-	188.10	-
		FB33-12-MD US10B	613	-	-	1	-	188.10	-
	Stainless	FB33-12-MD US32	629	-	-	1	-	188.10	-
		FB33-12-MD US32D	630	-	-	1	-	188.10	-
WS33 Wall Stop For Drywall Mounting	Brass	WS33 US26D	626	-	-	1	-	49.70	-
WS33X Wall Stop For Masonary Mounting	Brass	WS33X US26D	626	-	-	1	-	53.00	-
RL36/36A Roller Latch Mortise	Stainless	RL36 US32D	630	-	-	1	-	48.70	-
		RL36-A US32D	630	-	-	1	-	57.20	-
RL38 Roller Latch Surface Mount	Stainless	RL38 US32D	630	-	-	1	-	46.00	-
40 Decorative Light Duty Surface Bolt Packed with Universal and Mortise Strike 	Brass	40B3 3 IN	605	1.9	-	1	10	15.90	-
		40B5 3 IN	609	1.9	-	1	10	15.90	-
		40B10B 3 IN	613	1.9	-	1	10	16.60	-
		40B15 3 IN	619	1.9	-	1	10	15.90	-
		40B26 3 IN	625	1.9	-	1	10	16.60	-
		40B26D 3 IN	626	1.9	-	1	10	16.60	-
		40B3 4 IN	605	2.4	-	1	10	16.60	-
		40B5 4 IN	609	2.4	-	1	10	16.70	-
		40B10B 4 IN	613	2.4	-	1	10	17.50	-
		40B15 4 IN	619	2.4	-	1	10	16.70	-
		40B26 4 IN	625	2.4	-	1	10	17.50	-
		40B26D 4 IN	626	2.4	-	1	10	17.50	-

Bold pricing indicates item is in stock and available for **Fast Track** and **ProXpress**

HINGES

CONTINUOUS HINGES

PIVOTS

Numerical
1-059

Numerical
59-437

Numerical
438-1021

Numerical
1152-8190

Numerical
8200-9340

HINGES

CONTINUOUS HINGES

PIVOTS





Numerical 1-059

Numerical 59-437





Numerical 438-1021

Numerical 1152-8190

Numerical 8200-9340

MODEL	SUBSTRATE	MODEL NUMBER	BHMA FINISH	WEIGHT	MUST BE ORDERED IN MULTIPLE QTY	MULTIPLE QTY	PACKED PER BOX	LIST PRICE	
								EACH	PACKAGE
Continued from previous page. 40 Decorative Light Duty Surface Bolt Packed with Universal and Mortise Strike	Brass	40B3 6 IN	605	3.5	-	1	10	\$19.60	-
		40B5 6 IN	609	3.5	-	1	10	19.60	-
		40B10B 6 IN	613	3.5	-	1	10	20.40	-
		40B15 6 IN	619	3.5	-	1	10	19.60	-
		40B26 6 IN	625	3.5	-	1	10	20.40	-
		40B26D 6 IN	626	3.5	-	1	10	20.40	-
FS40 Auto Floor Type Holder Floor Clearance 1/2" or less 	Brass	FS40 US3	605	-	-	1	-	78.20	-
		FS40 US4	606	-	-	1	-	58.40	-
		FS40 US10	612	-	-	1	-	78.20	-
		FS40 US10B	613	-	-	1	-	78.20	-
		FS40 US26	625	-	-	1	-	78.20	-
		FS40 US26D	626	-	-	1	-	58.40	-
WS40 Automatic Wall Stop and Holder 	Brass	WS40 US3	605	-	-	1	-	104.90	-
		WS40 US4	606	-	-	1	-	104.90	-
		WS40 US10	612	-	-	1	-	104.90	-
		WS40 US10B	613	-	-	1	-	104.90	-
		WS40 US26	625	-	-	1	-	104.90	-
		WS40 US26D	626	-	-	1	-	98.50	-
FB41 Automatic Flush Bolt Wood Door Top and Bottom Bolt UL Listed 90 Minutes P=Pair T=Top Bolt Only B=Bottom Bolt Only 	Brass	FB41P-WD US3	605	-	-	1	-	190.40	-
		FB41P-WD US4	606	-	-	1	-	190.40	-
		FB41P-WD US10	612	-	-	1	-	190.40	-
		FB41P-WD US10B	613	-	-	1	-	190.40	-
	Stainless	FB41P-WD US32	629	-	-	1	-	190.40	-
		FB41P-WD US32D	630	-	-	1	-	190.40	-
	Brass	FB41T-WD US3	605	-	-	1	-	99.60	-
		FB41T-WD US4	606	-	-	1	-	99.60	-
		FB41T-WD US10	612	-	-	1	-	99.60	-
		FB41T-WD US10B	613	-	-	1	-	99.60	-
	Stainless	FB41T-WD US32	629	-	-	1	-	99.60	-
		FB41T-WD US32D	630	-	-	1	-	99.60	-
	Brass	FB41B-WD US3	605	-	-	1	-	99.60	-
		FB41B-WD US4	606	-	-	1	-	99.60	-
FB41B-WD US10		612	-	-	1	-	99.60	-	
FB41B-WD US10B		613	-	-	1	-	99.60	-	
Stainless	FB41B-WD US32	629	-	-	1	-	99.60	-	
	FB41B-WD US32D	630	-	-	1	-	99.60	-	
FS41 Automatic Floor Type Holder Floor Clearance 9/16" to 1-1/16"	Brass	FS41 US3	605	-	-	1	-	81.30	-
		FS41 US4	606	-	-	1	-	61.90	-
		FS41 US10	612	-	-	1	-	81.30	-
		FS41 US10B	613	-	-	1	-	81.30	-
		FS41 US26	625	-	-	1	-	81.30	-
		FS41 US26D	626	-	-	1	-	61.90	-
42 Pocket Door Bolt 	Brass	42B3	605	0.9	-	1	10	13.10	-
		42B4	606	0.9	-	1	10	13.10	-
		42B5	609	0.9	-	1	10	14.60	-
		42B10	612	0.9	-	1	10	15.20	-
		42B10B	613	0.9	-	1	10	15.20	-
		42B15	619	0.9	-	1	10	14.60	-
		42B26	625	0.9	-	1	10	15.20	-
		42B26D	626	0.9	-	1	10	15.20	-
COR42 Door Coordinator	See page 31								



Bold pricing indicates item is in stock and available for **Fast Track** and **ProXpress**

MODEL	SUBSTRATE	MODEL NUMBER	BHMA FINISH	WEIGHT	MUST BE ORDERED IN MULTIPLE QTY	MULTIPLE QTY	PACKED PER BOX	LIST PRICE	
								EACH	PACKAGE
FB42 Automatic Flush Bolt Wood Door UL 20 Minutes Top Bolt w/ Auxiliary Fire Latch	Brass	FB42-WD US3	605	-	-	1	-	\$192.20	-
		FB42-WD US4	606	-	-	1	-	192.20	-
		FB42-WD US10	612	-	-	1	-	192.20	-
		FB42-WD US10B	613	-	-	1	-	192.20	-
	Stainless	FB42-WD US32	629	-	-	1	-	192.20	-
		FB42-WD US32D	630	-	-	1	-	192.20	-
FS42 Automatic Floor Type Holder Floor Clearance 1-1/8" to 1-9/16"	Brass	FS42 US3	605	-	-	1	-	97.90	-
		FS42 US4	606	-	-	1	-	78.20	-
		FS42 US10	612	-	-	1	-	97.90	-
		FS42 US10B	613	-	-	1	-	97.90	-
		FS42 US26	625	-	-	1	-	97.90	-
		FS42 US26D	626	-	-	1	-	78.20	-
FS43 Automatic Floor Type Holder Floor Clearance 1-5/8" to 2-11/16"	Brass	FS43 US3	605	-	-	1	-	107.70	-
		FS43 US4	606	-	-	1	-	88.20	-
		FS43 US10	612	-	-	1	-	107.70	-
		FS43 US10B	613	-	-	1	-	107.70	-
		FS43 US26	625	-	-	1	-	107.70	-
		FS43 US26D	626	-	-	1	-	88.20	-
FL44 Filler Bar	See page 32								
WS45 Automatic Wall Holder For Drywall Mounting 	Brass	WS45 US3	605	-	-	1	-	140.50	-
		WS45 US4	606	-	-	1	-	140.50	-
		WS45 US10	612	-	-	1	-	140.50	-
		WS45 US10B	613	-	-	1	-	140.50	-
		WS45 US26	625	-	-	1	-	140.50	-
		WS45 US26D	626	-	-	1	-	137.10	-
	Aluminum	WS45 US28	628	-	-	1	-	110.60	-
WS45X Automatic Wall Holder For Masonry Mounting 	Brass	WS45X US3	605	-	-	1	-	148.60	-
		WS45X US4	606	-	-	1	-	148.60	-
		WS45X US10	612	-	-	1	-	148.60	-
		WS45X US10B	613	-	-	1	-	148.60	-
		WS45X US26	625	-	-	1	-	148.60	-
		WS45X US26D	626	-	-	1	-	145.10	-
	Aluminum	WS45X US28	628	-	-	1	-	118.60	-
S48 Mortise Bolt 	Brass	S48B3	605	2.6	-	1	10	17.60	-
		S48B5	609	2.6	-	1	10	21.10	-
		S48B10B	613	2.6	-	1	10	20.40	-
		S48B15	619	2.6	-	1	10	19.60	-
		S48B26	625	2.6	-	1	10	20.40	-
		S48B26D	626	2.6	-	1	10	20.40	-
S48 Strike Package		09-40-605	605	-	-	1	-	5.00	-
		09-40-613	613	-	-	1	-	5.00	-
		09-40-626	626	-	-	1	-	5.00	-
FB51 UL 3 Hour Constant Latching Top and Automatic Bottom Bolt, Metal Door P=Pair T=Top Bolt Only B=Bottom Bolt Only Optional Rod Lengths Available 18", 24", 36", 48" 11.10 List Add 	Brass	FB51P-12-MD US3	605	-	-	1	-	182.10	-
		FB51P-12-MD US4	606	-	-	1	-	182.10	-
		FB51P-12-MD US10	612	-	-	1	-	182.10	-
		FB51P-12-MD US10B	613	-	-	1	-	182.10	-
	Stainless	FB51P-12-MD US32	629	-	-	1	-	182.10	-
		FB51P-12-MD US32D	630	-	-	1	-	182.10	-
	Brass	FB51T-12-MD US3	605	-	-	1	-	95.00	-
		FB51T-12-MD US4	606	-	-	1	-	95.00	-
		FB51T-12-MD US10	612	-	-	1	-	95.00	-
		FB51T-12-MD US10B	613	-	-	1	-	95.00	-
	Stainless	FB51T-12-MD US32	629	-	-	1	-	95.00	-
		FB51T-12-MD US32D	630	-	-	1	-	95.00	-
COR52 Door Coordinator	See page 32								



Bold pricing indicates item is in stock and available for **Fast Track** and **ProXpress**

HINGES
 CONTINUOUS HINGES
 PIVOTS
 Numerical 1-059
 Numerical 59-437
 Numerical 438-1021
 Numerical 1152-8190
 Numerical 8200-9340

HINGES
 CONTINUOUS HINGES
 PIVOTS
 Numerical 1-059
 Numerical 59-437
 Numerical 438-1021
 Numerical 1152-8190
 Numerical 8200-9340

MODEL	SUBSTRATE	MODEL NUMBER	BHMA FINISH	WEIGHT	MUST BE ORDERED IN MULTIPLE QTY	MULTIPLE QTY	PACKED PER BOX	LIST PRICE	
								EACH	PACKAGE
FB52 Flush Bolt UL 3 Hour Constant Latching Top w/ Auxiliary Fire Latch	Brass	FB52-12-MD US3	605	-	-	1	-	\$182.10	-
		FB52-12-MD US4	606	-	-	1	-	182.10	-
		FB52-12-MD US10	612	-	-	1	-	182.10	-
		FB52-12-MD US10B	613	-	-	1	-	182.10	-
	Stainless	FB52-12-MD US32	629	-	-	1	-	182.10	-
		FB52-12-MD US32D	630	-	-	1	-	182.10	-
FB53 UL 3 Hour Constant Latching Top w/ Auxiliary Fire Latch and Retrofit Plate	Brass	FB53-12-MD US3	605	-	-	1	-	188.10	-
		FB53-12-MD US4	606	-	-	1	-	188.10	-
		FB53-12-MD US10	612	-	-	1	-	188.10	-
		FB53-12-MD US10B	613	-	-	1	-	188.10	-
	Stainless	FB53-12-MD US32	629	-	-	1	-	188.10	-
		FB53-12-MD US32D	630	-	-	1	-	188.10	-
054 Dutch Door Bolt 	Brass	054B3	605	2.3	-	1	5	46.00	-
		054B4	606	2.3	-	1	5	46.00	-
		054B10	612	2.3	-	1	5	41.90	-
		054B10B	613	2.3	-	1	5	50.40	-
		054B15	619	2.3	-	1	5	52.20	-
		054B26	625	2.3	-	1	5	50.40	-
		054B26D	626	2.3	-	1	5	46.00	-
059 Handrail Bracket 	Aluminum	059A3	666	3.2	-	1	20	3.40	-
		059A5	-	3.2	-	1	20	3.40	-
		059A10	668	3.2	-	1	20	3.40	-
		059A10B	703	3.2	-	1	20	3.40	-
		059A14	669	3.2	-	1	20	3.40	-
		059A15	670	3.2	-	1	20	3.40	-
		059A92	673	3.2	-	1	20	3.40	-
		059A-716	716	3.2	-	1	20	3.40	-
		059A-BLK	-	3.3	-	1	20	4.60	-
		059A-W	-	3.3	-	1	20	4.60	-
		SP059A3	666	68.0	Yes	20	20		\$70.00
		SP059A5	-	68.0	Yes	20	20		70.00
		SP059A14	669	68.0	Yes	20	20		70.00
		SP059A92	673	68.0	Yes	20	20		70.00
	Brass	059B3	605	3.2	-	1	10	19.90	-
		059B5	609	3.2	-	1	10	27.50	-
		059B10B	613	3.2	-	1	10	22.70	-
		059B15	619	3.2	-	1	10	22.70	-
		059B15A	620	3.2	-	1	10	22.70	-
		059B19	622	3.2	-	1	10	22.70	-
		059B26	625	3.2	-	1	10	27.50	-
		059B26D	626	3.2	-	1	10	27.50	-
		059B-716	-	3.2	-	1	10	22.70	-
		SC059B-716	-	-	Yes	5	5	-	117.20
SP059B10B		613	37.0	Yes	10	10	-	234.50	
SP059B26		625	37.0	Yes	10	10	-	280.50	
SPS059B-605		605	-	Yes	10	10	-	203.40	
SPS059B-619		619	-	Yes	10	10	-	234.50	
SPS059B-620	620	-	Yes	10	10	-	234.50		
SPS059B-716	-	-	Yes	10	10	-	234.50		
Zinc **	059Z-619E	-	-	-	1	20	5.30	-	

Bold pricing indicates item is in stock and available for **Fast Track** and **ProXpress**

MODEL	SUBSTRATE	MODEL NUMBER	BHMA FINISH	WEIGHT	MUST BE ORDERED IN MULTIPLE QTY	MULTIPLE QTY	PACKED PER BOX	LIST PRICE			
								EACH	PACKAGE		
59 Handrail Bracket 	Aluminum	59A3	666	1.6	-	1	10	\$3.50	-		
		59A5	-	2.1	-	1	10	4.50	-		
		59A10B	703	3.2	-	1	10	6.10	-		
		59A14	669	2.1	-	1	10	4.50	-		
		59A15	670	2.0	-	1	10	4.50	-		
		59A92	673	3.2	-	1	10	3.50	-		
		59A-716	-	2.0	-	1	10	4.50	-		
		SP59A3	666	45.0	Yes	15	15	-	\$54.30		
		SP59A5	-	45.0	Yes	15	15	-	65.50		
		SP59A14	669	45.0	Yes	15	15	-	65.50		
		SP59A92	673	45.0	Yes	15	15	-	54.30		
	Brass	59B3	605	3.8	-	1	10	20.90	-		
		59B5	609	3.8	-	1	10	24.00	-		
		59B15	619	3.8	-	1	10	24.00	-		
		59B26	625	3.8	-	1	10	24.00	-		
		59B26D	626	3.8	-	1	10	24.00	-		
59B-716		-	3.8	-	1	10	24.00	-			
SP59B3		605	41.0	Yes	10	10	-	209.10			
060 Flexible Door Stop 3" Projection 	Steel	060F3	632	1.1	-	1	20	1.10	-		
		060F5	638	1.1	-	1	20	1.10	-		
		060F10	639	1.1	-	1	20	1.10	-		
		060F10B	640	1.1	-	1	20	1.10	-		
		060F14	645	1.1	-	1	20	1.10	-		
		060F15	646	1.1	-	1	20	1.10	-		
		060F26D	652	1.1	-	1	20	1.10	-		
		SP060F3	632	145.0	Yes	50	50	-	56.20		
		SP060F5	638	145.0	Yes	50	50	-	56.20		
		SP060F10B	640	145.0	Yes	50	50	-	56.20		
		SP060F14	645	145.0	Yes	50	50	-	56.20		
		SRT (WSPART.1076)	9	-	Yes	100	100	-	37.10		
60 Door Stop 3-3/4" Projection 	Aluminum	60A3	666	1.5	-	1	20	3.30	-		
		60A10B	703	1.5	-	1	20	4.60	-		
		60A14	669	1.5	-	1	20	3.30	-		
		60A92	673	1.5	-	1	20	3.30	-		
	Brass	60B3	605	1.9	-	1	10	11.90	-		
		60B4	606	1.9	-	1	10	11.90	-		
		60B5	609	1.9	-	1	10	11.90	-		
		60B10	612	1.9	-	1	10	15.60	-		
		60B10B	613	1.9	-	1	10	15.60	-		
		60B15	619	1.9	-	1	10	15.60	-		
		60B26	625	1.9	-	1	10	15.60	-		
		60B26D	626	1.9	-	1	10	15.60	-		
		60 Rubber Tips		RT (WSPART.1075)	-	-	Yes	100	100	-	79.50
		COR60 Door Coordinator		See page 32							

HINGES

CONTINUOUS HINGES

PIVOTS

Numerical 1-059

Numerical 59-437

Numerical 438-1021

Numerical 1152-8190

Numerical 8200-9340

Bold pricing indicates item is in stock and available for **Fast Track** and **ProXpress**

HINGES

CONTINUOUS HINGES

PIVOTS



Numerical 1-059

Numerical 59-437

Numerical 438-1021







Numerical 1152-8190

Numerical 8200-9340

MODEL	SUBSTRATE	MODEL NUMBER	BHMA FINISH	WEIGHT	MUST BE ORDERED IN MULTIPLE QTY	MULTIPLE QTY	PACKED PER BOX	LIST PRICE	
								EACH	PACKAGE
061 Flexible Door Stop 4" Projection 	Steel	061F3	632	1.4	-	1	20	\$1.20	-
		061F5	638	1.4	-	1	20	1.20	-
		061F10	639	1.4	-	1	20	1.20	-
		061F10B	640	1.4	-	1	20	1.20	-
		061F14	645	1.4	-	1	20	1.20	-
		061F26D	652	1.4	-	1	20	1.20	-
		061F-W	-	1.4	-	1	20	1.20	-
		SP061F3	632	47.5	Yes	25	25	-	\$30.80
		SP061F5	638	47.5	Yes	25	25	-	30.80
SP061F14	645	47.5	Yes	25	25	-	30.80		
Rubber Tip - Flexible Stops	Rubber	SRT (WSPART.1076)	-	-	Yes	100	100	-	37.10
61 Solid Door Stop 3-3/16" Projection  *Provided with Black Rubber Tip	Aluminum	61A3	666	1.2	-	1	20	3.30	-
		61A5	-	1.2	-	1	20	3.30	-
		61A10	668	1.2	-	1	20	3.30	-
		61A10B	703	1.2	-	1	20	3.30	-
		61A14	669	1.2	-	1	20	3.30	-
		61A15	670	1.2	-	1	20	3.30	-
		61A19	-	1.2	-	1	20	3.30	-
		61A92	673	1.2	-	1	20	3.30	-
		61A-716*	-	1.2	-	1	20	3.30	-
		61A-BLK	-	1.3	-	1	20	3.60	-
		61A-W	-	1.3	-	1	20	3.60	-
		SP61A10B	703	42.5	Yes	25	25	-	86.90
		SP61A3	666	42.5	Yes	25	25	-	86.90
		SP61A5	-	42.5	Yes	25	25	-	86.90
		SP61A14	669	42.5	Yes	25	25	-	86.90
		SP61A92	673	42.5	Yes	25	25	-	86.90
		SP61A-BLK	-	20.0	Yes	10	10	-	37.00
SP61A-W	-	50.0	Yes	25	25	-	92.50		
61 Solid Door Stop 3-1/8" Projection 	Brass	61B3	605	1.4	-	1	10	11.90	-
		61B4	606	1.4	-	1	10	11.90	-
		61B5	609	1.4	-	1	10	11.90	-
		61B10	612	1.4	-	1	10	15.60	-
		61B10B	613	1.4	-	1	10	15.60	-
		61B15	619	1.4	-	1	10	15.60	-
		61B15A	620	1.4	-	1	10	15.60	-
		61B19	622	1.4	-	1	10	15.60	-
		61B26	625	1.4	-	1	10	15.60	-
		61B26D	626	1.4	-	1	10	11.90	-
		SC61B-605	605	-	Yes	5	5	-	60.00
		SC61B-609	609	-	Yes	5	5	-	60.00
		SC61B-619	619	-	Yes	5	5	-	80.80
		SC61B-716	716	-	Yes	5	5	-	80.80
		SP61B 10B	613	-	Yes	10	10	-	161.50
		SP61B26 (WS.10347)	625	-	Yes	10	10	-	161.50
		SPS61B-605	605	-	Yes	20	20	-	240.00
		SPS61B-609	609	-	Yes	20	20	-	240.00
		SPS61B-619	619	-	Yes	20	20	-	323.00
		SPS61B-620	620	-	Yes	20	20	-	323.00
SPS61B-716	-	-	Yes	20	20	-	323.00		

Continued on next page.

Bold pricing indicates item is in stock and available for **Fast Track** and **ProXpress**

MODEL	SUBSTRATE	MODEL NUMBER	BHMA FINISH	WEIGHT	MUST BE ORDERED IN MULTIPLE QTY	MULTIPLE QTY	PACKED PER BOX	LIST PRICE		
								EACH	PACKAGE	
61 Solid Door Stop 3-3/16" Projection <i>Continued from previous page</i>	Zinc	61Z-619E	-	4.1	-	1	20	\$3.10	-	
		61Z-716E	-	-	-	1	20	4.00	-	
		SC61Z-605E	677	-	-	Yes	5	5	-	\$17.90
		SC61Z-619E	-	-	-	Yes	5	5	-	21.80
61 Rubber Tips		RT (WSPART.1075)	-	-	Yes	100	100	-	79.50	
FB61 Flush Bolt for Wood Door UL 90 Minute Constant Latching Top and Automatic Bottom Bolt P=Pair (Top half w/automatic bottom bolt) T=Top Bolt Only 	Brass	FB61P-WD US3	605	-	-	1	-	192.20	-	
		FB61P-WD US4	606	-	-	-	1	-	192.20	-
		FB61P-WD US10	612	-	-	-	1	-	192.20	-
		FB61P-WD US10B	613	-	-	-	1	-	192.20	-
	Stainless	FB61P-WD US32	629	-	-	-	1	-	192.20	-
		FB61P-WD US32D	630	-	-	-	1	-	192.20	-
	Brass	FB61T-WD US3	605	-	-	-	1	-	99.60	-
		FB61T-WD US4	606	-	-	-	1	-	99.60	-
		FB61T-WD US10	612	-	-	-	1	-	99.60	-
		FB61T-WD US10B	613	-	-	-	1	-	99.60	-
	Stainless	FB61T-WD US32	629	-	-	-	1	-	99.60	-
		FB61T-WD US32D	630	-	-	-	1	-	99.60	-
FB62 Flush Bolt for Wood Door UL 20 Minute Constant Latching Top w/Auxiliary Fire Latch	Brass	FB62-WD US3	605	-	-	1	-	192.20	-	
		FB62-WD US4	606	-	-	-	1	-	192.20	-
		FB62-WD US10	612	-	-	-	1	-	192.20	-
		FB62-WD US10B	613	-	-	-	1	-	192.20	-
	Stainless	FB62-WD US32	629	-	-	-	1	-	192.20	-
		FB62-WD US32D	630	-	-	-	1	-	192.20	-
63 Flexible Door Stop 	Steel	63F-605E	632	2.7	-	1	20	1.00	-	
		63F-609E	638	2.7	-	1	20	1.00	-	
		63F-619E	646	1.8	-	1	20	1.00	-	
		63F-716E	-	1.8	-	1	20	1.00	-	
		63F-W	-	1.8	-	1	20	1.00	-	
63 Rubber Tips		RT (WSPART.1075)	-	-	Yes	100	100	-	79.50	
64 Door Stop 3-1/4" Projection 	Aluminum	64A3	666	2.3	-	1	20	2.80	-	
		64A10B	703	2.3	-	1	20	2.80	-	
		64A92	673	2.3	-	1	20	2.80	-	
	Brass	64B3	605	-	-	-	1	10	10.60	-
		64B4	606	-	-	-	1	10	11.60	-
		64B5	609	2.1	-	-	1	10	13.70	-
		64B10	612	2.3	-	-	1	10	13.70	-
		64B10B	613	2.3	-	-	1	10	13.70	-
		64B15	619	2.3	-	-	1	10	13.70	-
		64B26	625	2.3	-	-	1	10	13.70	-
64B26D	626	2.3	-	-	1	10	13.70	-		
64 Rubber Tips		RT (WSPART.1075)	-	-	Yes	100	100	-	79.50	
SR64 Door Silencer - Hollow Metal 		SR64 GRY (100/pk)	-	2.1	-	1	100	31.10	-	
		SR64 GRY - BULK (2500/pk)	-	-	-	1	2,500	471.40	-	
WS65 Wall Stop 	Aluminum	WS65 US3AL	666	2.8	-	1	20	4.50	-	
		WS65 US10AL	668	2.1	-	1	20	4.50	-	
		WS65 US10B-AL	703	2.8	-	1	20	4.50	-	
		WS65 US27	673	-	-	-	1	20	4.50	-
		SPWS65 US3AL	666	-	-	Yes	25	25	-	110.60
		SPWS65 US27	673	-	-	Yes	25	25	-	110.60
WS65 Rubber Tips		RT (WSPART.1075)	-	-	Yes	100	100	-	79.50	
SR65 Door Silencer - Wood 		SR65 GRY (100/pk)	-	-	-	1	100	31.10	-	
SR66 Door Silencer - Adhesive 		SR66 BRN (100/pk)	-	-	-	1	100	31.10	-	
		SR66 GRY (100/pk)	-	-	-	1	100	31.10	-	
		SR66 WHT (100/pk)	-	-	-	1	100	31.10	-	

Bold pricing indicates item is in stock and available for **Fast Track** and **ProXpress**





HINGES
 CONTINUOUS HINGES
 PIVOTS
 Numerical 1-059
 Numerical 59-437
 Numerical 438-1021
 Numerical 1152-8190
 Numerical 8200-9340

HINGES

CONTINUOUS
HINGES







PIVOTS

Numerical
1-059Numerical
59-437Numerical
438-1021Numerical
1152-8190Numerical
8200-9340

MODEL	SUBSTRATE	MODEL NUMBER	BHMA FINISH	WEIGHT	MUST BE ORDERED IN MULTIPLE QTY	MULTIPLE QTY	PACKED PER BOX	LIST PRICE	
								EACH	PACKAGE
066 Casement Fastener 	Aluminum	066A3 RS MS SS	666	-	-	1	10	\$6.30	-
		066A5 RS MS SS	-	-	-	1	10	6.30	-
		066A10B RS MS SS	703	-	-	1	10	6.30	-
		066A14 RS MS SS	669	-	-	1	10	6.30	-
		066A92 RS MS SS	673	-	-	1	10	6.30	-
	Brass	066B3 RS MS SS	605	-	-	1	10	27.80	-
		066B5 RS MS SS	609	-	-	1	10	33.40	-
		066B15 RS MS SS	619	-	-	1	10	34.70	-
		066B26 RS MS SS	625	-	-	1	10	33.40	-
		066B26D RS MS SS	626	-	-	1	10	33.40	-
66 Casement Fastener 	Aluminum	66A3 RS MS SS	666	-	-	1	10	7.30	-
		66A5 RS MS SS	-	-	-	1	10	7.30	-
		66A14 RS MS SS	669	-	-	1	10	7.30	-
		66A92 RS MS SS	673	-	-	1	10	7.30	-
	Brass	66B3 RS MS SS	605	-	-	1	10	33.90	-
		66B5 RS MS SS	609	-	-	1	10	33.90	-
		66B15 RS MS SS	619	-	-	1	10	33.90	-
		66B26 RS MS SS	625	-	-	1	10	33.90	-
		66B26D RS MS SS	626	-	-	1	10	33.90	-
		66B716 RS MS SS	-	-	-	1	10	33.90	-
69 Hinge Pin Door Stop Door Opening Adjustments 70° - 100° 	Steel	69F3	632	2.6	-	1	20	4.20	-
		69F5	638	2.6	-	1	20	4.20	-
		69F10	639	2.6	-	1	20	4.20	-
		69F10B	640	2.6	-	1	20	4.20	-
		69F14	645	2.6	-	1	20	4.20	-
		69F15	646	2.6	-	1	20	4.20	-
		69F15A	647	2.6	-	1	20	4.20	-
		69F26	651	2.6	-	1	20	4.20	-
		69F26D	652	2.6	-	1	20	4.20	-
		SP69F3	632	82.5	Yes	25	25	-	\$103.80
		SP69F5	635	82.5	Yes	25	25	-	103.80
	SP69F14	645	82.5	Yes	25	25	-	103.80	
69 Rubber Tip		09-310	-	-	-	1	1	74.20	-
70 Hinge Pin Door Stop Door Opening Adjustments 85° - 125°  *Provided with Black Rubber Tip Picture above for Brass and Zinc Substrates  Picture above for Aluminum Substrates	Aluminum	70A3	666	1.3	-	1	20	2.20	-
		70A4	667	1.3	-	1	20	2.20	-
		70A5	-	1.3	-	1	20	2.50	-
		70A10	668	1.3	-	1	20	2.20	-
		70A10B	703	1.3	-	1	20	2.50	-
		70A14	669	1.3	-	1	20	2.50	-
		70A15	670	1.3	-	1	20	2.50	-
		70A92	673	1.3	-	1	20	2.20	-
		70A-716*	-	1.3	-	1	20	2.50	-
		70A-BLK	-	1.4	-	1	20	3.10	-
		70A-W	-	1.4	-	1	20	3.10	-
		SP70A3	666	55.0	Yes	25	25	-	56.20
		SP70A5	-	55.0	Yes	25	25	-	64.60
		SP70A10	668	55.0	Yes	25	25	-	56.20
	SP70A92	673	55.0	Yes	25	25	-	56.20	
	Brass	70B3	605	1.4	-	1	10	11.00	-
		70B4	606	1.4	-	1	10	11.00	-
		70B5	609	1.4	-	1	10	13.90	-
		70B10	612	1.4	-	1	10	13.90	-
		70B10B	613	1.4	-	1	10	13.90	-
70B15		619	1.4	-	1	10	13.90	-	
70B19		622	1.4	-	1	10	13.90	-	
70B26	625	1.4	-	1	10	13.90	-		
70B26D	626	1.4	-	1	10	13.90	-		

Continued on next page.







Bold pricing indicates item is in stock and available for **Fast Track** and **ProXpress**

MODEL	SUBSTRATE	MODEL NUMBER	BHMA FINISH	WEIGHT	MUST BE ORDERED IN MULTIPLE QTY	MULTIPLE QTY	PACKED PER BOX	LIST PRICE	
								EACH	PACKAGE
70 Hinge Pin Door Stop Door Opening Adjustments 85° - 125°  <i>Continued from previous page.</i>	Brass	SC70B-605	605	-	Yes	5	5	-	\$57.20
		SC70B-619	619	-	Yes	5	5	-	70.60
		SC70B-620	620	-	Yes	5	5	-	70.60
		SC70B-716	-	-	Yes	5	5	-	70.60
		SPS70B-605	605	-	Yes	15	15	-	173.30
		SPS70B-619	619	-	Yes	15	15	-	212.00
		SPS70B-620	620	-	Yes	15	15	-	212.00
		SPS70B-716	-	-	Yes	15	15	-	212.00
	Zinc	70Z-406E	-	-	-	1	10	\$3.10	-
70Z-716E		-	-	-	1	20	3.10	-	
70 Rubber Tips		RT (WSPART.1075)	-	-	Yes	100	100	-	79.50
71 Casement Adjuster 	Brass	71B3 10 IN	605	1.7	-	1	2	66.60	-
		71B3 12 IN	605	1.9	-	1	2	72.40	-
		71B26 10 IN	625	1.7	-	1	2	66.60	-
		71B26 12 IN	625	1.9	-	1	2	72.40	-
72 Door Saver Residential 	Zinc	72Z-605E	677	-	-	1	50	2.50	-
		72Z-609E	-	-	-	1	50	2.50	-
		72Z-613E	704	-	-	1	50	2.50	-
		72Z-619E	-	-	-	1	50	2.50	-
		72Z-625E	-	-	-	1	50	2.50	-
		72Z-W	-	-	-	1	50	2.50	-
72 Rubber Tips		RT (WSPART.1075)	-	-	Yes	100	100	-	79.50
COR72 Door Coordinator	See page 32								
73 Door Saver Commercial 	Zinc	73Z-605E	677	-	-	1	25	5.00	-
		73Z-613E	704	-	-	1	25	5.00	-
		73Z-619E	-	-	-	1	25	5.00	-
		73Z-625E	-	-	-	1	25	5.00	-
73 Rubber Tips		RT (WSPART.1075)	-	-	Yes	100	100	-	79.50
90 Side Window Lock 	Aluminum	SP90A3	666	45.0	Yes	25	25	-	107.80
CS115 Crash Stop 	Steel	CS115 US10B 20 1/2 IN	613	5.0	-	1	5	46.10	-
		CS115 US10B 25 1/2 IN	613	5.5	-	1	5	49.10	-
		CS115 US10B 30 1/2 IN	613	6.0	-	1	5	54.50	-
		CS115 US26D 20 1/2 IN	626	5.0	-	1	5	46.10	-
		CS115 US26D 25 1/2 IN	626	5.5	-	1	5	49.10	-
CS115 US26D 30 1/2 IN	626	6.0	-	1	5	54.50	-		
HB159 Handrail Bracket 	Aluminum	HB159 US3AL	666	3.8	-	1	5	15.70	-
		HB159 US27	673	3.8	-	1	5	15.70	-

HINGES
 CONTINUOUS HINGES
 PIVOTS
 Numerical 1-059
 Numerical 59-437
 Numerical 438-1021
 Numerical 1152-8190
 Numerical 8200-9340





Bold pricing indicates item is in stock and available for **Fast Track** and **ProXpress**

HINGES
 CONTINUOUS HINGES
 PIVOTS
 Numerical 1-059
 Numerical 59-437
 Numerical 438-1021
 Numerical 1152-8190
 Numerical 8200-9340

MODEL	SUBSTRATE	MODEL NUMBER	BHMA FINISH	WEIGHT	MUST BE ORDERED IN MULTIPLE QTY	MULTIPLE QTY	PACKED PER BOX	LIST PRICE	
								EACH	PACKAGE
218* Finger Pull 1" Diameter 	Brass	218B3	605	1.6	Yes	4	40	-	\$9.80
		218B5	609	1.6	Yes	4	40	-	18.60
		218B10	612	1.6	Yes	4	40	-	18.60
		218B10B	613	1.6	Yes	4	40	-	18.60
		218B15	619	1.6	Yes	4	40	-	9.80
		218B26	625	1.6	Yes	4	40	-	13.10
		218B26D	626	1.6	Yes	4	40	-	13.10
221 Flush Pull 2-1/8" Diameter 	Brass	221B3	605	1.0	-	1	20	\$3.50	
		221B4	606	1.0	-	1	20	3.50	
		221B5	609	1.0	-	1	20	3.50	
		221B10	612	1.0	-	1	20	4.80	
		221B10B	613	1.0	-	1	20	4.20	
		221B15	619	1.0	-	1	20	4.00	
		221B26	625	1.0	-	1	20	4.20	
		221B26D	626	1.0	-	1	20	4.20	
		221B716	716	1.0	-	1	20	4.20	
		SPS221B-605	605	-	Yes	25	25	-	90.40
		SPS221B-609	609	-	Yes	25	25	-	116.70
		SPS221B-620	620	-	Yes	25	25	-	116.70
		222 Flush Pull 3-1/8" High x 1-5/8" Wide x 7/16" 	Brass	222B3	605	1.5	-	1	10
222B4	606			1.5	-	1	10	20.60	-
222B5	609			1.5	-	1	10	23.50	-
222B10	612			1.5	-	1	10	23.50	-
222B10B	613			1.5	-	1	10	23.50	-
222B15	619			1.5	-	1	10	22.70	-
222B26	625			1.5	-	1	10	23.50	-
222B26D	626			1.5	-	1	10	23.50	-
223 Flush Pull 3-9/16" High x 1-5/16" Wide x 1/2" Deep 	Brass	223B3	605	0.7	-	1	10	6.30	-
		223B4	606	0.7	-	1	10	6.30	-
		223B10	612	0.7	-	1	10	7.10	-
		223B10B	613	0.7	-	1	10	7.10	-
		223B15	619	0.7	-	1	10	6.80	-
		223B26	625	0.7	-	1	10	7.10	-
		223B26D	626	0.7	-	1	10	7.10	-
		227 Flush Pull 3-5/8" High x 1-3/4" Wide x 9/16" Deep 	Brass	227B3	605	1.0	-	1	10
227B4	606			1.0	-	1	10	9.40	-
227B5	609			1.0	-	1	10	10.40	-
227B10	612			1.0	-	1	10	10.90	-
227B10B	613			1.0	-	1	10	10.90	-
227B15	619			1.0	-	1	10	10.40	-
227B26	625			1.0	-	1	10	10.90	-
227B26D	626			1.0	-	1	10	10.90	-
230 Door Edge Pull 	Brass			230B3	605	1.3	-	1	10
		230B4	606	1.3	-	1	10	13.30	-
		230B5	609	1.3	-	1	10	14.60	-
		230B10	612	1.3	-	1	10	13.30	-
		230B10B	613	1.3	-	1	10	15.30	-
		230B15	619	1.3	-	1	10	14.60	-
		230B26	625	1.3	-	1	10	15.30	-
		230B26D	626	1.3	-	1	10	15.30	-

* NOTE: 218 Finger Pull priced at 4 per bag. Qty of 10 = 40 pieces.

Bold pricing indicates item is in stock and available for **Fast Track** and **ProXpress**

MODEL	SUBSTRATE	MODEL NUMBER	BHMA FINISH	WEIGHT	MUST BE ORDERED IN MULTIPLE QTY	MULTIPLE QTY	PACKED PER BOX	LIST PRICE		
								EACH	PACKAGE	
253 Decorative Heavy Duty Surface Bolt 	Brass	253B3 8 IN US MS	605	-	-	1	5	\$65.60	-	
		253B10B 8 IN US MS	613	-	-	1	5	75.50	-	
		253B26D 8 IN US MS	626	-	-	1	5	75.50	-	
		253B3 12 IN US MS	605	-	-	1	5	86.30	-	
		253B10B 12 IN US MS	613	-	-	1	5	92.20	-	
		253B26D 12 IN US MS	626	-	-	1	5	92.20	-	
253 Mortise Strike Package	Brass	09-22-605	605	-	-	1	1	8.20	-	
		09-22-613	613	-	-	1	1	8.20	-	
		09-22-626	626	-	-	1	1	8.20	-	
253 Angle Strike Package	Brass	09-33-605	605	-	-	1	1	18.20	-	
		09-33-613	613	-	-	1	1	18.20	-	
		09-33-626	626	-	-	1	1	18.20	-	
261 Manual Flush Bolt 	Brass	261B3	605	2.4	-	1	10	18.80	-	
		261B5	609	2.4	-	1	10	20.70	-	
		261B10B	613	2.4	-	1	10	23.70	-	
		261B15	619	2.4	-	1	10	21.50	-	
		261B26	625	2.4	-	1	10	21.50	-	
		261B26D	626	2.4	-	1	10	21.50	-	
		SP261B3	605	3.8	-	Yes	15	15	-	\$283.20
		SP261B15	619	0.0	-	Yes	15	15	-	322.60
262 Manual Flush Bolt 	Brass	262B3	605	3.6	-	1	10	27.50	-	
		262B5	609	3.6	-	1	10	30.30	-	
		262B10B	613	3.6	-	1	10	31.60	-	
		262B15	619	3.6	-	1	10	31.60	-	
		262B26	625	3.6	-	1	10	31.60	-	
		262B26D	626	3.6	-	1	10	31.60	-	
262 Strike Package		09-40-605	605	-	-	1	1	5.00	-	
		09-40-613	613	-	-	1	1	5.00	-	
		09-40-626	626	-	-	1	1	5.00	-	
265 Manual Flush Bolt 	Brass	265B3	605	2.1	-	1	10	21.40	-	
		265B5	609	2.1	-	1	10	23.50	-	
		265B10B	613	2.1	-	1	10	24.80	-	
		265B15	619	2.1	-	1	10	24.80	-	
		265B26	625	2.1	-	1	10	24.80	-	
		265B26D	626	2.1	-	1	10	24.80	-	
265 Strike Package		09-40-605	605	-	-	1	1	5.00	-	
		09-40-613	613	-	-	1	1	5.00	-	
		09-40-626	626	-	-	1	1	5.00	-	
299 Center Rescue Strike All Strikes Double Lip. Must be used with Center Hung Pivots. Strike Dimension Options: 7" Stk = 5 3/4" x 2 3/4" Frame 8" Stk = 6 3/4" x 2 3/4" Frame		299RS-7	630	-	-	1	-	48.30	-	
		299RS-8	630	-	-	1	-	48.30	-	
299 Offset Rescue Strike All Strikes Double Lip. Must be used with Center Hung Pivots. Strike Dimension Options: 7" Stk = 5 3/4" x 2 3/4" Frame 8" Stk = 6 3/4" x 2 3/4" Frame		299RB-7	630	-	-	1	-	48.30	-	
		299RB-8	630	-	-	1	-	48.30	-	
299 Rescue Emergency Stop Mortise All Strikes Double Lip. Must be used with Center Hung Pivots. Strike Dimension Options: 7" Stk = 5 3/4" x 2 3/4" Frame 8" Stk = 6 3/4" x 2 3/4" Frame		299AL	630	-	-	1	-	102.30	-	
299 Rescue Center Emergency Stop Strike (Part) All Strikes Double Lip. Must be used with Center Hung Pivots. Strike Dimension Options: 7" Stk = 5 3/4" x 2 3/4" Frame 8" Stk = 6 3/4" x 2 3/4" Frame		299ES-7	630	-	-	1	-	64.30	-	
		299ES-8	630	-	-	1	-	64.30	-	

Bold pricing indicates item is in stock and available for **Fast Track** and **ProXpress**

HINGES
 CONTINUOUS HINGES
 PIVOTS
 Numerical 1-059
 Numerical 59-437
 Numerical 438-1021
 Numerical 1152-8190
 Numerical 8200-9340

HINGES

CONTINUOUS HINGES

PIVOTS

Numerical 1-059

Numerical 59-437

Numerical 438-1021







Numerical 1152-8190

Numerical 8200-9340

MODEL	SUBSTRATE	MODEL NUMBER	BHMA FINISH	WEIGHT	MUST BE ORDERED IN MULTIPLE QTY	MULTIPLE QTY	PACKED PER BOX	LIST PRICE	
								EACH	PACKAGE
299 Rescue Offset Emergency Stop Strike (Part) All Strikes Double Lip. Must be used with Center Hung Pivots. Strike Dimension Options: 7" Stk = 5 3/4" x 2 3/4" Frame 8" Stk = 6 3/4" x 2 3/4" Frame		299EB-7	630	-	-	1	-	\$64.30	-
		299EB-8	630	-	-	1	-	64.30	-
299 Rescue Center Emergency Strike Assembly All Strikes Double Lip. Must be used with Center Hung Pivots. Strike Dimension Options: 7" Stk = 5 3/4" x 2 3/4" Frame 8" Stk = 6 3/4" x 2 3/4" Frame		299AS-7	630	-	-	1	-	166.60	-
		299AS-8	630	-	-	1	-	166.60	-
299 Rescue Offset Emergency Strike Assembly All Strikes Double Lip. Must be used with Center Hung Pivots. Strike Dimension Options: 7" Stk = 5 3/4" x 2 3/4" Frame 8" Stk = 6 3/4" x 2 3/4" Frame		299AB-7	630	-	-	1	-	166.60	-
		299AB-8	630	-	-	1	-	166.60	-
325 Magnetic Catch	Aluminum	325A3	666	1.9	-	1	20	2.90	-
		325A92	673	1.9	-	1	20	2.90	-
326 Heavy Duty Magnetic Catch	Aluminum	326A3	666	3.0	-	1	10	8.10	-
		326A92	673	3.0	-	1	10	8.10	-
327 Magnetic Catch Dual Triple Pole	Aluminum	327A3	666	4.0	-	1	10	13.80	-
		327A92	673	4.0	-	1	10	13.80	-
330 Double Roller Catch	Steel	330F2C	604	1.1	-	1	30	1.80	-
		SP330F2C	604	2.3	-	1	50	-	\$87.50
335 Roller Catch Adjustable	Brass	335B3	605	1.6	-	1	10	13.80	-
		335B5	609	1.6	-	1	10	16.40	-
		335B10	612	1.6	-	1	10	16.40	-
		335B10B	613	1.6	-	1	10	16.40	-
		335B15	619	1.6	-	1	10	17.20	-
		335B26	625	1.6	-	1	10	16.40	-
		335B26D	626	1.6	-	1	10	16.40	-
335 Strike & Mounting Package		09-45-613	613	-	-	1	1	6.10	-
		09-45-619	619	-	-	1	1	6.10	-
336 Roller Catch Adjustable	Brass	336B3	605	1.6	-	1	10	12.60	-
		336B4	606	1.6	-	1	10	16.40	-
		336B5	609	1.6	-	1	10	16.40	-
		336B10	612	1.6	-	1	10	16.40	-
		336B10B	613	1.6	-	1	10	16.40	-
		336B15	619	1.6	-	1	10	16.40	-
		336B26	625	1.6	-	1	10	16.40	-
		336B26D	626	1.6	-	1	10	15.30	-
336 Strike & Mounting Package		09-47-605	605	-	-	1	1	6.70	-
		09-47-613	613	-	-	1	1	6.70	-
							6.70		

Contact Ives Customer Service for pricing on additional sizes and finishes

Bold pricing indicates item is in stock and available for **Fast Track** and **ProXpress**

MODEL	SUBSTRATE	MODEL NUMBER	BHMA FINISH	WEIGHT	MUST BE ORDERED IN MULTIPLE QTY	MULTIPLE QTY	PACKED PER BOX	LIST PRICE	
								EACH	PACKAGE
345 Ball Catch 	Brass	345B3	605	0.8	-	1	10	\$8.10	-
		345B5	609	0.8	-	1	10	8.80	-
		345B10	612	0.8	-	1	10	9.20	-
		345B10B	613	0.8	-	1	10	9.20	-
		345B15	619	0.8	-	1	10	9.50	-
		345B26	625	0.8	-	1	10	9.20	-
347 Ball Catch 	Brass	347B3	605	1.9	-	1	10	12.00	-
		347B4	606	1.9	-	1	10	12.00	-
		347B5	609	1.9	-	1	10	13.00	-
		347B10	612	1.9	-	1	10	13.60	-
		347B10B	613	1.9	-	1	10	13.60	-
		347B15	619	1.9	-	1	10	13.00	-
		347B26	625	1.9	-	1	10	13.60	-
		347B26D	626	1.9	-	1	10	13.60	-
347 Strike & Mounting Package		09-53-605	605	-	-	1	10	6.10	-
		09-53-613	613	-	-	1	10	6.10	-
		09-53-619	619	-	-	1	10	6.10	-
		09-53-625	625	-	-	1	10	6.10	-
		09-53-626	626	-	-	1	10	6.10	-
349 Ball Catch 	Brass	349B3	605	1.8	-	1	10	12.00	-
		349B4	606	1.8	-	1	10	12.00	-
		349B5	609	1.8	-	1	10	14.20	-
		349B10	612	1.8	-	1	10	14.20	-
		349B10B	613	1.8	-	1	10	14.20	-
		349B15	619	1.8	-	1	10	14.70	-
		349B26	625	1.8	-	1	10	14.20	-
		349B26D	626	1.8	-	1	10	14.20	-
		349B-716	-	1.8	-	1	10	14.20	-
349 Strike & Mounting Package		09-61-605	-	-	-	1	1	6.10	-
		09-61-613	-	-	-	1	1	6.10	-
		09-61-626	-	-	-	1	1	6.10	-
FB358 Manual Flush Bolt Wood Door UL 90 Minutes 	Brass	FB358 US3	605	1.7	-	1	2	35.40	-
		FB358 US4	606	1.7	-	1	2	35.40	-
		FB358 US10	612	1.7	-	1	2	35.40	-
		FB358 US10B	613	1.7	-	1	2	35.40	-
		FB358 US15	619	1.8	-	1	5	35.40	-
		FB358 US26	625	1.7	-	1	2	35.40	-
		FB358 US26D	626	1.7	-	1	2	35.40	-
SB360 Surface Bolt Heavy Duty, UL Listed	Steel	SB360 US2C 12 IN	604	3.5	-	1	1	111.40	-
SB360 - MS Strike Package		09-82-604	604	-	-	1	1	23.30	-
SB360 - SNB Package		09-350-604	604	-	-	1	1	19.10	-
401/402CVX Wall Bumper w/Plastic Anchor Convex Rubber, with drywall and masonry anchors. 	Brass	WS401/402 CVX US3	605	2.9	-	1	10	15.80	-
		WS401/402 CVX US4	606	2.9	-	1	10	18.20	-
		WS401/402 CVX US10	612	2.9	-	1	10	18.20	-
		WS401/402 CVX US10B	613	2.9	-	1	10	18.20	-
		WS401/402 CVX US15	619	2.9	-	1	10	18.20	-
		WS401/402 CVX US26	625	2.9	-	1	10	18.20	-
		WS401/402 CVX US26D	626	2.9	-	1	10	18.20	-
401/402CCV Wall Bumper w/Plastic Anchor Concave Rubber, with drywall and masonry anchors. 	Brass	WS401/402 CCV US3	605	3.1	-	1	10	15.80	-
		WS401/402 CCV US4	606	3.1	-	1	10	18.20	-
		WS401/402 CCV US10	612	3.1	-	1	10	18.20	-
		WS401/402 CCV US10B	613	3.1	-	1	10	18.20	-
		WS401/402 CCV US15	619	3.1	-	1	10	18.20	-
		WS401/402 CCV US26	625	3.1	-	1	10	18.20	-
		WS401/402 CCV US26D	626	3.1	-	1	10	18.20	-

HINGES

CONTINUOUS HINGES

PIVOTS

Numerical 1-059

Numerical 59-437

Numerical 438-1021

Numerical 1152-8190

Numerical 8200-9340

Contact Ives Customer Service for pricing on additional sizes and finishes





Bold pricing indicates item is in stock and available for **Fast Track** and **ProXpress**

HINGES





CONTINUOUS HINGES

PIVOTS

Numerical
1-059Numerical
59-437Numerical
438-1021Numerical
1152-8190Numerical
8200-9340

MODEL	SUBSTRATE	MODEL NUMBER	BHMA FINISH	WEIGHT	MUST BE ORDERED IN MULTIPLE QTY	MULTIPLE QTY	PACKED PER BOX	LIST PRICE	
								EACH	PACKAGE
WS404-CVX Small Wall Stop Convex Rubber 1" Base Diameter 	Brass	WS404 US3	605	1.0	-	1	20	\$5.50	-
		WS404 US4	606	1.0	-	1	20	6.60	-
		WS404 US5	609	1.0	-	1	20	6.60	-
		WS404 US10	612	1.0	-	1	20	6.60	-
		WS404 US10B	613	1.0	-	1	20	6.60	-
		WS404 US15	619	1.0	-	1	20	6.90	-
		WS404 US26	625	1.0	-	1	20	6.60	-
		WS404 US26D	626	1.0	-	1	20	6.60	-
405 Coat and Hat Hook 	Aluminum	405A3	666	1.5	-	1	20	2.50	-
		405A4	667	1.5	-	1	20	2.50	-
		405A5	-	1.5	-	1	20	2.50	-
		405A10	668	1.5	-	1	20	2.50	-
		405A10B	703	1.5	-	1	20	2.50	-
		405A14	669	1.5	-	1	20	2.50	-
		405A92	673	1.5	-	1	20	2.50	-
406/407CVX Wall Stop w/Plastic Anchor Convex Rubber, with drywall and masonry anchors. 	Brass	WS406/407CVX US3	605	1.8	-	1	10	3.80	-
		WS406/407CVX US4	606	1.8	-	1	10	3.80	-
		WS406/407CVX US5	609	1.8	-	1	10	4.30	-
		WS406/407CVX US10	612	1.8	-	1	10	4.30	-
		WS406/407CVX US10B	613	1.8	-	1	10	4.30	-
		WS406/407CVX US15	619	1.8	-	1	10	4.30	-
		WS406/407CVX US26	625	1.8	-	1	10	4.30	-
		WS406/407CVX US26D	626	1.8	-	1	10	3.80	-
	Stainless	WS406/407CVX US32D	630	1.8	-	1	10	3.10	-
406/407CCV Wall Stop w/Plastic Anchor Concave Rubber, with drywall and masonry anchors. 	Brass	WS406/407CCV US3	605	2.0	-	1	10	3.80	-
		WS406/407CCV US4	606	2.0	-	1	10	3.80	-
		WS406/407CCV US5	609	1.8	-	1	10	4.30	-
		WS406/407CCV US10	612	2.0	-	1	10	4.30	-
		WS406/407CCV US10B	613	2.0	-	1	10	4.30	-
		WS406/407CCV US15	619	2.0	-	1	10	4.30	-
		WS406/407CCV US26	625	2.0	-	1	10	4.30	-
		WS406/407CCV US26D	626	2.0	-	1	10	3.80	-
	Stainless	WS406/407CCV US32D	630	2.0	-	1	10	3.10	-

Bold pricing indicates item is in stock and available for **Fast Track** and **ProXpress**

MODEL	SUBSTRATE	MODEL NUMBER	BHMA FINISH	WEIGHT	MUST BE ORDERED IN MULTIPLE QTY	MULTIPLE QTY	PACKED PER BOX	LIST PRICE	
								EACH	PACKAGE
FS410 Universal Floor Dome Stop		FS410 US3	605	3		1		\$25.80	-
		FS410 US26D	626	3		1		21.90	-
411 Wall Stop Adhesive Back	Rubber	411R-W	-	1.1	-	1	20	2.80	-
430 Floor Door Stop 	Aluminum	SP430A3	666	1.9	Yes	25	25	-	\$64.60
		SP430A5	-	1.9	Yes	25	25	-	67.30
		SP430A14	669	1.9	Yes	25	25	-	67.30
		SP430A92	673	1.9	Yes	25	25	-	64.60
	Brass	430 US3	605	1.8	-	1	10	14.70	-
		430 US4	606	1.8	-	1	10	13.60	-
		430 US5	609	1.8	-	1	10	17.40	-
		430 US10B	613	1.8	-	1	10	17.40	-
		430 US15	619	1.8	-	1	10	18.20	-
		430 US26	625	1.8	-	1	10	17.40	-
430 US26D		626	1.8	-	1	10	17.40	-	
430 Rubber Tip	Rubber	RT (WSPART.1075)	-	-	Yes	100	100	-	79.50
FS434 Angle Door Stop	Steel	FS434 US2C	604	4.0	-	1	10	8.50	-
FS434 Rubber Tip		09-318	-	-	-	1	1	4.00	-
R435 Riser For 436 Door Stop 	Aluminum	R435 1/4 IN	-	2.1	-	1	20	6.00	-
		R435 3/8 IN	-	2.6	-	1	20	6.00	-
		R435 1/2 IN	-	2.9	-	1	20	6.00	-
		R435 5/8 IN	-	3.3	-	1	20	6.00	-
		R435 3/4 IN	-	3.2	-	1	20	6.00	-
		R435 7/8 IN	-	3.2	-	1	20	6.00	-
		R435 1 IN	-	3.1	-	1	20	6.00	-
FS436 Floor Dome Stop 1" Height 	Brass	FS436 US3	605	2.2	-	1	10	6.30	-
		FS436 US4	606	2.2	-	1	10	6.30	-
		FS436 US5	609	2.2	-	1	10	6.30	-
		FS436 US10	612	2.2	-	1	10	7.30	-
		FS436 US10B	613	2.2	-	1	10	7.30	-
		FS436 US15	619	2.2	-	1	10	7.30	-
		FS436 US26	625	2.2	-	1	10	6.60	-
		FS436 US26D	626	2.2	-	1	10	5.30	-
		FS436 B-716	-	2.2	-	1	10	7.20	-
		SPFS436US26D	626	2.5	Yes	10	10	-	53.00
		SPSFS436B-605	605	-	Yes	15	15	-	96.10
		SPSFS436B-619	619	-	Yes	15	15	-	111.10
		SPSFS436B-716	-	-	Yes	15	15	-	111.10
	Aluminum	FS436 US28	628	-	-	1	10	4.80	-
	SPFS436US28	628	-	Yes	15	15	-	72.30	
R437 Riser For 438 Door Stop 	Aluminum	R437 1/4 IN	-	2.0	-	1	10	6.40	-
		R437 3/8 IN	-	2.0	-	1	10	6.40	-
		R437 1/2 IN	-	2.0	-	1	10	6.40	-
		R437 5/8 IN	-	2.0	-	1	10	6.40	-
		R437 3/4 IN	-	2.2	-	1	10	6.40	-
		R437 1 IN	-	2.3	-	1	10	6.40	-

HINGES

CONTINUOUS HINGES

PIVOTS

Numerical 1-059

Numerical 59-437

Numerical 438-1021

Numerical 1152-8190

Numerical 8200-9340

Bold pricing indicates item is in stock and available for **Fast Track** and **ProXpress**

HINGES

CONTINUOUS HINGES

PIVOTS







Numerical 1-059

Numerical 59-437





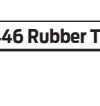

Numerical 438-1021

Numerical 1152-8190

Numerical 8200-9340

MODEL	SUBSTRATE	MODEL NUMBER	BHMA FINISH	WEIGHT	MUST BE ORDERED IN MULTIPLE QTY	MULTIPLE QTY	PACKED PER BOX	LIST PRICE	
								EACH	PACKAGE
FS438 Floor Dome Stop 13/8" Height 	Brass	FS438 US3	605	2.70	-	1	10	\$7.40	-
		FS438 US4	606	2.70	-	1	10	7.40	-
		FS438 US5	609	2.70	-	1	10	7.40	-
		FS438 US10	612	2.70	-	1	10	8.50	-
		FS438 US10B	613	2.70	-	1	10	8.50	-
		FS438 US15	619	2.70	-	1	10	10.80	-
		FS438 US26	625	2.70	-	1	10	8.00	-
	FS438 US26D	626	2.70	-	1	10	5.90	-	
	Aluminum	FS438 US28	628	1.60	-	1	10	5.80	-
FS439 	Zinc	FS439 US3	677	2.2	-	1	10	11.00	-
		FS439 US4	678	2.2	-	1	10	11.00	-
		FS439 US10B	704	2.2	-	1	10	11.80	-
		FS439 US 26D	682	2.2	-	1	10	9.80	-
		Stainless	FS439 US32D	630	2.2	-	1	10	16.00
FS440 Heavy Duty Spring Loaded Floor Stop 	Aluminum	FS440 US28	628	-	-	1	10	68.90	-
		Available Late 2017							
FS441 Floor Stop Now furnished with wood and masonry fasteners 	Brass	FS441 US3	605	1.10	-	1	2	21.90	-
		FS441 US4	606	1.10	-	1	2	24.90	-
		FS441 US5	609	1.10	-	1	2	23.40	-
		FS441 US10	612	1.10	-	1	2	24.90	-
		FS441 US10B	613	1.10	-	1	2	23.40	-
		FS441 US15	619	1.10	-	1	2	30.10	-
		FS441 US26	625	1.10	-	1	2	30.10	-
	FS441 US26D	626	1.10	-	1	2	21.20	-	
FS441 Rubber Tip		09-315	-	-	-	1	1	2.10	-
WS443 Wall Door Stop for Masonry Mounting 	Brass	WS443 US3	605	1.50	-	1	2	33.90	-
		WS443 US4	606	1.50	-	1	2	42.30	-
		WS443 US10	612	1.50	-	1	2	40.80	-
		WS443 US10B	613	1.50	-	1	2	40.80	-
		WS443 US15	619	1.50	-	1	2	42.30	-
		WS443 US26	625	1.50	-	1	2	40.80	-
	WS443 US26D	626	1.50	-	1	2	40.80	-	
WS443 Rubber Tip		09-316	-	-	-	1	1	2.10	-
FS444 Floor Stop for Masonry Mounting 	Brass	FS444 US3	605	2.00	-	1	2	25.90	-
		FS444 US4	606	2.00	-	1	2	25.90	-
		FS444 US10	612	2.00	-	1	2	25.90	-
		FS444 US10B	613	2.00	-	1	2	30.50	-
		FS444 US15	619	2.00	-	1	2	33.10	-
		FS444 US26	625	2.00	-	1	2	25.90	-
	FS444 US26D	626	2.00	-	1	2	24.90	-	
FS444 Rubber Tip		09-316	-	-	-	1	1	2.10	-
WS445 Wall Door Stop w/Heavy Duty Holder for Masonry Mounting 	Brass	WS445 US3	605	1.90	-	1	2	53.80	-
		WS445 US4	606	1.90	-	1	2	64.60	-
		WS445 US10	612	1.90	-	1	2	64.60	-
		WS445 US10B	613	1.90	-	1	2	64.60	-
		WS445 US15	619	1.90	-	1	2	67.10	-
		WS445 US26	625	1.90	-	1	2	64.60	-
	WS445 US26D	626	1.90	-	1	2	64.60	-	
WS445 Rubber Tip		09-316	-	-	-	1	1	2.10	-
FS446 Floor Stop w/Heavy Duty Holder for Masonry Mounting 	Brass	FS446 US3	605	2.40	-	1	2	51.30	-
		FS446 US4	606	2.40	-	1	2	51.30	-
		FS446 US10	612	2.40	-	1	2	51.30	-
		FS446 US10B	613	2.40	-	1	2	45.60	-
		FS446 US15	619	2.40	-	1	2	47.50	-
		FS446 US26	625	2.40	-	1	2	51.30	-
		FS446 US26D	626	2.40	-	1	2	36.50	-
		Aluminum	FS446 US28	628	1.30	-	1	2	26.20
FS446 Rubber Tip		09-316	-	-	-	1	1	2.10	-

Bold pricing indicates item is in stock and available for **Fast Track** and **ProXpress**

MODEL	SUBSTRATE	MODEL NUMBER	BHMA FINISH	WEIGHT	MUST BE ORDERED IN MULTIPLE QTY	MULTIPLE QTY	PACKED PER BOX	LIST PRICE	
								EACH	PACKAGE
WS447 Heavy Duty Wall Door Stop for Drywall Mounting 	Brass	WS447 US3	605	1.30	-	1	2	\$30.80	-
		WS447 US4	606	1.30	-	1	2	37.00	-
		WS447 US10	612	1.30	-	1	2	37.00	-
		WS447 US10B	613	1.30	-	1	2	37.00	-
		WS447 US15	619	1.30	-	1	2	38.50	-
		WS447 US26	625	1.30	-	1	2	37.00	-
		WS447 US26D	626	1.30	-	1	2	37.00	-
WS447 Rubber Tip		09-316	-	-	-	1	1	2.10	-
FS448 Floor Door Stop Heavy Duty for Wood Mounting 	Brass	FS448 US3	605	1.90	-	1	2	29.00	-
		FS448 US4	606	1.90	-	1	2	29.00	-
		FS448 US5	609	1.90	-	1	2	33.70	-
		FS448 US10	612	1.90	-	1	2	29.00	-
		FS448 US10B	613	1.90	-	1	2	28.10	-
		FS448 US15	619	1.90	-	1	2	36.50	-
		FS448 US26	625	1.90	-	1	2	36.50	-
	FS448 US26D	626	1.90	-	1	2	29.00	-	
	Aluminum	FS448 US28	628	0.80	-	1	2	21.30	-
FS448 Rubber Tip		09-316	-	-	-	1	1	2.10	-
WS449 Wall Door Stop w/Heavy Duty Holder for Drywall Mounting 	Brass	WS449 US3	605	1.60	-	1	2	51.40	-
		WS449 US4	606	1.60	-	1	2	61.60	-
		WS449 US10	612	1.60	-	1	2	61.60	-
		WS449 US10B	613	1.60	-	1	2	61.60	-
		WS449 US15	619	1.60	-	1	2	64.00	-
		WS449 US26	625	1.60	-	1	2	61.60	-
	WS449 US26D	626	1.60	-	1	2	61.60	-	
	Aluminum	WS449 US28	628	0.90	-	1	2	43.00	-
WS449 Rubber Tip		09-316	-	-	-	1	1	2.10	-
FS450 Floor Door Stop w/Heavy Duty Holder for Wood Mounting 	Brass	FS450 US3	605	2.20	-	1	2	54.50	-
		FS450 US4	606	2.20	-	1	2	54.50	-
		FS450 US10	612	2.20	-	1	2	54.50	-
		FS450 US10B	613	2.20	-	1	2	54.50	-
		FS450 US15	619	2.20	-	1	2	57.90	-
		FS450 US26	625	2.20	-	1	2	54.50	-
	FS450 US26D	626	2.20	-	1	2	39.60	-	
	Aluminum	FS450 US28	628	1.10	-	1	2	29.50	-
FS450 Rubber Tip		09-316	-	-	-	1	1	2.10	-
FS452 Kick Down Door Holder 4" 	Brass	FS452-4 US3	605	5.00	-	1	10	28.10	-
		FS452-4 US4	606	5.00	-	1	10	28.10	-
		FS452-4 US10	612	5.00	-	1	10	28.10	-
		FS452-4 US10B	613	5.00	-	1	10	29.70	-
		FS452-4 US15	619	5.00	-	1	10	38.40	-
		FS452-4 US26	625	5.00	-	1	10	41.70	-
	FS452-4 US26D	626	5.00	-	1	10	27.00	-	
	Aluminum	FS452-4 US28	628	2.10	-	1	10	24.50	-
FS452 Rubber Tips		HRT (FSPART.1075)	-	-	Yes	100	100	-	\$117.10
FS452 Kick Down Door Holder 5" 	Brass	FS452-5 US3	605	5.80	-	1	10	38.90	-
		FS452-5 US4	606	5.80	-	1	10	38.90	-
		FS452-5 US10	612	5.80	-	1	10	38.90	-
		FS452-5 US10B	613	5.80	-	1	10	38.90	-
		FS452-5 US15	619	5.80	-	1	10	43.80	-
		FS452-5 US26	625	5.80	-	1	10	48.70	-
	FS452-5 US26D	626	5.80	-	1	10	33.50	-	
FS452 Rubber Tips		HRT (FSPART.1075)	-	-	Yes	100	100	-	117.10
SB453 Surface Bolt UL Listed 8" 	Steel	SB453US2C-8-TB	604	5.40	-	1	5	40.60	-
		SB453US3-8-TB	632	5.80	-	1	5	40.60	-
		SB453US4-8-TB	633	5.80	-	1	5	40.60	-
		SB453US10-8-TB	639	5.40	-	1	5	48.90	-
		SB453US10B-8-TB	640	5.40	-	1	5	52.50	-
		SB453US26D-8-TB	652	5.40	-	1	5	50.00	-

HINGES

CONTINUOUS HINGES

PIVOTS

Numerical 1-059

Numerical 59-437

Numerical 438-1021

Numerical 1152-8190

Numerical 8200-9340

Bold pricing indicates item is in stock and available for **Fast Track** and **ProXpress**

HINGES

CONTINUOUS HINGES

PIVOTS







Numerical 1-059

Numerical 59-437







Numerical 438-1021

Numerical 1152-8190

Numerical 8200-9340

MODEL	SUBSTRATE	MODEL NUMBER	BHMA FINISH	WEIGHT	MUST BE ORDERED IN MULTIPLE QTY	MULTIPLE QTY	PACKED PER BOX	LIST PRICE	
								EACH	PACKAGE
SB453 Surface Bolt UL Listed 12"	Steel	SB453US2C 12-TB	604	6.60	-	1	5	\$51.20	-
		SB453US10 12-TB	639	6.60	-	1	5	54.70	-
		SB453US10B 12-TB	640	6.60	-	1	5	59.70	-
		SB453US26D 12-TB	652	6.60	-	1	5	63.20	-
SB453 Thrubolt with Cap Nut Pkg		09-340-626	626	-	-	1	1	8.10	-
SB453 Sex Bolt Pkg		09-351-604	604	-	-	1	1	14.90	-
FS455 4" Kick Down Door Holder 	Aluminum	FS455-4 US3AL	666	1.90	-	1	10	7.50	-
		FS455-4 US5AL	-	2.00	-	1	10	11.30	-
		FS455-4 US10AL	668	1.90	-	1	10	7.50	-
		FS455-4 US27	673	1.90	-	1	10	7.50	-
		SPFS455-4 US3AL	666	46.50	Yes	15	15	-	\$112.70
		SPFS455-4 US5AL	-	46.50	Yes	15	15	-	170.80
		SPFS455-4 US27	673	46.50	Yes	15	15	-	112.70
	Brass	FS455-4 US3	605	4.60	-	1	10	30.50	-
		FS455-4 US4	606	4.60	-	1	10	30.50	-
		FS455-4 US5	609	4.60	-	1	10	36.60	-
		FS455-4 US10	612	4.60	-	1	10	30.50	-
		FS455-4 US10B	613	4.60	-	1	10	36.60	-
		FS455-4 US15	619	4.60	-	1	10	37.50	-
		FS455-4 US26	625	4.60	-	1	10	36.60	-
FS455-4 US26D		626	4.60	-	1	10	36.60	-	
FS455 Rubber Tips		HRT (FSPART.1075)	-	-	Yes	100	100	-	117.10
FB457 Manual Flush Bolt UL 3 Hour Single Metal Door  Optional Rod Lengths Available 18", 24", 36", 48" 11.50 List Add	Brass	FB457-12 US3	605	2.00	-	1	12	26.20	-
		FB457-12 US4	606	2.00	-	1	12	26.20	-
		FB457-12 US10	612	2.00	-	1	12	26.20	-
		FB457-12 US10B	613	2.00	-	1	12	26.20	-
		FB457-12 US15	619	2.00	-	1	12	26.20	-
		FB457-12 US26	625	2.00	-	1	12	26.20	-
		FB457-12 US26D	626	2.00	-	1	12	26.20	-
		FB457 Bolt Tips		09-176-604	-	-	-	1	1
FB457 Guide PKG		09-135	-	-	-	1	1	2.10	-
FB458 Manual Flush Bolt UL 3 Hour Single Metal Door  Optional Rod Lengths Available 18", 24", 36", 48" 11.10 List Add	Brass	FB458 US3 12 IN	605	2.00	-	1	12	22.20	-
		FB458 US4 12 IN	606	2.00	-	1	12	22.20	-
		FB458 US5 12 IN	609	2.00	-	1	12	22.20	-
		FB458 US10 12 IN	612	2.00	-	1	12	22.20	-
		FB458 US10B 12 IN	613	2.00	-	1	12	22.20	-
		FB458 US15 12 IN	619	2.00	-	1	12	22.20	-
		FB458 US26 12 IN	625	2.00	-	1	12	22.20	-
		FB458 US26D 12 IN	626	2.00	-	1	12	20.70	-
		FB458 Bolt Tips		09-176-604	604	-	-	1	1
FB458 Guide PKG		09-135	-	-	-	1	1	2.10	-
RB470 Roller Bumper 2" Reach 	Brass	RB470 US3	605	0.90	-	1	2	29.20	-
		RB470 US26	625	0.90	-	1	2	36.60	-
		RB470 US26D	626	0.90	-	1	2	36.60	-
RB470 Large Roller PKG		09-137-626	626	-	-	1	1	5.50	-
RB471 Roller Bumper 4-1/2" Projection 	Brass	RB471 US3	605	1.00	-	1	2	27.60	-
		RB471 US4	606	1.00	-	1	2	33.10	-
		RB471 US26	625	1.00	-	1	2	33.10	-
		RB471 US26D	626	1.00	-	1	2	33.10	-
RB472 Roller Bumper 6" Projection 	Brass	RB472 US3	605	1.10	-	1	2	29.30	-
		RB472 US4	606	1.10	-	1	2	34.90	-
		RB472 US10	612	1.10	-	1	2	34.90	-
		RB472 US10B	613	1.10	-	1	2	34.90	-
		RB472 US15	619	1.10	-	1	2	33.20	-
		RB472 US26	625	1.10	-	1	2	34.90	-
		RB472 US26D	626	1.10	-	1	2	34.90	-
RB472 Large Roller PKG		09-137-626	626	-	-	1	1	5.50	-

Bold pricing indicates item is in stock and available for **Fast Track** and **ProXpress**

MODEL	SUBSTRATE	MODEL NUMBER	BHMA FINISH	WEIGHT	MUST BE ORDERED IN MULTIPLE QTY	MULTIPLE QTY	PACKED PER BOX	LIST PRICE	
								EACH	PACKAGE
481 Chain Door Guard 	Brass	481B3	605	2.50	-	1	10	\$11.30	-
		481B26D	626	2.50	-	1	10	13.30	-
	Steel	481F3	632	2.30	-	1	10	6.30	-
		481F4	633	2.30	-	1	10	6.30	-
		481F5	638	2.30	-	1	10	7.10	-
		481F10	639	2.30	-	1	10	7.10	-
		481F15	646	2.30	-	1	10	6.30	-
		481F26	651	2.30	-	1	10	6.30	-
		481F26D	652	2.30	-	1	10	6.30	-
		481F-716	-	1.20	-	1	10	7.30	-
	SC481F3	632	6.00	-	Yes	5	5	-	\$36.30
SC481F-619	646	6.00	-	Yes	5	5	-	36.30	
SC481F-716	-	11.50	-	Yes	5	5	-	36.30	
482 Door Guard 	Aluminum	482A3	666	3.50	-	1	5	9.30	-
		482A5	-	3.50	-	1	5	9.30	-
		482A26	672	3.50	-	1	5	11.00	-
		482A26D	702	3.50	-	1	5	11.00	-
	Brass	482B3	605	5.00	-	1	5	31.30	-
		482B4	606	5.00	-	1	5	34.50	-
		482B10	612	5.00	-	1	5	34.50	-
		482B10B	613	5.00	-	1	5	34.50	-
		482B15	619	5.00	-	1	5	47.30	-
		482B26	625	5.00	-	1	5	34.50	-
482B26D	626	5.00	-	1	5	34.50	-		
482▲ Plate		09-170-605	605	-	-	1	1	6.70	-
		09-170-613	613	-	-	1	1	6.70	-
		09-170-626	626	-	-	1	1	6.70	-
482▲ SHIM 1/8 In		09-576-626	626	-	-	1	1	15.20	-
482▲ SHIM 3/8 In		09-577-626	626	-	-	1	1	24.00	-
FS495 Auto Door Stop and Holder 3/8" Max Clearance Floor to Door 	Brass	FS495 US3	605	1.80	-	1	1	79.70	-
		FS495 US4	606	1.80	-	1	1	79.70	-
		FS495 US10	612	1.80	-	1	1	95.50	-
		FS495 US10B	613	1.80	-	1	1	95.50	-
		FS495 US26	625	1.80	-	1	1	95.50	-
		FS495 US26D	626	1.80	-	1	1	79.70	-
FS496 Auto Door Stop and Holder 1" Max Clearance Floor to Door 	Brass	FS496 US3	605	1.50	-	1	1	90.90	-
		FS496 US10	612	1.50	-	-	1	90.90	-
		FS496 US10B	613	1.50	-	1	1	90.90	-
		FS496 US26	625	1.50	-	1	1	90.90	-
		FS496 US26D	626	1.50	-	1	1	90.90	-
FS497 Auto Door Stop and Holder 	Brass	FS497 US3	605	1.40	-	1	1	84.90	-
		FS497 US10	612	1.40	-	1	1	101.90	-
		FS497 US10B	613	1.40	-	1	1	101.90	-
		FS497 US26	625	1.40	-	1	1	101.90	-
		FS497 US26D	626	1.40	-	1	1	84.90	-
FS544 Kick Down Door Holder 4" 	Steel	FS544 SP4	706	-	-	1	-	11.30	-
		FS544 SP10	691	-	-	1	-	11.30	-
		FS544 SP28	689	-	-	1	-	11.30	-
		FS544 SP313	695	-	-	1	-	11.30	-
		FS544 SPBLK	693	-	-	1	-	11.30	-
FS555 Kick Down Door Holder 5" 	Steel	FS555 SP4	706	-	-	1	-	12.00	-
		FS555 SP10	691	-	-	1	-	12.00	-
		FS555 SP28	689	-	-	1	-	12.00	-
		FS555 SP313	695	-	-	1	-	12.00	-
		FS555 SPBLK	693	-	-	1	-	12.00	-

▲ Fits brass door guards only.

Bold pricing indicates item is in stock and available for **Fast Track** and **ProXpress**

HINGES

CONTINUOUS HINGES

PIVOTS

Numerical 1-059

Numerical 59-437

Numerical 438-1021

Numerical 1152-8190











Numerical 8200-9340

HINGES



CONTINUOUS
HINGES

PIVOTS

Numerical
1-059Numerical
59-437Numerical
438-1021Numerical
1152-8190Numerical
8200-9340

MODEL	SUBSTRATE	MODEL NUMBER	BHMA FINISH	WEIGHT	MUST BE ORDERED IN MULTIPLE QTY	MULTIPLE QTY	PACKED PER BOX	LIST PRICE	
								EACH	PACKAGE
506 Plymouth, Curved Double Coat Hook - Surface Mount 	Brass	506-605	605	-	-	1	20	\$11.40	-
		506-613	613	-	-	1	20	11.40	-
		506-626	626	-	-	1	20	9.20	-
507 Rhodes, Parallel Double Coat Hook - Surface Mount 	Brass	507-605	605	-	-	1	20	26.40	-
		507-613	613	-	-	1	20	27.70	-
		507-626	626	-	-	1	20	21.80	-
507B Rhodes Single Coat Hook - Surface Mount 	Brass	507B-605	605	-	-	1	50	26.40	-
		507B-613	613	-	-	1	50	27.70	-
		507B-626	626	-	-	1	50	21.80	-
508 Greenwich, Wide Body Double Coat Hook - Surface Mount 	Brass	508-605	605	-	-	1	8	70.10	-
		508-613	613	-	-	1	8	72.40	-
		508-626	626	-	-	1	8	56.40	-
508C Greenwich, Wide Body Double Coat Hook - Concealed Mount 	Brass	508C-605	605	-	-	1	8	136.80	-
		508C-613	613	-	-	1	8	142.60	-
		508C-626	626	-	-	1	8	109.20	-
509C Tubular, Double Coat Hook - Concealed Mount 	Brass	509C-605	605	-	-	1	5	114.90	-
		509C-613	613	-	-	1	5	119.60	-
		509C-626	626	-	-	1	5	91.90	-
510C Latitude, Angled Double Coat Hook - Concealed Mount 	Brass	510C-605	605	-	-	1	4	114.90	-
		510C-613	613	-	-	1	4	119.60	-
		510C-626	626	-	-	1	4	91.90	-
510BC Latitude, Angled Single Coat Hook - Concealed Mount 	Brass	510BC-605	605	-	-	1	8	81.50	-
		510BC-613	613	-	-	1	8	85.10	-
		510BC-626	626	-	-	1	8	65.50	-
511BC Century, Wide Single Coat Hook - Concealed Mount 	Brass	511BC-605	605	-	-	1	50	19.60	-
		511BC-613	613	-	-	1	50	19.60	-
		511BC-626	626	-	-	1	50	14.90	-
543 Camelot, J Curve, Double Coat Hook - Surface Mount 	Stainless	543-629	629	-	-	1	10	10.40	-
		543-630	630	-	-	1	10	10.40	-
543B Camelot, J Curve, Single Coat Hook - Surface Mount 	Stainless	543B-629	629	-	-	1	10	9.20	-
		543B-630	630	-	-	1	10	9.20	-
554 Century, Wave Double Coat Hook - Surface Mount 	Brass	554-605	605	-	-	1	10	28.70	-
		554-625	625	-	-	1	10	23.00	-
		554-626	626	-	-	1	10	23.00	-

Bold pricing indicates item is in stock and available for **Fast Track** and **ProXpress**





MODEL	SUBSTRATE	MODEL NUMBER	BHMA FINISH	WEIGHT	MUST BE ORDERED IN MULTIPLE QTY	MULTIPLE QTY	PACKED PER BOX	LIST PRICE	
								EACH	PACKAGE
558B Orbit 1" J Curve w/ Bumper Single Coat Hook - Surface Mount	Brass	558B-605	605	-	-	1	20	\$94.20	-
		558B-613	613	-	-	1	20	98.80	-
		558B-626	626	-	-	1	20	75.80	-
559B Tubular, w/ Disc Single Coat Hook - Surface Mount	Brass	559B-605	605	-	-	1	40	21.80	-
		559B-613	613	-	-	1	40	21.80	-
		559B-626	626	-	-	1	40	17.30	-
571 Coat and Hat Hook 	Aluminum	571A3	666	1.30	-	1	20	1.20	-
		571A5	-	1.30	-	1	20	1.80	-
		571A10	668	1.30	-	1	20	1.20	-
		571A14	669	1.30	-	1	20	1.80	-
		571A15	670	1.30	-	1	20	1.80	-
		571A92	673	1.30	-	1	20	1.20	-
		571A-716	-	1.30	-	1	20	2.40	-
		571A-BLK	-	1.40	-	1	20	2.40	-
		571A-W	-	1.40	-	1	20	2.40	-
		SP571A3	666	47.50	Yes	25	25	-	\$32.00
		SP571A5	-	47.50	Yes	25	25	-	43.80
		SP571A14	669	47.50	Yes	25	25	-	43.80
		SP571A92	673	47.50	Yes	25	25	-	32.00
		SP571A-W	-	47.50	Yes	25	25	-	61.30
	Brass	571B3	605	1.50	-	-	10	8.10	-
		571B4	606	1.50	-	-	10	9.60	-
		571B5	609	1.50	-	-	10	9.60	-
		571B10B	613	1.50	-	1	10	9.60	-
		571B15	619	1.50	-	1	10	10.20	-
		571B26	625	1.50	-	1	10	9.60	-
		571B26D	626	1.50	-	1	10	9.60	-
		571B-716	-	1.50	-	1	10	9.60	-
		SP571B26	625	24	Yes	10	10	-	100.40
		SPS571B-609	609	-	Yes	25	25	-	274.00
		SPS571B-619	619	-	Yes	25	25	-	274.00
		SPS571B-620	620	-	Yes	25	25	-	274.00
Zinc **	571Z-619E	-	4.7	Yes	25	20	4.90	-	
572 Coat and Hat Hook 	Aluminum	572A3	666	1.90	-	1	20	4.00	-
		572A5	-	1.90	-	1	20	4.20	-
		572A10	668	1.90	-	1	20	4.20	-
		572A10B	703	0.00	-	1	20	4.20	-
		572A14	669	1.90	-	1	20	4.20	-
		572A15	670	1.90	-	1	20	4.20	-
		572A92	673	1.90	-	1	20	4.00	-
		Brass	572B3	605	1.10	-	1	10	11.00
	572B4		606	1.10	-	1	10	11.00	-
	572B5		609	1.10	-	1	10	13.90	-
	572B10		612	1.10	-	1	10	11.00	-
	572B10B		613	1.10	-	1	10	13.40	-
	572B15		619	1.10	-	1	10	13.90	-
	572B26		625	1.10	-	1	10	13.40	-
	572B26D		626	1.10	-	1	10	13.40	-

HINGES
 CONTINUOUS HINGES
 PIVOTS
 Numerical 1-059
 Numerical 59-437
 Numerical 438-1021
 Numerical 1152-8190
 Numerical 8200-9340

** Zinc substrate, narrow brass.





Bold pricing indicates item is in stock and available for **Fast Track** and **ProXpress**

HINGES
 CONTINUOUS HINGES
 PIVOTS
 Numerical 1-059
 Numerical 59-437
 Numerical 438-1021
 Numerical 1152-8190
 Numerical 8200-9340

MODEL	SUBSTRATE	MODEL NUMBER	BHMA FINISH	WEIGHT	MUST BE ORDERED IN MULTIPLE QTY	MULTIPLE QTY	PACKED PER BOX	LIST PRICE	
								EACH	PACKAGE
574 Coat and Hat Hook 	Aluminum	574A3	666	1.60	-	1	10	\$8.00	-
		574A26	672	1.60	-	1	10	8.00	-
		574A92	673	0.00	-	1	10	8.00	-
	Brass	574B3	605	4.10	-	1	10	27.70	-
		574B4	606	0.00	-	1	10	27.70	-
		574B10	612	0.00	-	1	10	33.00	-
		574B10B	613	4.10	-	1	10	33.00	-
		574B15	619	0.00	-	1	10	36.40	-
		574B26	625	4.10	-	1	10	33.00	-
575 Coat and Hat Hook 	Aluminum	575A3	666	1.40	-	1	10	4.90	-
		575A10B	703	1.40	-	1	10	5.40	-
		575A92	673	1.40	-	1	10	4.90	-
580 Ceiling Hook 	Aluminum	580A3	666	1.80	-	1	20	2.80	-
		580A5	-	0.00	-	1	20	3.00	-
		580A10	668	1.80	-	1	20	3.00	-
		580A14	669	1.80	-	1	20	3.00	-
		580A15	670	0.00	-	1	20	3.00	-
		580A92	673	1.80	-	1	20	2.80	-
		580A716	-	0.00	-	1	20	3.00	-
		SP580A14	669	60.00	Yes	25	25	-	\$75.80
		SP580A3	666	60.00	Yes	25	25	-	70.00
SP580A92	673	60.00	Yes	25	25	-	70.00		
581 Wardrobe Hook 	Aluminum	581A3	666	0.90	-	1	20	1.60	-
		581A5	-	0.90	-	1	20	1.80	-
		581A14	669	0.80	-	1	20	1.80	-
		581A15	670	0.90	-	1	20	1.80	-
		581A92	673	0.90	-	1	20	1.60	-
		581A-716	-	0.90	-	1	20	1.80	-
		581A-BLK	-	0.90	-	1	20	2.30	-
		581A-W	-	0.90	-	1	20	2.30	-
		SP581A3	666	120.00	Yes	50	50	-	75.80
		SP581A5	-	120.00	Yes	50	50	-	87.50
		SP581A14	669	120.00	Yes	50	50	-	87.50
		SP581A92	673	2.40	Yes	50	50	-	75.80
		Brass	581B3	605	0.80	-	1	10	5.50
	581B4		606	0.00	-	1	10	5.80	-
	581B5		609	0.80	-	1	10	6.60	-
	581B10		612	0.00	-	1	10	6.70	-
	581B10B		613	0.80	-	1	10	6.60	-
	581B15		619	0.80	-	1	10	6.80	-
	581B26		625	0.80	-	1	10	6.60	-
	581B26D	626	0.80	-	1	10	6.60	-	
581B-716	-	-	-	-	1	10	6.80	-	
SC581B-619	619	-	Yes	5	5	-	37.30		

Continued on next page.

Bold pricing indicates item is in stock and available for **Fast Track** and **ProXpress**

MODEL	SUBSTRATE	MODEL NUMBER	BHMA FINISH	WEIGHT	MUST BE ORDERED IN MULTIPLE QTY	MULTIPLE QTY	PACKED PER BOX	LIST PRICE		
								EACH	PACKAGE	
581 Wardrobe Hook <i>Continued from previous page.</i> 	Brass	SP581B26	625	27.00	Yes	10	10	-	\$65.30	
		SPS581B-605	605	-	Yes	25	25	-	151.70	
		SPS581B-609	609	-	Yes	25	25	-	186.70	
		SPS581B-619	619	-	Yes	25	25	-	186.70	
		SPS581B-620	620	-	Yes	25	25	-	186.70	
		SPS581B-716	-	-	Yes	25	25	-	186.70	
	Zinc**	581Z-619E	-	2.60	-	1	20	\$4.90	-	
582 Wardrobe Hook 	Aluminum	582A3	666	1.00	-	1	20	1.80	-	
		582A5	-	1.00	-	1	20	1.90	-	
		582A10	668	1.00	-	1	20	1.90	-	
		582A14	669	1.00	-	1	20	1.90	-	
		582A15	670	1.00	-	1	20	1.90	-	
		582A92	673	1.00	-	1	20	1.80	-	
		582A-716	-	1.00	-	1	20	1.90	-	
		582A-BLK	-	1.00	-	1	20	2.50	-	
		582A-W	-	1.00	-	1	20	2.50	-	
		SP582A3	666	42.50	Yes	25	25	-	43.80	
		SP582A5	-	42.50	Yes	25	25	-	46.60	
		SP582A14	669	42.50	Yes	25	25	-	46.60	
		SP582A92	673	42.50	Yes	25	25	-	43.80	
		SP582A-W	-	35.00	Yes	25	25	-	64.10	
		Brass	582B3	605	1.20	-	1	10	7.30	-
			582B4	606	1.20	-	1	10	8.10	-
	582B5		609	1.20	-	1	10	8.10	-	
	582B10		612	1.20	-	1	10	8.70	-	
	582B10B		613	1.20	-	1	10	8.70	-	
	582B15		619	1.20	-	1	10	9.00	-	
	582B26		625	1.20	-	1	10	8.70	-	
	582B26D		626	1.20	-	1	10	8.70	-	
	582B-716		-	1.20	-	1	10	9.00	-	
	SC582B-609		609	-	Yes	5	5	-	47.20	
	SC582B-619		619	-	Yes	5	5	-	47.20	
	SC582B-716		-	-	Yes	5	5	-	47.20	
	SP582B26		625	12.00	Yes	10	10	-	91.10	
	SPS582B-605		605	-	Yes	25	25	-	189.50	
	SPS582B-609		609	-	Yes	25	25	-	236.20	
	SPS582B-619		619	-	Yes	25	25	-	236.20	
	SPS582B-620		620	-	Yes	25	25	-	236.20	
	SPS582B-716	-	-	Yes	25	25	-	236.20		
	Zinc **	582Z-619E	-	4.70	-	1	20	4.90	-	
585/586 Closet Pole Socket 	Steel	SP585F3	632	50.00	Yes	25	25	-	37.90	
	Plastic	SP586P	-	32.00	Yes	20	20	-	23.30	
601 Mail Slot Sleeve 	Brass	60113/4 IN	630	0.40	-	1	1	18.60	-	

** Zinc substrate, narrow brass.

Bold pricing indicates item is in stock and available for **Fast Track** and **ProXpress**





HINGES
 CONTINUOUS HINGES
 PIVOTS
 Numerical 1-059
 Numerical 59-437
 Numerical 438-1021
 Numerical 1152-8190
 Numerical 8200-9340

HINGES



CONTINUOUS
HINGES

PIVOTS

Numerical
1-059Numerical
59-437Numerical
438-1021Numerical
1152-8190Numerical
8200-9340





MODEL	SUBSTRATE	MODEL NUMBER	BHMA FINISH	WEIGHT	MUST BE ORDERED IN MULTIPLE QTY	MULTIPLE QTY	PACKED PER BOX	LIST PRICE	
								EACH	PACKAGE
620 Letter Box Plate Magazine Open Back Plate Spring-Loaded Front Plate 	Brass	620B3	605	1.50	-	1	1	\$76.40	-
		620B5	609	1.50	-	1	1	94.20	-
		620B15	619	1.50	-	1	1	91.60	-
		620B26	625	1.50	-	1	1	91.60	-
		620B26D	626	1.50	-	1	1	91.60	-
		620B-716	-	3.30	-	1	1	91.60	-
		SC620B3	605	6.60	Yes	2	2	-	\$157.70
		SC620B-619	619	6.60	Yes	2	2	-	193.50
	SC620B-716	-	6.60	Yes	2	2	-	193.50	
620 Sex Bolt PKG	Aluminum	620PA28	628	0.60	-	1	1	47.70	-
		09-355-605	605	-	-	1	1	10.40	-
		09-355-613	613	-	-	1	1	12.70	-
STK685 Double Acting Strike Custom Made Specify Jamb width when ordering	Brass	STK685 US3	605	-	-	1	-	269.50	-
		STK685 US4	606	-	-	1	-	269.50	-
		STK685 US10	612	-	-	1	-	269.50	-
		STK685 US10B	613	-	-	1	-	269.50	-
		STK685 US26	625	-	-	1	-	269.50	-
		STK685 US26D	626	-	-	1	-	269.50	-
STK685L Double Acting Strike, Custom Made Specify Dimple Location and Jamb Width when ordering	Brass	STK685L US3	605	-	-	1	-	269.50	-
		STK685L US4	606	-	-	1	-	269.50	-
		STK685L US10	612	-	-	1	-	269.50	-
		STK685L US10B	613	-	-	1	-	269.50	-
		STK685L US26	625	-	-	1	-	269.50	-
		STK685L US26D	626	-	-	1	-	269.50	-
U696 Door Viewer, 150° UL Listed 90 Min	Brass	U696B4	606	0.50	-	1	10	16.00	-
		U696B10B	613	0.50	-	1	10	16.00	-
		U696B26D	626	0.50	-	1	10	16.00	-
696-700 Viewer Cover	Brass	890312606	606	-	-	1	1	1.80	-
		890312613	613	-	-	1	1	1.80	-
		890312626	626	-	-	1	1	1.80	-
696-700 Viewer Extension	Brass	890314626	626	-	-	1	1	2.70	-
698 Door Viewer, 190° For Doors 1-3/8" to 2-1/8" U = UL Listed 90 Min P = Plastic Lens 	Brass	698B3	605	0.80	-	1	10	18.80	-
		698B26D	626	0.80	-	1	10	18.80	-
		698P-B716	-	0.80	-	1	10	18.80	-
		U698B3	605	0.80	-	1	10	22.50	-
		U698B26D	626	0.80	-	1	10	22.50	-
		SC698P-B619	619	-	Yes	5	5	-	108.00
		890311605	605	-	-	1	1	2.30	-
698 Viewer Cover	Brass	890311626	626	-	-	1	1	2.30	-
		890311716	716	-	-	1	1	2.30	-
		890313626	626	-	-	1	1	3.70	-
700 Door Viewer, 120° For Doors 1-3/8" to 2-1/16" U = UL Listed 90 Min 	Brass	700B4	606	0.50	-	1	10	8.00	-
		700B26D	626	0.50	-	1	10	8.00	-
		SC700P-B605	605	2.50	Yes	5	5	-	40.80
		U700B4	606	0.50	-	1	10	10.90	-
		U700B10B	613	0.50	-	1	10	10.90	-
		U700B26D	626	0.50	-	1	10	10.90	-
		09-241-606	606	-	-	1	1	0.30	-
700 Trim Washer	Brass	09-241-613	613	-	-	1	1	0.30	-
		09-241-626	626	-	-	1	1	0.30	-
		701B4	606	0.80	-	1	10	8.80	-
701 Door Viewer, 120° For Doors 2-1/8" to 2-5/8" U = UL Listed 90 Min 	Brass	701B10B	613	0.80	-	1	10	8.80	-
		701B26D	626	0.80	-	1	10	8.80	-
		U701B4	606	0.80	-	1	10	12.60	-
		U701B10B	613	0.80	-	1	10	12.60	-
		U701B26D	626	0.80	-	1	10	12.60	-
		U701B26D	626	0.80	-	1	10	12.60	-

Bold pricing indicates item is in stock and available for **Fast Track** and **ProXpress**

MODEL	SUBSTRATE	MODEL NUMBER	BHMA FINISH	WEIGHT	MUST BE ORDERED IN MULTIPLE QTY	MULTIPLE QTY	PACKED PER BOX	LIST PRICE	
								EACH	PACKAGE
VR810DT/VR814DT Vandal Resistant Trim Use w/Falcon XX, 18 and 25 Series Exit Devices	Stainless	VR810-DT US32D	630	-	-	1	1	\$264.60	-
		VR814-DT US32D	630	-	-	1	1	264.60	-
VR810NL/VR814NL Vandal Resistant Trim Use w/Falcon XX, and 18 Series Rim Exit Devices	Stainless	VR810-NL RHR US32D	630	-	-	1	1	264.60	-
		VR810-NL LHR US32D	630	-	-	1	1	264.60	-
		VR814-NL RHR US32D	630	-	-	1	1	264.60	-
		VR814-NL LHR US32D	630	-	-	1	1	264.60	-
VR810NL-V/VR814NL-V Vandal Resistant Trim Use w/ Falcon XX-V, and w/ 25-R (Rim) and 25-V (surface vertical) devices	Stainless	VR810-NL-V US32D	630	-	-	1	1	264.60	-
		VR814-NL-V US32D	630	-	-	1	1	264.60	-
AS895 Applied Stop 	Brass	AS895 US3	605	-	-	1	1	51.00	-
		AS895 US4	606	-	-	1	1	46.90	-
		AS895 US10	612	-	-	1	1	47.50	-
		AS895 US10B	613	-	-	1	1	51.00	-
		AS895 US26	625	-	-	1	1	51.00	-
		AS895 US26D	626	-	-	1	1	51.00	-
VR900/VR904 Vandal Resistant Trim Use w/Mortise Locks Outswing Doors	Stainless	VR900 LHR US32D	630	-	-	1	1	264.60	-
		VR900 RHR US32D	630	-	-	1	1	264.60	-
		VR904 LHR US32D	630	-	-	1	1	264.60	-
		VR904 RHR US32D	630	-	-	1	1	264.60	-
VR900LLP/VR904LLP Vandal Resistant Trim Use w/Mortise Locks Inswing Doors LLP = Less Lock Protectors	Stainless	VR900-LLP LH US32D	630	-	-	1	1	264.60	-
		VR900-LLP RH US32D	630	-	-	1	1	264.60	-
		VR904-LLP LH US32D	630	-	-	1	1	264.60	-
		VR904-LLP RH US32D	630	-	-	1	1	264.60	-
VR910DT/VR914DT Vandal Resistant Trim Use w/Von Duprin 98/99 Series Rim and Verticle Exit Devices	Stainless	VR910-DT US32D	630	-	-	1	1	264.60	-
		VR914-DT US32D	630	-	-	1	1	264.60	-
VR910NL/VR914NL Vandal Resistant Trim Use w/Von Duprin 98/99 Series Rim and Verticle Exit Devices	Stainless	VR910-NL US32D	630	-	-	1	1	264.60	-
		VR914-NL US32D	630	-	-	1	1	264.60	-
VR910M-DT/VR914M-DT Vandal Resistant Trim Use w/Von Duprin 98/9975 Series Mortise Exit Devices	Stainless	VR910M-DT US32D	630	-	-	1	1	264.60	-
		VR914M-DT US32D	630	-	-	1	1	264.60	-
VR910M-NL/VR914M-NL Vandal Resistant Trim Use w/Von Duprin 98/9975 Series Mortise Exit Devices	Stainless	VR910M-NL LH US32D	630	-	-	1	1	264.60	-
		VR910M-NL RH US32D	630	-	-	1	1	264.60	-
		VR914M-NL LH US32D	630	-	-	1	1	264.60	-
		VR914M-NL RH US32D	630	-	-	1	1	264.60	-
919 Flush Pull, Oval 4-23/32" High X 1-19/22" Wide x 15/32" Deep 	Brass	919-605	605	-	-	1	2	82.80	-
		919-613	613	-	-	1	2	86.20	-
		919-626	626	-	-	1	2	66.70	-
950 Flush Pull, Rectangular 3-3/4" High X 2-7/8" Wide x 11/16" Deep 	Brass	950-605	605	-	-	1	2	74.70	-
		950-613	613	-	-	1	2	78.10	-
		950-626	626	-	-	1	2	59.80	-





Bold pricing indicates item is in stock and available for **Fast Track** and **ProXpress**

HINGES
 CONTINUOUS HINGES
 PIVOTS
 Numerical 1-059
 Numerical 59-437
 Numerical 438-1021
 Numerical 1152-8190
 Numerical 8200-9340

MODEL	SUBSTRATE	MODEL NUMBER	BHMA FINISH	WEIGHT	MUST BE ORDERED IN MULTIPLE QTY	MULTIPLE QTY	PACKED PER BOX	LIST PRICE		
								EACH	PACKAGE	
955 Flush Pull, Rectangular 4-5/8" High X 3-29/32" Wide x 1-3/16" Deep 	Brass	955-605	605	-	-	1	2	\$120.60	-	
		955-613	613	-	-	1	2	126.50	-	
		955-626	626	-	-	1	2	96.60	-	
960 Flush Pull, Rectangular 3-1/16" High X 1-7/8" Wide x 9/16" Deep 	Brass	960-605	605	-	-	1	2	33.40	-	
		960-613	613	-	-	1	2	34.50	-	
		960-626	626	-	-	1	2	26.40	-	
962 Flush Pull, Rectangular Black Inset 3-15/16" High X 2-7/16" Wide x 19/32" Deep	Brass	962-605	605	-	-	1	2	69.00	-	
		962-613	613	-	-	1	2	71.20	-	
		962-626	626	-	-	1	2	55.10	-	
990 Sliding Door Pull Doors 1-1/8" to 1-1/2" 	Aluminum	990A3	666	-	-	1	10	7.30	-	
		990A5	-	-	-	1	10	7.30	-	
		990A14	669	-	-	1	10	7.30	-	
		990A15	670	-	-	1	10	8.10	-	
		990A26D	702	-	-	1	10	7.30	-	
		990A-716	-	-	-	1	10	7.30	-	
	Brass	990B3	605	1.90	-	-	1	5	11.10	-
		990B-613	613	1.90	-	-	1	5	12.80	-
		990B-619	619	1.90	-	-	1	5	12.80	-
		990B26	625	1.90	-	-	1	5	12.80	-
		990B-716	-	1.90	-	-	1	5	12.80	-
		SC990B-605	605	-	-	Yes	5	5	-	\$50.90
		SC990B-609	609	-	-	Yes	5	5	-	60.60
		SC990B-619	619	-	-	Yes	5	5	-	60.60
SC990B-620	620	-	-	Yes	5	5	-	60.60		
SC990B-716	-	-	-	Yes	5	5	-	60.60		
991 Sliding Door Pull Doors 1-1/8" to 1-1/2" Thumb Turn on One Side Emergency Turn on Other Side 	Aluminum	991A3	666	-	-	1	10	8.50	-	
		991A5	-	-	-	1	10	8.50	-	
		991A14	669	-	-	1	10	9.90	-	
		991A15	670	-	-	1	10	9.90	-	
		991A26D	702	-	-	1	10	9.90	-	
		991A-716	-	-	-	1	10	9.90	-	
	Brass	991B3	605	2.30	-	-	1	5	15.60	-
		991B26	625	2.30	-	-	1	5	17.80	-
		991B-613	613	2.30	-	-	1	5	17.80	-
		991B-619	619	2.30	-	-	1	5	17.80	-
		991B-716	-	2.30	-	-	1	5	17.80	-
		CP991B26	625	2.80	-	Yes	5	5	-	91.60
		SC991B-605	605	-	-	Yes	5	5	-	82.90
		SC991B-609	609	-	-	Yes	5	5	-	91.60
SC991B-619	619	-	-	Yes	5	5	-	91.60		
SC991B-620	620	-	-	Yes	5	5	-	91.60		
SC991B-716	-	-	-	Yes	5	5	-	91.60		

* Note: SC3P (3 pack hinges) must be ordered in multiples of 3. Qty of 3 equals 9 hinges.

Bold pricing indicates item is in stock and available for **Fast Track** and **ProXpress**

MODEL	SUBSTRATE	MODEL NUMBER	BHMA FINISH	WEIGHT	MUST BE ORDERED IN MULTIPLE QTY	MULTIPLE QTY	PACKED PER BOX	LIST PRICE	
								EACH	PACKAGE
RL1152 Combination Roller Latch/Applied Stop 	Brass	RL1152 US3	605	-	-	-	-	\$130.10	-
		RL1152 US4	606	-	-	-	-	123.30	-
		RL1152 US10	612	-	-	-	-	123.30	-
		RL1152 US10B	613	-	-	-	-	130.10	-
		RL1152 US26	625	-	-	-	-	130.10	-
		RL1152 US26D	626	-	-	-	-	127.30	-
FS1153/FS1154 Plunger Type Door Holder 	Aluminum	FS1153 US28	628	-	-	-	-	45.60	-
	Brass	FS1154 US3	605	-	-	-	-	82.20	-
		FS1154 US4	606	-	-	-	-	82.20	-
		FS1154 US10	612	-	-	-	-	82.20	-
		FS1154 US10B	613	-	-	-	-	82.20	-
		FS1154 US26	625	-	-	-	-	82.20	-
FS1154 US26D	626	-	-	-	-	82.20	-		
SB1600M1 Handle Up 1 1/2" Steel Bolt B-Packed w/Mortise Strikes T-Packed w/Universal Strikes L-Locking Version* UL Listed 	Steel	SB1600M1-B SP28	689	-	-	-	-	123.90	-
		SB1600M1-B SP10	691	-	-	-	-	131.00	-
		SB1600M1-B SPBLK	693	-	-	-	-	131.00	-
		SB1600M1-B SP313	695	-	-	-	-	123.90	-
		SB1600M1-B SP4	706	-	-	-	-	131.00	-
		SB1600M1-T SP10	691	-	-	-	-	131.00	-
		SB1600M1-T SP28	689	-	-	-	-	123.90	-
		SB1600M1-T SP313	695	-	-	-	-	123.90	-
		SB1600M1-T SPBLK	693	-	-	-	-	131.00	-
		SB1600M1-T SP4	706	-	-	-	-	131.00	-
		SB1600M1-BL SP10	691	-	-	-	-	174.10	-
		SB1600M1-BL SP28	689	-	-	-	-	180.50	-
		SB1600M1-BL SP313	695	-	-	-	-	180.50	-
		SB1600M1-BL SPBLK	693	-	-	-	-	181.20	-
		SB1600M1-BL SP4	706	-	-	-	-	174.10	-
		SB1600M1-TL SP10	691	-	-	-	-	181.20	-
		SB1600M1-TL SP28	689	-	-	-	-	181.20	-
		SB1600M1-TL SP313	695	-	-	-	-	174.10	-
SB1600M1-TL SPBLK	693	-	-	-	-	174.10	-		
SB1600M1-TL SP4	706	-	-	-	-	181.20	-		
SB1600M2 Handle Up 1 1/2" Steel Bolt B-Packed w/Mortise Strikes T-Packed w/Universal Strikes L-Locking Version* UL Listed 	Steel	SB1600M2-B SP4	706	-	-	-	-	131.00	-
		SB1600M2-B SP10	691	-	-	-	-	131.00	-
		SB1600M2-B SP28	689	-	-	-	-	123.90	-
		SB1600M2-B SP313	695	-	-	-	-	123.90	-
		SB1600M2-B SPBLK	693	-	-	-	-	131.00	-
		SB1600M2-BL SP4	706	-	-	-	-	181.20	-
		SB1600M2-T SP10	691	-	-	-	-	131.00	-
		SB1600M2-T SP28	689	-	-	-	-	123.90	-
		SB1600M2-T SP313	695	-	-	-	-	123.90	-
		SB1600M2-T SPBLK	693	-	-	-	-	131.00	-
		SB1600M2-T SP4	706	-	-	-	-	131.00	-
		SB1600M2-BL 1SP10	691	-	-	-	-	181.20	-
		SB1600M2-BL SP28	689	-	-	-	-	180.50	-
		SB1600M2-BL SP313	695	-	-	-	-	180.50	-
		SB1600M2-BL SPBLK	693	-	-	-	-	181.20	-
		SB1600M2-TL SP4	706	-	-	-	-	181.20	-
		SB1600M2-TL SP10	691	-	-	-	-	181.20	-
		SB1600M2-TL SP28	689	-	-	-	-	180.50	-
SB1600M2-TL SP313	695	-	-	-	-	180.50	-		
SB1600M2-TL SPBLK	693	-	-	-	-	181.20	-		

* Lock default code = 1289. Alternative Codes: 1360/1390/1395.

Bold pricing indicates item is in stock and available for **Fast Track** and **ProXpress**



HINGES
 CONTINUOUS HINGES
 PIVOTS
 Numerical 1-059
 Numerical 59-437
 Numerical 438-1021
 Numerical 1152-8190
 Numerical 8200-9340

HINGES

CONTINUOUS
HINGES

PIVOTS

Numerical
1-059Numerical
59-437Numerical
438-1021Numerical
1152-8190Numerical
8200-9340

MODEL	SUBSTRATE	MODEL NUMBER	BHMA FINISH	WEIGHT	MUST BE ORDERED IN MULTIPLE QTY	MULTIPLE QTY	PACKED PER BOX	LIST PRICE	
								EACH	PACKAGE
SB1630 8" Steel Bolts B-Packed w/Mortise Strikes T-Packed w/Universal Strikes L-Locking Version* UL Listed 	Steel	SB1630-B US2G	603	-	-	-	-	\$41.90	-
		SB1630-B US10B	640	-	-	-	-	96.50	-
		SB1630-B US26D	652	-	-	-	-	59.70	-
		SB1630-T US2G	603	-	-	-	-	46.50	-
		SB1630-T US10B	640	-	-	-	-	101.20	-
		SB1630-T US26D	652	-	-	-	-	65.60	-
		SB1630-BL US2G	603	-	-	-	-	90.60	-
		SB1630-BL US10B	640	-	-	-	-	130.00	-
		SB1630-BL US26D	652	-	-	-	-	108.50	-
		SB1630-TL US2G	603	-	-	-	-	75.20	-
		SB1630-TL US10B	640	-	-	-	-	137.20	-
		SB1630-TL US26D	652	-	-	-	-	118.00	-
		SB1630-TB US2G	603	-	-	-	-	55.10	-
		SB1630-TB US10B	640	-	-	-	-	114.40	-
		SB1630-TB US26D	652	-	-	-	-	76.30	-
		SB1630-TBL US2G	603	-	-	-	-	87.00	-
SB1630-TBL US10B	640	-	-	-	-	147.70	-		
SB1630-TBL US26D	652	-	-	-	-	130.00	-		
SB1640 8" Steel Bolts B-Packed w/Mortise Strikes T-Packed w/Universal Strikes L-Locking Version* 	Brass	SB1640-B US3	605	-	-	-	-	118.00	-
		SB1640-B US10B	613	-	-	-	-	118.00	-
		SB1640-B US26D	626	-	-	-	-	106.20	-
		SB1640-T US3	605	-	-	-	-	123.90	-
		SB1640-T US10B	613	-	-	-	-	123.90	-
		SB1640-T US26D	626	-	-	-	-	114.40	-
		SB1640-BL US3	605	-	-	-	-	157.40	-
		SB1640-BL US10B	613	-	-	-	-	157.40	-
		SB1640-BL US26D	626	-	-	-	-	145.50	-
		SB1640-TL US3	605	-	-	-	-	165.70	-
SB1640-TL US10B	613	-	-	-	-	165.70	-		
SB1640-TL US26D	626	-	-	-	-	152.60	-		

* Lock default code = 1289. Alternative Codes: 1360/1390/1395.



Bold pricing indicates item is in stock and available for **Fast Track** and **ProXpress**

MODEL	SUBSTRATE	MODEL NUMBER	BHMA FINISH	WEIGHT	MUST BE ORDERED IN MULTIPLE QTY	MULTIPLE QTY	PACKED PER BOX	LIST PRICE		
								EACH	PACKAGE	
30X6 Classic House Number 4" 143	Brass	0	SC2-3006-605	605	-	Yes	5	5	-	\$42.50
			SC2-3006-619	619	-	Yes	5	5	-	54.30
			SC2-3006-716	-	-	Yes	5	5	-	54.30
		1	SC2-3016-605	605	-	Yes	5	5	-	42.50
			SC2-3016-619	619	-	Yes	5	5	-	54.30
			SC2-3016-716	-	-	Yes	5	5	-	54.30
		2	SC2-3026-605	605	-	Yes	5	5	-	42.50
			SC2-3026-619	619	-	Yes	5	5	-	54.30
			SC2-3026-716	-	-	Yes	5	5	-	54.30
		3	SC2-3036-605	605	-	Yes	5	5	-	42.50
			SC2-3036-619	619	-	Yes	5	5	-	54.30
			SC2-3036-716	-	-	Yes	5	5	-	54.30
		4	SC2-3046-605	605	-	Yes	5	5	-	42.50
			SC2-3046-619	619	-	Yes	5	5	-	54.30
			SC2-3046-716	-	-	Yes	5	5	-	54.30
		5	SC2-3056-605	605	-	Yes	5	5	-	42.50
			SC2-3056-619	619	-	Yes	5	5	-	54.30
			SC2-3056-716	-	-	Yes	5	5	-	54.30
		6	SC2-3066-605	605	-	Yes	5	5	-	42.50
			SC2-3066-619	619	-	Yes	5	5	-	54.30
			SC2-3066-716	-	-	Yes	5	5	-	54.30
		7	SC2-3076-605	605	-	Yes	5	5	-	42.50
			SC2-3076-619	619	-	Yes	5	5	-	54.30
			SC2-3076-716	-	-	Yes	5	5	-	54.30
		8	SC2-3086-605	605	-	Yes	5	5	-	42.50
			SC2-3086-619	619	-	Yes	5	5	-	54.30
			SC2-3086-716	-	-	Yes	5	5	-	54.30
		9	SC2-3096-605	605	-	Yes	5	5	-	42.50
			SC2-3096-619	619	-	Yes	5	5	-	54.30
			SC2-3096-716	-	-	Yes	5	5	-	54.30

HINGES
 CONTINUOUS HINGES
 PIVOTS
 Numerical 1-059
 Numerical 59-437
 Numerical 438-1021
 Numerical 1152-8190
 Numerical 8200-9340

*Bold pricing indicates item is in stock and available for **Fast Track** and **ProXpress***

HINGES
 CONTINUOUS HINGES
 PIVOTS
 Numerical 1-059
 Numerical 59-437
 Numerical 438-1021
 Numerical 1152-8190
 Numerical 8200-9340

MODEL	SUBSTRATE	MODEL NUMBER	VIEW NUMBER & FINISH	BHMA FINISH	WEIGHT	MUST BE			LIST PRICE	
						ORDERED IN	MULTIPLE QTY	PACKED PER BOX	EACH	PACKAGE
3107 Door Knocker 	Brass	SC2-3107B-619	-	619	4	Yes	2	2	-	\$123.70
3125 Door Knocker 	Brass	02-3125-605	-	605	1	-	-	1	\$26.70	-
		02-3125-609	-	609	1	-	-	1	31.50	-
		02-3125-619	-	619	1	-	-	1	31.50	-
		02-3125-625	-	625	1	-	-	1	31.50	-
		02-3125-626	-	626	1	-	-	1	26.70	-
		02-3125-716	-	-	1	-	-	1	31.50	-
		SC2-3125-609	-	609	-	Yes	5	5	-	166.20
		SC2-3125-716	-	-	-	Yes	5	5	-	166.20
31251/31252 Knocker/Viewer Available w/UL Viewer Only 	Brass	02-31251U-605	U700 w 606 viewer	605	-	-	-	1	38.90	-
		02-31251U-626	U700 w 626 viewer	626	-	-	-	1	44.30	-
		02-31251U-716	U700 w 10B viewer	-	-	-	-	1	36.80	-
		02-31252U-605	U701 w 606 viewer	605	-	-	-	1	40.50	-
		02-31252U-626	U701 w 626 viewer	626	-	-	-	1	46.20	-
		02-31252U-716	U701 w 10B viewer	-	-	-	-	1	38.60	-

Bold pricing indicates item is in stock and available for **Fast Track** and **ProXpress**

8100/8300/9100/9200 Series Pulls

8169/8181/8281/8189/8312/8320/8371/8372/8373/8700/8800/8848/8975 - Decorative Series

Mounting Methods

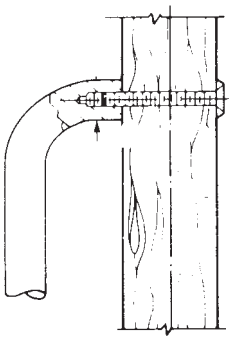
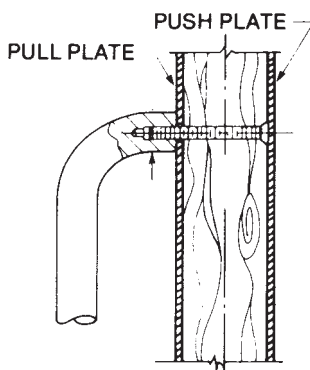
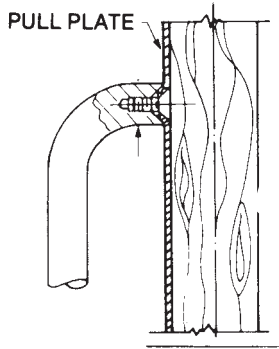
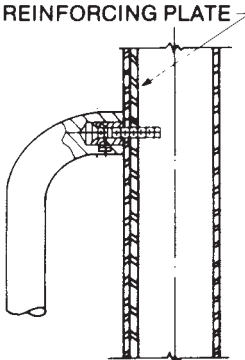
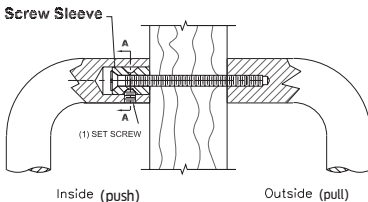
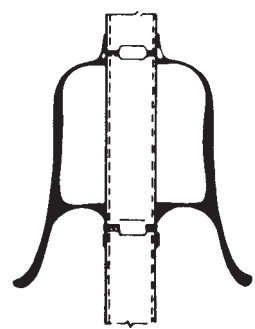
<p>Type Standard Mount</p>  <p>Standard Mounting</p>	<p>Type F Mount</p>  <p>Wood Doors Concealed Pull Mounting With Push Plate</p>	<p>Type G Mount</p>  <p>Concealed Pull Plate Mounting</p>
<p>Type L Mount</p>  <p>Reinforced Hollow Metal Door Concealed Pull Mounting</p>	<p>Type J or N Mount</p>  <p>Back to Back "Two-Anchor" Wood or Metal Door</p>	<p>Type K Mount</p>  <p>Back to Back Pull Mounting</p>

HINGES
CONTINUOUS HINGES
PIVOTS
Numerical 1-059
Numerical 59-437
Numerical 438-1021
Numerical 1152-8190
Numerical 8200-9340

*Bold pricing indicates item is in stock and available for **Fast Track** and **ProXpress***

8100/8300/9100/9200 Series Pulls

8169/8181/8281/8189/8312/8320/8371/8372/8373/8700/8800/8848/8975 - Decorative Series

Mounting Methods

HINGES
 CONTINUOUS HINGES
 PIVOTS
 Numerical 1-059
 Numerical 59-437
 Numerical 438-1021
 Numerical 1152-8190
 Numerical 8200-9340

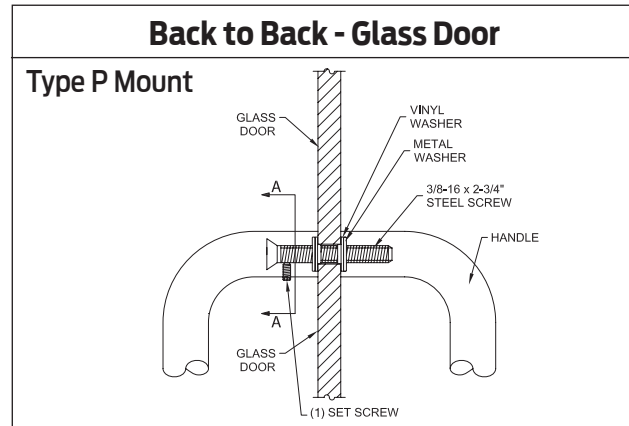
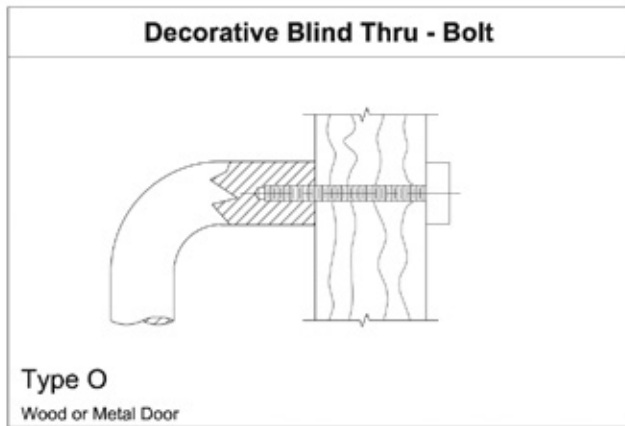

*Bold pricing indicates item is in stock and available for **Fast Track** and **ProXpress***

8100/8200/8300/9100/9200 - Series

8169/8181/8281/8189/8312/8320/8371/8372/8373/8700/8800/8848/8975 - Decorative Series

Special Pricing Information

- Through bolt fasteners are for standard 1-3/4" thick doors.
- Specify door thickness if other than standard.
- All screws are furnished standard as Phillips Head Drive.
- For fasteners other than shown contact our Customer Service Department for availability.

Suffix		List Add		
Optional Mounting Types:	No Suffix Req'd	Standard (Provided with all single pulls unless other mount noted.) 8102HD, 8103HD, 8103EZHD, 8105, 8111-5, 8145EZHD, 8190HD, 8190EZHD, 8302, 8303, 8305, 8311, 9100HD, 9264, 9266 8169, 8181, 8281, 8189, 8312, 8320, 8371, 8372, 8373, 8700, 8800, 8848, 8975	No Additional Charge	
	A	Concealed (One side, Aluminum) 8103HD, 8103EZHD, 8145EZHD, 8190HD, 8190EZHD, 8303, 9100HD, 9264, 9266 8169, 8181, 8281, 8189, 8312, 8320, 8371, 8848, 8975	17.00	
	F	Countersunk Thru Bolt 8102HD, 8103HD, 8103EZHD, 8105, 8111-5, 8145EZHD, 8190HD, 8190EZHD, 8302, 8303, 8305, 8311, 9100HD 8169, 8181, 8281, 8189, 8312, 8320, 8371, 8372, 8373, 8700, 8800, 8848, 8975	No Additional Charge	
	G	Concealed Pull Plate 8102, 8103, 8111, 8300, 8302, 8303, 8311	No Additional Charge	
	I	Concealed (One Side, Wood Door) 8102HD, 8103HD, 8103EZHD, 8145EZHD, 8190HD, 8190EZHD, 8302, 8303, 9100HD, 9264, 9266 8169, 8181, 8281, 8189, 8312, 8320, 8371, 8372, 8373, 8700, 8800, 8848, 8975	12.00	
	J*	Back to Back (Wood/Hollow Metal - 3/4" Round and Flat) 8102HD, 8302 8372, 8373, 8700, 8800	24.00	
	K*	Back to Back (8121) 8121	8.00	
	L	Concealed (One Side, Hollow Metal) 8103HD, 8103EZHD, 8145EZHD, 8190HD, 8190EZHD, 8303, 9100HD, 9264, 9266 8169, 8181, 8281, 8189, 8312, 8320, 8371, 8372, 8373, 8700, 8800, 8848, 8975	17.00	
	N*	Back to Back (Wood/Hollow Metal - 1" Round) 8103HD, 8103EZHD, 8145EZHD, 8190HD, 8190EZHD, 8303, 9100HD, 9264, 9266 8169, 8181, 8281, 8189, 8312, 8320, 8371, 8848, 8975	24.00	
	NO	Push Bar and Pull - Back to Back & Decorative Blind Thru Bolt (Wood/Hollow Metal) 9100HD, 9103EZHD, 9145EZHD, 9190HD, 9190EZHD	36.00	
	NS	Push Bar and Pull - Back to Back & Standard (Wood/Hollow Metal) 9100HD, 9103EZHD, 9145EZHD, 9190HD, 9190EZHD	No Additional Charge	
	O	Decorative Blind Thru Bolt (Wood/Hollow Metal) 8103HD, 8103EZHD, 8145EZHD, 8190HD, 8190EZHD, 9100HD, 9264, 9266 8169, 8181, 8281, 8189, 8312, 8320, 8371, 8848, 8975	28.00	
	P*	Back to Back (1/2" Glass) 8103HD, 8103EZHD, 8145EZHD, 8190HD, 8190EZHD, 9100HD, 9264, 9266 8169, 8181, 8281, 8189, 8312, 8320, 8371, 8848, 8975	29.00	
	PQ	Push Bar and Pull - Back to Back and Decorative Blind Thru Bolt (1/2" Glass) 9100HD, 9103EZHD, 9145EZHD, 9190HD, 9190EZHD	61.00	
	Q	Decorative Blind Thru Bolt (1/2" Glass) 8103HD, 8103EZHD, 8145EZHD, 8190HD, 8190EZHD, 9100HD, 9264, 9266 8169, 8181, 8281, 8189, 8312, 8320, 8371, 8848, 8975	39.00	
	X	Security Thru Bolt with Std. Washer. 8103HD, 8103EZHD, 8145EZHD, 8190HD, 8190EZHD, 8303, 9100HD, 9264, 9266 8169, 8181, 8281, 8189, 8312, 8320, 8371, 8848, 8975	47.00 - 613/US10B 30.00 all other Finishes	
Prefix				
	*	PR	Order as pair with model numbers (e.g. - PR8103EZ)	Double the list price for single unit and add mounting price from above.
		SGL	Single pull model machined for back to back application.	Based on mounting
Model				
Optional Custom Lengths: (available in 1" increments, fractional increments available as engineered specials)	9100HD, 9103EZHD, 9145EZHD, 9190HD, 9190EZHD	For lengths <28"	Same as 28" List Price	
		For lengths >28" and <33"	Same as 33" List Price	
		For lengths >33"	8.00/additional inch	
		Fractional increments available as engineered specials. List Add in addition to custom length pricing	158.00 List Add	
Optional Finish	AM	Anti-microbial Coating - US26D or US32D finishes only	35.00	
Optional Cut-Outs:	CFC	Cut for cylinder on 8200/8300 Series Push or Pull Plates (1-1/4" diameter)	6.00	
	CFT	Cut for Thumbturn on 8200/8300 Series Push or Pull Plates (3/8" diameter)	7.00	
Plates ordered for cut-out for cylinder or thumbturn, cutout is positioned 2" from top and centered in the plate width, up to 4" wide plates. For plates over 4" in width, cut-out is located 2" from edge. Please specify Door Handing LH or RH when ordering plates wider than 4".				
Optional Plate:	Model	Description	List Add	
	8300	For plate pierced for Pull, order 8300 Series Specify Center to Center dimension (5-1/4", 6", 8", 10"), Finish, and Plate Size	(to 8200 list price) 2.50	

Bold pricing indicates item is in stock and available for **Fast Track** and **ProXpress**



HINGES
 CONTINUOUS HINGES
 PIVOTS
 Numerical 1-059
 Numerical 59-437
 Numerical 438-1021
 Numerical 1152-8190
 Numerical 8200-9340

HINGES
 CONTINUOUS HINGES
 PIVOTS
 Numerical 1-059
 Numerical 59-437
 Numerical 438-1021
 Numerical 1152-8190
 Numerical 8200-9340

MODEL	PULL CTC	SUBSTRATE	MODEL NUMBER	BHMA FINISH	WEIGHT	MUST BE ORDERED IN MULTIPLE QTY	MULTIPLE QTY	PACKED PER BOX	LIST PRICE	
									EACH	PACKAGE
8102HD Straight Door Pull 3/4" Round, 1-1/2" Clearance Antimicrobial Coating US26D-AM or US32D-AM available. See page 65 for optional mounting types and pricing.	6"	Brass	8102HD-6 US3	605	-	-	1	-	\$47.00	-
			8102HD-6 US4	606	-	-	1	-	47.00	-
			8102HD-6 US10	612	-	-	1	-	53.60	-
			8102HD-6 US10B	613	-	-	1	-	55.50	-
			8102HD-6 US15	619	-	-	1	-	55.50	-
			8102HD-6 US26	625	-	-	1	-	52.90	-
			8102HD-6 US26D	626	-	-	1	-	47.00	-
	Aluminum	8102HD-6 US28	628	-	-	1	-	18.80	-	
	Stainless	8102HD-6 US32D	630	-	-	1	-	28.40	-	
	8"	Brass	8102HD-8 US3	605	-	-	1	-	52.90	-
			8102HD-8 US4	606	-	-	1	-	52.90	-
			8102HD-8 US10	612	-	-	1	-	60.70	-
			8102HD-8 US10B	613	-	-	1	-	62.70	-
			8102HD-8 US15	619	-	-	1	-	62.70	-
			8102HD-8 US26	625	-	-	1	-	58.80	-
			8102HD-8 US26D	626	-	-	1	-	52.90	-
	Aluminum	8102HD-8 US28	628	-	-	1	-	19.50	-	
	Stainless	8102HD-8 US32D	630	-	-	1	-	32.10	-	
	10"	Brass	8102HD-0 US3	605	-	-	1	-	61.80	-
			8102HD-0 US4	606	-	-	1	-	61.80	-
			8102HD-0 US10	612	-	-	1	-	71.20	-
8102HD-0 US10B			613	-	-	1	-	73.10	-	
8102HD-0 US15			619	-	-	1	-	73.10	-	
8102HD-0 US26			625	-	-	1	-	60.30	-	
8102HD-0 US26D			626	-	-	1	-	60.70	-	
Aluminum	8102HD-0 US28	628	-	-	1	-	20.80	-		
Stainless	8102HD-0 US32D	630	-	-	1	-	37.60	-		
8103HD Straight Door Pull 1" Round, 1-1/2" Clearance Antimicrobial Coating US26D-AM or US32D-AM available. See page 65 for optional mounting types and pricing.	8"	Brass	8103HD-8 US3	605	-	-	1	-	93.90	-
			8103HD-8 US4	606	-	-	1	-	93.90	-
			8103HD-8 US10	612	-	-	1	-	105.70	-
			8103HD-8 US10B	613	-	-	1	-	109.50	-
			8103HD-8 US15	619	-	-	1	-	109.50	-
			8103HD-8 US26	625	-	-	1	-	100.00	-
			8103HD-8 US26D	626	-	-	1	-	94.30	-
	Aluminum	8103HD-8 US28	628	-	-	1	-	27.20	-	
	Stainless	8103HD-8 US32	629	-	-	1	-	67.60	-	
		8103HD-8 US32D	630	-	-	1	-	55.80	-	
	10"	Brass	8103HD-0 US3	605	-	-	1	-	103.70	-
			8103HD-0 US4	606	-	-	1	-	103.70	-
			8103HD-0 US10	612	-	-	1	-	119.30	-
			8103HD-0 US10B	613	-	-	1	-	119.30	-
			8103HD-0 US15	619	-	-	1	-	123.40	-
8103HD-0 US26			625	-	-	1	-	109.50	-	
8103HD-0 US26D			626	-	-	1	-	103.70	-	
Aluminum		8103HD-0 US28	628	-	-	1	-	28.60	-	
Stainless	8103HD-0 US32	629	-	-	1	-	75.00	-		
	8103HD-0 US32D	630	-	-	1	-	62.60	-		

Continued on next page.



Bold pricing indicates item is in stock and available for **Fast Track** and **ProXpress**

MODEL	PULL CTC	SUBSTRATE	MODEL NUMBER	BHMA FINISH	WEIGHT	MUST BE ORDERED IN MULTIPLE QTY	MULTIPLE QTY	PACKED PER BOX	LIST PRICE		
									EACH	PACKAGE	
8103HD Straight Door Pull 1" Round, 1-1/2" Clearance <i>Continued from previous page.</i> 	12"	Brass	8103HD-2 US3	605	-	-	1	-	\$113.40	-	
			8103HD-2 US4	606	-	-	1	-	113.40	-	
			8103HD-2 US10	612	-	-	1	-	132.90	-	
			8103HD-2 US10B	613	-	-	1	-	135.10	-	
			8103HD-2 US15	619	-	-	1	-	135.10	-	
			8103HD-2 US26	625	-	-	1	-	120.50	-	
		8103HD-2 US26D	626	-	-	1	-	115.50	-		
		Aluminum	8103HD-2 US28	628	-	-	1	-	30.10	-	
		Stainless	8103HD-2 US32	629	-	-	1	-	82.30	-	
			8103HD-2 US32D	630	-	-	1	-	72.10	-	
8103EZHD Straight Door Pull 1" Round, 2-1/2" Clearance Antimicrobial Coating US26D-AM or US32D-AM available. See page 65 for optional mounting types and pricing. 	8"	Brass	8103EZHD-8 US3	605	-	-	1	-	102.20	-	
			8103EZHD-8 US4	606	-	-	1	-	102.20	-	
			8103EZHD-8 US10	612	-	-	1	-	113.70	-	
			8103EZHD-8 US10B	613	-	-	1	-	117.50	-	
			8103EZHD-8 US15	619	-	-	1	-	117.50	-	
			8103EZHD-8 US26	625	-	-	1	-	107.80	-	
		8103EZHD-8 US26D	626	-	-	1	-	102.40	-		
		Aluminum	8103EZHD-8 US28	628	-	-	1	-	36.50	-	
		316 Stainless	8103EZHD-8 US32	629-316	-	-	1	-	89.60	-	
			8103EZHD-8 US32D	630-316	-	-	1	-	78.10	-	
		10"	Brass	8103EZHD-0 US3	605	-	-	1	-	111.80	-
				8103EZHD-0 US4	606	-	-	1	-	111.80	-
	8103EZHD-0 US10			612	-	-	1	-	127.40	-	
	8103EZHD-0 US10B			613	-	-	1	-	131.30	-	
	8103EZHD-0 US15			619	-	-	1	-	131.30	-	
	8103EZHD-0 US26			625	-	-	1	-	117.50	-	
	8103EZHD-0 US26D		626	-	-	1	-	111.80	-		
	Aluminum		8103EZHD-0 US28	628	-	-	1	-	38.20	-	
	316 Stainless		8103EZHD-0 32-316	629-316	-	-	1	-	98.30	-	
			8103EZHD-0 32D-316	630-316	-	-	1	-	86.50	-	
	12"		Brass	8103EZHD-2 US3	605	-	-	1	-	121.40	-
				8103EZHD-2 US4	606	-	-	1	-	121.40	-
		8103EZHD-2 US10		612	-	-	1	-	141.10	-	
		8103EZHD-2 US10B		613	-	-	1	-	143.10	-	
8103EZHD-2 US15		619		-	-	1	-	143.10	-		
8103EZHD-2 US26		625		-	-	1	-	128.60	-		
8103EZHD-2 US26D		626	-	-	1	-	123.60	-			
Aluminum		8103EZHD-2 US28	628	-	-	1	-	39.80	-		
316 Stainless		8103EZHD-2 32-316	629-316	-	-	1	-	106.90	-		
		8103EZHD-2 32D-316	630-316	-	-	1	-	94.80	-		
8105 Straight Door Pull 1" Flattened 1/2 Round, 1-1/2" Clearance Antimicrobial Coating US26D-AM or US32D-AM available. See page 65 for optional mounting types and pricing. 	6"	Brass	8105-6 US3	605	-	-	1	-	51.20	-	
			8105-6 US4	606	-	-	1	-	51.20	-	
			8105-6 US10	612	-	-	1	-	62.90	-	
			8105-6 US10B	613	-	-	1	-	64.60	-	
			8105-6 US15	619	-	-	1	-	64.60	-	
			8105-6 US26	625	-	-	1	-	51.60	-	
		8105-6 US26D	626	-	-	1	-	47.10	-		
		Aluminum	8105-6 US28	628	-	-	1	-	21.40	-	
		Stainless	8105-6 US32D	630	-	-	1	-	39.10	-	
		8"	Brass	8105-8 US3	605	-	-	1	-	79.60	-
	8105-8 US4			606	-	-	1	-	79.60	-	
	8105-8 US10			612	-	-	1	-	86.50	-	
	8105-8 US10B			613	-	-	1	-	86.50	-	
	8105-8 US15			619	-	-	1	-	86.50	-	
	8105-8 US26			625	-	-	1	-	83.00	-	
	8105-8 US26D		626	-	-	1	-	83.00	-		
	Aluminum		8105-8 US28	628	-	-	1	-	26.70	-	
	Stainless	8105-8 US32D	630	-	-	1	-	57.00	-		
	10"	Brass	8105-0 US3	605	-	-	1	-	86.50	-	
			8105-0 US4	606	-	-	1	-	86.50	-	
			8105-0 US10	612	-	-	1	-	96.80	-	
			8105-0 US10B	613	-	-	1	-	96.80	-	
			8105-0 US15	619	-	-	1	-	96.80	-	
			8105-0 US26	625	-	-	1	-	90.00	-	
8105-0 US26D		626	-	-	1	-	90.00	-			
Aluminum		8105-0 US28	628	-	-	1	-	27.60	-		
Stainless		8105-0 US32D	630	-	-	1	-	64.10	-		





Bold pricing indicates item is in stock and available for **Fast Track** and **ProXpress**

HINGES
 CONTINUOUS HINGES
 PIVOTS
 Numerical 1-059
 Numerical 59-437
 Numerical 438-1021
 Numerical 1152-8190
 Numerical 8200-9340

HINGES
 CONTINUOUS HINGES
 PIVOTS
 Numerical 1-059
 Numerical 59-437
 Numerical 438-1021
 Numerical 1152-8190
 Numerical 8200-9340

MODEL	PULL CTC	SUBSTRATE	MODEL NUMBER	BHMA FINISH	WEIGHT	MUST BE ORDERED IN MULTIPLE QTY	MULTIPLE QTY	PACKED PER BOX	LIST PRICE			
									EACH	PACKAGE		
8111 Door Pull 1-3/16" Projection Antimicrobial Coating US26D-AM or US32D-AM available. See page 65 for optional mounting types and pricing. 	5" (Actual CTC = 5-1/4")	Brass	8111-5 US3	605	-	-	1	-	\$48.50	-		
			8111-5 US4	606	-	-	1	-	48.50	-		
			8111-5 US10	612	-	-	1	-	54.20	-		
			8111-5 US10B	613	-	-	1	-	54.20	-		
			8111-5 US15	619	-	-	1	-	54.20	-		
			8111-5 US26	625	-	-	1	-	48.50	-		
			8111-5 US26D	626	-	-	1	-	51.90	-		
		Aluminum	8111-5 US28	628	-	-	1	-	30.20	-		
Stainless	8111-5 US32D	630	-	-	1	-	44.90	-				
8112 Door Pull 2-3/16" Antimicrobial Coating US26D-AM available. Surface Mounted 	5"	Brass	8112-5 US26D	626	-	-	1	-	37.90	-		
		Aluminum	C8112-5 PA28	-	-	-	Yes	2	2	-	\$50.90	
8121 Door Pull 3-1/2" Antimicrobial Coating US26D-AM available. Surface Mounted 	5"	Brass	8121-5 US26D	626	-	-	1	-	55.20	-		
		Aluminum	8121-5 PA28	-	-	-	-	1	-	-	-	
8145EZHD 45 Offset Door Pull 1" Round, 2-1/2" Clearance Antimicrobial Coating US26D-AM or US32D-AM available. See page 65 for optional mounting types and pricing.	8"	Brass	8145EZHD-8 US3	605	-	-	1	-	116.80	-		
			8145EZHD-8 US4	606	-	-	1	-	116.80	-		
			8145EZHD-8 US10	612	-	-	1	-	134.90	-		
			8145EZHD-8 US10B	613	-	-	1	-	134.90	-		
			8145EZHD-8 US15	619	-	-	1	-	134.90	-		
			8145EZHD-8 US26	625	-	-	1	-	123.80	-		
			8145EZHD-8 US26D	626	-	-	1	-	123.80	-		
		316 Stainless	8145EZHD-8 32-316	629-316	-	-	1	-	122.90	-		
			8145EZHD-8 32D-316	630-316	-	-	1	-	101.30	-		
		Brass	10"	Brass	8145EZHD-0 US3	605	-	-	1	-	127.50	-
					8145EZHD-0 US4	606	-	-	1	-	127.50	-
					8145EZHD-0 US10	612	-	-	1	-	142.40	-
					8145EZHD-0 US10B	613	-	-	1	-	142.40	-
					8145EZHD-0 US15	619	-	-	1	-	142.40	-
8145EZHD-0 US26	625				-	-	1	-	134.90	-		
8145EZHD-0 US26D	626				-	-	1	-	134.90	-		
316 Stainless	8145EZHD-0 32-316	629-316	-	-	1	-	131.50	-				
	8145EZHD-0 32D-316	630-316	-	-	1	-	110.00	-				
Brass	12"	Brass	8145EZHD-2 US3	605	-	-	1	-	134.90	-		
			8145EZHD-2 US4	606	-	-	1	-	134.90	-		
			8145EZHD-2 US10	612	-	-	1	-	153.30	-		
			8145EZHD-2 US10B	613	-	-	1	-	153.30	-		
			8145EZHD-2 US15	619	-	-	1	-	153.30	-		
			8145EZHD-2 US26	625	-	-	1	-	146.20	-		
			8145EZHD-2 US26D	626	-	-	1	-	146.20	-		
316 Stainless	8145EZHD-2 32-316	629-316	-	-	1	-	140.20	-				
	8145EZHD-2 32D-316	630-316	-	-	1	-	118.70	-				
Brass	18"	Brass	8145EZHD-18 US3	605	-	-	1	-	182.50	-		
			8145EZHD-18 US4	606	-	-	1	-	182.50	-		
			8145EZHD-18 US10	612	-	-	1	-	204.40	-		
			8145EZHD-18 US10B	613	-	-	1	-	204.40	-		
			8145EZHD-18 US15	619	-	-	1	-	204.40	-		
			8145EZHD-18 US26	625	-	-	1	-	193.30	-		
			8145EZHD-18 US26D	626	-	-	1	-	193.30	-		
			316 Stainless	8145EZHD-18 32-316	629-316	-	-	1	-	189.60	-	
8145EZHD-18 32D-316	630-316	-		-	1	-	168.30	-				

Bold pricing indicates item is in stock and available for **Fast Track** and **ProXpress**

MODEL	PULL CTC	SUBSTRATE	MODEL NUMBER	BHMA FINISH	WEIGHT	MUST BE ORDERED IN MULTIPLE QTY	MULTIPLE QTY	PACKED PER BOX	LIST PRICE			
									EACH	PACKAGE		
8169 Tubular Decorative C Shaped Pull 1" Dia. See page 65 for optional mounting types and pricing. 	10"	Brass	8169-10-605	605	-	-	1	-	\$279.10	-		
			8169-10-613	613	-	-	1	-	279.10	-		
			8169-10-625	625	-	-	1	-	279.10	-		
			8169-10-626	626	-	-	1	-	279.10	-		
	12"	Brass	8169-10-630	630	-	-	1	-	248.10	-		
			8169-12-605	605	-	-	1	-	366.00	-		
			8169-12-613	613	-	-	1	-	366.00	-		
			8169-12-625	625	-	-	1	-	366.00	-		
		Stainless	8169-12-626	626	-	-	1	-	366.00	-		
			8169-12-630	630	-	-	1	-	256.70	-		
8181 Georgian Decorative Offset Pull 3/4" Dia. See page 65 for optional mounting types and pricing. 	12"	Brass	8181-12-605	605	-	-	1	-	443.70	-		
			8181-12-613	613	-	-	1	-	443.70	-		
			8181-12-625	625	-	-	1	-	443.70	-		
			8181-12-626	626	-	-	1	-	443.70	-		
	Aluminum	8181-12-628	628	-	-	1	-	417.20	-			
		8181-12-630	630	-	-	1	-	427.80	-			
	16"	Brass	8181-16-605	605	-	-	1	-	497.80	-		
			8181-16-613	613	-	-	1	-	497.80	-		
			8181-16-625	625	-	-	1	-	497.80	-		
			8181-16-626	626	-	-	1	-	497.80	-		
		Aluminum	8181-16-628	628	-	-	1	-	498.40	-		
			8181-16-630	630	-	-	1	-	497.80	-		
	18"	Brass	8181-18-605	605	-	-	1	-	524.90	-		
			8181-18-613	613	-	-	1	-	524.90	-		
			8181-18-625	625	-	-	1	-	524.90	-		
			8181-18-626	626	-	-	1	-	524.90	-		
Aluminum		8181-18-628	628	-	-	1	-	525.40	-			
		8181-18-630	630	-	-	1	-	524.90	-			
8189 Athens Decorative Offset Long Pull - 1 1/4" Dia. See page 65 for optional mounting types and pricing. Custom lengths available as engineered special. 	19 13/16"	Brass	8189-19-605	605	-	-	1	-	1122.90	-		
			8189-19-613	613	-	-	1	-	1167.70	-		
			8189-19-619	619	-	-	1	-	1240.60	-		
			8189-19-625	625	-	-	1	-	1240.60	-		
			8189-19-626	626	-	-	1	-	1240.60	-		
		Stainless	8189-19-630	630	-	-	1	-	704.80	-		
8190HD 90° Offset Door Pull 1" Round, 2-1/4" Clearance Antimicrobial Coating US26D-AM or US32D-AM available. See page 65 for optional mounting types and pricing. 	8"	Brass	8190HD-8 US3	605	-	-	1	-	110.70	-		
			8190HD-8 US4	606	-	-	1	-	110.70	-		
			8190HD-8 US10	612	-	-	1	-	127.90	-		
			8190HD-8 US10B	613	-	-	1	-	127.90	-		
			8190HD-8 US15	619	-	-	1	-	127.90	-		
			8190HD-8 US26	625	-	-	1	-	117.40	-		
		Stainless	8190HD-8 US26D	626	-	-	1	-	117.40	-		
			8190HD-8 US32	629	-	-	1	-	98.50	-		
	10"	Brass	8190HD-8 US32D	630	-	-	1	-	81.30	-		
			8190HD-0 US3	605	-	-	1	-	120.90	-		
			8190HD-0 US4	606	-	-	1	-	120.90	-		
			8190HD-0 US10	612	-	-	1	-	134.90	-		
			8190HD-0 US10B	613	-	-	1	-	129.50	-		
			8190HD-0 US15	619	-	-	1	-	134.90	-		
			8190HD-0 US26	625	-	-	1	-	127.90	-		
			8190HD-0 US26D	626	-	-	1	-	122.60	-		
		Stainless	8190HD-0 US32	629	-	-	1	-	105.40	-		
			8190HD-0 US32D	630	-	-	1	-	84.60	-		
			12"	Brass	8190HD-2 US3	605	-	-	1	-	127.90	-
					8190HD-2 US4	606	-	-	1	-	127.90	-
					8190HD-2 US10	612	-	-	1	-	145.20	-
					8190HD-2 US10B	613	-	-	1	-	145.20	-
	8190HD-2 US15	619			-	-	1	-	145.20	-		
	8190HD-2 US26	625			-	-	1	-	138.50	-		
	Stainless	8190HD-2 US26D		626	-	-	1	-	138.50	-		
		8190HD-2 US32		629	-	-	1	-	112.50	-		
	18"	Brass	8190HD-2 US32D	630	-	-	1	-	91.20	-		
			8190HD-18 US3	605	-	-	1	-	172.90	-		
			8190HD-18 US4	606	-	-	1	-	172.90	-		
			8190HD-18 US10	612	-	-	1	-	193.70	-		
8190HD-18 US10B			613	-	-	1	-	193.70	-			
8190HD-18 US15			619	-	-	1	-	193.70	-			
8190HD-18 US26			625	-	-	1	-	183.20	-			
8190HD-18 US26D			626	-	-	1	-	183.20	-			
Stainless		8190HD-18 US32	629	-	-	1	-	152.00	-			
		8190HD-18 US32D	630	-	-	1	-	129.50	-			

HINGES

CONTINUOUS HINGES

PIVOTS

Numerical 1-059

Numerical 59-437

Numerical 438-1021

Numerical 1152-8190

Numerical 8200-9340

Bold pricing indicates item is in stock and available for **Fast Track** and **ProXpress**

Additional 8190 Pulls Available in Fast Track and ProXpress				
MODELNUMBER	DESCRIPTION	SIZE	FINISH	Price
8190HD-0	90 Degree Offset Door Pull 1-3/4" (Mounting Type O)	10"	US32D	\$112.60
8190HD-2	90 Degree Offset Door Pull 1-3/4" (Mounting Type O)	12"	US32D	119.20

MODEL	PULL CTC	SUBSTRATE	MODEL NUMBER	BHMA FINISH	WEIGHT	MUST BE ORDERED IN MULTIPLE QTY	MULTIPLE QTY	PACKED PER BOX	LIST PRICE	
									EACH	PACKAGE
8190EZHD 90 Offset Door Pull 1" Round, 2-1/2" Clearance Antimicrobial Coating US26D-AM or US32D-AM available. See page 65 for optional mounting types and pricing.	8"	Brass	8190EZHD-8 US3	605	-	-	1	-	\$116.80	-
			8190EZHD-8 US4	606	-	-	1	-	116.80	-
			8190EZHD-8 US10	612	-	-	1	-	134.90	-
			8190EZHD-8 US10B	613	-	-	1	-	134.90	-
			8190EZHD-8 US15	619	-	-	1	-	134.90	-
			8190EZHD-8 US26	625	-	-	1	-	123.80	-
			8190EZHD-8 US26D	626	-	-	1	-	123.80	-
		316 Stainless	8190EZHD-8 32-316	629-316	-	-	1	-	122.90	-
	8190EZHD-8 32D-316		630-316	-	-	1	-	101.30	-	
	10"	Brass	8190EZHD-0 US3	605	-	-	1	-	127.50	-
			8190EZHD-0 US4	606	-	-	1	-	127.50	-
			8190EZHD-0 US10	612	-	-	1	-	142.40	-
			8190EZHD-0 US10B	613	-	-	1	-	142.40	-
			8190EZHD-0 US15	619	-	-	1	-	142.40	-
8190EZHD-0 US26			625	-	-	1	-	134.90	-	
8190EZHD-0 US26D			626	-	-	1	-	134.90	-	
316 Stainless		8190EZHD-0 32-316	629-316	-	-	1	-	131.50	-	
	8190EZHD-0 32D-316	630-316	-	-	1	-	110.00	-		
12"	Brass	8190EZHD-2 US3	605	-	-	1	-	134.90	-	
		8190EZHD-2 US4	606	-	-	1	-	134.90	-	
		8190EZHD-2 US10	612	-	-	1	-	153.30	-	
		8190EZHD-2 US10B	613	-	-	1	-	153.30	-	
		8190EZHD-2 US15	619	-	-	1	-	153.30	-	
		8190EZHD-2 US26	625	-	-	1	-	146.20	-	
		8190EZHD-2 US26D	626	-	-	1	-	146.20	-	
	316 Stainless	8190EZHD-2 32-316	629-316	-	-	1	-	140.20	-	
8190EZHD-2 32D-316		630-316	-	-	1	-	118.70	-		
18"	Brass	8190EZHD-18 US3	605	-	-	1	-	182.50	-	
		8190EZHD-18 US4	606	-	-	1	-	182.50	-	
		8190EZHD-18 US10	612	-	-	1	-	204.40	-	
		8190EZHD-18 US10B	613	-	-	1	-	204.40	-	
		8190EZHD-18 US15	619	-	-	1	-	204.40	-	
		8190EZHD-18 US26	625	-	-	1	-	193.30	-	
		8190EZHD-18 US26D	626	-	-	1	-	193.30	-	
	316 Stainless	8190EZHD-18 32-316	629-316	-	-	1	-	189.60	-	
8190EZHD-18 32D-316		630-316	-	-	1	-	168.30	-		

Contact Ives Customer Service for pricing on additional sizes and finishes

Bold pricing indicates item is in stock and available for **Fast Track** and **ProXpress**

HINGES
 CONTINUOUS HINGES
 PIVOTS
 Numerical 1-059
 Numerical 59-437
 Numerical 438-1021
 Numerical 1152-8190
 Numerical 8200-9340

MODEL	PLATE SIZE	SUBSTRATE	MODEL NUMBER	BHMA FINISH	WEIGHT	MUST BE ORDERED IN MULTIPLE QTY	MULTIPLE QTY	PACKED PER BOX	LIST PRICE			
									EACH	PACKAGE		
8200 Push Plate Antimicrobial Coating Available Specify US26D AM or US32D AM See Page 65 for list prices.	3x12" (89x306mm)	Brass	8200 US3	605	-	-	-	-	\$19.40	-		
			8200 US4	606	-	-	-	-	19.40	-		
			8200 US10	612	-	-	-	-	21.70	-		
			8200 US10B	613	-	-	-	-	24.20	-		
			8200 US15	619	-	-	-	-	24.20	-		
			8200 US26	625	-	-	-	-	24.20	-		
			8200 US26D	626	-	-	-	-	24.20	-		
		Aluminum	8200 US28	628	-	-	-	-	-	12.20	-	
			C8200 PA28	628	-	-	Yes	5	5	-	\$48.20	
	Stainless	8200 US32D	630	-	-	-	-	-	11.90	-		
	3.5x15" (89x381mm)	Brass	8200 US3	605	-	-	-	-	-	21.30	-	
			8200 US4	606	-	-	-	-	-	21.70	-	
			8200 US10	612	-	-	-	-	-	25.50	-	
			8200 US10B	613	-	-	-	-	-	26.30	-	
			8200 US15	619	-	-	-	-	-	26.30	-	
			8200 US26	625	-	-	-	-	-	25.50	-	
			8200 US26D	626	-	-	-	-	-	25.00	-	
			SC8200 B3	605	-	-	Yes	5	5	-	116.10	
			Aluminum	8200 US28	628	-	-	-	-	-	10.00	-
		C8200 PA28		-	-	-	Yes	5	5	-	50.50	
		8200 US32D		630	-	-	-	-	-	12.30	-	
		Stainless	8200 US32D	630	-	-	-	-	-	-	12.30	
			CGC8200 US32D	630	-	-	Yes	5	5	-	82.40	
		4x16" (102x408mm)	Brass	8200 US3	605	-	-	-	-	-	25.00	-
	8200 US4			606	-	-	-	-	-	25.00	-	
	8200 US10			612	-	-	-	-	-	28.60	-	
	8200 US10B			613	-	-	-	-	-	29.80	-	
	8200 US15			619	-	-	-	-	-	29.80	-	
	8200 US26			625	-	-	-	-	-	29.20	-	
	8200 US26D			626	-	-	-	-	-	28.60	-	
	Aluminum		8200 US28	628	-	-	-	-	-	9.50	-	
			8200 US32D	630	-	-	-	-	-	14.30	-	
	6x16" (153x408mm)		Brass	8200 US3	605	-	-	-	-	-	40.20	-
				8200 US4	606	-	-	-	-	-	40.20	-
				8200 US10	612	-	-	-	-	-	44.90	-
		8200 US10B		613	-	-	-	-	-	47.70	-	
		8200 US15		619	-	-	-	-	-	48.70	-	
		8200 US26		625	-	-	-	-	-	42.60	-	
		8200 US26D		626	-	-	-	-	-	42.60	-	
		Aluminum	8200 US28	628	-	-	-	-	-	12.20	-	
		Stainless	8200 US32D	630	-	-	-	-	-	19.50	-	
8x16" (204x408mm)	Brass	8200 US3	605	-	-	-	-	-	49.70	-		
		8200 US4	606	-	-	-	-	-	49.70	-		
		8200 US10	612	-	-	-	-	-	57.10	-		
		8200 US10B	613	-	-	-	-	-	60.90	-		
		8200 US15	619	-	-	-	-	-	60.90	-		
		8200 US26	625	-	-	-	-	-	55.90	-		
		8200 US26D	626	-	-	-	-	-	55.90	-		
	Aluminum	8200 US28	628	-	-	-	-	-	15.20	-		
	Stainless	8200 US32D	630	-	-	-	-	-	27.30	-		

HINGES
 CONTINUOUS HINGES
 PIVOTS
 Numerical 1-059
 Numerical 59-437
 Numerical 438-1021
 Numerical 1152-8190
 Numerical 8200-9340

Contact Ives Customer Service for pricing on additional sizes and finishes

Bold pricing indicates item is in stock and available for **Fast Track** and **ProXpress**

HINGES

CONTINUOUS HINGES

PIVOTS



Numerical 1-059

Numerical 59-437

Numerical 438-1021

Numerical 1152-8190

Numerical 8200-9340

MODEL	PULL CTC	PLATE SIZE	SUBSTRATE	MODEL NUMBER	BHMA FINISH	WEIGHT	MUST BE ORDERED IN			LIST PRICE	
							MULTIPLE QTY	MULTIPLE QTY	PACKED PER BOX	EACH	PACKAGE
8281 Georgian Decorative Straight Pull 3/4" Dia. See page 65 for optional mounting types and pricing. 	12"		Brass	8281-12-605	605	-	-	1		\$828.80	-
				8281-12-613	613	-	-	1		861.90	-
				8281-12-625	625	-	-	1		663.00	-
				8281-12-626	626	-	-	1		663.00	-
			Aluminum	8281-12-628	628	-	-	1		342.20	-
			Stainless Steel	8281-12-630	630	-	-	1		663.00	-
	16"		Brass	8281-16-605	605	-	-	1		855.50	-
				8281-16-613	613	-	-	1		889.70	-
				8281-16-625	625	-	-	1		684.50	-
				8281-16-626	626	-	-	1		684.50	-
			Aluminum	8281-16-628	628	-	-	1		355.10	-
			Stainless Steel	8281-16-630	630	-	-	1		684.50	-
	18"		Brass	8281-18-605	605	-	-	1		868.90	-
				8281-18-613	613	-	-	1		903.60	-
				8281-18-625	625	-	-	1		695.10	-
8281-18-626				626	-	-	1		695.10	-	
Aluminum			8281-18-628	628	-	-	1		361.40	-	
Stainless Steel			8281-18-630	630	-	-	1		695.10	-	
8302 Pull Plate Antimicrobial Coating US26D-AM or US32D-AM available. See page 65 for optional mounting types and pricing. 	6"	3.5x15" (89x381mm)	Brass	8302-6 US3	605	-	-	-	-	71.10	-
				8302-6 US4	606	-	-	-	-	71.10	-
				8302-6 US10	612	-	-	-	-	81.30	-
				8302-6 US10B	613	-	-	-	-	84.50	-
				8302-6 US15	619	-	-	-	-	84.50	-
				8302-6 US26	625	-	-	-	-	80.50	-
			8302-6 US26D	626	-	-	-	-	74.80	-	
			Aluminum	8302-6 US28	628	-	-	-	-	31.20	-
			C8302-6 PA28	628	-	Yes	2	2		\$62.40	-
			Stainless	8302-6 US32D	630	-	-	-	-	42.50	-
	6"	4x16" (102x408mm)	Brass	8302-6 US3	605	-	-	-	-	74.80	-
				8302-6 US4	606	-	-	-	-	74.80	-
				8302-6 US10	612	-	-	-	-	84.90	-
				8302-6 US10B	613	-	-	-	-	88.10	-
				8302-6 US15	619	-	-	-	-	88.10	-
				8302-6 US26	625	-	-	-	-	84.30	-
			8302-6 US26D	626	-	-	-	-	78.40	-	
			Aluminum	8302-6 US28	628	-	-	-	-	30.70	-
	Stainless	8302-6 US32D	630	-	-	-	-	44.40	-		
	6"	6x16" (153x408mm)	Brass	8302-6 US3	605	-	-	-	-	89.50	-
				8302-6 US4	606	-	-	-	-	89.50	-
8302-6 US10				612	-	-	-	-	100.70	-	
8302-6 US10B				613	-	-	-	-	106.40	-	
8302-6 US15				619	-	-	-	-	106.40	-	
8302-6 US26				625	-	-	-	-	97.70	-	
8302-6 US26D			626	-	-	-	-	91.90	-		
Aluminum			8302-6 US28	628	-	-	-	-	33.20	-	
Stainless			8302-8 US32D	630	-	-	-	-	51.70	-	

Continued on next page.

Contact Ives Customer Service for pricing on additional sizes and finishes

Bold pricing indicates item is in stock and available for **Fast Track** and **ProXpress**

MODEL	PULL CTC	PLATE SIZE	SUBSTRATE	MODEL NUMBER	BHMA FINISH	WEIGHT	MUST BE ORDERED IN			LIST PRICE	
							MULTIPLE QTY	MULTIPLE QTY	PACKED PER BOX	EACH	PACKAGE
8302 Pull Plate See page 65 for optional mounting types and pricing. <i>Continued from previous page.</i> 	8"	3.5x15" (89x381mm)	Brass	8302-8 US3	605	-	-	-	-	\$76.90	-
				8302-8 US4	606	-	-	-	-	76.90	-
				8302-8 US10	612	-	-	-	-	88.30	-
				8302-8 US10B	613	-	-	-	-	91.80	-
				8302-8 US15	619	-	-	-	-	91.80	-
				8302-8 US26	625	-	-	-	-	86.50	-
				8302-8 US26D	626	-	-	-	-	80.50	-
	Aluminum	8302-8 US28	628	-	-	-	-	30.60	-		
	Stainless	8302-8 US32D	630	-	-	-	-	46.30	-		
	8"	4x16" (102x408mm)	Brass	8302-8 US3	605	-	-	-	-	80.50	-
				8302-8 US4	606	-	-	-	-	80.50	-
				8302-8 US10	612	-	-	-	-	92.10	-
				8302-8 US10B	613	-	-	-	-	91.50	-
				8302-8 US15	619	-	-	-	-	95.30	-
				8302-8 US26	625	-	-	-	-	90.20	-
				8302-8 US26D	626	-	-	-	-	84.30	-
	Aluminum	8302-8 US28	628	-	-	-	-	31.30	-		
	Stainless	8302-8 US32D	630	-	-	-	-	48.20	-		
	8"	6x16" (153x408mm)	Brass	8302-8 US3	605	-	-	-	-	95.20	-
				8302-8 US4	606	-	-	-	-	95.20	-
				8302-8 US10	612	-	-	-	-	107.80	-
				8302-8 US10B	613	-	-	-	-	113.60	-
				8302-8 US15	619	-	-	-	-	113.60	-
				8302-8 US26	625	-	-	-	-	103.50	-
				8302-8 US26D	626	-	-	-	-	97.70	-
	Aluminum	8302-8 US28	628	-	-	-	-	33.80	-		
	Stainless	8302-8 US32D	630	-	-	-	-	55.70	-		
	10"	3.5x15" (89x381mm)	Brass	8302-0 US3	605	-	-	-	-	85.80	-
				8302-0 US4	606	-	-	-	-	85.80	-
				8302-0 US10	612	-	-	-	-	98.80	-
				8302-0 US10B	613	-	-	-	-	102.20	-
				8302-0 US15	619	-	-	-	-	102.20	-
				8302-0 US26	625	-	-	-	-	88.00	-
				8302-0 US26D	626	-	-	-	-	88.30	-
	Aluminum	8302-0 US28	628	-	-	-	-	33.20	-		
	Stainless	8302-0 US32D	630	-	-	-	-	51.80	-		
	10"	4x16" (102x408mm)	Brass	8302-0 US3	605	-	-	-	-	89.60	-
				8302-0 US4	606	-	-	-	-	89.60	-
				8302-0 US10	612	-	-	-	-	102.60	-
				8302-0 US10B	613	-	-	-	-	105.70	-
				8302-0 US15	619	-	-	-	-	105.70	-
				8302-0 US26	625	-	-	-	-	91.80	-
				8302-0 US26D	626	-	-	-	-	92.10	-
	Aluminum	8302-0 US28	628	-	-	-	-	32.70	-		
	Stainless	8302-0 US32D	630	-	-	-	-	53.70	-		
	10"	6x16" (153x408mm)	Brass	8302-0 US3	605	-	-	-	-	104.20	-
				8302-0 US4	606	-	-	-	-	104.20	-
				8302-0 US10	612	-	-	-	-	118.30	-
				8302-0 US10B	613	-	-	-	-	124.00	-
				8302-0 US15	619	-	-	-	-	124.00	-
				8302-0 US26	625	-	-	-	-	105.10	-
				8302-0 US26D	626	-	-	-	-	105.40	-
	Aluminum	8302-0 US28	628	-	-	-	-	35.20	-		
	Stainless	8302-0 US32D	630	-	-	-	-	58.80	-		

HINGES

CONTINUOUS HINGES

PIVOTS

Numerical 1-059

Numerical 59-437

Numerical 438-1021

Numerical 1152-8190

Numerical 8200-9340

Contact Ives Customer Service for pricing on additional sizes and finishes

Bold pricing indicates item is in stock and available for **Fast Track** and **ProXpress**

HINGES

CONTINUOUS HINGES

PIVOTS

Numerical 1-059

Numerical 59-437

Numerical 438-1021



Numerical 8190-1152

Numerical 8200-9340

MODEL	PULL CTC	PLATE SIZE	SUBSTRATE	MODEL NUMBER	BHMA FINISH	WEIGHT	MUST BE ORDERED IN			LIST PRICE	
							MULTIPLE QTY	MULTIPLE QTY	PACKED PER BOX	EACH	PACKAGE
8303 Pull Plate Antimicrobial Coating US26D-AM or US32D-AM available. See page 65 for optional mounting types and pricing.	8"	3.5x15" (89x381mm)	Brass	8303-8 US3	605	-	-	-	-	\$117.90	-
				8303-8 US4	606	-	-	-	-	117.90	-
				8303-8 US10	612	-	-	-	-	133.50	-
				8303-8 US10B	613	-	-	-	-	138.50	-
				8303-8 US15	619	-	-	-	-	138.50	-
				8303-8 US26	625	-	-	-	-	127.70	-
				8303-8 US26D	626	-	-	-	-	121.90	-
			Aluminum	8303-8 US28	628	-	-	-	-	39.50	-
			Stainless	8303-8 US32D	630	-	-	-	-	72.90	-
	8"	4x16" (102x408mm)	Brass	8303-8 US3	605	-	-	-	-	121.60	-
				8303-8 US4	606	-	-	-	-	121.60	-
				8303-8 US10	612	-	-	-	-	137.10	-
				8303-8 US10B	613	-	-	-	-	142.10	-
				8303-8 US15	619	-	-	-	-	142.10	-
				8303-8 US26	625	-	-	-	-	131.40	-
				8303-8 US26D	626	-	-	-	-	125.70	-
			Aluminum	8303-8 US28	628	-	-	-	-	39.00	-
			Stainless	8303-8 US32D	630	-	-	-	-	71.80	-
	8"	6x16" (153x408mm)	Brass	8303-8 US3	605	-	-	-	-	136.30	-
				8303-8 US4	606	-	-	-	-	136.30	-
				8303-8 US10	612	-	-	-	-	152.90	-
8303-8 US10B				613	-	-	-	-	160.30	-	
8303-8 US15				619	-	-	-	-	160.30	-	
8303-8 US26				625	-	-	-	-	144.70	-	
8303-8 US26D				626	-	-	-	-	139.00	-	
Aluminum			8303-8 US28	628	-	-	-	-	41.50	-	
Stainless			8303-8 US32D	630	-	-	-	-	80.20	-	
10"	3.5x15" (89x381mm)	Brass	8303-0 US3	605	-	-	-	-	127.80	-	
			8303-0 US4	606	-	-	-	-	127.80	-	
			8303-0 US10	612	-	-	-	-	147.00	-	
			8303-0 US10B	613	-	-	-	-	148.40	-	
			8303-0 US15	619	-	-	-	-	152.40	-	
			8303-0 US26	625	-	-	-	-	137.10	-	
			8303-0 US26D	626	-	-	-	-	131.50	-	
		Aluminum	8303-0 US28	628	-	-	-	-	41.00	-	
		Stainless	8303-0 US32D	630	-	-	-	-	76.80	-	
10"	4x16" (102x408mm)	Brass	8303-0 US3	605	-	-	-	-	131.50	-	
			8303-0 US4	606	-	-	-	-	131.50	-	
			8303-0 US10	612	-	-	-	-	150.80	-	
			8303-0 US10B	613	-	-	-	-	145.70	-	
			8303-0 US15	619	-	-	-	-	156.00	-	
			8303-0 US26	625	-	-	-	-	140.90	-	
			8303-0 US26D	626	-	-	-	-	135.10	-	
		Aluminum	8303-0 US28	628	-	-	-	-	40.40	-	
		Stainless	8303-0 US32D	630	-	-	-	-	78.60	-	

Continued on next page.

Bold pricing indicates item is in stock and available for **Fast Track** and **ProXpress**

MODEL	PULL CTC	PLATE SIZE	SUBSTRATE	MODEL NUMBER	BHMA FINISH	WEIGHT	MUST BE ORDERED IN			LIST PRICE			
							MULTIPLE QTY	MULTIPLE QTY	PACKED PER BOX	EACH	PACKAGE		
8303 Pull Plate Continued from previous page. 	10"	6x16" (153x408mm)	Brass	8303-0 US3	605	-	-	-	-	\$146.20	-		
				8303-0 US4	606	-	-	-	-	146.20	-		
				8303-0 US10	612	-	-	-	-	166.50	-		
				8303-0 US10B	613	-	-	-	-	170.20	-		
				8303-0 US15	619	-	-	-	-	174.30	-		
				8303-0 US26	625	-	-	-	-	154.20	-		
				8303-0 US26D	626	-	-	-	-	148.60	-		
			Aluminum	8303-0 US28	628	-	-	-	-	42.90	-		
Stainless	8303-0 US32D	630	-	-	-	-	83.80	-					
8305 Pull Plate Antimicrobial Coating US26D-AM or US32D-AM available. See page 65 for optional mounting types and pricing. 	6"	3.5x15" (89x381mm)	Brass	8305-6 US3	605	-	-	-	-	75.20	-		
				8305-6 US4	606	-	-	-	-	75.20	-		
				8305-6 US10	612	-	-	-	-	90.60	-		
				8305-6 US10B	613	-	-	-	-	93.60	-		
				8305-6 US15	619	-	-	-	-	93.60	-		
				8305-6 US26	625	-	-	-	-	79.30	-		
				8305-6 US26D	626	-	-	-	-	74.90	-		
			Aluminum	8305-6 US28	628	-	-	-	-	33.80	-		
			Stainless	8305-6 US32D	630	-	-	-	-	53.90	-		
			6"	4x16" (102x408mm)	Brass	8305-6 US3	605	-	-	-	-	79.00	-
						8305-6 US4	606	-	-	-	-	79.00	-
						8305-6 US10	612	-	-	-	-	94.40	-
	8305-6 US10B	613				-	-	-	-	97.20	-		
	8305-6 US15	619				-	-	-	-	97.20	-		
	8305-6 US26	625				-	-	-	-	83.00	-		
	8305-6 US26D	626			-	-	-	-	78.60	-			
	Aluminum	8305-6 US28	628	-	-	-	-	33.30	-				
	Stainless	8305-6 US32D	630	-	-	-	-	53.60	-				
	6"	6x16" (153x408mm)	Brass	8305-6 US3	605	-	-	-	-	93.60	-		
				8305-6 US4	606	-	-	-	-	93.70	-		
				8305-6 US10	612	-	-	-	-	110.30	-		
				8305-6 US10B	613	-	-	-	-	115.60	-		
				8305-6 US15	619	-	-	-	-	115.60	-		
				8305-6 US26	625	-	-	-	-	96.40	-		
				8305-6 US26D	626	-	-	-	-	92.10	-		
			Aluminum	8305-6 US28	628	-	-	-	-	35.90	-		
			Stainless	8305-6 US32D	630	-	-	-	-	61.30	-		
			8"	3.5x15" (89x381mm)	Brass	8305-8 US3	605	-	-	-	-	103.50	-
8305-8 US4						606	-	-	-	-	103.50	-	
8305-8 US10						612	-	-	-	-	114.10	-	
8305-8 US10B	613	-				-	-	-	115.50	-			
8305-8 US15	619	-				-	-	-	115.50	-			
8305-8 US26	625	-				-	-	-	110.70	-			
8305-8 US26D	626	-				-	-	-	110.70	-			
Aluminum	8305-8 US28	628			-	-	-	-	39.10	-			
Stainless	8305-8 US32D	630			-	-	-	-	71.80	-			

HINGES
 CONTINUOUS HINGES
 PIVOTS
 Numerical 1-059
 Numerical 59-437
 Numerical 438-1021
 Numerical 1152-8190
 Numerical 8200-9340

Bold pricing indicates item is in stock and available for **Fast Track** and **ProXpress**

HINGES

CONTINUOUS HINGES

PIVOTS

Numerical 1-059

Numerical 59-437



Numerical 438-1021

Numerical 8190-1152

Numerical 8200-9340

MODEL	PULL CTC	PLATE SIZE	SUBSTRATE	MODEL NUMBER	BHMA FINISH	WEIGHT	MUST BE ORDERED IN			LIST PRICE	
							MULTIPLE QTY	MULTIPLE QTY	PACKED PER BOX	EACH	PACKAGE
8305 Pull Plate <i>Continued from previous page.</i> 	8"	4x16" (102x408mm)	Brass	8305-8 US3	605	-	-	-	-	\$107.30	-
				8305-8 US4	606	-	-	-	-	107.30	-
				8305-8 US10	612	-	-	-	-	117.90	-
				8305-8 US10B	613	-	-	-	-	119.10	-
				8305-8 US15	619	-	-	-	-	119.10	-
				8305-8 US26	625	-	-	-	-	114.30	-
				8305-8 US26D	626	-	-	-	-	114.30	-
			Aluminum	8305-8 US28	628	-	-	-	-	38.50	-
			Stainless	8305-8 US32D	630	-	-	-	-	70.80	-
	8"	6x16" (153x408mm)	Brass	8305-8 US3	605	-	-	-	-	121.90	-
				8305-8 US4	606	-	-	-	-	121.90	-
				8305-8 US10	612	-	-	-	-	133.70	-
				8305-8 US10B	613	-	-	-	-	137.30	-
				8305-8 US15	619	-	-	-	-	137.30	-
				8305-8 US26	625	-	-	-	-	127.80	-
				8305-8 US26D	626	-	-	-	-	127.80	-
			Aluminum	8305-8 US28	628	-	-	-	-	41.10	-
			Stainless	8305-8 US32D	630	-	-	-	-	79.20	-
	10"	3.5x15" (89x381mm)	Brass	8305-0 US3	605	-	-	-	-	110.50	-
				8305-0 US4	606	-	-	-	-	110.50	-
				8305-0 US10	612	-	-	-	-	124.40	-
8305-0 US10B				613	-	-	-	-	125.80	-	
8305-0 US15				619	-	-	-	-	125.80	-	
8305-0 US26				625	-	-	-	-	117.70	-	
8305-0 US26D				626	-	-	-	-	117.70	-	
Aluminum			8305-0 US28	628	-	-	-	-	40.00	-	
Stainless			8305-0 US32D	630	-	-	-	-	78.90	-	
10"	4x16" (102x408mm)	Brass	8305-0 US3	605	-	-	-	-	114.10	-	
			8305-0 US4	606	-	-	-	-	114.10	-	
			8305-0 US10	612	-	-	-	-	128.20	-	
			8305-0 US10B	613	-	-	-	-	129.40	-	
			8305-0 US15	619	-	-	-	-	129.40	-	
			8305-0 US26	625	-	-	-	-	121.40	-	
			8305-0 US26D	626	-	-	-	-	121.40	-	
		Aluminum	8305-0 US28	628	-	-	-	-	39.40	-	
		Stainless	8305-0 US32D	630	-	-	-	-	77.50	-	
10"	6x16" (153x408mm)	Brass	8305-0 US3	605	-	-	-	-	128.80	-	
			8305-0 US4	606	-	-	-	-	128.80	-	
			8305-0 US10	612	-	-	-	-	144.00	-	
			8305-0 US10B	613	-	-	-	-	147.60	-	
			8305-0 US15	619	-	-	-	-	147.60	-	
			8305-0 US26	625	-	-	-	-	134.70	-	
			8305-0 US26D	626	-	-	-	-	134.70	-	
		Aluminum	8305-0 US28	628	-	-	-	-	41.90	-	
		Stainless	8305-0 US32D	630	-	-	-	-	86.10	-	

Bold pricing indicates item is in stock and available for **Fast Track** and **ProXpress**

MODEL	PULL CTC	PLATE SIZE	SUBSTRATE	MODEL NUMBER	BHMA FINISH	WEIGHT	MUST BE ORDERED IN			LIST PRICE		
							MULTIPLE QTY	MULTIPLE QTY	PACKED PER BOX	EACH	PACKAGE	
8311 Pull Plate Antimicrobial Coating US26D-AM or US32D-AM available. See page 65 for optional mounting types and pricing. 	5" (Actual CTC = 5-1/4")	3.5x15" (89x381mm)	Brass	8311-5 US3	605	-	-	-	-	\$72.50	-	
				SC8311-5B3	605	-	Yes	2	2		\$144.90	
				8311-5 US4	606	-	-	-	-	72.50	-	
				8311-5 US10	612	-	-	-	-	81.90	-	
				8311-5 US10B	613	-	-	-	-	83.20	-	
				8311-5 US15	619	-	-	-	-	83.20	-	
				8311-5 US26	625	-	-	-	-	76.20	-	
				8311-5 US26D	626	-	-	-	-	79.60	-	
			CGC8311-5B26D	626	-	Yes	5	5			397.80	
	Aluminum	8311-5 US28	628	-	-	-	-	42.60	-			
		C8311-5PA28	628	-	Yes	2	2			85.20		
	Stainless	8311-5 US32D	630	-	-	-	-	59.70	-			
	5" (Actual CTC = 5-1/4")	4x16" (102x408mm)	Brass	8311-5 US3	605	-	-	-	-	76.20	-	
				8311-5 US4	606	-	-	-	-	76.20	-	
				8311-5 US10	612	-	-	-	-	85.60	-	
				8311-5 US10B	613	-	-	-	-	86.80	-	
				8311-5 US15	619	-	-	-	-	86.80	-	
				8311-5 US26	625	-	-	-	-	79.90	-	
			8311-5 US26D	626	-	-	-	-	83.30	-		
	Aluminum	8311-5 US28	628	-	-	-	-	42.00	-			
	Stainless	8311-5 US32D	630	-	-	-	-	59.20	-			
5" (Actual CTC = 5-1/4")	6x16" (153x408mm)	Brass	8311-5 US3	605	-	-	-	-	90.80	-		
			8311-5 US4	606	-	-	-	-	90.80	-		
			8311-5 US10	612	-	-	-	-	101.30	-		
			8311-5 US10B	613	-	-	-	-	105.10	-		
			8311-5 US15	619	-	-	-	-	105.10	-		
			8311-5 US26	625	-	-	-	-	93.20	-		
		8311-5 US26D	626	-	-	-	-	96.70	-			
		Aluminum	8311-5 US28	628	-	-	-	-	44.50	-		
Stainless	8311-5 US32D	630	-	-	-	-	67.10	-				
8312 Plymouth Decorative Curved Pull - 1" Dia. See page 65 for optional mounting types and pricing. 	12"	Brass	8312-12-605	605	-	-	1	303.00	-			
			8312-12-613	613	-	-	1	368.00	-			
			8312-12-619	619	-	-	1	368.00	-			
			8312-12-625	625	-	-	1	368.00	-			
			8312-12-626	626	-	-	1	368.00	-			
			Stainless Steel	8312-12-630	630	-	-	1	855.50	-		
		8320 Plymouth Decorative Curved Pull - 1 1/4" Dia. See page 65 for optional mounting types and pricing. 	20"	Brass	8320-20-605	605	-	-	1	562.70	-	
8320-20-613	613				-	-	1	606.10	-			
8320-20-619	619				-	-	1	606.10	-			
8320-20-625	625				-	-	1	606.10	-			
8320-20-626	626				-	-	1	606.10	-			
Stainless Steel	8320-20-630			630	-	-	1	962.50	-			

HINGES
 CONTINUOUS HINGES
 PIVOTS
 Numerical 1-059
 Numerical 59-437
 Numerical 438-1021
 Numerical 1152-8190
 Numerical 8200-9340

Bold pricing indicates item is in stock and available for **Fast Track** and **ProXpress**

HINGES

CONTINUOUS HINGES

PIVOTS



Numerical 1-059

Numerical 59-437

Numerical 438-1021

Numerical 1152-8190

Numerical 8200-9340

MODEL	PULL CTC	PLATE SIZE	SUBSTRATE	MODEL NUMBER	BHMA FINISH	WEIGHT	MUST BE ORDERED IN			LIST PRICE	
							MULTIPLE QTY	MULTIPLE QTY	PACKED PER BOX	EACH	PACKAGE
8371 Addison Decorative Flat Tip, Straight Pull 1" Dia. See page 65 for optional mounting types and pricing. 	12"		Brass	8371-12-605	605	-	-	1	-	684.50	-
				8371-12-613	613	-	-	1	-	684.50	-
				8371-12-619	619	-	-	1	-	684.50	-
				8371-12-625	625	-	-	1	-	684.50	-
				8371-12-626	626	-	-	1	-	684.40	-
	18"		Brass	8371-18-605	605	-	-	1	-	722.90	-
				8371-18-613	613	-	-	1	-	722.90	-
				8371-18-619	619	-	-	1	-	722.90	-
				8371-18-625	625	-	-	1	-	722.90	-
				8371-18-626	626	-	-	1	-	722.90	-
	24"		Brass	8371-24-605	605	-	-	1	-	748.70	-
				8371-24-613	613	-	-	1	-	748.70	-
				8371-24-619	619	-	-	1	-	748.70	-
				8371-24-625	625	-	-	1	-	748.70	-
				8371-24-626	626	-	-	1	-	748.70	-
8372 Camelot Decorative Steeple Tip, Straight Pull 1" Dia. See page 65 for optional mounting types and pricing. 	12"		Brass	8372-12-605	605	-	-	1	-	684.50	-
				8372-12-613	613	-	-	1	-	684.50	-
				8372-12-619	619	-	-	1	-	684.50	-
				8372-12-625	625	-	-	1	-	684.50	-
				8372-12-626	626	-	-	1	-	684.40	-
	18"		Brass	8372-18-605	605	-	-	1	-	722.90	-
				8372-18-613	613	-	-	1	-	722.90	-
				8372-18-619	619	-	-	1	-	722.90	-
				8372-18-625	625	-	-	1	-	722.90	-
				8372-18-626	626	-	-	1	-	722.90	-
	24"		Brass	8372-24-605	605	-	-	1	-	748.70	-
				8372-24-613	613	-	-	1	-	748.70	-
				8372-24-619	619	-	-	1	-	748.70	-
				8372-24-625	625	-	-	1	-	748.70	-
				8372-24-626	626	-	-	1	-	748.70	-
8373 Brookshire Decorative Acorn Tip, Straight Pull 1" Dia. See page 65 for optional mounting types and pricing. 	12"		Brass	8373-12-605	605	-	-	1	-	684.50	-
				8373-12-613	613	-	-	1	-	684.50	-
				8373-12-619	619	-	-	1	-	684.50	-
				8373-12-625	625	-	-	1	-	684.50	-
				8373-12-626	626	-	-	1	-	684.40	-
	18"		Brass	8373-18-605	605	-	-	1	-	722.90	-
				8373-18-613	613	-	-	1	-	722.90	-
				8373-18-619	619	-	-	1	-	722.90	-
				8373-18-625	625	-	-	1	-	722.90	-
				8373-18-626	626	-	-	1	-	722.90	-
	24"		Brass	8373-24-605	605	-	-	1	-	748.70	-
				8373-24-613	613	-	-	1	-	748.70	-
				8373-24-619	619	-	-	1	-	748.70	-
				8373-24-625	625	-	-	1	-	748.70	-
				8373-24-626	626	-	-	1	-	748.70	-

Bold pricing indicates item is in stock and available for **Fast Track** and **ProXpress**

8400 Protection Plates Stocked Protection Plates

All protection plates come standard with 4 Beveled Edges and Counter Sunk Holes (B-CS) at no extra charge.

MODEL	SUBSTRATE	FINISH	PLATE SIZE	WEIGHT	MUST BE ORDERED IN MULTIPLE QTY	MUTIPLE QTY	PACKED PER BOX	LIST PRICE			
								EACH	PACKAGE		
8400	Aluminum	US28	8X34	---	---	---	---	\$29.42	---		
		Plastic	BLK	10 X 34	---	---	---	---	31.06	---	
	CLR		8 X 34	---	---	---	---	24.84	---		
	Brass	US3	6X34	---	---	---	---	---	76.90	---	
			8X34	---	---	---	---	---	96.82	---	
			10X34	---	---	---	---	---	121.02	---	
		US10	8X34	---	---	---	---	---	---	108.53	---
			10X34	---	---	---	---	---	---	135.66	---
		US10B	4X35	---	---	---	---	---	---	61.69	---
			6X34	---	---	---	---	---	---	87.39	---
			8X34	---	---	---	---	---	---	108.53	---
			8X35	---	---	---	---	---	---	114.91	---
			10X34	---	---	---	---	---	---	135.66	---
			10X34.5	---	---	---	---	---	---	143.64	---
			10X35	---	---	---	---	---	---	143.64	---
		US15	10X40	---	---	---	---	---	---	159.60	---
			10X46	---	---	---	---	---	---	183.54	---
			6X34	---	---	---	---	---	---	87.39	---
			8X34	---	---	---	---	---	---	110.82	---
		Stainless	US32	10X34	---	---	---	---	---	98.18	---
				US32D	4X34	---	---	---	---	---	18.85
	US32D		4X35	---	---	---	---	---	---	19.96	---
			4X41	---	---	---	---	---	---	23.29	---
			4X47	---	---	---	---	---	---	26.61	---
			6X30	---	---	---	---	---	---	24.95	---
			6X34	---	---	---	---	---	---	28.28	---
			6X35	---	---	---	---	---	---	29.94	---
			8X22	---	---	---	---	---	---	21.62	---
			8X26	---	---	---	---	---	---	25.56	---
			8X28	---	---	---	---	---	---	27.52	---
			8X30	---	---	---	---	---	---	29.48	---
			8X32	---	---	---	---	---	---	31.45	---
			8X34	---	---	---	---	---	---	33.41	---
			8X34.5	---	---	---	---	---	---	35.39	---
			8X35	---	---	---	---	---	---	35.39	---
			8X36	---	---	---	---	---	---	35.39	---
			8X38	---	---	---	---	---	---	37.35	---
			8X40	---	---	---	---	---	---	39.31	---
			8X41	---	---	---	---	---	---	41.28	---
			8X42	---	---	---	---	---	---	41.28	---
			8X46	---	---	---	---	---	---	45.21	---
			8X47	---	---	---	---	---	---	47.18	---
			10X17	---	---	---	---	---	---	27.03	---
			10X22	---	---	---	---	---	---	27.03	---
			10X23	---	---	---	---	---	---	29.48	---
			10X26	---	---	---	---	---	---	31.94	---
			10X28	---	---	---	---	---	---	34.40	---
			10X29	---	---	---	---	---	---	36.86	---
			10X30	---	---	---	---	---	---	36.86	---
	10X31		---	---	---	---	---	---	39.31	---	
10X32	---		---	---	---	---	---	39.31	---		
10X33	---	---	---	---	---	---	41.77	---			
10X34	---	---	---	---	---	---	41.77	---			
10X34.5	---	---	---	---	---	---	44.23	---			
10X35	---	---	---	---	---	---	44.23	---			
10X36	---	---	---	---	---	---	44.23	---			
10X37	---	---	---	---	---	---	46.68	---			
10X38	---	---	---	---	---	---	46.68	---			
10X39	---	---	---	---	---	---	49.14	---			
10X40	---	---	---	---	---	---	49.14	---			
10X40.5	---	---	---	---	---	---	51.60	---			
10X41	---	---	---	---	---	---	51.60	---			
10X42	---	---	---	---	---	---	51.60	---			
10X42.5	---	---	---	---	---	---	54.05	---			
10X43	---	---	---	---	---	---	54.05	---			
10X44	---	---	---	---	---	---	54.05	---			
10X46	---	---	---	---	---	---	56.51	---			
10X46.5	---	---	---	---	---	---	58.97	---			
10X47	---	---	---	---	---	---	58.97	---			
12X28	---	---	---	---	---	---	41.28	---			
12X34	---	---	---	---	---	---	50.13	---			

HINGES
 CONTINUOUS HINGES
 PIVOTS
 Numerical 1-059
 Numerical 59-437
 Numerical 438-1021
 Numerical 1152-8190
 Numerical 8200-9340

Bold pricing indicates item is in stock and available for **Fast Track** and **ProXpress**

8400 Protection Plates Stocked Protection Plates (continued)

All protection plates come standard with 4 Beveled Edges and Counter Sunk Holes (B-CS) at no extra charge.

MODEL	SUBSTRATE	FINISH	PLATE SIZE	WEIGHT	MUST BE ORDERED IN MULTIPLE QTY	MULTIPLE QTY	PACKED PER BOX	LIST PRICE	
								EACH	PACKAGE
8400 continued	Stainless continued	US32D continued	12X35	---	---	---	---	\$53.07	---
			12X40	---	---	---	---	58.97	---
			12X42	---	---	---	---	61.92	---
			12X46	---	---	---	---	67.81	---
			16X34	---	---	---	---	66.83	---
			16X40	---	---	---	---	78.62	---
			16X46	---	---	---	---	90.42	---
			18X34	---	---	---	---	81.61	---
			24X34	---	---	---	---	108.81	---
			30X34	---	---	---	---	136.02	---
			30X35	---	---	---	---	144.02	---
			30X40	---	---	---	---	160.02	---
			32X34	---	---	---	---	145.09	---
			34X34	---	---	---	---	154.15	---
			34X35	---	---	---	---	163.22	---
			34X36	---	---	---	---	163.22	---
			34X40	---	---	---	---	181.36	---
			34X46	---	---	---	---	208.56	---
			36X34	---	---	---	---	163.22	---
			36X35	---	---	---	---	172.82	---
36X40	---	---	---	---	192.02	---			
36X46	---	---	---	---	220.83	---			
8402	Stainless	US32D	10X34	---	---	---	---	57.52	---
			34X34	---	---	---	---	169.90	---
			34X46	---	---	---	---	224.31	---

For all other Protection Plates, see pricing in the table below. Options below are List Add per Hinge.

8400 Protection Plate (List Price (Per 100 Square Inches))

FINISH	SUBSTRATE	MAX SIZE	UNDER 8"	8" ≤ 16"	OVER 16" ≤ 36"	OVER 36" ≤ 48"
US32D	Stainless	48 x 48"	\$ 14.50	\$ 12.80	\$ 13.90	\$ 13.90
US32	Stainless	48 x 48"	31.70	30.10	30.70	30.70
US3	Brass	24 x 48"	39.30	37.10	49.00	NA
US4	Brass	24 x 48"	39.30	37.10	49.00	NA
US10	Brass	24 x 48"	43.80	41.60	54.70	NA
US10B	Brass	36 x 48"	44.60	41.60	54.70	NA
US15	Brass	24 x 48"	44.60	42.40	54.70	NA
US26	Brass	36 x 48"	43.10	41.00	54.70	NA
US26D	Brass	24 x 48"	43.10	41.00	54.70	NA
US28	Aluminum	48 x 48"	13.30	11.20	12.20	12.20
Clear	Plastic	48 x 48"	12.00	9.60	10.90	10.90
Black	Plastic	48 x 48"	12.00	9.60	10.90	10.90
654	Satin Stainless Steel	48 x 48"	12.30	11.10	12.00	12.00

Kickplates must be ordered in 1/2" increments

8400 Options

MODEL	DESCRIPTION	SIZE	LIST ADD PER PLATE
B-CS	Hand Bevel Four Edges (B4E) and Counter Sunk Holes		Standard
B-NH	No Mounting Holes - US32D, US32, US3, US4, US28, Clear, Black only		24.00
B-NHA	No Mounting Holes with Adhesive - US32D, US32, US3, US4, US28, Clear, Black only *not available on UL listed kickplates	12" and under	24.00
		over 12" up to 24"	50.00
TK-TX	Includes Self Drilling Tek Screws and Torx Brand Security Screws (package of 16 each)		12.00
ERS	Prepped for Extra Row of Screws (For extra mounting hole option, customer must specify location and quantity of holes required)		Consult Factory

MODEL	DESCRIPTION	SIZE	LIST ADD
8401	Gasket Tape Kit (sold separately)	Fits 8" x 34"	\$20.00 ea.
8402	UL Label Kickplate (not available on plastic kickplates)		17.00 ea.

Contact Ives Customer Service for pricing on additional sizes and finishes

Bold pricing indicates item is in stock and available for **Fast Track** and **ProXpress**

Door Plate Hundred Square Inch Sizing Chart

width

height	inches	22	24	26	28	30	32	34	36	38	40	42	44	46	48
4	0.88	0.96	1.04	1.12	1.2	1.28	1.36	1.44	1.52	1.6	1.68	1.76	1.84	1.92	
6	1.32	1.44	1.56	1.68	1.8	1.92	2.04	2.16	2.28	2.4	2.52	2.64	2.76	2.88	
8	1.76	1.92	2.08	2.24	2.4	2.56	2.72	2.88	3.04	3.2	3.36	3.52	3.68	3.84	
10	2.2	2.4	2.6	2.8	3	3.2	3.4	3.60	3.80	4	4.2	4.4	4.6	4.8	
12	2.64	2.88	3.12	3.36	3.6	3.84	4.08	4.32	4.56	4.8	5.04	5.28	5.52	5.76	
14	3.08	3.36	3.64	3.92	4.2	4.48	4.76	5.04	5.32	5.6	5.88	6.16	6.44	6.72	
16	3.52	3.84	4.16	4.48	4.8	5.12	5.44	5.76	6.08	6.4	6.72	7.04	7.36	7.68	
18	3.96	4.32	4.68	5.04	5.4	5.76	6.12	6.48	6.84	7.2	7.56	7.92	8.28	8.64	
20	4.4	4.8	5.2	5.6	6	6.4	6.8	7.20	7.60	8	8.4	8.8	9.2	9.6	
22	4.84	5.28	5.72	6.16	6.6	7.04	7.48	7.92	8.36	8.8	9.24	9.68	10.12	10.56	
24	5.28	5.76	6.24	6.72	7.2	7.68	8.16	8.64	9.12	9.6	10.08	10.56	11.04	11.52	
26	5.72	6.24	6.76	7.28	7.8	8.32	8.84	9.36	9.88	10.4	10.92	11.44	11.96	12.48	
28	6.16	6.72	7.28	7.84	8.4	8.96	9.52	10.08	10.64	11.2	11.76	12.32	12.88	13.44	
30	6.6	7.2	7.8	8.4	9	9.6	10.2	10.80	11.40	12	12.6	13.2	13.8	14.4	
32	7.04	7.68	8.32	8.96	9.6	10.24	10.88	11.52	12.16	12.8	13.44	14.08	14.72	15.36	
34	7.48	8.16	8.84	9.52	10.2	10.88	11.56	12.24	12.92	13.6	14.28	14.96	15.64	16.32	
36	7.92	8.64	9.36	10.08	10.8	11.52	12.24	12.96	13.68	14.4	15.12	15.84	16.56	17.28	
38	8.36	9.12	9.88	10.64	11.4	12.16	12.92	13.68	14.44	15.2	15.96	16.72	17.48	18.24	
40	8.8	9.6	10.4	11.2	12	12.8	13.6	14.40	15.20	16	16.8	17.6	18.4	19.2	
42	9.24	10.08	10.92	11.76	12.6	13.44	14.28	15.12	15.96	16.8	17.64	18.48	19.32	20.16	
44	9.68	10.56	11.44	12.32	13.2	14.08	14.96	15.84	16.72	17.6	18.48	19.36	20.24	21.12	
46	10.12	11.04	11.96	12.88	13.8	14.72	15.64	16.56	17.48	18.4	19.32	20.24	21.16	22.08	
48	10.56	11.52	12.48	13.44	14.4	15.36	16.32	17.28	18.24	19.2	20.16	21.12	22.08	23.04	

When pricing IVES Series 8400 Door Protection Plates to order, find the hundred square inch size on the chart above.

If ordering in increments not shown on above matrix, use the next larger size, height or width.

Example: 9 1/2" x 33 1/2" = 10 x 34 or 3.40 sq. inches.

For pricing, multiply square inch size by list price = 3.40 sq. inches X US32D list \$12.80 = \$43.52

Return Policy - requires prior approval, consult factory.

Residential Kickplates

MODEL	SUBSTRATE	PACKING	MODEL NUMBER	WEIGHT	ORDER QTY	BOX QTY	LIST PRICE	PKG PRICE
8400 Residential Kickplates	Aluminum	BOX PACK	8400PA28 6X34		1	5	\$15.10	-
			8400PA28 8X34		1	5	28.20	-
		CARDED	C8400PA28 6X30		5	5	-	\$122.00
			C8400PA28 6X34		5	5	-	129.90
			SC8400PA28 8X34		5	5	-	157.60
			SC8400PA3 6X30		5	5	-	173.10
			SC8400PA3 6X34		5	5	-	181.30
			SC8400PA3 8X34		5	5	-	220.40
			SC8400PA-619 8X34		5	5	-	221.40
	SC8400PA-716 8X34		5	5	-	215.90		
	Brass	CARDED	C8400B3 6X30		5	5	-	267.20
			C8400B3 6X34		5	5	-	283.20
			SC8400B3 8X34		5	5	-	314.70
			SC8400B-619 6X30		5	5	-	283.20
			SC8400B-716 6X30		5	5	-	283.20

Note: All items in price book available as special order.

Contact Ives Customer Service for pricing on additional sizes and finishes

Bold pricing indicates item is in stock and available for **Fast Track** and **ProXpress**

HINGES

CONTINUOUS HINGES

PIVOTS



Numerical 1-059

Numerical 59-437



Numerical 438-1021

Numerical 1152-8190

Numerical 8200-9340

MODEL	PULL CTC	SUBSTRATE	MODEL NUMBER	BHMA Finish	WEIGHT	Must Be Ordered in Multiple QTY	Multiple QTY	List Price	
								EACH	PACKAGE
8700 Greenwich Decorative Arc Straight Pull 3/4" Dia. See page 65 for optional mounting types and pricing. 	9"	Brass	8700-09-605	605	-	-	1	\$206.30	-
			8700-09-613	613	-	-	1	206.30	-
			8700-09-619	619	-	-	1	206.30	-
			8700-09-625	625	-	-	1	206.30	-
			8700-09-626	626	-	-	1	206.30	-
	12"	Brass	8700-12-605	605	-	-	1	214.80	-
			8700-12-613	613	-	-	1	214.80	-
			8700-12-619	619	-	-	1	214.80	-
			8700-12-625	625	-	-	1	214.80	-
			8700-12-626	626	-	-	1	214.80	-
	18"	Brass	8700-18-605	605	-	-	1	247.30	-
			8700-18-613	613	-	-	1	247.30	-
			8700-18-619	619	-	-	1	247.30	-
			8700-18-625	625	-	-	1	247.30	-
			8700-18-626	626	-	-	1	247.30	-
	24"	Brass	8700-24-605	605	-	-	1	247.30	-
			8700-24-613	613	-	-	1	247.30	-
			8700-24-619	619	-	-	1	247.30	-
			8700-24-625	625	-	-	1	247.30	-
			8700-24-626	626	-	-	1	247.30	-
9"	Brass	8800-09-605	605	-	-	1	265.20	-	
		8800-09-613	613	-	-	1	265.20	-	
		8800-09-619	619	-	-	1	265.20	-	
		8800-09-625	625	-	-	1	265.20	-	
		8800-09-626	626	-	-	1	265.20	-	
12"	Brass	8800-12-605	605	-	-	1	281.40	-	
		8800-12-613	613	-	-	1	281.40	-	
		8800-12-619	619	-	-	1	281.40	-	
		8800-12-625	625	-	-	1	281.40	-	
		8800-12-626	626	-	-	1	281.40	-	
18"	Brass	8800-18-605	605	-	-	1	308.50	-	
		8800-18-613	613	-	-	1	308.50	-	
		8800-18-619	619	-	-	1	308.50	-	
		8800-18-625	625	-	-	1	308.50	-	
		8800-18-626	626	-	-	1	308.50	-	
24"	Brass	8800-24-605	605	-	-	1	378.70	-	
		8800-24-613	613	-	-	1	378.70	-	
		8800-24-619	619	-	-	1	378.70	-	
		8800-24-625	625	-	-	1	378.70	-	
		8800-24-626	626	-	-	1	378.70	-	
12"	Brass	8848-12-605	605	-	-	1	513.20	-	
		8848-12-613	613	-	-	1	513.20	-	
		8848-12-619	619	-	-	1	513.20	-	
		8848-12-625	625	-	-	1	513.20	-	
		8848-12-626	626	-	-	1	513.20	-	
12"	Stainless Steel	8848-12-630	630	-	-	1	427.80	-	
8975 Rhodes Decorative Straight Pull - 1 1/4" w x 1/2" thick. See page 65 for optional mounting types and pricing. 	12"	Aluminum	8975-12-628	628	-	-	1	513.20	-

Bold pricing indicates item is in stock and available for **Fast Track** and **ProXpress**

MODEL	PULL CTC	PUSH CTC	SUBSTRATE	FINISH	MODEL NUMBER	DESCRIPTION	WEIGHT	ORDER QTY	BOX QTY	LIST PRICE			
9100HD Push Bar, 1" Round, 2-1/2" Projection Pull Plate Custom Sizing Available in 1" increments. Fractional increments available as Engineered Specials. See page 65 for pricing Antimicrobial Coating US26D-AM or US32D-AM available. Standard with NS mounting; See page 65 for optional mounting types and pricing. 	28"	28"	Brass	605	9100HD-28-US3					\$225.70			
				606	9100HD-28-US4				225.70				
				612	9100HD-28-US10				266.00				
				613	9100HD-28-US10B				266.00				
				619	9100HD-28-US15				266.00				
				625	9100HD-28-US26				232.90				
			626	9100HD-28-US26D				232.90					
			Stainless	629	9100HD-28-32				184.70				
				630	9100HD-28-32D				162.90				
			316 Stainless	629-316	9100HD-28-32-316				212.60				
				630-316	9100HD-28-32D-316				187.60				
			33"	Brass	33"	Brass	605	9100HD-33-US3					225.70
	606	9100HD-33-US4								225.70			
	612	9100HD-33-US10								266.00			
	613	9100HD-33-US10B								266.00			
	619	9100HD-33-US15								266.00			
	625	9100HD-33-US26								232.90			
	626	9100HD-33-US26D					232.90						
Stainless	629	9100HD-33-32					248.10						
	630	9100HD-33-32D					162.90						
316 Stainless	629-316	9100HD-33-32-316					285.60						
	630-316	9100HD-33-32D-316					187.60						
9103EZHD Push / Pull Combo 1" Round (8103EZ Pull + 9100 Push) Custom Sizing Available in 1" increments. Fractional increments available as Engineered Specials. See page 65 for pricing Antimicrobial Coating US26D-AM or US32D-AM available. 	8"	28"		Brass	605	9103EZHD-28-8-US3					342.40		
			606		9103EZHD-28-8-US4				342.40				
			612		9103EZHD-28-8-US10				400.60				
			613		9103EZHD-28-8-US10B				400.60				
			619		9103EZHD-28-8-US15				400.60				
			625		9103EZHD-28-8-US26				356.80				
			626	9103EZHD-28-8-US26D				356.80					
			316 Stainless	629-316	9103EZHD-28-8-32-316				330.70				
				630-316	9103EZHD-28-8-32D-316				293.60				
			10"	28"	Brass	Brass	605	9103EZHD-28-0-US3					323.20
							606	9103EZHD-28-0-US4				340.90	
							612	9103EZHD-28-0-US10				340.90	
	613	9103EZHD-28-0-US10B								340.90			
	619	9103EZHD-28-0-US15								340.90			
	625	9103EZHD-28-0-US26								340.90			
	626	9103EZHD-28-0-US26D				340.90							
	316 Stainless	629-316	9103EZHD-28-0-32-316				339.80						
		630-316	9103EZHD-28-0-32D-316				302.40						
	12"	28"	Brass	Brass	605	9103EZHD-28-2-US3					337.80		
					606	9103EZHD-28-2-US4				337.80			
					612	9103EZHD-28-2-US10				392.40			
					613	9103EZHD-28-2-US10B				392.40			
					619	9103EZHD-28-2-US15				392.40			
					625	9103EZHD-28-2-US26				348.60			
	626	9103EZHD-28-2-US26D				348.60							
	316 Stainless	629-316	9103EZHD-28-2-32-316				348.80						
		630-316	9103EZHD-28-2-32D-316				311.10						
	8"	33"	Brass	Brass	605	9103EZHD-33-8-US3					342.40		
					606	9103EZHD-33-8-US4				342.40			
					612	9103EZHD-33-8-US10				400.60			
					613	9103EZHD-33-8-US10B				400.60			
					619	9103EZHD-33-8-US15				400.60			
					625	9103EZHD-33-8-US26				356.80			
	626	9103EZHD-33-8-US26D				356.80							
	316 Stainless	629-316	9103EZHD-33-8-32-316				403.60						
		630-316	9103EZHD-33-8-32D-316				293.60						
10"	33"	Brass	Brass	605	9103EZHD-33-0-US3					330.70			
				606	9103EZHD-33-0-US4				330.70				
				612	9103EZHD-33-0-US10				381.50				
				613	9103EZHD-33-0-US10B				381.50				
				619	9103EZHD-33-0-US15				340.90				
				625	9103EZHD-33-0-US26				341.70				
626	9103EZHD-33-0-US26D				341.70								
316 Stainless	629-316	9103EZHD-33-0-32-316				412.70							
	630-316	9103EZHD-33-0-32D-316				302.40							

HINGES
 CONTINUOUS HINGES
 PIVOTS
 Numerical 1-059
 Numerical 59-437
 Numerical 438-1021
 Numerical 1152-8190
 Numerical 8200-9340

Bold pricing indicates item is in stock and available for **Fast Track** and **ProXpress**

HINGES

CONTINUOUS HINGES

PIVOTS

Numerical 1-059

Numerical 59-437

Numerical 438-1021

Numerical 1152-8190

Numerical 8200-9340

MODEL	PULL CTC	PUSH CTC	SUBSTRATE	FINISH	MODEL NUMBER	DESCRIPTION	WEIGHT	ORDER QTY	BOX QTY	LIST PRICE	
9103EZHD Push / Pull Combo 1" Round <i>Continued from previous page.</i>	12"	33"	Brass	605	9103EZHD-33-2-US3					\$337.80	
				606	9103EZHD-33-2-US4				337.80		
				612	9103EZHD-33-2-US10			392.40			
				613	9103EZHD-33-2-US10B			392.40			
				619	9103EZHD-33-2-US15			392.40			
				625	9103EZHD-33-2-US26			348.60			
			316 Stainless	626	9103EZHD-33-2-US26D			348.60			
				629-316	9103EZHD-33-2-32-316			421.70			
				630-316	9103EZHD-33-2-32D-316			311.10			
9145EZHD Push / Pull Combo 1" Round (8145EZHD Pull + 9100HD Push) <i>Custom Sizing Available in 1" increments</i> <i>Fractional increments available as Engineered Specials</i> <i>See page 65 for pricing</i> <i>Antimicrobial Coating US26D-AM or US32D-AM available.</i> <i>See page 65 for optional mounting types and pricing.</i>	8"	28"	Brass	605	9145EZHD-28-8-USB3					372.20	
				606	9145EZHD-28-8-US4				372.20		
				612	9145EZHD-28-8-US10			431.50			
				613	9145EZHD-28-8-US10B			431.50			
				619	9145EZHD-28-8-US15			431.50			
				625	9145EZHD-28-8-US26			386.80			
			316 Stainless	626	9145EZHD-28-8-US26D			386.80			
				629-316	9145EZHD-28-8-32-316			365.50			
				630-316	9145EZHD-28-8-32D-316			317.90			
	10"	28"	Brass	605	9145EZHD-28-0-US3						383.50
				606	9145EZHD-28-0-US4				383.50		
				612	9145EZHD-28-0-US10			439.30			
				613	9145EZHD-28-0-US10B			439.30			
				619	9145EZHD-28-0-US15			439.30			
				625	9145EZHD-28-0-US26			398.40			
			316 Stainless	626	9145EZHD-28-0-US26D			398.40			
				629-316	9145EZHD-28-0-32-316			374.60			
				630-316	9145EZHD-28-0-32D-316			327.00			
	12"	28"	Brass	605	9145EZHD-28-2-US3						391.30
				606	9145EZHD-28-2-US4				391.30		
				612	9145EZHD-28-2-US10			450.80			
				613	9145EZHD-28-2-US10B			450.80			
				619	9145EZHD-28-2-US15			450.80			
				625	9145EZHD-28-2-US26			410.20			
316 Stainless			626	9145EZHD-28-2-US26D			410.20				
			629-316	9145EZHD-28-2-32-316			383.70				
			630-316	9145EZHD-28-2-32D-316			336.10				
18"	28"	Brass	605	9145EZHD-28-18-US3						441.10	
			606	9145EZHD-28-18-US4				441.10			
			612	9145EZHD-28-18-US10			504.40				
			613	9145EZHD-28-18-US10B			504.40				
			619	9145EZHD-28-18-US15			504.40				
			625	9145EZHD-28-18-US26			459.60				
		316 Stainless	626	9145EZHD-28-18-US26D			459.60				
			629-316	9145EZHD-28-18-32-316			435.50				
			630-316	9145EZHD-28-18-32D-316			388.10				
8"	33"	Brass	605	9145EZHD-33-8-US3						372.20	
			606	9145EZHD-33-8-US4				372.20			
			612	9145EZHD-33-8-US10			431.50				
			613	9145EZHD-33-8-US10B			431.50				
			619	9145EZHD-33-8-US15			431.50				
			625	9145EZHD-33-8-US26			386.80				
		316 Stainless	626	9145EZHD-33-8-US26D			386.80				
			629-316	9145EZHD-33-8-32-316			438.50				
			630-316	9145EZHD-33-8-32D-316			317.90				
10"	33"	Brass	605	9145EZHD-33-0-US3						383.50	
			606	9145EZHD-33-0-US4				383.50			
			612	9145EZHD-33-0-US10			439.30				
			613	9145EZHD-33-0-US10B			439.30				
			619	9145EZHD-33-0-US15			439.30				
			625	9145EZHD-33-0-US26			398.40				
		316 Stainless	626	9145EZHD-33-0-US26D			398.40				
			629-316	9145EZHD-33-0-32-316			447.50				
			630-316	9145EZHD-33-0-32D-316			327.00				
12"	33"	Brass	605	9145EZHD-33-2-US3						391.30	
			606	9145EZHD-33-2-US4				391.30			
			612	9145EZHD-33-2-US10			450.80				
			613	9145EZHD-33-2-US10B			450.80				
			619	9145EZHD-33-2-US15			450.80				
			625	9145EZHD-33-2-US26			410.20				
		316 Stainless	626	9145EZHD-33-2-US26D			410.20				
			629-316	9145EZHD-33-2-32-316			456.60				
			630-316	9145EZHD-33-2-32D-316			336.10				

*Continued on next page.**Bold pricing indicates item is in stock and available for Fast Track and ProXpress*

MODEL	PULL CTC	PUSH CTC	SUBSTRATE	FINISH	MODEL NUMBER	DESCRIPTION	WEIGHT	ORDER QTY	BOX QTY	LIST PRICE
9145EZHD Push / Pull Combo 1" Round <i>Continued from previous page.</i>	18"	33"	Brass	605	9145EZHD-33-18-US3					\$441.10
				606	9145EZHD-33-18-US4				441.10	
				612	9145EZHD-33-18-US10			504.40		
				613	9145EZHD-33-18-US10B			504.40		
				619	9145EZHD-33-18-US15			504.40		
				625	9145EZHD-33-18-US26			459.60		
			626	9145EZHD-33-18-US26D			459.60			
			316 Stainless	629-316	9145EZHD-33-18-32-316			508.40		
				630-316	9145EZHD-33-18-32D-316			388.10		
			9190HD Push / Pull Combo 1" Round (8190HD Pull + 9100HD PUSH) Custom Sizing Available in 1" increments. Fractional increments available as Engineered Specials. See page 65 for pricing Antimicrobial Coating US26D-AM or US32D-AM available. <i>See page 65 for optional mounting types and pricing.</i>	8"	28"	Brass	605	9190HD-28-8-US3		
606	9190HD-28-8-US4							348.60		
612	9190HD-28-8-US10							407.00		
613	9190HD-28-8-US10B							407.00		
619	9190HD-28-8-US15							400.40		
625	9190HD-28-8-US26							363.30		
626	9190HD-28-8-US26D						363.30			
Stainless	629	9190HD-28-8-US32						294.70		
	630	9190HD-28-8-US32D				254.80				
10"	28"	Brass		605	9190HD-28-0-US3					359.60
				606	9190HD-28-0-US4			359.60		
				612	9190HD-28-0-US10			414.00		
				613	9190HD-28-0-US10B			414.00		
				619	9190HD-28-0-US15			407.90		
				625	9190HD-28-0-US26			374.20		
		626		9190HD-28-0-US26D			374.20			
		Stainless		629	9190HD-28-0-US32			301.70		
630	9190HD-28-0-US32D					262.10				
12"	28"	Brass		605	9190HD-28-2-US3					367.10
				606	9190HD-28-2-US4			367.10		
				612	9190HD-28-2-US10			425.20		
				613	9190HD-28-2-US10B			425.20		
				619	9190HD-28-2-US15			418.70		
				625	9190HD-28-2-US26			385.20		
		626	9190HD-28-2-US26D			385.20				
		Stainless	629	9190HD-28-2-US32			372.50			
630	9190HD-28-2-US32D				269.10					
18"	28"	Brass	605	9190HD-28-18-US3					407.90	
			606	9190HD-28-18-US4			407.90			
			612	9190HD-28-18-US10			469.60			
			613	9190HD-28-18-US10B			469.60			
			619	9190HD-28-18-US15			469.60			
			625	9190HD-28-18-US26			425.90			
		626	9190HD-28-18-US26D			425.90				
		Stainless	629	9190HD-28-18-US32			344.30			
630	9190HD-28-18-US32D				304.30					
8"	33"	Brass	605	9190HD-33-8-US3					348.60	
			606	9190HD-33-8-US4			348.60			
			612	9190HD-33-8-US10			407.00			
			613	9190HD-33-8-US10B			407.00			
			619	9190HD-33-8-US15			400.40			
			625	9190HD-33-8-US26			363.30			
		626	9190HD-33-8-US26D			363.30				
		Stainless	629	9190HD-33-8-US32			294.70			
630	9190HD-33-8-US32D				254.80					
10"	33"	Brass	605	9190HD-33-0-US3					359.60	
			606	9190HD-33-0-US4			359.60			
			612	9190HD-33-0-US10			414.00			
			613	9190HD-33-0-US10B			414.00			
			619	9190HD-33-0-US15			407.90			
			625	9190HD-33-0-US26			374.20			
		626	9190HD-33-0-US26D			374.20				
		Stainless	629	9190HD-33-0-US32			301.70			
630	9190HD-33-0-US32D				262.10					
12"	33"	Brass	605	9190HD-33-2-US3					367.10	
			606	9190HD-33-2-US4			367.10			
			612	9190HD-33-2-US10			425.20			
			613	9190HD-33-2-US10B			425.20			
			619	9190HD-33-2-US15			418.70			
			625	9190HD-33-2-US26			385.20			
		626	9190HD-33-2-US26D			385.20				
		Stainless	629	9190HD-33-2-US32			372.50			
630	9190HD-33-2-US32D				269.10					
18"	33"	Brass	605	9190HD-33-18-US3					407.90	
			606	9190HD-33-18-US4			407.90			
			612	9190HD-33-18-US10			469.60			
			613	9190HD-33-18-US10B			469.60			
			619	9190HD-33-18-US15			469.60			
			625	9190HD-33-18-US26			425.90			
		626	9190HD-33-18-US26D			425.90				
		Stainless	629	9190HD-33-18-US32			407.70			
630	9190HD-33-18-US32D				304.30					



HINGES
 CONTINUOUS HINGES
 PIVOTS
 Numerical 1-059
 Numerical 59-437
 Numerical 438-1021
 Numerical 1152-8190
 Numerical 8200-9340

Bold pricing indicates item is in stock and available for Fast Track and ProXpress

HINGES
 CONTINUOUS HINGES
 PIVOTS
 Numerical 1-059
 Numerical 59-437
 Numerical 438-1021
 Numerical 1152-8190
 Numerical 8200-9340

MODEL	PULL CTC	PUSH CTC	SUBSTRATE	FINISH	MODEL NUMBER	DESCRIPTION	WEIGHT	ORDER QTY	BOX QTY	LIST PRICE			
9190EZHD Push / Pull Combo 1" Round (8190EZHD Pull + 9100HD Push) Custom Sizing Available in 1" increments Fractional increments available as Engineered Specials See page 65 for pricing Antimicrobial Coating US26D-AM or US32D-AM available.	8"	28"	Brass	605	9190EZHD-28-8-USB3					\$372.20			
				606	9190EZHD-28-8-US4				372.20				
				612	9190EZHD-28-8-US10				431.50				
				613	9190EZHD-28-8-US10B				431.50				
				619	9190EZHD-28-8-US15				431.50				
				625	9190EZHD-28-8-US26				386.80				
				626	9190EZHD-28-8-US26D				386.80				
			316 Stainless	629-316	9190EZHD-28-8-32-316				365.50				
				630-316	9190EZHD-28-8-32D-316				317.90				
				Brass	10"	28"	605	9190EZHD-28-0-US3					383.50
							606	9190EZHD-28-0-US4				383.50	
							612	9190EZHD-28-0-US10				439.30	
							613	9190EZHD-28-0-US10B				439.30	
							619	9190EZHD-28-0-US15				439.30	
	625	9190EZHD-28-0-US26							398.40				
	626	9190EZHD-28-0-US26D							398.40				
	316 Stainless	629-316	9190EZHD-28-0-32-316						374.60				
		630-316	9190EZHD-28-0-32D-316						327.00				
	12"	28"	Brass	605			9190EZHD-28-2-US3					391.30	
				606			9190EZHD-28-2-US4				391.30		
				612			9190EZHD-28-2-US10				450.80		
				613			9190EZHD-28-2-US10B				450.80		
				619			9190EZHD-28-2-US15				450.80		
				625	9190EZHD-28-2-US26				410.20				
				626	9190EZHD-28-2-US26D				410.20				
			316 Stainless	629-316	9190EZHD-28-2-32-316				383.70				
				630-316	9190EZHD-28-2-32D-316				336.10				
				18"	28"	Brass	605	9190EZHD-28-18-US3					441.10
606							9190EZHD-28-18-US4				441.10		
612							9190EZHD-28-18-US10				504.40		
613							9190EZHD-28-18-US10B				504.40		
619							9190EZHD-28-18-US15				504.40		
625	9190EZHD-28-18-US26							459.60					
626	9190EZHD-28-18-US26D							459.60					
316 Stainless	629-316	9190EZHD-28-18-32-316						435.50					
	630-316	9190EZHD-28-18-32D-316						388.10					
	8"	33"	Brass			605	9190EZHD-33-8-US3					372.20	
						606	9190EZHD-33-8-US4				372.20		
						612	9190EZHD-33-8-US10				431.50		
						613	9190EZHD-33-8-US10B				431.50		
						619	9190EZHD-33-8-US15				431.50		
625				9190EZHD-33-8-US26				386.80					
626				9190EZHD-33-8-US26D				386.80					
316 Stainless			629-316	9190EZHD-33-8-32-316				438.50					
			630-316	9190EZHD-33-8-32D-316				317.90					
			10"	33"	Brass	605	9190EZHD-33-0-US3					383.50	
						606	9190EZHD-33-0-US4				383.50		
						612	9190EZHD-33-0-US10				439.30		
						613	9190EZHD-33-0-US10B				439.30		
						619	9190EZHD-33-0-US15				439.30		
625	9190EZHD-33-0-US26							398.40					
626	9190EZHD-33-0-US26D							398.40					
316 Stainless	629-316	9190EZHD-33-0-32-316						447.50					
	630-316	9190EZHD-33-0-32D-316						327.00					
12"	33"	Brass			605	9190EZHD-33-2-US3					391.30		
					606	9190EZHD-33-2-US4				391.30			
					612	9190EZHD-33-2-US10				450.80			
					613	9190EZHD-33-2-US10B				450.80			
					619	9190EZHD-33-2-US15				450.80			
			625	9190EZHD-33-2-US26				410.20					
			626	9190EZHD-33-2-US26D				410.20					
		316 Stainless	629-316	9190EZHD-33-2-32-316				456.60					
			630-316	9190EZHD-33-2-32D-316				336.10					
			18"	33"	Brass	605	9190EZHD-33-18-US3					441.10	
						606	9190EZHD-33-18-US4				441.10		
						612	9190EZHD-33-18-US10				504.40		
						613	9190EZHD-33-18-US10B				504.40		
						619	9190EZHD-33-18-US15				504.40		
625	9190EZHD-33-18-US26							459.60					
626	9190EZHD-33-18-US26D							459.60					
316 Stainless	629-316	9190EZHD-33-18-32-316						508.40					
	630-316	9190EZHD-33-18-32D-316						388.10					

Contact Ives Customer Service for pricing on additional sizes and finishes

Bold pricing indicates item is in stock and available for **Fast Track** and **ProXpress**

Offset Long Pulls

	Length	Pull CTC	BHMA	List
9264 (Round Tip) or 9264F (Flat Tip)	12"	8"	605	\$372.20
	12"	8"	606	372.20
	12"	8"	613	383.10
	12"	8"	629-316	377.70
	12"	8"	630-316	317.40
9264 (Round Tip) or 9264F (Flat Tip)	18"	12"	605	426.90
	18"	12"	606	426.90
	18"	12"	613	437.90
	18"	12"	629-316	421.50
	18"	12"	630-316	344.80
9264 (Round Tip) or 9264F (Flat Tip)	24"	18"	605	481.60
	24"	18"	606	481.60
	24"	18"	613	492.60
	24"	18"	629-316	465.30
	24"	18"	630-316	372.20
9264 (Round Tip) or 9264F (Flat Tip)	36"	20"	605	721.60
	36"	20"	606	752.20
	36"	20"	613	794.40
	36"	20"	629-316	730.40
	36"	20"	630-316	491.60
9264 (Round Tip) or 9264F (Flat Tip)	72"	56"	605	883.90
	72"	56"	606	883.90
	72"	56"	613	919.20
	72"	56"	629-316	858.20
	72"	56"	630-316	587.50

Straight Long Pulls

9266 (Round Tip) or 9266F (Flat Tip)	12"	8"	605	\$295.60
	12"	8"	606	295.60
	12"	8"	613	301.00
	12"	8"	629-316	295.60
	12"	8"	630-316	235.30
9266 (Round Tip) or 9266F (Flat Tip)	18"	12"	605	350.30
	18"	12"	606	350.30
	18"	12"	613	355.70
	18"	12"	629-316	339.40
	18"	12"	630-316	262.70
9266 (Round Tip) or 9266F (Flat Tip)	24"	18"	605	405.00
	24"	18"	606	405.00
	24"	18"	613	410.40
	24"	18"	629-316	383.10
	24"	18"	630-316	290.10
9266 (Round Tip) or 9266F (Flat Tip)	36"	20"	605	561.90
	36"	20"	606	585.70
	36"	20"	613	600.50
	36"	20"	629-316	568.70
	36"	20"	630-316	411.10
9266 (Round Tip) or 9266F (Flat Tip)	72"	56"	605	716.50
	72"	56"	606	716.50
	72"	56"	613	724.80
	72"	56"	629-316	696.60
	72"	56"	630-316	514.20

See Next Page for Long Pull Options Pricing
 - Custom Lengths, Center to Center, and Finishes
 - Additional Mounting Brackets
 See Page 65 for Optional Mounting Types and Pricing

HINGES

CONTINUOUS
HINGES

PIVOTS

Numerical
1-059

Numerical
59-437

Numerical
438-1021

Numerical
1152-8190

Numerical
8200-9340

Contact Ives Customer Service for pricing on additional sizes and finishes

Bold pricing indicates item is in stock and available for **Fast Track** and **ProXpress**

Long Pull Options

Custom Lengths*		BHMA	List
· Order in 1" increments. List price for 1" increments between 12" and 72" use next larger size list price.			
· Greater than 72", use list price add per inch charge per finish.		606/605	\$58.00
		613	66.00
		629-316	69.00
		630-316	13.00
· If fractional lengths are required, use the following list adder. For pulls less than 72" long, use the next higher standard length price plus the list adder for pricing. For pulls greater than 72", use the 72" price plus the price add per inch plus the fractional list adder.			158.00
Custom Center to Center*		BHMA	List
· If not specified, standard center to center length for pulls 36" or longer, center to center length is 16" less than total pull length. Center to Center length must be specified for lengths less than 36"			
· For non standard center to center lengths or locations on standard length pulls, use the following list adder. Consult factory if the center to center length is less than half the total pull length. If the fractional custom length adder is being applied, then the custom center to center will not be applied			158.00
Custom Finishes*		BHMA	List
Custom painting & Antimicrobial Coating <i>US32D-AM only</i>	Contact customer service for size availability, pricing, and color approval. Additional lead time up to 6 weeks may be needed.		
*Return Policy - requires prior approval, consult factory			
Optional Mounting Hardware		BHMA	List
MB	Additional Mounting Bracket, list price adder per bracket <i>Unless specified, additional mounting brackets are centered on pull. Mounting Bracket and list adder are required for pulls over 96".</i>		141.00
See page 65 for Optional mounting packages			

HINGES

CONTINUOUS
HINGES

PIVOTS

Numerical
1-059Numerical
59-437Numerical
438-1021Numerical
1152-8190Numerical
8200-9340

Bold pricing indicates item is in stock and available for **Fast Track** and **ProXpress**

IVES ARCHITECTURAL HARDWARE - Parts Price List

Description	Finish	Part No.	List Price Each
HINGES Item 3CB1, 3PB1, 3SP1			
Hinge Mtg Pkg	605(US3), 632(US3), 633(US4)	HGPART.1001	3.00
Hinge Mtg Pkg	639(US10)	HGPART.1002	3.00
Hinge Mtg Pkg	600(USP),630(US32D),651(US26)	HGPART.1003	3.00
Hinge Mtg Pkg	643(US11)	HGPART.1004	3.00
Hinge Security Mtg Pkg	-	HGPART.1005	20.60
Hinge MS Mtg Screws Pkg of 100 - Steel	600(USP)	HGPART.1026	5.40
Hinge MS Mtg Screws Pkg of 100 - Brass	605(US3)	HGPART.1008	10.90
Hinge MS Mtg Screws Pkg of 100 - Steel	632(US3)	HGPART.1018	5.40
Hinge MS Mtg Screws Pkg of 100 - Brass	606(US4)	HGPART.1032	10.90
Hinge MS Mtg Screws Pkg of 100 - Steel	633(US4)	HGPART.1035	5.40
Hinge MS Mtg Screws Pkg of 100 - Brass	612(US10)	HGPART.1010	10.90
Hinge MS Mtg Screws Pkg of 100 - Steel	639(US10)	HGPART.1019	5.40
Hinge MS Mtg Screws Pkg of 100 - Brass	613(US10B)	HGPART.1011	10.90
Hinge MS Mtg Screws Pkg of 100 - Steel	640(US10B)	HGPART.1020	5.40
Hinge MS Mtg Screws Pkg of 100 - Steel	641(US10A)	HGPART.1028	5.40
Hinge MS Mtg Screws Pkg of 100 - Steel	643(US11)	HGPART.1029	5.40
Hinge MS Mtg Screws Pkg of 100 - Brass	619(US15)	HGPART.1009	10.90
Hinge MS Mtg Screws Pkg of 100 - Steel	646(US15)	HGPART.1021	5.40
Hinge MS Mtg Screws Pkg of 100 - Brass	625(US26)	HGPART.1033	10.90
Hinge MS Mtg Screws Pkg of 100 - Steel	651(US26)	HGPART.1036	5.40
Hinge MS Mtg Screws Pkg of 100 - Brass	626(US26D)	HGPART.1034	10.90
Hinge MS Mtg Screws Pkg of 100 - Steel	652(US26D)	HGPART.1037	5.40
Hinge MS Mtg Screws Pkg of 100 - Stainless Steel	630(US32D)	HGPART.1016	10.90
Hinge WS Mtg Screws Pkg of 100 - Steel	600(USP)	HGPART.1027	5.40
Hinge WS Mtg Screws Pkg of 100 - Brass	605(US3)	HGPART.1012	21.70
Hinge WS Mtg Screws Pkg of 100 - Steel	632(US3)	HGPART.1022	5.40
Hinge WS Mtg Screws Pkg of 100 - Brass	606(US4)	HGPART.1038	23.10
Hinge WS Mtg Screws Pkg of 100 - Steel	633(US4)	HGPART.1041	5.40
Hinge WS Mtg Screws Pkg of 100 - Brass	612(US10)	HGPART.1014	23.10
Hinge WS Mtg Screws Pkg of 100 - Steel	639(US10)	HGPART.1023	5.40
Hinge WS Mtg Screws Pkg of 100 - Brass	613(US10B)	HGPART.1015	23.10
Hinge WS Mtg Screws Pkg of 100 - Steel	640(US10B)	HGPART.1024	5.40
Hinge WS Mtg Screws Pkg of 100 - Steel	641(US10A)	HGPART.1030	5.40
Hinge WS Mtg Screws Pkg of 100 - Steel	643(US11)	HGPART.1031	5.40
Hinge WS Mtg Screws Pkg of 100 - Brass	619(US15)	HGPART.1013	21.70
Hinge WS Mtg Screws Pkg of 100 - Steel	646(US15)	HGPART.1025	5.40
Hinge WS Mtg Screws Pkg of 100 - Brass	625(US26)	HGPART.1039	21.70
Hinge WS Mtg Screws Pkg of 100 - Steel	651(US26)	HGPART.1042	5.40
Hinge WS Mtg Screws Pkg of 100 - Brass	626(US26D)	HGPART.1040	21.70
Hinge WS Mtg Screws Pkg of 100 - Steel	652(US26D)	HGPART.1043	5.40
Hinge WS Mtg Screws Pkg of 100 - Stainless Steel	630(US32D)	HGPART.1017	21.70
HINGES Item 5BB1, 5BB1SC, 5PB1			
Hinge Mtg Pkg	605(US3), 632(US3), 633(US4)	HGPART.1001	3.00
Hinge Mtg Pkg	639(US10)	HGPART.1002	3.00
Hinge Mtg Pkg	600(USP),630(US32D),651(US26), 652(US26D)	HGPART.1003	3.00
Hinge Mtg Pkg	643(US11)	HGPART.1004	3.00
Hinge Security Mtg Pkg	-	HGPART.1005	20.60
Hinge MS Mtg Screws Pkg of 100 - Steel	600(USP)	HGPART.1026	5.40
Hinge MS Mtg Screws Pkg of 100 - Brass	605(US3)	HGPART.1008	10.90
Hinge MS Mtg Screws Pkg of 100 - Steel	632(US3)	HGPART.1018	5.40
Hinge MS Mtg Screws Pkg of 100 - Brass	606(US4)	HGPART.1032	10.90
Hinge MS Mtg Screws Pkg of 100 - Steel	633(US4)	HGPART.1035	5.40
Hinge MS Mtg Screws Pkg of 100 - Brass	612(US10)	HGPART.1010	10.90

Contact Ives Customer Service for pricing on additional sizes and finishes

Bold pricing indicates item is in stock and available for **Fast Track** and **ProXpress**

IVES ARCHITECTURAL HARDWARE - Parts Price List

Description	Finish	Part No.	List Price Each
HINGES Item 5BB1, 5BB1SC, 5PB1 (Continued)			
Hinge MS Mtg Screws Pkg of 100 - Steel	639(US10)	HGPART.1019	5.40
Hinge MS Mtg Screws Pkg of 100 - Brass	613(US10B)	HGPART.1011	10.90
Hinge MS Mtg Screws Pkg of 100 - Steel	640(US10B)	HGPART.1020	5.40
Hinge MS Mtg Screws Pkg of 100 - Steel	641(US10A)	HGPART.1028	5.40
Hinge MS Mtg Screws Pkg of 100 - Steel	643(US11)	HGPART.1029	5.40
Hinge MS Mtg Screws Pkg of 100 - Brass	619(US15)	HGPART.1009	10.90
Hinge MS Mtg Screws Pkg of 100 - Steel	646(US15)	HGPART.1021	5.40
Hinge MS Mtg Screws Pkg of 100 - Brass	625(US26)	HGPART.1033	10.90
Hinge MS Mtg Screws Pkg of 100 - Steel	651(US26)	HGPART.1036	5.40
Hinge MS Mtg Screws Pkg of 100 - Brass	626(US26D)	HGPART.1034	10.90
Hinge MS Mtg Screws Pkg of 100 - Steel	652(US26D)	HGPART.1037	5.40
Hinge MS Mtg Screws Pkg of 100 - Stainless Steel	630(US32D)	HGPART.1016	10.90
Hinge WS Mtg Screws Pkg of 100 - Steel	600(USP)	HGPART.1027	5.40
Hinge WS Mtg Screws Pkg of 100 - Brass	605(US3)	HGPART.1012	21.70
Hinge WS Mtg Screws Pkg of 100 - Steel	632(US3)	HGPART.1022	5.40
Hinge WS Mtg Screws Pkg of 100 - Brass	606(US4)	HGPART.1038	23.10
Hinge WS Mtg Screws Pkg of 100 - Steel	633(US4)	HGPART.1041	5.40
Hinge WS Mtg Screws Pkg of 100 - Brass	612(US10)	HGPART.1014	23.10
Hinge WS Mtg Screws Pkg of 100 - Steel	639(US10)	HGPART.1023	5.40
Hinge WS Mtg Screws Pkg of 100 - Brass	613(US10B)	HGPART.1015	23.10
Hinge WS Mtg Screws Pkg of 100 - Steel	640(US10B)	HGPART.1024	5.40
Hinge WS Mtg Screws Pkg of 100 - Steel	641(US10A)	HGPART.1030	5.40
Hinge WS Mtg Screws Pkg of 100 - Steel	643(US11)	HGPART.1031	5.40
Hinge WS Mtg Screws Pkg of 100 - Brass	619(US15)	HGPART.1013	21.70
Hinge WS Mtg Screws Pkg of 100 - Steel	646(US15)	HGPART.1025	5.40
Hinge WS Mtg Screws Pkg of 100 - Brass	625(US26)	HGPART.1039	21.70
Hinge WS Mtg Screws Pkg of 100 - Steel	651(US26)	HGPART.1042	5.40
Hinge WS Mtg Screws Pkg of 100 - Brass	626(US26D)	HGPART.1040	21.70
Hinge WS Mtg Screws Pkg of 100 - Steel	652(US26D)	HGPART.1043	5.40
Hinge WS Mtg Screws Pkg of 100 - Stainless Steel	630(US32D)	HGPART.1017	21.70
CONTINUOUS HINGES - GEARED			
Chinge Geared Tek Scr Pkg Us28 (Pkg of 48)	US28	HGPART.1070	19.90
Chinge Geared Tek Scr Pkg 313AN (Pkg of 48)	313AN	HGPART.1071	19.90
Chinge Geared Tek/Wd Scr Pkg Us28 (24 Tek/24 Wood)	US28	HGPART.1102	19.90
Chinge Geared Tek/Wd Scr Pkg 313AN (24 Tek/24 Wood)	313AN	HGPART.1103	19.90
Chinge Geared Wd Scr Pkg Us28 (Pkg of 48)	US28	HGPART.1068	19.90
Chinge Geared Wd Scr Pkg 313AN (Pkg of 48)	313AN	HGPART.1069	19.90
Chinge Geared Hm Sec Scr Pkg Us32D (Pkg of 24)	US32D	HGPART.1104	35.40
Chinge Geared Wd Sec Scr Pkg Us32D (Pkg of 24)	US32D	HGPART.1105	35.40
112TWP Panel Service Kit	US28	840737-28	249.00
112TWP Panel Service Kit	313AN	840737-42	249.00
224TWP Panel Service Kit	US28	840738-28	249.00
224TWP Panel Service Kit	313AN	840738-42	249.00
XY TWP CON Panel Service Kit	US28	HGPART.1159	294.00
XY TWP CON Panel Service Kit	313AN	HGPART.1160	294.00
CONTINUOUS HINGES - Pin & Barrel			
Chinge Pin & Barrel #10 X 1/2 Tek Screw SELF DRILL (Pkg of 54)	US32D	HGPART.1044	22.20
Chinge Pin & Barrel #10 X 1 Flat Head Wood Screw (Pkg of 27)	US32D	HGPART.1046	11.00
Chinge Pin & Barrel Adjustment Stud (Pkg of 27)	US32D	HGPART.1048	92.10
Chinge Pin & Barrel #10 X 3/4" Tek Screw (Pkg of 27)	US32D	HGPART.1050	18.90
Chinge Pin & Barrel 120" 1/2" TEK screw pkg		HGPART.1044	22.20
Chinge Pin & Barrel 120" Full Surface screw pkg (Pan Head TEK)		HGPART.1045	17.70

Contact Ives Customer Service for pricing on additional sizes and finishes

Bold pricing indicates item is in stock and available for **Fast Track** and **ProXpress**

IVES ARCHITECTURAL HARDWARE - Parts Price List

Description	Finish	Part No.	List Price Each
CONTINUOUS HINGES - Pin & Barrel (Continued)			
Chinge Pin & Barrel 120" wood screw pkg		HGPART.1046	10.90
Chinge Pin & Barrel 120" Full Surface cover clip pkg		HGPART.1047	37.20
Chinge Pin & Barrel 120" Adjustment stud (with machine screws) pkg		HGPART.1048	87.30
Chinge Pin & Barrel 120" Full Surface sexbolt pkg		HGPART.1049	87.30
Chinge Pin & Barrel 120" 3/4" TEK screw pkg		HGPART.1050	18.60
Chinge Pin & Barrel Replacment ETW Module	US32D	HGPART.1108	297.90
Chinge Pin & Barrel 83" Full Surface screw cover	US32D	HGPART.1109	76.90
Chinge Pin & Barrel 85" Full Surface screw cover	US32D	HGPART.1110	76.90
Chinge Pin & Barrel 95" Full Surface screw cover	US32D	HGPART.1111	88.40
Chinge Pin & Barrel 120" Full Surface screw cover	US32D	HGPART.1112	102.40
Chinge Pin & Barrel 120" hollow metal security screw pkg (Torx screws)		HGPART.1113	156.50
Chinge Pin & Barrel 120" hollow metal machine screw pkg		HGPART.1114	37.20
Chinge Pin & Barrel 120" wood door security screw pkg (wood Torx screws)		HGPART.1124	156.60
700CSTWP Panel Service Kit	US32D	HGPART.1153	808.00
PIVOTS 7212/15/22/26/27 & 7215F/26F/27F Top Pivot			
7212/15/22/26/27 Top Bearing Leaf	US3	PVPART.1001	125.70
7212/15/22/26/27 Top Bearing Leaf	US4	PVPART.1002	125.70
7212/15/22/26/27 Top Bearing Leaf	US10	PVPART.1003	125.70
7212/15/22/26/27 Top Bearing Leaf	US10B	PVPART.1004	125.70
7212/15/22/26/27 Top Bearing Leaf	US26	PVPART.1005	125.70
7212/15/22/26/27 Top Bearing Leaf	US26D	PVPART.1006	107.80
7212/15/22/26/27 Top Bearing Leaf	SP4	PVPART.1007	77.50
7212/15/22/26/27 Top Bearing Leaf	SP10	PVPART.1008	77.50
7212/15/22/26/27 Top Bearing Leaf	SP28	PVPART.1009	77.50
7212/15/22/26/27 Top Bearing Leaf	SP313	PVPART.1010	77.50
7212/15/22/26/27 Top Bearing Leaf	SPBLK	PVPART.1011	77.50
7212/15/22/26/27 Top Pin Leaf	US3	PVPART.1012	125.70
7212/15/22/26/27 Top Pin Leaf	US4	PVPART.1013	125.70
7212/15/22/26/27 Top Pin Leaf	US10	PVPART.1014	125.70
7212/15/22/26/27 Top Pin Leaf	US10B	PVPART.1015	125.70
7212/15/22/26/27 Top Pin Leaf	US26	PVPART.1016	125.70
7212/15/22/26/27 Top Pin Leaf	US26D	PVPART.1017	107.80
7212/15/22/26/27 Top Pin Leaf	SP4	PVPART.1018	77.50
7212/15/22/26/27 Top Pin Leaf	SP10	PVPART.1019	77.50
7212/15/22/26/27 Top Pin Leaf	SP28	PVPART.1020	77.50
7212/15/22/26/27 Top Pin Leaf	SP313	PVPART.1021	77.50
7212/15/22/26/27 Top Pin Leaf	SPBLK	PVPART.1022	77.50
7215F/26F/27F Top Bearing Leaf	US3	PVPART.1227	222.80
7215F/26F/27F Top Bearing Leaf	US10	PVPART.1228	222.80
7215F/26F/27F Top Bearing Leaf	US32	PVPART.1229	222.80
7215F/26F/27F Top Bearing Leaf	US32D	PVPART.1230	192.50
7215F/26F/27F Top Bearing Leaf	SP4	PVPART.1231	162.10
7215F/26F/27F Top Bearing Leaf	SP10	PVPART.1232	162.10
7215F/26F/27F Top Bearing Leaf	SP28	PVPART.1233	162.10
7215F/26F/27F Top Bearing Leaf	SP313	PVPART.1234	162.10
7215F/26F/27F Top Bearing Leaf	SPBLK	PVPART.1235	162.10
7215F/26F/27F Top Pin Leaf	US3	PVPART.1236	222.80
7215F/26F/27F Top Pin Leaf	US10	PVPART.1237	222.80
7215F/26F/27F Top Pin Leaf	US32	PVPART.1238	222.80
7215F/26F/27F Top Pin Leaf	US32D	PVPART.1239	192.50
7215F/26F/27F Top Pin Leaf	SP4	PVPART.1240	162.10

Contact Ives Customer Service for pricing on additional sizes and finishes

Bold pricing indicates item is in stock and available for **Fast Track** and **ProXpress**

IVES ARCHITECTURAL HARDWARE - Parts Price List

Description	Finish	Part No.	List Price Each
PIVOTS 7212/15/22/26/27 & 7215F/26F/27F Top Pivot (Continued)			
7215F/26F/27F Top Pin Leaf	SP10	PVPART.1241	162.10
7215F/26F/27F Top Pin Leaf	SP28	PVPART.1242	162.10
7215F/26F/27F Top Pin Leaf	SP313	PVPART.1243	162.10
7215F/26F/27F Top Pin Leaf	SPBLK	PVPART.1244	162.10
7212/12V/15/22/26/27/44/45 Top Mounting Pkg	US3, US4, SP4	PVPART.1023	13.30
7212/12V/15/22/26/27/44/45 Top Mounting Pkg	US10, SP10	PVPART.1024	13.30
7212/12V/15/22/26/27/44/45 Top Mounting Pkg	US10B, SP313	PVPART.1025	13.30
7212/12V/15/22/26/27/44/45 Top Mounting Pkg	US26, US26D, SP28, US32, US32D	PVPART.1026	13.30
7212/12V/15/22/26/27/44/45 Top Mounting Pkg	SPBLK	PVPART.1027	13.30
7212/12V/15/22/26/27/44/45 Top Security Mtg Pkg	-	PVPART.1028	24.10
7212/12V/15/22/26/27/44/45 Top Wood Mtg Pkg	US3, US4, SP4	PVPART.1821	12.20
7212/12V/15/22/26/27/44/45 Top Wood Mtg Pkg	US10, SP10	PVPART.1822	12.20
7212/12V/15/22/26/27/44/45 Top Wood Mtg Pkg	US10B, SP313	PVPART.1823	12.20
7212/12V/15/22/26/27/44/45 Top Wood Mtg Pkg	US26, US26D, SP28, US32, US32D	PVPART.1824	12.20
7212/12V/15/22/26/27/44/45 Top Wood Mtg Pkg	SPBLK	PVPART.1825	12.20
7212/15/22/26/27/30/37/44/45 Top Pivot Pin	-	PVPART.1029	6.10
Pivot Set Screw (Pkg of 10)	-	PVPART.1030	4.90
Pivot Bushing	-	PVPART.1870	3.00
7212/15/22/26/27/30/37/44/45 Cap Screw	US3	PVPART.1032	19.30
7212/15/22/26/27/30/37/44/45 Cap Screw	US4	PVPART.1033	19.30
7212/15/22/26/27/30/37/44/45 Cap Screw	US10	PVPART.1034	19.30
7212/15/22/26/27/30/37/44/45 Cap Screw	US10B	PVPART.1035	19.30
7212/15/22/26/27/30/37/44/45 Cap Screw	US26, US32	PVPART.1036	19.30
7212/15/22/26/27/30/37/44/45 Cap Screw	US26D, US32D	PVPART.1037	19.30
7212/15/22/26/27/30/37/44/45 Cap Screw	SP4	PVPART.1038	19.30
7212/15/22/26/27/30/37/44/45 Cap Screw	SP10	PVPART.1039	19.30
7212/15/22/26/27/30/37/44/45 Cap Screw	SP28	PVPART.1040	19.30
7212/15/22/26/27/30/37/44/45 Cap Screw	SP313	PVPART.1041	19.30
7212/15/22/26/27/30/37/44/45 Cap Screw	SPBLK	PVPART.1042	19.30
7212V Top Pivot			
7212V Top Door Leaf - RH	US3	PVPART.1144	130.80
7212V Top Door Leaf - RH	US4	PVPART.1145	130.80
7212V Top Door Leaf - RH	US10	PVPART.1146	130.80
7212V Top Door Leaf - RH	US10B	PVPART.1147	130.80
7212V Top Door Leaf - RH	US26	PVPART.1148	130.80
7212V Top Door Leaf - RH	US26D	PVPART.1149	112.40
7212V Top Door Leaf - RH	SP4	PVPART.1150	85.80
7212V Top Door Leaf - RH	SP10	PVPART.1151	85.80
7212V Top Door Leaf - RH	SP28	PVPART.1152	85.80
7212V Top Door Leaf - RH	SP313	PVPART.1153	85.80
7212V Top Door Leaf - RH	SPBLK	PVPART.1154	85.80
7212V Top Jamb Leaf - RH	US3	PVPART.1155	130.80
7212V Top Jamb Leaf - RH	US4	PVPART.1156	130.80
7212V Top Jamb Leaf - RH	US10	PVPART.1157	130.80
7212V Top Jamb Leaf - RH	US10B	PVPART.1158	130.80
7212V Top Jamb Leaf - RH	US26	PVPART.1159	130.80
7212V Top Jamb Leaf - RH	US26D	PVPART.1160	112.40
7212V Top Jamb Leaf - RH	SP4	PVPART.1161	85.80
7212V Top Jamb Leaf - RH	SP10	PVPART.1162	85.80
7212V Top Jamb Leaf - RH	SP28	PVPART.1163	85.80
7212V Top Jamb Leaf - RH	SP313	PVPART.1164	85.80
7212V Top Jamb Leaf - RH	SPBLK	PVPART.1165	85.80
7212V Top Door Leaf - LH	US3	PVPART.1166	130.80

Contact Ives Customer Service for pricing on additional sizes and finishes

Bold pricing indicates item is in stock and available for **Fast Track** and **ProXpress**

IVES ARCHITECTURAL HARDWARE - Parts Price List

Description	Finish	Part No.	List Price Each
7212V Top Pivot (Continued)			
7212V Top Door Leaf - LH	US4	PVPART.1167	130.80
7212V Top Door Leaf - LH	US10	PVPART.1168	130.80
7212V Top Door Leaf - LH	US10B	PVPART.1169	130.80
7212V Top Door Leaf - LH	US26	PVPART.1170	130.80
7212V Top Door Leaf - LH	US26D	PVPART.1171	112.40
7212V Top Door Leaf - LH	SP4	PVPART.1172	85.80
7212V Top Door Leaf - LH	SP10	PVPART.1173	85.80
7212V Top Door Leaf - LH	SP28	PVPART.1174	85.80
7212V Top Door Leaf - LH	SP313	PVPART.1175	85.80
7212V Top Door Leaf - LH	SPBLK	PVPART.1176	85.80
7212V Top Jamb Leaf - LH	US3	PVPART.1177	130.80
7212V Top Jamb Leaf - LH	US4	PVPART.1178	130.80
7212V Top Jamb Leaf - LH	US10	PVPART.1179	130.80
7212V Top Jamb Leaf - LH	US10B	PVPART.1180	130.80
7212V Top Jamb Leaf - LH	US26	PVPART.1181	130.80
7212V Top Jamb Leaf - LH	US26D	PVPART.1182	112.40
7212V Top Jamb Leaf - LH	SP4	PVPART.1183	85.80
7212V Top Jamb Leaf - LH	SP10	PVPART.1184	85.80
7212V Top Jamb Leaf - LH	SP28	PVPART.1185	85.80
7212V Top Jamb Leaf - LH	SP313	PVPART.1186	85.80
7212V Top Jamb Leaf - LH	SPBLK	PVPART.1187	85.80
7212/12V/15/26/27/44/45 Top Mtg Pkg	US3, US4, SP4	PVPART.1023	13.30
7212/12V/15/26/27/44/45 Top Mtg Pkg	US10, SP10	PVPART.1024	13.30
7212/12V/15/26/27/44/45 Top Mtg Pkg	US10B, SP313	PVPART.1025	13.30
7212/12V/15/26/27/44/45 Top Mtg Pkg	US26, US26D, SP28	PVPART.1026	13.30
7212/12V/15/26/27/44/45 Top Mtg Pkg	SPBLK	PVPART.1027	13.30
7212/12V/15/26/27/44/45 Top Wood Mtg Pkg	US3, US4, SP4	PVPART.1821	12.20
7212/12V/15/26/27/44/45 Top Wood Mtg Pkg	US10, SP10	PVPART.1822	12.20
7212/12V/15/26/27/44/45 Top Wood Mtg Pkg	US10B, SP313	PVPART.1823	12.20
7212/12V/15/26/27/44/45 Top Wood Mtg Pkg	US26, US26D, SP28	PVPART.1824	12.20
7212/12V/15/26/27/44/45 Top Wood Mtg Pkg	SPBLK	PVPART.1825	12.20
7212/12V/15/26/27/44/45 Top Security Mtg Pkg	-	PVPART.1028	24.10
Pivot Set Screw (Pkg of 10)	-	PVPART.1030	4.90
7212/12V/22 Pivot Bearing	-	PVPART.1031	4.90
7212/12V/22 Pivot Bearing Pin	-	PVPART.1093	4.90
7212V Pivot Pin Cap	US3	PVPART.1194	13.30
7212V Pivot Pin Cap	US4	PVPART.1195	13.30
7212V Pivot Pin Cap	US10	PVPART.1196	13.30
7212V Pivot Pin Cap	US10B	PVPART.1197	13.30
7212V Pivot Pin Cap	US26	PVPART.1198	13.30
7212V Pivot Pin Cap	US26D	PVPART.1199	13.30
7212V Pivot Pin Cap	SP4	PVPART.1200	13.30
7212V Pivot Pin Cap	SP10	PVPART.1201	13.30
7212V Pivot Pin Cap	SP28	PVPART.1202	13.30
7212V Pivot Pin Cap	SP313	PVPART.1203	13.30
7212V Pivot Pin Cap	SPBLK	PVPART.1204	13.30
7230F/37F Top Pivot			
7230F/37F Top Bearing Leaf	US3	PVPART.1517	206.90
7230F/37F Top Bearing Leaf	US10	PVPART.1518	206.90
7230F/37F Top Bearing Leaf	US32	PVPART.1519	206.90
7230F/37F Top Bearing Leaf	US32D	PVPART.1520	192.50
7230F/37F Top Bearing Leaf	SP4	PVPART.1521	170.60

Contact Ives Customer Service for pricing on additional sizes and finishes

Bold pricing indicates item is in stock and available for **Fast Track** and **ProXpress**

IVES ARCHITECTURAL HARDWARE - Parts Price List

Description	Finish	Part No.	List Price Each
7230F/37F Top Pivot (Continued)			
7230F/37F Top Bearing Leaf	SP10	PVPART.1522	170.60
7230F/37F Top Bearing Leaf	SP28	PVPART.1523	170.60
7230F/37F Top Bearing Leaf	SP313	PVPART.1524	170.60
7230F/37F Top Bearing Leaf	SPBLK	PVPART.1525	170.60
7230F/37F Top Pin Leaf	US3	PVPART.1526	206.90
7230F/37F Top Pin Leaf	US10	PVPART.1527	206.90
7230F/37F Top Pin Leaf	US32	PVPART.1528	206.90
7230F/37F Top Pin Leaf	US32D	PVPART.1529	192.50
7230F/37F Top Pin Leaf	SP4	PVPART.1530	170.60
7230F/37F Top Pin Leaf	SP10	PVPART.1531	170.60
7230F/37F Top Pin Leaf	SP28	PVPART.1532	170.60
7230F/37F Top Pin Leaf	SP313	PVPART.1533	170.60
7230F/37F Top Pin Leaf	SPBLK	PVPART.1534	170.60
7230F/37F Top Mounting Pkg	US3, SP4	PVPART.1535	19.30
7230F/37F Top Mounting Pkg	US10, SP10	PVPART.1536	19.30
7230F/37F Top Mounting Pkg	US32, US32D, SP28	PVPART.1537	19.30
7230F/37F Top Mounting Pkg	SP313	PVPART.1542	19.30
7230F/37F Top Mounting Pkg	SPBLK	PVPART.1543	19.30
7230F/37F Top Security Mounting Pkg	-	PVPART.1544	35.20
7230F/37F Top Wood Mtg Pkg	US3, SP4	PVPART.1841	15.20
7230F/37F Top Wood Mtg Pkg	US10, SP10	PVPART.1842	15.20
7230F/37F Top Wood Mtg Pkg	US32, US32D, SP28	PVPART.1843	15.20
7230F/37F Top Wood Mtg Pkg	SP313	PVPART.1844	15.20
7230F/37F Top Wood Mtg Pkg	SPBLK	PVPART.1845	15.20
7212/15/22/26/27/30/37/44/45 Top Pivot Pin	-	PVPART.1029	6.10
Pivot Set Screw (Pkg of 10)	-	PVPART.1030	4.90
Pivot Bushing	-	PVPART.1870	3.00
7212/15/22/26/27/30/37/44/45 Cap Screw	US3	PVPART.1032	19.30
7212/15/22/26/27/30/37/44/45 Cap Screw	US10	PVPART.1034	19.30
7212/15/22/26/27/30/37/44/45 Cap Screw	US32	PVPART.1036	19.30
7212/15/22/26/27/30/37/44/45 Cap Screw	US32D	PVPART.1037	19.30
7212/15/22/26/27/30/37/44/45 Cap Screw	SP4	PVPART.1038	19.30
7212/15/22/26/27/30/37/44/45 Cap Screw	SP10	PVPART.1039	19.30
7212/15/22/26/27/30/37/44/45 Cap Screw	SP28	PVPART.1040	19.30
7212/15/22/26/27/30/37/44/45 Cap Screw	SP313	PVPART.1041	19.30
7212/15/22/26/27/30/37/44/45 Cap Screw	SPBLK	PVPART.1042	19.30
7244F/45F Top Pivot			
7244F/45F Top Bearing Leaf	US3	PVPART.1615	224.80
7244F/45F Top Bearing Leaf	US10	PVPART.1616	224.80
7244F/45F Top Bearing Leaf	US32	PVPART.1617	224.80
7244F/45F Top Bearing Leaf	US32D	PVPART.1618	215.50
7244F/45F Top Bearing Leaf	SP4	PVPART.1619	196.00
7244F/45F Top Bearing Leaf	SP10	PVPART.1620	196.00
7244F/45F Top Bearing Leaf	SP28	PVPART.1621	196.00
7244F/45F Top Bearing Leaf	SP313	PVPART.1622	196.00
7244F/45F Top Bearing Leaf	SPBLK	PVPART.1623	196.00
7244F/45F Top Pin Leaf	US3	PVPART.1624	224.80
7244F/45F Top Pin Leaf	US10	PVPART.1625	224.80
7244F/45F Top Pin Leaf	US32	PVPART.1626	224.80
7244F/45F Top Pin Leaf	US32D	PVPART.1627	215.50
7244F/45F Top Pin Leaf	SP4	PVPART.1628	196.00
7244F/45F Top Pin Leaf	SP10	PVPART.1629	196.00
7244F/45F Top Pin Leaf	SP28	PVPART.1630	196.00

Contact Ives Customer Service for pricing on additional sizes and finishes

Bold pricing indicates item is in stock and available for **Fast Track** and **ProXpress**

IVES ARCHITECTURAL HARDWARE - Parts Price List

Description	Finish	Part No.	List Price Each
7244F/45F Top Pivot (Continued)			
7244F/45F Top Pin Leaf	SP313	PVPART.1631	196.00
7244F/45F Top Pin Leaf	SPBLK	PVPART.1632	196.00
7212/12V/15/26/27/44/45 Top Mounting Pkg	US3, SP4	PVPART.1023	13.30
7212/12V/15/26/27/44/45 Top Mounting Pkg	US10, SPI0	PVPART.1024	13.30
7212/12V/15/26/27/44/45 Top Mounting Pkg	US32, US32D, SP28	PVPART.1026	13.30
7212/12V/15/26/27/44/45 Top Mounting Pkg	SP313	PVPART.1025	13.30
7212/12V/15/26/27/44/45 Top Mounting Pkg	SPBLK	PVPART.1027	13.30
7212/12V/15/26/27/44/45 Top Security Mtg Pkg	-	PVPART.1028	24.10
7212/12V/15/26/27/44/45 Top Wood Mtg Pkg	US3, SP4	PVPART.1821	12.20
7212/12V/15/26/27/44/45 Top Wood Mtg Pkg	US10, SPI0	PVPART.1822	12.20
7212/12V/15/26/27/44/45 Top Wood Mtg Pkg	US32, US32D, SP28	PVPART.1824	12.20
7212/12V/15/26/27/44/45 Top Wood Mtg Pkg	SP313	PVPART.1823	12.20
7212/12V/15/26/27/44/45 Top Wood Mtg Pkg	SPBLK	PVPART.1825	12.20
7212/15/22/26/27/30/37/44/45 Top Pivot Pin	-	PVPART.1029	6.10
Pivot Set Screw (Pkg of 10)	-	PVPART.1030	4.90
Pivot Bushing	-	PVPART.1870	3.00
7212/15/22/26/27/30/37/44/45 Cover Cap Screw	US3	PVPART.1032	19.30
7212/15/22/26/27/30/37/44/45 Cover Cap Screw	US10	PVPART.1034	19.30
7212/15/22/26/27/30/37/44/45 Cover Cap Screw	US32	PVPART.1036	19.30
7212/15/22/26/27/30/37/44/45 Cover Cap Screw	US32D	PVPART.1037	19.30
7212/15/22/26/27/30/37/44/45 Cover Cap Screw	SP4	PVPART.1038	19.30
7212/15/22/26/27/30/37/44/45 Cover Cap Screw	SPI0	PVPART.1039	19.30
7212/15/22/26/27/30/37/44/45 Cover Cap Screw	SP28	PVPART.1040	19.30
7212/15/22/26/27/30/37/44/45 Cover Cap Screw	SP313	PVPART.1041	19.30
7212/15/22/26/27/30/37/44/45 Cover Cap Screw	SPBLK	PVPART.1042	19.30
7253/55/55J/56 Top Pivot			
7253/55/55J/56 Top Door Leaf	-	PVPART.1705	170.60
7253/55/55J/56 Top Frame Leaf	US3	PVPART.1706	170.60
7253/55/55J/56 Top Frame Leaf	US4	PVPART.1707	170.60
7253/55/55J/56 Top Frame Leaf	US10	PVPART.1708	170.60
7253/55/55J/56 Top Frame Leaf	US10B	PVPART.1709	170.60
7253/55/55J/56 Top Frame Leaf	US26	PVPART.1710	170.60
7253/55/55J/56 Top Frame Leaf	US26D	PVPART.1711	170.60
7253/55/55J/56 Top Frame Leaf	SP4	PVPART.1712	147.70
7253/55/55J/56 Top Frame Leaf	SPI0	PVPART.1713	147.70
7253/55/55J/56 Top Frame Leaf	SP28	PVPART.1714	147.70
7253/55/55J/56 Top Frame Leaf	SP313	PVPART.1715	147.70
7253/55/55J/56 Top Frame Leaf	SPBLK	PVPART.1716	147.70
7253/55/55J/56 Top Finish Plate Pkg	US3	PVPART.1717	71.30
7253/55/55J/56 Top Finish Plate Pkg	US4	PVPART.1718	71.30
7253/55/55J/56 Top Finish Plate Pkg	US10	PVPART.1719	71.30
7253/55/55J/56 Top Finish Plate Pkg	US10B	PVPART.1720	71.30
7253/55/55J/56 Top Finish Plate Pkg	US26	PVPART.1721	71.30
7253/55/55J/56 Top Finish Plate Pkg	US26D	PVPART.1722	71.30
7253/55/55J/56 Top Finish Plate Pkg	SP4	PVPART.1723	44.80
7253/55/55J/56 Top Finish Plate Pkg	SPI0	PVPART.1724	44.80
7253/55/55J/56 Top Finish Plate Pkg	SP28	PVPART.1725	44.80
7253/55/55J/56 Top Finish Plate Pkg	SP313	PVPART.1726	44.80
7253/55/55J/56 Top Finish Plate Pkg	SPBLK	PVPART.1727	44.80
7227/37/45/56/59 Finish Plate Screw (Pkg of 10)	-	PVPART.1335	1.80
7253/55/55J/56/59 Top Mounting Pkg	US3, US4, SP4	PVPART.1729	13.30
7253/55/55J/56/59 Top Mounting Pkg	US10, SPI0	PVPART.1730	13.30
7253/55/55J/56/59 Top Mounting Pkg	US10B, SP313	PVPART.1731	13.30

Contact Ives Customer Service for pricing on additional sizes and finishes

Bold pricing indicates item is in stock and available for **Fast Track** and **ProXpress**

IVES ARCHITECTURAL HARDWARE - Parts Price List

Description	Finish	Part No.	List Price Each
7253/55/55J/56 Top Pivot(Continued)			
7253/55/55J/56/59 Top Mounting Pkg	US26, US26D, SP28	PVPART.1732	13.30
7253/55/55J/56/59 Top Mounting Pkg	SPBLK	PVPART.1733	13.30
7253/55/55J/56/59 Top Security Mtg Pkg	-	PVPART.1734	18.10
7253/55/55J/56/59 Top Wood Mtg Pkg	US3, US4, SP4	PVPART.1859	8.50
7253/55/55J/56/59 Top Wood Mtg Pkg	US10, SP10	PVPART.1860	8.50
7253/55/55J/56/59 Top Wood Mtg Pkg	US10B, SP313	PVPART.1861	8.50
7253/55/55J/56/59 Top Wood Mtg Pkg	US26, US26D, SP28	PVPART.1862	8.50
7253/55/55J/56/59 Top Wood Mtg Pkg	SPBLK	PVPART.1863	8.50
7259 Top Pivot			
7259 Top Door Leaf	-	PVPART.1788	170.60
7259 Top Frame Leaf	US3	PVPART.1789	170.60
7259 Top Frame Leaf	US4	PVPART.1790	170.60
7259 Top Frame Leaf	US10	PVPART.1791	170.60
7259 Top Frame Leaf	US10B	PVPART.1792	170.60
7259 Top Frame Leaf	US26	PVPART.1793	170.60
7259 Top Frame Leaf	US26D	PVPART.1794	170.60
7259 Top Frame Leaf	SP4	PVPART.1795	147.70
7259 Top Frame Leaf	SP10	PVPART.1796	147.70
7259 Top Frame Leaf	SP28	PVPART.1797	147.70
7259 Top Frame Leaf	SP313	PVPART.1798	147.70
7259 Top Frame Leaf	SPBLK	PVPART.1799	147.70
7259 Top Finish Plate Pkg	US3	PVPART.1800	71.30
7259 Top Finish Plate Pkg	US4	PVPART.1801	71.30
7259 Top Finish Plate Pkg	US10	PVPART.1802	71.30
7259 Top Finish Plate Pkg	US10B	PVPART.1803	71.30
7259 Top Finish Plate Pkg	US26	PVPART.1804	71.30
7259 Top Finish Plate Pkg	US26D	PVPART.1805	71.30
7259 Top Finish Plate Pkg	SP4	PVPART.1806	44.80
7259 Top Finish Plate Pkg	SP10	PVPART.1807	44.80
7259 Top Finish Plate Pkg	SP28	PVPART.1808	44.80
7259 Top Finish Plate Pkg	SP313	PVPART.1809	44.80
7259 Top Finish Plate Pkg	SPBLK	PVPART.1810	44.80
7227/37/45/56/59 Finish Plate Screw (Pkg of 10)	-	PVPART.1335	1.80
7253/55/55J/56/59 Top Mounting Pkg	US3, US4, SP4	PVPART.1729	13.30
7253/55/55J/56/59 Top Mounting Pkg	US10, SP10	PVPART.1730	13.30
7253/55/55J/56/59 Top Mounting Pkg	US10B, SP313	PVPART.1731	13.30
7253/55/55J/56/59 Top Mounting Pkg	US26, US26D, SP28	PVPART.1732	13.30
7253/55/55J/56/59 Top Mounting Pkg	SPBLK	PVPART.1733	13.30
7253/55/55J/56/59 Top Security Mtg Pkg	-	PVPART.1734	18.10
7253/55/55J/56/59 Top Wood Mtg Pkg	US3, US4, SP4	PVPART.1859	8.50
7253/55/55J/56/59 Top Wood Mtg Pkg	US10, SP10	PVPART.1860	8.50
7253/55/55J/56/59 Top Wood Mtg Pkg	US10B, SP313	PVPART.1861	8.50
7253/55/55J/56/59 Top Wood Mtg Pkg	US26, US26D, SP28	PVPART.1862	8.50
7253/55/55J/56/59 Top Wood Mtg Pkg	SPBLK	PVPART.1863	8.50
7212/12V/22 Intermediate Pivot			
7212/12V/22 Int Door Leaf - RH	US3	PVPART.1094	144.10
7212/12V/22 Int Door Leaf - RH	US4	PVPART.1095	144.10
7212/12V/22 Int Door Leaf - RH	US10	PVPART.1096	144.10
7212/12V/22 Int Door Leaf - RH	US10B	PVPART.1097	144.10
7212/12V/22 Int Door Leaf - RH	US26	PVPART.1098	144.10
7212/12V/22 Int Door Leaf - RH	US26D	PVPART.1099	125.70
7212/12V/22 Int Door Leaf - RH	SP4	PVPART.1100	100.50
7212/12V/22 Int Door Leaf - RH	SP10	PVPART.1101	100.50

Contact Ives Customer Service for pricing on additional sizes and finishes

Bold pricing indicates item is in stock and available for **Fast Track** and **ProXpress**

IVES ARCHITECTURAL HARDWARE - Parts Price List

Description	Finish	Part No.	List Price Each
7212/12V/22 Intermediate Pivot (Continued)			
7212/12V/22 Int Door Leaf - RH	SP28	PVPART.1102	100.50
7212/12V/22 Int Door Leaf - RH	SP313	PVPART.1103	100.50
7212/12V/22 Int Door Leaf - RH	SPBLK	PVPART.1104	100.50
7212/12V/22 Int Jamb Leaf - RH	US3	PVPART.1105	144.10
7212/12V/22 Int Jamb Leaf - RH	US4	PVPART.1106	144.10
7212/12V/22 Int Jamb Leaf - RH	US10	PVPART.1107	144.10
7212/12V/22 Int Jamb Leaf - RH	US10B	PVPART.1108	144.10
7212/12V/22 Int Jamb Leaf - RH	US26	PVPART.1109	144.10
7212/12V/22 Int Jamb Leaf - RH	US26D	PVPART.1110	125.70
7212/12V/22 Int Jamb Leaf - RH	SP4	PVPART.1111	100.50
7212/12V/22 Int Jamb Leaf - RH	SP10	PVPART.1112	100.50
7212/12V/22 Int Jamb Leaf - RH	SP28	PVPART.1113	100.50
7212/12V/22 Int Jamb Leaf - RH	SP313	PVPART.1114	100.50
7212/12V/22 Int Jamb Leaf - RH	SPBLK	PVPART.1115	100.50
7212/12V/22 Int Door Leaf - LH	US3	PVPART.1116	144.10
7212/12V/22 Int Door Leaf - LH	US4	PVPART.1117	144.10
7212/12V/22 Int Door Leaf - LH	US10	PVPART.1118	144.10
7212/12V/22 Int Door Leaf - LH	US10B	PVPART.1119	144.10
7212/12V/22 Int Door Leaf - LH	US26	PVPART.1120	144.10
7212/12V/22 Int Door Leaf - LH	US26D	PVPART.1121	125.70
7212/12V/22 Int Door Leaf - LH	SP4	PVPART.1122	100.50
7212/12V/22 Int Door Leaf - LH	SP10	PVPART.1123	100.50
7212/12V/22 Int Door Leaf - LH	SP28	PVPART.1124	100.50
7212/12V/22 Int Door Leaf - LH	SP313	PVPART.1125	100.50
7212/12V/22 Int Door Leaf - LH	SPBLK	PVPART.1126	100.50
7212/12V/22 Int Jamb Leaf - LH	US3	PVPART.1127	144.10
7212/12V/22 Int Jamb Leaf - LH	US4	PVPART.1128	144.10
7212/12V/22 Int Jamb Leaf - LH	US10	PVPART.1129	144.10
7212/12V/22 Int Jamb Leaf - LH	US10B	PVPART.1130	144.10
7212/12V/22 Int Jamb Leaf - LH	US26	PVPART.1131	144.10
7212/12V/22 Int Jamb Leaf - LH	US26D	PVPART.1132	125.70
7212/12V/22 Int Jamb Leaf - LH	SP4	PVPART.1133	100.50
7212/12V/22 Int Jamb Leaf - LH	SP10	PVPART.1134	100.50
7212/12V/22 Int Jamb Leaf - LH	SP28	PVPART.1135	100.50
7212/12V/22 Int Jamb Leaf - LH	SP313	PVPART.1136	100.50
7212/12V/22 Int Jamb Leaf - LH	SPBLK	PVPART.1137	100.50
7212/12V/22 Int Mounting Pkg	US3, US4, SP4	PVPART.1138	12.20
7212/12V/22 Int Mounting Pkg	US10, SP10	PVPART.1139	12.20
7212/12V/22 Int Mounting Pkg	US10B, SP313	PVPART.1140	12.20
7212/12V/22 Int Mounting Pkg	US26, US26D, SP28	PVPART.1141	12.20
7212/12V/22 Int Mounting Pkg	SPBLK	PVPART.1142	12.20
7212/12V/22 Int Wood Mtg Pkg	US3, US4, SP4	PVPART.1831	8.90
7212/12V/22 Int Wood Mtg Pkg	US10, SP10	PVPART.1832	8.90
7212/12V/22 Int Wood Mtg Pkg	US10B, SP313	PVPART.1833	8.90
7212/12V/22 Int Wood Mtg Pkg	US26, US26D, SP28	PVPART.1834	8.90
7212/12V/22 Int Wood Mtg Pkg	SPBLK	PVPART.1835	8.90
7212/12V/22 Int Security Mtg Pkg	-	PVPART.1143	18.10
Pivot Set Screw (Pkg of 10)	-	PVPART.1030	4.90
7212/12V/22 Pivot Bearing	-	PVPART.1031	4.90
7212/12V/22 Pivot Bearing Pin	-	PVPART.1093	4.90
7215/26/27 & 7215F/26F/27F Intermediate Pivot			
7215/26/27 Int Door Leaf - RH	US3	PVPART.1354	130.80
7215/26/27 Int Door Leaf - RH	US4	PVPART.1355	130.80

Contact Ives Customer Service for pricing on additional sizes and finishes

Bold pricing indicates item is in stock and available for **Fast Track** and **ProXpress**

IVES ARCHITECTURAL HARDWARE - Parts Price List

Description	Finish	Part No.	List Price Each
7215/26/27 & 7215F/26F/27F Intermediate Pivot (Continued)			
7215/26/27 Int Door Leaf - RH	US10	PVPART.1356	130.80
7215/26/27 Int Door Leaf - RH	US10B	PVPART.1357	130.80
7215/26/27 Int Door Leaf - RH	US26	PVPART.1358	130.80
7215/26/27 Int Door Leaf - RH	US26D	PVPART.1359	117.30
7215/26/27 Int Door Leaf - RH	SP4	PVPART.1360	107.80
7215/26/27 Int Door Leaf - RH	SPI0	PVPART.1361	107.80
7215/26/27 Int Door Leaf - RH	SP28	PVPART.1362	107.80
7215/26/27 Int Door Leaf - RH	SP313	PVPART.1363	107.80
7215/26/27 Int Door Leaf - RH	SPBLK	PVPART.1364	107.80
7215/26/27 Int Jamb Leaf - RH	US3	PVPART.1365	130.80
7215/26/27 Int Jamb Leaf - RH	US4	PVPART.1366	130.80
7215/26/27 Int Jamb Leaf - RH	US10	PVPART.1367	130.80
7215/26/27 Int Jamb Leaf - RH	US10B	PVPART.1368	130.80
7215/26/27 Int Jamb Leaf - RH	US26	PVPART.1369	130.80
7215/26/27 Int Jamb Leaf - RH	US26D	PVPART.1370	117.30
7215/26/27 Int Jamb Leaf - RH	SP4	PVPART.1371	107.80
7215/26/27 Int Jamb Leaf - RH	SPI0	PVPART.1372	107.80
7215/26/27 Int Jamb Leaf - RH	SP28	PVPART.1373	107.80
7215/26/27 Int Jamb Leaf - RH	SP313	PVPART.1374	107.80
7215/26/27 Int Jamb Leaf - RH	SPBLK	PVPART.1375	107.80
7215/26/27 Int Door Leaf - LH	US3	PVPART.1376	130.80
7215/26/27 Int Door Leaf - LH	US4	PVPART.1377	130.80
7215/26/27 Int Door Leaf - LH	US10	PVPART.1378	130.80
7215/26/27 Int Door Leaf - LH	US10B	PVPART.1379	130.80
7215/26/27 Int Door Leaf - LH	US26	PVPART.1380	130.80
7215/26/27 Int Door Leaf - LH	US26D	PVPART.1381	117.30
7215/26/27 Int Door Leaf - LH	SP4	PVPART.1382	107.80
7215/26/27 Int Door Leaf - LH	SPI0	PVPART.1383	107.80
7215/26/27 Int Door Leaf - LH	SP28	PVPART.1384	107.80
7215/26/27 Int Door Leaf - LH	SP313	PVPART.1385	107.80
7215/26/27 Int Door Leaf - LH	SPBLK	PVPART.1386	107.80
7215/26/27 Int Jamb Leaf - LH	US3	PVPART.1387	130.80
7215/26/27 Int Jamb Leaf - LH	US4	PVPART.1388	130.80
7215/26/27 Int Jamb Leaf - LH	US10	PVPART.1389	130.80
7215/26/27 Int Jamb Leaf - LH	US10B	PVPART.1390	130.80
7215/26/27 Int Jamb Leaf - LH	US26	PVPART.1391	130.80
7215/26/27 Int Jamb Leaf - LH	US26D	PVPART.1392	117.30
7215/26/27 Int Jamb Leaf - LH	SP4	PVPART.1393	107.80
7215/26/27 Int Jamb Leaf - LH	SPI0	PVPART.1394	107.80
7215/26/27 Int Jamb Leaf - LH	SP28	PVPART.1395	107.80
7215/26/27 Int Jamb Leaf - LH	SP313	PVPART.1396	107.80
7215/26/27 Int Jamb Leaf - LH	SPBLK	PVPART.1397	107.80
7215F/26F/27F Int Door Leaf - RH	US3	PVPART.1398	206.90
7215F/26F/27F Int Door Leaf - RH	US10	PVPART.1399	206.90
7215F/26F/27F Int Door Leaf - RH	US32	PVPART.1400	206.90
7215F/26F/27F Int Door Leaf - RH	US32D	PVPART.1401	197.20
7215F/26F/27F Int Door Leaf - RH	SP4	PVPART.1402	166.80
7215F/26F/27F Int Door Leaf - RH	SPI0	PVPART.1403	166.80
7215F/26F/27F Int Door Leaf - RH	SP28	PVPART.1404	166.80
7215F/26F/27F Int Door Leaf - RH	SP313	PVPART.1405	166.80
7215F/26F/27F Int Door Leaf - RH	SPBLK	PVPART.1406	166.80
7215F/26F/27F Int Jamb Leaf - RH	US3	PVPART.1407	206.90
7215F/26F/27F Int Jamb Leaf - RH	US10	PVPART.1408	206.90

Contact Ives Customer Service for pricing on additional sizes and finishes

Bold pricing indicates item is in stock and available for **Fast Track** and **ProXpress**

IVES ARCHITECTURAL HARDWARE - Parts Price List

Description	Finish	Part No.	List Price Each
7215/26/27 & 7215F/26F/27F Intermediate Pivot (Continued)			
7215F/26F/27F Int Jamb Leaf - RH	US32	PVPART.1409	206.90
7215F/26F/27F Int Jamb Leaf - RH	US32D	PVPART.1410	197.20
7215F/26F/27F Int Jamb Leaf - RH	SP4	PVPART.1411	166.80
7215F/26F/27F Int Jamb Leaf - RH	SP10	PVPART.1412	166.80
7215F/26F/27F Int Jamb Leaf - RH	SP28	PVPART.1413	166.80
7215F/26F/27F Int Jamb Leaf - RH	SP313	PVPART.1414	166.80
7215F/26F/27F Int Jamb Leaf - RH	SPBLK	PVPART.1415	166.80
7215F/26F/27F Int Door Leaf - LH	US3	PVPART.1416	206.90
7215F/26F/27F Int Door Leaf - LH	US10	PVPART.1417	206.90
7215F/26F/27F Int Door Leaf - LH	US32	PVPART.1418	206.90
7215F/26F/27F Int Door Leaf - LH	US32D	PVPART.1419	197.20
7215F/26F/27F Int Door Leaf - LH	SP4	PVPART.1420	166.80
7215F/26F/27F Int Door Leaf - LH	SP10	PVPART.1421	166.80
7215F/26F/27F Int Door Leaf - LH	SP28	PVPART.1422	166.80
7215F/26F/27F Int Door Leaf - LH	SP313	PVPART.1423	166.80
7215F/26F/27F Int Door Leaf - LH	SPBLK	PVPART.1424	166.80
7215F/26F/27F Int Jamb Leaf - LH	US3	PVPART.1425	206.90
7215F/26F/27F Int Jamb Leaf - LH	US10	PVPART.1426	206.90
7215F/26F/27F Int Jamb Leaf - LH	US32	PVPART.1427	206.90
7215F/26F/27F Int Jamb Leaf - LH	US32D	PVPART.1428	197.20
7215F/26F/27F Int Jamb Leaf - LH	SP4	PVPART.1429	166.80
7215F/26F/27F Int Jamb Leaf - LH	SP10	PVPART.1430	166.80
7215F/26F/27F Int Jamb Leaf - LH	SP28	PVPART.1431	166.80
7215F/26F/27F Int Jamb Leaf - LH	SP313	PVPART.1432	166.80
7215F/26F/27F Int Jamb Leaf - LH	SPBLK	PVPART.1433	166.80
7215/26/27/30/37/44/45 Int Mounting Pkg	US3, US4, SP4	PVPART.1434	12.20
7215/26/27/30/37/44/45 Int Mounting Pkg	US10, SP10	PVPART.1435	12.20
7215/26/27/30/37/44/45 Int Mounting Pkg	US10B, SP313	PVPART.1436	12.20
7215/26/27/30/37/44/45 Int Mounting Pkg	US26, US26D, US32, US32D, SP28	PVPART.1437	12.20
7215/26/27/30/37/44/45 Int Mounting Pkg	SPBLK	PVPART.1438	12.20
7215/26/27/30/37/44/45 Int Security Mtg Pkg	-	PVPART.1439	29.20
7215/26/27/30/37/44/45 Int Wood Mtg Pkg	US3, US4, SP4	PVPART.1836	13.30
7215/26/27/30/37/44/45 Int Wood Mtg Pkg	US10, SP10	PVPART.1837	13.30
7215/26/27/30/37/44/45 Int Wood Mtg Pkg	US10B, SP313	PVPART.1838	13.30
7215/26/27/30/37/44/45 Int Wood Mtg Pkg	US26, US26D, US32, US32D, SP28	PVPART.1839	13.30
7215/26/27/30/37/44/45 Int Wood Mtg Pkg	SPBLK	PVPART.1840	13.30
7212/15/22/26/27/30/37/44/45 Cap Screw	US3	PVPART.1032	19.30
7212/15/22/26/27/30/37/44/45 Cap Screw	US4	PVPART.1033	19.30
7212/15/22/26/27/30/37/44/45 Cap Screw	US10	PVPART.1034	19.30
7212/15/22/26/27/30/37/44/45 Cap Screw	US10B	PVPART.1035	19.30
7212/15/22/26/27/30/37/44/45 Cap Screw	US26, US32	PVPART.1036	19.30
7212/15/22/26/27/30/37/44/45 Cap Screw	US26D, US32D	PVPART.1037	19.30
7212/15/22/26/27/30/37/44/45 Cap Screw	SP4	PVPART.1038	19.30
7212/15/22/26/27/30/37/44/45 Cap Screw	SP10	PVPART.1039	19.30
7212/15/22/26/27/30/37/44/45 Cap Screw	SP28	PVPART.1040	19.30
7212/15/22/26/27/30/37/44/45 Cap Screw	SP313	PVPART.1041	19.30
7212/15/22/26/27/30/37/44/45 Cap Screw	SPBLK	PVPART.1042	19.30
7215/26/27 Pivot Ball	-	PVPART.1349	1.80
Pivot Bushing	-	PVPART.1870	3.00
Pivot Retainer Lock	-	PVPART.1353	7.30
Pivot Washer (Pkg of 10)	-	PVPART.1352	6.10
7215/26/27/30/37/44/45 Int Pivot Bearing Pin	-	PVPART.1847	12.20

Contact Ives Customer Service for pricing on additional sizes and finishes

Bold pricing indicates item is in stock and available for **Fast Track** and **ProXpress**

IVES ARCHITECTURAL HARDWARE - Parts Price List

Description	Finish	Part No.	List Price Each
7230F/37F Intermediate Pivot			
7230F/37F Int Door Leaf - RH	US3	PVPART.1565	224.80
7230F/37F Int Door Leaf - RH	US10	PVPART.1566	224.80
7230F/37F Int Door Leaf - RH	US32	PVPART.1567	224.80
7230F/37F Int Door Leaf - RH	US32D	PVPART.1568	215.50
7230F/37F Int Door Leaf - RH	SP4	PVPART.1569	185.10
7230F/37F Int Door Leaf - RH	SP10	PVPART.1570	185.10
7230F/37F Int Door Leaf - RH	SP28	PVPART.1571	185.10
7230F/37F Int Door Leaf - RH	SP313	PVPART.1572	185.10
7230F/37F Int Door Leaf - RH	SPBLK	PVPART.1573	185.10
7230F/37F Int Jamb Leaf - RH	US3	PVPART.1574	224.80
7230F/37F Int Jamb Leaf - RH	US10	PVPART.1575	224.80
7230F/37F Int Jamb Leaf - RH	US32	PVPART.1576	224.80
7230F/37F Int Jamb Leaf - RH	US32D	PVPART.1577	215.50
7230F/37F Int Jamb Leaf - RH	SP4	PVPART.1578	185.10
7230F/37F Int Jamb Leaf - RH	SP10	PVPART.1579	185.10
7230F/37F Int Jamb Leaf - RH	SP28	PVPART.1580	185.10
7230F/37F Int Jamb Leaf - RH	SP313	PVPART.1581	185.10
7230F/37F Int Jamb Leaf - RH	SPBLK	PVPART.1582	185.10
7230F/37F Int Door Leaf - LH	US3	PVPART.1583	224.80
7230F/37F Int Door Leaf - LH	US10	PVPART.1584	224.80
7230F/37F Int Door Leaf - LH	US32	PVPART.1585	224.80
7230F/37F Int Door Leaf - LH	US32D	PVPART.1586	215.50
7230F/37F Int Door Leaf - LH	SP4	PVPART.1587	185.10
7230F/37F Int Door Leaf - LH	SP10	PVPART.1588	185.10
7230F/37F Int Door Leaf - LH	SP28	PVPART.1589	185.10
7230F/37F Int Door Leaf - LH	SP313	PVPART.1590	185.10
7230F/37F Int Door Leaf - LH	SPBLK	PVPART.1591	185.10
7230F/37F Int Jamb Leaf - LH	US3	PVPART.1592	224.80
7230F/37F Int Jamb Leaf - LH	US10	PVPART.1593	224.80
7230F/37F Int Jamb Leaf - LH	US32	PVPART.1594	224.80
7230F/37F Int Jamb Leaf - LH	US32D	PVPART.1595	215.50
7230F/37F Int Jamb Leaf - LH	SP4	PVPART.1596	185.10
7230F/37F Int Jamb Leaf - LH	SP10	PVPART.1597	185.10
7230F/37F Int Jamb Leaf - LH	SP28	PVPART.1598	185.10
7230F/37F Int Jamb Leaf - LH	SP313	PVPART.1599	185.10
7230F/37F Int Jamb Leaf - LH	SPBLK	PVPART.1600	185.10
7215/26/27/30/37/44/45 Int Mounting Pkg			
7215/26/27/30/37/44/45 Int Mounting Pkg	US3, SP4	PVPART.1434	12.20
7215/26/27/30/37/44/45 Int Mounting Pkg	US10, SP10	PVPART.1435	12.20
7215/26/27/30/37/44/45 Int Mounting Pkg	SP313	PVPART.1436	12.20
7215/26/27/30/37/44/45 Int Mounting Pkg	US32, US32D, SP28	PVPART.1437	12.20
7215/26/27/30/37/44/45 Int Mounting Pkg	SPBLK	PVPART.1438	12.20
7215/26/27/30/37/44/45 Int Security Mtg Pkg	-	PVPART.1439	29.20
7215/26/27/30/37/44/45 Int Wood Mtg Pkg	US3, US4	PVPART.1836	13.30
7215/26/27/30/37/44/45 Int Wood Mtg Pkg	US10, SP10	PVPART.1837	13.30
7215/26/27/30/37/44/45 Int Wood Mtg Pkg	SP313	PVPART.1838	13.30
7215/26/27/30/37/44/45 Int Wood Mtg Pkg	US32, US32D, SP28	PVPART.1839	13.30
7215/26/27/30/37/44/45 Int Wood Mtg Pkg	SPBLK	PVPART.1840	13.30
7212/15/22/26/27/30/37/44/45 Cap Screw	US3	PVPART.1032	19.30
7212/15/22/26/27/30/37/44/45 Cap Screw	US10	PVPART.1034	19.30
7212/15/22/26/27/30/37/44/45 Cap Screw	US32	PVPART.1036	19.30
7212/15/22/26/27/30/37/44/45 Cap Screw	US32D	PVPART.1037	19.30

Contact Ives Customer Service for pricing on additional sizes and finishes

Bold pricing indicates item is in stock and available for **Fast Track** and **ProXpress**

IVES ARCHITECTURAL HARDWARE - Parts Price List

Description	Finish	Part No.	List Price Each
7215/26/27/30/37/44/45 Int Mounting Pkg (Continued)			
7212/15/22/26/27/30/37/44/45 Cap Screw	SP4	PVPART.1038	19.30
7212/15/22/26/27/30/37/44/45 Cap Screw	SP10	PVPART.1039	19.30
7212/15/22/26/27/30/37/44/45 Cap Screw	SP28	PVPART.1040	19.30
7212/15/22/26/27/30/37/44/45 Cap Screw	SP313	PVPART.1041	19.30
7212/15/22/26/27/30/37/44/45 Cap Screw	SPBLK	PVPART.1042	19.30
7230/37/44/45 Intermediate Pivot Ball	-	PVPART.1607	1.80
Pivot Bushing	-	PVPART.1870	3.00
Pivot Retainer Lock	-	PVPART.1353	7.30
Pivot Washer (Pkg of 10)	-	PVPART.1352	6.10
7215/26/27/30/37/44/45 Int Pivot Bearing Pin	-	PVPART.1847	12.20
7244F/45F Intermediate Pivot			
7244F/45F Int Door Leaf - RH	US3	PVPART.1655	244.30
7244F/45F Int Door Leaf - RH	US10	PVPART.1656	244.30
7244F/45F Int Door Leaf - RH	US32	PVPART.1657	244.30
7244F/45F Int Door Leaf - RH	US32D	PVPART.1658	229.80
7244F/45F Int Door Leaf - RH	SP4	PVPART.1659	206.90
7244F/45F Int Door Leaf - RH	SP10	PVPART.1660	206.90
7244F/45F Int Door Leaf - RH	SP28	PVPART.1661	206.90
7244F/45F Int Door Leaf - RH	SP313	PVPART.1662	206.90
7244F/45F Int Door Leaf - RH	SPBLK	PVPART.1663	206.90
7244F/45F Int Jamb Leaf - RH	US3	PVPART.1664	244.30
7244F/45F Int Jamb Leaf - RH	US10	PVPART.1665	244.30
7244F/45F Int Jamb Leaf - RH	US32	PVPART.1666	244.30
7244F/45F Int Jamb Leaf - RH	US32D	PVPART.1667	229.80
7244F/45F Int Jamb Leaf - RH	SP4	PVPART.1668	206.90
7244F/45F Int Jamb Leaf - RH	SP10	PVPART.1669	206.90
7244F/45F Int Jamb Leaf - RH	SP28	PVPART.1670	206.90
7244F/45F Int Jamb Leaf - RH	SP313	PVPART.1671	206.90
7244F/45F Int Jamb Leaf - RH	SPBLK	PVPART.1672	206.90
7244F/45F Int Door Leaf - LH	US3	PVPART.1673	244.30
7244F/45F Int Door Leaf - LH	US10	PVPART.1674	244.30
7244F/45F Int Door Leaf - LH	US32	PVPART.1675	244.30
7244F/45F Int Door Leaf - LH	US32D	PVPART.1676	229.80
7244F/45F Int Door Leaf - LH	SP4	PVPART.1677	206.90
7244F/45F Int Door Leaf - LH	SP10	PVPART.1678	206.90
7244F/45F Int Door Leaf - LH	SP28	PVPART.1679	206.90
7244F/45F Int Door Leaf - LH	SP313	PVPART.1680	206.90
7244F/45F Int Door Leaf - LH	SPBLK	PVPART.1681	206.90
7244F/45F Int Jamb Leaf - LH	US3	PVPART.1682	244.30
7244F/45F Int Jamb Leaf - LH	US10	PVPART.1683	244.30
7244F/45F Int Jamb Leaf - LH	US32	PVPART.1684	244.30
7244F/45F Int Jamb Leaf - LH	US32D	PVPART.1685	229.80
7244F/45F Int Jamb Leaf - LH	SP4	PVPART.1686	206.90
7244F/45F Int Jamb Leaf - LH	SP10	PVPART.1687	206.90
7244F/45F Int Jamb Leaf - LH	SP28	PVPART.1688	206.90
7244F/45F Int Jamb Leaf - LH	SP313	PVPART.1689	206.90
7244F/45F Int Jamb Leaf - LH	SPBLK	PVPART.1690	206.90
7215/26/27/30/37/44/45 Int Mounting Pkg	US3, SP4	PVPART.1434	12.20
7215/26/27/30/37/44/45 Int Mounting Pkg	US10, SP10	PVPART.1435	12.20
7215/26/27/30/37/44/45 Int Mounting Pkg	SP313	PVPART.1436	12.20
7215/26/27/30/37/44/45 Int Mounting Pkg	US32, US32D, SP28	PVPART.1437	12.20
7215/26/27/30/37/44/45 Int Mounting Pkg	SPBLK	PVPART.1438	12.20
7215/26/27/30/37/44/45 Int Security Mtg Pkg	-	PVPART.1439	29.20

Contact Ives Customer Service for pricing on additional sizes and finishes

Bold pricing indicates item is in stock and available for **Fast Track** and **ProXpress**

IVES ARCHITECTURAL HARDWARE - Parts Price List

Parts

Description	Finish	Part No.	List Price Each
7244F/45F Intermediate Pivot (Continued)			
7215/26/27/30/37/44/45 Int Wood Mtg Pkg	US3, SP4	PVPART.1836	13.30
7215/26/27/30/37/44/45 Int Wood Mtg Pkg	US10, SP10	PVPART.1837	13.30
7215/26/27/30/37/44/45 Int Wood Mtg Pkg	SP313	PVPART.1838	13.30
7215/26/27/30/37/44/45 Int Wood Mtg Pkg	US32, US32D, SP28	PVPART.1839	13.30
7215/26/27/30/37/44/45 Int Wood Mtg Pkg	SPBLK	PVPART.1840	13.30
7212/15/22/26/27/30/37/44/45 Cap Screw	US3	PVPART.1032	19.30
7212/15/22/26/27/30/37/44/45 Cap Screw	US10	PVPART.1034	19.30
7212/15/22/26/27/30/37/44/45 Cap Screw	US32	PVPART.1036	19.30
7212/15/22/26/27/30/37/44/45 Cap Screw	US32D	PVPART.1037	19.30
7212/15/22/26/27/30/37/44/45 Cap Screw	SP4	PVPART.1038	19.30
7212/15/22/26/27/30/37/44/45 Cap Screw	SP10	PVPART.1039	19.30
7212/15/22/26/27/30/37/44/45 Cap Screw	SP28	PVPART.1040	19.30
7212/15/22/26/27/30/37/44/45 Cap Screw	SP313	PVPART.1041	19.30
7212/15/22/26/27/30/37/44/45 Cap Screw	SPBLK	PVPART.1042	19.30
7230/37/44/45 Intermediate Pivot Ball	-	PVPART.1607	1.80
Pivot Bushing	-	PVPART.1870	3.00
Pivot Retainer Lock	-	PVPART.1353	7.30
Pivot Washer (Pkg of 10)	-	PVPART.1352	6.10
7215/26/27/30/37/44/45 Int Pivot Bearing Pin	-	PVPART.1847	12.20
7212 Bottom Pivot			
7212/12V/22 Btm Door Leaf - RH	US3	PVPART.1043	130.80
7212/12V/22 Btm Door Leaf - RH	US4	PVPART.1044	130.80
7212/12V/22 Btm Door Leaf - RH	US10	PVPART.1045	130.80
7212/12V/22 Btm Door Leaf - RH	US10B	PVPART.1046	130.80
7212/12V/22 Btm Door Leaf - RH	US26	PVPART.1047	130.80
7212/12V/22 Btm Door Leaf - RH	US26D	PVPART.1048	112.40
7212/12V/22 Btm Door Leaf - RH	SP4	PVPART.1049	85.80
7212/12V/22 Btm Door Leaf - RH	SP10	PVPART.1050	85.80
7212/12V/22 Btm Door Leaf - RH	SP28	PVPART.1051	85.80
7212/12V/22 Btm Door Leaf - RH	SP313	PVPART.1052	85.80
7212/12V/22 Btm Door Leaf - RH	SPBLK	PVPART.1053	85.80
7212/12V Btm Jamb Leaf - RH	US3	PVPART.1054	130.80
7212/12V Btm Jamb Leaf - RH	US4	PVPART.1055	130.80
7212/12V Btm Jamb Leaf - RH	US10	PVPART.1056	130.80
7212/12V Btm Jamb Leaf - RH	US10B	PVPART.1057	130.80
7212/12V Btm Jamb Leaf - RH	US26	PVPART.1058	130.80
7212/12V Btm Jamb Leaf - RH	US26D	PVPART.1059	112.40
7212/12V Btm Jamb Leaf - RH	SP4	PVPART.1060	85.80
7212/12V Btm Jamb Leaf - RH	SP10	PVPART.1061	85.80
7212/12V Btm Jamb Leaf - RH	SP28	PVPART.1062	85.80
7212/12V Btm Jamb Leaf - RH	SP313	PVPART.1063	85.80
7212/12V Btm Jamb Leaf - RH	SPBLK	PVPART.1064	85.80
7212/12V/22 Btm Door Leaf - LH	US3	PVPART.1065	130.80
7212/12V/22 Btm Door Leaf - LH	US4	PVPART.1066	130.80
7212/12V/22 Btm Door Leaf - LH	US10	PVPART.1067	130.80
7212/12V/22 Btm Door Leaf - LH	US10B	PVPART.1068	130.80
7212/12V/22 Btm Door Leaf - LH	US26	PVPART.1069	130.80
7212/12V/22 Btm Door Leaf - LH	US26D	PVPART.1070	112.40
7212/12V/22 Btm Door Leaf - LH	SP4	PVPART.1071	85.80
7212/12V/22 Btm Door Leaf - LH	SP10	PVPART.1072	85.80
7212/12V/22 Btm Door Leaf - LH	SP28	PVPART.1073	85.80
7212/12V/22 Btm Door Leaf - LH	SP313	PVPART.1074	85.80
7212/12V/22 Btm Door Leaf - LH	SPBLK	PVPART.1075	85.80

Contact Ives Customer Service for pricing on additional sizes and finishes

Bold pricing indicates item is in stock and available for **Fast Track** and **ProXpress**

IVES ARCHITECTURAL HARDWARE - Parts Price List

Description	Finish	Part No.	List Price Each
7212 Bottom Pivot (Continued)			
7212/12V Btm Jamb Leaf - LH	US3	PVPART.1076	130.80
7212/12V Btm Jamb Leaf - LH	US4	PVPART.1077	130.80
7212/12V Btm Jamb Leaf - LH	US10	PVPART.1078	130.80
7212/12V Btm Jamb Leaf - LH	US10B	PVPART.1079	130.80
7212/12V Btm Jamb Leaf - LH	US26	PVPART.1080	130.80
7212/12V Btm Jamb Leaf - LH	US26D	PVPART.1081	112.40
7212/12V Btm Jamb Leaf - LH	SP4	PVPART.1082	85.80
7212/12V Btm Jamb Leaf - LH	SP10	PVPART.1083	85.80
7212/12V Btm Jamb Leaf - LH	SP28	PVPART.1084	85.80
7212/12V Btm Jamb Leaf - LH	SP313	PVPART.1085	85.80
7212/12V Btm Jamb Leaf - LH	SPBLK	PVPART.1086	85.80
7212/12V/15 Btm Mounting Pkg	US3, US4, SP4	PVPART.1087	13.30
7212/12V/15 Btm Mounting Pkg	US10, SP10	PVPART.1088	13.30
7212/12V/15 Btm Mounting Pkg	US10B, SP313	PVPART.1089	13.30
7212/12V/15 Btm Mounting Pkg	US26, US26D, SP28	PVPART.1090	13.30
7212/12V/15 Btm Mounting Pkg	SPBLK	PVPART.1091	13.30
7212/12V/15 Btm Security Mounting Pkg	-	PVPART.1092	24.10
7212/12V/15/22 Btm Wood Mtg Pkg	US3, US4, SP4	PVPART.1826	12.20
7212/12V/15/22 Btm Wood Mtg Pkg	US10, SP10	PVPART.1827	12.20
7212/12V/15/22 Btm Wood Mtg Pkg	US10B, SP313	PVPART.1828	12.20
7212/12V/15/22 Btm Wood Mtg Pkg	US26, US26D, SP28	PVPART.1829	12.20
7212/12V/15/22 Btm Wood Mtg Pkg	SPBLK	PVPART.1830	12.20
Pivot Set Screw (Pkg of 10)	-	PVPART.1030	4.90
7212/12V/22 Pivot Bearing	-	PVPART.1031	4.90
7212/12V/22 Pivot Bearing Pin	-	PVPART.1093	4.90
7212V Bottom Pivot			
7212/12V/22 Btm Door Leaf - RH	US3	PVPART.1043	130.80
7212/12V/22 Btm Door Leaf - RH	US4	PVPART.1044	130.80
7212/12V/22 Btm Door Leaf - RH	US10	PVPART.1045	130.80
7212/12V/22 Btm Door Leaf - RH	US10B	PVPART.1046	130.80
7212/12V/22 Btm Door Leaf - RH	US26	PVPART.1047	130.80
7212/12V/22 Btm Door Leaf - RH	US26D	PVPART.1048	112.40
7212/12V/22 Btm Door Leaf - RH	SP4	PVPART.1049	85.80
7212/12V/22 Btm Door Leaf - RH	SP10	PVPART.1050	85.80
7212/12V/22 Btm Door Leaf - RH	SP28	PVPART.1051	85.80
7212/12V/22 Btm Door Leaf - RH	SP313	PVPART.1052	85.80
7212/12V/22 Btm Door Leaf - RH	SPBLK	PVPART.1053	85.80
7212/12V Btm Jamb Leaf - RH	US3	PVPART.1054	130.80
7212/12V Btm Jamb Leaf - RH	US4	PVPART.1055	130.80
7212/12V Btm Jamb Leaf - RH	US10	PVPART.1056	130.80
7212/12V Btm Jamb Leaf - RH	US10B	PVPART.1057	130.80
7212/12V Btm Jamb Leaf - RH	US26	PVPART.1058	130.80
7212/12V Btm Jamb Leaf - RH	US26D	PVPART.1059	112.40
7212/12V Btm Jamb Leaf - RH	SP4	PVPART.1060	85.80
7212/12V Btm Jamb Leaf - RH	SP10	PVPART.1061	85.80
7212/12V Btm Jamb Leaf - RH	SP28	PVPART.1062	85.80
7212/12V Btm Jamb Leaf - RH	SP313	PVPART.1063	85.80
7212/12V Btm Jamb Leaf - RH	SPBLK	PVPART.1064	85.80
7212/12V/22 Btm Door Leaf - LH	US3	PVPART.1065	130.80
7212/12V/22 Btm Door Leaf - LH	US4	PVPART.1066	130.80
7212/12V/22 Btm Door Leaf - LH	US10	PVPART.1067	130.80
7212/12V/22 Btm Door Leaf - LH	US10B	PVPART.1068	130.80
7212/12V/22 Btm Door Leaf - LH	US26	PVPART.1069	130.80

Contact Ives Customer Service for pricing on additional sizes and finishes

Bold pricing indicates item is in stock and available for **Fast Track** and **ProXpress**

IVES ARCHITECTURAL HARDWARE - Parts Price List

Description	Finish	Part No.	List Price Each
7212V Bottom Pivot (Continued)			
7212/12V/22 Btm Door Leaf - LH	US26D	PVPART.1070	112.40
7212/12V/22 Btm Door Leaf - LH	SP4	PVPART.1071	85.80
7212/12V/22 Btm Door Leaf - LH	SP10	PVPART.1072	85.80
7212/12V/22 Btm Door Leaf - LH	SP28	PVPART.1073	85.80
7212/12V/22 Btm Door Leaf - LH	SP313	PVPART.1074	85.80
7212/12V/22 Btm Door Leaf - LH	SPBLK	PVPART.1075	85.80
7212/12V Btm Jamb Leaf - LH	US3	PVPART.1076	130.80
7212/12V Btm Jamb Leaf - LH	US4	PVPART.1077	130.80
7212/12V Btm Jamb Leaf - LH	US10	PVPART.1078	130.80
7212/12V Btm Jamb Leaf - LH	US10B	PVPART.1079	130.80
7212/12V Btm Jamb Leaf - LH	US26	PVPART.1080	130.80
7212/12V Btm Jamb Leaf - LH	US26D	PVPART.1081	112.40
7212/12V Btm Jamb Leaf - LH	SP4	PVPART.1082	85.80
7212/12V Btm Jamb Leaf - LH	SP10	PVPART.1083	85.80
7212/12V Btm Jamb Leaf - LH	SP28	PVPART.1084	85.80
7212/12V Btm Jamb Leaf - LH	SP313	PVPART.1085	85.80
7212/12V Btm Jamb Leaf - LH	SPBLK	PVPART.1086	85.80
7212/12V/15/22 Btm Mounting Pkg	US3, US4, SP4	PVPART.1087	13.30
7212/12V/15/22 Btm Mounting Pkg	US10, SP10	PVPART.1088	13.30
7212/12V/15/22 Btm Mounting Pkg	US10B, SP313	PVPART.1089	13.30
7212/12V/15/22 Btm Mounting Pkg	US26, US26D, SP28	PVPART.1090	13.30
7212/12V/15/22 Btm Mounting Pkg	SPBLK	PVPART.1091	13.30
7212/12V/15 Btm Security Mtg Pkg	-	PVPART.1092	24.10
7212/12V/15/22 Btm Wood Mtg Pkg	US3, US4, SP4	PVPART.1826	12.20
7212/12V/15/22 Btm Wood Mtg Pkg	US10, SP10	PVPART.1827	12.20
7212/12V/15/22 Btm Wood Mtg Pkg	US10B, SP313	PVPART.1828	12.20
7212/12V/15/22 Btm Wood Mtg Pkg	US26, US26D, SP28	PVPART.1829	12.20
7212/12V/15/22 Btm Wood Mtg Pkg	SPBLK	PVPART.1830	12.20
Pivot Set Screw (Pkg of 10)	-	PVPART.1030	4.90
7212/12V/22 Pivot Bearing	-	PVPART.1031	4.90
7212/12V/22 Pivot Bearing Pin	-	PVPART.1093	4.90
7215 & 7215F Bottom Pivot			
7215 Btm Door Leaf - RH	US3	PVPART.1251	144.10
7215 Btm Door Leaf - RH	US4	PVPART.1252	144.10
7215 Btm Door Leaf - RH	US10	PVPART.1253	144.10
7215 Btm Door Leaf - RH	US10B	PVPART.1254	144.10
7215 Btm Door Leaf - RH	US26	PVPART.1255	144.10
7215 Btm Door Leaf - RH	US26D	PVPART.1256	134.40
7215 Btm Door Leaf - RH	SP4	PVPART.1257	146.40
7215 Btm Door Leaf - RH	SP10	PVPART.1258	146.40
7215 Btm Door Leaf - RH	SP28	PVPART.1259	146.40
7215 Btm Door Leaf - RH	SP313	PVPART.1260	146.40
7215 Btm Door Leaf - RH	SPBLK	PVPART.1261	146.40
7215 Btm Jamb Leaf - RH	US3	PVPART.1262	144.10
7215 Btm Jamb Leaf - RH	US4	PVPART.1263	144.10
7215 Btm Jamb Leaf - RH	US10	PVPART.1264	144.10
7215 Btm Jamb Leaf - RH	US10B	PVPART.1265	144.10
7215 Btm Jamb Leaf - RH	US26	PVPART.1266	144.10
7215 Btm Jamb Leaf - RH	US26D	PVPART.1267	134.40
7215 Btm Jamb Leaf - RH	SP4	PVPART.1268	146.40
7215 Btm Jamb Leaf - RH	SP10	PVPART.1269	146.40
7215 Btm Jamb Leaf - RH	SP28	PVPART.1270	146.40
7215 Btm Jamb Leaf - RH	SP313	PVPART.1271	146.40

Contact Ives Customer Service for pricing on additional sizes and finishes

Bold pricing indicates item is in stock and available for **Fast Track** and **ProXpress**

IVES ARCHITECTURAL HARDWARE - Parts Price List

Description	Finish	Part No.	List Price Each
7215 & 7215F Bottom Pivot (Continued)			
7215 Btm Jamb Leaf - RH	SPBLK	PVPART.1272	146.40
7215 Btm Door Leaf - LH	US3	PVPART.1273	144.10
7215 Btm Door Leaf - LH	US4	PVPART.1274	144.10
7215 Btm Door Leaf - LH	US10B	PVPART.1276	144.10
7215 Btm Door Leaf - LH	US26	PVPART.1277	144.10
7215 Btm Door Leaf - LH	US26D	PVPART.1278	134.40
7215 Btm Door Leaf - LH	SP4	PVPART.1279	146.40
7215 Btm Door Leaf - LH	SP10	PVPART.1280	146.40
7215 Btm Door Leaf - LH	SP28	PVPART.1281	146.40
7215 Btm Door Leaf - LH	SP313	PVPART.1282	146.40
7215 Btm Door Leaf - LH	SPBLK	PVPART.1283	146.40
7215 Btm Jamb Leaf - LH	US3	PVPART.1284	144.10
7215 Btm Jamb Leaf - LH	US4	PVPART.1285	144.10
7215 Btm Jamb Leaf - LH	US10	PVPART.1286	144.10
7215 Btm Jamb Leaf - LH	US10B	PVPART.1287	144.10
7215 Btm Jamb Leaf - LH	US26	PVPART.1288	144.10
7215 Btm Jamb Leaf - LH	US26D	PVPART.1289	134.40
7215 Btm Jamb Leaf - LH	SP4	PVPART.1290	146.40
7215 Btm Jamb Leaf - LH	SP10	PVPART.1291	146.40
7215 Btm Jamb Leaf - LH	SP28	PVPART.1292	146.40
7215 Btm Jamb Leaf - LH	SP313	PVPART.1293	146.40
7215 Btm Jamb Leaf - LH	SPBLK	PVPART.1294	146.40
7215F Btm Door Leaf - RH	US3	PVPART.1295	256.50
7215F Btm Door Leaf - RH	US10	PVPART.1296	256.50
7215F Btm Door Leaf - RH	US32	PVPART.1297	256.50
7215F Btm Door Leaf - RH	US32D	PVPART.1298	238.30
7215F Btm Door Leaf - RH	SP4	PVPART.1299	188.80
7215F Btm Door Leaf - RH	SP10	PVPART.1300	188.80
7215F Btm Door Leaf - RH	SP28	PVPART.1301	188.80
7215F Btm Door Leaf - RH	SP313	PVPART.1302	188.80
7215F Btm Door Leaf - RH	SPBLK	PVPART.1303	188.80
7215F Btm Jamb Leaf - RH	US3	PVPART.1304	256.50
7215F Btm Jamb Leaf - RH	US10	PVPART.1305	256.50
7215F Btm Jamb Leaf - RH	US32	PVPART.1306	256.50
7215F Btm Jamb Leaf - RH	US32D	PVPART.1307	238.30
7215F Btm Jamb Leaf - RH	SP4	PVPART.1308	188.80
7215F Btm Jamb Leaf - RH	SP10	PVPART.1309	188.80
7215F Btm Jamb Leaf - RH	SP28	PVPART.1310	188.80
7215F Btm Jamb Leaf - RH	SP313	PVPART.1311	188.80
7215F Btm Jamb Leaf - RH	SPBLK	PVPART.1312	188.80
7215F Btm Door Leaf - LH	US3	PVPART.1313	256.50
7215F Btm Door Leaf - LH	US10	PVPART.1314	256.50
7215F Btm Door Leaf - LH	US32	PVPART.1315	256.50
7215F Btm Door Leaf - LH	US32D	PVPART.1316	238.30
7215F Btm Door Leaf - LH	SP4	PVPART.1317	188.80
7215F Btm Door Leaf - LH	SP10	PVPART.1318	188.80
7215F Btm Door Leaf - LH	SP28	PVPART.1319	188.80
7215F Btm Door Leaf - LH	SP313	PVPART.1320	188.80
7215F Btm Door Leaf - LH	SPBLK	PVPART.1321	188.80
7215F Btm Jamb Leaf - LH	US3	PVPART.1322	256.50
7215F Btm Jamb Leaf - LH	US10	PVPART.1323	256.50
7215F Btm Jamb Leaf - LH	US32	PVPART.1324	256.50
7215F Btm Jamb Leaf - LH	US32D	PVPART.1325	238.30

Contact Ives Customer Service for pricing on additional sizes and finishes

Bold pricing indicates item is in stock and available for **Fast Track** and **ProXpress**

IVES ARCHITECTURAL HARDWARE - Parts Price List

Description	Finish	Part No.	List Price Each
7215 & 7215F Bottom Pivot (Continued)			
7215F Btm Jamb Leaf - LH	SP4	PVPART.1326	188.80
7215F Btm Jamb Leaf - LH	SP10	PVPART.1327	188.80
7215F Btm Jamb Leaf - LH	SP28	PVPART.1328	188.80
7215F Btm Jamb Leaf - LH	SP313	PVPART.1329	188.80
7215F Btm Jamb Leaf - LH	SPBLK	PVPART.1330	188.80
7212/12V/15/22 Btm Mounting Pkg	US3, US4, SP4	PVPART.1087	13.30
7212/12V/15/22 Btm Mounting Pkg	US10, SP10	PVPART.1088	13.30
7212/12V/15/22 Btm Mounting Pkg	US10B, SP313	PVPART.1089	13.30
7212/12V/15/22 Btm Mounting Pkg	US26, US26D, US32, US32D, SP28	PVPART.1090	13.30
7212/12V/15/22 Btm Mounting Pkg	SPBLK	PVPART.1091	13.30
7212/12V/15/22 Btm Security Mtg Pkg	-	PVPART.1092	24.10
7212/12V/15/22 Btm Wood Mtg Pkg	US3, US4, SP4	PVPART.1826	12.20
7212/12V/15/22 Btm Wood Mtg Pkg	US10, SP10	PVPART.1827	12.20
7212/12V/15/22 Btm Wood Mtg Pkg	US10B, SP313	PVPART.1828	12.20
7212/12V/15/22 Btm Wood Mtg Pkg	US26, US26D, US32, US32D, SP28	PVPART.1829	12.20
7212/12V/15/22 Btm Wood Mtg Pkg	SPBLK	PVPART.1830	12.20
7212/15/22/26/27/30/37/44/45 Cap Screw	US3	PVPART.1032	19.30
7212/15/22/26/27/30/37/44/45 Cap Screw	US4	PVPART.1033	19.30
7212/15/22/26/27/30/37/44/45 Cap Screw	US10	PVPART.1034	19.30
7212/15/22/26/27/30/37/44/45 Cap Screw	US10B	PVPART.1035	19.30
7212/15/22/26/27/30/37/44/45 Cap Screw	US26, US32	PVPART.1036	19.30
7212/15/22/26/27/30/37/44/45 Cap Screw	US26D, US32D	PVPART.1037	19.30
7212/15/22/26/27/30/37/44/45 Cap Screw	SP4	PVPART.1038	19.30
7212/15/22/26/27/30/37/44/45 Cap Screw	SP10	PVPART.1039	19.30
7212/15/22/26/27/30/37/44/45 Cap Screw	SP28	PVPART.1040	19.30
7212/15/22/26/27/30/37/44/45 Cap Screw	SP313	PVPART.1041	19.30
7212/15/22/26/27/30/37/44/45 Cap Screw	SPBLK	PVPART.1042	19.30
7215/26/27 Pivot Ball	-	PVPART.1349	1.80
7215/15F Pivot Pin	-	PVPART.1350	8.50
Pivot Bearing Shaft	-	PVPART.1351	4.90
Pivot Washer (Pkg of 10)	-	PVPART.1352	6.10
Pivot Retainer Lock	-	PVPART.1353	7.30
7222 Bottom Pivot			
7212/12V/22 Btm Door Leaf - RH	US3	PVPART.1043	130.80
7212/12V/22 Btm Door Leaf - RH	US4	PVPART.1044	130.80
7212/12V/22 Btm Door Leaf - RH	US10	PVPART.1045	130.80
7212/12V/22 Btm Door Leaf - RH	US10B	PVPART.1046	130.80
7212/12V/22 Btm Door Leaf - RH	US26	PVPART.1047	130.80
7212/12V/22 Btm Door Leaf - RH	US26D	PVPART.1048	112.40
7212/12V/22 Btm Door Leaf - RH	SP4	PVPART.1049	85.80
7212/12V/22 Btm Door Leaf - RH	SP10	PVPART.1050	85.80
7212/12V/22 Btm Door Leaf - RH	SP28	PVPART.1051	85.80
7212/12V/22 Btm Door Leaf - RH	SP313	PVPART.1052	85.80
7212/12V/22 Btm Door Leaf - RH	SPBLK	PVPART.1053	85.80
7212/12V/22 Btm Door Leaf - LH	US3	PVPART.1065	130.80
7212/12V/22 Btm Door Leaf - LH	US4	PVPART.1066	130.80
7212/12V/22 Btm Door Leaf - LH	US10	PVPART.1067	130.80
7212/12V/22 Btm Door Leaf - LH	US10B	PVPART.1068	130.80
7212/12V/22 Btm Door Leaf - LH	US26	PVPART.1069	130.80
7212/12V/22 Btm Door Leaf - LH	US26D	PVPART.1070	112.40
7212/12V/22 Btm Door Leaf - LH	SP4	PVPART.1071	85.80
7212/12V/22 Btm Door Leaf - LH	SP10	PVPART.1072	85.80
7212/12V/22 Btm Door Leaf - LH	SP28	PVPART.1073	85.80

Contact Ives Customer Service for pricing on additional sizes and finishes

Bold pricing indicates item is in stock and available for **Fast Track** and **ProXpress**

IVES ARCHITECTURAL HARDWARE - Parts Price List

Description	Finish	Part No.	List Price Each
7222 Bottom Pivot (Continued)			
7212/12V/22 Btm Door Leaf - LH	SP313	PVPART.1074	85.80
7212/12V/22 Btm Door Leaf - LH	SPBLK	PVPART.1075	85.80
7222 Btm Cone Pkg	US3	PVPART.1440	121.10
7222 Btm Cone Pkg	US4	PVPART.1441	121.10
7222 Btm Cone Pkg	US10	PVPART.1442	121.10
7222 Btm Cone Pkg	US10B	PVPART.1443	121.10
7222 Btm Cone Pkg	US26	PVPART.1444	121.10
7222 Btm Cone Pkg	US26D	PVPART.1445	104.00
7222 Btm Cone Pkg	SP4	PVPART.1446	73.70
7222 Btm Cone Pkg	SP10	PVPART.1447	73.70
7222 Btm Cone Pkg	SP28	PVPART.1448	73.70
7222 Btm Cone Pkg	SP313	PVPART.1449	73.70
7222 Btm Cone Pkg	SPBLK	PVPART.1450	73.70
7222 Btm Mounting Pkg	-	PVPART.1451	21.70
7222 Security Mounting Pkg	-	PVPART.1452	12.20
Pivot Set Screw (Pkg of 10)	-	PVPART.1030	4.90
7212/12V/22 Pivot Bearing	-	PVPART.1031	4.90
7212/12V/22 Pivot Bearing Pin	-	PVPART.1093	4.90
7226 & 7226F Bottom Pivot			
7226/26F/27/27F Bottom Door Leaf	-	PVPART.1334	132.90
7226 Bottom Base Pkg	US3	PVPART.1453	136.70
7226 Bottom Base Pkg	US4	PVPART.1454	136.70
7226 Bottom Base Pkg	US10	PVPART.1455	136.70
7226 Bottom Base Pkg	US10B	PVPART.1456	136.70
7226 Bottom Base Pkg	US26	PVPART.1457	136.70
7226 Bottom Base Pkg	US26D	PVPART.1458	125.70
7226 Bottom Base Pkg	SP4	PVPART.1459	112.40
7226 Bottom Base Pkg	SP10	PVPART.1460	112.40
7226 Bottom Base Pkg	SP28	PVPART.1461	112.40
7226 Bottom Base Pkg	SP313	PVPART.1462	112.40
7226 Bottom Base Pkg	SPBLK	PVPART.1463	112.40
7226F/44F Bottom Base Pkg	US3	PVPART.1640	269.90
7226F/44F Bottom Base Pkg	US10	PVPART.1641	269.90
7226F/44F Bottom Base Pkg	US32	PVPART.1642	269.90
7226F/44F Bottom Base Pkg	US32D	PVPART.1643	259.00
7226F/44F Bottom Base Pkg	SP4	PVPART.1644	229.80
7226F/44F Bottom Base Pkg	SP10	PVPART.1645	229.80
7226F/44F Bottom Base Pkg	SP28	PVPART.1646	229.80
7226F/44F Bottom Base Pkg	SP313	PVPART.1647	229.80
7226F/44F Bottom Base Pkg	SPBLK	PVPART.1648	229.80
7226/26F Bottom Mounting Pkg	US3, US4, SP4	PVPART.1464	37.40
7226/26F Bottom Mounting Pkg	US10, SP10	PVPART.1465	37.40
7226/26F Bottom Mounting Pkg	US10B, SP313	PVPART.1466	37.40
7226/26F Bottom Mounting Pkg	US26, US26D, SP28	PVPART.1467	37.40
7226/26F Bottom Mounting Pkg	SPBLK	PVPART.1468	37.40
7226/26F Security Mounting Pkg	-	PVPART.1469	29.20
7226/27/30F/37F/44F/45F Cover	US3	PVPART.1470	48.30
7226/27/30F/37F/44F/45F Cover	US4	PVPART.1471	48.30
7226/27/30F/37F/44F/45F Cover	US10	PVPART.1472	48.30
7226/27/30F/37F/44F/45F Cover	US10B	PVPART.1473	48.30
7226/27/30F/37F/44F/45F Cover	US26, US32	PVPART.1474	48.30
7226/27/30F/37F/44F/45F Cover	US26D, US32D	PVPART.1476	48.30
7226/27/30F/37F/44F/45F Cover	SP4	PVPART.1478	48.30

Contact Ives Customer Service for pricing on additional sizes and finishes

Bold pricing indicates item is in stock and available for **Fast Track** and **ProXpress**

IVES ARCHITECTURAL HARDWARE - Parts Price List

Parts

Description	Finish	Part No.	List Price Each
7226 & 7226F Bottom Pivot (Continued)			
7226/27/30F/37F/44F/45F Cover	SP10	PVPART.1479	48.30
7226/27/30F/37F/44F/45F Cover	SP28	PVPART.1480	48.30
7226/27/30F/37F/44F/45F Cover	SP313	PVPART.1481	48.30
7226/27/30F/37F/44F/45F Cover	SPBLK	PVPART.1482	48.30
7226/27/30F/37F/44F/45F Cover Screw	US3	PVPART.1483	8.50
7226/27/30F/37F/44F/45F Cover Screw	US4, SP4	PVPART.1484	8.50
7226/27/30F/37F/44F/45F Cover Screw	US10, SP10	PVPART.1485	8.50
7226/27/30F/37F/44F/45F Cover Screw	US10B, SP313	PVPART.1486	8.50
7226/27/30F/37F/44F/45F Cover Screw	US26, US32	PVPART.1487	8.50
7226/27/30F/37F/44F/45F Cover Screw	US26D, US32D, SP28	PVPART.1488	8.50
7226/27/30F/37F/44F/45F Cover Screw	SPBLK	PVPART.1495	8.50
7226/27/37/44/45 Btm Pivot Bearing Pin	-	PVPART.1849	13.30
Pivot Set Screw (Pkg of 10)	-	PVPART.1030	4.90
7227 & 7227F Bottom Pivot			
7226/26F/27/27F Bottom Door Leaf	-	PVPART.1334	132.90
7227/27F/45F Base Pkg	-	PVPART.1497	444.10
7227/37/45/56/59 Finish Plate Pkg	US3	PVPART.1498	96.80
7227/37/45/56/59 Finish Plate Pkg	US4	PVPART.1499	96.80
7227/37/45/56/59 Finish Plate Pkg	US10	PVPART.1500	96.80
7227/37/45/56/59 Finish Plate Pkg	US10B	PVPART.1501	96.80
7227/37/45/56/59 Finish Plate Pkg	US26, US32	PVPART.1502	96.80
7227/37/45/56/59 Finish Plate Pkg	US26D, US32D	PVPART.1503	88.30
7227/37/45/56/59 Finish Plate Pkg	SP4	PVPART.1506	81.00
7227/37/45/56/59 Finish Plate Pkg	SP10	PVPART.1507	81.00
7227/37/45/56/59 Finish Plate Pkg	SP28	PVPART.1508	81.00
7227/37/45/56/59 Finish Plate Pkg	SP313	PVPART.1509	81.00
7227/37/45/56/59 Finish Plate Pkg	SPBLK	PVPART.1510	81.00
7227/7237F Bottom Mounting Pkg	US3, US4, SP4	PVPART.1511	37.40
7227/7237F Bottom Mounting Pkg	US10, SP10	PVPART.1512	37.40
7227/7237F Bottom Mounting Pkg	US10B, SP313	PVPART.1513	37.40
7227/7237F Bottom Mounting Pkg		PVPART.1514	37.40
7227/7237F Bottom Mounting Pkg	SPBLK	PVPART.1515	37.40
7227/7237F Bottom Security Mounting Pkg	-	PVPART.1516	38.70
7226/27/30F/37F/44F/45F Cover	US3	PVPART.1470	48.30
7226/27/30F/37F/44F/45F Cover	US4	PVPART.1471	48.30
7226/27/30F/37F/44F/45F Cover	US10	PVPART.1472	48.30
7226/27/30F/37F/44F/45F Cover	US10B	PVPART.1473	48.30
7226/27/30F/37F/44F/45F Cover	US26, US32	PVPART.1474	48.30
7226/27/30F/37F/44F/45F Cover	US26D, US32D	PVPART.1476	48.30
7226/27/30F/37F/44F/45F Cover	SP4	PVPART.1478	48.30
7226/27/30F/37F/44F/45F Cover	SP10	PVPART.1479	48.30
7226/27/30F/37F/44F/45F Cover	SP28	PVPART.1480	48.30
7226/27/30F/37F/44F/45F Cover	SP313	PVPART.1481	48.30
7226/27/30F/37F/44F/45F Cover	SPBLK	PVPART.1482	48.30
7226/27/30F/37F/44F/45F Cover Screw	US3	PVPART.1483	8.50
7226/27/30F/37F/44F/45F Cover Screw	US4, SP4	PVPART.1484	8.50
7226/27/30F/37F/44F/45F Cover Screw	US10, SP10	PVPART.1485	8.50
7226/27/30F/37F/44F/45F Cover Screw	US10B, SP313	PVPART.1486	8.50
7226/27/30F/37F/44F/45F Cover Screw	US26, US32	PVPART.1487	8.50
7226/27/30F/37F/44F/45F Cover Screw	US26D, US32D, SP28	PVPART.1488	8.50
7226/27/30F/37F/44F/45F Cover Screw	SPBLK	PVPART.1495	8.50
7227/37/45/56/59 Finish Plate Screw (Pkg of 10)	-	PVPART.1335	1.80
7226/27/37/44/45 Btm Pivot Bearing Pin	-	PVPART.1849	13.30
Pivot Set Screw (Pkg of 10)	-	PVPART.1030	4.90

Contact Ives Customer Service for pricing on additional sizes and finishes

Bold pricing indicates item is in stock and available for **Fast Track** and **ProXpress**

IVES ARCHITECTURAL HARDWARE - Parts Price List

Description	Finish	Part No.	List Price Each
7230F Bottom Pivot			
7230F/37F Btm Door Leaf	-	PVPART.1545	147.70
7230F Btm Base Pkg	US3	PVPART.1546	269.90
7230F Btm Base Pkg	US10	PVPART.1547	269.90
7230F Btm Base Pkg	US32	PVPART.1548	269.90
7230F Btm Base Pkg	US32D	PVPART.1549	259.00
7230F Btm Base Pkg	SP4	PVPART.1550	229.80
7230F Btm Base Pkg	SPI0	PVPART.1551	229.80
7230F Btm Base Pkg	SP28	PVPART.1552	229.80
7230F Btm Base Pkg	SP313	PVPART.1553	229.80
7230F Btm Base Pkg	SPBLK	PVPART.1554	229.80
7230F Btm Mounting Pkg	US3, SP4	PVPART.1555	39.90
7230F Btm Mounting Pkg	US10, SPI0	PVPART.1556	39.90
7230F Btm Mounting Pkg	US32, US32D, SP28	PVPART.1557	39.90
7230F Btm Mounting Pkg	SP313	PVPART.1562	39.90
7230F Btm Mounting Pkg	SPBLK	PVPART.1563	39.90
7230F Btm Security Mtg Pkg	-	PVPART.1564	35.20
7226/27/30F/37F/44F/45F Cover	US3	PVPART.1470	48.30
7226/27/30F/37F/44F/45F Cover	US10	PVPART.1472	48.30
7226/27/30F/37F/44F/45F Cover	US32	PVPART.1474	48.30
7226/27/30F/37F/44F/45F Cover	US32D	PVPART.1476	48.30
7226/27/30F/37F/44F/45F Cover	SP4	PVPART.1478	48.30
7226/27/30F/37F/44F/45F Cover	SPI0	PVPART.1479	48.30
7226/27/30F/37F/44F/45F Cover	SP28	PVPART.1480	48.30
7226/27/30F/37F/44F/45F Cover	SP313	PVPART.1481	48.30
7226/27/30F/37F/44F/45F Cover	SPBLK	PVPART.1482	48.30
7226/27/30F/37F/44F/45F Cover Screw	US3	PVPART.1483	8.50
7226/27/30F/37F/44F/45F Cover Screw	US10, SPI0	PVPART.1485	8.50
7226/27/30F/37F/44F/45F Cover Screw	US32	PVPART.1487	8.50
7226/27/30F/37F/44F/45F Cover Screw	US32D, SP28	PVPART.1488	8.50
7226/27/30F/37F/44F/45F Cover Screw	SP4	PVPART.1484	8.50
7226/27/30F/37F/44F/45F Cover Screw	SP313	PVPART.1486	8.50
7226/27/30F/37F/44F/45F Cover Screw	SPBLK	PVPART.1495	8.50
7230F Pivot Bearing Pin	-	PVPART.1850	13.30
Pivot Set Screw (Pkg of 10)	-	PVPART.1030	4.90
7237F Bottom Pivot			
7230F/37F Btm Door Leaf	-	PVPART.1545	147.70
7237F Btm Base Pkg	-	PVPART.1608	444.10
7227/37/45/56/59 Finish Plate Pkg	US3	PVPART.1498	96.80
7227/37/45/56/59 Finish Plate Pkg	US10	PVPART.1500	96.80
7227/37/45/56/59 Finish Plate Pkg	US32	PVPART.1502	96.80
7227/37/45/56/59 Finish Plate Pkg	US32D	PVPART.1503	88.30
7227/37/45/56/59 Finish Plate Pkg	SP4	PVPART.1506	81.00
7227/37/45/56/59 Finish Plate Pkg	SPI0	PVPART.1507	81.00
7227/37/45/56/59 Finish Plate Pkg	SP28	PVPART.1508	81.00
7227/37/45/56/59 Finish Plate Pkg	SP313	PVPART.1509	81.00
7227/37/45/56/59 Finish Plate Pkg	SPBLK	PVPART.1510	81.00
7227/7237F Btm Mounting Pkg	US3, SP4	PVPART.1511	37.40
7227/7237F Btm Mounting Pkg	US10, SPI0	PVPART.1512	37.40
7227/7237F Btm Mounting Pkg	SP313	PVPART.1513	37.40
7227/7237F Btm Mounting Pkg	US32, US32D, SP28	PVPART.1514	37.40
7227/7237F Btm Mounting Pkg	SPBLK	PVPART.1515	37.40
7227/7237F Btm Security Mtg Pkg	-	PVPART.1516	38.70
7226/27/30F/37F/44F/45F Cover	US3	PVPART.1470	48.30

Contact Ives Customer Service for pricing on additional sizes and finishes

Bold pricing indicates item is in stock and available for **Fast Track** and **ProXpress**

IVES ARCHITECTURAL HARDWARE - Parts Price List

Description	Finish	Part No.	List Price Each
7237F Bottom Pivot (Continued)			
7226/27/30F/37F/44F/45F Cover	US10	PVPART.1472	48.30
7226/27/30F/37F/44F/45F Cover	US32	PVPART.1474	48.30
7226/27/30F/37F/44F/45F Cover	US32D	PVPART.1476	48.30
7226/27/30F/37F/44F/45F Cover	SP4	PVPART.1478	48.30
7226/27/30F/37F/44F/45F Cover	SPI0	PVPART.1479	48.30
7226/27/30F/37F/44F/45F Cover	SP28	PVPART.1480	48.30
7226/27/30F/37F/44F/45F Cover	SP313	PVPART.1481	48.30
7226/27/30F/37F/44F/45F Cover	SPBLK	PVPART.1482	48.30
7226/27/30F/37F/44F/45F Cover Screw	US3	PVPART.1483	8.50
7226/27/30F/37F/44F/45F Cover Screw	US10, SPI0	PVPART.1485	8.50
7226/27/30F/37F/44F/45F Cover Screw	US32	PVPART.1487	8.50
7226/27/30F/37F/44F/45F Cover Screw	US32D, SP28	PVPART.1488	8.50
7226/27/30F/37F/44F/45F Cover Screw	SP4	PVPART.1484	8.50
7226/27/30F/37F/44F/45F Cover Screw	SP313	PVPART.1486	8.50
7226/27/30F/37F/44F/45F Cover Screw	SPBLK	PVPART.1495	8.50
7227/37/45/56/59 Finish Plate Screw (Pkg of 10)	-	PVPART.1335	1.80
7226/27/37/44/45 Btm Pivot Bearing Pin	-	PVPART.1849	13.30
Pivot Set Screw (Pkg of 10)	-	PVPART.1030	4.90
7244F Bottom Pivot			
7244F/45F Bottom Door Leaf	-	PVPART.1639	147.70
7226/26F/44F Bottom Base Pkg	US3	PVPART.1640	269.90
7226/26F/44F Bottom Base Pkg	US10	PVPART.1641	269.90
7226/26F/44F Bottom Base Pkg	US32	PVPART.1642	269.90
7226/26F/44F Bottom Base Pkg	US32D	PVPART.1643	259.00
7226/26F/44F Bottom Base Pkg	SP4	PVPART.1644	229.80
7226/26F/44F Bottom Base Pkg	SPI0	PVPART.1645	229.80
7226/26F/44F Bottom Base Pkg	SP28	PVPART.1646	229.80
7226/26F/44F Bottom Base Pkg	SP313	PVPART.1647	229.80
7226/26F/44F Bottom Base Pkg	SPBLK	PVPART.1648	229.80
7244F/7245F Bottom Mounting Pkg	US3, SP4	PVPART.1649	37.40
7244F/7245F Bottom Mounting Pkg	US10, SPI0	PVPART.1650	37.40
7244F/7245F Bottom Mounting Pkg	US32, US32D, SP28	PVPART.1651	37.40
7244F/7245F Bottom Mounting Pkg	SP313	PVPART.1652	37.40
7244F/7245F Bottom Mounting Pkg	SPBLK	PVPART.1653	37.40
7244F/45F Bottom Security Mounting Pkg	-	PVPART.1654	32.60
7226/27/30F/37F/44F/45F Cover	US3	PVPART.1470	48.30
7226/27/30F/37F/44F/45F Cover	US10	PVPART.1472	48.30
7226/27/30F/37F/44F/45F Cover	US32	PVPART.1474	48.30
7226/27/30F/37F/44F/45F Cover	US32D	PVPART.1476	48.30
7226/27/30F/37F/44F/45F Cover	SP4	PVPART.1478	48.30
7226/27/30F/37F/44F/45F Cover	SPI0	PVPART.1479	48.30
7226/27/30F/37F/44F/45F Cover	SP28	PVPART.1480	48.30
7226/27/30F/37F/44F/45F Cover	SP313	PVPART.1481	48.30
7226/27/30F/37F/44F/45F Cover	SPBLK	PVPART.1482	48.30
7226/27/30F/37F/44F/45F Cover Screw	US3	PVPART.1483	8.50
7226/27/30F/37F/44F/45F Cover Screw	US10, SPI0	PVPART.1485	8.50
7226/27/30F/37F/44F/45F Cover Screw	US32	PVPART.1487	8.50
7226/27/30F/37F/44F/45F Cover Screw	US32D, SP28	PVPART.1488	8.50
7226/27/30F/37F/44F/45F Cover Screw	SP4	PVPART.1484	8.50
7226/27/30F/37F/44F/45F Cover Screw	SP313	PVPART.1486	8.50
7226/27/30F/37F/44F/45F Cover Screw	SPBLK	PVPART.1495	8.50
7226/27/37/44/45 Btm Pivot Bearing Pin	-	PVPART.1849	13.30
Pivot Set Screw (Pkg of 10)	-	PVPART.1030	4.90

Contact Ives Customer Service for pricing on additional sizes and finishes

Bold pricing indicates item is in stock and available for **Fast Track** and **ProXpress**

IVES ARCHITECTURAL HARDWARE - Parts Price List

Description	Finish	Part No.	List Price Each
7245F Bottom Pivot			
7244F/45F Bottom Door Leaf	-	PVPART.1639	147.70
72/27/27F/45F Bottom Base Pkg	-	PVPART.1497	444.10
7227/37/45/56/59 Finish Plate Pkg	US3	PVPART.1498	96.80
7227/37/45/56/59 Finish Plate Pkg	US10	PVPART.1500	96.80
7227/37/45/56/59 Finish Plate Pkg	US32	PVPART.1502	96.80
7227/37/45/56/59 Finish Plate Pkg	US32D	PVPART.1503	88.30
7227/37/45/56/59 Finish Plate Pkg	SP4	PVPART.1506	81.00
7227/37/45/56/59 Finish Plate Pkg	SPI0	PVPART.1507	81.00
7227/37/45/56/59 Finish Plate Pkg	SP28	PVPART.1508	81.00
7227/37/45/56/59 Finish Plate Pkg	SP313	PVPART.1509	81.00
7227/37/45/56/59 Finish Plate Pkg	SPBLK	PVPART.1510	81.00
7244F/45F Bottom Mounting Pkg	US3, SP4	PVPART.1649	37.40
7244F/45F Bottom Mounting Pkg	US10, SPI0	PVPART.1650	37.40
7244F/45F Bottom Mounting Pkg	US32, US32D, SP28	PVPART.1651	37.40
7244F/45F Bottom Mounting Pkg	SP313	PVPART.1652	37.40
7244F/45F Bottom Mounting Pkg	SPBLK	PVPART.1653	37.40
7245F Bottom Security Mtg Pkg	-	PVPART.1654	32.60
7226/27/30F/37F/44F/45F Cover	US3	PVPART.1470	48.30
7226/27/30F/37F/44F/45F Cover	US10	PVPART.1472	48.30
7226/27/30F/37F/44F/45F Cover	US32	PVPART.1474	48.30
7226/27/30F/37F/44F/45F Cover	US32D	PVPART.1476	48.30
7226/27/30F/37F/44F/45F Cover	SP4	PVPART.1478	48.30
7226/27/30F/37F/44F/45F Cover	SPI0	PVPART.1479	48.30
7226/27/30F/37F/44F/45F Cover	SP28	PVPART.1480	48.30
7226/27/30F/37F/44F/45F Cover	SP313	PVPART.1481	48.30
7226/27/30F/37F/44F/45F Cover	SPBLK	PVPART.1482	48.30
7226/27/30F/37F/44F/45F Cover Screw	US3	PVPART.1483	8.50
7226/27/30F/37F/44F/45F Cover Screw	US10, SPI0	PVPART.1485	8.50
7226/27/30F/37F/44F/45F Cover Screw	US32	PVPART.1487	8.50
7226/27/30F/37F/44F/45F Cover Screw	US32D, SP28	PVPART.1488	8.50
7226/27/30F/37F/44F/45F Cover Screw	SP4	PVPART.1484	8.50
7226/27/30F/37F/44F/45F Cover Screw	SP313	PVPART.1486	8.50
7226/27/30F/37F/44F/45F Cover Screw	SPBLK	PVPART.1495	8.50
7226/27/37/44/45 Btm Pivot Bearing Pin	-	PVPART.1849	13.30
Pivot Set Screw (Pkg of 10)	-	PVPART.1030	4.90
7227/37/45/56/59 Finish Plate Screw (Pkg of 10)	-	PVPART.1335	1.80
7253 Bottom Pivot			
7253 Btm Door Leaf	-	PVPART.1735	147.70
7253 Btm Base	US3	PVPART.1736	59.50
7253 Btm Base	US4	PVPART.1737	59.50
7253 Btm Base	US10	PVPART.1738	59.50
7253 Btm Base	US10B	PVPART.1739	59.50
7253 Btm Base	US26	PVPART.1740	59.50
7253 Btm Base	US26D	PVPART.1741	59.50
7253 Btm Base	SP4	PVPART.1742	51.90
7253 Btm Base	SPI0	PVPART.1743	51.90
7253 Btm Base	SP28	PVPART.1744	51.90
7253 Btm Base	SP313	PVPART.1745	51.90
7253 Btm Base	SPBLK	PVPART.1746	51.90
7253 Bearing	-	PVPART.1704	19.30
7253 Btm Mounting Pkg	-	PVPART.1747	44.80
7253 Btm Security Mounting Pkg	-	PVPART.1748	8.50
7255 Bottom Pivot			

Contact Ives Customer Service for pricing on additional sizes and finishes

Bold pricing indicates item is in stock and available for **Fast Track** and **ProXpress**

IVES ARCHITECTURAL HARDWARE - Parts Price List

Description	Finish	Part No.	List Price Each
7255 Bottom Pivot (Continued)			
7255/55J Bottom Door Leaf	-	PVPART.1749	111.40
7255 Btm Base	US3	PVPART.1750	97.90
7255 Btm Base	US4	PVPART.1751	97.90
7255 Btm Base	US10	PVPART.1752	97.90
7255 Btm Base	US10B	PVPART.1753	97.90
7255 Btm Base	US26	PVPART.1754	97.90
7255 Btm Base	US26D	PVPART.1755	97.90
7255 Btm Base	SP4	PVPART.1756	93.20
7255 Btm Base	SP10	PVPART.1757	93.20
7255 Btm Base	SP28	PVPART.1758	93.20
7255 Btm Base	SP313	PVPART.1759	93.20
7255 Btm Base	SPBLK	PVPART.1760	93.20
7255 Btm Mounting Pkg	US3, US4, SP4	PVPART.1761	18.10
7255 Btm Mounting Pkg	US10, SP10	PVPART.1762	18.10
7255 Btm Mounting Pkg	US10B, SP313	PVPART.1763	18.10
7255 Btm Mounting Pkg	US26, US26D, SP28	PVPART.1764	18.10
7255 Btm Mounting Pkg	SPBLK	PVPART.1765	18.10
7255 Btm Security Mounting Pkg	-	PVPART.1766	20.60
7255J Bottom Pivot			
7255/55J Bottom Door Leaf	-	PVPART.1749	111.40
7255J Bottom Base	US3	PVPART.1767	97.90
7255J Bottom Base	US4	PVPART.1768	97.90
7255J Bottom Base	US10	PVPART.1769	97.90
7255J Bottom Base	US10B	PVPART.1770	97.90
7255J Bottom Base	US26	PVPART.1771	97.90
7255J Bottom Base	US26D	PVPART.1772	97.90
7255J Bottom Base	SP4	PVPART.1773	93.20
7255J Bottom Base	SP10	PVPART.1774	93.20
7255J Bottom Base	SP28	PVPART.1775	93.20
7255J Bottom Base	SP313	PVPART.1776	93.20
7255J Bottom Base	SPBLK	PVPART.1777	93.20
7255J Bottom Mounting Pkg	US3, US4, SP4	PVPART.1778	12.20
7255J Bottom Mounting Pkg	US10, SP10	PVPART.1779	12.20
7255J Bottom Mounting Pkg	US10B, SP313	PVPART.1780	12.20
7255J Bottom Mounting Pkg	US26, US26D, SP28	PVPART.1781	12.20
7255J Bottom Mounting Pkg	SPBLK	PVPART.1782	12.20
7255J Btm Security Mtg Pkg	-	PVPART.1783	18.10
7255J Bottom Wood Mtg Pkg	US3, US4, SP4	PVPART.1864	8.50
7255J Bottom Wood Mtg Pkg	US10, SP10	PVPART.1865	8.50
7255J Bottom Wood Mtg Pkg	US10B, SP313	PVPART.1866	8.50
7255J Bottom Wood Mtg Pkg	US26, US26D, SP28	PVPART.1867	8.50
7255J Bottom Wood Mtg Pkg	SPBLK	PVPART.1868	8.50
7256 Bottom Pivot			
7256 Btm Door Leaf	-	PVPART.1784	111.40
7256 Btm Base Pkg	-	PVPART.1785	407.70
7227/37/45/56/59 Finish Plate Pkg	US3	PVPART.1498	96.80
7227/37/45/56/59 Finish Plate Pkg	US4	PVPART.1499	96.80
7227/37/45/56/59 Finish Plate Pkg	US10	PVPART.1500	96.80
7227/37/45/56/59 Finish Plate Pkg	US10B	PVPART.1501	96.80
7227/37/45/56/59 Finish Plate Pkg	US26	PVPART.1502	96.80
7227/37/45/56/59 Finish Plate Pkg	US26D	PVPART.1503	88.30
7227/37/45/56/59 Finish Plate Pkg	SP4	PVPART.1506	81.00
7227/37/45/56/59 Finish Plate Pkg	SP10	PVPART.1507	81.00

Contact Ives Customer Service for pricing on additional sizes and finishes

Bold pricing indicates item is in stock and available for **Fast Track** and **ProXpress**

IVES ARCHITECTURAL HARDWARE - Parts Price List

Description	Finish	Part No.	List Price Each
7256 Bottom Pivot (Continued)			
7227/37/45/56/59 Finish Plate Pkg	SP28	PVPART.1508	81.00
7227/37/45/56/59 Finish Plate Pkg	SP313	PVPART.1509	81.00
7227/37/45/56/59 Finish Plate Pkg	SPBLK	PVPART.1510	81.00
7256 Btm Mounting Pkg	-	PVPART.1786	8.50
7256 Btm Security Mounting Pkg	-	PVPART.1787	12.20
7227/37/45/56/59 Finish Plate Screw (Pkg of 10)	-	PVPART.1335	1.80
7259 Bottom Pivot			
7259 Btm Door Leaf	-	PVPART.1817	222.80
7259 Btm Base Kit	-	PVPART.1818	592.80
7227/37/45/56/59 Finish Plate Pkg	US3	PVPART.1498	96.80
7227/37/45/56/59 Finish Plate Pkg	US4	PVPART.1499	96.80
7227/37/45/56/59 Finish Plate Pkg	US10	PVPART.1500	96.80
7227/37/45/56/59 Finish Plate Pkg	US10B	PVPART.1501	96.80
7227/37/45/56/59 Finish Plate Pkg	US26	PVPART.1502	96.80
7227/37/45/56/59 Finish Plate Pkg	US26D	PVPART.1503	88.30
7227/37/45/56/59 Finish Plate Pkg	SP4	PVPART.1506	81.00
7227/37/45/56/59 Finish Plate Pkg	SP10	PVPART.1507	81.00
7227/37/45/56/59 Finish Plate Pkg	SP28	PVPART.1508	81.00
7227/37/45/56/59 Finish Plate Pkg	SP313	PVPART.1509	81.00
7227/37/45/56/59 Finish Plate Pkg	SPBLK	PVPART.1510	81.00
7259 Btm Mounting Pkg	-	PVPART.1819	12.20
7259 Btm Security Mtg Pkg	-	PVPART.1820	26.60
91105 Pocket Pivot			
91105 Pocket Pivot Mtg Pkg	US3	PVPART.1188	18.10
91105 Pocket Pivot Mtg Pkg	US10	PVPART.1189	18.10
91105 Pocket Pivot Mtg Pkg	US32, US32D, USP	PVPART.1190	18.10
91105 Pocket Pivot Mtg Pkg	SP313	PVPART.1191	18.10
AS18			
AS18 Mounting Pkg	US3, US4	ASPART.1001	5.50
AS18 Mounting Pkg	US10	ASPART.1002	5.50
AS18 Mounting Pkg	US10B	ASPART.1003	5.50
AS18 Mounting Pkg	US26, US26D	ASPART.1004	5.50
Silencer (Pkg of 10)	-	ASPART.1005	5.50
AS18 Security Mounting Pkg	-	ASPART.1006	11.10
AS895			
AS895 Mounting Pkg	US3, US4	ASPART.1007	5.50
AS895 Mounting Pkg	US10	ASPART.1008	5.50
AS895 Mounting Pkg	US10B	ASPART.1009	5.50
AS895 Mounting Pkg	US26, US26D	ASPART.1010	5.50
AS895 Security Mounting Pkg	-	ASPART.1011	11.10
CBI			
CBI Roller & Pin Pkg	-	CBPART.1001	5.50
CBI Mounting Pkg	US3, US4	CBPART.1002	14.20
CBI Mounting Pkg	US10	CBPART.1003	14.20
CBI Mounting Pkg	US10B	CBPART.1004	14.20
CBI Mounting Pkg	USP, US26, US26D	CBPART.1005	14.20
CBI Mounting Pkg	SPBLK	CBPART.1006	14.20
CBI Security Mounting Pkg	-	CBPART.1007	8.40
CL11			
CL11 Mounting Pkg	US3, US4	CLPART.1001	7.00
CL11 Mounting Pkg	US10	CLPART.1002	7.00
CL11 Mounting Pkg	US26D	CLPART.1003	7.00
CL11 Hook Pkg	US3	CLPART.1004	16.70

Contact Ives Customer Service for pricing on additional sizes and finishes

Bold pricing indicates item is in stock and available for **Fast Track** and **ProXpress**

IVES ARCHITECTURAL HARDWARE - Parts Price List

Description	Finish	Part No.	List Price Each
CL11 (Continued)			
CL11 Hook Pkg	US4	CLPART.1005	14.20
CL11 Hook Pkg	US10	CLPART.1006	14.20
CL11 Hook Pkg	US26D	CLPART.1007	14.20
CL11 Security Mounting Pkg	-	CLPART.1008	14.20
CL12			
CL12 Mounting Pkg	US3, US4	CLPART.1009	7.00
CL12 Mounting Pkg	US10	CLPART.1010	7.00
CL12 Mounting Pkg	US26D	CLPART.1011	7.00
CL12 Hook Pkg	US3	CLPART.1012	16.70
CL12 Hook Pkg	US4	CLPART.1013	14.20
CL12 Hook Pkg	US10	CLPART.1014	14.20
CL12 Hook Pkg	US26D	CLPART.1015	14.20
CL12 Security Mounting Pkg	-	CLPART.1016	16.70
CL14			
CL14 Mounting Pkg	US3, US4	CLPART.1017	4.20
CL14 Mounting Pkg	US10	CLPART.1018	4.20
CL14 Mounting Pkg	US26D	CLPART.1019	4.20
CL14 Security Mounting Pkg	-	CLPART.1020	5.50
CL21			
CL21 Mounting Package	US26D	CLPART.1021	4.20
CL21 Hook Package	US26D	CLPART.1022	19.70
CL21 Security Mounting Package	-	CLPART.1023	5.50
CL21A			
CL21A Mounting Package	US3, US4	CLPART.1024	5.50
CL21A Mounting Package	US10	CLPART.1025	5.50
CL21A Mounting Package	US26, US26D	CLPART.1027	5.50
CL21A Hook Package	US3	CLPART.1028	19.70
CL21A Hook Package	US4	CLPART.1029	16.70
CL21A Hook Package	US10	CLPART.1030	16.70
CL21A Hook Package	US26	CLPART.1032	19.70
CL21A Hook Package	US26D	CLPART.1033	16.70
CL21A Security Mounting Package	-	CLPART.1034	11.10
CL22			
CL22 Mounting Pkg	US3, US4	CLPART.1035	5.50
CL22 Mounting Pkg	US10	CLPART.1036	5.50
CL22 Mounting Pkg	US26, US26D	CLPART.1038	5.50
CL22 Hook Pkg	US3	CLPART.1039	14.20
CL22 Hook Pkg	US4	CLPART.1040	11.10
CL22 Hook Pkg	US10	CLPART.1041	11.10
CL22 Hook Pkg	US26	CLPART.1043	14.20
CL22 Hook Pkg	US26D	CLPART.1044	11.10
CL22 Security Mounting Pkg	-	CLPART.1045	11.10
COR7G/COR9G			
COR7G/9G Nylon Roller & Bolt Pkg	US3,US4	CORPART.1001	20.90
COR7G/9G Nylon Roller & Bolt Pkg	US10	CORPART.1022	20.90
COR7G/9G Nylon Roller & Bolt Pkg	US10B	CORPART.1023	20.90
COR7G/9G Nylon Roller & Bolt Pkg	US26,US26D	CORPART.1024	20.90
COR7G/9G Rubber Roller & Pin Pkg	-	CORPART.1002	8.40
COR7G/9G Door Bracket Pkg	US3	CORPART.1003	25.10
COR7G/9G Door Bracket Pkg	US4	CORPART.1004	25.10
COR7G/9G Door Bracket Pkg	US10	CORPART.1005	25.10
COR7G/9G Door Bracket Pkg	US10B	CORPART.1006	25.10
COR7G/9G Door Bracket Pkg	US26	CORPART.1007	25.10

Contact Ives Customer Service for pricing on additional sizes and finishes

Bold pricing indicates item is in stock and available for **Fast Track** and **ProXpress**

IVES ARCHITECTURAL HARDWARE - Parts Price List

Description	Finish	Part No.	List Price Each
COR7G/COR9G (Continued)			
COR7G/9G Door Bracket Pkg	US26D	CORPART.1008	25.10
COR7G/9G Rub Plate Pkg	-	CORPART.1009	5.50
COR7G/9G Mounting Pkg	US3, US4	CORPART.1010	16.70
COR7G/9G Mounting Pkg	US10	CORPART.1011	16.70
COR7G/9G Mounting Pkg	US10B	CORPART.1012	16.70
COR7G/9G Mounting Pkg	US26, US26D	CORPART.1013	16.70
COR7G/9G Security Mounting Pkg	-	CORPART.1021	19.70
COR32/COR42/COR52/COR60/COR72			
COR32/42/52/60/72 Rub Plate (Pkg of 2)	-	CORPART.1014	9.50
COR32/42/52/60/72 Mounting Pkg	US28, US26D	CORPART.1018	9.50
COR32/42/52/60/72 Mounting Pkg	315AN	CORPART.1019	25.40
COR32/42/52/60/72 Security Mounting Pkg	-	CORPART.1020	33.80
CS115			
CS115/SB453/454/0454 Thru Bolt with Cap Nut Pkg (Set of 4)	US26D	09-340-626	8.10
Sex Bolt Pkg	US26D, US2C	09-351-604	14.90
DP2			
DP2 Plate Pkg	US3	DPPART.1001	11.10
DP2 Plate Pkg	US4	DPPART.1002	11.10
DP2 Plate Pkg	US10	DPPART.1003	11.10
DP2 Plate Pkg	US10B	DPPART.1004	11.10
DP2 Plate Pkg	US26	DPPART.1005	11.10
DP2 Plate Pkg	US26D	DPPART.1006	11.10
DP2 Mounting Pkg	US3, US4	DPPART.1007	4.20
DP2 Mounting Pkg	US10	DPPART.1008	4.20
DP2 Mounting Pkg	US10B	DPPART.1009	4.20
DP2 Mounting Pkg	US26, US26D	DPPART.1010	4.20
DP2 Security Mounting Pkg	-	DPPART.1011	5.50
FB30 Series - Metal Door Automatic Flushbolt			
FB30T Face Plate Pkg	US3	FBPART.1001	37.60
FB30T Face Plate Pkg	US4	FBPART.1002	37.60
FB30T Face Plate Pkg	US10	FBPART.1003	37.60
FB30T Face Plate Pkg	US10B	FBPART.1004	37.60
FB30T Face Plate Pkg	US32	FBPART.1005	37.60
FB30T Face Plate Pkg	US32D	FBPART.1006	37.60
FB30B/50B Face Plate Pkg	US3	FBPART.1007	37.60
FB30B/50B Face Plate Pkg	US4	FBPART.1008	37.60
FB30B/50B Face Plate Pkg	US10	FBPART.1009	37.60
FB30B/50B Face Plate Pkg	US10B	FBPART.1010	37.60
FB30B/50B Face Plate Pkg	US32	FBPART.1011	37.60
FB30B/50B Face Plate Pkg	US32D	FBPART.1012	37.60
FB30/50 Guide Pkg	-	FBPART.1013	7.00
FB30/40/50/60 Rub Plate & Shim Pkg	-	FBPART.1014	2.90
FB30/40/50B/60B Auxiliary Bolt	-	FBPART.1015	4.20
FB30/50 8 3/4" Rod & Bolt Tip Kit - 12"	-	FBPART.1016	11.10
FB30/50B Bolt Tip	-	FBPART.1017	11.10
FB30/50 8 3/4" - 12" Rod Only	-	FBPART.1018	5.50
FB30/50 7 1/2" Rod & Bolt Tip Kit - 9"	-	FBPART.1019	11.10
FB30/50 16 1/2" Rod & Bolt Tip Kit - 18"	-	FBPART.1020	11.10
FB30/50 22 1/2" Rod & Bolt Tip Kit - 24"	-	FBPART.1021	11.10
FB30/50 28 1/2" Rod & Bolt Tip Kit - 30"	-	FBPART.1022	11.10
FB30/50 34 1/2" Rod & Bolt Tip Kit - 36"	-	FBPART.1023	11.10
FB30/50 46 1/2" Rod & Bolt Tip Kit - 48"	-	FBPART.1024	11.10
FB30/40/50B/60B Strike Pkg	US3, US4	FBPART.1025	8.40

Contact Ives Customer Service for pricing on additional sizes and finishes

Bold pricing indicates item is in stock and available for **Fast Track** and **ProXpress**

IVES ARCHITECTURAL HARDWARE - Parts Price List

Description	Finish	Part No.	List Price Each
FB30 Series - Metal Door Automatic Flushbolt (Continued)			
FB30/40/50B/60B Strike Pkg	US10	FBPART.1026	8.40
FB30/40/50B/60B Strike Pkg	US10B	FBPART.1027	8.40
FB30/40/50B/60B Strike Pkg	US32, US32D	FBPART.1028	8.40
FB30/50 Mounting Pkg	US3, US4	FBPART.1029	19.70
FB30/50 Mounting Pkg	US10	FBPART.1030	19.70
FB30/50 Mounting Pkg	US10B	FBPART.1031	19.70
FB30/50 Mounting Pkg	US32, US32D	FBPART.1032	19.70
FB30/50 Security Mounting Pkg	-	FBPART.1033	33.50
FB32/42/52/62 AFL Plug/Screw Pkg	-	FBPART.1034	4.90
FB32/42/52/62 Auxiliary Fire Latch	-	FBPART.1035	118.80
FB30/50 Retrofit Pkg	-	FBPART.1065	9.50
FB30/40/50/60 Face Plate Screws, Pkg 10	US3, US4	FBPART.1066	6.10
FB30/40/50/60 Face Plate Screws, Pkg 10	US10	FBPART.1067	6.10
FB30/40/50/60 Face Plate Screws, Pkg 10	US10B	FBPART.1068	6.10
FB30/40/50/60 Face Plate Screws, Pkg 10	US32, US32D	FBPART.1069	6.10
FB40 Series - Wood Door Automatic Flushbolt			
FB40T Face Plate Pkg	US3	FBPART.1036	37.60
FB40T Face Plate Pkg	US4	FBPART.1037	37.60
FB40T Face Plate Pkg	US10	FBPART.1038	37.60
FB40T Face Plate Pkg	US10B	FBPART.1039	37.60
FB40T Face Plate Pkg	US32	FBPART.1040	37.60
FB40T Face Plate Pkg	US32D	FBPART.1041	37.60
FB40B/60B Face Plate Pkg	US3	FBPART.1042	37.60
FB40B/60B Face Plate Pkg	US4	FBPART.1043	37.60
FB40B/60B Face Plate Pkg	US10	FBPART.1044	37.60
FB40B/60B Face Plate Pkg	US10B	FBPART.1045	37.60
FB40B/60B Face Plate Pkg	US32	FBPART.1046	37.60
FB40B/60B Face Plate Pkg	US32D	FBPART.1047	37.60
FB30/40/50/60 Rub Plate & Shim Pkg	-	FBPART.1014	2.90
FB40/60 Guide Pkg	-	FBPART.1048	8.40
FB40/60 Cover	-	FBPART.1049	5.50
FB30/40/50B/60B Auxiliary Bolt	-	FBPART.1015	4.20
FB40/60B Rod & Bolt Tip Kit	-	FBPART.1050	8.40
FB40/60B Bolt Tip	-	FBPART.1051	4.20
FB40/60 Rod - 2 1/2"	-	FBPART.1052	4.20
FB30/40/50B/60B Strike Pkg	US3, US4	FBPART.1025	8.40
FB30/40/50B/60B Strike Pkg	US10	FBPART.1026	8.40
FB30/40/50B/60B Strike Pkg	US10B	FBPART.1027	8.40
FB30/40/50B/60B Strike Pkg	US32, US32D	FBPART.1028	8.40
FB40/60 Mounting Pkg	US3, US4	FBPART.1053	19.70
FB40/60 Mounting Pkg	US10	FBPART.1054	19.70
FB40/60 Mounting Pkg	US10B	FBPART.1055	19.70
FB40/60 Mounting Pkg	US32, US32D	FBPART.1056	19.70
FB40/60 Security Mounting Pkg	-	FBPART.1057	30.80
FB32/42/52/62 AFL Plug/Screw Pkg	-	FBPART.1034	4.90
FB32/42/52/62 Auxiliary Fire Latch	-	FBPART.1035	118.80
FB30/40/50/60 Face Plate Screws. Pkg 10	US3, US4	FBPART.1066	6.10
FB30/40/50/60 Face Plate Screws. Pkg 10	US10	FBPART.1067	6.10
FB30/40/50/60 Face Plate Screws. Pkg 10	US10B	FBPART.1068	6.10
FB30/40/50/60 Face Plate Screws. Pkg 10	US32, US32D	FBPART.1069	6.10
FB50 Series - Metal Door Constant Latching Flushbolt			
FB50T Face Plate Pkg	US3	FBPART.1058	37.60
FB50T Face Plate Pkg	US4	FBPART.1059	37.60

Contact Ives Customer Service for pricing on additional sizes and finishes

Bold pricing indicates item is in stock and available for **Fast Track** and **ProXpress**

IVES ARCHITECTURAL HARDWARE - Parts Price List

Description	Finish	Part No.	List Price Each
FB50 Series - Metal Door Constant Latching Flushbolt (continued)			
FB50T Face Plate Pkg	US10	FBPART.1060	37.60
FB50T Face Plate Pkg	US10B	FBPART.1061	37.60
FB50T Face Plate Pkg	US32	FBPART.1062	37.60
FB50T Face Plate Pkg	US32D	FBPART.1063	37.60
FB30B/50B Face Plate Pkg	US3	FBPART.1007	37.60
FB30B/50B Face Plate Pkg	US4	FBPART.1008	37.60
FB30B/50B Face Plate Pkg	US10	FBPART.1009	37.60
FB30B/50B Face Plate Pkg	US10B	FBPART.1010	37.60
FB30B/50B Face Plate Pkg	US32	FBPART.1011	37.60
FB30B/50B Face Plate Pkg	US32D	FBPART.1012	37.60
FB30/50 Guide Pkg	-	FBPART.1013	7.00
FB30/40/50/60 Rub Plate & Shim Pkg	-	FBPART.1014	2.90
FB30/40/50B/60B Auxiliary Bolt	-	FBPART.1015	4.20
FB50T/60T Auxiliary Bolt	-	FBPART.1070	8.40
FB50T Rod & Bolt Tip Kit - 12"	-	FBPART.1071	12.50
FB50T Bolt Tip	-	FBPART.1072	7.00
FB50 Series - Metal Door Constant Latching Flushbolt			
FB30/50 8 3/4" Rod & Bolt Tip Kit - 12"	-	FBPART.1016	11.10
FB30/50B Bolt Tip	-	FBPART.1017	11.10
FB30/50 8 3/4" - 12" Rod Only	-	FBPART.1018	5.50
FB30/50 7 1/2" Rod & Bolt Tip Kit - 9"	-	FBPART.1019	11.10
FB30/50 16 1/2" Rod & Bolt Tip Kit - 18"	-	FBPART.1020	11.10
FB30/50 22 1/2" Rod & Bolt Tip Kit - 24"	-	FBPART.1021	11.10
FB30/50 28 1/2" Rod & Bolt Tip Kit - 30"	-	FBPART.1022	11.10
FB30/50 34 1/2" Rod & Bolt Tip Kit - 36"	-	FBPART.1023	11.10
FB30/50 46 1/2" Rod & Bolt Tip Kit - 48"	-	FBPART.1024	11.10
FB30/40/50B/60B Strike Pkg	US3, US4	FBPART.1025	8.40
FB30/40/50B/60B Strike Pkg	US10	FBPART.1026	8.40
FB30/40/50B/60B Strike Pkg	US10B	FBPART.1027	8.40
FB30/40/50B/60B Strike Pkg	US32, US32D	FBPART.1028	8.40
FB30/50 Mounting Pkg	US3, US4	FBPART.1029	19.70
FB30/50 Mounting Pkg	US10	FBPART.1030	19.70
FB30/50 Mounting Pkg	US10B	FBPART.1031	19.70
FB30/50 Mounting Pkg	US32, US32D	FBPART.1032	19.70
FB30/50 Security Mounting Pkg	-	FBPART.1033	33.50
FB50T/60T Top Strike Pkg	US3	FBPART.1073	23.60
FB50T/60T Top Strike Pkg	US4	FBPART.1074	23.60
FB50T/60T Top Strike Pkg	US10	FBPART.1075	23.60
FB50T/60T Top Strike Pkg	US10B	FBPART.1076	23.60
FB50T/60T Top Strike Pkg	US32, US32D	FBPART.1077	23.60
FB32/42/52/62 AFL Plug/Screw Pkg	-	FBPART.1034	4.90
FB32/42/52/62 Auxiliary Fire Latch	-	FBPART.1035	118.80
FB30/50 Retrofit Plate Pkg	-	FBPART.1065	9.50
FB30/40/50/60 Face Plate Screws. Pkg 10	US3, US4	FBPART.1066	6.10
FB30/40/50/60 Face Plate Screws. Pkg 10	US10	FBPART.1067	6.10
FB30/40/50/60 Face Plate Screws. Pkg 10	US10B	FBPART.1068	6.10
FB30/40/50/60 Face Plate Screws. Pkg 10	US32, US32D	FBPART.1069	6.10
FB60 Series - Wood Door Constant Latching Flushbolt			
FB60T Face Plate Pkg	US3	FBPART.1078	37.60
FB60T Face Plate Pkg	US4	FBPART.1079	37.60
FB60T Face Plate Pkg	US10	FBPART.1080	37.60
FB60T Face Plate Pkg	US10B	FBPART.1081	37.60
FB60T Face Plate Pkg	US32	FBPART.1082	37.60

Contact Ives Customer Service for pricing on additional sizes and finishes

Bold pricing indicates item is in stock and available for **Fast Track** and **ProXpress**

IVES ARCHITECTURAL HARDWARE - Parts Price List

Description	Finish	Part No.	List Price Each
FB60 Series - Wood Door Constant Latching Flushbolt (Continued)			
FB60T Face Plate Pkg	US32D	FBPART.1083	37.60
FB40B/60B Face Plate Pkg	US3	FBPART.1042	37.60
FB40B/60B Face Plate Pkg	US4	FBPART.1043	37.60
FB40B/60B Face Plate Pkg	US10	FBPART.1044	37.60
FB40B/60B Face Plate Pkg	US10B	FBPART.1045	37.60
FB40B/60B Face Plate Pkg	US32	FBPART.1046	37.60
FB40B/60B Face Plate Pkg	US32D	FBPART.1047	37.60
FB30/40/50/60 Rub Plate & Shim Pkg	-	FBPART.1014	2.90
FB40/60 Guide Pkg	-	FBPART.1048	8.40
FB40/60 Cover	-	FBPART.1049	5.50
FB30/40/50B/60B Auxiliary Bolt	-	FBPART.1015	4.20
FB50T/60T Auxiliary Bolt	-	FBPART.1070	8.40
FB60T Rod & Bolt Tip Kit	-	FBPART.1090	11.10
FB60T Bolt Tip	-	FBPART.1091	7.00
FB40/60B Rod & Bolt Tip Kit	-	FBPART.1050	8.40
FB40/60B Bolt Tip	-	FBPART.1051	4.20
FB40/60 Rod - 2 1/2"	-	FBPART.1052	4.20
FB60 Series - Wood Door Constant Latching Flushbolt			
FB30/40/50B/60B Strike Pkg	US3, US4	FBPART.1025	8.40
FB30/40/50B/60B Strike Pkg	US10	FBPART.1026	8.40
FB30/40/50B/60B Strike Pkg	US10B	FBPART.1027	8.40
FB30/40/50B/60B Strike Pkg	US32, US32D	FBPART.1028	8.40
FB40/60 Mounting Pkg	US3, US4	FBPART.1053	19.70
FB40/60 Mounting Pkg	US10	FBPART.1054	19.70
FB40/60 Mounting Pkg	US10B	FBPART.1055	19.70
FB40/60 Mounting Pkg	US32, US32D	FBPART.1056	19.70
FB40/60 Security Mounting Pkg	-	FBPART.1057	30.80
FB50T/60T Top Strike Pkg	US3	FBPART.1073	23.60
FB50T/60T Top Strike Pkg	US4	FBPART.1074	23.60
FB50T/60T Top Strike Pkg	US10	FBPART.1075	23.60
FB50T/60T Top Strike Pkg	US10B	FBPART.1076	23.60
FB50T/60T Top Strike Pkg	US32, US32D	FBPART.1077	23.60
FB32/42/52/62 AFL Plug/Screw Pkg	-	FBPART.1034	4.90
FB32/42/52/62 Auxiliary Fire Latch	-	FBPART.1035	118.80
FB30/40/50/60 Face Plate Screws. Pkg 10	US3, US4	FBPART.1066	6.10
FB30/40/50/60 Face Plate Screws. Pkg 10	US10	FBPART.1067	6.10
FB30/40/50/60 Face Plate Screws. Pkg 10	US10B	FBPART.1068	6.10
FB30/40/50/60 Face Plate Screws. Pkg 10	US32, US32D	FBPART.1069	6.10
FB457//FB458 Metal Door Manual Flushbolt			
Guide	-	09-135	2.10
Bolt Tip	-	09-176-604	4.80
Rod - 18"	-	09-161	5.80
Rod - 24"	-	09-162	5.80
Rod - 36"	-	09-172	5.80
Rod - 48"	-	09-173	5.80
FS9			
FS9 Hook Pkg	US3	FSPART.1001	48.90
FS9 Hook Pkg	US4	FSPART.1002	48.90
FS9 Hook Pkg	US10	FSPART.1003	48.90
FS9 Hook Pkg	US10B	FSPART.1004	42.10
FS9 Hook Pkg	US26	FSPART.1005	48.90
FS9 Hook Pkg	US26D	FSPART.1006	42.10
FS9 Mounting Pkg	US3, US4	FSPART.1007	5.50

Contact Ives Customer Service for pricing on additional sizes and finishes

Bold pricing indicates item is in stock and available for **Fast Track** and **ProXpress**

IVES ARCHITECTURAL HARDWARE - Parts Price List

Description	Finish	Part No.	List Price Each
FB457//FB458 Metal Door Manual Flushbolt (Continued)			
FS9 Mounting Pkg	US10	FSPART.1008	5.50
FS9 Mounting Pkg	US10B	FSPART.1009	5.50
FS9 Mounting Pkg	US26, US26D	FSPART.1010	5.50
FS9 Security Mounting Pkg	-	FSPART.1011	8.40
FS9 Stud & Lead Anchor Pkg	-	FSPART.1012	8.40
FS13/FS17			
FS13/17 Rubber (Pkg of 6)	-	FSPART.1013	16.70
FS13/17 Mounting Pkg	US3, US4	FSPART.1014	2.90
FS13/17 Mounting Pkg	US10	FSPART.1015	2.90
FS13/17 Mounting Pkg	US10B	FSPART.1016	2.90
FS13/17 Mounting Pkg	US26, US26D	FSPART.1017	2.90
FS13/17 Security Mounting Pkg	-	FSPART.1018	2.90
FS40/FS41/FS42/FS43			
FS40 Strike Pkg	US3	FSPART.1019	29.40
FS40 Strike Pkg	US4	FSPART.1020	28.00
FS40 Strike Pkg	US10	FSPART.1021	28.00
FS40 Strike Pkg	US10B	FSPART.1022	35.00
FS40 Strike Pkg	US26	FSPART.1023	29.40
FS40 Strike Pkg	US26D	FSPART.1024	28.00
FS41 Strike Pkg	US3	FSPART.1034	29.40
FS41 Strike Pkg	US4	FSPART.1035	28.00
FS41 Strike Pkg	US10	FSPART.1036	28.00
FS41 Strike Pkg	US10B	FSPART.1037	35.00
FS41 Strike Pkg	US26	FSPART.1038	29.40
FS41 Strike Pkg	US26D	FSPART.1039	28.00
FS42 Strike Pkg	US3	FSPART.1040	29.40
FS42 Strike Pkg	US4	FSPART.1041	28.00
FS42 Strike Pkg	US10	FSPART.1042	28.00
FS42 Strike Pkg	US10B	FSPART.1043	35.00
FS42 Strike Pkg	US26	FSPART.1044	29.40
FS42 Strike Pkg	US26D	FSPART.1045	28.00
FS43 Strike Pkg	US3	FSPART.1046	29.40
FS43 Strike Pkg	US4	FSPART.1047	28.00
FS43 Strike Pkg	US10	FSPART.1048	28.00
FS43 Strike Pkg	US10B	FSPART.1049	35.00
FS43 Strike Pkg	US26	FSPART.1050	29.40
FS43 Strike Pkg	US26D	FSPART.1051	28.00
FS40/41/42/43 Strike Mounting Pkg	US3, US4	FSPART.1025	5.50
FS40/41/42/43 Strike Mounting Pkg	US10	FSPART.1026	5.50
FS40/41/42/43 Strike Mounting Pkg	US10B	FSPART.1027	5.50
FS40/41/42/43 Strike Mounting Pkg	US26, US26D	FSPART.1028	5.50
FS40/41/42/43 Body Mounting Pkg	US3, US4	FSPART.1029	5.50
FS40/41/42/43 Body Mounting Pkg	US10	FSPART.1030	5.50
FS40/41/42/43 Body Mounting Pkg	US10B	FSPART.1031	5.50
FS40/41/42/43 Body Mounting Pkg	US26, US26D	FSPART.1032	5.50
FS40/41/42/43 Security Mounting Pkg	-	FSPART.1033	19.70
FS434			
FS434 Rubber	-	09-318	4.00
FS441			
FS441/442/451 Rubber	-	09-315	2.10
FS442			
FS441/442/451 Rubber	-	09-315	2.10

Contact Ives Customer Service for pricing on additional sizes and finishes

Bold pricing indicates item is in stock and available for **Fast Track** and **ProXpress**

IVES ARCHITECTURAL HARDWARE - Parts Price List

Description	Finish	Part No.	List Price Each
FS444/FS446/FS448/FS450			
Rubber Tip, order in quantities of 100	-	09-316	2.10
FS451			
FS441/442/451 Rubber	-	09-315	2.10
FS452			
FS452/455	Rubber (Order in quantities of 100, Price per package of 100)	HRT (FSPART.1075)	117.10
FS455			
FS452/455	Rubber (Order in quantities of 100, Price per package of 100)	HRT (FSPART.1075)	117.10
FS544/FS555			
FS544/555 Rubber - Threaded (Pkg of 6)	-	FSPART.1052	16.70
FS544/555 Mounting Pkg	SP4	FSPART.1054	4.20
FS544/555 Mounting Pkg	SP10	FSPART.1055	4.20
FS544/555 Mounting Pkg	SP313	FSPART.1056	4.20
FS544/555 Mounting Pkg	SP28	FSPART.1057	4.20
FS544/555 Mounting Pkg	SPBLK	FSPART.1058	4.20
FS544/555 Security Mounting Pkg	-	FSPART.1059	11.10
FS544/555 Rubber with Screw	-	FSPART.1074	2.90
FS1153			
FS1153 Rubber Pkg	-	FSPART.1060	2.90
FS1153 Mounting Pkg	US28	FSPART.1061	2.90
FS1153 Security Mounting Pkg	-	FSPART.1062	5.50
FS1154			
FS1154 Rubber Pkg	-	FSPART.1063	2.90
FS1154 Mounting Pkg	US3, US4	FSPART.1064	4.20
FS1154 Mounting Pkg	US10	FSPART.1065	4.20
FS1154 Mounting Pkg	US10B	FSPART.1066	4.20
FS1154 Mounting Pkg	US26, US26D	FSPART.1067	4.20
FS1154 Security Mounting Pkg	-	FSPART.1068	8.40
LG1			
LG1/7 Mounting Pkg	US32D, US2G	LGPART.1001	5.50
LG1/7 Mounting Pkg	USP	LGPART.1002	14.20
LG1/7 Mounting Pkg	US4	LGPART.1003	14.20
LG1/7 Mounting Pkg	US10	LGPART.1004	14.20
LG1/7 Mounting Pkg	SP313	LGPART.1005	14.20
LG7			
LG1/7 Mounting Pkg	US32D	LGPART.1001	5.50
LG10			
LG10/12/14 Mounting Pkg	US32D, USP	LGPART.1007	4.20
LG10/12/14 Security Mounting Pkg	-	LGPART.1008	11.10
LG11			
LG11/13 Mounting Pkg	US32D, SP313	LGPART.1009	4.20
LG11/13 Security Mounting Pkg	-	LGPART.1010	5.50
LG12			
LG10/12/14 Mounting Pkg	US32D, USP	LGPART.1007	4.20
LG10/12/14 Security Mounting Pkg	-	LGPART.1008	11.10
LG13			
LG11/13 Mounting Pkg	US32D, SP313	LGPART.1009	4.20
LG11/13 Security Mounting Pkg	-	LGPART.1010	5.50
LG14			
LG10/12/14 Mounting Pkg	US32D	LGPART.1007	4.20
LG10/12/14 Security Mounting Pkg	-	LGPART.1008	11.10

Contact Ives Customer Service for pricing on additional sizes and finishes

Bold pricing indicates item is in stock and available for **Fast Track** and **ProXpress**

IVES ARCHITECTURAL HARDWARE - Parts Price List

Description	Finish	Part No.	List Price Each
MB1F/MB2F/MB3F/MB1V/MB2V/MB3V			
MB1/2 AL Mounting Pkg	SPBLK	MBPART.1006	11.10
MB1/2 AL Security Mounting Pkg	-	MBPART.1007	11.10
MB1F/MB2F/MB3F/MB1V/MB2V/MB3V (Continued)			
MB1F/2F/3F/1V/2V/3V STL Mounting Pkg	SP28, USP	MBPART.1011	11.10
MB1F/2F/3F/1V/2V/3V STL Mounting Pkg	SPBLK	MBPART.1013	11.10
MB1F/2F/3F/1V/2V/3V STL Security Mtg Pkg	-	MBPART.1014	11.10
RB470/RB471/RB472			
RB470/471/472 Roller, Bushing & Rivet Pkg	US15, US26D	09-137-626	5.50
RL30			
RL30 Standard Strike Mtg Pkg	US3, US4	RLPART.1001	5.50
RL30 Standard Strike Mtg Pkg	US10	RLPART.1002	5.50
RL30 Standard Strike Mtg Pkg	US10B	RLPART.1003	5.50
RL30 Standard Strike Mtg Pkg	US26, US26D	RLPART.1004	5.50
RL30 ASA Strike Mtg Pkg	US3, US4	RLPART.1005	8.40
RL30 ASA Strike Mtg Pkg	US10	RLPART.1006	8.40
RL30 ASA Strike Mtg Pkg	US10B	RLPART.1007	8.40
RL30 ASA Strike Mtg Pkg	US26, US26D	RLPART.1008	8.40
RL30 Standard Strike Security Mtg Pkg	-	RLPART.1009	11.10
RL30 ASA Strike Security Mtg Pkg	-	RLPART.1010	11.10
RL30 Strike Pkg	US3	RLPART.1011	16.70
RL30 Strike Pkg	US4	RLPART.1012	16.70
RL30 Strike Pkg	US10	RLPART.1013	16.70
RL30 Strike Pkg	US10B	RLPART.1014	16.70
RL30 Strike Pkg	US26	RLPART.1015	16.70
RL30 Strike Pkg	US26D	RLPART.1016	16.70
RL30/32/36 ASA Strike Pkg	US3	RLPART.1017	16.70
RL30/32/36 ASA Strike Pkg	US4	RLPART.1018	16.70
RL30/32/36 ASA Strike Pkg	US10	RLPART.1019	16.70
RL30/32/36 ASA Strike Pkg	US10B	RLPART.1020	16.70
RL30/32/36 ASA Strike Pkg	US26	RLPART.1021	16.70
RL30/32/36 ASA Strike Pkg	US26D	RLPART.1022	16.70
RL30/1152 Rubber Roller, Silencers & Pin Pkg	-	RLPART.1023	11.10
RL30/1152 Nylon Coated Brass Roller & Pin Pkg	-	RLPART.1024	11.10
RL30/1152 Nylon Roller & Pin Pkg	-	RLPART.1025	9.80
RL30/1152 Roller Pin	-	RLPART.1026	2.90
RL30/1152 Nylon Silencers (Pkg of 2)	-	RLPART.1027	1.20
RL32			
RL32/36 Standard Strike Mtg Pkg	US3, US4	RLPART.1028	5.50
RL32/36 Standard Strike Mtg Pkg	US10	RLPART.1029	5.50
RL32/36 Standard Strike Mtg Pkg	US10B	RLPART.1030	5.50
RL32/36 Standard Strike Mtg Pkg	US32, US32D	RLPART.1031	5.50
RL32/36 ASA Strike Mtg Pkg	US3, US4	RLPART.1032	8.40
RL32/36 ASA Strike Mtg Pkg	US10	RLPART.1033	8.40
RL32/36 ASA Strike Mtg Pkg	US10B	RLPART.1034	8.40
RL32/36 ASA Strike Mtg Pkg	US32, US32D	RLPART.1035	8.40
RL32/36 Standard Strike Security Mtg Pkg	-	RLPART.1036	11.10
RL32/36 ASA Strike Security Mtg Pkg	-	RLPART.1037	11.10
RL32/36 Strike Pkg	US3	RLPART.1038	16.70
RL32/36 Strike Pkg	US4	RLPART.1039	16.70
RL32/36 Strike Pkg	US10	RLPART.1040	16.70
RL32/36 Strike Pkg	US10B	RLPART.1041	16.70
RL32/36 Strike Pkg	US32	RLPART.1042	16.70
RL32/36 Strike Pkg	US32D	RLPART.1043	16.70

Contact Ives Customer Service for pricing on additional sizes and finishes

Bold pricing indicates item is in stock and available for **Fast Track** and **ProXpress**

IVES ARCHITECTURAL HARDWARE - Parts Price List

Description	Finish	Part No.	List Price Each
RL32 (Continued)			
RL30/32/36 ASA Strike Pkg	US3	RLPART.1017	16.70
RL30/32/36 ASA Strike Pkg	US4	RLPART.1018	16.70
RL30/32/36 ASA Strike Pkg	US10	RLPART.1019	16.70
RL30/32/36 ASA Strike Pkg	US10B	RLPART.1020	16.70
RL30/32/36 ASA Strike Pkg	US26	RLPART.1021	16.70
RL30/32/36 ASA Strike Pkg	US26D	RLPART.1022	16.70
RL32 Nylon Roller & Pin Pkg	-	RLPART.1045	9.80
RL32 Roller Pin	-	RLPART.1046	2.90
RL36			
RL32/36 Standard Strike Mtg Pkg	US32D	RLPART.1031	5.50
RL32/36 ASA Strike Mtg Pkg	US32D	RLPART.1035	8.40
RL32/36 Standard Strike Security Mtg Pkg	-	RLPART.1036	11.10
RL32/36 ASA Strike Security Mtg Pkg	-	RLPART.1037	11.10
RL32/36 Strike Pkg	US32D	RLPART.1043	16.70
RL30/32/36 ASA Strike Pkg	US26D	RLPART.1022	16.70
RL38			
RL38 Mounting Pkg	US32D	RLPART.1051	5.50
RL38 Security Mtg Pkg	-	RLPART.1053	11.10
RL1152			
RL1152 Mounting Pkg	US3, US4	RLPART.1054	5.50
RL1152 Mounting Pkg	US10	RLPART.1055	5.50
RL1152 Mounting Pkg	US10B	RLPART.1056	5.50
RL1152 Mounting Pkg	US26, US26D	RLPART.1057	5.50
RL1152 Security Mounting Pkg	-	RLPART.1058	11.10
RL1152 Strike Pkg	US3	RLPART.1059	16.70
RL1152 Strike Pkg	US4	RLPART.1060	16.70
RL1152 Strike Pkg	US10	RLPART.1061	16.70
RL1152 Strike Pkg	US10B	RLPART.1062	16.70
RL1152 Strike Pkg	US26	RLPART.1063	16.70
RL1152 Strike Pkg	US26D	RLPART.1064	16.70
RL30/1152 Rubber Roller, Silencers & Pin Pkg	-	RLPART.1023	11.10
RL30/1152 Brass Roller & Pin Pkg	-	RLPART.1024	11.10
RL30/1152 Nylon Roller & Pin Pkg	-	RLPART.1025	9.80
RL30/1152 Roller Pin	-	RLPART.1026	2.90
RL30/1152 Nylon Silencers (Pkg of 2)	-	RLPART.1027	1.20
SB360			
SB360 Mortise Strike Pkg	US2C	09-82-604	23.30
SB360 Sex Bolt Package (Set of 4)	US2C	09-350-604	19.10
SB453			
Thru Bolt with Cap Nut Pkg (Set of 4)	US26D, US2C	09-340-626	8.10
Sex Bolt Pkg	US26D, US2C	09-351-604	14.90
SB1630/SB1640/SB1600M1/SB1600M2			
SB1600 Top Strike Pkg	US2G	SBPART.1001	15.40
SB1600 Top Strike Pkg	US3	SBPART.1002	26.50
SB1600 Top Strike Pkg	US10B, SP313	SBPART.1003	26.50
SB1600 Top Strike Pkg	US26D, SP28	SBPART.1004	18.10
SB1600 Top Strike Pkg	SP4	SBPART.1015	26.50
SB1600 Top Strike Pkg	SP10	SBPART.1016	26.50
SB1600 Top Strike Pkg	SPBLK	SBPART.1019	26.50
SB1600 Bottom Strike Pkg	US2G	SBPART.1005	11.10
SB1600 Bottom Strike Pkg	US3	SBPART.1006	22.50
SB1600 Bottom Strike Pkg	US10B, SP313	SBPART.1007	22.50
SB1600 Bottom Strike Pkg	US26D, SP28	SBPART.1008	14.20

Contact Ives Customer Service for pricing on additional sizes and finishes

Bold pricing indicates item is in stock and available for **Fast Track** and **ProXpress**

IVES ARCHITECTURAL HARDWARE - Parts Price List

Description	Finish	Part No.	List Price Each
SB1630/SB1640/SB1600M1/SB1600M2 (Continued)			
SB1600 Bottom Strike Pkg	SP4	SBPART.1020	22.50
SB1600 Bottom Strike Pkg	SP10	SBPART.1021	22.50
SB1600 Bottom Strike Pkg	SPBLK	SBPART.1024	22.50
SB1600 Bolt Mounting Pkg	-	SBPART.1009	5.50
SB1600 End Plug & Stud Pkg	-	SBPART.1010	8.40
SB1600 Security Mounting Pkg	-	SBPART.1011	11.10
SB1600 Lock Housing Pkg	US2G	SBPART.1033	20.90
SB1600 Lock Housing Pkg	US3	SBPART.1034	35.00
SB1600 Lock Housing Pkg	US10B	SBPART.1035	35.00
SB1600 Lock Housing Pkg	US26D	SBPART.1036	28.00
SB1600 Lock Housing Pkg	SP4	SBPART.1017	35.00
SB1600 Lock Housing Pkg	SP10	SBPART.1018	35.00
SB1600 Lock Housing Pkg	SP313	SBPART.1023	35.00
SB1600 Lock Housing Pkg	SP28	SBPART.1025	35.00
SB1600 Lock Housing Pkg	SPBLK	SBPART.1022	35.00
SB1600 Lock Cylinder - 1289	-	SBPART.1037	16.70
SB1600 Lock Cylinder - 1360	-	SBPART.1038	16.70
SB1600 Lock Cylinder - 1390	-	SBPART.1039	16.70
SB1600 Lock Cylinder - 1395	-	SBPART.1040	16.70
SB1600 Sex Bolt Pkg (Set of 3)	US26D, US2G, SP28	SBPART.1012	25.90
SB1600 Sex Bolt Pkg (Set of 3)	US3	SBPART.1013	25.90
SB1600 Sex Bolt Pkg (Set of 3)	US10B, SP313	SBPART.1014	25.90
SB1600 Sex Bolt Pkg (Set of 3)	SP4	SBPART.1028	25.90
SB1600 Sex Bolt Pkg (Set of 3)	SP10	SBPART.1029	25.90
SB1600 Sex Bolt Pkg (Set of 3)	SPBLK	SBPART.1032	25.90
SR64			
SR64 Installation Pin	-	SRPART.1001	1.20
SR64 Installation Pin (Pkg of 10)	-	SRPART.1002	14.20
VR900/VR904/VR900-LLP/VR904-LLP			
VR900 Mounting Pkg	US32D	VRPART.1001	8.40
VR900/910/910M Collar Pkg	US32D	VRPART.1002	28.00
VR910DT/VR914DT/VR810DT/VR814DT			
VR910/910M Mounting Pkg	US32D	VRPART.1003	8.40
VR910DT/VR914DT/VR810NL/VR814NL			
VR910/910M Mounting Pkg	US32D	VRPART.1003	8.40
VR910/910 Cylinder Mounting Pkg	US32D	VRPART.1004	18.10
VR900/910/910M Collar Pkg	US32D	VRPART.1002	28.00
VR910M-DT/ VR914-DT			
VR910/910M Mounting Pkg	US32D	VRPART.1003	8.40
VR910M-NL / VR914M-NL			
VR910/910M Mounting Pkg	US32D	VRPART.1003	8.40
VR900/910/910M Collar Pkg	US32D	VRPART.1002	28.00
WS11			
WS11/11X/20/33 Rubber (Pkg of 6)	-	WSPART.1001	16.70
WS11/33 Mounting Pkg	US3, US4	WSPART.1002	4.20
WS11/33 Mounting Pkg	US10	WSPART.1003	4.20
WS11/33 Mounting Pkg	US10B	WSPART.1004	4.20
WS11/33 Mounting Pkg	US26, US26D	WSPART.1005	4.20
WS11/33 Security Mounting Pkg	-	WSPART.1006	11.10
WS11X			
WS11/11X/20/33 Rubber (Pkg of 6)	-	WSPART.1001	16.70
WS11X/33X Mounting Pkg	US3, US4	WSPART.1029	7.00
WS11X/33X Mounting Pkg	US10	WSPART.1030	7.00

Contact Ives Customer Service for pricing on additional sizes and finishes

Bold pricing indicates item is in stock and available for **Fast Track** and **ProXpress**

IVES ARCHITECTURAL HARDWARE - Parts Price List

Description	Finish	Part No.	List Price Each
WS11X (Continued)			
WS11X/33X Mounting Pkg	US10B	WSPART.1031	7.00
WS11X/33X Mounting Pkg	US26, US26D	WSPART.1032	7.00
WS11X/33X Security Mounting Pkg	-	WSPART.1033	9.80
WS11/11X/20/33 Rubber (Pkg of 6)	-	WSPART.1001	16.70
WS20			
WS20/20X Strike Pkg	US3	WSPART.1008	14.20
WS20/20X Strike Pkg	US4	WSPART.1009	14.20
WS20/20X Strike Pkg	US10	WSPART.1010	14.20
WS20/20X Strike Pkg	US10B	WSPART.1011	14.20
WS20/20X Strike Pkg	US26	WSPART.1012	14.20
WS20/20X Strike Pkg	US26D	WSPART.1013	14.20
WS20 Mounting Pkg	US3, US4	WSPART.1014	7.00
WS20 Mounting Pkg	US10	WSPART.1015	7.00
WS20 Mounting Pkg	US10B	WSPART.1016	7.00
WS20 Mounting Pkg	US26, US26D	WSPART.1017	7.00
WS20 Security Mounting Pkg	-	WSPART.1018	14.20
WS20X			
WS11/11X/20/33 Rubber (Pkg of 6)	-	WSPART.1001	16.70
WS20/20X Strike Pkg	US3	WSPART.1008	14.20
WS20/20X Strike Pkg	US4	WSPART.1009	14.20
WS20/20X Strike Pkg	US10	WSPART.1010	14.20
WS20/20X Strike Pkg	US10B	WSPART.1011	14.20
WS20/20X Strike Pkg	US26	WSPART.1012	14.20
WS20/20X Strike Pkg	US26D	WSPART.1013	14.20
WS20X Mounting Pkg	US3, US4	WSPART.1019	11.10
WS20X Mounting Pkg	US10	WSPART.1020	11.10
WS20X Mounting Pkg	US10B	WSPART.1021	11.10
WS20X Mounting Pkg	US26, US26D	WSPART.1022	11.10
WS20X Security Mounting Pkg	-	WSPART.1023	16.70
WS33			
WS11/11X/20/33 Rubber (Pkg of 6)	-	WSPART.1001	16.70
WS11/33 Mounting Pkg	US3, US4	WSPART.1002	4.20
WS11/33 Mounting Pkg	US10	WSPART.1003	4.20
WS11/33 Mounting Pkg	US10B	WSPART.1004	4.20
WS11/33 Mounting Pkg	US26, US26D	WSPART.1005	4.20
WS11/33 Security Mounting Pkg	-	WSPART.1006	11.10
WS33X			
WS11/11X/20/33 Rubber (Pkg of 6)	-	WSPART.1001	16.70
WS11X/33X Mounting Pkg	US3, US4	WSPART.1029	7.00
WS11X/33X Mounting Pkg	US10	WSPART.1030	7.00
WS11X/33X Mounting Pkg	US10B	WSPART.1031	7.00
WS11X/33X Mounting Pkg	US26, US26D	WSPART.1032	7.00
WS11X/33X Security Mounting Pkg	-	WSPART.1033	9.80
WS40			
WS40 Hook Pkg	US3	WSPART.1034	15.40
WS40 Hook Pkg	US4	WSPART.1035	14.20
WS40 Hook Pkg	US10	WSPART.1036	14.20
WS40 Hook Pkg	US10B	WSPART.1037	14.20
WS40 Hook Pkg	US26	WSPART.1038	15.40
WS40 Hook Pkg	US26D	WSPART.1039	14.20
WS40 Hook Pkg	US28	WSPART.1040	12.50
WS40 Mounting Pkg	US3, US4	WSPART.1041	8.40

Contact Ives Customer Service for pricing on additional sizes and finishes

Bold pricing indicates item is in stock and available for **Fast Track** and **ProXpress**

IVES ARCHITECTURAL HARDWARE - Parts Price List

Parts

Description	Finish	Part No.	List Price Each
WS40 (Continued)			
WS40 Mounting Pkg	US10	WSPART.1042	8.40
WS40 Mounting Pkg	US10B	WSPART.1043	8.40
WS40 Mounting Pkg	US26, US26D, US28	WSPART.1044	8.40
WS40 Security Mounting Pkg	-	WSPART.1045	16.70
WS45			
WS45 Hook Pkg	US3	WSPART.1046	74.00
WS45 Hook Pkg	US4	WSPART.1047	69.90
WS45 Hook Pkg	US10	WSPART.1048	69.90
WS45 Hook Pkg	US10B	WSPART.1049	69.90
WS45 Hook Pkg	US26	WSPART.1050	74.00
WS45 Hook Pkg	US26D	WSPART.1051	72.60
WS45 Mounting Pkg	US3, US4	WSPART.1052	8.40
WS45 Mounting Pkg	US10	WSPART.1053	8.40
WS45 Mounting Pkg	US10B	WSPART.1054	8.40
WS45 Mounting Pkg	US26, US26D	WSPART.1055	8.40
WS45 Security Mounting Pkg	-	WSPART.1056	20.90
WS45X			
WS45X Hook Pkg	US3	WSPART.1057	78.20
WS45X Hook Pkg	US4	WSPART.1058	72.60
WS45X Hook Pkg	US10	WSPART.1059	72.60
WS45X Hook Pkg	US10B	WSPART.1060	72.60
WS45X Hook Pkg	US26	WSPART.1061	78.20
WS45X Hook Pkg	US26D	WSPART.1062	78.20
WS45X Mounting Pkg	US3, US4	WSPART.1063	14.20
WS45X Mounting Pkg	US10	WSPART.1064	14.20
WS45X Mounting Pkg	US10B	WSPART.1065	14.20
WS45X Mounting Pkg	US26, US26D	WSPART.1066	14.20
WS45X Security Mounting Pkg	-	WSPART.1067	20.90
WS65			
60-65/70/430	RT Rubber, order in quantities of 100 (Price per package of 100)	RT (WSPART.1075)	79.50
60-65/70/430	Black Rubber Tip, order in quantities of 100 (Price per package of 100)	WSPART.1089	79.50
WS436/WS438			
FS13/17 Security Mounting Pkg	-	FSPART.1018	2.90
WS443			
Rubber Tip, order in quantities of 100	-	09-316	2.10
WS445			
Rubber Tip, order in quantities of 100	-	09-316	2.10
WS447			
Rubber Tip, order in quantities of 100	-	09-316	2.10
WS449			
Rubber Tip, order in quantities of 100	-	09-316	2.10
S48			
S48/262/265/266 Strike Pkg	B3	09-40-605	5.00
S48/262/265/266 Strike Pkg	B10B	09-40-613	5.00
S48/262/265/266 Strike Pkg	B26D	09-40-626	5.00
54			
054/253 Mortise Strike Pkg	B3	09-22-605	8.20
054/253 Mortise Strike Pkg	B10B	09-22-613	8.20
054/253 Mortise Strike Pkg	B26D	09-22-626	8.20
060/061			
060/061	SRT Rubber, order in quantities of 100 (Price per package of 100)	SRT (WSPART.1076)	37.10

Contact Ives Customer Service for pricing on additional sizes and finishes

Bold pricing indicates item is in stock and available for **Fast Track** and **ProXpress**

IVES ARCHITECTURAL HARDWARE - Parts Price List

Description	Finish	Part No.	List Price Each
60			
60-65/70/430	RT Rubber, order in quantities of 100 (Price per package of 100)	RT (WSPART.1075)	79.50
60-65/70/430	Black Rubber Tip, order in quantities of 100 (Price per package of 100)	WSPART.1089	79.50
61			
60-65/70/430	RT Rubber, order in quantities of 100 (Price per package of 100)	RT (WSPART.1075)	79.50
60-65/70/430	Black Rubber Tip, order in quantities of 100 (Price per package of 100)	WSPART.1089	79.50
62			
60-65/70/430	RT Rubber, order in quantities of 100 (Price per package of 100)	RT (WSPART.1075)	79.50
60-65/70/430	Black Rubber Tip, order in quantities of 100 (Price per package of 100)	WSPART.1089	79.50
64			
60-65/70/430	RT Rubber, order in quantities of 100 (Price per package of 100)	RT (WSPART.1075)	79.50
60-65/70/430	Black Rubber Tip, order in quantities of 100 (Price per package of 100)	WSPART.1089	79.50
69			
69 Rubber Tip	(Price per package of 100)	09-310	74.20
70			
60-65/70/430	RT Rubber, order in quantities of 100 (Price per package of 100)	RT (WSPART.1075)	79.50
60-65/70/430	Black Rubber Tip, order in quantities of 100 (Price per package of 100)	WSPART.1089	79.50
72/73			
60-65/70/430	RT Rubber, order in quantities of 100 (Price per package of 100)	RT (WSPART.1075)	79.50
60-65/70/430	Black Rubber Tip, order in quantities of 100 (Price per package of 100)	WSPART.1089	79.50
253			
Angle Strike Pkg	B3	09-33-605	18.20
Angle Strike Pkg	B10B	09-33-613	18.20
Angle Strike Pkg	B26D	09-33-626	18.20
Mortise Strike Pkg	B3	09-22-605	8.20
Mortise Strike Pkg	B10B	09-22-613	8.20
Mortise Strike Pkg	B26D	09-22-626	8.20
262			
S48/262/265 Strike Pkg	B3	09-40-605	5.00
S48/262/265 Strike Pkg	B10B	09-40-613	5.00
S48/262/265 Strike Pkg	B26D	09-40-626	5.00
265			
S48/262/265 Strike Pkg	B3	09-40-605	5.00
S48/262/265 Strike Pkg	B10B	09-40-613	5.00
S48/262/265 Strike Pkg	B26D	09-40-626	5.00
335			
335 Strike & Mounting Pkg	B10B	09-45-613	6.10
335 Strike & Mounting Pkg	B15	09-45-619	6.10
336			
336 Strike & Mounting Pkg	B3	09-47-605	6.70
336 Strike & Mounting Pkg	B10B	09-47-613	6.70
336 Strike & Mounting Pkg	B26D	09-47-626	6.70
347			
347 Strike & Mounting Pkg	B3	09-53-605	6.10
347 Strike & Mounting Pkg	B10B	09-53-613	6.10

Contact Ives Customer Service for pricing on additional sizes and finishes

Bold pricing indicates item is in stock and available for **Fast Track** and **ProXpress**

IVES ARCHITECTURAL HARDWARE - Parts Price List

Description	Finish	Part No.	List Price Each
347 (Continued)			
347 Strike & Mounting Pkg	B15	09-53-619	6.10
347 Strike & Mounting Pkg	B26	09-53-625	6.10
347 Strike & Mounting Pkg	B26D	09-53-626	6.10
349			
349 Strike & Mounting Pkg	B3	09-61-605	6.10
349 Strike & Mounting Pkg	B10B	09-61-613	6.10
349 Strike & Mounting Pkg	B26D	09-61-626	6.10
353/354 Angle Strike Pkg	B26D	09-33-626	18.20
353/354 Mortise Strike Pkg	B3	09-22-605	8.20
353/354 Mortise Strike Pkg	B10B	09-22-613	8.20
353/354 Mortise Strike Pkg	B26D	09-22-626	8.20
430			
60-65/70/430	RT Rubber, order in quantities of 100 (Price per package of 100)	RT (WSPART.1075)	79.50
60-65/70/430	Black Rubber Tip, order in quantities of 100 (Price per package of 100)	WSPART.1089	79.50
482			
482 Plate	B3	09-170-605	6.70
482 Plate	B10B	09-170-613	6.70
482 Plate	B15, B26D	09-170-626	6.70
482 SHIM 1/8 IN	B15, B26D	09-576-626	15.20
482 SHIM 3/8 IN	B15, B26D	09-577-626	24.00
620			
Sex Bolt Package (Set of 4)	B3, B-505	09-355-605	10.40
Sex Bolt Package (Set of 4)	B10B, B-613	09-355-613	12.70
Sex Bolt Package (Set of 4)	B15, B-619, B15A, B-620	09-355-626	12.70
621			
Sex Bolt Package (Set of 4)	B3	09-355-605	10.40
Sex Bolt Package (Set of 4)	B10B	09-355-613	12.70
Sex Bolt Package (Set of 4)	B15, B15A, B26, B26D, PA28	09-355-626	12.70
U696			
696-700 Viewer Cover	606	890312606	1.80
696-700 Viewer Cover	613	890312613	1.80
696-700 Viewer Cover	626	890312626	1.80
696-700 Viewer Extension	626	890314626	2.70
View Trim Washer	B4	09-241-606	0.30
View Trim Washer	B26D	09-241-626	0.30
U69B			
698 Viewer Cover	605	890311605	2.30
698 Viewer Cover	626	890311626	2.30
698 Viewer Cover	716	890311716	2.30
698 Viewer Extension	626	890313626	3.70
700			
696-700 Viewer Cover	606	890312606	1.80
696-700 Viewer Cover	613	890312613	1.80
696-700 Viewer Cover	626	890312626	1.80
696-700 Viewer Extension	626	890314626	2.70
View Trim Washer	B4	09-241-606	0.30
View Trim Washer	B10B	09-241-613	0.30
View Trim Washer	B26D	09-241-626	0.30
701			
View Trim Washer	B4	09-241-606	0.30
View Trim Washer	B10B	09-241-613	0.30
View Trim Washer	B26D	09-241-626	0.30

Contact Ives Customer Service for pricing on additional sizes and finishes

Bold pricing indicates item is in stock and available for **Fast Track** and **ProXpress**

IVES ARCHITECTURAL HARDWARE - Parts Price List

Description	Finish	Part No.	List Price Each
8112			
Screw - #8 x 1" OPHSMS (Qty 6)	B26D	PULLPART.1060	3.00
8121 (1 3/4" Door)			
Screw - #8 x 1" OPHSMS (Qty 6)	B26D	PULLPART.1060	3.00
8121 Screw Pkg - K Mount	B26D	09-512-618	25.40
8200/8300/8302/8303/8305/8311/8400 Plate Mounting Screws			
Gasket	-	KPPART.10013	20.00
Screw - #6 x 5/8" UOPHSMS (Pkg 16)	B3, B4	09-282-632	0.50
Screw - #6 x 5/8" UOPHSMS (Pkg 16)	B10	09-282-639	0.50
Screw - #6 x 5/8" UOPHSMS (Pkg 16)	B10B, B-613, BRN	09-282-640	0.50
Screw - #6 x 5/8" UOPHSMS (Pkg 16)	B15, B26, B26D, S32, S32D, PA28, CLR	09-282-630	0.50
Screw - #6 x 5/8" TEK/TORX (Pkg 16)	B3, B4	KPART.10014	11.00
Screw - #6 x 5/8" TEK/TORX (Pkg 16)	B10	KPART.10015	11.00
Screw - #6 x 5/8" TEK/TORX (Pkg 16)	B10B, B-613, BRN	KPART.10016	11.00
Screw - #6 x 5/8" TEK/TORX (Pkg 16)	B15, B26, B26D, S32, S32D, PA	KPART.10017	11.00
Pull Mounting Packages for 8105, 8111, 8305, 8311, 8700, 8800			
Also used with Old Mtg Style Pulls (Non-HD) 8102, 8103, 8103EZ, 8190, 8302, 8303, 9100			
See Page 65 for which options can be used with each model.			
Standard Mount 1.3/4" Door	B3, B4	09-469-605	5.40
Standard Mount 1.3/4" Door	B10	09-469-612	5.40
Standard Mount 1.3/4" Door	B10B	09-469-613	5.40
Standard Mount 1.3/4" Door	B15, B26, B26D, PA28, S32, S32D	09-469-603	5.40
Standard Mount 2" Door	B3, B4	PULLPART.1001	5.40
Standard Mount 2" Door	B10	PULLPART.1002	5.40
Standard Mount 2" Door	B10B	PULLPART.1003	5.40
Standard Mount 2" Door	B15, B26, B26D, PA28, S32, S32D	PULLPART.1004	5.40
F Mount 1.3/4" Door	-	09-464-603	3.00
F Mount 2" Door	-	PULLPART.1005	3.00
F Mount 2 1/4" Door	-	PULLPART.1006	3.00
G Mount	-	09-509-603	3.00
H / I / L Mount (combined pack)	-	09-510-603	32.60
J / N Mount (combined pack) 1.3/4" Door	-	09-508-603	11.40
J / N Mount (combined pack) 2" - 2 1/4" Door	-	09-294-603	11.40
M Mount 1 3/4" - 2" Door	B3	09-521-605	21.70
M Mount 1 3/4" - 2" Door	B4	09-521-606	21.70
M Mount 1 3/4" - 2" Door	B10	09-521-612	21.70
M Mount 1 3/4" - 2" Door	B10B	09-521-613	21.70
M Mount 1 3/4" - 2" Door	B26	09-521-625	21.70
M Mount 1 3/4" - 2" Door	B26D	09-521-626	21.70
M Mount 1 3/4" - 2" Door	S32	09-521-629	21.70
M Mount 1 3/4" - 2" Door	S32D	09-521-630	21.70
M Mount 1 3/4" - 2" Door	B15	09-521-619	21.70
M Mount 2 1/4" Door	S32D	PULLPART.1007	44.20
M Mount 2 1/4" Door	B3	PULLPART.1008	44.20
M Mount 2 1/4" Door	B4	PULLPART.1009	44.20
M Mount 2 1/4" Door	B10	PULLPART.1010	44.20
M Mount 2 1/4" Door	B10B	PULLPART.1011	44.20
M Mount 2 1/4" Door	B26	PULLPART.1012	44.20
M Mount 2 1/4" Door	S32	PULLPART.1013	44.20
M Mount 2 1/4" Door	B26d	PULLPART.1014	44.20
M Mount 2 1/4" Door	B15	PULLPART.1015	44.20
O Mount 1.3/4" Door	B3	09-523-605	18.10
O Mount 1.3/4" Door	B4	09-523-606	18.10
O Mount 1.3/4" Door	B10	09-523-612	18.10
O Mount 1.3/4" Door	B10B	09-523-613	18.10

Contact Ives Customer Service for pricing on additional sizes and finishes

Bold pricing indicates item is in stock and available for **Fast Track** and **ProXpress**

IVES ARCHITECTURAL HARDWARE - Parts Price List

Description	Finish	Part No.	List Price Each
Pull Mounting Packages for 8105, 8111, 8305, 8311, 8700, 8800 Also used with Old Mtg Style Pulls (Non-HD) 8102, 8103, 8103EZ, 8190, 8302, 8303, 9100 (Continued) See Page 65 for which options can be used with each model.			
O Mount 1.3/4" Door	B26	09-523-625	18.10
O Mount 1.3/4" Door	B26D	09-523-626	18.10
O Mount 1.3/4" Door	S32	09-523-629	18.10
O Mount 1.3/4" Door	S32D	09-523-630	18.10
O Mount 1.3/4" Door	B15	09-523-619	18.10
O Mount 2" Door	S32D	PULLPART.1016	37.10
O Mount 2" Door	B3	PULLPART.1017	37.10
O Mount 2" Door	B4	PULLPART.1018	37.10
O Mount 2" Door	B10	PULLPART.1019	37.10
O Mount 2" Door	B10B	PULLPART.1020	37.10
O Mount 2" Door	B26	PULLPART.1021	37.10
O Mount 2" Door	S32	PULLPART.1022	37.10
O Mount 2" Door	B26D	PULLPART.1023	37.10
O Mount 2" Door	B15	PULLPART.1024	37.10
O Mount 2 1/4" Door	S32D	PULLPART.1025	37.10
O Mount 2 1/4" Door	B3	PULLPART.1026	37.10
O Mount 2 1/4" Door	B4	PULLPART.1027	37.10
O Mount 2 1/4" Door	B10	PULLPART.1028	37.10
O Mount 2 1/4" Door	B10B	PULLPART.1029	37.10
O Mount 2 1/4" Door	B26	PULLPART.1030	37.10
O Mount 2 1/4" Door	S32	PULLPART.1031	37.10
O Mount 2 1/4" Door	B26D	PULLPART.1032	37.10
O Mount 2 1/4" Door	B15	PULLPART.1033	37.10
* Type M and O mounting packs are sold in multiples of 1.			
Pull HD Mounting Packages for 8102HD, 8302, 8372, 8373, 8975 See Page 65 for which options can be used with each model.			
5/16HD Standard Mount 1.1/2"-1.7/8" Door	B15,B26,26D	PULLPART.1063	5.40
5/16HD Standard Mount 1.1/2"-1.7/8" Door	B3	PULLPART.1064	5.40
5/16HD Standard Mount 1.1/2"-1.7/8" Door	B10	PULLPART.1065	5.40
5/16HD Standard Mount 1.1/2"-1.7/8" Door	B10B	PULLPART.1066	5.40
5/16HD Standard Mount 2-2.1/4" Door	B15,B26,B26D	PULLPART.1071	5.40
5/16HD Standard Mount 2-2.1/4" Door	B3	PULLPART.1072	5.40
5/16HD Standard Mount 2-2.1/4" Door	B10	PULLPART.1073	5.40
5/16HD Standard Mount 2-2.1/4" Door	B10B	PULLPART.1074	5.40
5/16HD G Mount	-	PULLPART.1079	3.00
5/16HD I Mount	-	PULLPART.1081	32.60
5/16HD J Mount 1.1/2"-1.7/8" Door	-	PULLPART.1085	11.40
5/16HD J Mount 2-2.1/4" Door	-	PULLPART.1086	11.40
5/16HD L Mount	-	PULLPART.1083	32.60
Pull HD Mounting Packages for 8103HD, 8103EZHD, 8145EZHD, 8190HD, 8190EZHD, 8303, 9100HD, 9264, 9266, 8169, 8181, 8281, 8189, 8312, 8320, 8371, 8848 See Page 65 for which options can be used with each model.			
3/8HD Standard Mount 1.1/2"-1.7/8" Door	B15,B26,26D	PULLPART.1067	5.40
3/8HD Standard Mount 1.1/2"-1.7/8" Door	B3	PULLPART.1068	5.40
3/8HD Standard Mount 1.1/2"-1.7/8" Door	B10	PULLPART.1069	5.40
3/8HD Standard Mount 1.1/2"-1.7/8" Door	B10B	PULLPART.1070	5.40
3/8HD Standard Mount 2-2.1/4" Door	B15,B26,B26D	PULLPART.1075	5.40
3/8HD Standard Mount 2-2.1/4" Door	B3,B4	PULLPART.1076	5.40
3/8HD Standard Mount 2-2.1/4" Door	B10	PULLPART.1077	5.40
3/8HD Standard Mount 2-2.1/4" Door	B10B	PULLPART.1078	5.40
3/8HD A Mount	-	PULLPART.1200	32.60
3/8HD G Mount	-	PULLPART.1080	3.00
3/8HD I Mount	-	PULLPART.1082	32.60
3/8HD L Mount	-	PULLPART.1084	16.50
3/8HD N Mount 1.1/2"-1.7/8" Door	-	PULLPART.1087	11.40

Contact Ives Customer Service for pricing on additional sizes and finishes

Bold pricing indicates item is in stock and available for **Fast Track** and **ProXpress**

IVES ARCHITECTURAL HARDWARE - Parts Price List

Description	Finish	Part No.	List Price Each
Pull HD Mounting Packages for 8103HD, 8103EZHD, 8145EZHD, 8190HD, 8190EZHD, 8303, 9100HD, 9264, 9266, 8169, 8181, 8281, 8189, 8312, 8320, 8371, 8848 (Continued) See Page 65 for which options can be used with each model.			
3/8HD N Mount 2-2.1/4" Door	-	PULLPART.1088	11.40
3/8HD O Mount 1.1/2"-1.7/8" Door	B3	PULLPART.1089	18.10
3/8HD O Mount 1.1/2"-1.7/8" Door	US4	PULLPART.1090	18.10
3/8HD O Mount 1.1/2"-1.7/8" Door	US10	PULLPART.1091	18.10
3/8HD O Mount 1.1/2"-1.7/8" Door	US10B	PULLPART.1092	18.10
3/8HD O Mount 1.1/2"-1.7/8" Door	US15	PULLPART.1093	18.10
3/8HD O Mount 1.1/2"-1.7/8" Door	US26	PULLPART.1094	18.10
3/8HD O Mount 1.1/2"-1.7/8" Door	US26D	PULLPART.1095	18.10
3/8HD O Mount 1.1/2"-1.7/8" Door	US32	PULLPART.1096	18.10
3/8HD O Mount 1.1/2"-1.7/8" Door	US32D	PULLPART.1097	18.10
3/8HD O Mount 2-2.1/4" Door	US3	PULLPART.1098	37.20
3/8HD O Mount 2-2.1/4" Door	US4	PULLPART.1099	37.20
3/8HD O Mount 2-2.1/4" Door	US10	PULLPART.1100	37.20
3/8HD O Mount 2-2.1/4" Door	US10B	PULLPART.1101	37.20
3/8HD O Mount 2-2.1/4" Door	US15	PULLPART.1102	37.20
3/8HD O Mount 2-2.1/4" Door	US26	PULLPART.1103	37.20
3/8HD O Mount 2-2.1/4" Door	US26D	PULLPART.1104	37.20
3/8HD O Mount 2-2.1/4" Door	US32	PULLPART.1105	37.20
3/8HD O Mount 2-2.1/4" Door	US32D	PULLPART.1106	37.20
3/8HD P Mount	-	PULLPART.1201	40.30
3/8HD Q Mount 3/8"-5/8" Door	B3	PULLPART.1202	48.10
3/8HD Q Mount 3/8"-5/8" Door	US4	PULLPART.1203	48.10
3/8HD Q Mount 3/8"-5/8" Door	US10	PULLPART.1204	48.10
3/8HD Q Mount 3/8"-5/8" Door	US10B	PULLPART.1205	48.10
3/8HD Q Mount 3/8"-5/8" Door	US15	PULLPART.1206	48.10
3/8HD Q Mount 3/8"-5/8" Door	US26	PULLPART.1207	48.10
3/8HD Q Mount 3/8"-5/8" Door	US26D	PULLPART.1208	48.10
3/8HD Q Mount 3/8"-5/8" Door	US32	PULLPART.1209	48.10
3/8HD Q Mount 3/8"-5/8" Door	US32D	PULLPART.1210	48.10
3/8HD X 1.1/2"-1.7/8" Door	B15,B26,26D	PULLPART.1211	37.20
3/8HD X 1.1/2"-1.7/8" Door	B3	PULLPART.1212	37.20
3/8HD X 1.1/2"-1.7/8" Door	B10	PULLPART.1213	37.20
3/8HD X 1.1/2"-1.7/8" Door	B10B	PULLPART.1214	37.20
3/8HD X 2-2.1/4" Door	B15,B26,B26D	PULLPART.1215	37.20
3/8HD X 2-2.1/4" Door	B3,B4	PULLPART.1216	37.20
3/8HD X 2-2.1/4" Door	B10	PULLPART.1217	37.20
3/8HD X 2-2.1/4" Door	B10B	PULLPART.1218	37.20
Old Mtg Style Push/Pull Combos (Non-HD) Mounting Packages for 9103EZ, 9190 See Page 65 for which options can be used with each model.			
NO Mount 1.3/4" Door	B3	09-525-605	45.40
NO Mount 1.3/4" Door	B4	09-525-606	45.40
NO Mount 1.3/4" Door	B10	09-525-612	45.40
NO Mount 1.3/4" Door	B10B	09-525-613	45.40
NO Mount 1.3/4" Door	B26	09-525-625	45.40
NO Mount 1.3/4" Door	B26D	09-525-626	45.40
NO Mount 1.3/4" Door	S32	09-525-629	45.40
NO Mount 1.3/4" Door	S32D	09-525-630	45.40
NO Mount 1.3/4" Door	B15	09-525-619	45.40
NO Mount 2" Door	B3	PULLPART.1042	45.40
NO Mount 2" Door	B4	PULLPART.1043	45.40
NO Mount 2" Door	B10	PULLPART.1044	45.40
NO Mount 2" Door	B10B	PULLPART.1045	45.40

Contact Ives Customer Service for pricing on additional sizes and finishes

Bold pricing indicates item is in stock and available for **Fast Track** and **ProXpress**

IVES ARCHITECTURAL HARDWARE - Parts Price List

Description	Finish	Part No.	List Price Each
Old Mtg Style Push/Pull Combos (Non-HD) Mounting Packages for 9103EZ, 9190 (Continued)			
See Page 65 for which options can be used with each model.			
NO Mount 2" Door	B26	PULLPART.1046	45.40
NO Mount 2" Door	B26D	PULLPART.1047	45.40
NO Mount 2" Door	S32	PULLPART.1048	45.40
NO Mount 2" Door	S32D	PULLPART.1049	45.40
NO Mount 2" Door	B15	PULLPART.1050	45.40
NO Mount 2 1/4" Door	B3	PULLPART.1051	45.40
NO Mount 2 1/4" Door	B4	PULLPART.1052	45.40
NO Mount 2 1/4" Door	B10	PULLPART.1053	45.40
NO Mount 2 1/4" Door	B10B	PULLPART.1054	45.40
NO Mount 2 1/4" Door	B26	PULLPART.1055	45.40
NO Mount 2 1/4" Door	B26D	PULLPART.1056	45.40
NO Mount 2 1/4" Door	S32	PULLPART.1057	45.40
NO Mount 2 1/4" Door	S32D	PULLPART.1058	45.40
NO Mount 2 1/4" Door	B15	PULLPART.1059	45.40
NS Mount 1.3/4" Door	B3,B4	09-524-605	26.20
NS Mount 1.3/4" Door	B15, B26, B26D, PA28, S32, S32D	09-524-630	26.20
NS Mount 1.3/4" Door	B10	09-524-612	26.20
NS Mount 1.3/4" Door	B10B	09-524-613	26.20
NS Mount 2" Door	B3,B4	PULLPART.1034	26.20
NS Mount 2" Door	B15, B26, B26D, PA28, S32, S32D	PULLPART.1035	26.20
NS Mount 2" Door	B10	PULLPART.1036	26.20
NS Mount 2" Door	B10B	PULLPART.1037	26.20
NS Mount 2" Door	B3,B4	PULLPART.1038	26.20
NS Mount 2" Door	B15, B26, B26D, PA28, S32, S32D	PULLPART.1039	26.20
NS Mount 2" Door	B10	PULLPART.1040	26.20
NS Mount 2" Door	B10B	PULLPART.1041	26.20
Push/Pull Combo HD Mounting Packages for 9103EZHD, 9145EZHD, 9190HD, 9190EZHD			
See Page 65 for which options can be used with each model.			
3/8HD NO Mount 1.1/2"-1.7/8" Door	US3	PULLPART.1115	45.40
3/8HD NO Mount 1.1/2"-1.7/8" Door	US4	PULLPART.1116	45.40
3/8HD NO Mount 1.1/2"-1.7/8" Door	US10	PULLPART.1117	45.40
3/8HD NO Mount 1.1/2"-1.7/8" Door	US10B	PULLPART.1118	45.40
3/8HD NO Mount 1.1/2"-1.7/8" Door	US15	PULLPART.1119	45.40
3/8HD NO Mount 1.1/2"-1.7/8" Door	US26	PULLPART.1120	45.40
3/8HD NO Mount 1.1/2"-1.7/8" Door	US26D	PULLPART.1121	45.40
3/8HD NO Mount 1.1/2"-1.7/8" Door	US32	PULLPART.1122	45.40
3/8HD NO Mount 1.1/2"-1.7/8" Door	US32D	PULLPART.1123	45.40
3/8HD NO Mount 2-2.1/4" Door	US3	PULLPART.1124	45.40
3/8HD NO Mount 2-2.1/4" Door	US4	PULLPART.1125	45.40
3/8HD NO Mount 2-2.1/4" Door	US10	PULLPART.1126	45.40
3/8HD NO Mount 2-2.1/4" Door	US10B	PULLPART.1127	45.40
3/8HD NO Mount 2-2.1/4" Door	US15	PULLPART.1128	45.40
3/8HD NO Mount 2-2.1/4" Door	US26	PULLPART.1129	45.40
3/8HD NO Mount 2-2.1/4" Door	US26D	PULLPART.1130	45.40
3/8HD NO Mount 2-2.1/4" Door	US32	PULLPART.1131	45.40
3/8HD NO Mount 2-2.1/4" Door	US32D	PULLPART.1132	45.40
3/8HD NS Mount 1.1/2"-1.7/8" Door	B15,B26,B26D	PULLPART.1107	26.20
3/8HD NS Mount 1.1/2"-1.7/8" Door	B3,B4	PULLPART.1108	26.20
3/8HD NS Mount 1.1/2"-1.7/8" Door	B10	PULLPART.1109	26.20
3/8HD NS Mount 1.1/2"-1.7/8" Door	B10B	PULLPART.1110	26.20
3/8HD NS Mount 2-2.1/4" Door	B15,B26,B26D	PULLPART.1111	26.20
3/8HD NS Mount 2-2.1/4" Door	B3,B4	PULLPART.1112	26.20

Contact Ives Customer Service for pricing on additional sizes and finishes

Bold pricing indicates item is in stock and available for **Fast Track** and **ProXpress**

Parts

IVES ARCHITECTURAL HARDWARE - Parts Price List

Description	Finish	Part No.	List Price Each
Push/Pull Combo HD Mounting Packages for 9103EZHD, 9145EZHD, 9190HD, 9190EZHD (Continued)			
See Page 65 for which options can be used with each model.			
3/8HD NS Mount 2-2.1/4" Door	B10	PULLPART.1113	26.20
3/8HD NS Mount 2-2.1/4" Door	B10B	PULLPART.1114	26.20
3/8HD PQ Mount 3/8"-5/8" Door	US3	PULLPART.1219	83.70
3/8HD PQ Mount 3/8"-5/8" Door	US4	PULLPART.1220	83.70
3/8HD PQ Mount 3/8"-5/8" Door	US10	PULLPART.1221	83.70
3/8HD PQ Mount 3/8"-5/8" Door	US10B	PULLPART.1222	83.70
3/8HD PQ Mount 3/8"-5/8" Door	US15	PULLPART.1223	83.70
3/8HD PQ Mount 3/8"-5/8" Door	US26	PULLPART.1224	83.70
3/8HD PQ Mount 3/8"-5/8" Door	US26D	PULLPART.1225	83.70
3/8HD PQ Mount 3/8"-5/8" Door	US32	PULLPART.1226	83.70
3/8HD PQ Mount 3/8"-5/8" Door	US32D	PULLPART.1227	83.70

Contact Ives Customer Service for pricing on additional sizes and finishes

Bold pricing indicates item is in stock and available for **Fast Track** and **ProXpress**

WARRANTY

Ives (the “Company”) warrants only to Customer that the products will be free from defects in material and workmanship for a period of 12 months from the date of shipment of products. Continuous hinges carry a Lifetime Warranty with exception of electrified continuous hinged which carry a 12 month Warranty from time of shipment. The Customer shall be obligated to promptly report any failure to conform to this warranty in writing to the Company within the warranty period provided above. Company’s sole obligation under this warranty is limited to repairing or replacing, at its option, the defective products.

NO OTHER WARRANTIES, EXPRESS OR IMPLIED, ARE MADE WITH RESPECT TO THE PRODUCTS INCLUDING, BUT NOT LIMITED TO, ANY IMPLIED WARRANTY OF MERCHANTABILITY OR FITNESS FOR A PARTICULAR PURPOSE.

The provisions of this limited warranty do not apply to products: (i) used for the purposes for which they are not designed or intended; (ii) which have been repaired or altered without Company’s prior written consent; (iii) which have been subjected to misuse, abuse, negligence, or accident; (iv) which have been improperly stored, installed, maintained, or operated; (v) which have been used in violation of written instructions provided by Company to Customer; (vi) which have been subjected to improper temperature, humidity, or other environmental conditions; (vii) which have been affected by normal wear and tear; or (viii) which, based on Company’s examination, do not disclose to Company’s satisfaction nonconformance to the warranty.

The following costs and expenses are not covered by the provisions of this limited warranty: (i) labor costs for the removal and reinstallation of products; (ii) shipping and freight expenses required to return products to Company; (iii) normal maintenance; and (iv) economic losses. In addition, the provisions of this warranty are not applicable to anything other than defects in Company’s material (products only) or workmanship.

CONSUMER PRODUCTS. With respect to “consumer products” as defined under the Magnuson-Moss Warranty Act (“MMWA”), the following statements are made. (a) Some states do not allow limitations on how long an implied warranty lasts, so the above limitation may not apply to you. **IF ANY IMPLIED WARRANTY IS PROVIDED UNDER THE MMWA, IT IS LIMITED TO THE DURATION OF THE WARRANTY PROVIDED ABOVE.** (b) Some states do not allow the exclusion or limitation of incidental or consequential damages, so the above limitation or exclusion may not apply to you. (c) This warranty gives you specific legal rights and you may also have other rights which vary from state to state.

About Allegion

Allegion (NYSE: ALLE) creates peace of mind by pioneering safety and security. As a \$2 billion provider of security solutions for homes and businesses, Allegion employs more than 8,000 people and sells products in more than 120 countries across the world. Allegion comprises more than 25 global brands, including strategic brands CISA®, Interflex®, LCN®, Schlage® and Von Duprin®.

For more, visit www.allegion.com

aptiQ ■ LCN ■ **SCHLAGE** ■ STEELCRAFT ■ VON DUPRIN