

# Architectural Door Accessories

**ASSA ABLOY**

The global leader in  
door opening solutions

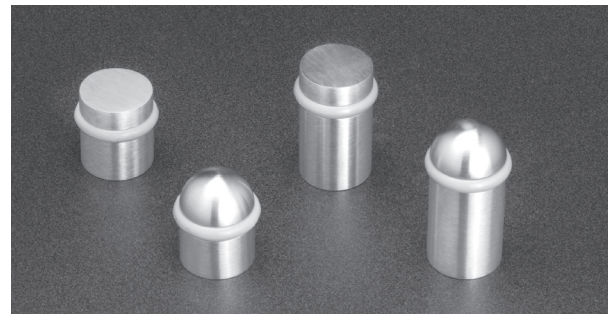
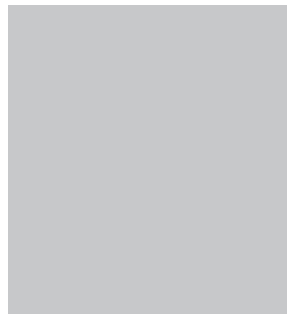

## Rockwood Products Price Book - Architectural Series

Prices Effective September 1, 2017

## Table of Contents

<b>General Information</b>	<b>2-5</b>	OvalTek (flat oval grip)	14
Numeric Index	3	PlanTek (flat front pulls)	32
Ordering Information	4	RightAngles (w/ or w/o GripZone)	7
Post Mounted Pulls/General Information	5	SculpTrex (shaped cast pulls)	31
<b>Architectural Pulls</b>	<b>6-44</b>	SkewTek (angled end pulls)	29
AccenTek (solid pulls with accents)	31	SoftMet (*Santoprene™ grip)	14
ArborMet (wood grip pulls)	27	SoftTek (Santoprene™ grip)	15
ArborTek (wood grip pulls)	28	Traditional (decorative pulls & plates)	33
BandWidth (collar mount pulls)	13	Tubular (1 ¼" and 1 ½" diameter pulls)	6
CenTek (shaped pulls)	29	<b>Leather Architectural Pulls</b>	<b>34-38</b>
CenTrex (shaped pulls)	30	English Bridle Leather (straight & offset pulls)	34-35
Classic (finial pulls)	33	Flush Leather Pulls	38
Edge Pulls (for closet doors)	8	Leather Oval (ergonomic pulls)	38
Flush Pulls	7	Upholstery Leather GeoMetek	39
GeoMetek (narrow profile pulls)	41	Upholstery Leather (straight & offset pulls)	36-37
Groove (straight & offset pulls)	15	<b>Small Architectural Pulls</b>	<b>7-39</b>
LineaMax (long grooved pulls)	23	ArborMet	11
LineaMet (contrasting grooved pulls)	21	GripZone	10
LineaTek (fully grooved pulls)	22	Groove	9-10
Locking Door Pull System	42-44	Leather	39
MariTek (tapered pulls)	33	MegaTek	9
MegaCurve (long curved pulls)	11	NoirMet	11
MegaTek (straight & offset pulls)	17-19	Wire	7
MezzoTek (necked post pulls)	12	<b>Architectural Accessories</b>	<b>8-9</b>
NeoCylinder (w/ or w/o GripZone)	39	Coat Hooks	8
NeoMax (long pulls w/GripZone)	20-21	Door Stops	8
NeoMetrix (w/GripZone)	15	Push Plates, Pull Plates and Signage	9
NeoMitre (w/ or w/o GripZone)	40	<b>Architectural Finishes</b>	<b>45</b>
NeoTek (w/GripZone)	16	<b>Mounting Types</b>	<b>46</b>
NoirMet (black anodized grip)	24-25	<b>Mounting Details</b>	<b>47-48</b>
NoirTek (black anodized grip)	26	<b>Fasteners - Spare Parts</b>	<b>49-51</b>
OvalTek (true oval grip)	14	<b>Mounting Kits</b>	<b>52</b>
		<b>Discontinued Products</b>	<b>53</b>

\*Santoprene™ is a registered trademark of the Exxon Mobil Corporation.

**ASSA ABLOY**

The global leader in  
door opening solutions

Prices Effective September 1, 2017

Copyright © 2017, Rockwood Manufacturing Company, an ASSA ABLOY Group company. All rights reserved.  
Reproduction in whole or in part without the express written permission of Rockwood Manufacturing Company is prohibited.

## Numeric Index

No.	Description	Page	No.	Description	Page
570	Dust Proof Strike.....	44	RM2610 - RM2640	SoftTek .....	15
ADA	ADA Large 1 13/16" Thumbturn.....	44	RM3010 - RM3060	NeoMetrix.....	15
DP3301	MegaTek Dummy Pull (round).....	44	RM3100 - RM3154	See RM3300-RM3342	
DP3401	NeoTek Dummy Pull.....	44	RM3101 - RM3131	Groove.....	15
DP7901	GeoMetek Dummy Pull (square)....	44	RM3200 - RM3254	NeoTek .....	16
LP3301	Locking Pull PostMount .....	42	RM3300 - RM3342	MegaTek.....	17-19
LP3401	Locking Pull NeoTek .....	42	RM3400 - RM3442	NeoMax.....	20-21
LP6061	Locking Pull English Bridle Leather Wrapped .....	43	RM3510 - RM3554	LineaMet.....	21
LP6161	Locking Pull Upholstery Leather Wrapped .....	43	RM3610 - RM3654	LineaTek .....	22
LP6440	Locking Pull Upholstery Leather Wrapped .....	44	RM3701 - RM3782	LineaMax .....	23
LP7901	Locking Pull GeoMetek .....	44	RM3800 - RM3854	NoirMet.....	24-25
LPS01 - LPS06	Locking Pull Strikes .....	44	RM3900 - RM3954	NoirTek.....	26
RM201 - RM372	Tubular .....	6	RM4000 - RM4054	ArborMet.....	27
RM405 - RM423	RightAngles .....	7	RM4100 - RM4190	ArborTek .....	28
RM710 - RM735	Small Pulls (Wire).....	7	RM4200 - RM4274	SkewTek .....	29
RM751 - RM760	Edge Pulls - for Closet Doors.....	8	RM4300 - RM4305	CenTek .....	29
RM780 - RM785	Flush Pulls.....	7	RM4400 - RM4552	CenTrex .....	30
RM801 - RM843	Coat Hooks .....	8	RM4700 - RM4820	AccenTek .....	31
RM850 - RM877	Door Stops.....	8	RM5000 - RM5050	SculpTrex.....	31
RM850, RM851	Door Stops.....	8, 44	RM5200 - RM5280	PlanTek .....	32
RM1010 - RM1160	Push Plates, Pull Plates, and Signage .....	9	RM5500 - RM5598	Traditional .....	33
RM1200 - RM1270	Small Pulls (MegaTek, Groove)....	9-10	RM5650 - RM5670	Classic .....	33
RM1300 - RM1370	Small Pulls (GripZone).....	10	RM5700 - RM5702	MariTek.....	33
RM1410 - RM1470	Small Pulls (NoirMet) .....	11	RM6000 - RM6092	English Bridle Leather .....	34-35
RM1510 - RM1570	Small Pulls (ArborMet).....	11	RM6100 - RM6192	Upholstery Leather.....	36-37
RM2000 - RM2034	MegaCurve .....	11	RM6200 - RM6240	Leather Oval .....	38
RM2110 - RM2150	MezzoTek.....	12	RM6300 - RM6354	Flush Leather Pulls .....	38
RM2200 - RM2244	BandWidth .....	13	RM6400 - RM6440	Upholstery Leather GeoMetek.....	39
RM2300 - RM2330	OvalTek (true oval) .....	14	RM6500 - RM6730	Small Pulls (Leather).....	39
RM2400 - RM2420	OvalTek (flat oval) .....	14	RM7210 - RM7240	NeoCylinder .....	39
RM2510 - RM2544	SoftMet .....	14	RM7300 - RM7450	NeoMitre .....	40
			RM7900 - RM7960	GeoMetek .....	41
			SP1001 - SP1082	Fasteners - Spare Parts .....	49-51
			KIT1 - KITRM380G	Mounting Kits.....	52

## Ordering Information

This price list cancels and supersedes all prior listings.  
Orders are accepted with the understanding that they will be billed at prices in effect at time of shipment.  
Prices are subject to change without notice.  
We reserve the right to decline the whole or part of orders in which the price or quantity of goods is not acceptable to us.

## Easy Order Placement

By Phone: 1-800-458-2424 Monday through Thursday 8:00 am ET to 7:00 pm ET, Friday 8:00 am ET to 4:30 pm ET  
By Fax: Orders may be faxed to 1-800-922-9212  
By Email: [orders.rockwood@assaabloy.com](mailto:orders.rockwood@assaabloy.com)  
By Internet: <http://extranet.assaabloydss.com/> and select Order Entry under the Customer Service Menu

## Terms and Conditions of Sale

Terms: 1% 15 days, net 30 days  
Remit Payment To: PNC Bank/Rockwood, PO Box 644489, Pittsburgh, PA 15264-4489

## Freight Policy

Freight Allowance: All prices are F.O.B. Rockwood, Pennsylvania. Full freight will be allowed on shipments of \$1,000 net and over within the continental limits of the United States (excluding Alaska and Hawaii). All shipments are routed most cost effective route of our choice. We reserve the right to designate the carrier.

## Special Order Material

Special items made to your specifications are not returnable. These items are not subject to cancellation without consideration of expense involved at the cancellation date.

## Samples

Salable samples will be charged at regular prices.

## Returned Goods

Return no merchandise without written permission from the factory. Authorization will insure your receiving proper credit. Errors in shipping may occasionally occur. If this is the case immediately notify the factory, and we will gladly make the proper adjustments. If the error is at the customer's end, a minimum charge of 25% plus freight will be incurred for handling. Unauthorized claims for labor or charges will not be allowed. No credit will be allowed beyond six months after invoice date.

## Shortages

Claims for shortages must be made within 30 days of invoice date.

## Templates

Upon request we will furnish templates for any of our standard items of manufacture. Commonly used templates are available on our website at [www.rockwoodmfg.com](http://www.rockwoodmfg.com).

## Product Weight Information

NOTE: Weights indicated throughout the price list are approximate for brass, bronze or stainless steel base material. Aluminum base materials weigh approximately  $\frac{1}{3}$  the listed weights.

## Engraving

Engraving may be added on many pulls. Call factory for pricing.

# ASSA ABLOY

The global leader in  
door opening solutions

Prices Effective September 1, 2017

Copyright © 2017, Rockwood Manufacturing Company, an ASSA ABLOY Group company. All rights reserved.  
Reproduction in whole or in part without the express written permission of Rockwood Manufacturing Company is prohibited.

## Post Mounted Pulls

It is our goal that you get the best possible functional and aesthetic door pull from our wide selection. On long door pulls there will naturally be a small amount of flexing between mounting points that are far apart. We offer the following guidelines to help you determine when a mid-post is required or when you should consider altering the location of the mounting posts (by moving them closer together) in order to minimize the flexing of the grip. Making the grip rigid by adding a mid-post is the ideal condition for long pulls on all doors but is particularly important on all glass doors that have an inherent flexing in the door itself. The combined flexing of the door and the pull can loosen mechanical joints and stress the fasteners.

Our recommendations for adding a mid-post to long door pulls is based on a theoretical pull load of 30 lbs. (foot pounds) maximum to open the door, which is a greater than the typical force required to open an average door. The maximum amount of deflection of the grip you will see at that force is  $\frac{3}{8}$ ". The conditions on your job site can vary due to door weight, wind loading, closer settings, locked doors being aggressively pulled and other circumstances. It is our recommendation that you add a mid-post if there is any question about heavy or hard to open doors; having an extra mounting point always makes for a more stable and durable installation.

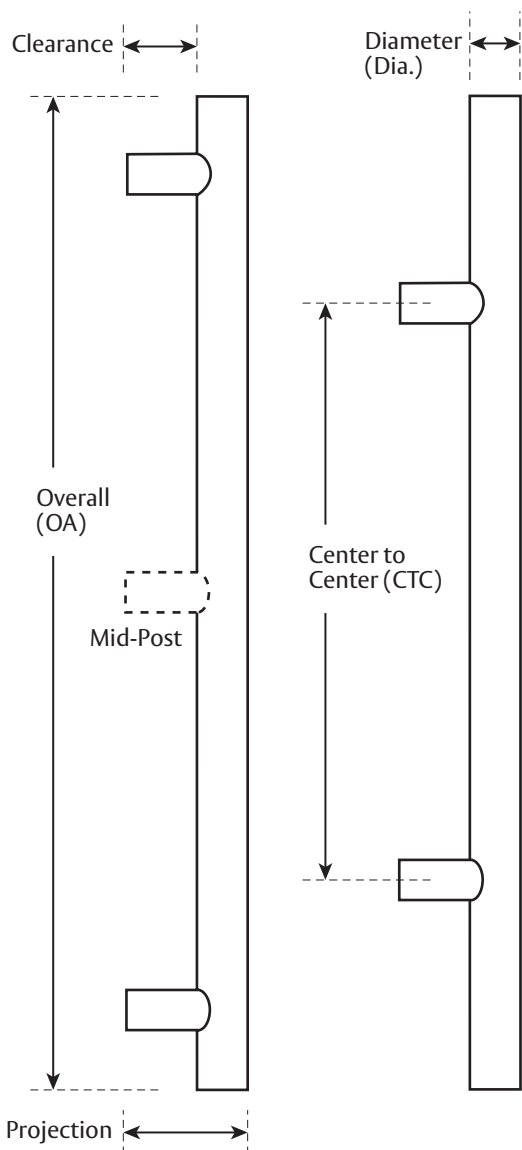

On long pulls, post can be positioned closer to each other and farther away from ends as a strategy to avoid mid-post if door condition permits.

POST MOUNTED PULLS SHAPES AND SIZES			
SHAPE	MATERIAL	MATERIAL Size	MAXIMUM CTC
<b>Round</b>			
	Stainless Steel	1"	70"
		1 1/4"	90"
		1 1/2"	110"
	Brass/Bronze	1"	57"
		1 1/4"	73"
		1 1/2"	87"
Aluminum	1"	66"*	
	1 1/4"	90"*	
	1 1/2"	115"*	
<b>Oval</b>			
	Stainless Steel	1" x 1 1/2"	100"
		1" x 1 7/8"	119"
<b>Flat Oval</b>			
	Stainless Steel	3/4" x 1 1/2"	93"
<b>Square</b>			
	Stainless Steel	3/4" x 3/4"	62"
<b>Rectangular</b>			
	Stainless Steel	1/2" x 1 1/4"	86"
		3/4" x 1 1/2"	110"
	Brass/Bronze	3/4" x 1 1/2"	89"
<b>Rectangular</b>			
	Stainless Steel	1/2" x 1 1/4"	52"
		3/4" x 1 1/2"	75"
	Brass/Bronze	3/4" x 1 1/2"	60"

\*The maximum length of anodized aluminum pulls is 87" due to our tank size. Longer aluminum pulls are available in satin finish and clear coated or powder coat paint.

Tubular - 1 1/4" & 1 1/2" Diameter Pulls

Straight Pulls											
Part	CTC	Dia.	28/628	313/710 315/711	3/605 4/606	10/612 10B/613	Stock PC 10BE	32D/630	32/629	32D316	32316
RM301	12"	1 1/4"	125	138	318	343	178	128	143	166	186
RM302	18"	1 1/4"	140	155	337	364	197	147	165	191	214
RM303	24"	1 1/4"	155	171	356	384	216	166	186	216	242
RM304	36"	1 1/4"	185	204	394	426	284	204	228	265	296
RM321	12"	1 1/2"	140	154	386	417	209	159	178	207	231
RM322	18"	1 1/2"	155	171	405	438	228	178	200	232	259
RM323	24"	1 1/2"	170	187	424	458	247	197	221	256	287
RM324	36"	1 1/2"	200	220	462	499	315	235	263	306	342
90° Offset Pulls											
RM201	12"	1 1/4"	143	162	242	255	205	155	190	193	225
RM202	18"	1 1/4"	156	177	269	282	223	173	208	213	244
RM203	24"	1 1/4"	168	191	296	310	240	190	225	238	270
RM204	36"	1 1/4"	197	219	356	370	293	213	249	263	296
RM221	12"	1 1/2"	184	197	290	310	228	178	225		
RM222	18"	1 1/2"	197	211	322	337	282	202	249		
RM223	24"	1 1/2"	211	225	363	376	304	224	274		
RM224	36"	1 1/2"	239	253	428	443	332	252	303		
Push Bars - Add \$6/in. per bar for extra length bars over 36".											
RM350	Up to 36"	1 1/4"	184	205	269	290	228	178	200	232	238
RM370	Up to 36"	1 1/2"	211	232	322	349	298	218	244		
Straight Push Pull Sets - Specify Push Bar CTC. Add \$6/in. per bar for extra length bars over 36".											
RM351	12"	1 1/4"	291	327	473	510	404	324	364	422	433
RM352	18"	1 1/4"	299	333	500	540	415	335	375	436	445
RM371	12"	1 1/2"	361	396	568	613	461	381	426		
RM372	18"	1 1/2"	382	416	586	633	504	404	452		
Offset Push Pull Sets - Specify Push Bar CTC. Add \$6/in. per bar for extra length bars over 36".											
RM251	12"	1 1/4"	341	382	526	568	428	348	390	452	477
RM252	18"	1 1/4"	354	396	553	597	444	364	407	473	495
RM271	12"	1 1/2"	409	444	627	677	510	410	459		
RM272	18"	1 1/2"	426	459	660	713	533	433	484		
Heavy Duty 30° Offset Pulls											
Part	CTC	Dia.	28/628	313/710 315/711	3/605 4/606	10/612 10B/613	Stock PC 10BE	32D/630	32316	32/629	32D316
RM257	10"	1 1/4"	149	162	326	352	305	225	321	251	291
RM258	12"	1 1/4"	162	177	349	377	325	245	340	275	318
RM259	18"	1 1/4"	168	184	385	416	350	270	368	302	351

NOTE: Engraving "Push" or "Pull" add \$95.00 (1/2" letter height).

NOTE: Post location on push bars can be located 1/8" from end for narrow & medium stile doors and 1" from end for flush and wide stile doors.

**ASSA ABLOY**

The global leader in  
door opening solutions

Prices Effective September 1, 2017

Copyright © 2017, Rockwood Manufacturing Company, an ASSA ABLOY Group company. All rights reserved.  
Reproduction in whole or in part without the express written permission of Rockwood Manufacturing Company is prohibited.

## RightAngles - with or without GripZone

Without GripZone (RM410-RM413 specify handing and height x width when ordering.)									
Part	28/628	313/710 315/711	3/605 4/606	10/612 10B/613	Stock PC 10BE	32D/630	32/629	32D316	32316
RM405-15	185	209	299	323	281	178	201	231	262
RM410 (leg up)	382	439	640	691	523	368	423	478	550
RM411 (leg down)	382	439	640	691	523	368	423	478	550
RM412 (leg up)	648	741	723	781	814	624	714	812	929
RM413 (leg down)	648	741	723	781	814	624	714	812	929
With GripZone (RM420-RM423 specify handing and height x width when ordering.)									
Part	3/605	9/611	32/629	32316					
RM415-15	411	475	342	606					
RM420 (leg up)	809	927	669	1182					
RM421 (leg down)	809	927	669	1182					
RM422 (leg up)	1045	1202	854	1534					
RM423 (leg down)	1045	1202	854	1534					

## Small Pulls - for Cabinets, Casework and Closets

Wire Pulls - without base plates								
Part	CTC	Dia.	3/605 4/606	10B/613	Stock PC 10BE	26/625 26D/626	32D/630	32/629
RM710-4	4"	3/8"	30	32	32	30	20	22
RM710-5	5"	3/8"	31	33	33	31	21	23
RM710-6	6"	3/8"	32	35	35	33	22	25
RM720-4	4"	1/2"	36	39	37	36	22	25
RM720-5	5"	1/2"	37	40	38	37	23	27
RM720-6	6"	1/2"	38	41	40	38	25	29
RM730-5	5"	5/8"	42	45	42	42	27	30
RM730-6	6"	5/8"	43	46	43	43	28	31
RM730-7	7"	5/8"	44	48	44	44	29	32
Wire Pulls - with base plates								
RM715-4	4"	3/8"	46	50	50	46	37	41
RM715-5	5"	3/8"	48	52	52	48	39	43
RM715-6	6"	3/8"	49	53	53	51	40	46
RM725-4	4"	1/2"	55	59	56	55	41	47
RM725-5	5"	1/2"	56	60	57	56	42	48
RM725-6	6"	1/2"	57	62	58	57	43	49
RM735-5	5"	5/8"	60	65	58	60	43	49
RM735-6	6"	5/8"	62	67	60	62	45	50
RM735-7	7"	5/8"	63	68	61	63	46	51

## Flush Pulls

Flush Pulls					
Part	Size	3/605 4/606	10B/613	Stock PC 10BE	26/625 26D/626
RM780	2 3/16" x 3 1/4"	33	36	36	35
RM782	2 11/16" x 4 3/16"	35	38	38	37
RM785	3 1/2" Dia.	44	48	48	46

Prices Effective September 1, 2017

Copyright © 2017, Rockwood Manufacturing Company, an ASSA ABLOY Group company. All rights reserved.  
Reproduction in whole or in part without the express written permission of Rockwood Manufacturing Company is prohibited.

**ASSA ABLOY**

The global leader in  
door opening solutions

Edge Pulls - for Closet Doors

Square Edge Door						
Part	Max OA	3/605 4/606	10/612 10B/613	Stock PC 10BE	32D/630	32/629
RM751	Up to 12"	81	87	81	66	73
RM752	Up to 12"	83	90	83	68	76
Bevel Edge Door						
RM753	Up to 12"	85	92	85	70	78
RM754	Up to 12"	87	94	88	73	82

Double Edge Pull - Square Edge						
Part	Max OA	3/605 4/606	10/612 10B/613	Stock PC 10BE	32D/630	32/629
RM755	Up to 12"	159	172	146	131	147
Concealed Edge Pull						
Part	Max OA	Size	3/605 4/606	10/612 10B/613	Stock PC 10BE	26/625 26D/626
RM760	Up to 12"	1" x 4 1/4"	43	46	46	46

- Specifying Information: 1. Select style pull number; 2. Select standard length [2", 2 1/2", 3", 4", 5", 6", 12" (max)]; 3. Specify door thickness [Example: RM752-4" 32D 1 3/4" door]

Coat Hooks

Part	Size	3/605 4/606	10B/613	Stock PC 10BE	26/625 26D/626	32D/630
RM801	1 1/4" x 1 3/4"	55	59	59	58	46
RM802	1 1/4" x 2 3/4"	56	60	60	59	48
RM803	1" x 2"	55	59	59		58
RM804	1" x 3"	56	60	60		59
RM805	1" x 1 3/4"	69	75	75	75	
RM806	1" x 3"	75	81	81	82	
RM807	1 1/4" x 2 3/4"	84	91	91	91	
RM808	1 1/4" x 3 1/2"	91	98	98	96	
RM811	3/4" x 1 1/2"	37	40	40	37	
RM812	1 1/4" x 2 1/4"	39	42	42	39	
Part	Size					15/619
RM817	Square 1 3/4", 2 11/16" Projection					44

Part	Size	3/605 4/606 10B/613	Stock PC 10BE	26/625 26D/626	32D/630	32/629
RM828	3/4"W x 2 7/8"	65	54		46	63
RM829	3/4"W x 1 7/8"	59	52		42	58

LineaMet Coat Hooks					
Part	Size	Stock PC 10BE	32D/630	32/629	
RM830 (w/base plate)	1 1/4" x 2 1/4"	69	54	57	
RM831	5/8" x 2 1/8"	69	54	57	

ArborMet Coat Hooks					
Part	Size	Stock PC 10BE	32D/630	32/629	
RM835 (w/base plate)	1 1/4" x 2 1/4"	69	54	57	
RM836	5/8" x 2 1/8"	69	54	57	

SoftMet Coat Hooks					
Part	Size	Stock PC 10BE	32D/630	32/629	
RM838 (w/base plate)	1 1/4" x 2 1/4"	69	54	57	
RM839	5/8" x 2 1/8"	69	54	57	

Groove Coat Hooks					
Part	Size	Stock PC 10BE	32D/630	32/629	
RM840 (w/base plate)	1/2" x 1 5/8"	57	42		
RM841 (w/base plate)	5/8" x 2 1/8"	60	45		
RM842	1/2" x 1 1/2"	50	35		
RM843	5/8" x 2"	52	37		

Door Stops

Floor Mounted						
Part	Height	3/605 4/606	10/612 10B/613	Stock PC 10BE	26/625 26D/626	32D/630
RM850	1 1/2"	36	39	39	33	34
RM851	2 1/2"	46	50	50	46	44
RM855	1 3/4"	40	43	43	37	38
RM856	2 3/4"	49	53	53	49	46
Part	Size					15/619
RM857	Square 1" Base, 2 3/4" Projection					58

Wall Mounted						
Part	Projection	3/605 4/606	10/612 10B/613	Stock PC 10BE	26/625 26D/626	32D/630
RM860	1 1/32"	23	25	25	22	20
RM861	1 3/32"	23	25	25	22	20
Part	Size					15/619
RM867	Square 1 3/4" Base, 3/4" Projection					46

Base Board Mounted						
Part	Projection	3/605 4/606	10/612 10B/613	Stock PC 10BE	26/625 26D/626	32D/630
RM870	1 1/2"	32	35	35	30	23
RM871	3 1/4"	32	35	35	30	23
RM872	3 3/4"	32	35	35	30	23
RM875	1 1/2"	45	48	48	45	35
RM876	3 1/4"	45	48	48	45	35
RM877	3 3/4"	45	48	48	45	35

ASSA ABLOY

The global leader in door opening solutions

Prices Effective September 1, 2017

Copyright © 2017, Rockwood Manufacturing Company, an ASSA ABLOY Group company. All rights reserved. Reproduction in whole or in part without the express written permission of Rockwood Manufacturing Company is prohibited.



## Push Plates, Pull Plates and Signage

Square Corner - Adhesive Mount						
Part	Size	3/605 4/606	10/612 10B/613	Stock PC 10BE	32D/630	32/629
RM1010	4" x 22"				50	56
RM1010H	4" x 22"				75	84
RM1010L	4" x 22"				75	84
Square Corner - Screw Mount						
RM1020	4" x 22"	73	79	57	37	42
RM1020H	4" x 22"	102	110	83	63	71
RM1020L	4" x 22"	102	110	83	63	71
Radius End Corner - Adhesive Mount						
RM1030	4" x 22"				63	71
RM1030H	4" x 22"				89	100
RM1030L	4" x 22"				89	100
Radius End Corner - Screw Mount						
RM1040	4" x 22"	88	96	70	50	56
RM1040H	4" x 22"	116	126	95	75	84
RM1040L	4" x 22"	116	126	95	75	84

Indicator Plates - Adhesive Mount					
Part	Size	3/605 4/606	10/612 10B/613	32D/630	32/629
RM1110H	1" Dia.	60	68	53	59
RM1110L	1" Dia.	60	68	53	59
RM1120H	2 1/2" Dia.	60	68	53	59
RM1120L	2 1/2" Dia.	60	68	53	59
RM1150M	2" x 4"	64	74	59	67
RM1150W	2" x 5 3/4"	67	76	61	69
Indicator Plates - Screw Mount					
RM1160M	2" x 4"	64	74	59	67
RM1160W	2" x 5 3/4"	67	76	61	69

## MegaTek - Small Pulls for Cabinets, Casework & Closet Doors

Straight - Flat Ends								
Part	Max OA	Dia.	3/605 4/606	10B/613	Stock PC 10BE	32D/630	32/629	32D316
RM1200-4	5 7/8"	1/2"	48	52	42	22	25	28
RM1200-5	6 7/8"	1/2"	49	53	43	23	26	30
RM1200-6	7 7/8"	1/2"	50	54	53	33	38	43
RM1200-8	9 7/8"	1/2"	53	57	57	37	41	48
RM1200-10	11 7/8"	1/2"	56	61	60	40	44	52
RM1200-12	13 7/8"	1/2"	63	68	63	43	49	56
RM1200-18	19 7/8"	1/2"	84	90	66	46	52	60
RM1200-24	25 7/8"	1/2"	96	103	76	56	63	73
RM1200-30	31 7/8"	1/2"	114	123	85	65	72	84
RM1210-5	6 7/8"	5/8"	63	68	52	32	36	42
RM1210-6	7 7/8"	5/8"	64	69	56	36	40	46
RM1210-7	8 7/8"	5/8"	65	70	61	41	46	53
RM1210-8	9 7/8"	5/8"	67	73	63	43	49	56
RM1210-10	11 7/8"	5/8"	75	80	64	44	50	57
RM1210-12	13 7/8"	5/8"	81	88	66	46	52	60
RM1210-18	19 7/8"	5/8"	111	120	80	60	68	79
RM1210-24	25 7/8"	5/8"	127	136	89	69	78	90
RM1210-30	31 7/8"	5/8"	152	164	95	75	83	97

## Groove - Small Pulls

Straight - Flat Ends								
Part	Max OA	Dia.	3/605 4/606	10/612 10B/613	Stock PC 10BE	32D/630	32/629	32D316
RM1211-5	6 7/8"	5/8"	71	76	68	48	54	
RM1211-6	7 7/8"	5/8"	72	77	69	49	55	
RM1211-7	8 7/8"	5/8"	73	78	70	50	56	
RM1211-8	9 7/8"	5/8"	74	80	71	51	57	
RM1211-10	11 7/8"	5/8"	81	87	72	52	58	
RM1211-12	13 7/8"	5/8"	85	93	75	55	61	
Offset - Flat Ends								
RM1230-5	6 7/8"	5/8"	90	98	88	68	76	88
RM1230-6	7 7/8"	5/8"	92	99	89	69	77	90
RM1230-7	8 7/8"	5/8"	94	101	91	71	79	92
RM1230-8	9 7/8"	5/8"	98	106	94	74	83	96
RM1230-10	11 7/8"	5/8"	105	113	95	75	84	98
RM1230-12	13 7/8"	5/8"	110	119	97	77	86	100
RM1230-18	19 7/8"	5/8"	138	150	117	87	98	113
RM1230-24	25 7/8"	5/8"	154	166	129	99	110	129
RM1230-30	31 7/8"	5/8"	177	191	133	103	115	134
Straight - Round Ends								
RM1240-4	5 7/8"	1/2"	57	62	59	39	44	51
RM1240-5	6 7/8"	1/2"	58	63	60	40	45	52
RM1240-6	7 7/8"	1/2"	59	64	61	41	46	53
RM1240-8	9 7/8"	1/2"	61	67	64	44	49	57
RM1240-10	11 7/8"	1/2"	63	69	68	48	54	62
RM1240-12	13 7/8"	1/2"	68	73	72	52	58	68
RM1240-18	19 7/8"	1/2"	88	96	86	56	62	73
RM1240-24	25 7/8"	1/2"	103	111	92	62	70	81
RM1240-30	31 7/8"	1/2"	116	126	102	72	80	94

Small Pulls (con't)

Straight - Round Ends								
Part	Max OA	Dia.	3/605 4/606	10B/613	Stock PC 10BE	32D/630	32/629	32D316
RM1250-5	6 7/8"	5/8"	68	73	68	48	54	63
RM1250-6	7 7/8"	5/8"	70	75	69	49	55	64
RM1250-7	8 7/8"	5/8"	72	78	70	50	56	65
RM1250-8	9 7/8"	5/8"	74	80	71	51	57	66
RM1250-10	11 7/8"	5/8"	82	88	73	53	59	69
RM1250-12	13 7/8"	5/8"	86	94	75	55	61	71
RM1250-18	19 7/8"	5/8"	114	124	85	65	73	85
RM1250-24	25 7/8"	5/8"	131	141	95	75	85	98
RM1250-30	31 7/8"	5/8"	154	166	100	80	89	103

Offset - Round Ends								
Part	Max OA	Dia.	3/605 4/606	10B/613	Stock PC 10BE	32D/630	32/629	32D316
RM1270-5	6 7/8"	5/8"	103	111	97	77	86	100
RM1270-6	7 7/8"	5/8"	104	112	98	78	87	101
RM1270-7	8 7/8"	5/8"	105	113	99	79	88	102
RM1270-8	9 7/8"	5/8"	108	116	101	81	90	105
RM1270-10	11 7/8"	5/8"	114	124	102	82	92	106
RM1270-12	13 7/8"	5/8"	120	129	104	84	94	109
RM1270-18	19 7/8"	5/8"	148	159	117	97	108	126
RM1270-24	25 7/8"	5/8"	163	177	125	105	117	137
RM1270-30	31 7/8"	5/8"	187	202	129	109	122	142

GripZone - Small Pulls for Cabinets, Casework & Closet Doors

Straight - Flat Ends			
Part	Max OA	Dia.	32/629
RM1300-4	5 7/8"	1/2"	56
RM1300-5	6 7/8"	1/2"	57
RM1300-6	7 7/8"	1/2"	58
RM1300-8	9 7/8"	1/2"	59
RM1300-10	11 7/8"	1/2"	61
RM1300-12	13 7/8"	1/2"	66
RM1300-18	19 7/8"	1/2"	70
RM1300-24	25 7/8"	1/2"	80
RM1300-30	31 7/8"	1/2"	88
Straight - Flat Ends			
RM1310-5	6 7/8"	5/8"	63
RM1310-6	7 7/8"	5/8"	64
RM1310-7	8 7/8"	5/8"	65
RM1310-8	9 7/8"	5/8"	66
RM1310-10	11 7/8"	5/8"	68
RM1310-12	13 7/8"	5/8"	70
RM1310-18	19 7/8"	5/8"	84
RM1310-24	25 7/8"	5/8"	93
RM1310-30	31 7/8"	5/8"	104

Offset - Flat Ends			
Part	Max OA	Dia.	32/629
RM1330-5	6 7/8"	5/8"	93
RM1330-6	7 7/8"	5/8"	94
RM1330-7	8 7/8"	5/8"	95
RM1330-8	9 7/8"	5/8"	99
RM1330-10	11 7/8"	5/8"	101
RM1330-12	13 7/8"	5/8"	104
RM1330-18	19 7/8"	5/8"	115
RM1330-24	25 7/8"	5/8"	126
RM1330-30	31 7/8"	5/8"	135
Straight - Round Ends			
RM1340-4	5 7/8"	1/2"	64
RM1340-5	6 7/8"	1/2"	65
RM1340-6	7 7/8"	1/2"	66
RM1340-8	9 7/8"	1/2"	68
RM1340-10	11 7/8"	1/2"	70
RM1340-12	13 7/8"	1/2"	77
RM1340-18	19 7/8"	1/2"	82
RM1340-24	25 7/8"	1/2"	88
RM1340-30	31 7/8"	1/2"	99

Straight - Round Ends			
Part	Max OA	Dia.	32/629
RM1350-5	6 7/8"	5/8"	74
RM1350-6	7 7/8"	5/8"	75
RM1350-7	8 7/8"	5/8"	76
RM1350-8	9 7/8"	5/8"	77
RM1350-10	11 7/8"	5/8"	80
RM1350-12	13 7/8"	5/8"	82
RM1350-18	19 7/8"	5/8"	93
RM1350-24	25 7/8"	5/8"	104
RM1350-30	31 7/8"	5/8"	112
Offset - Round Ends			
RM1370-5	6 7/8"	5/8"	104
RM1370-6	7 7/8"	5/8"	105
RM1370-7	8 7/8"	5/8"	106
RM1370-8	9 7/8"	5/8"	108
RM1370-10	11 7/8"	5/8"	110
RM1370-12	13 7/8"	5/8"	112
RM1370-18	19 7/8"	5/8"	126
RM1370-24	25 7/8"	5/8"	135
RM1370-30	31 7/8"	5/8"	146

**ASSA ABLOY**

The global leader in door opening solutions

Prices Effective September 1, 2017

Copyright © 2017, Rockwood Manufacturing Company, an ASSA ABLOY Group company. All rights reserved. Reproduction in whole or in part without the express written permission of Rockwood Manufacturing Company is prohibited.

## NoirMet - Small Pulls

Straight - Flat Ends							
Part	Max OA	Dia.	3/605 4/606	10B/613	Stock PC 10BE	32D/630	32/629
RM1410-5	6 7/8"	5/8"	111	120	85	65	72
RM1410-6	7 7/8"	5/8"	114	123	87	67	75
Offset - Flat Ends							
RM1430-5	6 7/8"	5/8"	157	170	123	103	116
RM1430-6	7 7/8"	5/8"	160	173	125	105	118
Straight - Round Ends							
RM1450-5	6 7/8"	5/8"	132	143	101	81	90
RM1450-6	7 7/8"	5/8"	135	146	104	84	93
Offset - Round Ends							
RM1470-5	6 7/8"	5/8"	177	191	140	120	135
RM1470-6	7 7/8"	5/8"	180	194	145	125	140

## ArborMet - Small Pulls

Straight - Flat Ends							
Part	Max OA	Dia.	3/605 4/606	10B/613	Stock PC 10BE	32D/630	32/629
RM1510-5	6 7/8"	5/8"	117	126	89	69	79
RM1510-6	7 7/8"	5/8"	120	130	92	72	82
Offset - Flat Ends							
RM1530-5	6 7/8"	5/8"	163	176	129	109	124
RM1530-6	7 7/8"	5/8"	167	180	132	112	129
Straight - Round Ends							
RM1550-5	6 7/8"	5/8"	138	149	108	88	100
RM1550-6	7 7/8"	5/8"	141	152	111	91	104
Offset - Round Ends							
RM1570-5	6 7/8"	5/8"	184	199	147	127	145
RM1570-6	7 7/8"	5/8"	186	201	149	129	148

## MegaCurve - Long Curved Pulls

Mid Bow								
Part	Max OA	3/605 4/606	10/612 10B/613	Stock PC 10BE	32D/630	32/629	32D316	32316
RM2000	72" - 96"	1509	1630	1145	1025	1170	1358	1521
RM2004	72" - 96"	1603	1731	1230	1110	1267		
Long Bow Pulls								
RM2010	72" - 96"	1977	2135	1571	1451	1656	1922	2152
RM2014	72" - 96"	2073	2239	1656	1536	1753		
45° Pulls								
RM2020	72" - 96"	1603	1731	1230	1110	1267	1470	1647
RM2024	72" - 96"	1697	1833	1315	1195	1363		
Triangle Pulls								
RM2030	72" - 96"	1603	1731	1230	1110	1267	1470	1647
RM2034	72" - 96"	1697	1833	1315	1195	1363		

- Add \$6/in. over 96".

Prices Effective September 1, 2017

Copyright © 2017, Rockwood Manufacturing Company, an ASSA ABLOY Group company. All rights reserved.  
Reproduction in whole or in part without the express written permission of Rockwood Manufacturing Company is prohibited.

**ASSA ABLOY**

The global leader in  
door opening solutions

MezzoTek - Necked Post Pulls

Straight Pulls without GripZone									
Part	Max OA	Dia.	3/605 4/606	10/612 10B/613	Stock PC 10BE	32D/630	32/629	32D316	32316
<b>RM2110</b>	12"	1 1/4"	471	509	280	200	224	260	290
	24"	1 1/4"	509	550	330	250	280	325	363
	36"	1 1/4"	547	591	380	300	336	390	435
	48"	1 1/4"	585	632	430	350	392	455	508
	60"	1 1/4"	610	659	463	383	429	498	555
	72"	1 1/4"	635	686	516	416	466	541	603
	84"	1 1/4"	660	713	549	449	503	584	651
	96"	1 1/4"	685	740	582	482	540	627	699
<b>RM2120</b>	12"	1 1/2"	512	553	291	211	236		
	24"	1 1/2"	550	594	341	261	292		
	36"	1 1/2"	588	635	391	311	348		
	48"	1 1/2"	626	676	441	361	404		
	60"	1 1/2"	651	703	473	393	440		
	72"	1 1/2"	676	730	526	426	477		
	84"	1 1/2"	701	757	559	459	514		
	96"	1 1/2"	726	784	592	492	551		
Push Bars without GripZone									
<b>RM2112</b>	Up to 36" CTC	1 1/4"	547	591	380	300	336		
<b>RM2122</b>	Up to 36" CTC	1 1/2"	588	635	391	311	348		
Straight Pulls with GripZone									
Part	Max OA	Dia.	3/605	9/611	32/629	32316			
<b>RM2130</b>	12"	1 1/4"	571	646	324	470			
	24"	1 1/4"	609	688	380	551			
	36"	1 1/4"	647	731	436	632			
	48"	1 1/4"	685	774	492	713			
	60"	1 1/4"	710	803	529	767			
	72"	1 1/4"	735	831	566	821			
	84"	1 1/4"	760	859	603	874			
	96"	1 1/4"	785	887	640	928			
<b>RM2140</b>	12"	1 1/2"	612	692	336				
	24"	1 1/2"	650	735	392				
	36"	1 1/2"	688	777	448				
	48"	1 1/2"	726	820	504				
	60"	1 1/2"	751	849	540				
	72"	1 1/2"	776	877	577				
	84"	1 1/2"	801	905	614				
	96"	1 1/2"	826	933	651				
Push Bars with GripZone									
<b>RM2132</b>	Up to 36" CTC	1 1/4"	647	731	436				
<b>RM2142</b>	Up to 36" CTC	1 1/2"	688	777	448				
Double Stepped Post Pulls									
Part	Max OA	Dia.	3/605 4/606	10/612 10B/613	Stock PC 10BE	32D/630	32/629	32D316	32316
<b>RM2150-8</b>	14"	1"	365	402	298	218	244	284	318
<b>RM2150-11</b>	17"	1"	380	418	311	231	259	301	337
<b>RM2150-16</b>	22"	1"	395	435	323	243	272	316	355

- Add \$6/in. over 96".
- MP (Mid Post) - Add \$70 each (Recommended for maximum rigidity on long door pulls. See page 5 for guidelines.)
- Pulls with GripZone offer an additional aesthetic look, not a tactile feel. The grip zones are satin, the post and end sections are polished. US10B finish is not available on GripZone pulls.

NOTE: Post location on push bars can be located 1/8" from end for narrow & medium stile doors and 1" from end for flush and wide stile doors.



The global leader in door opening solutions

Prices Effective September 1, 2017

Copyright © 2017, Rockwood Manufacturing Company, an ASSA ABLOY Group company. All rights reserved. Reproduction in whole or in part without the express written permission of Rockwood Manufacturing Company is prohibited.

## BandWidth - Collar Mount Pulls

Straight Pulls - Flat Ends							
Part	Max OA	Dia.	3/605 4/606	10/612 10B/613	Stock PC 10BE	32D/630	32/629
<b>RM2200</b>	12"	1"	446	482	416	336	376
	24"	1"	519	560	454	374	419
	36"	1"	592	639	512	412	461
	48"	1"	665	718	550	450	504
	60"	1"	737	796	575	475	532
	72"	1"	810	875	600	500	560
	84"	1"	883	954	625	525	588
	96"	1"	956	1032	650	550	616
<b>RM2210</b>	12"	1 1/4"	478	516	427	347	389
	24"	1 1/4"	548	592	465	385	431
	36"	1 1/4"	619	669	523	423	474
	48"	1 1/4"	689	744	560	460	515
	60"	1 1/4"	760	821	585	485	543
	72"	1 1/4"	830	896	610	510	571
	84"	1 1/4"	901	973	635	535	599
	96"	1 1/4"	971	1049	660	560	627
Offset Pulls - Flat Ends							
<b>RM2230</b>	12"	1"	486	525	450	370	414
	24"	1"	559	604	508	408	457
	36"	1"	632	682	546	446	500
	48"	1"	705	761	584	484	542
	60"	1"	777	840	609	509	570
	72"	1"	850	918	634	534	598
	84"	1"	923	997	659	559	626
	96"	1"	996	1076	684	584	654
<b>RM2240</b>	12"	1 1/4"	518	559	461	381	427
	24"	1 1/4"	588	635	519	419	469
	36"	1 1/4"	659	712	557	457	512
	48"	1 1/4"	729	787	594	494	553
	60"	1 1/4"	800	864	619	519	581
	72"	1 1/4"	870	940	644	544	609
	84"	1 1/4"	941	1016	669	569	637
	96"	1 1/4"	1011	1092	694	594	665

Straight Pulls - Round Ends							
Part	Max OA	Dia.	3/605 4/606	10/612 10B/613	Stock PC 10BE	32D/630	32/629
<b>RM2204</b>	12"	1"	531	573	456	376	421
	24"	1"	604	652	514	414	464
	36"	1"	677	731	552	452	506
	48"	1"	750	810	590	490	549
	60"	1"	822	888	615	515	577
	72"	1"	895	967	640	540	605
	84"	1"	968	1046	665	565	633
	96"	1"	1041	1124	690	590	661
<b>RM2214</b>	12"	1 1/4"	563	608	467	387	433
	24"	1 1/4"	633	684	525	425	476
	36"	1 1/4"	704	760	563	463	519
	48"	1 1/4"	774	836	600	500	560
	60"	1 1/4"	845	913	625	525	588
	72"	1 1/4"	915	988	650	550	616
	84"	1 1/4"	986	1065	675	575	644
	96"	1 1/4"	1056	1140	700	600	672
Offset Pulls - Round Ends							
<b>RM2234</b>	12"	1"	571	617	510	410	459
	24"	1"	644	695	548	448	502
	36"	1"	717	774	586	486	544
	48"	1"	790	853	624	524	587
	60"	1"	862	931	649	549	615
	72"	1"	935	1010	674	574	643
	84"	1"	1008	1089	699	599	671
	96"	1"	1081	1167	724	624	699
<b>RM2244</b>	12"	1 1/4"	603	651	521	421	472
	24"	1 1/4"	673	727	559	459	514
	36"	1 1/4"	744	804	597	497	557
	48"	1 1/4"	814	879	634	534	598
	60"	1 1/4"	885	956	659	559	626
	72"	1 1/4"	955	1031	684	584	654
	84"	1 1/4"	1026	1108	709	609	682
	96"	1 1/4"	1096	1184	734	634	710
Push Bars - Flat Ends							
<b>RM2202</b>	Up to 36" CTC	1"	592	639	512	412	461
<b>RM2212</b>	Up to 36" CTC	1 1/4"	619	669	523	423	474
Push Bars - Round Ends							
<b>RM2206</b>	Up to 36" CTC	1"	677	731	552	452	506
<b>RM2216</b>	Up to 36" CTC	1 1/4"	704	760	563	463	519

- Add 5/16" in. over 96".
- MP (Mid Post) - Add \$100 each (Recommended for maximum rigidity on long door pulls. See page 5 for guidelines.)
- Specify finish of grip and collar.

NOTE: Post location on push bars can be located 1/8" from end for narrow & medium stile doors and 1" from end for flush and wide stile doors.

**ASSA ABLOY**

The global leader in  
door opening solutions

OvalTek - True Oval Grip

Straight Pulls						
Part	Max OA	Size	Stock PC 10BE	32D/630	32/629	
RM2300-8	12"	1" x 1 1/2"	398	318	356	
RM2300-11	15"	1" x 1 1/2"	406	326	365	
RM2300-16	20"	1" x 1 1/2"	413	333	373	
RM2300	36" - 48"	1" x 1 1/2"	567	467	524	
RM2300	48" - 72"	1" x 1 1/2"	658	558	624	
RM2300	72" - 96"	1" x 1 1/2"	778	678	760	
Offset Pulls						
RM2320-8	13"	1" x 1 1/2"	430	350	392	
RM2320-11	16"	1" x 1 1/2"	437	357	400	
RM2320-16	21"	1" x 1 1/2"	444	364	407	
RM2320	36" - 48"	1" x 1 1/2"	593	493	552	
RM2320	48" - 72"	1" x 1 1/2"	681	581	651	
RM2320	72" - 96"	1" x 1 1/2"	793	693	776	
Straight Pulls						
RM2310-11	15"	1 1/8" x 1 7/8"	413	333	373	
RM2310-16	20"	1 1/8" x 1 7/8"	441	361	405	
RM2310-20	24"	1 1/8" x 1 7/8"	456	376	422	
RM2310	36" - 48"	1 1/8" x 1 7/8"	598	498	558	
RM2310	48" - 72"	1 1/8" x 1 7/8"	703	603	675	
RM2310	72" - 96"	1 1/8" x 1 7/8"	840	740	829	
Offset Pulls						
RM2330-11	16"	1 1/8" x 1 7/8"	444	364	407	
RM2330-16	21"	1 1/8" x 1 7/8"	472	392	439	
RM2330-20	25"	1 1/8" x 1 7/8"	506	406	455	
RM2330	36" - 48"	1 1/8" x 1 7/8"	624	524	586	
RM2330	48" - 72"	1 1/8" x 1 7/8"	720	620	694	
RM2330	72" - 96"	1 1/8" x 1 7/8"	850	750	841	
Push Bars						
RM2302	Up to 36" CTC	1" x 1 1/2"	628	528	591	
RM2312	Up to 36" CTC	1 1/8" x 1 7/8"	642	542	606	

OvalTek - Flat Oval Grip

Straight Pulls - Small Round Posts						
Part	Max OA	Size	Stock PC 10BE	32D/630	32/629	
RM2400-8	14"	3/4" x 1 1/2"	441	361	405	
RM2400-11	17"	3/4" x 1 1/2"	456	376	422	
RM2400-16	22"	3/4" x 1 1/2"	472	392	439	
RM2400	36" - 48"	3/4" x 1 1/2"	658	558	624	
RM2400	48" - 72"	3/4" x 1 1/2"	748	648	725	
RM2400	72" - 96"	3/4" x 1 1/2"	964	844	946	
Straight Pulls - Large Round Posts						
RM2410-8	13"	3/4" x 1 1/2"	472	392	439	
RM2410-11	16"	3/4" x 1 1/2"	506	406	455	
RM2410-16	21"	3/4" x 1 1/2"	523	423	474	
RM2410	36" - 48"	3/4" x 1 1/2"	687	587	657	
RM2410	48" - 72"	3/4" x 1 1/2"	778	678	760	
RM2410	72" - 96"	3/4" x 1 1/2"	992	872	977	
Straight Pulls - Oblong Posts						
RM2420-8	14"	3/4" x 1 1/2"	612	512	573	
RM2420-11	17"	3/4" x 1 1/2"	628	528	591	
RM2420-16	22"	3/4" x 1 1/2"	642	542	606	
RM2420	36" - 48"	3/4" x 1 1/2"	809	709	794	
RM2420	48" - 72"	3/4" x 1 1/2"	899	799	895	
RM2420	72" - 96"	3/4" x 1 1/2"	1113	993	1112	
Push Bar - Large Round Posts						
RM2402	Up to 36" CTC	3/4" x 1 1/2"	748	648	725	

- RM2310 & RM2410 pulls add \$7/in. over 96".
- MP (Mid Post) - Add \$100 each (Recommended for maximum rigidity on long door pulls. See page 5 for guidelines.)

NOTE: Post location on push bars can be located 1/8" from end for narrow & medium stile doors and 1" from end for flush and wide stile doors.

SoftMet - Santoprene™ Grip

Straight Pulls - Flat Ends								
Part	Max OA	Dia.	3/605 4/606	10/612 10B/613	Stock PC 10BE	32D/630	32/629	
RM2510-8	12"	1 1/4"	361	390	373	293	328	
RM2510-11	15"	1 1/4"	377	407	387	307	345	
RM2510-16	20"	1 1/4"	409	442	411	331	370	
RM2510	Up to 36" CTC	1 1/4"	572	618	576	476	533	
Offset Pulls - Flat Ends								
RM2540-8	12"	1 1/4"	402	434	411	331	370	
RM2540-11	15"	1 1/4"	419	453	427	347	388	
RM2540-16	20"	1 1/4"	451	487	450	370	414	
RM2540	Up to 36" CTC	1 1/4"	613	662	614	514	576	
Straight Pulls - Round Ends								
RM2514-8	12"	1 1/4"	402	434	411	331	370	
RM2514-11	15"	1 1/4"	419	453	427	347	388	
RM2514-16	20"	1 1/4"	451	487	450	370	414	
RM2514	Up to 36" CTC	1 1/4"	613	662	614	514	576	

Offset Pulls - Round Ends								
Part	Max OA	Dia.	3/605 4/606	10/612 10B/613	Stock PC 10BE	32D/630	32/629	
RM2544-8	12"	1 1/4"	442	477	450	370	414	
RM2544-11	15"	1 1/4"	458	495	464	384	429	
RM2544-16	20"	1 1/4"	490	529	508	408	457	
RM2544	Up to 36" CTC	1 1/4"	653	705	651	551	617	
Push Bars								
RM2512	Up to 36" CTC	Sq. End	589	636	590	490	548	
RM2516	Up to 36" CTC	Rd. End	630	680	629	529	593	

NOTE: Post location on push bars can be located 1/8" from end for narrow & medium stile doors and 1" from end for flush and wide stile doors.

\*Santoprene™ is a registered trademark of the Exxon Mobil Corporation.

**ASSA ABLOY**

The global leader in door opening solutions

Prices Effective September 1, 2017

Copyright © 2017, Rockwood Manufacturing Company, an ASSA ABLOY Group company. All rights reserved. Reproduction in whole or in part without the express written permission of Rockwood Manufacturing Company is prohibited.

## SoftTek - Santoprene™ Grip

Straight Pulls							
Part	Max OA	Dia.	3/605 4/606	10/612 10B/613	Stock PC 10BE	32D/630	32/629
RM2610-8	13"	1 ¼"	325	351	351	282	316
RM2610-11	16"	1 ¼"	340	367	367	297	333
RM2610-16	21"	1 ¼"	371	401	398	318	356
RM2610	Up to 36" CTC	1 ¼"	524	566	558	458	513
Offset Pulls							
RM2640-8	13"	1 ¼"	363	392	392	318	356
RM2640-11	16"	1 ¼"	380	410	410	334	374
RM2640-16	21"	1 ¼"	410	443	434	354	396
RM2640	Up to 36" CTC	1 ¼"	565	610	595	495	554
Push Bar							
RM2612	Up to 36" CTC	1 ¼"	540	583	572	472	529

## NeoMetrix - with GripZone

Straight Pulls						
Part	CTC	Dia.	3/605	9/611	32/629	32316
RM3010-12	12"	1"	173	216	130	169
RM3010-18	18"	1"	225	281	157	204
RM3020-12	12"	1 ¼"	248	310	195	254
RM3020-18	18"	1 ¼"	278	348	207	269
RM3020-24	24"	1 ¼"	309	386	220	286
RM3030-12	12"	1 ½"	293	366	215	
RM3030-18	18"	1 ½"	314	393	245	
RM3030-24	24"	1 ½"	342	428	275	

NOTE: Post location on push bars can be located ⅛" from end for narrow & medium stile doors and 1" from end for flush and wide stile doors.

Offset Pulls						
Part	CTC	Dia.	3/605	9/611	32/629	32316
RM3040-12	12"	1"	220	275	154	
RM3040-18	18"	1"	255	319	189	
RM3050-12	12"	1 ¼"	305	381	239	
RM3050-18	18"	1 ¼"	335	419	257	
RM3050-24	24"	1 ¼"	363	454	275	
RM3060-12	12"	1 ½"	358	448	270	
RM3060-18	18"	1 ½"	392	490	300	
RM3060-24	24"	1 ½"	436	545	325	
Push Bars - 7" Grip						
RM3012	Up to 36"	1"	305	381	201	261
RM3022	Up to 36"	1 ¼"	335	419	245	319
RM3032	Up to 36"	1 ½"	392	490	300	

## Groove - Straight & Offset Pulls

Straight Pulls - Flat Ends							
Part	Max OA	Dia.	3/605 4/606	10/612 10B/613	Stock PC 10BE	32D/630	32/629
RM3101-8	13"	1"	275	297	218	168	188
RM3101-10	15"	1"	280	302	225	175	196
RM3101-12	17"	1"	287	310	230	180	202
Offset Pulls - Flat Ends							
RM3131-8	13"	1"	308	333	249	199	223
RM3131-10	15"	1"	315	340	285	205	230
RM3131-12	17"	1"	322	348	291	211	236

\*Santoprene™ is a registered trademark of the Exxon Mobil Corporation.

Prices Effective September 1, 2017

Copyright © 2017, Rockwood Manufacturing Company, an ASSA ABLOY Group company. All rights reserved.  
Reproduction in whole or in part without the express written permission of Rockwood Manufacturing Company is prohibited.

**ASSA ABLOY**

The global leader in  
door opening solutions

NeoTek - Post Mounted with GripZone

Straight Pulls - Flat Ends							
Part	Max OA	Dia.	3/605	9/611	32/629	32316	
<b>RM3200</b>	12"	1"	284	321	172		
	24"	1"	358	404	215		
	36"	1"	431	488	258		
	48"	1"	505	571	301		
	60"	1"	579	654	344		
	72"	1"	653	737	387		
	84"	1"	726	821	430		
	96"	1"	800	904	473		
	<b>RM3210</b>	12"	1 1/4"	314	355	184	267
		24"	1 1/4"	385	436	227	329
		36"	1 1/4"	457	516	270	392
		48"	1 1/4"	528	597	313	454
60"		1 1/4"	600	678	356	516	
72"		1 1/4"	671	758	399	579	
	84"	1 1/4"	743	839	442	641	
	96"	1 1/4"	814	920	485	703	
	<b>RM3220</b>	12"	1 1/2"	373	421	208	
		24"	1 1/2"	440	497	254	
		36"	1 1/2"	507	573	301	
		48"	1 1/2"	574	649	347	
60"		1 1/2"	641	724	394		
72"		1 1/2"	708	800	440		
	84"	1 1/2"	775	876	487		
	96"	1 1/2"	842	951	533		
	Offset Pulls - Flat Ends						
	<b>RM3230</b>	12"	1"	321	363	204	
		24"	1"	395	446	247	
		36"	1"	468	529	290	
48"		1"	542	613	333		
60"		1"	616	696	376		
72"		1"	690	779	419		
	84"	1"	763	863	462		
	96"	1"	837	946	505		
	<b>RM3240</b>	12"	1 1/4"	351	397	216	
		24"	1 1/4"	422	477	259	
		36"	1 1/4"	494	558	302	
		48"	1 1/4"	565	639	345	
60"		1 1/4"	637	719	388		
72"		1 1/4"	708	800	431		
	84"	1 1/4"	780	881	474		
	96"	1 1/4"	851	962	517		
	<b>RM3250</b>	12"	1 1/2"	410	463	240	
		24"	1 1/2"	477	539	286	
		36"	1 1/2"	544	615	333	
		48"	1 1/2"	611	690	379	
60"		1 1/2"	678	766	426		
72"		1 1/2"	745	842	472		
	84"	1 1/2"	812	918	519		
	96"	1 1/2"	879	993	565		

- Add <sup>5</sup>/<sub>16</sub>" in. over 96".
- MP (Mid Post) - Add \$70 each (Recommended for maximum rigidity on long door pulls. See page 5 for guidelines.)

Straight Pulls - Round Ends							
Part	Max OA	Dia.	3/605	9/611	32/629	32316	
<b>RM3204</b>	12"	1"	364	411	206		
	24"	1"	438	495	249		
	36"	1"	511	578	292		
	48"	1"	585	661	335		
	60"	1"	659	745	378		
	72"	1"	733	828	421		
	84"	1"	806	911	464		
	96"	1"	880	994	507		
	<b>RM3214</b>	12"	1 1/4"	394	445	218	
		24"	1 1/4"	465	526	261	
		36"	1 1/4"	537	607	304	
		48"	1 1/4"	608	687	347	
60"		1 1/4"	680	768	390		
72"		1 1/4"	751	849	433		
	84"	1 1/4"	823	930	476		
	96"	1 1/4"	894	1010	519		
	<b>RM3224</b>	12"	1 1/2"	453	512	242	
		24"	1 1/2"	520	588	288	
		36"	1 1/2"	587	663	335	
		48"	1 1/2"	654	739	381	
60"		1 1/2"	721	815	428		
72"		1 1/2"	788	890	474		
	84"	1 1/2"	855	966	521		
	96"	1 1/2"	922	1042	567		
	Offset Pulls - Round Ends						
	<b>RM3234</b>	12"	1"	401	453	238	
		24"	1"	475	536	281	
		36"	1"	548	620	324	
48"		1"	622	703	367		
60"		1"	696	786	410		
72"		1"	770	870	453		
	84"	1"	843	953	496		
	96"	1"	917	1036	539		
	<b>RM3244</b>	12"	1 1/4"	432	488	250	
		24"	1 1/4"	503	569	293	
		36"	1 1/4"	575	650	336	
		48"	1 1/4"	646	730	379	
60"		1 1/4"	718	811	422		
72"		1 1/4"	789	892	465		
	84"	1 1/4"	861	972	508		
	96"	1 1/4"	932	1053	551		
	<b>RM3254</b>	12"	1 1/2"	490	554	274	
		24"	1 1/2"	557	629	320	
		36"	1 1/2"	624	705	367	
		48"	1 1/2"	691	781	413	
60"		1 1/2"	758	857	460		
72"		1 1/2"	825	932	506		
	84"	1 1/2"	892	1008	553		
	96"	1 1/2"	959	1084	599		

Push Bars - Flat Ends (7" Grip)					
Part	CTC	Dia.	3/605	9/611	32/629
<b>RM3202</b>	Up to 36"	1"	431	488	258
<b>RM3212</b>	Up to 36"	1 1/4"	457	516	270
<b>RM3222</b>	Up to 36"	1 1/2"	507	573	301
Push Bars - Round Ends (7" Grip)					
<b>RM3206</b>	Up to 36"	1"	511	578	292
<b>RM3216</b>	Up to 36"	1 1/4"	537	607	304
<b>RM3226</b>	Up to 36"	1 1/2"	587	663	335

NOTE: Post location on push bars can be located 1/8" from end for narrow & medium stile doors and 1" from end for flush and wide stile doors.

Prices Effective September 1, 2017

**ASSA ABLOY**

The global leader in door opening solutions



## MegaTek - Straight & Offset PostMount Pulls

Straight Pulls - Flat Ends (87" max overall in aluminum, specify CTC and overall length.)											
Part	Max OA	Dia.	28/628	313/710 315/711	3/605 4/606	10/612 10B/613	Stock PC 10BE	32D/630	32/629	32D316	32316
<b>RM3300</b>	12"	1"	121	134	318	343	178	128	143	166	186
	24"	1"	159	172	356	384	216	166	186	216	242
	36"	1"	197	210	394	426	284	204	228	265	296
	48"	1"	213	253	432	467	322	242	271	315	352
	60"	1"	238	278	457	494	347	267	299	347	389
	72"	1"	263	303	482	521	372	292	327	380	425
	84"	1"	288	328	507	548	397	317	355	412	462
	96"	1"			532	575	422	342	383	445	498
<b>RM3301</b>	12"	1 ¼"	139	153	332	359	189	139	156	181	203
	24"	1 ¼"	177	191	370	400	227	177	198	230	257
	36"	1 ¼"	215	229	408	441	295	215	241	280	313
	48"	1 ¼"	253	293	446	482	332	252	282	328	367
	60"	1 ¼"	278	318	471	509	357	277	310	360	403
	72"	1 ¼"	303	343	496	536	382	302	338	393	439
	84"	1 ¼"	328	368	521	563	407	327	366	425	476
	96"	1 ¼"			546	590	432	352	394	458	512
<b>RM3302</b>	12"	1 ½"	160	218	317	342	201	151	169	196	220
	24"	1 ½"	198	256	355	383	239	189	212	246	276
	36"	1 ½"	236	294	393	424	307	227	254	295	330
	48"	1 ½"	301	332	459	496	343	263	295	342	384
	60"	1 ½"	326	357	484	523	368	288	323	374	420
	72"	1 ½"	351	382	509	550	393	313	351	407	456
	84"	1 ½"	376	407	534	577	418	338	379	439	493
	96"	1 ½"			559	604	443	363	407	472	529
Offset Pulls - Flat Ends (Specify CTC and overall length.)											
<b>RM3310</b>	12"	1"			353	381	206	156	175	203	226
	24"	1"			391	422	244	194	217	252	281
	36"	1"			429	463	312	232	260	302	336
	48"	1"			467	504	348	268	300	348	389
	60"	1"			492	531	373	293	328	381	425
	72"	1"			517	558	398	318	356	413	461
	84"	1"			542	585	423	343	384	446	497
	96"	1"			567	612	448	368	412	478	534
<b>RM3311</b>	12"	1 ¼"			366	395	218	168	188	218	244
	24"	1 ¼"			404	436	286	206	231	268	299
	36"	1 ¼"			442	477	324	244	273	317	354
	48"	1 ¼"			480	518	359	279	312	363	405
	60"	1 ¼"			505	545	384	304	340	395	441
	72"	1 ¼"			530	572	409	329	368	428	477
	84"	1 ¼"			555	599	434	354	396	460	513
	96"	1 ¼"			580	626	459	379	424	493	550
<b>RM3312</b>	12"	1 ½"			353	381	229	179	200	233	260
	24"	1 ½"			391	422	297	217	243	282	315
	36"	1 ½"			429	463	335	255	286	332	370
	48"	1 ½"			494	534	369	289	324	376	419
	60"	1 ½"			519	561	394	314	352	408	455
	72"	1 ½"			544	588	419	339	380	441	492
	84"	1 ½"			569	615	444	364	408	473	528
	96"	1 ½"			594	642	469	389	436	506	564

- Add \$6/in. over 96".
- MP (Mid Post) - Add \$70 each (Recommended for maximum rigidity on long door pulls. See page 5 for guidelines.)

MegaTek - Straight & Offset PostMount Pulls (con't)

Straight Pulls - Round Ends (90" max overall in aluminum, specify CTC and overall length.)											
Part	Max OA	Dia.	28/628	313/710 315/711	3/605 4/606	10/612 10B/613	Stock PC 10BE	32D/630	32/629	32D316	32316
<b>RM3320</b>	12"	1"	153	166	394	426	212	162	181	211	235
	24"	1"	191	204	432	467	280	200	224	260	291
	36"	1"	229	242	470	508	318	238	267	309	347
	48"	1"	246	286	508	549	353	273	306	355	398
	60"	1"	271	311	533	576	378	298	334	387	434
	72"	1"	296	336	558	603	403	323	362	420	471
	84"	1"	321	361	583	630	428	348	390	452	507
	96"	1"			608	657	453	373	418	485	543
<b>RM3321</b>	12"	1 1/4"	174	186	408	441	224	174	195	226	254
	24"	1 1/4"	212	224	446	482	292	212	237	276	308
	36"	1 1/4"	250	262	484	523	330	250	280	325	364
	48"	1 1/4"	286	327	522	564	364	284	318	369	413
	60"	1 1/4"	311	352	547	591	389	309	346	402	450
	72"	1 1/4"	336	377	572	618	414	334	374	434	486
	84"	1 1/4"	361	402	597	645	439	359	402	467	523
	96"	1 1/4"			622	672	464	384	430	499	559
<b>RM3322</b>	12"	1 1/2"	192	206	399	431	247	197	221	256	287
	24"	1 1/2"	230	244	437	472	315	235	263	306	342
	36"	1 1/2"	268	282	475	513	353	273	306	355	398
	48"	1 1/2"	301	332	541	584	385	305	342	397	445
	60"	1 1/2"	326	357	566	611	410	330	370	429	481
	72"	1 1/2"	351	382	591	638	435	355	398	462	517
	84"	1 1/2"	376	407	616	665	460	380	426	494	554
	96"	1 1/2"			641	692	505	405	454	527	590
Offset Pulls - Round Ends (Specify CTC and overall length.)											
<b>RM3330</b>	12"	1"			427	461	241	191	214		
	24"	1"			465	502	309	229	256		
	36"	1"			503	543	347	267	299		
	48"	1"			541	584	380	300	336		
	60"	1"			566	611	405	325	364		
	72"	1"			591	638	430	350	392		
	84"	1"			616	665	455	375	420		
	96"	1"			641	692	500	400	448		
<b>RM3331</b>	12"	1 1/4"			441	476	282	202	226		
	24"	1 1/4"			479	517	320	240	269		
	36"	1 1/4"			517	558	358	278	311		
	48"	1 1/4"			555	599	390	310	347		
	60"	1 1/4"			580	626	415	335	375		
	72"	1 1/4"			605	653	440	360	403		
	84"	1 1/4"			630	680	465	385	431		
	96"	1 1/4"			655	707	510	410	459		
<b>RM3332</b>	12"	1 1/2"			435	470	306	226	253		
	24"	1 1/2"			473	511	344	264	296		
	36"	1 1/2"			511	552	382	302	338		
	48"	1 1/2"			575	621	411	331	371		
	60"	1 1/2"			600	648	436	356	399		
	72"	1 1/2"			625	675	461	381	427		
	84"	1 1/2"			650	702	506	406	455		
	96"	1 1/2"			675	729	531	431	483		

- Add \$6/in. over 96".
- MP (Mid Post) - Add \$70 each (Recommended for maximum rigidity on long door pulls. See page 5 for guidelines.)

**ASSA ABLOY**

The global leader in door opening solutions

Prices Effective September 1, 2017

Copyright © 2017, Rockwood Manufacturing Company, an ASSA ABLOY Group company. All rights reserved. Reproduction in whole or in part without the express written permission of Rockwood Manufacturing Company is prohibited.

## MegaTek - Straight & Offset PostMount Pulls (con't)

Straight Pulls - Bent Ends (86" max CTC in aluminum, specify CTC.)											
Part	CTC	Dia.	28/628	313/710 315/711	3/605 4/606	10/612 10B/613	Stock PC 10BE	32D/630	32/629	32D316	32316
<b>RM3340</b>	12"	1"	115	127	265	286	167	117	131	152	170
	24"	1"	145	160	303	327	205	155	174	202	226
	36"	1"	175	193	341	368	243	193	216	251	281
	48"	1"	205	226	379	409	311	231	259	300	337
	60"	1"	235	259	413	446	327	247	277	321	360
	72"	1"	265	292	446	482	343	263	295	342	384
	84"	1"	295	325	527	569	375	295	330	383	429
<b>RM3341</b>	96"	1"			608	657	406	326	365	424	475
	12"	1 ¼"	125	138	318	343	178	128	143	166	186
	24"	1 ¼"	155	171	356	384	216	166	186	216	242
	36"	1 ¼"	185	204	394	426	284	204	228	265	296
	48"	1 ¼"	215	237	432	467	322	242	271	315	352
	60"	1 ¼"	245	270	466	503	338	258	288	335	374
	72"	1 ¼"	275	303	500	540	353	273	306	355	398
<b>RM3342</b>	84"	1 ¼"	305	336	588	635	385	305	341	396	443
	96"	1 ¼"			676	730	416	336	376	437	489
	12"	1 ½"	140	154	386	417	209	159	178	207	231
	24"	1 ½"	170	187	424	458	247	197	221	256	287
	36"	1 ½"	200	220	462	499	315	235	263	306	342
	48"	1 ½"	230	253	500	540	353	273	306	355	398
	60"	1 ½"	260	286	535	577	364	284	318	369	413
<b>RM3342</b>	72"	1 ½"	290	319	569	615	374	294	329	382	428
	84"	1 ½"	320	352	650	701	406	326	365	423	475
	96"	1 ½"			730	788	437	357	400	464	520

Push Bars - Flat Ends											
Part	Max OA	Dia.	28/628	313/710 315/711	3/605 4/606	10/612 10B/613	Stock PC 10BE	32D/630	32/629	32D316	32316
<b>RM3102</b>	Up to 36" CTC	1"	197	210	394	426	284	204	228	265	296
<b>RM3112</b>	Up to 36" CTC	1 ¼"	215	229	408	441	295	215	241	280	313
<b>RM3122</b>	Up to 36" CTC	1 ½"	236	294	393	424	307	227	254	295	330

Push Bars - Round Ends											
<b>RM3106</b>	Up to 36" CTC	1"	229	242	470	508	318	238	267	309	347
<b>RM3116</b>	Up to 36" CTC	1 ¼"	250	262	484	523	330	250	280	325	364
<b>RM3126</b>	Up to 36" CTC	1 ½"	268	282	475	513	353	273	306	355	398

- Add \$6/in. over 96".
- MP (Mid Post) - Add \$70 each (Recommended for maximum rigidity on long door pulls. See page 5 for guidelines.)

NOTE: Post location on push bars can be located ⅛" from end for narrow & medium stile doors and 1" from end for flush and wide stile doors.

## Quick Ship MegaTek - Straight PostMount Pulls

Straight Pulls - Flat Ends - Back-to-Back Mounting				
Part	CTC	OA	Dia.	32D/630
<b>RM3301BTB1224.32D</b>	12"	24"	1 ¼"	375
<b>RM3301BTB2436.32D</b>	24"	36"	1 ¼"	451
<b>RM3301BTB3648.32D</b>	36"	48"	1 ¼"	525
<b>RM3301BTB4860.32D</b>	48"	60"	1 ¼"	575
<b>RM3301BTB6072.32D</b>	60"	72"	1 ¼"	625
<b>RM3301BTB7284.32D</b>	72"	84"	1 ¼"	675
<b>RM3301BTB8496.32D</b>	84"	96"	1 ¼"	725

- Mounting included for both 1 ¾" wood or metal doors and ½" glass doors.

**ASSA ABLOY**

The global leader in  
door opening solutions

NeoMax - Post Mounted GripZone

Straight Pulls - Flat Ends						
Part	Max OA	Dia.	3/605	9/611	32/629	32316
<b>RM3400</b>	12"	1"	284	321	172	
	24"	1"	358	404	215	
	36"	1"	431	488	258	
	48"	1"	505	571	301	
	60"	1"	579	654	344	
	72"	1"	653	737	387	
	84"	1"	726	821	430	
96"	1"	800	904	473		
<b>RM3401</b>	12"	1 1/4"	314	355	184	267
	24"	1 1/4"	385	436	227	329
	36"	1 1/4"	457	516	270	392
	48"	1 1/4"	528	597	313	454
	60"	1 1/4"	600	678	356	516
	72"	1 1/4"	671	758	399	579
	84"	1 1/4"	743	839	442	641
96"	1 1/4"	814	920	485	703	
<b>RM3402</b>	12"	1 1/2"	373	421	208	
	24"	1 1/2"	440	497	254	
	36"	1 1/2"	507	573	301	
	48"	1 1/2"	574	649	347	
	60"	1 1/2"	641	724	394	
	72"	1 1/2"	708	800	440	
	84"	1 1/2"	775	876	487	
96"	1 1/2"	842	951	533		
Offset Pulls - Flat Ends						
<b>RM3410</b>	12"	1"	321	363	204	
	24"	1"	395	446	247	
	36"	1"	468	529	290	
	48"	1"	542	613	333	
	60"	1"	616	696	376	
	72"	1"	690	779	419	
	84"	1"	763	863	462	
96"	1"	837	946	505		
<b>RM3411</b>	12"	1 1/4"	351	397	216	
	24"	1 1/4"	422	477	259	
	36"	1 1/4"	494	558	302	
	48"	1 1/4"	565	639	345	
	60"	1 1/4"	637	719	388	
	72"	1 1/4"	708	800	431	
	84"	1 1/4"	780	881	474	
96"	1 1/4"	851	962	517		
<b>RM3412</b>	12"	1 1/2"	410	463	240	
	24"	1 1/2"	477	539	286	
	36"	1 1/2"	544	615	333	
	48"	1 1/2"	611	690	379	
	60"	1 1/2"	678	766	426	
	72"	1 1/2"	745	842	472	
	84"	1 1/2"	812	918	519	
96"	1 1/2"	879	993	565		

Straight Pulls - Round Ends						
Part	Max OA	Dia.	3/605	9/611	32/629	32316
<b>RM3420</b>	12"	1"	364	411	206	
	24"	1"	438	495	249	
	36"	1"	511	578	292	
	48"	1"	585	661	335	
	60"	1"	659	745	378	
	72"	1"	733	828	421	
	84"	1"	806	911	464	
96"	1"	880	994	507		
<b>RM3421</b>	12"	1 1/4"	394	445	218	
	24"	1 1/4"	465	526	261	
	36"	1 1/4"	537	607	304	
	48"	1 1/4"	608	687	347	
	60"	1 1/4"	680	768	390	
	72"	1 1/4"	751	849	433	
	84"	1 1/4"	823	930	476	
96"	1 1/4"	894	1010	519		
<b>RM3422</b>	12"	1 1/2"	453	512	242	
	24"	1 1/2"	520	588	288	
	36"	1 1/2"	587	663	335	
	48"	1 1/2"	654	739	381	
	60"	1 1/2"	721	815	428	
	72"	1 1/2"	788	890	474	
	84"	1 1/2"	855	966	521	
96"	1 1/2"	922	1042	567		
Offset Pulls - Round Ends						
<b>RM3430</b>	12"	1"	401	453	238	
	24"	1"	475	536	281	
	36"	1"	548	620	324	
	48"	1"	622	703	367	
	60"	1"	696	786	410	
	72"	1"	770	870	453	
	84"	1"	843	953	496	
96"	1"	917	1036	539		
<b>RM3431</b>	12"	1 1/4"	432	488	250	
	24"	1 1/4"	503	569	293	
	36"	1 1/4"	575	650	336	
	48"	1 1/4"	646	730	379	
	60"	1 1/4"	718	811	422	
	72"	1 1/4"	789	892	465	
	84"	1 1/4"	861	972	508	
96"	1 1/4"	932	1053	551		
<b>RM3432</b>	12"	1 1/2"	490	554	274	
	24"	1 1/2"	557	629	320	
	36"	1 1/2"	624	705	367	
	48"	1 1/2"	691	781	413	
	60"	1 1/2"	758	857	460	
	72"	1 1/2"	825	932	506	
	84"	1 1/2"	892	1008	553	
96"	1 1/2"	959	1084	599		

- Add 5/6 in. over 96".
- MP (Mid Post) - Add \$70 each (Recommended for maximum rigidity on long door pulls. See page 5 for guidelines.)

**ASSA ABLOY**

The global leader in door opening solutions

Prices Effective September 1, 2017

Copyright © 2017, Rockwood Manufacturing Company, an ASSA ABLOY Group company. All rights reserved. Reproduction in whole or in part without the express written permission of Rockwood Manufacturing Company is prohibited.

## NeoMax - Post Mounted GripZone (con't)

Straight Pulls - Bent Ends (Specify CTC.)						
Part	CTC	Dia.	3/605	9/611	32/629	32316
<b>RM3440</b>	12"	1"	314	355	202	
	24"	1"	388	438	245	
	36"	1"	461	521	288	
	48"	1"	535	605	331	
	60"	1"	609	688	374	
	72"	1"	683	771	417	
<b>RM3441</b>	12"	1 1/4"	344	389	214	310
	24"	1 1/4"	415	469	257	373
	36"	1 1/4"	487	550	300	435
	48"	1 1/4"	558	631	343	497
	60"	1 1/4"	630	712	386	560
	72"	1 1/4"	701	792	429	622
<b>RM3442</b>	12"	1 1/2"	403	455	238	
	24"	1 1/2"	470	531	284	
	36"	1 1/2"	537	607	331	
	48"	1 1/2"	604	683	377	
	60"	1 1/2"	671	758	424	
	72"	1 1/2"	738	834	470	
<b>RM3442</b>	84"	1 1/2"	805	910	517	
	96"	1 1/2"	872	985	563	

## LineaMet - Contrasting Grooved Pulls

Straight Pulls - Flat Ends							
Part	Max OA	Dia.	3/605 4/606	10/612 10B/613	Stock PC 10BE	32D/630	32/629
<b>RM3510-8</b>	12"	1 1/4"	600	649	429	349	391
<b>RM3510-11</b>	15"	1 1/4"	611	659	447	367	411
<b>RM3510-16</b>	20"	1 1/4"	620	669	460	380	426
<b>RM3520-11</b>	15"	1 1/2"	723	781	466	386	432
<b>RM3520-16</b>	20"	1 1/2"	765	826	504	404	452
<b>RM3520-20</b>	24"	1 1/2"	806	871	520	420	471
Offset Pulls - Flat Ends							
<b>RM3540-8</b>	12"	1 1/4"	651	703	474	394	441
<b>RM3540-11</b>	15"	1 1/4"	662	715	511	411	461
<b>RM3540-16</b>	20"	1 1/4"	674	728	523	423	475
<b>RM3550-11</b>	15"	1 1/2"	776	838	529	429	481
<b>RM3550-16</b>	20"	1 1/2"	818	883	547	447	501
<b>RM3550-20</b>	24"	1 1/2"	858	927	563	463	519
Straight Pulls - Round Ends							
<b>RM3514-8</b>	12"	1 1/4"	651	703	474	394	441
<b>RM3514-11</b>	15"	1 1/4"	662	715	511	411	461
<b>RM3514-16</b>	20"	1 1/4"	674	728	523	423	475
<b>RM3524-11</b>	15"	1 1/2"	776	838	529	429	481
<b>RM3524-16</b>	20"	1 1/2"	818	883	547	447	501
<b>RM3524-20</b>	24"	1 1/2"	858	927	563	463	519

Offset Pulls - Round Ends							
Part	Max OA	Dia.	3/605 4/606	10/612 10B/613	Stock PC 10BE	32D/630	32/629
<b>RM3544-8</b>	12"	1 1/4"	703	759	537	437	490
<b>RM3544-11</b>	15"	1 1/4"	713	771	554	454	509
<b>RM3544-16</b>	20"	1 1/4"	723	781	566	466	522
<b>RM3554-11</b>	15"	1 1/2"	826	891	572	472	528
<b>RM3554-16</b>	20"	1 1/2"	868	937	590	490	548
<b>RM3554-20</b>	24"	1 1/2"	910	982	606	506	567

Push Bars - Flat Ends							
Part	CTC	Dia.	3/605 4/606	10/612 10B/613	Stock PC 10BE	32D/630	32/629
<b>RM3512</b>	Up to 36"	1 1/4"	806	871	537	437	490
<b>RM3522</b>	Up to 36"	1 1/2"	930	1005	588	488	547
Push Bars - Round Ends							
<b>RM3516</b>	Up to 36"	1 1/4"	858	927	582	482	540
<b>RM3526</b>	Up to 36"	1 1/2"	981	1059	632	532	596

NOTE: Post location on push bars can be located 1/8" from end for narrow & medium stile doors and 1" from end for flush and wide stile doors.

## LineaTek - Fully Grooved Pulls

Straight Pulls - Flat Ends							
Part	Max OA	Dia.	3/605 4/606	10/612 10B/613	Stock PC 10BE	32D/630	32/629
RM3610-8	13"	1 1/4"	431	466	336	256	287
RM3610-11	16"	1 1/4"	442	477	349	269	301
RM3610-16	21"	1 1/4"	451	486	360	280	314
RM3620-11	16"	1 1/2"	470	508	372	292	327
RM3620-16	21"	1 1/2"	490	529	380	300	336
RM3620-20	25"	1 1/2"	508	549	387	307	344
Offset Pulls - Flat Ends							
RM3640-8	13"	1 1/4"	481	519	378	298	334
RM3640-11	16"	1 1/4"	491	530	391	311	348
RM3640-16	21"	1 1/4"	500	541	405	325	364
RM3650-11	16"	1 1/2"	520	561	413	333	373
RM3650-16	21"	1 1/2"	541	584	423	343	384
RM3650-20	25"	1 1/2"	560	605	432	352	394
Straight Pulls - Round Ends							
RM3614-8	13"	1 1/4"	539	583	387	307	344
RM3614-11	16"	1 1/4"	550	593	396	316	354
RM3614-16	21"	1 1/4"	560	605	404	324	363
RM3624-11	16"	1 1/2"	587	634	437	357	400
RM3624-16	21"	1 1/2"	607	656	447	367	411
RM3624-20	25"	1 1/2"	627	677	456	376	421
Offset Pulls - Round Ends							
RM3644-8	13"	1 1/4"	587	634	432	352	394
RM3644-11	16"	1 1/4"	597	645	446	366	410
RM3644-16	21"	1 1/4"	607	656	461	381	427
RM3654-11	16"	1 1/2"	637	688	502	402	450
RM3654-16	21"	1 1/2"	657	710	510	410	459
RM3654-20	25"	1 1/2"	676	730	518	418	468

Push Bars - Flat Ends							
Part	CTC	Dia.	3/605 4/606	10/612 10B/613	Stock PC 10BE	32D/630	32/629
RM3612	Up to 36"	1 1/4"	568	614	437	357	400
RM3622	Up to 36"	1 1/2"	607	656	456	376	421
Push Bars - Round Ends							
RM3616	Up to 36"	1 1/4"	676	730	509	409	458
RM3626	Up to 36"	1 1/2"	723	781	542	442	495

- Add \$7.50/in. over 36".

NOTE: Post location on push bars can be located 1/8" from end for narrow & medium stile doors and 1" from end for flush and wide stile doors.

# ASSA ABLOY

The global leader in  
door opening solutions

Prices Effective September 1, 2017

Copyright © 2017, Rockwood Manufacturing Company, an ASSA ABLOY Group company. All rights reserved.  
Reproduction in whole or in part without the express written permission of Rockwood Manufacturing Company is prohibited.

## LineaMax - Long Grooved Pulls

Straight Pulls - Solid Flat Ends							
Part	Max OA	Dia.	3/605 4/606	10/612 10B/613	Stock PC 10BE	32D/630	32/629
<b>RM3701</b>	36" - 48"	1 1/4"	910	982	720	620	694
	48" - 72"	1 1/4"	1073	1159	810	710	795
	72" - 96"	1 1/4"	1444	1559	1009	889	996
<b>RM3702</b>	36" - 48"	1 1/2"	1136	1227	793	693	776
	48" - 72"	1 1/2"	1280	1382	882	782	876
	72" - 96"	1 1/2"	1631	1761	1097	977	1094
Offset Pulls - Solid Flat Ends							
<b>RM3711</b>	36" - 48"	1 1/4"	963	1040	768	668	748
	48" - 72"	1 1/4"	1127	1217	855	755	846
	72" - 96"	1 1/4"	1498	1618	1053	933	1045
<b>RM3712</b>	36" - 48"	1 1/2"	1187	1282	837	737	825
	48" - 72"	1 1/2"	1333	1440	945	825	924
	72" - 96"	1 1/2"	1682	1817	1140	1020	1142
Straight Pulls - Fully Grooved Flat Ends							
<b>RM3721</b>	36" - 48"	1 1/4"	703	759	615	515	577
	48" - 72"	1 1/4"	872	942	720	620	694
	72" - 96"	1 1/4"	1220	1318	864	764	856
<b>RM3722</b>	36" - 48"	1 1/2"	743	803	686	586	656
	48" - 72"	1 1/2"	910	982	810	710	795
	72" - 96"	1 1/2"	1302	1406	956	836	936
Offset Pulls - Fully Grooved Flat Ends							
<b>RM3731</b>	36" - 48"	1 1/4"	756	817	660	560	627
	48" - 72"	1 1/4"	921	995	768	668	748
	72" - 96"	1 1/4"	1271	1372	929	809	906
<b>RM3732</b>	36" - 48"	1 1/2"	795	858	733	633	709
	48" - 72"	1 1/2"	963	1040	855	755	846
	72" - 96"	1 1/2"	1354	1462	998	878	983
Straight Pulls - Solid Round Ends							
<b>RM3751</b>	36" - 48"	1 1/4"	963	1040	768	668	748
	48" - 72"	1 1/4"	1127	1217	855	755	846
	72" - 96"	1 1/4"	1498	1618	1053	933	1045
<b>RM3752</b>	36" - 48"	1 1/2"	1187	1282	837	737	825
	48" - 72"	1 1/2"	1333	1440	945	825	924
	72" - 96"	1 1/2"	1682	1817	1140	1020	1142
Offset Pulls - Solid Round Ends							
<b>RM3761</b>	36" - 48"	1 1/4"	1014	1096	810	710	795
	48" - 72"	1 1/4"	1178	1272	899	799	895
	72" - 96"	1 1/4"	1549	1673	1097	977	1094
<b>RM3762</b>	36" - 48"	1 1/2"	1239	1337	882	782	876
	48" - 72"	1 1/2"	1383	1494	992	872	977
	72" - 96"	1 1/2"	1737	1876	1184	1064	1192

Straight Pulls - Fully Grooved Round Ends							
Part	Max OA	Dia.	3/605 4/606	10/612 10B/613	Stock PC 10BE	32D/630	32/629
<b>RM3771</b>	36" - 48"	1 1/4"	817	882	669	569	637
	48" - 72"	1 1/4"	981	1059	775	675	756
	72" - 96"	1 1/4"	1333	1440	938	818	916
<b>RM3772</b>	36" - 48"	1 1/2"	872	942	757	657	736
	48" - 72"	1 1/2"	1034	1117	882	782	876
	72" - 96"	1 1/2"	1425	1539	1027	907	1016
Offset Pulls - Fully Grooved Round Ends							
<b>RM3781</b>	36" - 48"	1 1/4"	872	942	713	613	687
	48" - 72"	1 1/4"	1034	1117	820	720	806
	72" - 96"	1 1/4"	1383	1494	980	860	963
<b>RM3782</b>	36" - 48"	1 1/2"	921	995	802	702	786
	48" - 72"	1 1/2"	1086	1173	945	825	924
	72" - 96"	1 1/2"	1478	1596	1070	950	1064
Straight Pulls - Fully Grooved Bent Ends							
<b>RM3741</b>	36" - 48"	1 1/4"				497	557
	48" - 72"	1 1/4"				551	617
	72" - 96"	1 1/4"				710	795
<b>RM3742</b>	36" - 48"	1 1/2"				569	637
	48" - 72"	1 1/2"				638	715
	72" - 96"	1 1/2"				799	895

- Add \$7.50/in. over 96".
- MP (Mid Post) - Add \$63 each (Recommended for maximum rigidity on long door pulls. See page 5 for guidelines).

NoirMet - Black Anodized Grip with Contrasting Ends and Posts

Straight Pulls - Flat Ends									
Part	Max OA	Dia.	3/605 4/606	10/612 10B/613	Stock PC 10BE	32D	32/629	32D316	32316
<b>RM3800</b>	12"	1"	291	336	304	224	246	291	320
	24"	1"	317	361	325	245	270	319	351
	36"	1"	328	372	338	258	284	335	369
	48"	1"	488	533	418	338	372	439	484
	60"	1"	530	567	437	357	393	464	511
	72"	1"	571	601	455	375	413	488	537
	84"	1"	653	690	500	400	440	520	572
	96"	1"	734	778	524	424	466	551	606
	<b>RM3810</b>	12"	1 1/4"	306	350	310	230	253	299
24"		1 1/4"	350	378	338	258	284	335	369
36"		1 1/4"	363	392	351	271	298	352	387
48"		1 1/4"	489	533	432	352	387	458	503
60"		1 1/4"	516	553	446	366	403	476	524
72"		1 1/4"	543	573	460	380	418	494	543
84"		1 1/4"	646	675	526	426	469	554	610
96"		1 1/4"	749	776	571	471	518	612	673
<b>RM3820</b>		12"	1 1/2"	379	407	351	271	298	352
	24"	1 1/2"	422	450	373	293	322	381	419
	36"	1 1/2"	458	487	404	324	356	421	463
	48"	1 1/2"	521	535	461	381	419	495	545
	60"	1 1/2"	569	584	509	409	450	532	585
	72"	1 1/2"	616	632	536	436	480	567	624
	84"	1 1/2"	706	721	582	482	530	627	689
	96"	1 1/2"	795	810	628	528	581	686	755
	Offset Pulls - Flat Ends								
<b>RM3830</b>	12"	1"	328	407	338	258	284	335	369
	24"	1"	389	462	378	298	328	387	426
	36"	1"	459	522	418	338	372	439	484
	48"	1"	528	583	458	378	416	491	541
	60"	1"	570	617	477	397	437	516	568
	72"	1"	611	651	515	415	457	540	594
	84"	1"	693	740	550	450	495	585	644
	96"	1"	774	828	584	484	532	629	692
	<b>RM3840</b>	12"	1 1/4"	342	422	344	264	290	343
24"		1 1/4"	411	473	384	304	334	395	434
36"		1 1/4"	470	528	423	343	377	446	490
48"		1 1/4"	529	583	462	382	420	497	546
60"		1 1/4"	556	603	476	396	436	515	567
72"		1 1/4"	583	623	510	410	451	533	586
84"		1 1/4"	686	725	556	456	502	593	653
96"		1 1/4"	789	826	601	501	551	651	716
<b>RM3850</b>		12"	1 1/2"	414	480	386	306	337	398
	24"	1 1/2"	458	522	404	324	356	421	463
	36"	1 1/2"	510	554	448	368	405	478	527
	48"	1 1/2"	561	585	511	411	452	534	588
	60"	1 1/2"	609	634	539	439	483	571	628
	72"	1 1/2"	656	682	566	466	513	606	667
	84"	1 1/2"	746	771	612	512	563	666	732
	96"	1 1/2"	835	860	658	558	614	725	798

**ASSA ABLOY**

The global leader in  
door opening solutions

Prices Effective September 1, 2017

Copyright © 2017, Rockwood Manufacturing Company, an ASSA ABLOY Group company. All rights reserved.  
Reproduction in whole or in part without the express written permission of Rockwood Manufacturing Company is prohibited.



NoirMet - Black Anodized Grip with Contrasting Ends and Posts (con't)

Straight Pulls - Round Ends									
Part	Max OA	Dia.	3/605 4/606	10/612 10B/613	Stock PC 10BE	32D	32/629	32D316	32316
<b>RM3804</b>	12"	1"	328	372	338	258	284	335	369
	24"	1"	353	397	362	282	310	367	403
	36"	1"	363	407	373	293	322	381	419
	48"	1"	525	569	458	378	416	491	541
	60"	1"	566	603	477	397	437	516	568
	72"	1"	606	636	516	416	458	541	595
	84"	1"	687	724	551	451	496	586	645
	96"	1"	767	811	585	485	534	631	694
<b>RM3814</b>	12"	1 1/4"	342	386	344	264	290	343	377
	24"	1 1/4"	387	415	372	292	321	380	417
	36"	1 1/4"	401	429	386	306	337	398	438
	48"	1 1/4"	526	570	464	384	422	499	549
	60"	1 1/4"	553	589	478	398	438	517	569
	72"	1 1/4"	579	608	512	412	453	536	589
	84"	1 1/4"	681	710	558	458	504	595	655
	96"	1 1/4"	783	812	603	503	553	654	719
<b>RM3824</b>	12"	1 1/2"	414	444	386	306	337	398	438
	24"	1 1/2"	458	487	404	324	356	421	463
	36"	1 1/2"	493	522	439	359	395	467	514
	48"	1 1/2"	556	572	512	412	453	536	589
	60"	1 1/2"	604	620	540	440	484	572	629
	72"	1 1/2"	652	667	567	467	514	607	668
	84"	1 1/2"	740	755	611	511	562	664	731
	96"	1 1/2"	828	843	655	555	611	722	794
Offset Pulls - Round Ends									
<b>RM3834</b>	12"	1"	363	392	373	293	322	381	419
	24"	1"	426	460	412	332	365	432	475
	36"	1"	496	536	450	370	407	481	529
	48"	1"	565	610	508	408	449	530	584
	60"	1"	606	654	527	427	470	555	611
	72"	1"	646	698	546	446	491	580	638
	84"	1"	727	785	581	481	529	625	688
	96"	1"	807	872	615	515	577	670	750
<b>RM3844</b>	12"	1 1/4"	379	409	378	298	334	387	434
	24"	1 1/4"	447	483	417	337	377	438	490
	36"	1 1/4"	507	548	456	376	421	489	547
	48"	1 1/4"	566	611	514	414	464	538	603
	60"	1 1/4"	593	640	528	428	479	556	623
	72"	1 1/4"	619	669	542	442	495	575	644
	84"	1 1/4"	721	779	588	488	547	634	711
	96"	1 1/4"	823	889	633	533	597	693	776
<b>RM3854</b>	12"	1 1/2"	450	486	419	339	380	441	494
	24"	1 1/2"	493	532	439	359	402	467	523
	36"	1 1/2"	545	589	501	401	449	521	584
	48"	1 1/2"	596	644	542	442	495	575	644
	60"	1 1/2"	644	696	570	470	526	611	684
	72"	1 1/2"	692	747	597	497	557	646	724
	84"	1 1/2"	780	842	642	542	607	705	789
	96"	1 1/2"	868	937	687	587	657	763	854
Push Bars - Flat Ends									
Part	CTC	Dia.	3/605 4/606	10/612 10B/613	Stock PC 10BE	32D	32/629	32D316	32316
<b>RM3802</b>	Up to 36"	1"	328	354	338	258	289	335	376
<b>RM3812</b>	Up to 36"	1 1/4"	363	392	351	271	304	352	395
<b>RM3822</b>	Up to 36"	1 1/2"	458	495	404	324	363	421	472
Push Bars - Round Ends									
<b>RM3806</b>	Up to 36"	1"	363	392	373	293	328	381	426
<b>RM3816</b>	Up to 36"	1 1/4"	401	433	386	306	343	398	446
<b>RM3826</b>	Up to 36"	1 1/2"	493	532	439	359	402	467	523

• Add \$6/in. over 36".

NOTE: Post location on push bars can be located 1/8" from end for narrow & medium stile doors and 1" from end for flush and wide stile doors.

**ASSA ABLOY**

The global leader in  
door opening solutions

Prices Effective September 1, 2017

Copyright © 2017, Rockwood Manufacturing Company, an ASSA ABLOY Group company. All rights reserved.  
Reproduction in whole or in part without the express written permission of Rockwood Manufacturing Company is prohibited.

NoirTek - Black Anodized Grip with Contrasting Posts

Straight Pulls - Flat Ends									
Part	Max OA	Dia.	28/628	313/710 315/711	3/605 4/606	10/612 10B/613	Stock PC 10BE	32D/630	32/629
RM3900-8	13"	1"	146	146	173	187	187	143	160
RM3900-10	15"	1"	151	151	178	192	192	148	166
RM3900-12	17"	1"	156	156	183	198	198	153	171
RM3910-8	13"	1 ¼"	160	160	188	203	203	156	175
RM3910-11	16"	1 ¼"	166	166	194	210	210	162	181
RM3910-16	21"	1 ¼"	172	172	200	216	216	168	188
RM3920-11	16"	1 ½"	190	190	207	224	224	175	196
RM3920-16	21"	1 ½"	197	197	214	231	231	182	204
RM3920-20	25"	1 ½"	204	204	221	239	239	189	212
Offset Pulls - Flat Ends									
RM3930-8	13"	1"			208	225	225	175	196
RM3930-10	15"	1"			213	230	230	180	202
RM3930-12	17"	1"			218	235	235	185	207
RM3940-8	13"	1 ¼"			222	240	237	187	209
RM3940-11	16"	1 ¼"			228	246	243	193	216
RM3940-16	21"	1 ¼"			234	253	249	199	223
RM3950-11	16"	1 ½"			236	255	255	201	225
RM3950-16	21"	1 ½"			243	262	262	208	233
RM3950-20	25"	1 ½"			250	270	270	215	241
Straight Pulls - Round Ends									
RM3904-8	13"	1"	181	181	208	225	225	175	196
RM3904-10	15"	1"	186	186	213	230	230	180	202
RM3904-12	17"	1"	191	191	218	235	235	185	207
RM3914-8	13"	1 ¼"	195	195	222	240	237	187	209
RM3914-11	16"	1 ¼"	201	201	228	246	243	193	216
RM3914-16	21"	1 ¼"	207	207	234	253	249	199	223
RM3924-11	16"	1 ½"	225	225	236	255	255	201	225
RM3924-16	21"	1 ½"	232	232	243	262	262	208	233
RM3924-20	25"	1 ½"	239	239	251	271	271	215	241
Offset Pulls - Round Ends									
RM3934-8	13"	1"			243	262	262	207	232
RM3934-10	15"	1"			248	268	268	212	237
RM3934-12	17"	1"			253	273	273	217	243
RM3944-8	13"	1 ¼"			257	278	278	220	246
RM3944-11	16"	1 ¼"			263	284	284	226	253
RM3944-16	21"	1 ¼"			269	291	291	232	260
RM3954-11	16"	1 ½"			272	294	294	239	268
RM3954-16	21"	1 ½"			279	301	301	246	276
RM3954-20	25"	1 ½"			286	309	309	253	283
Push Bars - Flat Ends									
Part	CTC	Dia.	28/628	313/710 315/711	3/605 4/606	10/612 10B/613	Stock PC 10BE	32D/630	32/629
RM3902	Up to 36"	1"	190	190	200	216	216	168	188
RM3912	Up to 36"	1 ¼"	203	203	215	232	231	181	203
RM3922	Up to 36"	1 ½"	275	275	286	309	309	246	276
Push Bars - Round Ends									
RM3906	Up to 36"	1"	225	225	236	255	255	201	225
RM3916	Up to 36"	1 ¼"	239	239	251	271	271	213	239
RM3926	Up to 36"	1 ½"	311	311	322	348	348	279	312

- Add 5/16" over 36".

NOTE: Post location on push bars can be located 1/8" from end for narrow & medium stile doors and 1" from end for flush and wide stile doors.

**ASSA ABLOY**

The global leader in door opening solutions

Prices Effective September 1, 2017

Copyright © 2017, Rockwood Manufacturing Company, an ASSA ABLOY Group company. All rights reserved. Reproduction in whole or in part without the express written permission of Rockwood Manufacturing Company is prohibited.

## ArborMet - Wood Grip Pulls

Straight Pulls - Flat Ends							
Part	Max OA	Dia.	3/605 4/606	10/612 10B/613	Stock PC 10BE	32D/630	32/629
RM4000-8	12"	1"	388	419	395	315	347
RM4000-10	14"	1"	396	428	402	322	354
RM4000-12	16"	1"	408	440	409	329	361
RM4010-8	12"	1 1/4"	405	437	395	315	347
RM4010-11	15"	1 1/4"	414	447	411	331	364
RM4010-16	20"	1 1/4"	421	455	426	346	381
RM4020-11	15"	1 1/2"	472	510	455	375	412
RM4020-16	20"	1 1/2"	489	528	472	392	431
RM4020-20	24"	1 1/2"	505	545	508	408	449
Offset Pulls - Flat Ends							
RM4030-8	12"	1"	431	465	433	353	388
RM4030-10	14"	1"	440	475	441	361	398
RM4030-12	16"	1"	450	486	449	369	406
RM4040-8	12"	1 1/4"	447	483	433	353	388
RM4040-11	15"	1 1/4"	456	492	449	369	406
RM4040-16	20"	1 1/4"	463	500	465	385	423
RM4050-11	15"	1 1/2"	514	555	516	416	457
RM4050-16	20"	1 1/2"	530	572	531	431	475
RM4050-20	24"	1 1/2"	546	590	546	446	491
Straight Pulls - Round Ends							
RM4004-8	12"	1"	481	519	440	360	396
RM4004-10	14"	1"	489	528	448	368	405
RM4004-12	16"	1"	501	541	455	375	412
RM4014-8	12"	1 1/4"	498	538	440	360	396
RM4014-11	15"	1 1/4"	507	548	456	376	414
RM4014-16	20"	1 1/4"	514	555	471	391	430
RM4024-11	15"	1 1/2"	572	618	539	439	482
RM4024-16	20"	1 1/2"	589	636	554	454	499
RM4024-20	24"	1 1/2"	605	653	569	469	515
Offset Pulls - Round Ends							
RM4034-8	12"	1"	523	565	500	400	440
RM4034-10	14"	1"	531	573	508	408	449
RM4034-12	16"	1"	542	585	516	416	457
RM4044-8	12"	1 1/4"	539	582	500	400	440
RM4044-11	15"	1 1/4"	548	592	516	416	457
RM4044-16	20"	1 1/4"	556	600	531	431	475
RM4054-11	15"	1 1/2"	616	665	578	478	526
RM4054-16	20"	1 1/2"	632	683	594	494	544
RM4054-20	24"	1 1/2"	648	700	609	509	560

- Long pull lengths available. Call factory for pricing.
- Additional fee may be included on Premium and Super Premium wood species.

Push Bars - Flat Ends							
Part	CTC	Dia.	3/605 4/606	10/612 10B/613	Stock PC 10BE	32D/630	32/629
RM4002	Up to 36"	1"	488	527	522	422	464
RM4012	Up to 36"	1 1/4"	505	545	539	439	482
RM4022	Up to 36"	1 1/2"	590	637	600	500	550
Push Bars - Round Ends							
RM4006	Up to 36"	1"	582	629	569	469	515
RM4016	Up to 36"	1 1/4"	598	646	585	485	534
RM4026	Up to 36"	1 1/2"	691	746	662	562	618

NOTE: Post location on push bars can be located 1/8" from end for narrow & medium stile doors and 1" from end for flush and wide stile doors.

## ArborTek - Wood Grip Pulls

Straight Pulls - Flat Ends							
Part	Max OA	Dia.	3/605 4/606	10/612 10B/613	Stock PC 10BE	32D/630	32/629
RM4100-8	13"	1"	270	292	292	220	247
RM4100-10	15"	1"	279	301	301	229	257
RM4100-12	17"	1"	283	305	305	233	261
RM4110-8	13"	1 1/4"	287	310	310	236	265
RM4110-11	16"	1 1/4"	295	319	319	252	283
RM4110-16	21"	1 1/4"	302	326	326	267	299
RM4120-11	16"	1 1/2"	339	366	360	280	313
RM4120-16	21"	1 1/2"	364	393	372	292	326
RM4120-20	25"	1 1/2"	388	419	395	315	353
Offset Pulls - Flat Ends							
RM4130-8	13"	1"	312	337	337	260	290
RM4130-10	15"	1"	321	347	347	267	299
RM4130-12	17"	1"	324	350	350	271	303
RM4140-8	13"	1 1/4"	328	354	354	275	307
RM4140-11	16"	1 1/4"	338	365	365	289	324
RM4140-16	21"	1 1/4"	347	375	375	304	340
RM4150-11	16"	1 1/2"	381	411	397	317	354
RM4150-16	21"	1 1/2"	406	438	409	329	368
RM4150-20	25"	1 1/2"	431	465	433	353	395
Straight Pulls - Round Ends							
RM4104-8	13"	1"	312	337	337	260	290
RM4104-10	15"	1"	321	347	347	267	299
RM4104-12	17"	1"	324	350	350	271	303
RM4114-8	13"	1 1/4"	328	354	354	275	307
RM4114-11	16"	1 1/4"	338	365	365	289	324
RM4114-16	21"	1 1/4"	347	375	375	304	340
RM4124-11	16"	1 1/2"	381	411	397	317	354
RM4124-16	21"	1 1/2"	406	438	409	329	368
RM4124-20	25"	1 1/2"	431	465	433	353	395
Offset Pulls - Round Ends							
RM4134-8	13"	1"	355	383	379	299	335
RM4134-10	15"	1"	364	393	387	307	345
RM4134-12	17"	1"	369	399	391	311	349
RM4144-8	13"	1 1/4"	373	403	395	315	353
RM4144-11	16"	1 1/4"	380	410	410	331	370
RM4144-16	21"	1 1/4"	388	419	419	346	387
RM4154-11	16"	1 1/2"	421	455	438	358	400
RM4154-16	21"	1 1/2"	447	483	449	369	413
RM4154-20	25"	1 1/2"	472	510	471	391	438

Push Bars - Flat Ends							
Part	CTC	Dia.	3/605 4/606	10/612 10B/613	Stock PC 10BE	32D/630	32/629
RM4112	Up to 36"	1 1/4"	405	437	426	346	387
RM4122	Up to 36"	1 1/2"	440	475	455	375	420
Push Bars - Round Ends							
RM4116	Up to 36"	1 1/4"	447	483	465	385	431
RM4126	Up to 36"	1 1/2"	481	519	516	416	465

NOTE: Post location on push bars can be located 1/8" from end for narrow & medium stile doors and 1" from end for flush and wide stile doors.

Wood Pulls with Collar Mount Posts							
Straight Pulls - Flat Ends							
Part	OA	Dia.	3/605 4/606	10/612 10B/613	Stock PC 10BE	32D/630	32/629
RM4160	12"	1"	423	457	453	373	418
	24"	1"	489	528	519	439	492
	36"	1"	554	598	584	504	564
	48"	1"	622	672	652	572	641
Straight Pulls - Flat Ends							
RM4170	12"	1 1/4"	430	464	460	380	426
	24"	1 1/4"	509	550	539	459	514
	36"	1 1/4"	587	634	617	537	601
	48"	1 1/4"	643	694	673	593	664
Offset Pulls - Flat Ends							
RM4180	12"	1"	469	507	499	419	469
	24"	1"	541	584	571	491	550
	36"	1"	613	662	643	563	631
	48"	1"	662	715	692	612	685
Offset Pulls - Flat Ends							
RM4190	12"	1 1/4"	474	512	504	424	475
	24"	1 1/4"	559	604	589	509	570
	36"	1 1/4"	644	696	674	594	665
	48"	1 1/4"	677	731	707	627	702

- Additional fee may be included on Premium and Super Premium wood species.

ASSA ABLOY

The global leader in  
door opening solutions

Prices Effective September 1, 2017

Copyright © 2017, Rockwood Manufacturing Company, an ASSA ABLOY Group company. All rights reserved.  
Reproduction in whole or in part without the express written permission of Rockwood Manufacturing Company is prohibited.

## SkewTek - Angled End Pulls

Straight Pull - Forward Segment									
Part	Max OA	Dia.	28/628	313/710 315/711	3/605 4/606	10/612 10B/613	Stock PC 10BE	32D/630	32/629
RM4200-11	16"	1 1/2"			544	587	474	394	442
Offset Pulls - Forward Segment									
RM4210LH-11	16"	1 1/2"			578	624	524	424	475
RM4210RH-11	16"	1 1/2"			578	624	524	424	475
Straight Pulls - Rectangular Posts									
RM4270-12	18"	2"	597	639	906		721	621	695
RM4270-24	30"	2"	653	697	990		792	692	776
Offset Pulls - Rectangular Posts									
RM4272-12	18"	2"	738	781	1046		840	740	828
RM4272-24	30"	2"	795	837	1129		932	812	909
Straight Pulls - Round Posts									
RM4274-12	18"	2"	597	639	906		721	621	695
RM4274-24	30"	2"	653	697	990		792	692	776

- Add 5/6" in. over 30".

## CenTek - Shaped Pulls

Part	CTC	3/605 4/606	10/612 10B/613	Stock PC 10BE	32D/630	32/629
RM4300	42"	799	863	679	579	649
RM4301	42"	851	919	726	626	702
RM4302	42"	1081	1167	933	813	911
RM4303	42"	883	954	757	657	736
RM4304	42"	883	954	757	657	736
RM4305	42"	1081	1167	933	813	911

## CenTrex - Shaped Pulls

Curved Pulls									
Part	CTC	28/628	313/710 315/711	3/605 4/606	10/612 108/613	Stock PC 10BE	26/625 26D/626	32D/630	32/629
RM4400-12	12"	319	336	482	521	409	482	329	368
RM4400-20	20"	332	349	534	577	422	534	342	384
Double Curved Pulls									
RM4402LH	12"	381	397	534	577	452	534	372	417
RM4402RH	12"	381	397	534	577	452	534	372	417
Straight Radius Pulls									
RM4410-12	12"	282	298	482	521	363	482	283	317
RM4410-18	18"	298	316	534	577	379	534	299	335
RM4410-24	24"	316	332	583	630	409	583	329	368
Offset Radius Pulls									
RM4412-12	12"	349	365	551	595	422	551	342	384
RM4412-18	18"	365	381	599	647	438	599	358	402
RM4412-24	24"	381	397	649	701	467	649	387	434
Semi-Circular Pulls									
RM4420	9"	217	233		433	305	401	225	251
RM4422	12"	233	250		450	321	417	241	269
Radius Push Bars									
RM4440LH	Up to 36"	414	431	733	792	622	733	522	584
RM4440RH	Up to 36"	414	431	733	792	622	733	522	584
Compound Radius Push Bars									
RM4450LH	Up to 36"	825	876	1049	1133	938	1049	818	917
RM4450RH	Up to 36"	825	876	1049	1133	938	1049	818	917
Semi-Circular Pulls									
RM4500	11"	332	349	667	720	501		401	448
RM4502	11"	332	349	667	720	501		401	448
RM4506	12"			434	469	393		313	350
Side Radius Pull									
RM4510	12"	365	397	500	540	452		372	417
Projecting Radius Pull									
RM4512	12"	431	463	733	792	576		476	533
Radius Push Bars									
RM4516LH	Up to 36"	446	479	649	701	531		431	483
RM4516RH	Up to 36"	446	479	649	701	531		431	483
Semi-Circular Pulls									
RM4550	12"			1115	1204	1204	1115		
RM4552	14"			900	972	972	900		

NOTE: Post location on push bars can be located 1/8" from end for narrow & medium stile doors and 1" from end for flush and wide stile doors.

**ASSA ABLOY**

The global leader in  
door opening solutions

Prices Effective September 1, 2017

Copyright © 2017, Rockwood Manufacturing Company, an ASSA ABLOY Group company. All rights reserved.  
Reproduction in whole or in part without the express written permission of Rockwood Manufacturing Company is prohibited.

## AccenTek - Solid Pulls with Accents

Cast Pulls									
Part	Grip	CTC	Stock PC 10BE	3/605 4/606	10/612 10A/722	10B/613 10BL/614	15/619 15A/620	20A/624	26/625 26D/626
RM4720	1 1/2" x 1/2" x 12 1/2"	8"	404	373	404	404	404	404	404
RM4700W	1 1/4" x 5/8" x 14"	10"	469	435	469	469	469	469	469
RM4700B	1 1/4" x 5/8" x 14"	10"	469	435	469	469	469	469	469
Formed Pulls with Distinguished Fastener Heads									
Part	Grip	CTC	Wrought Black	Stock PC 10BE	Black Suede	US32D	Industrial Steel		
RM4800	3/4" Dia	12"	340	340	340	315			
		16"	340	340	340	315	381		
		24"	418	418	418	387			
		36"	514	514	514	477			
RM4810	1 1/2" x 1/4"	12"	280	280	280	255			
		16"	280	280	280	255	314		
		24"	344	344	344	314			
		36"	424	424	424	386			
RM4820	1 1/2" x 3/16"	12"	340	340	340	315			
		16"	340	340	340	315	381		
		24"	418	418	418	387			
		36"	514	514	514	477			
RM4800 x RM4810		12"	620	620	620	570			
		16"	620	620	620	570	694		
		24"	763	763	763	701			
		36"	938	938	938	862			
RM4820 x RM4810		12"	620	620	620	570			
		16"	620	620	620	570	694		
		24"	763	763	763	701			
		36"	938	938	938	862			

- RM4700 pulls contain white or black polycarbonate insert.
- RM4800 series, US32D and 10BE come with Socket Head Screws. Other finishes come with Hex Head Screws.
- RM4800 series longer lengths may be offered, call factory for pricing.
- Specify CTC when ordering.

NOTE: Industrial Steel coming soon!

## SculpTrex - Shaped Cast Pulls

Part	CTC	3/605 4/606	10/612 10B/613	Stock PC 10BE	26/625 26D/626
RM5000	12"	577	623	623	577
RM5002	20"	643	695	695	643
RM5010	12"	577	623	623	577
RM5012	20"	643	695	695	643
RM5020LH	20"	696	753	753	696
RM5020RH	20"	696	753	753	696
RM5030	12"	596	643	643	596
RM5032	20"	663	716	716	663
RM5040	12"	596	643	643	596
RM5042	20"	663	716	716	663
RM5050LH	20"	714	772	772	714
RM5050RH	20"	714	772	772	714

Prices Effective September 1, 2017

Copyright © 2017, Rockwood Manufacturing Company, an ASSA ABLOY Group company. All rights reserved.  
Reproduction in whole or in part without the express written permission of Rockwood Manufacturing Company is prohibited.

**ASSA ABLOY**

The global leader in  
door opening solutions

PlanTek - Flat Front Pulls

Straight Cast Pulls								
Part	CTC	Grip Size	3/605 4/606	10/612 10B/613	Stock PC 10BE	26/625 26D/626	32D/630	32/629
RM5200-7	7"	1"	225	243	243	225		
RM5200-12	12"	1"	259	280	280	259		
RM5202	12"	1 1/4"	328	354	354	328		
Offset Cast Pulls								
RM5204-8	8"	1"	225	243	243	225		
RM5204-12	12"	1"	259	280	280	259		
Radius End Pulls								
RM5210-10	10"	1/2" x 1 1/4"	462	499	377		297	333
RM5210-12	12"	1/2" x 1 1/4"	480	518	392		312	349
RM5220-12	12"	3/4" x 1 1/2"	616	665	420		340	381
RM5220-18	18"	3/4" x 1 1/2"	686	741	465		385	431
Square End Pulls								
RM5230-10	10"	1/2" x 1 1/4"	428	462	304		224	251
RM5230-12	12"	1/2" x 1 1/4"	447	483	318		238	266
RM5240-12	12"	3/4" x 1 1/2"	566	612	333		253	283
RM5240-18	18"	3/4" x 1 1/2"	633	684	347		267	300
Bent End Pulls								
RM5250-10	10"	1/2" x 1 1/4"	345	372	289		209	234
RM5250-12	12"	1/2" x 1 1/4"	360	389	304		224	251
RM5260-12	12"	3/4" x 1 1/2"	462	499	347		267	300
RM5260-18	18"	3/4" x 1 1/2"	548	591	377		297	333
Radius End Pulls								
RM5270-10	10"	1/2" x 3/4"			363		283	317
RM5270-12	12"	1/2" x 3/4"			374		294	330
RM5270-16	16"	1/2" x 3/4"			401		321	360
Straight Cast Pull								
RM5280	9"	1/2" x 1/2"	105	113	113	105		
Push Bars - Radius Ends								
RM5212	Up to 36"	1/2" x 1 1/4"	633	684	449		369	414
RM5222	Up to 36"	3/4" x 1 1/2"	957	1034	618		518	580
Push Bars - Flat Ends								
RM5232	Up to 36"	1/2" x 1 1/4"	633	684	392		312	349
RM5242	Up to 36"	3/4" x 1 1/2"	941	1017	465		385	431

- Add 9/in. over 36".
- RM5200, RM5202, RM5204 CTC can not be modified.

NOTE: Post location on push bars can be located 1/8" from end for narrow & medium stile doors and 1" from end for flush and wide stile doors.



## Traditional - Decorative Pulls & Plates

Add pull price to plate price to make pull plate combination.

Cast Pulls							
Part	CTC	Base Plate	3/605 4/606	10/612 10B/613	Stock PC 10BE	15/619 15A/620	26/625 26D/626
RM5500	6"	no	85	91	91	95	85
RM5502	6 7/8"	yes	138	148	148	158	152
RM5510	12"	no	138	148	148	177	165
RM5512	12 7/8"	yes	193	209	209	244	220
Cast Pulls							
RM5520	8"	no	124	134	134	137	124
RM5522	8"	yes	152	163	163	163	152
Cast Pulls							
Part	Size		3/605 4/606	10/612 10B/613	Stock PC 10BE	15/619 15A/620	26/625 26D/626
RM5530	5 1/2"		43	47	47	53	43
RM5532	7 1/2"		63	68	68	72	67
RM5534	12"		187	201	201	197	187
Heavy Decorative Plates - .090" Thick							
RM5590A	3" x 12"		73	80	80	88	81
RM5590B	3 1/2" x 15"		81	87	87	93	89
RM5590C	4" x 16"		89	96	96	102	94
Heavy Decorative Plates - .090" Thick							
RM5592A	3" x 12"		73	80	80	88	81
RM5592B	3 1/2" x 15"		81	87	87	93	89
RM5592C	4" x 16"		89	96	96	102	94
Heavy Decorative Plates - .090" Thick							
RM5594B	3 1/2" x 15"		146	158	158	159	152
Rope Border Cast Plates							
RM5596A	3" x 12"		89	96	96	93	89
RM5596B	3 1/2" x 15"		103	111	111	108	103
Plain Cast Plate - 5/16" Thick							
RM5598B	3 1/2" x 15"		117	126	126	121	117

## Classic - Finial Door Pulls

1" Door Pulls								
Part	CTC	Grip	Base Plate	3/605 4/606	10/612 10B/613	Stock PC 10BE	15/619 15A/620	26/625 26D/626
RM5650	10"	Plain	no	313	338	338	368	345
RM5652	10"	Rope	no	313	338	338	368	345
RM5654	10"	Fluted	no	313	338	338	368	345
RM5660	10"	Plain	yes	350	377	377	406	382
RM5662	10"	Rope	yes	350	377	377	406	382
RM5664	10"	Fluted	yes	350	377	377	406	382
1" Offset Door Pull								
RM5670	10"	Plain	no	353	382	382	392	385

- To order suffix finial style number .
- Add 5/6/in. for longer pulls up to 36".

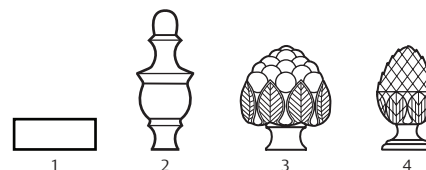

Finial Style Number (example: RM5650-4)

Suffix	Finial Style:
1	Plain
2	Urn
3	Berry
4	Pinecone

## MariTek - Tapered Pulls

Straight Door Pulls						
Part	CTC	3/605 4/606	10B/613	Stock PC 10BE	14/618 15/619	26/625 26D/626
RM5700	6"	231	249	249	237	245
RM5702	12"	245	264	264	251	258

English Bridle Leather Pulls

Straight Pulls - Flat Ends							
Part	Max OA	Dia.	3/605 4/606	10/612 10B/613	Stock PC 10BE	32D/630	32/629
<b>RM6000</b>	12"	1"	711	768	639	539	604
	24"	1"	1053	1138	933	813	911
	36"	1"	1396	1507	1207	1087	1217
	48"	1"	1738	1877	1483	1363	1527
	60"	1"	2094	2261	1759	1639	1836
	72"	1"	2449	2645	2035	1915	2145
	84"	1"	2647	2858	2140	2020	2262
	96"	1"	2844	3072	2246	2126	2381
<b>RM6010</b>	12"	1 1/4"	792	855	724	624	699
	24"	1 1/4"	1289	1392	1134	1014	1136
	36"	1 1/4"	1786	1929	1524	1404	1572
	48"	1 1/4"	2196	2372	1864	1744	1953
	60"	1 1/4"	2606	2814	2204	2084	2334
	72"	1 1/4"	2738	2957	2332	2212	2477
	84"	1 1/4"	2869	3099	2459	2339	2620
	96"	1 1/4"	3001	3241	2566	2446	2740
<b>RM6020</b>	12"	1 1/2"	902	974	814	714	800
	24"	1 1/2"	1439	1554	1257	1137	1273
	36"	1 1/2"	1975	2133	1680	1560	1747
	48"	1 1/2"	2410	2602	1878	1758	1969
	60"	1 1/2"	2844	3072	2076	1956	2191
	72"	1 1/2"	3002	3243	2275	2155	2413
	84"	1 1/2"	3161	3414	2473	2353	2635
	96"	1 1/2"	3319	3585	2671	2551	2857
Offset Pulls - Flat Ends							
<b>RM6030</b>	12"	1"	746	806	669	569	637
	24"	1"	1088	1175	963	843	944
	36"	1"	1431	1545	1237	1117	1251
	48"	1"	1773	1915	1513	1393	1560
	60"	1"	2129	2299	1789	1669	1869
	72"	1"	2484	2683	2065	1945	2178
	84"	1"	2682	2896	2170	2050	2296
	96"	1"	2879	3109	2276	2156	2415
<b>RM6040</b>	12"	1 1/4"	827	893	754	654	732
	24"	1 1/4"	1324	1430	1164	1044	1169
	36"	1 1/4"	1821	1967	1554	1434	1606
	48"	1 1/4"	2231	2409	1894	1774	1987
	60"	1 1/4"	2641	2852	2234	2114	2368
	72"	1 1/4"	2773	2994	2362	2242	2510
	84"	1 1/4"	2904	3137	2489	2369	2653
	96"	1 1/4"	3036	3279	2596	2476	2773
<b>RM6050</b>	12"	1 1/2"	937	1012	844	744	833
	24"	1 1/2"	1474	1591	1287	1167	1307
	36"	1 1/2"	2010	2171	1710	1590	1781
	48"	1 1/2"	2445	2640	1908	1788	2003
	60"	1 1/2"	2879	3109	2106	1986	2225
	72"	1 1/2"	3037	3280	2305	2185	2447
	84"	1 1/2"	3196	3451	2503	2383	2669
	96"	1 1/2"	3354	3622	2701	2581	2891

Straight Pulls - Round Ends							
Part	Max OA	Dia.	3/605 4/606	10/612 10B/613	Stock PC 10BE	32D/630	32/629
<b>RM6004</b>	12"	1"	787	850	674	574	643
	24"	1"	1053	1138	968	848	950
	36"	1"	1396	1507	1242	1122	1257
	48"	1"	1738	1877	1518	1398	1566
	60"	1"	2094	2261	1794	1674	1875
	72"	1"	2449	2645	2070	1950	2184
	84"	1"	2647	2858	2175	2055	2302
	96"	1"	2844	3072	2281	2161	2420
<b>RM6014</b>	12"	1 1/4"	792	855	759	659	738
	24"	1 1/4"	1289	1392	1169	1049	1175
	36"	1 1/4"	1786	1929	1559	1439	1612
	48"	1 1/4"	2196	2372	1899	1779	1992
	60"	1 1/4"	2606	2814	2239	2119	2373
	72"	1 1/4"	2738	2957	2367	2247	2516
	84"	1 1/4"	2869	3099	2494	2374	2659
	96"	1 1/4"	3001	3241	2601	2481	2779
<b>RM6024</b>	12"	1 1/2"	902	974	849	749	839
	24"	1 1/2"	1439	1554	1292	1172	1313
	36"	1 1/2"	1975	2133	1715	1595	1786
	48"	1 1/2"	2410	2602	1913	1793	2008
	60"	1 1/2"	2844	3072	2111	1991	2230
	72"	1 1/2"	3002	3243	2310	2190	2452
	84"	1 1/2"	3161	3414	2508	2388	2674
	96"	1 1/2"	3319	3585	2706	2586	2896
Offset Pulls - Round Ends							
<b>RM6034</b>	12"	1"	821	887	704	604	676
	24"	1"	1163	1256	998	878	983
	36"	1"	1506	1626	1272	1152	1290
	48"	1"	1848	1996	1548	1428	1599
	60"	1"	2204	2380	1824	1704	1908
	72"	1"	2559	2764	2100	1980	2218
	84"	1"	2757	2977	2205	2085	2335
	96"	1"	2954	3190	2311	2191	2454
<b>RM6044</b>	12"	1 1/4"	902	974	789	689	772
	24"	1 1/4"	1399	1511	1199	1079	1208
	36"	1 1/4"	1896	2048	1589	1469	1645
	48"	1 1/4"	2306	2490	1929	1809	2026
	60"	1 1/4"	2716	2933	2269	2149	2407
	72"	1 1/4"	2848	3075	2397	2277	2550
	84"	1 1/4"	2979	3218	2524	2404	2692
	96"	1 1/4"	3111	3360	2631	2511	2812
<b>RM6054</b>	12"	1 1/2"	1012	1093	879	779	872
	24"	1 1/2"	1549	1672	1322	1202	1346
	36"	1 1/2"	2085	2252	1745	1625	1820
	48"	1 1/2"	2520	2721	1943	1823	2042
	60"	1 1/2"	2954	3190	2141	2021	2264
	72"	1 1/2"	3112	3361	2340	2220	2486
	84"	1 1/2"	3271	3532	2538	2418	2708
	96"	1 1/2"	3429	3703	2736	2616	2930

- Add 5/6 in. over 96".
- MP (Mid Post) - Add 5/70 each. (Recommended for maximum rigidity on long door pulls. See page 5 for guidelines.)
- FW (Full Wrap) available up to 72" overall length pull - Call for pricing.
- Specify leather color.

NOTE: All long pulls include charge for leather between mounting posts up to a maximum of 72" of leather cover.

**ASSA ABLOY**

The global leader in door opening solutions

Prices Effective September 1, 2017

Copyright © 2017, Rockwood Manufacturing Company, an ASSA ABLOY Group company. All rights reserved. Reproduction in whole or in part without the express written permission of Rockwood Manufacturing Company is prohibited.

## English Bridle Leather Pulls (con't)

Straight Pulls - Flat Ends							
Part	Max OA	Dia.	3/605 4/606	10/612 10B/613	Stock PC 10BE	32D/630	32/629
<b>RM6060</b>	12"	1"	711	768	639	539	604
	24"	1"	1053	1138	933	813	911
	36"	1"	1396	1507	1207	1087	1217
	48"	1"	1738	1877	1483	1363	1527
	60"	1"	2094	2261	1759	1639	1836
	72"	1"	2449	2645	2035	1915	2145
	84"	1"	2647	2858	2140	2020	2262
	96"	1"	2844	3072	2246	2126	2381
<b>RM6061</b>	12"	1 1/4"	792	855	724	624	699
	24"	1 1/4"	1289	1392	1134	1014	1136
	36"	1 1/4"	1786	1929	1524	1404	1572
	48"	1 1/4"	2196	2372	1864	1744	1953
	60"	1 1/4"	2606	2814	2204	2084	2334
	72"	1 1/4"	2738	2957	2332	2212	2477
	84"	1 1/4"	2869	3099	2459	2339	2620
	96"	1 1/4"	3001	3241	2566	2446	2740
<b>RM6062</b>	12"	1 1/2"	902	974	814	714	800
	24"	1 1/2"	1439	1554	1257	1137	1273
	36"	1 1/2"	1975	2133	1680	1560	1747
	48"	1 1/2"	2410	2602	1878	1758	1969
	60"	1 1/2"	2844	3072	2076	1956	2191
	72"	1 1/2"	3002	3243	2275	2155	2413
	84"	1 1/2"	3161	3414	2473	2353	2635
	96"	1 1/2"	3319	3585	2671	2551	2857
Offset Pulls - Flat Ends							
<b>RM6070</b>	12"	1"	746	806	669	569	637
	24"	1"	1088	1175	963	843	944
	36"	1"	1431	1545	1237	1117	1251
	48"	1"	1773	1915	1513	1393	1560
	60"	1"	2129	2299	1789	1669	1869
	72"	1"	2484	2683	2065	1945	2178
	84"	1"	2682	2896	2170	2050	2296
	96"	1"	2879	3109	2276	2156	2415
<b>RM6071</b>	12"	1 1/4"	827	893	754	654	732
	24"	1 1/4"	1324	1430	1164	1044	1169
	36"	1 1/4"	1821	1967	1554	1434	1606
	48"	1 1/4"	2231	2409	1894	1774	1987
	60"	1 1/4"	2641	2852	2234	2114	2368
	72"	1 1/4"	2773	2994	2362	2242	2510
	84"	1 1/4"	2904	3137	2489	2369	2653
	96"	1 1/4"	3036	3279	2596	2476	2773
<b>RM6072</b>	12"	1 1/2"	937	1012	844	744	833
	24"	1 1/2"	1474	1591	1287	1167	1307
	36"	1 1/2"	2010	2171	1710	1590	1781
	48"	1 1/2"	2445	2640	1908	1788	2003
	60"	1 1/2"	2879	3109	2106	1986	2225
	72"	1 1/2"	3037	3280	2305	2185	2447
	84"	1 1/2"	3196	3451	2503	2383	2669
	96"	1 1/2"	3354	3622	2701	2581	2891

Straight Pulls - Round Ends							
Part	Max OA	Dia.	3/605 4/606	10/612 10B/613	Stock PC 10BE	32D/630	32/629
<b>RM6080</b>	12"	1"	787	850	674	574	643
	24"	1"	1053	1138	968	848	950
	36"	1"	1396	1507	1242	1122	1257
	48"	1"	1738	1877	1518	1398	1566
	60"	1"	2094	2261	1794	1674	1875
	72"	1"	2449	2645	2070	1950	2184
	84"	1"	2647	2858	2175	2055	2302
	96"	1"	2844	3072	2281	2161	2420
<b>RM6081</b>	12"	1 1/4"	792	855	759	659	738
	24"	1 1/4"	1289	1392	1169	1049	1175
	36"	1 1/4"	1786	1929	1559	1439	1612
	48"	1 1/4"	2196	2372	1899	1779	1992
	60"	1 1/4"	2606	2814	2239	2119	2373
	72"	1 1/4"	2738	2957	2367	2247	2516
	84"	1 1/4"	2869	3099	2494	2374	2659
	96"	1 1/4"	3001	3241	2601	2481	2779
<b>RM6082</b>	12"	1 1/2"	902	974	849	749	839
	24"	1 1/2"	1439	1554	1292	1172	1313
	36"	1 1/2"	1975	2133	1715	1595	1786
	48"	1 1/2"	2410	2602	1913	1793	2008
	60"	1 1/2"	2844	3072	2111	1991	2230
	72"	1 1/2"	3002	3243	2310	2190	2452
	84"	1 1/2"	3161	3414	2508	2388	2674
	96"	1 1/2"	3319	3585	2706	2586	2896
Offset Pulls - Round Ends							
<b>RM6090</b>	12"	1"	821	887	704	604	676
	24"	1"	1163	1256	998	878	983
	36"	1"	1506	1626	1272	1152	1290
	48"	1"	1848	1996	1548	1428	1599
	60"	1"	2204	2380	1824	1704	1908
	72"	1"	2559	2764	2100	1980	2218
	84"	1"	2757	2977	2205	2085	2335
	96"	1"	2954	3190	2311	2191	2454
<b>RM6091</b>	12"	1 1/4"	902	974	789	689	772
	24"	1 1/4"	1399	1511	1199	1079	1208
	36"	1 1/4"	1896	2048	1589	1469	1645
	48"	1 1/4"	2306	2490	1929	1809	2026
	60"	1 1/4"	2716	2933	2269	2149	2407
	72"	1 1/4"	2848	3075	2397	2277	2550
	84"	1 1/4"	2979	3218	2524	2404	2692
	96"	1 1/4"	3111	3360	2631	2511	2812
<b>RM6092</b>	12"	1 1/2"	1012	1093	879	779	872
	24"	1 1/2"	1549	1672	1322	1202	1346
	36"	1 1/2"	2085	2252	1745	1625	1820
	48"	1 1/2"	2520	2721	1943	1823	2042
	60"	1 1/2"	2954	3190	2141	2021	2264
	72"	1 1/2"	3112	3361	2340	2220	2486
	84"	1 1/2"	3271	3532	2538	2418	2708
	96"	1 1/2"	3429	3703	2736	2616	2930

- Add \$6/in. over 96".
- MP (Mid Post) - Add \$70 each. (Recommended for maximum rigidity on long door pulls. See page 5 for guidelines.)
- FW (Full Wrap) available up to 72" overall length pull - Call for pricing.
- Specify leather color.

NOTE: All long pulls include charge for leather between mounting posts up to a maximum of 72" of leather cover.

**ASSA ABLOY**

The global leader in  
door opening solutions

Upholstery Leather Pulls

Straight Pulls - Flat Ends							
Part	Max OA	Dia.	3/605 4/606	10/612 10B/613	Stock PC 10BE	32D/630	32/629
<b>RM6100</b>	12"	1"	633	684	581	481	539
	24"	1"	896	968	758	658	737
	36"	1"	1239	1338	1052	932	1044
	48"	1"	1581	1707	1328	1208	1353
	60"	1"	1827	1973	1488	1368	1532
	72"	1"	2182	2357	1764	1644	1841
	84"	1"	2331	2517	1857	1737	1945
	96"	1"	2528	2730	1963	1843	2064
<b>RM6110</b>	12"	1 1/4"	711	768	639	539	604
	24"	1 1/4"	1241	1340	1092	972	1089
	36"	1 1/4"	1738	1877	1482	1362	1525
	48"	1 1/4"	2148	2320	1822	1702	1906
	60"	1 1/4"	2449	2645	2076	1956	2191
	72"	1 1/4"	2581	2787	2204	2084	2334
	84"	1 1/4"	2712	2929	2302	2182	2444
	96"	1 1/4"	2844	3072	2409	2289	2564
<b>RM6120</b>	12"	1 1/2"	808	873	682	582	652
	24"	1 1/2"	1345	1453	1222	1102	1234
	36"	1 1/2"	1881	2031	1645	1525	1708
	48"	1 1/2"	2316	2501	1843	1723	1930
	60"	1 1/2"	2750	2970	2041	1921	2152
	72"	1 1/2"	2908	3141	2240	2120	2374
	84"	1 1/2"	3067	3312	2438	2318	2596
	96"	1 1/2"	3225	3483	2636	2516	2818
Offset Pulls - Flat Ends							
<b>RM6130</b>	12"	1"	668	721	611	511	572
	24"	1"	931	1005	788	688	771
	36"	1"	1274	1376	1082	962	1077
	48"	1"	1616	1745	1358	1238	1387
	60"	1"	1862	2011	1518	1398	1566
	72"	1"	2217	2394	1794	1674	1875
	84"	1"	2366	2555	1887	1767	1979
	96"	1"	2563	2768	1993	1873	2098
<b>RM6140</b>	12"	1 1/4"	746	806	669	569	637
	24"	1 1/4"	1276	1378	1122	1002	1122
	36"	1 1/4"	1773	1915	1512	1392	1559
	48"	1 1/4"	2183	2358	1852	1732	1940
	60"	1 1/4"	2484	2683	2106	1986	2224
	72"	1 1/4"	2616	2825	2234	2114	2367
	84"	1 1/4"	2747	2967	2332	2212	2477
	96"	1 1/4"	2879	3109	2439	2319	2597
<b>RM6150</b>	12"	1 1/2"	843	910	712	612	685
	24"	1 1/2"	1380	1490	1252	1132	1268
	36"	1 1/2"	1916	2069	1675	1555	1742
	48"	1 1/2"	2351	2539	1873	1753	1963
	60"	1 1/2"	2785	3008	2071	1951	2185
	72"	1 1/2"	2943	3178	2270	2150	2408
	84"	1 1/2"	3102	3350	2468	2348	2630
	96"	1 1/2"	3260	3521	2666	2546	2852

Straight Pulls - Round Ends							
Part	Max OA	Dia.	3/605 4/606	10/612 10B/613	Stock PC 10BE	32D/630	32/629
<b>RM6104</b>	12"	1"	708	765	616	516	578
	24"	1"	971	1049	793	693	776
	36"	1"	1314	1419	1087	967	1083
	48"	1"	1656	1788	1363	1243	1392
	60"	1"	1902	2054	1523	1403	1571
	72"	1"	2257	2438	1799	1679	1880
	84"	1"	2406	2598	1892	1772	1985
	96"	1"	2603	2811	1998	1878	2103
<b>RM6114</b>	12"	1 1/4"	786	849	674	574	643
	24"	1 1/4"	1316	1421	1127	1007	1128
	36"	1 1/4"	1813	1958	1517	1397	1565
	48"	1 1/4"	2223	2401	1857	1737	1945
	60"	1 1/4"	2524	2726	2111	1991	2230
	72"	1 1/4"	2656	2868	2239	2119	2373
	84"	1 1/4"	2787	3010	2337	2217	2483
	96"	1 1/4"	2919	3153	2444	2324	2603
<b>RM6124</b>	12"	1 1/2"	883	954	717	617	691
	24"	1 1/2"	1420	1534	1257	1137	1273
	36"	1 1/2"	1956	2112	1680	1560	1747
	48"	1 1/2"	2391	2582	1878	1758	1969
	60"	1 1/2"	2825	3051	2076	1956	2191
	72"	1 1/2"	2983	3222	2275	2155	2414
	84"	1 1/2"	3142	3393	2473	2353	2635
	96"	1 1/2"	3300	3564	2671	2551	2857
Offset Pulls - Round Ends							
<b>RM6134</b>	12"	1"	743	802	646	546	612
	24"	1"	1006	1086	823	723	810
	36"	1"	1349	1457	1117	997	1117
	48"	1"	1691	1826	1393	1273	1426
	60"	1"	1937	2092	1553	1433	1605
	72"	1"	2292	2475	1829	1709	1914
	84"	1"	2441	2636	1922	1802	2018
	96"	1"	2638	2849	2028	1908	2137
<b>RM6144</b>	12"	1 1/4"	821	887	704	604	676
	24"	1 1/4"	1351	1459	1157	1037	1161
	36"	1 1/4"	1848	1996	1547	1427	1598
	48"	1 1/4"	2258	2439	1887	1767	1979
	60"	1 1/4"	2559	2764	2141	2021	2264
	72"	1 1/4"	2691	2906	2269	2149	2406
	84"	1 1/4"	2822	3048	2367	2247	2517
	96"	1 1/4"	2954	3190	2474	2354	2636
<b>RM6154</b>	12"	1 1/2"	918	991	747	647	725
	24"	1 1/2"	1455	1570	1287	1167	1307
	36"	1 1/2"	1991	2150	1710	1590	1781
	48"	1 1/2"	2426	2620	1908	1788	2003
	60"	1 1/2"	2860	3089	2106	1986	2224
	72"	1 1/2"	3018	3259	2305	2185	2447
	84"	1 1/2"	3177	3431	2503	2383	2669
	96"	1 1/2"	3335	3602	2701	2581	2891

- Add <sup>5</sup>/<sub>16</sub> in. over 96".
- MP (Mid Post) - Add <sup>5</sup>/<sub>16</sub> each. (Recommended for maximum rigidity on long door pulls. See page 5 for guidelines.)
- FW (Full Wrap) available up to 72" overall length pull - Call for pricing.
- Specify leather color.

NOTE: All long pulls include charge for leather between mounting posts up to a maximum of 72" of leather cover.

**ASSA ABLOY**

The global leader in door opening solutions

## Upholstery Leather Pulls (con't)

Straight Pulls - Flat Ends							
Part	Max OA	Dia.	3/605 4/606	10/612 10B/613	Stock PC 10BE	32D/630	32/629
<b>RM6160</b>	12"	1"	633	684	581	481	539
	24"	1"	896	968	758	658	737
	36"	1"	1239	1338	1052	932	1044
	48"	1"	1581	1707	1328	1208	1353
	60"	1"	1827	1973	1488	1368	1532
	72"	1"	2182	2357	1764	1644	1841
	84"	1"	2331	2517	1857	1737	1945
	96"	1"	2528	2730	1963	1843	2064
<b>RM6161</b>	12"	1 1/4"	711	768	639	539	604
	24"	1 1/4"	1241	1340	1092	972	1089
	36"	1 1/4"	1738	1877	1482	1362	1525
	48"	1 1/4"	2148	2320	1822	1702	1906
	60"	1 1/4"	2449	2645	2076	1956	2191
	72"	1 1/4"	2581	2787	2204	2084	2334
	84"	1 1/4"	2712	2929	2302	2182	2444
	96"	1 1/4"	2844	3072	2409	2289	2564
<b>RM6162</b>	12"	1 1/2"	808	873	682	582	652
	24"	1 1/2"	1345	1453	1222	1102	1234
	36"	1 1/2"	1881	2031	1645	1525	1708
	48"	1 1/2"	2316	2501	1843	1723	1930
	60"	1 1/2"	2750	2970	2041	1921	2152
	72"	1 1/2"	2908	3141	2240	2120	2374
	84"	1 1/2"	3067	3312	2438	2318	2596
	96"	1 1/2"	3225	3483	2636	2516	2818
Offset Pulls - Flat Ends							
<b>RM6170</b>	12"	1"	668	721	611	511	572
	24"	1"	931	1005	788	688	771
	36"	1"	1274	1376	1082	962	1077
	48"	1"	1616	1745	1358	1238	1387
	60"	1"	1862	2011	1518	1398	1566
	72"	1"	2217	2394	1794	1674	1875
	84"	1"	2366	2555	1887	1767	1979
	96"	1"	2563	2768	1993	1873	2098
<b>RM6171</b>	12"	1 1/4"	746	806	669	569	637
	24"	1 1/4"	1276	1378	1122	1002	1122
	36"	1 1/4"	1773	1915	1512	1392	1559
	48"	1 1/4"	2183	2358	1852	1732	1940
	60"	1 1/4"	2484	2683	2106	1986	2224
	72"	1 1/4"	2616	2825	2234	2114	2367
	84"	1 1/4"	2747	2967	2332	2212	2477
	96"	1 1/4"	2879	3109	2439	2319	2597
<b>RM6172</b>	12"	1 1/2"	843	910	712	612	685
	24"	1 1/2"	1380	1490	1252	1132	1268
	36"	1 1/2"	1916	2069	1675	1555	1742
	48"	1 1/2"	2351	2539	1873	1753	1963
	60"	1 1/2"	2785	3008	2071	1951	2185
	72"	1 1/2"	2943	3178	2270	2150	2408
	84"	1 1/2"	3102	3350	2468	2348	2630
	96"	1 1/2"	3260	3521	2666	2546	2852

Straight Pulls - Round Ends							
Part	Max OA	Dia.	3/605 4/606	10/612 10B/613	Stock PC 10BE	32D/630	32/629
<b>RM6180</b>	12"	1"	708	765	616	516	578
	24"	1"	971	1049	793	693	776
	36"	1"	1314	1419	1087	967	1083
	48"	1"	1656	1788	1363	1243	1392
	60"	1"	1902	2054	1523	1403	1571
	72"	1"	2257	2438	1799	1679	1880
	84"	1"	2406	2598	1892	1772	1985
	96"	1"	2603	2811	1998	1878	2103
<b>RM6181</b>	12"	1 1/4"	786	849	674	574	643
	24"	1 1/4"	1316	1421	1127	1007	1128
	36"	1 1/4"	1813	1958	1517	1397	1565
	48"	1 1/4"	2223	2401	1857	1737	1945
	60"	1 1/4"	2524	2726	2111	1991	2230
	72"	1 1/4"	2656	2868	2239	2119	2373
	84"	1 1/4"	2787	3010	2337	2217	2483
	96"	1 1/4"	2919	3153	2444	2324	2603
<b>RM6182</b>	12"	1 1/2"	883	954	717	617	691
	24"	1 1/2"	1420	1534	1257	1137	1273
	36"	1 1/2"	1956	2112	1680	1560	1747
	48"	1 1/2"	2391	2582	1878	1758	1969
	60"	1 1/2"	2825	3051	2076	1956	2191
	72"	1 1/2"	2983	3222	2275	2155	2414
	84"	1 1/2"	3142	3393	2473	2353	2635
	96"	1 1/2"	3300	3564	2671	2551	2857
Offset Pulls - Round Ends							
<b>RM6190</b>	12"	1"	743	802	646	546	612
	24"	1"	1006	1086	823	723	810
	36"	1"	1349	1457	1117	997	1117
	48"	1"	1691	1826	1393	1273	1426
	60"	1"	1937	2092	1553	1433	1605
	72"	1"	2292	2475	1829	1709	1914
	84"	1"	2441	2636	1922	1802	2018
	96"	1"	2638	2849	2028	1908	2137
<b>RM6191</b>	12"	1 1/4"	821	887	704	604	676
	24"	1 1/4"	1351	1459	1157	1037	1161
	36"	1 1/4"	1848	1996	1547	1427	1598
	48"	1 1/4"	2258	2439	1887	1767	1979
	60"	1 1/4"	2559	2764	2141	2021	2264
	72"	1 1/4"	2691	2906	2269	2149	2406
	84"	1 1/4"	2822	3048	2367	2247	2517
	96"	1 1/4"	2954	3190	2474	2354	2636
<b>RM6192</b>	12"	1 1/2"	918	991	747	647	725
	24"	1 1/2"	1455	1570	1287	1167	1307
	36"	1 1/2"	1991	2150	1710	1590	1781
	48"	1 1/2"	2426	2620	1908	1788	2003
	60"	1 1/2"	2860	3089	2106	1986	2224
	72"	1 1/2"	3018	3259	2305	2185	2447
	84"	1 1/2"	3177	3431	2503	2383	2669
	96"	1 1/2"	3335	3602	2701	2581	2891

- Add 5/6 in. over 96".
- MP (Mid Post) - Add \$70 each. (Recommended for maximum rigidity on long door pulls. See page 5 for guidelines.)
- FW (Full Wrap) available up to 72" overall length pull - Call for pricing.
- Specify leather color.

NOTE: All long pulls include charge for leather between mounting posts up to a maximum of 72" of leather cover.

**ASSA ABLOY**

The global leader in  
door opening solutions

Leather Oval - Ergonomic Pulls

True Oval					
Part	Max OA	Grip Size	Stock PC 10BE	32D/630	32/629
RM6200-12	15 1/2"	1" x 1 1/2"	846	746	798
RM6200-16	19 1/2"	1" x 1 1/2"	984	864	924
RM6200	36" - 48"	1" x 1 1/2"	1907	1787	1913
RM6200	48" - 72"	1" x 1 1/2"	2800	2680	2867
RM6200	72" - 96"	1" x 1 1/2"	3096	2976	3184
Flat Oval - 3/4" Diameter Posts					
RM6220-12	16"	3/4" x 1 1/2"	882	782	837
RM6220-16	20"	3/4" x 1 1/2"	1044	924	988
RM6220	36" - 48"	3/4" x 1 1/2"	1980	1860	1991
RM6220	48" - 72"	3/4" x 1 1/2"	2873	2753	2946
RM6220	72" - 96"	3/4" x 1 1/2"	3096	2976	3184

Flat Oval - 1" Diameter Posts					
Part	Max OA	Grip Size	Stock PC 10BE	32D/630	32/629
RM6230-12	17"	3/4" x 1 1/2"	933	813	870
RM6230-16	21"	3/4" x 1 1/2"	1074	954	1020
RM6230	36" - 48"	3/4" x 1 1/2"	2011	1891	2024
RM6230	48" - 72"	3/4" x 1 1/2"	2904	2784	2978
RM6230	72" - 96"	3/4" x 1 1/2"	3127	3007	3217
Flat Oval - 3/4"x 1 1/2" Diameter Posts					
RM6240-12	15 1/4"	3/4" x 1 1/2"	1052	932	998
RM6240-16	19 1/4"	3/4" x 1 1/2"	1192	1072	1148
RM6240	36" - 48"	3/4" x 1 1/2"	2130	2010	2151
RM6240	48" - 72"	3/4" x 1 1/2"	3022	2902	3105
RM6240	72" - 96"	3/4" x 1 1/2"	3245	3125	3344

- Add \$6/in. over 96".
- MP (Mid Post) - Add \$63 each. (Recommended for maximum rigidity on long door pulls. See page 5 for guidelines.)
- Specify leather color.

NOTE: All long pulls include charge for leather between mounting posts up to a maximum of 72" of leather cover.

Flush Leather Pulls

Straight Pulls - Flat Ends							
Part	Max OA	Dia.	3/605 4/606	10/612 10B/613	Stock PC 10BE	32D/630	32/629
RM6300-10	14"	1"	792	856	728	628	672
RM6300-12	16"	1"	840	908	771	671	718
RM6300	Up to 48"	1"	2055	2219	1832	1712	1831
RM6310-12	16"	1 1/4"	950	1025	846	746	798
RM6310-16	20"	1 1/4"	1028	1110	941	821	878
RM6310	Up to 48"	1 1/4"	2212	2389	1907	1787	1913
RM6310	48" - 72"	1 1/4"	2844	3072	2502	2382	2548
RM6310	72" - 96"	1 1/4"	3791	4094	3394	3274	3504
RM6320-12	16"	1 1/2"	1028	1110	941	821	878
RM6320-16	20"	1 1/2"	1107	1195	1015	895	957
RM6320	Up to 48"	1 1/2"	2370	2559	2056	1936	2072
RM6320	48" - 72"	1 1/2"	3001	3242	2651	2531	2708
RM6320	72" - 96"	1 1/2"	3950	4266	3543	3423	3663
Offset Pulls - Flat Ends							
RM6330-10	14"	1"	830	896	764	664	711
RM6330-12	16"	1"	879	950	810	710	760
RM6330	Up to 48"	1"	2095	2262	1869	1749	1872
RM6340-12	16"	1 1/4"	989	1068	882	782	837
RM6340-16	20"	1 1/4"	1069	1154	977	857	917
RM6340	Up to 48"	1 1/4"	2253	2433	1944	1824	1951
RM6340	48" - 72"	1 1/4"	2884	3115	2539	2419	2589
RM6340	72" - 96"	1 1/4"	3830	4137	3433	3313	3545
RM6350-12	16"	1 1/2"	1069	1154	977	857	917
RM6350-16	20"	1 1/2"	1147	1239	1052	932	998
RM6350	Up to 48"	1 1/2"	2411	2603	2093	1973	2110
RM6350	48" - 72"	1 1/2"	3043	3286	2687	2567	2747
RM6350	72" - 96"	1 1/2"	3988	4308	3581	3461	3704

Straight Pulls - Round Ends							
Part	Max OA	Dia.	3/605 4/606	10/612 10B/613	Stock PC 10BE	32D/630	32/629
RM6304-10	14"	1"	830	896	764	664	711
RM6304-12	16"	1"	879	950	810	710	760
RM6304	Up to 48"	1"	2095	2262	1869	1749	1872
RM6314-12	16"	1 1/4"	989	1068	882	782	837
RM6314-16	20"	1 1/4"	1069	1154	977	857	917
RM6314	Up to 48"	1 1/4"	2253	2433	1944	1824	1951
RM6314	48" - 72"	1 1/4"	2884	3115	2539	2419	2589
RM6314	72" - 96"	1 1/4"	3830	4137	3433	3313	3545
RM6324-12	16"	1 1/2"	1069	1154	977	857	917
RM6324-16	20"	1 1/2"	1147	1239	1052	932	998
RM6324	Up to 48"	1 1/2"	2411	2603	2093	1973	2110
RM6324	48" - 72"	1 1/2"	3043	3286	2687	2567	2747
RM6324	72" - 96"	1 1/2"	3988	4308	3581	3461	3704
Offset Pulls - Round Ends							
RM6334-10	14"	1"	872	941	801	701	750
RM6334-12	16"	1"	917	991	846	746	798
RM6334	Up to 48"	1"	2134	2305	1907	1787	1913
RM6344-12	16"	1 1/4"	1028	1110	941	821	878
RM6344-16	20"	1 1/4"	1107	1195	1015	895	957
RM6344	Up to 48"	1 1/4"	2290	2473	1980	1860	1991
RM6344	48" - 72"	1 1/4"	2922	3156	2575	2455	2627
RM6344	72" - 96"	1 1/4"	3873	4183	3469	3349	3583
RM6354-12	16"	1 1/2"	1107	1195	1015	895	957
RM6354-16	20"	1 1/2"	1186	1280	1088	968	1035
RM6354	Up to 48"	1 1/2"	2449	2645	2130	2010	2151
RM6354	48" - 72"	1 1/2"	3080	3327	2725	2605	2788
RM6354	72" - 96"	1 1/2"	4029	4351	3617	3497	3741

- Add \$6/in. over 96".
- Up to 96" available with mid-post (Recommended for maximum rigidity on long door pulls. See page 5 for guidelines.)
- Specify leather type and color.

**ASSA ABLOY**

The global leader in door opening solutions

Prices Effective September 1, 2017

Copyright © 2017, Rockwood Manufacturing Company, an ASSA ABLOY Group company. All rights reserved. Reproduction in whole or in part without the express written permission of Rockwood Manufacturing Company is prohibited.

## Upholstery Leather GeoMetek - Narrow Profile Pulls

Straight Square End Pulls					
Part	CTC	Grip Size	Stock PC 10BE	32D/630	32/629
RM6400-11	11"	3/4" x 3/4"	573	473	506
RM6400-16	16"	3/4" x 3/4"	700	600	642
RM6400	Up to 48"	3/4" x 3/4"	1575	1455	
RM6440-11	11"	1 1/4" x 1 1/4"	665	565	605
RM6440-16	16"	1 1/4" x 1 1/4"	822	722	773
RM6440	Up to 48"	1 1/4" x 1 1/4"	1925	1805	
Straight Rectangular End Pulls					
RM6410-11	11"	3/4" x 1 1/2"	670	570	610
RM6410-16	16"	3/4" x 1 1/2"	813	713	763
RM6410-20	20"	3/4" x 1 1/2"	855	755	808
RM6410	Up to 96"	3/4" x 1 1/2"	2617	2497	

Offset Square End Pulls					
Part	CTC	Grip Size	Stock PC 10BE	32D/630	32/629
RM6420-11	11"	3/4" x 3/4"	612	512	548
RM6420-16	16"	3/4" x 3/4"	739	639	683
RM6420	Up to 48"	3/4" x 3/4"	1623	1503	
Offset Rectangular End Pulls					
RM6430-11	11"	3/4" x 1 1/2"	707	607	650
RM6430-16	16"	3/4" x 1 1/2"	848	748	800
RM6430-20	20"	3/4" x 1 1/2"	982	862	922
RM6430	Up to 96"	3/4" x 1 1/2"	2654	2534	

## Leather - Small Pulls for Cabinets, Casework & Closet Doors

Straight Surface Wrapped - Flat Ends							
Part	Max OA	Dia.	3/605 4/606	10/612 10B/613	Stock PC 10BE	32D/630	32/629
RM6500-4	5 7/8"	1/2"	174	187	184	134	143
RM6500-5	6 7/8"	1/2"	185	200	194	144	154
RM6510-5	6 7/8"	5/8"	213	230	221	171	184
RM6510-6	7 7/8"	5/8"	239	258	246	196	209
Offset Surface Wrapped - Flat Ends							
RM6530-5	7"	5/8"	265	286	286	219	235
RM6530-6	8"	5/8"	289	312	312	243	260
Straight Surface Wrapped - Round Ends							
RM6540-4	5 7/8"	1/2"	191	207	201	151	161
RM6540-5	6 7/8"	1/2"	205	222	213	163	174
RM6550-5	7"	5/8"	232	251	239	189	202
RM6550-6	8"	5/8"	257	278	278	212	227
Offset Surface Wrapped - Round Ends							
RM6570-5	7"	5/8"	283	306	306	237	253
RM6570-6	8"	5/8"	307	332	332	261	279
Straight Flush Wrapped - Flat Ends							
RM6610-5	6 7/8"	5/8"	239	258	231	181	193
RM6610-6	7 7/8"	5/8"	269	291	290	210	224
Offset Flush Wrapped - Flat Ends							
RM6630-5	6 7/8"	5/8"	280	303	299	219	235
RM6630-6	7 7/8"	5/8"	312	337	330	250	267
Straight Flush Wrapped - Round Ends							
RM6650-5	6 7/8"	5/8"	252	271	243	193	206
RM6650-6	7 7/8"	5/8"	283	306	302	222	238
Offset Flush Wrapped - Round Ends							
RM6670-5	6 7/8"	5/8"	293	317	312	232	248
RM6670-6	7 7/8"	5/8"	323	349	341	261	279
Straight Full Wrapped - Flat Ends							
RM6700-4	5 7/8"	1/2"	199	214	214	173	186
RM6700-5	6 7/8"	1/2"	224	241	241	196	209
RM6710-5	6 7/8"	5/8"	244	264	264	215	231
RM6710-6	7 7/8"	5/8"	274	295	295	243	260
Offset Full Wrapped - Flat Ends							
RM6730-5	6 7/8"	5/8"	286	309	309	254	271
RM6730-6	7 7/8"	5/8"	314	339	339	282	301

- Any size made to order.
- Specify leather type and color.

## NeoCylinder - with or without GripZone

Straight Pulls without GripZone					
Part	CTC	Dia.	Stock PC 10BE	32D/630	32/629
RM7210-11	11"	1 1/4"	349	269	301
RM7210-16	16"	1 1/4"	357	277	310
RM7210-20	20"	1 1/4"	365	285	319
RM7210	Up to 36"	1 1/4"	441	361	405
Offset Pulls without GripZone					
RM7220-11	11"	1 1/4"	411	331	370
RM7220-16	16"	1 1/4"	419	339	379
RM7220-20	20"	1 1/4"	428	348	389
RM7220	Up to 36"	1 1/4"	524	424	475
Straight Pulls with GripZone					
RM7230-11	11"	1 1/4"			377
RM7230-16	16"	1 1/4"			385
RM7230-20	20"	1 1/4"			392
RM7230	Up to 36"	1 1/4"			545
Offset Pulls with GripZone					
RM7240-11	11"	1 1/4"			439
RM7240-16	16"	1 1/4"			444
RM7240-20	20"	1 1/4"			455
RM7240	Up to 36"	1 1/4"			605
Push Bar without GripZone					
RM7212	Up to 36"	1 1/4"	441	361	405
Push Bar with GripZone					
RM7232	Up to 36"	1 1/4"			545

- Add \$6/in. over 36".

## NeoMitre - with or without GripZone

Straight Pulls without GripZone					
Part	CTC	Dia.	Stock PC 10BE	32D/630	32/629
RM7300-8	8"	1"	368	288	323
RM7300-11	11"	1"	376	296	331
RM7300-16	16"	1"	383	303	339
RM7300	Up to 36"	1"	523	423	474
RM7310-11	11"	1 ¼"	506	406	455
RM7310-16	16"	1 ¼"	514	414	464
RM7310-20	20"	1 ¼"	523	423	474
RM7310	Up to 36"	1 ¼"	582	482	541
RM7320-11	11"	1 ½"	582	482	541
RM7320-16	16"	1 ½"	591	491	550
RM7320-20	20"	1 ½"	598	498	558
RM7320	Up to 36"	1 ½"	658	558	624
Offset Pulls without GripZone					
RM7330-8	8	1"	441	361	405
RM7330-11	11	1"	449	369	413
RM7330-16	16	1"	456	376	422
RM7330	Up to 36"	1"	598	498	558
RM7340-11	11"	1 ¼"	582	482	541
RM7340-16	16"	1 ¼"	591	491	550
RM7340-20	20"	1 ¼"	598	498	558
RM7340	Up to 36"	1 ¼"	658	558	624
RM7350-11	11"	1 ½"	658	558	624
RM7350-16	16"	1 ½"	665	565	633
RM7350-20	20"	1 ½"	671	571	640
RM7350	Up to 36"	1 ½"	734	634	710
Push Bars without GripZone					
RM7302	Up to 36"	1"	523	423	474
RM7312	Up to 36"	1 ¼"	582	482	541
RM7322	Up to 36"	1 ½"	658	558	624

- Add 5/6" in. over 36".

NOTE: Post location on push bars can be located 1/8" from end for narrow & medium stile doors and 1" from end for flush and wide stile doors.

Straight Pulls with GripZone			
Part	CTC	Dia.	32/629
RM7400-8	8"	1"	376
RM7400-11	11"	1"	385
RM7400-16	16"	1"	392
RM7400	Up to 36"	1"	542
RM7410-11	11"	1 ¼"	498
RM7410-16	16"	1 ¼"	512
RM7410-20	20"	1 ¼"	573
RM7410	Up to 36"	1 ¼"	634
RM7420-11	11"	1 ½"	571
RM7420-16	16"	1 ½"	587
RM7420-20	20"	1 ½"	649
RM7420	Up to 36"	1 ½"	709
Offset Pulls with GripZone			
RM7430-8	8"	1"	453
RM7430-11	11"	1"	460
RM7430-16	16"	1"	467
RM7430	Up to 36"	1"	618
RM7440-11	11"	1 ¼"	571
RM7440-16	16"	1 ¼"	587
RM7440-20	20"	1 ¼"	649
RM7440	Up to 36"	1 ¼"	709
RM7450-11	11"	1 ½"	648
RM7450-16	16"	1 ½"	664
RM7450-20	20"	1 ½"	724
RM7450	Up to 36"	1 ½"	784
Push Bars with GripZone			
RM7402	Up to 36"	1"	542
RM7412	Up to 36"	1 ¼"	634
RM7422	Up to 36"	1 ½"	709

# ASSA ABLOY

The global leader in  
door opening solutions

Prices Effective September 1, 2017

Copyright © 2017, Rockwood Manufacturing Company, an ASSA ABLOY Group company. All rights reserved.  
Reproduction in whole or in part without the express written permission of Rockwood Manufacturing Company is prohibited.



## GeoMetek - Narrow Profile Pulls

Straight Square End Pulls					
Part	CTC	Grip Size	Stock PC 10BE	32D/630	32/629
RM7900	12"	3/4" x 3/4"	245	195	218
	24"	3/4" x 3/4"	316	236	264
	36"	3/4" x 3/4"	357	277	310
	48"	3/4" x 3/4"	399	319	357
RM7940	12"	1 1/4" x 1 1/4"	327	247	277
	24"	1 1/4" x 1 1/4"	374	294	329
	36"	1 1/4" x 1 1/4"	421	341	382
	48"	1 1/4" x 1 1/4"	467	387	433
Straight Square Bridge Pulls					
RM7902	12"	3/4" x 3/4"	320	240	269
	24"	3/4" x 3/4"	360	280	314
	36"	3/4" x 3/4"	401	321	360
	48"	3/4" x 3/4"	441	361	404
Straight Rectangular End Pulls					
RM7910	12"	3/4" x 1 1/2"	305	225	252
	24"	3/4" x 1 1/2"	471	391	438
	36"	3/4" x 1 1/2"	658	558	625
	48"	3/4" x 1 1/2"	821	724	811
Straight Rectangular Bridge Pulls					
RM7912	12"	3/4" x 1 1/2"	348	268	300
	24"	3/4" x 1 1/2"	534	434	486
	36"	3/4" x 1 1/2"	700	600	672
	48"	3/4" x 1 1/2"	866	766	858
Offset Pulls					
RM7920	12"	3/4" x 3/4"	307	227	254
	24"	3/4" x 3/4"	345	265	297
	36"	3/4" x 3/4"	384	304	340
	48"	3/4" x 3/4"	422	342	383
RM7930	12"	3/4" x 1 1/2"	346	266	298
	24"	3/4" x 1 1/2"	524	424	475
	36"	3/4" x 1 1/2"	683	583	653
	48"	3/4" x 1 1/2"	841	741	830
Straight Rectangular End Stepped Post Pull					
RM7960	12"	3/4" x 3/4"	348	268	300
	24"	3/4" x 3/4"	394	314	352
	36"	3/4" x 3/4"	439	359	402
	48"	3/4" x 3/4"	505	405	454
Straight Rectangular End Stepped Post Cast Pull					
Part	CTC	Grip Size	3/605 4/606	10/612 10B/613	15/619
RM7960	12"	3/4" x 3/4"	328	354	377

- Add \$9/in. over 48".

Locking Door Pulls

PostMount - Round						
Part	Description	3/605 4/606	Stock PC 10BE	10B/613 10BL/614	32/629	32D/630
LP3301DBD	Half Height Pull - Bolts Down	1769	1378	1911	1138	1017
LP3301DBU	Half Height Pull - Bolts Up	1941	1469	2097	1229	1097
LP3301FHD	Full Height Pull - Bolts Down	2148	1557	2321	1317	1176
LP3301FHU	Full Height Pull - Bolts Up	2356	1661	2545	1421	1269
LP3301FHB	Full Height Pull - Bolts Up and Down	2594	1910	2801	1670	1490
Horizontal Push/Pull Bar Option - Half Height – Bolts Down (DBD)						
LP3301DBDBEPB	Bent End Both Sides	2353	1755	2541	1515	1352
LP3301DBDBEPT	Bent End Thumbturn Side - Mating Side Vertical	2061	1567	2226	1327	1185
LP3301DBDBEPC	Bent End Cylinder Side - Mating Side Vertical	2061	1567	2226	1327	1185
LP3301DBDPMPB	Post Mount Both Sides	2582	1874	2789	1634	1458
LP3301DBDPMPT	Post Mount Thumbturn Side - Mating Side Vertical	2262	1671	2442	1431	1277
LP3301DBDPMPC	Post Mount Cylinder Side - Mating Side Vertical	2262	1671	2442	1431	1277
Horizontal Push/Pull Bar Option - Half Height – Bolts Up (DBU)						
LP3301DBUBEPB	Bent End Both Sides	2353	1755	2541	1515	1352
LP3301DBUBEPT	Bent End Thumbturn Side - Mating Side Vertical	2061	1567	2226	1327	1185
LP3301DBUBEPC	Bent End Cylinder Side - Mating Side Vertical	2061	1567	2226	1327	1185
LP3301DBUPMPB	Post Mount Both Sides	2582	1874	2789	1634	1458
LP3301DBUPMPT	Post Mount Thumbturn Side - Mating Side Vertical	2262	1671	2442	1431	1277
LP3301DBUPMPC	Post Mount Cylinder Side - Mating Side Vertical	2262	1671	2442	1431	1277
NeoTek with GripZone - Round						
Part	Description	3/605	32/629			
LP3401DBD	Half Height Pull - Bolts Down	1896	1222			
LP3401DBU	Half Height Pull - Bolts Up	2080	1317			
LP3401FHD	Full Height Pull - Bolts Down	2274	1410			
LP3401FHU	Full Height Pull - Bolts Up	2495	1520			
LP3401FHB	Full Height Pull - Bolts Up and Down	2734	1741			
Horizontal Push/Pull Bar Option - Half Height – Bolts Down (DBD)						
LP3401DBDBEPB	Bent End Both Sides	2521	1625			
LP3401DBDBEPT	Bent End Thumbturn Side - Mating Side Vertical	2209	1423			
LP3401DBDBEPC	Bent End Cylinder Side - Mating Side Vertical	2209	1423			
LP3401DBDPMPB	Post Mount Both Sides	2521	1625			
LP3401DBDPMPT	Post Mount Thumbturn Side - Mating Side Vertical	2209	1423			
LP3401DBDPMPC	Post Mount Cylinder Side - Mating Side Vertical	2209	1423			
Horizontal Push/Pull Bar Option - Half Height – Bolts Up (DBU)						
LP3401DBUBEPB	Bent End Both Sides	2767	1752			
LP3401DBUBEPT	Bent End Thumbturn Side - Mating Side Vertical	2423	1535			
LP3401DBUBEPC	Bent End Cylinder Side - Mating Side Vertical	2423	1535			
LP3401DBUPMPB	Post Mount Both Sides	2767	1752			
LP3401DBUPMPT	Post Mount Thumbturn Side - Mating Side Vertical	2423	1535			
LP3401DBUPMPC	Post Mount Cylinder Side - Mating Side Vertical	2423	1535			

- DBD and DBU priced as 51" overall. Add \$12/in. over 96" long for full height or 51" long for half height.
- Horizontal Push/Pull Option, add \$12/in. over 36".

NOTE: New square Locking Pulls only available in US10BE, US32, and US32D.



The global leader in  
door opening solutions

Prices Effective September 1, 2017

Copyright © 2017, Rockwood Manufacturing Company, an ASSA ABLOY Group company. All rights reserved.  
Reproduction in whole or in part without the express written permission of Rockwood Manufacturing Company is prohibited.

Locking Door Pulls (con't)

English Bridle Leather Wrapped - Round						
Part	Description	3/605 4/606	Stock PC 10BE	10B/613 10BL/614	32/629	32D/630
LP6061DBD	Half Height Pull - Bolts Down	4926	4142	5320	4505	4022
LP6061DBU	Half Height Pull - Bolts Up	5098	4233	5506	4585	4113
LP6061FHD	Full Height Pull - Bolts Down	6273	5332	6774	5837	5212
LP6061FHU	Full Height Pull - Bolts Up	6481	5436	6998	5930	5316
LP6061FHB	Full Height Pull - Bolts Up and Down	6719	5685	7254	6151	5565
Horizontal Push/Pull Bar Option - Half Height – Bolts Down (DBD)						
LP6061DBDBEPB*	Bent End Both Sides	6399	4938	6911	5357	4818
LP6061DBDBEPT*	Bent End Thumbturn Side - Mating Side Vertical	5662	4540	6116	4931	4420
LP6061DBDBEPC*	Bent End Cylinder Side - Mating Side Vertical	5662	4540	6116	4931	4420
LP6061DBDPMPB*	Post Mount Both Sides	6399	4938	6911	5357	4818
LP6061DBDPMPT*	Post Mount Thumbturn Side - Mating Side Vertical	5662	4540	6116	4931	4420
LP6061DBDPMPC*	Post Mount Cylinder Side - Mating Side Vertical	5662	4540	6116	4931	4420
Horizontal Push/Pull Bar Option - Half Height – Bolts Up (DBU)						
LP6061DBUBEPB*	Bent End Both Sides	6571	5029	7097	5437	4909
LP6061DBUBEPT*	Bent End Thumbturn Side - Mating Side Vertical	5834	4631	6302	5011	4511
LP6061DBUBEPC*	Bent End Cylinder Side - Mating Side Vertical	5834	4631	6302	5011	4511
LP6061DBUPMPB*	Post Mount Both Sides	6571	5029	7097	5437	4909
LP6061DBUPMPT*	Post Mount Thumbturn Side - Mating Side Vertical	5834	4631	6302	5011	4511
LP6061DBUPMPC*	Post Mount Cylinder Side - Mating Side Vertical	5834	4631	6302	5011	4511
PostMount Upholstery Leather Wrapped - Round						
LP6161DBD	Half Height Pull - Bolts Down	4830	4058	5216	4411	3938
LP6161DBU	Half Height Pull - Bolts Up	5002	4149	5402	4491	4029
LP6161FHD	Full Height Pull - Bolts Down	5958	5018	6435	5486	4898
LP6161FHU	Full Height Pull - Bolts Up	6166	5122	6659	5579	5002
LP6161FHB	Full Height Pull - Bolts Up and Down	6404	5371	6915	5800	5251
Horizontal Push/Pull Bar Option - Half Height – Bolts Down (DBD)						
LP6161DBDBEPB*	Bent End Both Sides	6241	4842	6740	5250	4722
LP6161DBDBEPT*	Bent End Thumbturn Side - Mating Side Vertical	5535	4451	5978	4804	4358
LP6161DBDBEPC*	Bent End Cylinder Side - Mating Side Vertical	5535	4451	5978	4804	4358
LP6161DBDPMPB*	Post Mount Both Sides	6241	4842	6740	5250	4722
LP6161DBDPMPT*	Post Mount Thumbturn Side - Mating Side Vertical	5535	4451	5978	4804	4358
LP6161DBDPMPC*	Post Mount Cylinder Side - Mating Side Vertical	5535	4451	5978	4804	4358
Horizontal Push/Pull Bar Option - Half Height – Bolts Up (DBU)						
LP6161DBUBEPB*	Bent End Both Sides	6413	4933	6926	5330	4813
LP6161DBUBEPT*	Bent End Thumbturn Side - Mating Side Vertical	5707	4542	6164	4884	4449
LP6161DBUBEPC*	Bent End Cylinder Side - Mating Side Vertical	5707	4542	6164	4884	4449
LP6161DBUPMPB*	Post Mount Both Sides	6413	4933	6926	5330	4813
LP6161DBUPMPT*	Post Mount Thumbturn Side - Mating Side Vertical	5707	4542	6164	4884	4449
LP6161DBUPMPC*	Post Mount Cylinder Side - Mating Side Vertical	5707	4542	6164	4884	4449

- DBD and DBU priced as 51" overall. Add \$12/in. over 96" long for full height or 51" long for half height.
- \* Price includes up to 42" of English Bridle Leather on vertical.
- Other options available upon request.

NOTE: New square Locking Pulls only available in US10BE, US32, and US32D.

Locking Door Pulls (con't)

GeoMetek Upholstery Leather Wrapped - Square						
Part	Description	3/605 4/606	Stock PC 10BE	10B/613 10BL/614	32/629	32D/630
LP6440DBD	Half Height Pull - Bolts Down		4264		4641	4144
LP6440DBU	Half Height Pull - Bolts Up		4355		4721	4235
LP6440FHD	Full Height Pull - Bolts Down		5224		5716	5104
LP6440FHU	Full Height Pull - Bolts Up		5328		5809	5208
LP6440FHB	Full Height Pull - Bolts Up and Down		5577		6030	5457
GeoMetek - Square						
LP7901DBD	Half Height Pull - Bolts Down		1460		1305	1220
LP7901DBU	Half Height Pull - Bolts Up		1555		1407	1315
LP7901FHD	Full Height Pull - Bolts Down		1652		1511	1412
LP7901FHU	Full Height Pull - Bolts Up		1762		1628	1522
LP7901FHB	Full Height Pull - Bolts Up and Down		2027		1912	1787
MegaTek Dummy Pull - Round						
DP3301DBD	Half Height Pull - Bolts Down	1388	1054	1500	870	814
DP3301DBU	Half Height Pull - Bolts Up	1523	1118	1645	939	878
DP3301FHD	Full Height Pull - Bolts Down	1896	1299	2048	1133	1059
DP3301FHU	Full Height Pull - Bolts Up	2081	1382	2247	1223	1142
NeoTek with GripZone Dummy Pull - Round						
DP3401DBD	Half Height Pull - Bolts Down	1487			977	
DP3401DBU	Half Height Pull - Bolts Up	1633			1054	
DP3401FHD	Full Height Pull - Bolts Down	2007			1269	
DP3401FHU	Full Height Pull - Bolts Up	2203			1369	
GeoMetek Dummy Pull - Square						
DP7901DBD	Half Height Pull - Bolts Down		1215		1043	975
DP7901DBU	Half Height Pull - Bolts Up		1293		1127	1053
DP7901FHD	Full Height Pull - Bolts Down		1511		1360	1271
DP7901FHU	Full Height Pull - Bolts Up		1611		1467	1371

- DBD and DBU priced as 51" overall. Add \$12/in. over 96" long for full height or 51" long for half height.
- \* Price includes up to 42" of Upholstry Leather on vertical. Other options available upon request.

NOTE: New Square Locking Pulls only available in US10BE, US32, and US32D.

Locking Door Pull Accessories

Part	Description	Stock PC 10BE	28/628	32/629	32D/630	314E
LPS01	Top Strike - 3/4" x 1 1/2" x 3"	39	39	75	67	
LPS02	Top Strike - w/Rubber Stop - 3/4" x 2 1/2" x 3"	39	39	75	67	
LPS03	Top Strike - Stainless Steel - .050" x 1 1/8" x 2 1/4"	39		35	31	
LPS04	Transom Strike - 1 1/4"D x 4"H	126		102	91	
LPS05	Transom Strike - 1 1/4"SQ x 4 1/2"H	147		118	106	
LPS06	Mortised Header Strike 2" Dia.			187	167	230
Part	Description	3/605 4/606	10/612 10BL/614	Stock PC 10BE	26/625 26D/626	15/619
570	Dust Proof Strike	27	29	29	28	29
Part	Description	3/605 4/606	10/612 10BL/614	Stock PC 10BE	26/625 26D/626	32D/630
RM850	Floor Mounted Stop 1 1/2" Projection	36	39	39	33	34
RM851	Floor Mounted Stop 2 1/2" Projection	46	50	50	46	44
Part	Description	3/605 4/606	10BL/614	Stock PC 10BE	32D/630	
ADA (suffix)	ADA Large Thumbturn - 1 13/16"	37	37	37	36	

NOTE: Thumbturn design differs between the round and square versions.

**ASSA ABLOY**

The global leader in  
door opening solutions

Prices Effective September 1, 2017

Copyright © 2017, Rockwood Manufacturing Company, an ASSA ABLOY Group company. All rights reserved.  
Reproduction in whole or in part without the express written permission of Rockwood Manufacturing Company is prohibited.

## Architectural Finishes

Most of Rockwood's products are available in all of the following architectural finishes. The catalog indicates exceptions. This finish list is grouped by base metal.

Base Metal	Description	Price Book Code	Rockwood Code	BHMA Code
Aluminum	Satin	27	US27	627
Aluminum	Clear Anodized	28	US28	628
Aluminum	Light Bronze Anodized	311	311	—
Aluminum	Medium Bronze Anodized	312	312	—
Aluminum	Dark Bronze Anodized	313	313	710
Aluminum	Extra Dark Bronze Anodized	314	314	—
Aluminum	Black Anodized	315	315	711
Aluminum	White Powder Coat	WPC	WPC	—
Aluminum	Red Powder Coat	RPC	RPC	—
Aluminum	Black Powder Coat	BPC	BPC	—
Brass	Polished Clear Coated	3	US3	605
Brass	Polished No Coating	3NL	US3NL	—
Brass	Satin Clear Coated	4	US4	606
Brass	Satin Oxidized Relieved	5	US5	609
Brass	Satin Nickel Plated Clear Coated	15	US15	619
Brass	Satin Nickel Blackened Relieved Clear Coated	15A	US15A	620
Brass	Flat Black Powder Coated	19	US19	622
Brass	Polished Chrome Plated	26	US26	625
Brass	Satin Chrome Plated	26D	US26D	626
Bronze*	Polished Clear Coated	9	US9	611
Bronze*	Satin Clear Coated	10	US10	612
Bronze*	Satin Black Oxidized Oil Rubbed	10A	US10A	—
Bronze*	Satin Oxidized Oil Rubbed	10B	US10B	613
Bronze*	Satin Oxidized Clear Coated	10BL	US10BL	614
Bronze*	Dark Oxidized Statuary Clear Coated	20A	US20A	624
Stainless Steel	Polished	32	US32	629
Stainless Steel	Satin	32D	US32D	630
<b>Special Finishes</b> (see descriptions)				
Stainless Steel	Satin MicroShield® Coated	32DMS***	US32DMS***	—
Stainless Steel	Polished 316 Alloy	32316***	US32316***	—
Stainless Steel	Satin 316 Alloy	32D316***	US32D316***	—
	Dark Oxidized Satin Bronze, Equivalent	10BE	US10BE	(613E)
	Black Suede Powder Coat	BSP	BSP	—

## Special Finishes Description

**32DMS** (MicroShield®): As part of its promise to provide innovative solutions to their customers, ASSA ABLOY Group companies offer the MicroShield® technology, a silver-based antimicrobial coating designed to inhibit the spread of germs and bacteria.

**32316** and **32D316** are made from alloy 316 stainless steel containing molybdenum and extra nickel giving it substantially higher corrosion resistance than the standard stainless steels typically used in door hardware. This finish is ideal for use in coastal, urban, and industrial areas that have harsh environmental conditions. **32316** (polish) finishes offer the best corrosion resistance and should be used in caustic environments.

**10BE** Dark Oxidized Satin Bronze equivalent: This finish provides the richness and warmth of the 10B/613 "living" finish, but maintains its original color and appearance and will not fade or wear over time. The 10BE finish is offered by Corbin Russwin, McKinney, Norton, Rixson, Rockwood, SARGENT and Yale, providing visual consistency between ASSA ABLOY Group brands.

\* On most bronze finishes we will supply solid bronze material. Where solid bronze material is not available, we will use brass as a base material with a bronze look powder coat in its place.

\*\*\* Available on select items as indicated by the finish icon throughout the catalog.



MicroShield® is a registered trademark of Yale Security Inc., an ASSA ABLOY Group company.

**ASSA ABLOY**

The global leader in  
door opening solutions

**Mounting Types**

PULL STYLE	PULL ON ONE SIDE OF DOOR						PULL ON BOTH SIDES OF DOOR (BTB)			
	Thru Bolt	Deco Thru Bolt		Concealed			Conehead/Set Screw		Spanner Collar	
DOOR TYPE	Wood/Metal		Glass	Metal	Metal	Wood	Wood/Metal	Glass	Wood/Metal	Glass
CONEHEADS	NA	NA	NA	Single	Single	Single	Single	Single	NA	NA
MOUNTING TYPE	Type 1	Type 12	Type 15	Type 6	Type 6R	Type 8	Type 5	Type 13	Type 11	Type 14
Standard (STD) Bolt Size	¼"-20	¼"-20	¼"-20	¼"-20	¼"-20	¼"-20	¼"-20	¼"-20		
Price	INCL	24.00	26.00	10.00	12.00	10.00	10.00	17.00		
Heavy Duty (HD) Bolt Size	⅝"-18	⅝"-18	⅝"-18	⅝"-18	⅝"-18	⅝"-18	⅝"-18	⅝"-18		
Price	5.00	29.00	31.00	14.00	17.00	14.00	14.00	21.00		
Extra Heavy Duty (XHD) Bolt Size	¾"-16	¾"-16	¾"-16						¾"-16	¾"-16
Price	10.00	29.00	31.00						29.00	31.00

Straight Pulls											
Pull Type	Dia.	MAXIMUM BOLT SIZE ALLOWED						MAXIMUM BOLT SIZE ALLOWED			
		Type 1	Type 12	Type 15	Type 6	Type 6R	Type 8	Type 5	Type 13	Type 11	Type 14
Straight	½"	STD	STD	STD			STD		STD	STD	STD
Straight	⅝"	HD	HD	HD	HD		HD	HD	HD	HD	HD
Straight	1"	HD	HD	HD	HD	HD	HD	HD	HD	HD	HD
Straight	1 ¼"	HD	HD	HD	HD	HD	HD	HD	HD	HD	HD
Straight	1 ½"	HD	HD	HD	HD	HD	HD	HD	HD	HD	HD

Offset Pulls											
Pull Type	Dia.	MAXIMUM BOLT SIZE ALLOWED						MAXIMUM BOLT SIZE ALLOWED			
		Type 1	Type 12	Type 15	Type 6	Type 6R	Type 8	Type 5	Type 13	Type 11	Type 14
Offset	½"	STD	STD	STD						STD	STD
Offset	⅝"	HD	HD	HD						STD	STD
Offset	1"	XHD	XHD	XHD						HD	HD
Offset	1 ¼"	XHD	XHD	XHD						HD	HD
Offset	1 ½"	XHD	XHD	XHD						HD	HD

**ASSA ABLOY**

The global leader in door opening solutions

Prices Effective September 1, 2017

Copyright © 2017, Rockwood Manufacturing Company, an ASSA ABLOY Group company. All rights reserved. Reproduction in whole or in part without the express written permission of Rockwood Manufacturing Company is prohibited.

## Door Pull Mounting Details

### Free End Thru Bolt

**TYPE 1 - Thru Bolt Wood or Metal Door**

Labels: Pull, Finish Washer, Flat Head Machine Screw, Outside, Inside

Type	Bolt Size	Drill Size	Price
1	1/4"-20	9/32	Incl.
1HD	5/16"-18	11/32	5.00
1XHD	3/8"-16	13/32	10.00

**TYPE 12 - Decorative Thru Bolt Wood or Metal Door**

Labels: Pull, Thru Bolt

Type	Bolt Size	Drill Size	Price
12	1/4"-20	9/32	24.00
12HD	5/16"-18	11/32	29.00
12XHD	3/8"-16	13/32	29.00

**TYPE 15 - Decorative Thru Bolt Glass Door**

Labels: Plastic Washers, Pull, Thru Bolt, Neoprene Bushing 5/8" Dia. Hole

Type	Bolt Size	Drill Size	Price
15	1/4"-20	5/8	26.00
15HD	5/16"-18	5/8	31.00
15XHD	3/8"-16	5/8	31.00

### Free End Concealed

**TYPE 6 - Surface Concealed Metal Door**

Minimum diameter of pull is 5/8"

Labels: Cone Head Machine Screw, Pull, Set Screw, Reinforcement by others

For doors with rivnuts specify type 6R

Type	Bolt Size	Drill Size	Price
6	1/4"-20	1/4"-20 Tap	10.00
*6HD	5/16"-18	5/16"-18 Tap	14.00

**TYPE 6R - Surface Concealed Metal Door**

Minimum diameter of pull is 1"

Labels: Cone Head Machine Screw, Pull, Set Screw, Rivnut

Type	Bolt Size	Drill Size	Price
6	1/4"-20	N/A	12.00
*6HD	5/16"-18	N/A	17.00

**TYPE 8 - Surface Concealed Wood Door**

Labels: Cone Head Machine Screw, Pull, Knife Thread Insert, 1/4"-20 Set Screw

Type	Bolt Size	Drill Size	Price
8	1/4"-20	23/64-9/16 dp.	10.00
*8HD	5/16"-18	7/16-9/16 dp.	14.00

### Back-to-Back

**TYPE 5 - Back-to-Back Wood or Metal Door**

Minimum diameter of pull is 5/8"

Labels: Cone Head Machine Screw, Pull, Set Screw, Inside, Outside

Type	Bolt Size	Drill Size	Price
5	1/4"-20	9/32	10.00
5HD	5/16"-18	11/32	14.00

**TYPE 13 - Back-to-Back Glass Door**

Labels: Cone Head Machine Screw, Pull, Plastic Washers, Set Screw, Washer, Neoprene Bushing 5/8" Dia. Hole, Inside, Outside

Type	Bolt Size	Drill Size	Price
13	1/4"-20	5/8	17.00
*13HD	5/16"-18	5/8	21.00

**TYPE 11XHD - Back-to-Back w/Spanner Collar - Wood or Metal Door**

Minimum diameter of pull is 1"

Labels: Spanner Collar, Pull, RH Thread, Inside, Outside

Type	Bolt Size	Drill Size	Price
11XHD	3/8"-16	13/32	29.00

**TYPE 14XHD - Back-to-Back Glass Door**

Minimum diameter of pull is 1"

Labels: Spanner Collar, RH/LH Thread, Pull, Felt Washers, Neoprene Bushing 5/8" Dia. Hole, Inside, Outside

Type	Bolt Size	Drill Size	Price
14XHD	3/8"-16	5/8	31.00

\*HD mountings feature 2 set screws 180° apart.

### RM4800 Mounting Only

**RM4800 Series - Thru Bolt Wood or Metal Door**

Labels: Pull, Screw, Post

Bolt Size	Drill Size	Price
3/8"-16	5/8	38.00

**RM4800 Series - Back-to-Back Wood or Metal Door**

Labels: Pull, Screw, Post

Bolt Size	Drill Size	Price
3/8"-16	5/8	38.00

**ASSA ABLOY**

The global leader in door opening solutions

Prices Effective September 1, 2017

Copyright © 2017, Rockwood Manufacturing Company, an ASSA ABLOY Group company. All rights reserved. Reproduction in whole or in part without the express written permission of Rockwood Manufacturing Company is prohibited.

## Push and Pull Bar Mounting Details

### Sizing of Push Bars

#### Flush Doors

- Door width:
- minus 5" for bent end bars
  - minus 5" for flat end post mount bars
  - minus 7" for round end post mount bars

#### Stile and Rail Doors or Doors with Lites

- Door width:
- minus width of one stile

**CAUTION:** Always confirm bars will not interfere with jamb or cause pinching hazard.

**CAUTION:** On narrow stile doors, be sure push bar base fits on the stile and bar does not interfere with the stop.

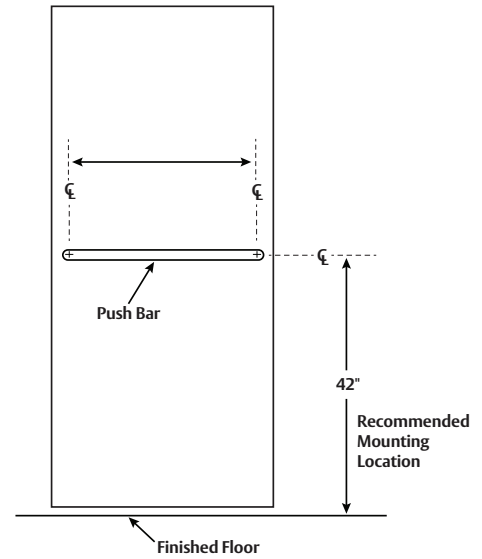

### Handing of Doors

The handing of a door is determined from the outside of the opening.

Standing outside the door:

- If the hinges are on the right, it is a right hand door.
- If the hinges are on the left, it is a left hand door.
- If the door opens away from you, it is a regular bevel door.
- If the door opens toward you, it is a reverse bevel door.

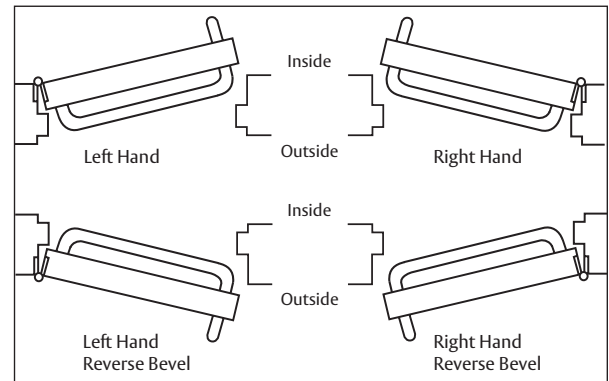

### Typical Mounting

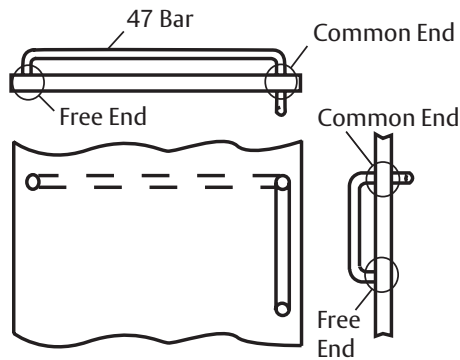

**ASSA ABLOY**

The global leader in door opening solutions

Prices Effective September 1, 2017

Copyright © 2017, Rockwood Manufacturing Company, an ASSA ABLOY Group company. All rights reserved. Reproduction in whole or in part without the express written permission of Rockwood Manufacturing Company is prohibited.



### Thru Bolt Mounting - For 1 3/4" Wood and Metal Doors

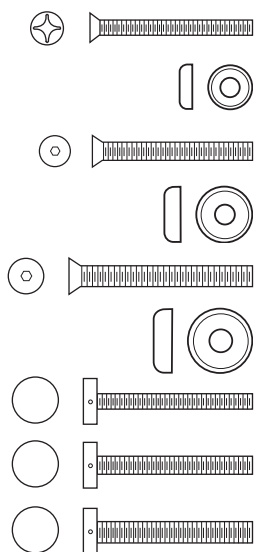

Part	Description	Mounting Type	Price
SP1004	1/4"-20 x 2 1/4" Flat Head Machine Screw Thru Bolt	1	1.50
SP1005	1/4"-20 Finishing Washer	1	0.90
SP1053	5/16"-18 x 2 1/2" Socket Flat Head Machine Screw Thru Bolt	1HD	3.20
SP1054	5/16"-18 Finishing Washer	1HD	1.20
SP1001	3/8"-16 x 2 1/2" Socket Flat Head Machine Screw Thru Bolt	1XHD	5.00
SP1002	3/8"-16 Finishing Washer	1XHD	1.50
SP1003	1" Diameter Decorative Thru Bolt 1/4"-20 x 2 1/4"	12	13.60
SP1055	1" Diameter Decorative Thru Bolt 5/16"-18 x 2 1/4"	12HD	16.20
SP1041	1 1/4" Diameter Decorative Thru Bolt 3/8"-16 x 2 1/4"	12XHD	16.20

### Back to Back Mounting - For 1 3/4" Wood and Metal Doors

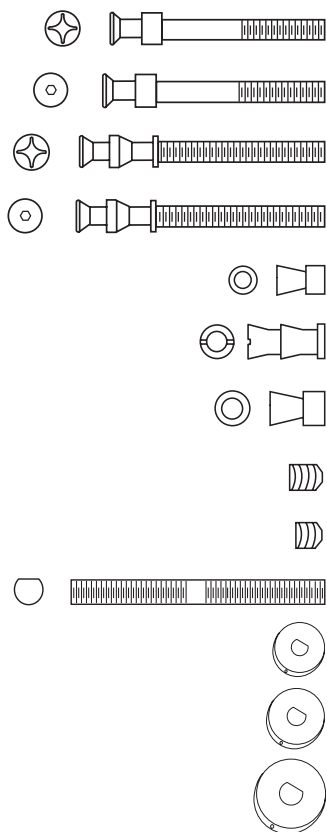

Part	Description	Mounting Type	Price
SP1025	1/4"-20 x 2 1/4" Cone Head Machine Screw	5	3.50
SP1056	5/16"-18 x 2 1/4" Cone Head Machine Screw	5HD	5.60
SP1052	1/4"-20 x 2 1/4" Double Cone Head Machine Screw (for use with offset pulls)	16	4.20
SP1057	5/16"-18 x 2 1/4" Double Cone Head Machine Screw (for use with offset pulls)	16HD	6.80
SP1027	1/4"-20 Cone Head Union (Used to Convert Cone Head to Thru Bolt Hole)	N/A	3.50
SP1079	1/4"-20 Double Cone Head Union (Used to Convert Double Cone Head to Thru Bolt Hole)	N/A	6.20
SP1068	5/16"-18 Cone Head Union (Used to Convert Cone Head to Thru Bolt Hole)	N/A	5.60
SP1026	1/4"-20 x 5/16" Set Screws (Standard)	N/A	0.90
SP1065	1/4"-20 x 3/16" Set Screw (Short)	N/A	1.10
SP1032	3/8"-16 x 2 7/8" LH/RH Bolt	11	7.40
SP1071	Spanner Collar 1" Diameter for LH/RH Bolt	11	11.10
SP1033	Spanner Collar 1 1/4" Diameter for LH/RH Bolt	11	11.10
SP1072	Spanner Collar 1 1/2" Diameter for LH/RH Bolt	11	12.40

Prices Effective September 1, 2017

Copyright © 2017, Rockwood Manufacturing Company, an ASSA ABLOY Group company. All rights reserved.  
Reproduction in whole or in part without the express written permission of Rockwood Manufacturing Company is prohibited.

**ASSA ABLOY**

The global leader in  
door opening solutions

## Concealed Mounting - For 1 3/4" Wood and Metal Doors

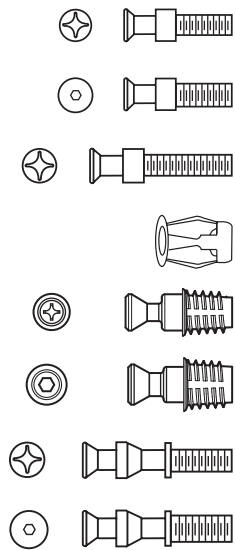

Part	Description	Mounting Type	Price
SP1039	1/4"-20 x 1 1/2" Cone Head Machine Screw	6 / 6R	3.50
SP1058	5/16"-18 x 1 1/2" Cone Head Machine Screw	6HD	5.60
SP1021	1/4"-20 x 1 1/8" Cone Head Machine Screw; For Use with Jack Nut - Type 7 Mount	7	3.50
SP1030	1/4"-20 Jack Nut Insert; Mounting Anchor for Concealed Mounting on Hollow Doors	7	3.70
SP1080	1/4"-20 Cone Head / Knife Thread Insert	8	5.90
SP1082	5/16"-18 Cone Head / Knife Thread Insert	8HD	5.90
SP1051	1/4"-20 x 1 1/2" Double Cone Head Machine Screw	17 / 17R	5.60
SP1059	5/16"-18 x 1 1/2" Double Cone Head Machine Screw	17HD	6.80

## Bushings &amp; Washers - For 1/2" Glass Doors

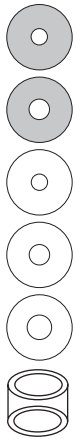

Part	Description	Mounting Type	Price
SP1022	Stainless Steel Washer for 1/4"-20 Cone Head Machine Screw .032" Thick	13	1.50
SP1060	Stainless Steel Washer for 5/16"-18 Cone Head Machine Screw .060" Thick	13HD	1.50
SP1023	Plastic Washer for 1/4"-20 Bolt; Specify Size	13	1.30
SP1061	Plastic Washer for 5/16"-18 Bolt; Specify Size	13HD	1.40
SP1062	Plastic Washer for 3/8"-16 Bolt; Specify Size	14	1.40
SP1024	Glass Door Bushing for 5/8" Hole in Glass; Specify Size	13 / 13HD / 14	1.50

## Thru Bolt Mounting - For 1/2" Glass Doors

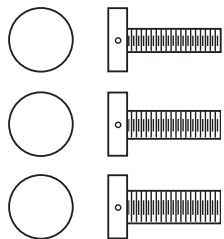

Part	Description	Mounting Type	Price
SP1020	1" Diameter Decorative Thru Bolt; 1/4"-20 x 1 1/8"	15	13.60
SP1063	1" Diameter Decorative Thru Bolt; 5/16"-18 x 1 1/8"	15HD	16.20
SP1040	1 1/4" Diameter Decorative Thru Bolt; 3/8"-16 x 1 1/8"	15XHD	16.20

**ASSA ABLOY**The global leader in  
door opening solutions

Prices Effective September 1, 2017

Copyright © 2017, Rockwood Manufacturing Company, an ASSA ABLOY Group company. All rights reserved.  
Reproduction in whole or in part without the express written permission of Rockwood Manufacturing Company is prohibited.

## Back to Back Mounting - For 1/2" Glass Doors

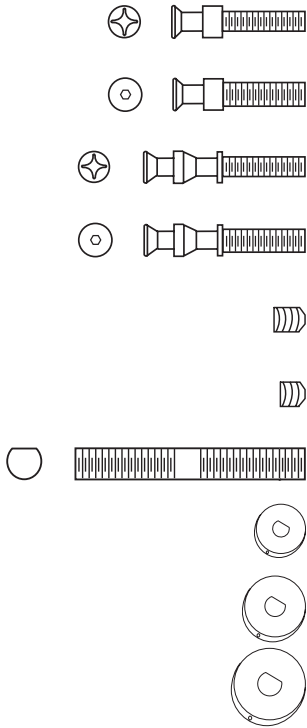

Part	Description	Mounting Type	Price
SP1021	1/4"-20 x 1 1/8" Cone Head Machine Screw	13	3.50
SP1064	5/16"-18 x 1 1/8" Cone Head Machine Screw	13HD	5.60
SP1067	1/4"-20 x 1 1/8" Double Cone Head Machine Screw	18	5.60
SP1066	5/16"-18 x 1 1/8" Double Cone Head Machine Screw	18HD	6.80
SP1026	1/4"-20 x 5/16" Set Screw (Standard)	N/A	0.90
SP1065	1/4"-20 x 3/16" Set Screw (Short)	N/A	1.10
SP1031	3/8"-16 x 1 3/4" LH/RH Bolt	14	7.40
SP1071	Spanner Collar 1" Diameter for LH/RH Bolt	14	11.10
SP1033	Spanner Collar 1 1/4" Diameter for LH/RH Bolt	14	11.10
SP1072	Spanner Collar 1 1/2" Diameter for LH/RH Bolt	14	12.40

## Y Base Plates

Specify bolt hole size and finish. Standard pulls require two plates.

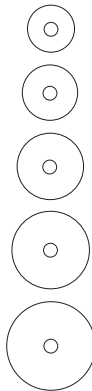

Part	Description	For Use With	Price
SP1073	1/8" Thick x 1 1/16" Diameter	3/4" Diameter Pulls	13.60
SP1074	1/8" Thick x 1 1/4" Diameter	1" Diameter Pulls and Posts	13.60
SP1075	1/8" Thick x 1 1/2" Diameter	1" Diameter Pulls and Posts	13.60
SP1076	1/8" Thick x 1 3/4" Diameter	1" Diameter Pulls and Posts	13.60
SP1077	1/8" Thick x 2" Diameter	1" Diameter Pulls and Posts	13.60

## Flush Pull Fasteners

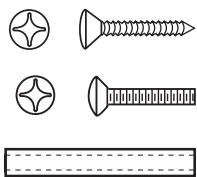

Part	Description	Door Type	Price
SP1006	#8 x 3/4" Oval Head Sheet Metal Screw	Wood or Metal	0.60
SP1007	#8-32 x 3/4" Oval Head Machine Screw	Metal	0.60
SP1034	#8-32 x 1 5/8" Brass Sleeve Machine Screw	Wood or Metal	3.70

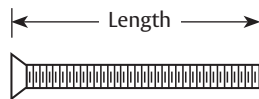

Standard Thru Bolt for Countersunk Holes

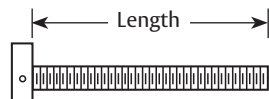

Decorative Thru Bolt for Wood or Metal Doors

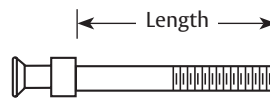

Cone Head Bolt for Back-to-Back Wood or Metal Doors

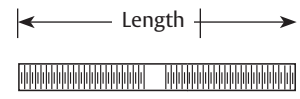

LH/RH Bolt without Heads

## Mounting Kits for Door Pulls

Part	Mounting Type	Description	Price
<b>KIT1</b>	1	2 ea. 1/4"-20 x 2 1/4" Thru Bolts and 2 ea. Finish Washers; Specify Finish	4.10
<b>KIT1HD</b>	1HD	2 ea. 5/16"-18 x 2 1/2" Thru Bolts and 2 ea. Finish Washers; Specify Finish	8.10
<b>KIT1XHD</b>	1XHD	2 ea. 3/8"-16 x 2 1/2" Thru Bolts and 2 ea. Finish Washers; Specify Finish	11.90
<b>KIT5</b>	5	2 ea. 1/4"-20 x 2 1/4" Cone Head Bolts and 2 ea. Set Screws	8.10
<b>KIT5HD</b>	5HD	2 ea. 5/16"-18 x 2 1/4" Cone Head Bolts and 4 ea. Set Screws	12.10
<b>KIT6</b>	6	2 ea. 1/4"-20 x 1 1/2" Cone Head Bolts and 2 ea. Set Screws	8.10
<b>KIT6HD</b>	6HD	2 ea. 5/16"-18 x 1 1/2" Cone Head Bolts and 4 ea. Set Screws	12.10
<b>KIT11</b>	11	2 ea. 3/8"-16 x 3 1/2" LH/RH Bolt and 2 ea. Spanner Collars for 1 3/4" Doors; Specify Pull Diameter and Finish	30.90
<b>KIT12-1</b>	12	2 ea. 1/4"-20 x 2 1/4" Decorative Thru Bolts; 1" Dia.; Specify Finish	27.20
<b>KIT12-1HD</b>	12HD	2 ea. 5/16"-18 x 2 1/4" Decorative Thru Bolts; 1" Dia.; Specify Finish	32.50
<b>KIT12-1.25XHD</b>	12XHD	2 ea. 3/8"-16 x 2 1/4" Decorative Thru Bolts; 1 1/4" Dia.; Specify Finish	35.50
<b>KIT12-1.5XHD</b>	12XHD	2 ea. 3/8"-16 x 2 1/4" Decorative Thru Bolts; 1 1/2" Dia.; Specify Finish	41.30
<b>KIT13</b>	13	2 ea. 1/4"-20 x 1 1/8" Cone Head Bolts; 2 ea. Metal Washers; 4 ea. Plastic Washers; 2 ea. Bushings for 1/2" Glass Doors; 2 ea. Set Screws; Specify if other than 1/2" Glass	15.00
<b>KIT13HD</b>	13HD	2 ea. 5/16"-18 x 1 1/8" Cone Head Bolts; 2 ea. Metal Washers; 4 ea. Plastic Washers; 2 ea. Bushings for 1/2" Glass Doors; 4 ea. Set Screws; Specify if other than 1/2" Glass	18.90
<b>KIT14</b>	14	2 ea. 3/8"-16 x 2 1/4" LH/RH Bolt; 2 ea. Spanner Collars; 2 ea. Bushings; 4 ea. Washers for 1/2" Glass Doors; Specify Pull Diameter and Finish	36.90
<b>KIT15</b>	15	2 ea. 1/4"-20 x 1 1/8" Decorative Thru Bolts; 1" Dia.; 2 ea. Bushings; 4 ea. Plastic Washers; Specify Finish and Glass Thickness/Hole Size	32.50
<b>KIT15HD</b>	15HD	2 ea. 5/16"-18 x 1 1/8" Decorative Thru Bolts; 1" Dia.; 2 ea. Bushings; 4 ea. Plastic Washers; Specify Finish and Glass Thickness/Hole Size	38.10
<b>KIT15-1.25XHD</b>	15XHD	2 ea. 3/8"-16 x 1 1/8" Decorative Thru Bolts; 1 1/4" Dia.; 2 ea. Bushings; 4 ea. Plastic Washers; Specify Finish and Glass Thickness/Hole Size	41.30
<b>KIT15-1.5XHD</b>	15XHD	2 ea. 3/8"-16 x 1 1/8" Decorative Thru Bolts; 1 1/2" Dia.; 2 ea. Bushings; 4 ea. Plastic Washers; Specify Finish and Glass Thickness/Hole Size	47.30
<b>KIT16</b>	16	2 ea. 1/4"-20 x 2 1/4" Double Cone Head Bolts and 4 ea. Set Screws	12.10
<b>KIT16HD</b>	16HD	2 ea. 5/16"-18 x 2 1/4" Double Cone Head Bolts and 4 ea. Set Screws	15.00

Part	Mounting Type	Description	Price
<b>KIT17</b>	17	2 ea. 1/4"-20 x 1 1/2" Double Cone Head Bolts and 4 ea. Set Screws	12.10
<b>KIT17HD</b>	17HD	2 ea. 5/16"-18 x 1 1/2" Double Cone Head Bolts and 4 ea. Set Screws	15.00
<b>KIT18</b>	18	2 ea. 1/4"-20 x 1 1/8" Double Cone Head Bolts; 2 ea. Metal Washers; 4 ea. Plastic Washers; 2 ea. Bushings for 1/2" Glass Doors; Specify if other than 1/2" Glass and 4 ea. Set Screws	20.80
<b>KIT18HD</b>	18HD	2 ea. 5/16"-18 x 1 1/8" Double Cone Head Bolts; 2 ea. Metal Washers; 4 ea. Plastic Washers; 2 ea. Bushings for 1/2" Glass Doors; Specify if other than 1/2" Glass and 4 ea. Set Screws	23.80
<b>KIT-T1</b>	T1	1 ea. 1/4"-20 X 2 1/4" Cone Head Bolt; 1 ea. 1/4"-20 Cone Head Union; 2 ea. Set Screws; 2 ea. 1/4"-20 x 1 1/4" — 1" Dia. Decorative Thru Bolts; Specify Finish	35.40
<b>KIT-T2</b>	T2	1 ea. 1/4"-20 X 1 1/8" Cone Head Bolt; 1 ea. 1/4"-20 Cone Head Union; 2 ea. Set Screws; 2 ea. 1/4"-20 x 1 1/8" — 1" Dia. Decorative Thru Bolts; 1 ea. Metal Washer; 6 ea. Plastic Washers; 3 ea. Bushings; Specify Finish	44.10
<b>KIT-T3</b>	T3	1 ea. 1/4"-20 X 2 1/4" Cone Head Bolt; 1 ea. 1/4"-20 Cone Head Union; 2 ea. Set Screws; 2 ea. 1/4"-20 x 1 1/4" Thru Bolts; 2 ea. Finish Washers; Specify Finish	12.10
<b>KIT-T4</b>	T4	1 ea. 1/4"-20 X 2 1/4" Cone Head Bolt; 2 ea. 1/4"-20 x 1 1/2" Cone Head Bolts; 3 ea. Set Screws	12.10
<b>KIT-T5</b>	T5	1 ea. 1/4"-20 X 2 1/4" Cone Head Bolt; 2 ea. 1/4"-20 x 1 1/2" Cone Head Wood Screws; 3 ea. Set Screws	12.10
<b>KITRM1.25</b>	11x1XHD	2 ea. 3/8"-16 x 2 1/2" Thru-Bolts; 2 ea. Finish Washers; 1 ea. 3/8"-16 x 3 1/2" LH/RH Bolt; 1 ea. 1 1/4" Spanner Collar; Specify Finish	27.50
<b>KITRM360</b>	11x12XHD	2 ea. 3/8"-16 x 2 1/4" Decorative Thru Bolts 1 1/4" Dia.; 1 ea. 3/8"-16 x 3 1/2" LH/RH Bolt; 1 ea. 1 1/4" Spanner Collar; Specify Finish	50.90
<b>KITRM360G</b>	14x15XHD	2 ea. 3/8"-16 x 2 1/4" Decorative Thru Bolts 1 1/4" Dia.; 1 ea. 3/8"-16 x 2 1/4" LH/RH Bolt; 1 ea. 1 1/4" Spanner Collar; 3 ea. Bushings; 6 ea. Plastic Washers; Specify Finish	59.80
<b>KITRM1.5</b>	11x1XHD	2 ea. 3/8"-16 x 2 1/2" Thru Bolts; 2 ea. Finish Washers; 1 ea. 3/8"-16 x 3 1/2" LH/RH Bolt; 1 ea. 1 1/2" Spanner Collar; Specify Finish	30.30
<b>KITRM380</b>	11x12XHD	2 ea. 3/8"-16 x 2 1/4" Decorative Thru Bolts 1 1/2" Dia.; 1 ea. 3/8"-16 x 3 1/2" LH/RH Bolt; 1 ea. 1 1/2" Spanner Collar; Specify Finish	59.80
<b>KITRM380G</b>	14x15XHD	2 ea. 3/8"-16 x 2 1/4" Decorative Thru Bolts 1 1/2" Dia.; 1 ea. 3/8"-16 x 1 1/4" LH/RH Bolt; 1 ea. 1 1/2" Spanner Collar; 3 ea. Bushings; 6 ea. Plastic Washers; Specify Finish	68.50

**ASSA ABLOY**

The global leader in door opening solutions

Prices Effective September 1, 2017

Copyright © 2017, Rockwood Manufacturing Company, an ASSA ABLOY Group company. All rights reserved. Reproduction in whole or in part without the express written permission of Rockwood Manufacturing Company is prohibited.

## Discontinued Products

Coat Hooks
RM809
RM810
RM824
RM825
RM826
RM827

IberMet - Cork Grip
RM2710N
RM2710R
RM2740N
RM2740R
RM2714N
RM2714R
RM2744N
RM2744R
RM1610N
RM1610R
RM1630N
RM1630R
RM1650N
RM1650R
RM1670N
RM1670R

Bronze Age - Copper Rich Grip
RM2810
RM2820
RM2840
RM2850
RM2814
RM2824
RM2844
RM2854
RM2812
RM2822
RM2816
RM2826

RM3100 MegaTek Series - See RM3300 MegaTek Series on pg. 17 for equivalent pulls.
RM3100
RM3110
RM3120
RM3130
RM3140
RM3150
RM3104
RM3114
RM3124
RM3134
RM3144
RM3154

AborMet – Square Wood Grip
RM4060
RM4062
RM4064
RM4066
RM4068

Classic - Finial Door Pulls
RM5600
RM5602
RM5604
RM5610
RM5612
RM5614

Notes

---

## Notes

---

ASSA ABLOY is the global leader in door opening solutions, dedicated to satisfying end-user needs for security, safety and convenience

**ASSA ABLOY**



300 Main Street  
Rockwood, Pennsylvania 15557  
P: 800-458-2424 • F: 800-922-9212  
[www.rockwoodmfg.com](http://www.rockwoodmfg.com) • [orders.rockwood@assaabloy.com](mailto:orders.rockwood@assaabloy.com)

(In Canada)  
Door Security Solutions Canada  
160 Four Valley Drive  
Vaughan, ON L4K 4T9  
P: 800-461-3007  
[www.assaabloy.ca](http://www.assaabloy.ca)