

# Architectural Door Accessories

**ASSA ABLOY**

The global leader in  
door opening solutions

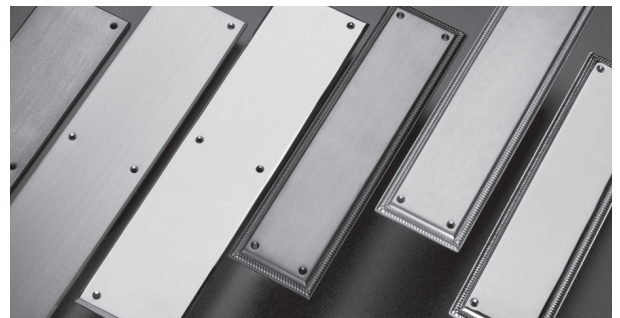
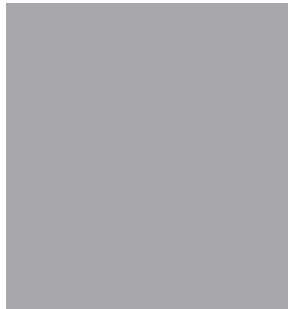
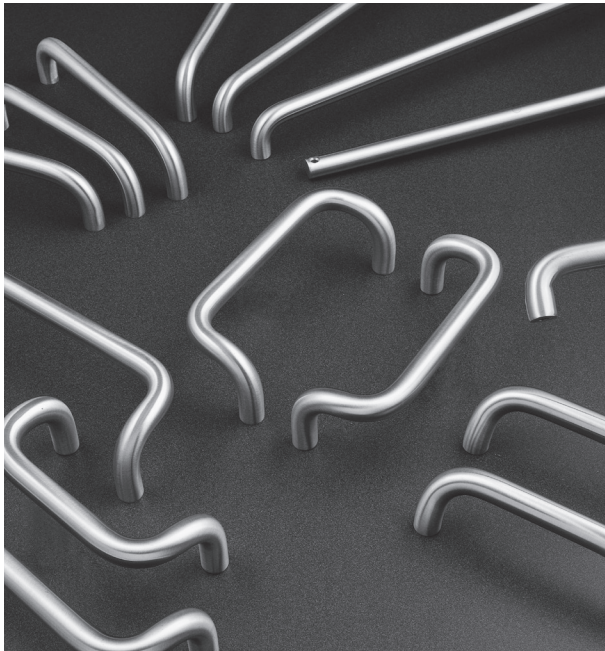

## Rockwood Products Price Book - Accessories

Prices Effective September 1, 2017



| Table of Contents                              | Page # |
|--|--------|
| Architectural Finishes                         | 33     |
| Angle Plates                                   | 29     |
| Auxiliary Hardware                             | 27     |
| Card Holder                                    | 25     |
| Coordinators                                   | 27     |
| Corner Guards                                  | 21     |
| Covers   | 28     |
| Custom Strikes                                 | 29     |
| Decals   | 25     |
| Door Edges                                     | 21-22  |
| Door Guards                                    | 25     |
| Door Knockers & Viewers                        | 25     |
| Door Plates - Kick Plates/Armor Plates         | 30-32  |
| Door Pulls                                     | 16-20  |
| Door Silencers                                 | 25     |
| Door Stops                                     | 23-24  |
| Fasteners - Spare Parts                        | 38-41  |
| Filler Plates & Shims                          | 29     |
| Flush Bolts                                    | 27     |
| Flush Bolts - Manual                           | 24     |
| Flush Bolts - Residential                      | 25     |
| Flush Pulls                                    | 15     |
| Gate Latch                                     | 24     |
| Gravity Door Coordinators                      | 24     |
| General Information                            | 8      |
| Hospital Latches                               | 24     |
| Latch Protectors                               | 22     |
| Mounting Details                               | 34-37  |
| Mounting Kits                                  | 42     |
| Numeric Index                                  | 4-7    |
| Overhead Holders & Stops                       | 28     |
| Pivots   | 29     |
| Privacy Door Latch                             | 25     |
| Pull Plate Sets                                | 14     |
| Pull Plates                                    | 20-21  |
| Push and Pull Bars                             | 9      |
| Push Plate Ordering Information                | 12     |
| Push Plates                                    | 13-15  |
| Roller Latches                                 | 24     |
| Series 47 Push Bars                            | 10     |
| Series 47 Tubular Push & Pull Bars             | 11     |
| Signs  | 26     |
| Surface Bolts                                  | 24-25  |
| Trim Protector Bars                            | 29     |
| Vandal Resistant Trim & Vandal Resistant Pulls | 20     |
| Wall Guard                                     | 25     |

Prices Effective September 1, 2017

Copyright © 2017, Rockwood Manufacturing Company, an ASSA ABLOY Group company. All rights reserved.  
 Reproduction in whole or in part without the express written permission of Rockwood Manufacturing Company is prohibited.

**ASSA ABLOY**

The global leader in  
 door opening solutions

| No.                 | Description                               | Page | No.                 | Description                   | Page |
|---------------------|---|------|---------------------|-------------------------------|------|
| 10-PB               | Push Bar .....                            | 9    | 102 x 70            | Pull Plates .....             | 20   |
| 10BO                | Bracket for #10.....                      | 9    | 105                 | Straight Door Pull.....       | 16   |
| 11-PB – 18-PB       | Push Bars.....                            | 9    | 105 x 70            | Pull Plates .....             | 20   |
| 19-PB               | Push Bar .....                            | 9    | 106-RKW             | Straight Door Pull.....       | 16   |
| 20-PB – 23-PB       | Pull Bars.....                            | 9    | 106 x 70            | Pull Plates .....             | 20   |
| 25-PB – 26-PB       | Push Bars.....                            | 9    | 107                 | Straight Door Pull.....       | 16   |
| 27-PB – 30-PB       | Push Pull Bar Sets .....                  | 9    | 107 x 70            | Pull Plates .....             | 20   |
| 31-PB – 32-PB       | Pull Bars.....                            | 9    | 107 x 73B/73BL      | Pull Plate Set.....           | 14   |
| 33-PB – 34-PB       | Push Bars.....                            | 9    | 107BTB5 – 112BTB5   | Straight Door Pull Sets ..... | 16   |
| 35-PB – 36-PB       | Push Pull Bar Sets .....                  | 9    | 108 – 110-RKW       | Straight Door Pull.....       | 16   |
| 40-PB – 42-PB       | Screen Door Guards.....                   | 9    | 110 x 70            | Pull Plates .....             | 20   |
| 43-PB – 45-PB       | Push Bars.....                            | 9    | 110 x 73C/73CL      | Pull Plate Set.....           | 14   |
| 47-PB, -2-PB, -3-PB | Series 47 Push Bars .....                 | 10   | 110BTB13 – 112BTB13 | Straight Door Pull Sets ..... | 16   |
| 48-PB               | Series 47 Push Bar.....                   | 10   | 110-6SP             | Security Door Pull .....      | 16   |
| 50-PB               | Pull Bar.....                             | 9    | 111-RKW, 111A       | Straight Door Pull.....       | 16   |
| 51-PB               | Push Bar .....                            | 9    | 111 x 70            | Pull Plates .....             | 20   |
| 51BO                | Bracket for #50.....                      | 9    | 111 x 73C/73CL      | Pull Plate Set.....           | 14   |
| 52-PB               | Push Pull Bar Set .....                   | 9    | 112                 | Straight Door Pull.....       | 16   |
| 53-PB               | Push Pull Bar Set .....                   | 9    | 118                 | Straight Door Pull.....       | 16   |
| 70 Series           | Push Plates - .050" Thick .....           | 13   | 120 – 122-RKW       | Door Pulls .....              | 17   |
| 71 Series           | Push Plates - .062" Thick .....           | 13   | 122 x 70            | Pull Plates .....             | 20   |
| 73 Series           | Push Plates - .125" Thick .....           | 14   | 123                 | Door Pull.....                | 17   |
| 75 Series           | Push Plates - .125" Thick .....           | 14   | 123 x 70            | Pull Plates .....             | 20   |
| 76 Series           | Decorative Push Plates - .050" Thick..... | 14   | 125-RKW             | Door Pull.....                | 17   |
| 77 Series           | Decorative Push Plates - .050" Thick..... | 14   | 125 x 70            | Pull Plates .....             | 20   |
| 80 – 86             | Push Plates - .050" Thick .....           | 15   | 126-RKW             | Door Pull.....                | 17   |
| 87                  | Push Plate - .125" Thick .....            | 15   | 126 x 70            | Pull Plates .....             | 20   |
| 90, 90B             | Cylinder Pulls .....                      | 15   | 130-RKW – 132-RKW   | Cast Door Pulls .....         | 17   |
| 91-RKW – 93-RKW     | Combination Push Pull Plates.....         | 15   | 132 x 70            | Pull Plates .....             | 20   |
| 94, 94BTB           | Flush Pulls.....                          | 15   | 134-RKW – 137       | Cast Door Pulls .....         | 17   |
| 94C                 | Flush Pull.....                           | 15   | 137 x 70            | Pull Plates .....             | 20   |
| 94DLL, 94DLS        | Dead Lock Flush Pulls.....                | 15   | 138 – 139           | Cast Door Pulls .....         | 17   |
| 94L, 94P            | Flush Pulls.....                          | 15   | 147, 147L           | Cast Door Pulls .....         | 17   |
| 94P x 94L           | Flush Pull Set .....                      | 15   | 147 x 76, 77        | Decorative Pull Plates .....  | 21   |
| 95A, 95B            | Flush Pulls.....                          | 15   | 148                 | Cast Door Pull .....          | 17   |
| 95R                 | Flush Pull - Round.....                   | 15   | 148 x 76, 77        | Decorative Pull Plates .....  | 21   |
| 96                  | Flush Pull.....                           | 15   | 149                 | Cast Door Pull .....          | 17   |
| 102-RKW             | Straight Door Pull.....                   | 16   | 176-RKW – 177       | Offset Door Pulls.....        | 19   |

## ASSA ABLOY

The global leader in  
 door opening solutions

Prices Effective September 1, 2017

Copyright © 2017, Rockwood Manufacturing Company, an ASSA ABLOY Group company. All rights reserved.  
 Reproduction in whole or in part without the express written permission of Rockwood Manufacturing Company is prohibited.

| No.            | Description                         | Page | No.            | Description  | Page |
|----------------|-------------------------------------|------|----------------|--|------|
| 185            | Offset Door Pull.....               | 19   | 505-RKW – 508  | Cast Brass Door Stops.....                               | 24   |
| 193            | Hospital Door Pull.....             | 19   | 517            | Aluminum Door Stop .....                                 | 24   |
| 208            | Wooden Door Pull .....              | 19   | 518 – 519      | Cast Brass Door Stops.....                               | 24   |
| 215, 215L      | Tapered Door Pulls.....             | 19   | 520            | Replacement Bumper .....                                 | 24   |
| 290 – 296      | Corner Guards .....                 | 21   | 525 – 526      | Spring Base Door Stops .....                             | 24   |
| 300 – 302B     | Mortise Door Edges.....             | 21   | 528            | Hinge Pin Stop.....                                      | 24   |
| 304 – 307      | Non-Mortise Door Edges .....        | 22   | 550 Series     | Lever Ext. Flush Bolt, Guide & Strike.....               | 24   |
| 308 – 310B-BS  | Overlapping Door Edges .....        | 22   | 554 Series     | Rabbit Piece, Guide & Strike .....                       | 24   |
| 320-RKW – 330  | Latch Protectors .....              | 22   | 555 Series     | Lever Ext. Flush Bolt, Bolt Head,<br>Guide & Strike..... | 24   |
| 400 – 405      | Solid Cast Wall Stops .....         | 23   | 555ROD         | Optional Bolt Lengths .....                              | 24   |
| 406 – 409      | Wrought Wall Stops.....             | 23   | 555 x BFB      | Flush Bolt w/Bottom Fire Bolt .....                      | 24   |
| 412 – 416      | Solid Cast Wall Stops .....         | 23   | 556WS          | Lever Ext. Wind Storm Flush Bolt .....                   | 24   |
| 426            | Wall Stop .....                     | 23   | 557 Series     | Lever Ext. Flush Bolt & Strike .....                     | 24   |
| 430-RKW        | Solid Cast Wall Stop .....          | 23   | 570            | Dust Proof Strike.....                                   | 24   |
| 431-RKW, 432W  | Wall Stops .....                    | 23   | 576, 576B      | Gravity Door Coordinator.....                            | 24   |
| 438 – 439      | Light Duty Dome Stops .....         | 23   | 580 Series     | Surface Bolts .....                                      | 24   |
| 440 – 441      | Low Dome Stops .....                | 23   | 582 Series     | Surface Bolts .....                                      | 24   |
| 441CU          | Dome Stop Combination Unit.....     | 23   | 585 Series     | Heavy Duty Surface Bolts.....                            | 24   |
| 441H           | Cast Universal Dome Stop.....       | 23   | 590 – 594      | Roller Latches .....                                     | 24   |
| 442 – 443      | High Dome Stops.....                | 23   | 596 Series     | Hospital Push Pull Latches.....                          | 24   |
| 444            | Cast Door Stop Riser .....          | 23   | 602            | Secret Gate Latch .....                                  | 24   |
| 445, 445H      | Heavy Duty Door Stops .....         | 23   | 603 – 604 Shim | Door Guards w/Shim .....                                 | 25   |
| 446            | Door Stop.....                      | 23   | 605, 605SMS    | Door Guard Protection Plates.....                        | 25   |
| 449            | Door Stop Riser.....                | 23   | 606-RKW        | Wall Guard .....   | 25   |
| 455            | Curved Roller Stop .....            | 23   | 607 (PDL)      | Privacy Door Latch.....                                  | 25   |
| 456-RKW, 456L  | Straight Roller Stops .....         | 23   | 608-RKW – 609  | Door Silencers .....                                     | 25   |
| 458            | Kick Down Door Stop.....            | 23   | 611            | Door Knocker.....  | 25   |
| 459            | Spring Loaded Plunger Stop .....    | 23   | 614, 614V      | Door Knockers.....                                       | 25   |
| 460 – 461L     | Kick Down Door Stops .....          | 23   | 619            | 160° Door Viewer .....                                   | 25   |
| 462 – 468-RKW  | Heavy Duty Door Stops .....         | 23   | 620            | 160° Door Viewer .....                                   | 25   |
| 470 – 481      | Door Stops.....                     | 23   | 620VC          | Viewer Cover for 619.....                                | 25   |
| 481MP          | Heavy Duty Mounting Plate.....      | 23   | 621            | 160° Door Viewer .....                                   | 25   |
| 482 – 485      | Door Stops.....                     | 23   | 622            | 190° Door Viewer .....                                   | 25   |
| 486            | Angle Door Stop .....               | 23   | 622VC          | Viewer Cover for 622.....                                | 25   |
| 487            | Heavy Duty Wall Stop.....           | 23   | 624            | 160° Door Viewer w/Cover .....                           | 25   |
| 488 – 489      | Door Stops.....                     | 24   | 626 – 629      | 190° Door Viewers w/Cover .....                          | 25   |
| 490            | Door Holder & Stop .....            | 24   | 630 Series     | Surface Bolts .....                                      | 25   |
| 491-RKW – 494S | Automatic Door Holders & Stops..... | 24   |                |  |      |

| No.               | Description                              | Page | No.                 | Description  | Page |
|-------------------|--|------|---------------------|--|------|
| 640, 640RE        | Residential Flush Bolts .....            | 25   | BF150 – BF159       | 90° Offset Door Pulls .....                        | 18   |
| 651               | Card Holder .....                        | 25   | BF156 – BF159 BTB16 | 90° Offset Door Pull Sets.....                     | 18   |
| 660, 661, 662-RKW | Decals .....                             | 25   | BF156 – BF159 C17   | 90° Offset Door Pull Sets.....                     | 18   |
| 670 Series        | Engraved Signs.....                      | 26   | BF160 – BF169       | 45° Offset Door Pulls .....                        | 19   |
| 674H, 674L        | Engraved Signs.....                      | 26   | BF257 – BF260       | Heavy Duty Offset Door Pulls.....                  | 20   |
| 700 – 702         | Hand Rail Brackets.....                  | 27   | BF680 Series        | Engraved Signs w/Braille.....                      | 26   |
| 790               | Small Coat Hook.....                     | 27   | BF683 – BF689       | ADA Tactile Signs w/Braille .....                  | 26   |
| 796               | Small Double Coat Hook.....              | 27   | BF15647, -2, -3     | Offset Push Pull Bar Sets.....                     | 10   |
| 802, 806          | Medium Coat Hooks.....                   | 27   | BF15747, -2, -3     | Offset Push Pull Bar Sets.....                     | 10   |
| 841               | Ball Knob.....                           | 27   | BF157A47, -2, -3    | Offset Push Pull Bar Sets.....                     | 10   |
| 845               | Utility Pull.....                        | 27   | BF15847, -2, -3     | Offset Push Pull Bar Sets.....                     | 10   |
| 850 – 856-RKW     | Wire Pulls.....                          | 27   | BF15947             | Offset Push Pull Bar Set.....                      | 10   |
| 860               | Flush Cup Pull.....                      | 27   | BFLG10 – BFLG16     | Latch Guard Covers .....                           | 28   |
| 870               | Wrought Flush Pull .....                 | 27   | BFM682 – BFM689     | Tactile ADA Molded Plastic<br>Signs w/Braille..... | 26   |
| 872               | Cast Flush Pull .....                    | 27   | BFRC12, BFRC24      | Vertical Rod Covers .....                          | 28   |
| 880               | Cast Lever Edge Pull.....                | 27   | BP47, -2, -3        | Series 47 Push Bars w/Base Plate.....              | 10   |
| 885-RKW           | Concealed Edge Pull.....                 | 27   | CP10 – CP10HD       | Pivots - Standard Head .....                       | 29   |
| 890 – 891         | Pocket Door Pulls .....                  | 27   | CP20 – CP20HD       | Pivots - Standard Head Pivot .....                 | 29   |
| 900 – 901         | Magnetic Catches.....                    | 27   | CP40 – CP40HD       | Pivots - Standard Floor .....                      | 29   |
| 910 – 911         | Adjustable Ball Catches .....            | 27   | CP50 – CP50HD       | Pivots - Standard Floor Pivot.....                 | 29   |
| 1100              | Carry Bar .....                          | 27   | CPK2840             | Cover Plate Kit .....                              | 27   |
| 1700              | Door Coordinator .....                   | 27   | CS Series           | Custom Strikes .....                               | 29   |
| 2600 Series       | Door Coordinators .....                  | 27   | D89                 | Security Flush Pull .....                          | 15   |
| 2805              | Self Latching Flush Bolt (Top Only)..... | 27   | D133-RKW            | Security Loop Door Pull.....                       | 17   |
| 2840, 2842        | Automatic Flush Bolt Sets.....           | 27   | DF86                | Door Edge Filler Plate.....                        | 29   |
| 2845              | Combination Flush Bolt Set .....         | 27   | DFF4                | Frame Hinge Filler Plates .....                    | 29   |
| 2848, 2849        | Flush Bolts w/Bottom Fire Bolt .....     | 27   | DFF5                | Frame Hinge Filler Plates .....                    | 29   |
| 2905              | Self Latching Flush Bolt (Top Only)..... | 27   | DHF4B               | Door Hinge Filler Plates .....                     | 29   |
| 2940, 2942        | Automatic Flush Bolt Set.....            | 27   | DHF4S               | Door Hinge Filler Plates .....                     | 29   |
| 2945              | Combination Flush Bolt Set .....         | 27   | DHF5B               | Door Hinge Filler Plates .....                     | 29   |
| 2948, 2949        | Flush Bolts w/Bottom Fire Bolt .....     | 27   | DHF5S               | Door Hinge Filler Plates .....                     | 29   |
| 2960, 2962        | Automatic Flush Bolts .....              | 27   | FB-1, -2            | Filler Bars.....                                   | 27   |
| 11047, -2, -3     | Straight Push Pull Bar Sets .....        | 10   | FBF48               | Flush Bolt Filler Plate .....                      | 29   |
| 11147, -2, -3     | Straight Push Pull Bar Sets .....        | 10   | FBS48               | Flush Bolt Strike Filler Plate .....               | 29   |
| 111A47, -2, -3    | Straight Push Pull Bar Sets .....        | 10   | FC161               | Door Face Filler Plate.....                        | 29   |
| 11247, -2, -3     | Straight Push Pull Bar Sets .....        | 10   | FD160               | Door Face Filler Plate.....                        | 29   |
| 11847             | Straight Push Pull Bar Set .....         | 10   | HD2230              | Heavy Duty Trim Protector Bars .....               | 29   |
| BF97, BF97L       | Barrier Free Flush Pulls.....            | 15   |                     |  |      |

## ASSA ABLOY

The global leader in  
door opening solutions

Prices Effective September 1, 2017

Copyright © 2017, Rockwood Manufacturing Company, an ASSA ABLOY Group company. All rights reserved.  
Reproduction in whole or in part without the express written permission of Rockwood Manufacturing Company is prohibited.

| No.                        | Description  | Page | No.                   | Description                               | Page  |
|----------------------------|--|------|-----------------------|---|-------|
| HD2230M                    | Heavy Duty Trim Protector Bars .....               | 29   | R116EDPL              | Exit Device Protector .....               | 29    |
| HD2240                     | Heavy Duty Trim Protector Bars .....               | 29   | SD1230                | Standard Duty Trim Protector Bar .....    | 29    |
| HD2240M                    | Heavy Duty Trim Protector Bars .....               | 29   | SD1240                | Standard Duty Trim Protector Bar .....    | 29    |
| HD2250                     | Heavy Duty Trim Protector Bars .....               | 29   | SD1250                | Standard Duty Trim Protector Bar .....    | 29    |
| HD2250M                    | Heavy Duty Trim Protector Bars .....               | 29   | SD1260                | Standard Duty Trim Protector Bar .....    | 29    |
| HG70C                      | Push Plate - .050" Thick<br>Horizontal Grain ..... | 13   | SF160                 | Strike Filler Plate .....                 | 29    |
| HS42                       | 4 Hinge Shims .....                                | 29   | SFASA                 | Strike Filler Plate .....                 | 29    |
| HS44                       | 4 1/2" Hinge Shims .....                           | 29   | SFB160                | Strike Filler Plate .....                 | 29    |
| HS52                       | 5" Hinge Shims .....                               | 29   | SP47                  | Series 47 Push Bar .....                  | 10    |
| HS54                       | 5" Hinge Shims .....                               | 29   | SP1001 – SP1079       | Fasteners - Spare Parts .....             | 38-41 |
| K1038                      | Metal Door Plate - .038" Thick .....               | 31   | T47, -2, -3           | Tubular Push Bars .....                   | 11    |
| K1050, K1050F              | Metal Door Plates - .050" Thick .....              | 31   | T110 – T118           | Tubular Door Pulls .....                  | 16    |
| K1050-1 – K1050-8          | Shaped Metal Door Plates - .050" Thick .....       | 31   | T110 – T112 BTB5      | Tubular Door Pulls Sets .....             | 16    |
| K1050A-1 – K1050A-8        | Shaped Metal Door Plates - .050" Thick .....       | 31   | T110 – T112 BTB13     | Tubular Door Pulls Sets .....             | 16    |
| K1062                      | Metal Door Plate - .062" Thick .....               | 32   | T110 x 70             | Tubular Pull Plates .....                 | 21    |
| K1125                      | Metal Door Plate - .125" Thick .....               | 32   | T111 x 70             | Tubular Pull Plates .....                 | 21    |
| K2060 Series               | Plastic Door Plates - .060" Thick .....            | 32   | T11047                | Tubular Straight Push Pull Bar Sets ..... | 11    |
| K2125 Series               | Plastic Door Plates - .125" Thick .....            | 32   | T11147                | Tubular Straight Push Pull Bar Sets ..... | 11    |
| K3125                      | Laminate Plastic Door Plate - .125" Thick .....    | 32   | T111A47               | Tubular Straight Push Pull Bar Sets ..... | 11    |
| K4125                      | Clear Plastic Door Plate - .125" Thick .....       | 32   | T11247                | Tubular Straight Push Pull Bar Sets ..... | 11    |
| KB1150 – KB1152            | Angle Plates - .050" Thick .....                   | 29   | T11847                | Tubular Straight Push Pull Bar Set .....  | 11    |
| KIT Series                 | Mounting Kits for Door Pulls .....                 | 42   | TBF156 – TBF159       | Tubular 90° Offset Door Pulls .....       | 18    |
| LA86                       | Latch Adapter Plate .....                          | 29   | TBF156 – TBF159 BTB16 | Tubular 90° Offset Door Pull Sets .....   | 18    |
| LF161                      | Door Edge Filler Plate .....                       | 29   | TBF156 – TBF159 C17   | Tubular 90° Offset Door Pull Sets .....   | 18    |
| MFKIT                      | Multi-Function Friction & Hold Open Kit .....      | 28   | TBF15647              | Tubular Offset Push Pull Bar Sets .....   | 11    |
| OH100                      | HD Concealed Overhead Stops .....                  | 28   | TBF15747              | Tubular Offset Push Pull Bar Sets .....   | 11    |
| OH200                      | Concealed Overhead Holders & Stops .....           | 28   | TBF157A47             | Tubular Offset Push Pull Bar Sets .....   | 11    |
| OH900                      | HD Surface Overhead Stops .....                    | 28   | TBF15847              | Tubular Offset Push Pull Bar Sets .....   | 11    |
| OH1000                     | Surface Overhead Holders & Stops .....             | 28   | TBF15947              | Tubular Offset Push Pull Bar Set .....    | 11    |
| OH103-ALM -<br>OH1003S-ALM | Overhead Stops w/Aluminum Channel .....            | 28   | VRP30                 | Vandal Resistant Pull .....               | 20    |
| PDL (607)                  | Privacy Door Latch .....                           | 25   | VRT12 – VRT26         | Vandal Resistant Trim .....               | 20    |
| R101LPB                    | Trim Protector Bars .....                          | 29   | Y102 – Y112           | Straight Door Pulls w/Base Plates .....   | 17    |
| R102LPB                    | Trim Protector Bars .....                          | 29   | Y118                  | Straight Door Pulls w/Base Plate .....    | 17    |
| R111LPB                    | Trim Protector Bars .....                          | 29   | YBF150 – YBF159       | 90° Offset Door Pulls w/Base Plates ..... | 19    |
| R112LPB                    | Trim Protector Bars .....                          | 29   |                       |   |       |
| R115LPB                    | Trim Protector Bars .....                          | 29   |                       |   |       |
| R116EDPH                   | Exit Device Protector .....                        | 29   |                       |   |       |



## Ordering Information

This price list cancels and supersedes all prior listings.

Orders are accepted with the understanding that they will be billed at prices in effect at time of shipment.

Prices are subject to change without notice.

We reserve the right to decline the whole or part of orders in which the price or quantity of goods is not acceptable to us.

## Easy Order Placement

By Phone: 1-800-458-2424 Monday through Thursday 8:00 am ET to 7:00 pm ET, Friday 8:00 am ET to 4:30 pm ET

By Fax: Orders may be faxed to 1-800-922-9212

By Email: [orders.rockwood@assaabloy.com](mailto:orders.rockwood@assaabloy.com)

By Internet: <http://extranet.assaabloydss.com/> and select Order Entry under the Customer Service Menu

## Terms and Conditions of Sale

Terms: 1% 15 days, net 30 days

Remit Payment To: PNC Bank/Rockwood, PO Box 644489, Pittsburgh, PA 15264-4489

## Freight Policy

Freight Allowance: All prices are F.O.B. Rockwood, Pennsylvania. Full freight will be allowed on shipments of \$1,000 net and over within the continental limits of the United States (excluding Alaska and Hawaii). All shipments are routed most cost effective route of our choice. We reserve the right to designate the carrier.

## Special Order Material

Special items made to your specifications are not returnable. These items are not subject to cancellation without consideration of expense involved at the cancellation date.

## Samples

Salable samples will be charged at regular prices.

## Returned Goods

Return no merchandise without written permission from the factory. Authorization will insure your receiving proper credit. Errors in shipping may occasionally occur. If this is the case immediately notify the factory, and we will gladly make the proper adjustments. If the error is at the customer's end, a minimum charge of 25% plus freight will be incurred for handling. Unauthorized claims for labor or charges will not be allowed. No credit will be allowed beyond six months after invoice date.

## Shortages

Claims for shortages must be made within 30 days of invoice date.

## Templates

Upon request we will furnish templates for any of our standard items of manufacture. Commonly used templates are available on our website at [www.rockwoodmfg.com](http://www.rockwoodmfg.com).

## Product Weight Information

NOTE: Weights indicated throughout the price list are approximate for brass, bronze or stainless steel base material. Aluminum base materials weigh approximately  $\frac{1}{3}$  the listed weights.

## Engraving

Engraving may be added on many pulls. Call factory for pricing.

# ASSA ABLOY

The global leader in  
door opening solutions

Prices Effective September 1, 2017

Copyright © 2017, Rockwood Manufacturing Company, an ASSA ABLOY Group company. All rights reserved.  
Reproduction in whole or in part without the express written permission of Rockwood Manufacturing Company is prohibited.



## Push and Pull Bars

| Push and Pull Bars |        |                |                   |                  |                   |         |       |
|--------------------|--------|----------------|-------------------|------------------|-------------------|---------|-------|
| Part               | 28/628 | 3/605<br>4/606 | 10/612<br>10B/613 | Stock PC<br>10BE | 26/625<br>26D/626 | 32D/630 | 32DMS |
| 10-PB              |        | 354            | 354               | 351              | 342               |         |       |
| 10BO               |        | 114            | 114               | 113              | 111               |         |       |
| 11-PB              | 143    | 291            | 333               | 178              | 322               | 152     | 174   |
| 12-PB              | 143    | 291            | 333               | 178              | 322               | 152     | 174   |
| 14-PB              | 143    | 333            | 373               | 195              | 362               | 166     | 191   |
| 15-PB              | 143    | 333            | 373               | 195              | 362               | 166     | 191   |
| 18-PB              | 143    | 333            | 373               | 195              | 362               | 166     | 191   |
| 19-PB              | 143    | 333            | 373               | 195              | 362               | 166     | 191   |
| 20-PB              | 349    |                |                   | 427              |                   | 364     | 419   |
| 21-PB              | 395    | 827            | 1014              | 476              | 984               | 406     | 467   |
| 22-PB              | 402    |                |                   | 492              |                   | 420     | 483   |
| 23-PB              | 427    | 933            | 1117              | 517              | 1084              | 441     | 507   |
| 25-PB              | 137    |                |                   | 154              |                   | 131     | 151   |
| 26-PB              | 143    | 312            | 373               | 162              | 362               | 138     | 159   |
| 27-PB              | 615    |                |                   | 735              |                   | 627     | 721   |
| 28-PB              | 678    | 1447           | 1758              | 798              | 1707              | 681     | 783   |
| 29-PB              | 671    |                |                   | 798              |                   | 681     | 783   |
| 30-PB              | 709    | 1550           | 1861              | 840              | 1805              | 716     | 824   |

| Push and Pull Bars |        |                |                   |                  |                   |         |       |
|--------------------|--------|----------------|-------------------|------------------|-------------------|---------|-------|
| Part               | 28/628 | 3/605<br>4/606 | 10/612<br>10B/613 | Stock PC<br>10BE | 26/625<br>26D/626 | 32D/630 | 32DMS |
| 31-PB              | 350    |                |                   | 534              |                   | 456     | 524   |
| 32-PB              | 368    | 840            | 942               | 547              | 914               | 466     | 537   |
| 33-PB              | 303    |                |                   | 417              |                   | 356     | 410   |
| 34-PB              | 321    | 679            | 761               | 430              | 738               | 366     | 422   |
| 35-PB              | 518    |                |                   | 951              |                   | 812     | 933   |
| 36-PB              | 532    | 1518           | 1699              | 977              | 1648              | 834     | 959   |
| 40-PB              |        | 307            | 307               | 274              | 297               |         |       |
| 41-PB              |        | 217            | 217               | 194              | 210               |         |       |
| 42-PB              |        | 157            | 157               | 140              | 152               |         |       |
| 43-PB              | 162    | 487            | 583               | 345              | 565               | 294     | 338   |
| 44-PB              | 150    | 455            | 546               | 325              | 530               | 277     | 319   |
| 45-PB              | 141    | 413            | 495               | 307              | 480               | 263     | 301   |
| 50-PB              |        | 407            | 445               | 397              | 431               |         |       |
| 51-PB              |        | 163            | 179               | 161              | 173               |         |       |
| 51BO               |        | 32             | 36                | 32               | 35                |         |       |
| 52-PB              |        | 727            | 799               | 713              | 776               |         |       |
| 53-PB              |        | 139            | 156               | 140              | 151               |         |       |

## Push & Pull Extra Length Bars

| Extra Length Bars     |        |                |                   |                  |                   |         |
|-----------------------|--------|----------------|-------------------|------------------|-------------------|---------|
| Description           | 28/628 | 3/605<br>4/606 | 10/612<br>10B/613 | Stock PC<br>10BE | 26/625<br>26D/626 | 32D/630 |
| Over 3/4" thru 1 1/2" | 3      | 6              | 7                 | 7                | 6                 | 5       |
| Over 1 1/2" thru 3"   | 4      | 8              | 9                 | 9                | 8                 | 7       |

Bars over 36" add per inch the following additional cost.

## Mounting Types for Push Bars 10 through 45 and 50, 51, 52

Mounting charge included in list price.

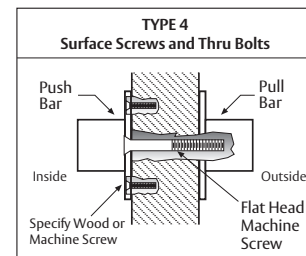
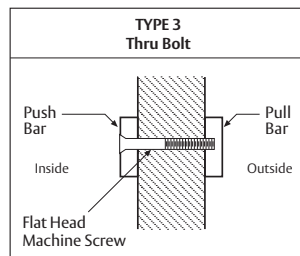
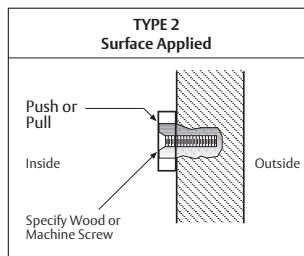
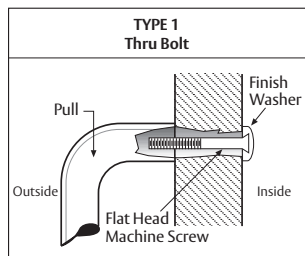

Series 47 Push Bars

| Series 47 Push Bars   |        |                           |                |                   |                  |                   |         |        |       |        |       |
|---|--------|---------------------------|----------------|-------------------|------------------|-------------------|---------|--------|-------|--------|-------|
| Part  | 28/628 | 313/710<br>314<br>315/711 | 3/605<br>4/606 | 10/612<br>10B/613 | Stock PC<br>10BE | 26/625<br>26D/626 | 32D/630 | 32/629 | 32DMS | 32D316 | 32316 |
| SP47  | 78     | 93                        | 235            | 294               | 242              | 226               | 211     | 242    | 239   | 274    | 294   |
| 47-PB   | 66     | 81                        | 221            | 221               | 223              | 215               | 193     | 217    | 220   | 256    | 268   |
| 47-2-PB   | 130    | 158                       | 442            | 442               | 445              | 428               | 386     | 435    | 440   | 509    | 534   |
| 47-3-PB   | 194    | 237                       | 662            | 662               | 667              | 642               | 579     | 652    | 659   | 763    | 801   |
| 48-PB   | 66     | 78                        | 174            | 205               | 141              | 168               | 113     | 153    | 139   | 164    | 187   |
| BP47  | 104    | 117                       | 259            | 259               | 259              | 250               | 227     | 254    | 256   | 293    | 305   |
| BP47-2  | 208    | 235                       | 553            | 553               | 554              | 537               | 489     | 544    | 548   | 621    | 645   |
| BP47-3  | 271    | 313                       | 786            | 786               | 789              | 763               | 694     | 773    | 780   | 888    | 926   |
| Straight Single Bar Sets  |        |                           |                |                   |                  |                   |         |        |       |        |       |
| 11047   | 94     | 112                       | 315            | 339               | 303              | 305               | 262     | 296    | 300   | 351    | 375   |
| 111A47  | 95     | 113                       | 318            | 355               | 305              | 308               | 264     | 303    | 302   | 355    | 380   |
| 11147   | 95     | 113                       | 318            | 355               | 312              | 308               | 270     | 309    | 309   | 362    | 386   |
| 11247   | 96     | 115                       | 330            | 366               | 321              | 321               | 278     | 315    | 317   | 372    | 398   |
| 11847   | 107    | 128                       | 376            | 414               | 347              | 365               | 303     | 345    | 343   | 409    | 433   |
| Straight Double Bar Sets  |        |                           |                |                   |                  |                   |         |        |       |        |       |
| 11047-2   | 158    | 191                       | 534            | 560               | 524              | 518               | 454     | 514    | 518   | 605    | 641   |
| 111A47-2  | 160    | 192                       | 538            | 574               | 527              | 522               | 458     | 519    | 521   | 609    | 645   |
| 11147-2   | 160    | 192                       | 538            | 574               | 534              | 522               | 464     | 525    | 528   | 615    | 653   |
| 11247-2   | 161    | 194                       | 551            | 586               | 542              | 534               | 470     | 531    | 536   | 628    | 664   |
| Straight Triple Bar Sets  |        |                           |                |                   |                  |                   |         |        |       |        |       |
| 11047-3   | 222    | 268                       | 754            | 780               | 746              | 732               | 648     | 731    | 737   | 858    | 908   |
| 111A47-3  | 223    | 269                       | 757            | 794               | 748              | 735               | 650     | 736    | 739   | 862    | 913   |
| 11147-3   | 223    | 269                       | 757            | 794               | 756              | 735               | 656     | 742    | 748   | 869    | 919   |
| 11247-3   | 225    | 272                       | 771            | 807               | 764              | 748               | 665     | 749    | 755   | 883    | 931   |
| Offset Single Bar Sets  |        |                           |                |                   |                  |                   |         |        |       |        |       |
| BF15647   | 111    | 134                       | 352            | 379               | 332              | 341               | 287     | 327    | 329   | 401    | 427   |
| BF157A47  | 115    | 139                       | 361            | 388               | 337              | 350               | 291     | 330    | 333   | 407    | 432   |
| BF15747   | 115    | 139                       | 361            | 388               | 343              | 350               | 295     | 334    | 339   | 412    | 439   |
| BF15847   | 123    | 146                       | 369            | 398               | 352              | 358               | 304     | 344    | 348   | 423    | 449   |
| BF15947   | 138    | 161                       | 401            | 425               | 380              | 389               | 330     | 371    | 375   | 458    | 485   |
| Offset Double Bar Sets  |        |                           |                |                   |                  |                   |         |        |       |        |       |
| BF15647-2   | 175    | 212                       | 573            | 600               | 554              | 555               | 480     | 544    | 548   | 656    | 693   |
| BF157A47-2  | 180    | 218                       | 581            | 609               | 559              | 564               | 485     | 547    | 552   | 660    | 699   |
| BF15747-2   | 180    | 218                       | 581            | 609               | 566              | 564               | 489     | 551    | 560   | 666    | 704   |
| BF15847-2   | 187    | 223                       | 590            | 616               | 573              | 572               | 496     | 562    | 567   | 677    | 716   |
| Offset Triple Bar Sets  |        |                           |                |                   |                  |                   |         |        |       |        |       |
| BF15647-3   | 240    | 290                       | 793            | 820               | 776              | 770               | 673     | 760    | 768   | 910    | 961   |
| BF157A47-3  | 244    | 297                       | 802            | 829               | 782              | 777               | 677     | 763    | 773   | 914    | 965   |
| BF15747-3   | 244    | 297                       | 802            | 829               | 787              | 777               | 681     | 769    | 778   | 921    | 972   |
| BF15847-3   | 252    | 302                       | 810            | 837               | 795              | 786               | 691     | 778    | 786   | 931    | 981   |
| Series 47 Extra Length Bars - Bars over 36" add per inch the following additional cost per bar. |        |                           |                |                   |                  |                   |         |        |       |        |       |
|   | 3      | 3                         | 4              | 4                 | 5                | 3                 | 3       | 5      | 5     | 5      | 6     |

See page 35 for detailed mounting drawings. Engraving "Push" or "Pull" on 1" Series 47 Push Bars add \$95.00 (1/2" Letter Height).



The global leader in door opening solutions

Prices Effective September 1, 2017

Copyright © 2017, Rockwood Manufacturing Company, an ASSA ABLOY Group company. All rights reserved. Reproduction in whole or in part without the express written permission of Rockwood Manufacturing Company is prohibited.

Series 47 Tubular Push & Pull Bars

| Series 47 Tubular Push Bars                |       |       |        |         |               |         |        |       |
|--|-------|-------|--------|---------|---------------|---------|--------|-------|
| Part                                       | 3/605 | 4/606 | 10/612 | 10B/613 | Stock PC 10BE | 32D/630 | 32/629 | 32DMS |
| T47  | 192   | 192   | 203    | 203     | 156           | 131     | 151    | 150   |
| T47-2                                      | 381   | 381   | 405    | 405     | 310           | 260     | 303    | 299   |
| T47-3                                      | 572   | 572   | 606    | 606     | 465           | 390     | 454    | 448   |
| Series 47 Tubular Straight Single Bar Sets |       |       |        |         |               |         |        |       |
| T11047                                     | 292   | 292   | 306    | 306     | 225           | 189     | 228    | 217   |
| T111A47                                    | 297   | 297   | 314    | 314     | 228           | 191     | 230    | 220   |
| T11147                                     | 297   | 297   | 314    | 314     | 228           | 191     | 230    | 220   |
| T11247                                     | 304   | 304   | 318    | 318     | 231           | 193     | 232    | 222   |
| T11847                                     | 318   | 318   | 332    | 332     | 243           | 204     | 246    | 234   |
| Series 47 Tubular Offset Single Bar Sets   |       |       |        |         |               |         |        |       |
| TBF15647                                   | 324   | 324   | 336    | 336     | 234           | 195     | 252    | 226   |
| TBF157A47                                  | 327   | 327   | 342    | 342     | 237           | 200     | 254    | 229   |
| TBF15747                                   | 327   | 327   | 342    | 342     | 237           | 200     | 254    | 229   |
| TBF15847                                   | 332   | 332   | 346    | 346     | 241           | 202     | 257    | 232   |
| TBF15947                                   | 348   | 348   | 365    | 365     | 258           | 216     | 272    | 248   |

See page 35 for detailed mounting drawings. Engraving "Push" or "Pull" on 1" Series 47 Push Bars add \$95.00 (1/2" Letter Height).

TYPICAL MOUNTING

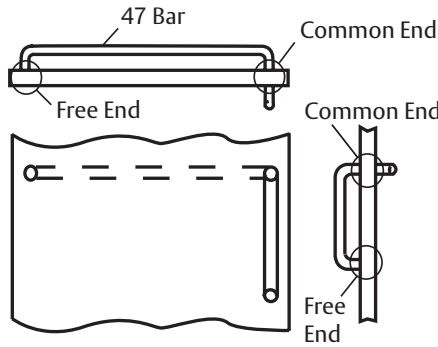

For Set Mounting Hardware, see page 34.

### Location Standards

Positioning Applications:

- door pulls to plates
- engraving on plates
- cutouts on plates
- cutout and engraving on plates

Sizing:

- 1 1/4" standard cylinder hole cutout size
- 3/8" diameter standard thumbturn hole
- other cutout sizes and styles are readily available

NOTE: Be sure the pull you choose will fit on the plate, allowing for cutouts and/or engraving.

### Pull Positioning on Plates 4" or Less in Width

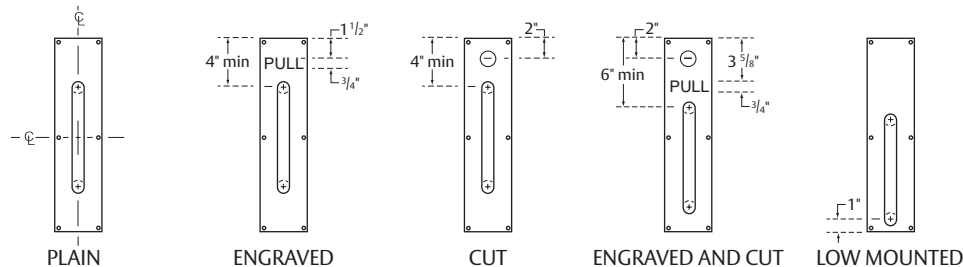

### Pull Positioning on Plates Wider than 4" (Handing Required)

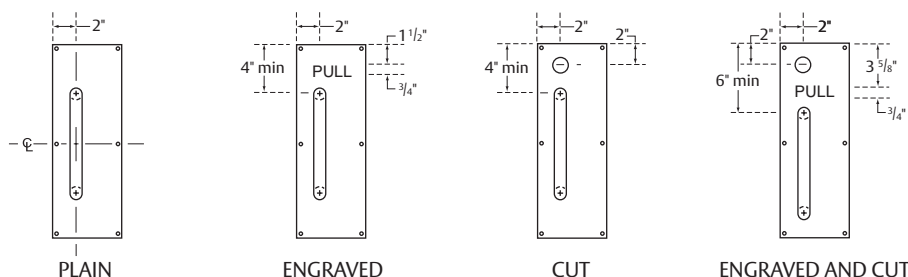

### Recommended Locations on Door

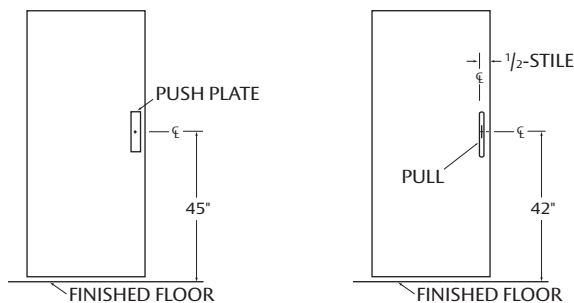

### Engraving and Adhesive Mounting

| Description                                | Price                       |
|--|-----------------------------|
| Engraving "Push", "Pull", "Men" or "Women" | 21 (24 for Stainless Steel) |
| Push Plate Adhesive Mounting               | 9                           |

Engraving: 3/4" high condensed block letters with black enamel fill; other letter sizes and styles are readily available.

### Additional Charges Per Thickness of Push Plate

| Part | Description       | 70 | 71 | 73 | 74 |
|------|-------------------|----|----|----|----|
| CFC  | Cut for Cylinder  | 2  | 3  | 5  | 9  |
| CFTT | Cut for Thumbturn | 2  | 3  | 5  | 9  |

### ADA Accessibility Guidelines for Buildings and Facilities (ADAAG)

as amended through January 1998 4.13.9 Door Hardware. Handles, pulls, latches, locks, and other operating devices on accessible doors shall have a shape that is easy to grasp with one hand and does not require tight grasping, tight pinching, or twisting of the wrist to operate. Lever-operated mechanisms, push-type mechanisms, and U-shaped handles are acceptable designs. When sliding doors are fully open, operating hardware shall be exposed and usable from both sides. Hardware required for accessible door passage shall be mounted no higher than 48 in. (1220 mm) above finished floor.

Push Plates - .050" Thick

| No. 70 - Square Ends         |        |                |                   |                  |                   |         |        |       |        |
|------------------------------|--------|----------------|-------------------|------------------|-------------------|---------|--------|-------|--------|
| Part                         | 28/628 | 3/605<br>4/606 | 10/612<br>10B/613 | Stock PC<br>10BE | 26/625<br>26D/626 | 32D/630 | 32/629 | 32DMS | 32D316 |
| 70A                          | 13     | 23             | 24                | 15               | 23                | 13      | 17     | 15    | 22     |
| 70B                          | 14     | 24             | 29                | 18               | 28                | 16      | 21     | 18    | 22     |
| 70C-RKW                      | 14     | 29             | 32                | 19               | 31                | 16      | 23     | 19    | 24     |
| 70E                          | 21     | 44             | 50                | 33               | 48                | 28      | 38     | 33    | 37     |
| 70F                          | 23     | 50             | 59                | 35               | 56                | 30      | 42     | 35    | 45     |
| 70G                          | 17     | 33             | 40                | 23               | 38                | 20      | 26     | 23    | 29     |
| No. 70RC - Round Corners     |        |                |                   |                  |                   |         |        |       |        |
| 70RCA                        | 17     | 27             | 28                | 18               | 27                | 16      | 20     | 18    | 25     |
| 70RCB                        | 19     | 29             | 33                | 22               | 32                | 19      | 24     | 22    | 25     |
| 70RCC                        | 19     | 32             | 36                | 24               | 35                | 21      | 26     | 24    | 27     |
| 70RCE                        | 24     | 47             | 53                | 37               | 51                | 32      | 42     | 37    | 43     |
| 70RCF                        | 26     | 54             | 63                | 40               | 61                | 35      | 46     | 40    | 49     |
| 70RCG                        | 21     | 36             | 44                | 27               | 42                | 23      | 29     | 26    | 32     |
| No. 70RE - Round Ends        |        |                |                   |                  |                   |         |        |       |        |
| 70REA                        | 23     | 32             | 34                | 26               | 33                | 22      | 26     | 25    | 31     |
| 70REB                        | 24     | 34             | 40                | 28               | 38                | 24      | 29     | 27    | 31     |
| 70REC                        | 25     | 38             | 44                | 31               | 42                | 26      | 32     | 30    | 32     |
| No. HG70C - Horizontal Grain |        |                |                   |                  |                   |         |        |       |        |
| HG70C                        | 14     | 29             |                   |                  |                   | 16      | 23     |       |        |

See page 12 for standard locations and sizes of Cylinder Cutouts (CFC) and Thumbturn Cutouts (CFTT), engraving and pricing.

Push Plates - .062" Thick

| No. 71 - Square Corners  |                  |         |       |
|--------------------------|------------------|---------|-------|
| Part                     | Stock PC<br>10BE | 32D/630 | 32DMS |
| 71A                      | 23               | 20      | 23    |
| 71B                      | 26               | 22      | 25    |
| 71C                      | 30               | 25      | 29    |
| 71E                      | 39               | 34      | 39    |
| 71F                      | 46               | 39      | 45    |
| 71G                      | 34               | 29      | 34    |
| No. 71RC - Round Corners |                  |         |       |
| 71RCA                    | 28               | 24      | 27    |
| 71RCB                    | 31               | 26      | 30    |
| 71RCC                    | 34               | 29      | 34    |
| 71RCE                    | 46               | 39      | 45    |
| 71RCF                    | 49               | 42      | 48    |
| 71RCG                    | 39               | 34      | 39    |
| No. 71RE - Round Ends    |                  |         |       |
| 71REA                    | 37               | 32      | 37    |
| 71REB                    | 39               | 34      | 39    |
| 71REC                    | 42               | 36      | 41    |

Concealed Mount Pull Plate Sets

| Pull Plate x Plate with Lug |         |       |               |
|-----------------------------|---------|-------|---------------|
| Part                        | 32D/630 | 32DMS | Stock PC 10BE |
| 107 x 73B/73BL              | 150     | 172   | 175           |
| 110 x 73C/73CL              | 197     | 226   | 230           |
| 111 x 73C/73CL              | 204     | 235   | 238           |

| Pull (only) x Plate with Lug |         |       |               |
|------------------------------|---------|-------|---------------|
| Part                         | 32D/630 | 32DMS | Stock PC 10BE |
| 107 x 73BL                   | 105     | 120   | 123           |
| 110 x 73CL                   | 147     | 169   | 171           |
| 111 x 73CL                   | 156     | 180   | 183           |

See page 12 for standard locations and sizes of Cylinder Cutouts (CFC) and Thumbturn Cutouts (CFTT), engraving and pricing. See page 36 for detail drawing of Type 9 mounting.

Push Plates

| No. 73 - Square Corners (.125" Thick)                     |                |                   |                   |                   |                   |         |        |       |        |
|---|----------------|-------------------|-------------------|-------------------|-------------------|---------|--------|-------|--------|
| Part  | 28/628         | 3/605<br>4/606    | 10/612<br>10B/613 | Stock PC<br>10BE  | 26/625<br>26D/626 | 32D/630 | 32/629 | 32DMS | 32D316 |
| 73A   | 26             | 71                | 85                | 50                | 82                | 43      | 61     | 49    | 56     |
| 73B   | 31             | 78                | 89                | 54                | 86                | 46      | 63     | 54    | 60     |
| 73C   | 32             | 85                | 95                | 59                | 92                | 50      | 69     | 58    | 67     |
| 73E   | 39             | 114               | 125               | 81                | 120               | 69      | 88     | 80    | 98     |
| 73F   | 46             | 142               | 153               | 99                | 148               | 85      | 100    | 98    | 110    |
| 73G   | 34             | 101               | 114               | 66                | 110               | 57      | 80     | 65    | 79     |
| No. 73RC - Round Corners (.125" Thick)                    |                |                   |                   |                   |                   |         |        |       |        |
| 73RCA   | 39             | 82                | 94                | 60                | 91                | 51      | 74     | 59    | 66     |
| 73RCB   | 41             | 87                | 99                | 64                | 96                | 55      | 75     | 63    | 70     |
| 73RCC   | 44             | 94                | 103               | 68                | 100               | 59      | 82     | 67    | 77     |
| 73RCE   | 52             | 124               | 133               | 92                | 129               | 79      | 101    | 90    | 108    |
| 73RCF   | 59             | 153               | 163               | 111               | 158               | 95      | 112    | 109   | 121    |
| 73RCG   | 47             | 110               | 124               | 76                | 119               | 65      | 91     | 75    | 89     |
| No. 73RE - Round Ends (.125" Thick)                       |                |                   |                   |                   |                   |         |        |       |        |
| 73REA   | 58             | 98                | 110               | 79                | 107               | 67      | 89     | 78    | 83     |
| 73REB   | 62             | 103               | 116               | 82                | 112               | 70      | 91     | 81    | 87     |
| 73REC   | 63             | 110               | 121               | 88                | 117               | 76      | 98     | 87    | 94     |
| Laminate and Clear Plastic - Square Corners (.125" Thick) |                |                   |                   |                   |                   |         |        |       |        |
| Part  | Black          | Brown             | Gray              | Beige             | Clear             |         |        |       |        |
| 75A   | 13             | 13                | 13                | 13                | 13                |         |        |       |        |
| 75B   | 14             | 14                | 14                | 14                | 14                |         |        |       |        |
| 75C   | 14             | 14                | 14                | 14                | 15                |         |        |       |        |
| 75E   | 18             | 18                | 17                | 17                | 18                |         |        |       |        |
| 75F   | 20             | 20                | 19                | 19                | 20                |         |        |       |        |
| 75G   | 17             | 17                | 16                | 16                | 17                |         |        |       |        |
| Decorative (.050" Thick)                                  |                |                   |                   |                   |                   |         |        |       |        |
| Part  | 3/605<br>4/606 | 10/612<br>10B/613 | Stock PC<br>10BE  | 26/625<br>26D/626 |                   |         |        |       |        |
| 76B   | 42             | 46                | 42                | 44                |                   |         |        |       |        |
| 76C   | 45             | 49                | 45                | 47                |                   |         |        |       |        |
| 77B   | 42             | 46                | 42                | 44                |                   |         |        |       |        |
| 77C   | 45             | 49                | 45                | 47                |                   |         |        |       |        |

See page 12 for standard locations and sizes of Cylinder Cutouts (CFC) and Thumbturn Cutouts (CFTT), engraving and pricing.

**ASSA ABLOY**

The global leader in door opening solutions

Prices Effective September 1, 2017

Copyright © 2017, Rockwood Manufacturing Company, an ASSA ABLOY Group company. All rights reserved. Reproduction in whole or in part without the express written permission of Rockwood Manufacturing Company is prohibited.

## Push Plates (con't)

| <b>.050" Thick</b> |        |                |                   |                  |                   |         |        |       |        |
|--------------------|--------|----------------|-------------------|------------------|-------------------|---------|--------|-------|--------|
| Part               | 28/628 | 3/605<br>4/606 | 10/612<br>10B/613 | Stock PC<br>10BE | 26/625<br>26D/626 | 32D/630 | 32/629 | 32DMS | 32D316 |
| 80                 | 39     | 64             | 70                | 47               | 68                | 40      | 53     | 46    | 58     |
| 81                 | 41     | 67             | 72                | 51               | 70                | 44      | 57     | 50    | 62     |
| 82                 | 44     | 71             | 80                | 55               | 77                | 47      | 60     | 55    | 65     |
| 84                 | 68     | 114            | 122               | 93               | 118               | 80      | 93     | 91    | 96     |
| 85                 | 25     | 48             | 49                | 37               | 47                | 32      |        | 37    |        |
| 86                 | 36     | 55             | 58                | 46               | 55                | 39      |        | 45    |        |
| <b>.125" Thick</b> |        |                |                   |                  |                   |         |        |       |        |
| 87                 | 64     | 131            | 141               | 109              | 136               | 93      | 112    | 107   |        |

See page 12 for standard locations and sizes of Cylinder Cutouts (CFC) and Thumbturn Cutouts (CFTT), engraving and pricing.

## Flush Pulls

| <b>Heavy Duty Security - Cast Brass</b>  |        |                |                   |                  |                   |         |        |       |        |       |
|--|--------|----------------|-------------------|------------------|-------------------|---------|--------|-------|--------|-------|
| Part   | 4/606  | 26D/626        | Stock PC<br>10BE  |                  |                   |         |        |       |        |       |
| D89  | 98     | 66             | 75                |                  |                   |         |        |       |        |       |
| <b>Cylinder Pulls - .125" Thick</b>  |        |                |                   |                  |                   |         |        |       |        |       |
| Part   | 28/628 | 3/605<br>4/606 | 10/612<br>10B/613 | Stock PC<br>10BE | 26/625<br>26D/626 | 32D/630 | 32/629 | 32DMS | 32D316 | 32316 |
| 90   | 45     | 50             | 56                | 53               | 54                | 44      |        | 53    |        |       |
| 90B  | 38     | 48             | 50                | 47               | 48                | 41      |        | 47    |        |       |
| <b>Combination Pulls - .125" Thick - See page 12 for standard locations and sizes of Cylinder Cutouts (CFC) and Thumbturn Cutouts (CFTT), engraving and pricing.</b> |        |                |                   |                  |                   |         |        |       |        |       |
| 91-RKW   | 43     | 80             | 84                | 62               | 81                | 54      |        | 61    |        |       |
| 92-RKW   | 47     | 83             | 87                | 66               | 84                | 57      |        | 65    |        |       |
| 93-RKW   | 70     | 147            | 156               | 120              | 151               | 104     |        | 119   |        |       |
| <b>Flush Pulls - .125" Thick</b>   |        |                |                   |                  |                   |         |        |       |        |       |
| 94   |        | 69             | 74                | 41               | 71                | 36      | 53     | 41    | 47     | 65    |
| 94BTB (pair)   |        | 144            | 152               | 90               | 147               | 78      | 107    | 90    | 100    | 135   |
| 94C  |        | 71             | 77                | 45               | 74                | 39      | 55     | 45    | 49     | 67    |
| 94L  |        | 80             | 83                | 52               | 80                | 45      | 61     | 52    | 58     | 76    |
| 94P  |        | 71             | 77                | 45               | 74                | 39      | 55     | 45    | 49     | 67    |
| 94P x 94L  |        | 150            | 157               | 96               | 152               | 83      | 114    | 96    | 105    | 141   |
| <b>Dead Lock Pulls - For Barrier Free grip specify BF94DLL or BF94DLS. Used with dead bolt lock. 1 1/4" cylinder hole is standard.</b>                               |        |                |                   |                  |                   |         |        |       |        |       |
| 94DLL  |        | 121            | 121               | 97               | 117               | 84      | 104    | 97    | 107    | 127   |
| 94DLS  |        | 102            | 102               | 77               | 98                | 66      | 87     | 77    | 89     | 107   |
| <b>Cast Brass - Fasteners concealed in cup.</b>  |        |                |                   |                  |                   |         |        |       |        |       |
| 95A  |        | 31             | 32                | 35               | 31                |         |        |       |        |       |
| 95B  |        | 32             | 34                | 38               | 33                |         |        |       |        |       |
| 95R  |        | 42             | 44                | 48               | 42                |         |        |       |        |       |
| <b>Flush Pull - .125" Thick - See page 12 for standard locations and sizes of Cylinder Cutouts (CFC) and Thumbturn Cutouts (CFTT), engraving and pricing.</b>        |        |                |                   |                  |                   |         |        |       |        |       |
| 96   |        | 100            | 107               | 74               | 104               | 64      |        | 73    |        |       |
| <b>Barrier Free - .125" Thick</b>  |        |                |                   |                  |                   |         |        |       |        |       |
| BF97   |        | 127            | 134               | 104              | 130               | 90      |        | 103   |        |       |
| BF97L  |        | 150            | 159               | 130              | 153               | 112     |        | 130   |        |       |



### Straight Door Pulls & Door Pull Sets

| Straight Door Pulls & Door Pull Sets                                      |        |                    |                |                   |                  |                   |         |        |       |        |       |
|---|--------|--------------------|----------------|-------------------|------------------|-------------------|---------|--------|-------|--------|-------|
| Part  | 28/628 | 313/710<br>315/711 | 3/605<br>4/606 | 10/612<br>10B/613 | Stock PC<br>10BE | 26/625<br>26D/626 | 32D/630 | 32/629 | 32DMS | 32D316 | 32316 |
| 102-RKW   | 21     | 25                 | 44             | 54                | 32               | 42                | 27      | 43     | 31    |        |       |
| 105   | 22     | 26                 | 49             | 61                | 35               | 47                | 29      | 44     | 33    | 50     | 61    |
| 106-RKW   | 22     | 26                 | 50             | 63                | 36               | 48                | 30      | 46     | 34    | 51     | 63    |
| 107   | 24     | 29                 | 56             | 68                | 39               | 53                | 32      | 47     | 37    | 54     | 64    |
| 108   | 26     | 31                 | 64             | 81                | 48               | 62                | 42      | 54     | 47    | 61     | 73    |
| 109   | 29     | 32                 | 69             | 89                | 54               | 67                | 46      | 59     | 52    | 65     | 79    |
| 110-RKW   | 30     | 34                 | 94             | 120               | 81               | 90                | 69      | 81     | 78    | 95     | 108   |
| 111A  | 31     | 35                 | 97             | 134               | 84               | 94                | 72      | 86     | 82    | 101    | 112   |
| 111-RKW   | 31     | 35                 | 97             | 134               | 93               | 94                | 78      | 92     | 89    | 107    | 119   |
| 112   | 32     | 37                 | 109            | 145               | 100              | 106               | 84      | 98     | 97    | 119    | 133   |
| 118   | 44     | 49                 | 156            | 195               | 129              | 150               | 109     | 129    | 126   | 155    | 167   |
| Straight Door Pull Sets — Type 5 Back-to-Back Mount for 1 3/4" Door.      |        |                    |                |                   |                  |                   |         |        |       |        |       |
| 107BTB5   | 59     | 67                 | 119            | 149               | 89               | 114               | 75      | 102    | 85    | 113    | 139   |
| 108BTB5   | 63     | 72                 | 139            | 170               | 109              | 135               | 91      | 116    | 105   | 133    | 158   |
| 110BTB5   | 70     | 77                 | 199            | 251               | 177              | 193               | 147     | 169    | 169   | 202    | 226   |
| 111BTB5   | 72     | 79                 | 208            | 281               | 198              | 201               | 166     | 193    | 191   | 224    | 249   |
| 112BTB5   | 74     | 87                 | 231            | 305               | 214              | 225               | 180     | 207    | 206   | 249    | 274   |
| Straight Door Pull Sets — Type 13 Back-to-Back Mount for 1/2" Glass Door. |        |                    |                |                   |                  |                   |         |        |       |        |       |
| 110BTB13  | 77     | 87                 | 208            | 260               | 184              | 201               | 154     | 176    | 177   | 210    | 234   |
| 111BTB13  | 79     | 90                 | 215            | 288               | 207              | 208               | 172     | 202    | 198   | 231    | 257   |
| 112BTB13  | 83     | 94                 | 240            | 312               | 223              | 231               | 187     | 213    | 215   | 257    | 283   |

See page 34 for mounting selection and charges. NOTE: For BF Barrier Free projection on applicable straight door pulls add: \$8.40 each list. Add \$52.50 for knurling — round pulls only.

### Security Door Pull

| Security Door Pull |                  |         |       |
|--------------------|------------------|---------|-------|
| Part               | Stock PC<br>10BE | 32D/630 | 32DMS |
| 110-6SP            | 212              | 180     | 189   |

For use on security hollow metal doors with reinforcing plate and access hole cover plate with \*TORX® - security torx screws — all to be supplied by door manufacturer.

### Tubular Door Pulls & Door Pull Sets

| Tubular Straight Door Pulls — Type 1 Thru-Bolt Mount for 1 3/4" Door.          |                |                   |                  |         |        |       |
|--|----------------|-------------------|------------------|---------|--------|-------|
| Part   | 3/605<br>4/606 | 10/612<br>10B/613 | Stock PC<br>10BE | 32D/630 | 32/629 | 32DMS |
| T110   | 103            | 105               | 74               | 62      | 76     | 71    |
| T111A  | 108            | 111               | 76               | 64      | 78     | 73    |
| T111   | 108            | 111               | 76               | 64      | 78     | 73    |
| T112   | 113            | 116               | 80               | 67      | 83     | 77    |
| T118   | 127            | 129               | 91               | 76      | 96     | 87    |
| Tubular Straight Door Pull Sets — Type 5 Back-to-Back Mount for 1 3/4" Door.   |                |                   |                  |         |        |       |
| T110BTB5   | 213            | 220               | 159              | 133     | 163    | 153   |
| T111BTB5   | 226            | 232               | 165              | 137     | 170    | 159   |
| T112BTB5   | 237            | 242               | 170              | 143     | 174    | 164   |
| Tubular Straight Door Pull Sets — Type 13 Back-to-Back Mount for 1 3/4" Glass. |                |                   |                  |         |        |       |
| T110BTB13  | 222            | 230               | 167              | 140     | 172    | 161   |
| T111BTB13  | 234            | 240               | 172              | 145     | 176    | 166   |
| T112BTB13  | 244            | 250               | 178              | 149     | 180    | 172   |

\*Torx® is a registered trademark of Textron Inc.

**ASSA ABLOY**

The global leader in  
door opening solutions

Prices Effective September 1, 2017

Copyright © 2017, Rockwood Manufacturing Company, an ASSA ABLOY Group company. All rights reserved. Reproduction in whole or in part without the express written permission of Rockwood Manufacturing Company is prohibited.

## Door Pulls with Base Plates

| Pulls with Base Plates |        |                    |                |                   |                  |                   |         |        |       |        |       |
|------------------------|--------|--------------------|----------------|-------------------|------------------|-------------------|---------|--------|-------|--------|-------|
| Part                   | 28/628 | 313/710<br>315/711 | 3/605<br>4/606 | 10/612<br>10B/613 | Stock PC<br>10BE | 26/625<br>26D/626 | 32D/630 | 32/629 | 32DMS | 32D316 | 32316 |
| Y102                   | 37     | 43                 | 66             | 80                | 54               | 64                | 45      | 61     | 51    |        |       |
| Y105                   | 37     | 43                 | 72             | 88                | 58               | 70                | 48      | 62     | 56    | 69     | 83    |
| Y106                   | 37     | 45                 | 73             | 90                | 59               | 71                | 49      | 64     | 57    | 71     | 85    |
| Y107                   | 40     | 46                 | 79             | 95                | 61               | 75                | 51      | 65     | 59    | 72     | 86    |
| Y108                   | 45     | 48                 | 89             | 106               | 72               | 86                | 60      | 72     | 69    | 83     | 94    |
| Y109                   | 46     | 50                 | 94             | 114               | 77               | 91                | 64      | 81     | 75    | 87     | 99    |
| Y110                   | 47     | 50                 | 118            | 147               | 105              | 113               | 87      | 101    | 101   | 116    | 131   |
| Y111A                  | 48     | 51                 | 122            | 162               | 107              | 118               | 89      | 106    | 103   | 122    | 135   |
| Y111                   | 48     | 51                 | 122            | 162               | 116              | 118               | 98      | 111    | 111   | 130    | 140   |
| Y112                   | 49     | 55                 | 135            | 173               | 124              | 131               | 104     | 119    | 120   | 140    | 152   |
| Y118                   | 60     | 66                 | 181            | 223               | 154              | 175               | 129     | 148    | 148   | 175    | 188   |

## Door Pulls

| Pulls - Engraving available vertically. See page 12 for pricing. |        |                |                   |                  |                   |         |       |
|--|--------|----------------|-------------------|------------------|-------------------|---------|-------|
| Part   | 28/628 | 3/605<br>4/606 | 10/612<br>10B/613 | Stock PC<br>10BE | 26/625<br>26D/626 | 32D/630 | 32DMS |
| 120  | 88     |                |                   | 128              |                   | 110     | 127   |
| 121  | 93     |                |                   | 138              |                   | 119     | 136   |
| 122-RKW  | 25     | 58             | 77                | 40               | 74                | 34      | 40    |
| 123  | 29     |                |                   | 48               |                   | 42      | 48    |
| 125-RKW  | 29     | 62             | 66                | 54               | 64                | 46      | 53    |
| 126-RKW  | 31     | 73             | 81                | 60               | 78                | 51      | 59    |
| Cast Pulls   |        |                |                   |                  |                   |         |       |
| 130-RKW  | 25     | 44             | 46                | 53               | 44                | 45      | 52    |
| 131-RKW  | 25     | 44             | 46                | 53               | 44                | 45      | 52    |
| 132-RKW  | 25     | 37             | 42                | 49               | 40                | 43      | 49    |
| D133-RKW   |        | 57             |                   | 60               |                   | 51      | 59    |
| 134-RKW  |        | 56             | 60                | 66               | 58                |         |       |
| 137  |        | 45             | 49                | 55               | 47                | 45      |       |
| 137L   |        | 92             | 92                | 101              | 87                |         |       |
| 138  | 38     | 64             | 70                | 79               | 68                |         |       |
| 139  | 38     | 64             | 70                | 79               | 68                |         |       |
| Cast Pulls - See page 34 for mounting selection and charges.     |        |                |                   |                  |                   |         |       |
| 147  |        | 73             | 73                | 81               | 70                |         |       |
| 147L   |        | 122            | 145               | 162              | 141               |         |       |
| 148  |        | 109            | 109               | 122              | 106               |         |       |
| 149  |        | 135            | 135               | 149              | 130               |         |       |

90° Offset Door Pulls & Door Pull Sets

| 90° Offset Door Pulls & Door Pull Sets  |        |                    |                |                   |                  |                   |         |        |       |        |       |
|---|--------|--------------------|----------------|-------------------|------------------|-------------------|---------|--------|-------|--------|-------|
| Part  | 28/628 | 313/710<br>315/711 | 3/605<br>4/606 | 10/612<br>10B/613 | Stock PC<br>10BE | 26/625<br>26D/626 | 32D/630 | 32/629 | 32DMS | 32D316 | 32316 |
| BF150   | 39     | 49                 | 96             | 117               | 78               | 93                | 66      | 88     | 76    | 98     | 111   |
| BF151   | 44     | 52                 | 103            | 127               | 83               | 100               | 71      | 92     | 81    | 103    | 114   |
| BF152   | 47     | 56                 | 108            | 135               | 88               | 105               | 75      | 98     | 86    | 108    | 123   |
| BF156   | 47     | 56                 | 133            | 160               | 112              | 128               | 94      | 109    | 108   | 146    | 162   |
| BF157A  | 52     | 61                 | 140            | 168               | 117              | 136               | 99      | 113    | 113   | 151    | 166   |
| BF157   | 52     | 61                 | 140            | 168               | 122              | 136               | 103     | 119    | 119   | 158    | 171   |
| BF158   | 59     | 67                 | 148            | 177               | 130              | 144               | 110     | 128    | 127   | 169    | 183   |
| BF159   | 72     | 84                 | 180            | 205               | 162              | 175               | 136     | 156    | 157   | 205    | 218   |
| Offset Door Pulls Sets - Type 16 Back-to-Back Mount for 1 3/4" Door. (Double Cone Head)         |        |                    |                |                   |                  |                   |         |        |       |        |       |
| BF156BTB16  | 107    | 123                | 279            | 331               | 238              | 269               | 200     | 234    | 230   | 307    | 334   |
| BF157ABTB16   | 116    | 136                | 294            | 349               | 248              | 285               | 210     | 240    | 241   | 317    | 342   |
| BF157BTB16  | 116    | 136                | 294            | 349               | 259              | 285               | 218     | 250    | 252   | 330    | 357   |
| BF158BTB16  | 130    | 148                | 311            | 366               | 279              | 302               | 235     | 266    | 270   | 352    | 379   |
| BF159BTB16  | 161    | 179                | 373            | 423               | 340              | 362               | 287     | 322    | 330   | 423    | 450   |
| Offset Door Pulls - Type 17 Concealed Mount for 1 3/4" Aluminum Door. (Double Cone Head)        |        |                    |                |                   |                  |                   |         |        |       |        |       |
| BF156C17  | 62     | 69                 | 146            | 174               | 127              | 141               | 107     | 126    | 123   | 163    | 174   |
| BF157AC17   | 67     | 75                 | 156            | 182               | 133              | 150               | 111     | 129    | 128   | 167    | 180   |
| BF157C17  | 67     | 75                 | 156            | 182               | 139              | 150               | 116     | 133    | 134   | 172    | 186   |
| BF158C17  | 72     | 84                 | 164            | 191               | 147              | 159               | 125     | 140    | 144   | 184    | 197   |
| BF159C17  | 90     | 99                 | 195            | 219               | 178              | 188               | 151     | 168    | 173   | 219    | 233   |
| Tubular Offset Door Pulls - Type 1 Thru-Bolt Mount for 1 3/4" Door.                             |        |                    |                |                   |                  |                   |         |        |       |        |       |
| TBF156  |        |                    | 133            | 137               | 82               |                   | 69      | 100    | 79    |        |       |
| TBF157A   |        |                    | 138            | 140               | 85               |                   | 71      | 103    | 82    |        |       |
| TBF157  |        |                    | 138            | 140               | 85               |                   | 71      | 103    | 82    |        |       |
| TBF158  |        |                    | 142            | 146               | 87               |                   | 73      | 105    | 84    |        |       |
| TBF159  |        |                    | 158            | 164               | 108              |                   | 90      | 120    | 104   |        |       |
| Tubular Offset Door Pull Sets - Type 16 Back-to-Back Mount for 1 3/4" Door. (Double Cone Head)  |        |                    |                |                   |                  |                   |         |        |       |        |       |
| TBF156BTB16   |        |                    | 281            | 287               | 180              |                   | 151     | 216    | 174   |        |       |
| TBF157ABTB16  |        |                    | 290            | 295               | 188              |                   | 158     | 220    | 181   |        |       |
| TBF157BTB16   |        |                    | 290            | 295               | 188              |                   | 158     | 220    | 181   |        |       |
| TBF158BTB16   |        |                    | 297            | 304               | 195              |                   | 163     | 225    | 188   |        |       |
| TBF159BTB16   |        |                    | 332            | 343               | 230              |                   | 192     | 257    | 221   |        |       |
| Tubular Offset Door Pull - Type 17 Concealed Mount for 1 3/4" Aluminum Door. (Double Cone Head) |        |                    |                |                   |                  |                   |         |        |       |        |       |
| TBF156C17   |        |                    | 150            | 153               | 102              |                   | 85      | 116    | 98    |        |       |
| TBF157AC17  |        |                    | 155            | 157               | 104              |                   | 87      | 118    | 100   |        |       |
| TBF157C17   |        |                    | 155            | 157               | 104              |                   | 87      | 118    | 100   |        |       |
| TBF158C17   |        |                    | 158            | 160               | 108              |                   | 90      | 120    | 104   |        |       |
| TBF159C17   |        |                    | 176            | 181               | 125              |                   | 105     | 137    | 121   |        |       |

See page 34 for mounting selection and charges.



The global leader in door opening solutions

Prices Effective September 1, 2017

Copyright © 2017, Rockwood Manufacturing Company, an ASSA ABLOY Group company. All rights reserved. Reproduction in whole or in part without the express written permission of Rockwood Manufacturing Company is prohibited.

## 90° Offset Door Pulls with Base Plates

| Part    | 28/628 | 313/710<br>315/711 | 3/605<br>4/606 | 10/612<br>108/613 | Stock PC<br>10BE | 26/625<br>26D/626 | 32D/630 | 32/629 | 32DMS | 32D316 | 32316 |
|---------|--------|--------------------|----------------|-------------------|------------------|-------------------|---------|--------|-------|--------|-------|
| YBF150  | 58     | 66                 | 120            | 143               | 102              | 116               | 85      | 108    | 98    | 119    | 134   |
| YBF151  | 60     | 68                 | 127            | 153               | 106              | 122               | 88      | 111    | 102   | 123    | 137   |
| YBF152  | 63     | 71                 | 134            | 163               | 112              | 129               | 93      | 119    | 108   | 131    | 144   |
| YBF156  | 63     | 71                 | 157            | 186               | 135              | 152               | 112     | 131    | 129   | 168    | 181   |
| YBF157A | 68     | 77                 | 166            | 196               | 141              | 161               | 118     | 134    | 135   | 173    | 187   |
| YBF157  | 68     | 77                 | 166            | 196               | 147              | 161               | 122     | 139    | 141   | 179    | 192   |
| YBF158  | 74     | 86                 | 174            | 205               | 155              | 169               | 130     | 146    | 149   | 190    | 205   |
| YBF159  | 92     | 101                | 207            | 233               | 186              | 200               | 156     | 175    | 180   | 226    | 242   |

See page 34 for mounting selection and charges.

## 45° Offset Door Pulls

| Part   | 28/628 | 313/710<br>315/711 | 3/605<br>4/606 | 10/612<br>108/613 | Stock PC<br>10BE | 26/625<br>26D/626 | 32D/630 | 32/629 | 32DMS | 32D316 | 32316 |
|--------|--------|--------------------|----------------|-------------------|------------------|-------------------|---------|--------|-------|--------|-------|
| BF160  | 39     | 49                 | 96             | 117               | 78               | 93                | 66      | 88     | 76    | 98     | 111   |
| BF161  | 44     | 52                 | 103            | 127               | 83               | 100               | 71      | 92     | 81    | 103    | 114   |
| BF162  | 47     | 56                 | 108            | 135               | 88               | 105               | 75      | 98     | 86    | 108    | 123   |
| BF166  | 47     | 56                 | 133            | 160               | 137              | 128               | 115     | 132    | 133   | 146    | 162   |
| BF167A | 52     | 61                 | 140            | 168               | 142              | 136               | 120     | 136    | 138   | 151    | 166   |
| BF167  | 52     | 61                 | 140            | 168               | 147              | 136               | 125     | 139    | 144   | 158    | 171   |
| BF168  | 59     | 67                 | 148            | 177               | 157              | 144               | 132     | 151    | 152   | 169    | 183   |
| BF169  | 72     | 84                 | 180            | 205               | 188              | 175               | 159     | 177    | 183   | 205    | 218   |

See page 34 for mounting selection and charges.

## Offset Door Pulls

| Part    | 28/628 | 313/710<br>315/711 | 3/605<br>4/606 | 10/612<br>108/613 | Stock PC<br>10BE | 32D/630 | 32DMS |
|---------|--------|--------------------|----------------|-------------------|------------------|---------|-------|
| 176-RKW | 127    | 131                | 345            | 387               | 223              | 188     | 216   |
| 177     | 137    | 145                | 387            | 426               | 267              | 225     | 259   |
| 185     | 149    | 171                | 542            | 542               | 490              | 413     | 475   |

Call factory for engraving and pricing.

## Hospital Door Pull

| Part | 3/605<br>4/606 | 10/612<br>108/613 | Stock PC<br>10BE | 26/625<br>26D/626 | 32D/630 | 32DMS |
|------|----------------|-------------------|------------------|-------------------|---------|-------|
| 193  | 56             | 59                | 66               | 57                | 56      | 65    |

## Wooden Door Pull

| Part | 28/628 | 313/710<br>315/711 | 3/605<br>4/606 | 10/612<br>108/613 | Stock PC<br>10BE | 26/625<br>26D/626 | 32D/630 | 32/629 | 32DMS |
|------|--------|--------------------|----------------|-------------------|------------------|-------------------|---------|--------|-------|
| 208  | 230    | 230                | 227            | 227               | 245              | 219               | 208     | 215    | 239   |

Wood available in Oiled or Clear Finish. See page 34 for mounting details.

## Tapered Door Pull

| Part | 28/628 | 313/710<br>315/711 | 3/605<br>4/606 | 10/612<br>108/613 | Stock PC<br>10BE | 26/625<br>26D/626 | 32D/630 | 32/629 | 32DMS |
|------|--------|--------------------|----------------|-------------------|------------------|-------------------|---------|--------|-------|
| 215  | 218    | 231                | 358            | 401               | 313              | 389               | 261     | 304    | 300   |
| 215L | 290    | 306                | 646            | 706               | 534              | 684               | 445     | 527    | 512   |

Larger sizes available upon request. See page 34 for mounting details.

**ASSA ABLOY**

The global leader in  
door opening solutions

### Heavy Duty Offset Pulls

| Heavy Duty Offset Pulls |        |                    |                |                   |                  |                   |         |        |       |        |       |
|-------------------------|--------|--------------------|----------------|-------------------|------------------|-------------------|---------|--------|-------|--------|-------|
| Part                    | 28/628 | 313/710<br>315/711 | 3/605<br>4/606 | 10/612<br>10B/613 | Stock PC<br>10BE | 26/625<br>26D/626 | 32D/630 | 32/629 | 32DMS | 32D316 | 32316 |
| BF257                   | 137    | 149                | 333            | 383               | 264              | 324               | 223     | 285    | 256   | 279    | 310   |
| BF258                   | 149    | 162                | 359            | 407               | 287              | 348               | 242     | 305    | 279   | 297    | 331   |
| BF259                   | 154    | 170                | 407            | 468               | 317              | 396               | 267     | 331    | 307   | 324    | 357   |
| BF260                   | 170    | 181                | 468            | 543               | 347              | 454               | 293     | 359    | 337   | 351    | 382   |

Supplied with 3/8" -16 Thru Bolts.

### Vandal Resistant Trim

| Vandal Resistant Trim |                  |         |       |
|-----------------------|------------------|---------|-------|
| Part                  | Stock PC<br>10BE | 32D/630 | 32DMS |
| VRT12                 | 261              | 240     | 261   |
| VRT14                 | 307              | 284     | 307   |
| VRT16                 | 261              | 240     | 261   |
| VRT22                 |                  | 292     |       |
| VRT24                 |                  | 337     |       |
| VRT26                 |                  | 295     |       |

Specify Exit Device make and model to thru bolt directly to device.

### Vandal Resistant Pull

| Vandal Resistant Pull |                  |                  |
|-----------------------|------------------|------------------|
| Part                  | Stock PC<br>10BE | BPC/FBPC/RPC/WPC |
| VRP30                 | 120              | 120              |

Set up charge for custom powder coat will apply. Specify Exit Device make and model to thru bolt directly to device.

### Pull Plates

| Pull Plates |        |                |                   |                  |                   |         |        |       |        |
|-------------|--------|----------------|-------------------|------------------|-------------------|---------|--------|-------|--------|
| Part        | 28/628 | 3/605<br>4/606 | 10/612<br>10B/613 | Stock PC<br>10BE | 26/625<br>26D/626 | 32D/630 | 32/629 | 32DMS | 32D316 |
| 102 x 70B   |        | 68             | 85                | 49               | 82                | 41      | 61     | 47    |        |
| 102 x 70C   |        | 71             | 88                | 51               | 85                | 43      | 63     | 49    |        |
| 105 x 70B   | 34     | 73             | 92                | 51               | 88                | 43      | 62     | 49    | 70     |
| 105 x 70C   | 35     | 80             | 95                | 54               | 92                | 45      | 64     | 53    | 72     |
| 106 x 70B   | 34     | 75             | 94                | 53               | 91                | 44      | 64     | 51    | 71     |
| 106 x 70C   | 35     | 82             | 97                | 55               | 94                | 46      | 66     | 54    | 73     |
| 107 x 70B   | 37     | 82             | 99                | 55               | 96                | 46      | 65     | 54    | 72     |
| 107 x 70C   | 37     | 85             | 103               | 58               | 99                | 48      | 67     | 56    | 75     |
| 110 x 70B   | 44     | 119            | 150               | 99               | 146               | 83      | 100    | 96    | 117    |
| 110 x 70C   | 44     | 125            | 153               | 100              | 149               | 84      | 102    | 97    | 119    |
| 111 x 70B   | 46     | 125            | 165               | 110              | 160               | 92      | 110    | 106   | 127    |
| 111 x 70C   | 46     | 129            | 169               | 112              | 163               | 95      | 113    | 108   | 127    |
| 122 x 70B   | 37     | 85             | 109               | 56               | 105               | 47      |        | 55    |        |
| 122 x 70C   | 39     | 88             | 112               | 60               | 109               | 49      |        | 57    |        |
| 123 x 70B   | 41     |                |                   | 66               |                   | 56      |        | 63    |        |
| 123 x 70C   | 41     |                |                   | 67               |                   | 57      |        | 65    |        |
| 125 x 70B   | 41     | 89             | 98                | 70               | 95                | 60      |        | 68    |        |
| 125 x 70C   | 41     | 93             | 102               | 72               | 98                | 61      |        | 69    |        |
| 126 x 70B   | 46     | 101            | 112               | 76               | 109               | 64      |        | 74    |        |
| 126 x 70C   | 46     | 105            | 115               | 79               | 112               | 66      |        | 76    |        |
| 132 x 70B   | 37     | 64             | 71                | 69               | 69                | 59      |        | 67    |        |
| 132 x 70C   | 39     | 67             | 75                | 70               | 72                | 60      |        | 68    |        |
| 137 x 70B   |        | 70             | 82                | 72               | 79                | 61      |        | 69    |        |
| 137 x 70C   |        | 73             | 85                | 73               | 82                | 62      |        | 71    |        |

Barrier Free - Available in 2 1/2" clearance add \$9 list (excludes 132 and 137).

**ASSA ABLOY**

The global leader in  
door opening solutions

Prices Effective September 1, 2017

Copyright © 2017, Rockwood Manufacturing Company, an ASSA ABLOY Group company. All rights reserved. Reproduction in whole or in part without the express written permission of Rockwood Manufacturing Company is prohibited.

## Decorative Pull Plates

| Decorative Pull Plates |                |                   |                  |                   |
|------------------------|----------------|-------------------|------------------|-------------------|
| Part                   | 3/605<br>4/606 | 10/612<br>10B/613 | Stock PC<br>10BE | 26/625<br>26D/626 |
| 147 x 76B              | 115            | 120               | 134              | 116               |
| 147 x 76C              | 119            | 124               | 137              | 119               |
| 147 x 77B              | 115            | 120               | 134              | 116               |
| 147 x 77C              | 119            | 124               | 137              | 119               |
| 148 x 76B              | 150            | 155               | 173              | 150               |
| 148 x 76C              | 155            | 160               | 178              | 154               |
| 148 x 77B              | 150            | 155               | 173              | 150               |
| 148 x 77C              | 155            | 160               | 178              | 154               |

## Tubular Pull Plates

| Tubular Pull Plates |                |                   |                  |         |        |       |
|---------------------|----------------|-------------------|------------------|---------|--------|-------|
| Part                | 3/605<br>4/606 | 10/612<br>10B/613 | Stock PC<br>10BE | 32D/630 | 32/629 | 32DMS |
| T110 x 70B          | 129            | 139               | 92               | 77      | 98     | 89    |
| T110 x 70C          | 134            | 143               | 94               | 79      | 100    | 91    |
| T111 x 70B          | 137            | 144               | 94               | 79      | 102    | 91    |
| T111 x 70C          | 140            | 148               | 99               | 83      | 104    | 95    |

## Corner Guards

| Corner Guards |               |                |                   |         |
|---------------|---------------|----------------|-------------------|---------|
| Part          | Size          | 3/605<br>4/606 | 10/612<br>10B/613 | 32D/630 |
| 290           | 2" x 2" x 40" | 121            | 132               | 71      |
|               | 2" x 2" x 48" | 135            | 148               | 76      |
|               | 3" x 3" x 40" | 154            | 170               | 82      |
|               | 3" x 3" x 48" | 175            | 193               | 90      |
| 291           | 2" x 2" x 40" | 128            | 137               | 76      |
|               | 2" x 2" x 48" | 140            | 154               | 82      |
|               | 3" x 3" x 40" | 162            | 176               | 88      |
|               | 3" x 3" x 48" | 182            | 198               | 95      |

| Corner Guards |               |                |                   |                  |         |       |
|---------------|---------------|----------------|-------------------|------------------|---------|-------|
| Part          | Size          | 3/605<br>4/606 | 10/612<br>10B/613 | Stock PC<br>10BE | 32D/630 | 32DMS |
| 295           | 2" x 2" x 40" | 99             | 109               | 61               | 53      | 60    |
|               | 2" x 2" x 48" | 112            | 127               | 70               | 59      | 69    |
|               | 3" x 3" x 40" | 135            | 148               | 77               | 65      | 75    |
|               | 3" x 3" x 48" | 153            | 171               | 85               | 73      | 84    |
| 296           | 2" x 2" x 40" | 108            | 115               | 70               | 59      | 69    |
|               | 2" x 2" x 48" | 118            | 135               | 77               | 65      | 75    |
|               | 3" x 3" x 40" | 140            | 154               | 83               | 71      | 82    |
|               | 3" x 3" x 48" | 161            | 179               | 93               | 80      | 91    |

Other lengths available up to 96" and leg widths up to 6". Part number 290 and 291 includes self-adhesive mounting.

## Mortised Door Edges (UL Approved)

| Mortised Door Edges |           |                |                   |                  |         |       |        |
|---------------------|-----------|----------------|-------------------|------------------|---------|-------|--------|
| Part                | Height    | 3/605<br>4/606 | 10/612<br>10B/613 | Stock PC<br>10BE | 32D/630 | 32DMS | 32D316 |
| 300                 | Up to 42" | 92             | 97                | 60               | 52      | 59    | 72     |
|                     | 43" - 66" | 139            | 152               | 92               | 78      | 90    | 108    |
|                     | 67" - 96" | 205            | 219               | 130              | 111     | 128   | 157    |
| 301                 | Up to 42" | 92             | 97                | 60               | 52      | 59    | 72     |
|                     | 43" - 66" | 139            | 152               | 92               | 78      | 90    | 108    |
|                     | 67" - 96" | 205            | 219               | 130              | 111     | 128   | 157    |
| 302                 | Up to 42" | 103            | 110               | 72               | 61      | 71    | 77     |
|                     | 43" - 66" | 152            | 165               | 108              | 92      | 106   | 121    |
|                     | 67" - 96" | 224            | 238               | 153              | 131     | 151   | 175    |
| 302B                | Up to 42" | 103            | 110               | 72               | 61      | 71    | 77     |
|                     | 43" - 66" | 152            | 165               | 108              | 92      | 106   | 121    |
|                     | 67" - 96" | 224            | 238               | 153              | 131     | 151   | 175    |

Available in stainless steel, brass and bronze. UL Listed for fire rated doors. Add \$13 per edge - specify UL when ordering (300-UL). Includes Phillips Flat Head Sheet Metal Screw Fasteners. To defray set up costs, add 30% for less than 10 pieces. Add an additional \$12 for each cutout.

### Non-Mortise Door Edges (UL Approved)

| Non-Mortise Door Edges |           |                |                   |                  |         |       |        |
|------------------------|-----------|----------------|-------------------|------------------|---------|-------|--------|
| Part                   | Height    | 3/605<br>4/606 | 10/612<br>10B/613 | Stock PC<br>10BE | 32D/630 | 32DMS | 32D316 |
| 304                    | Up to 42" | 92             | 97                | 60               | 52      | 59    | 72     |
|                        | 43"- 66"  | 139            | 152               | 92               | 78      | 90    | 108    |
|                        | 67"- 96"  | 205            | 219               | 130              | 111     | 128   | 157    |
| 305                    | Up to 42" | 92             | 97                | 60               | 52      | 59    | 72     |
|                        | 43"- 66"  | 139            | 152               | 92               | 78      | 90    | 108    |
|                        | 67"- 96"  | 205            | 219               | 130              | 111     | 128   | 157    |
| 306-RKW                | Up to 42" | 103            | 110               | 72               | 61      | 71    | 77     |
|                        | 43"- 66"  | 152            | 165               | 108              | 92      | 106   | 121    |
|                        | 67"- 96"  | 224            | 238               | 153              | 131     | 151   | 175    |
| 306-AST                | Up to 96" |                |                   | 452              | 386     | 444   |        |
| 306B                   | Up to 42" | 103            | 110               | 72               | 61      | 71    | 77     |
|                        | 43"- 66"  | 152            | 165               | 108              | 92      | 106   | 121    |
|                        | 67"- 96"  | 224            | 238               | 153              | 131     | 151   | 175    |
| 306B-AST               | Up to 96" |                |                   | 452              | 386     | 444   |        |
| 307                    | Up to 42" | 118            | 126               | 89               | 76      | 88    | 95     |
|                        | 43"- 66"  | 177            | 190               | 137              | 117     | 135   | 146    |
|                        | 67"- 96"  | 263            | 275               | 195              | 166     | 192   | 216    |

Available in stainless steel, brass and bronze. UL Listed for fire rated doors. Add \$13 per edge - specify UL when ordering (304-UL). Includes Phillips Flat Head Sheet Metal Screw Fasteners. To defray set up costs, add 30% for less than 10 pieces. Add an additional \$12 for each cutout.

### Overlapping Door Edges (UL Approved)

| Overlapping Door Edges |           |                |                   |                  |         |       |        |
|------------------------|-----------|----------------|-------------------|------------------|---------|-------|--------|
| Part                   | Height    | 3/605<br>4/606 | 10/612<br>10B/613 | Stock PC<br>10BE | 32D/630 | 32DMS | 32D316 |
| 308                    | Up to 42" | 103            | 110               | 72               | 61      | 71    | 80     |
| 309                    | Up to 42" | 103            | 110               | 72               | 61      | 71    | 80     |
| 310                    | Up to 42" | 115            | 122               | 85               | 73      | 84    | 93     |
| 310B                   | Up to 42" | 115            | 122               | 85               | 73      | 84    | 93     |
| 310BS                  | Up to 42" | 115            | 122               | 85               | 73      | 84    | 93     |

Available in stainless steel, brass and bronze. UL Listed for fire rated doors. Add \$13 per edge - specify UL when ordering (308-UL). Includes Phillips Flat Head Sheet Metal Screw Fasteners. To defray set up costs, add 30% for less than 10 pieces. Add an additional \$12 for each cutout.

### Latch Protectors

| Latch Protectors |        |                  |         |         |
|------------------|--------|------------------|---------|---------|
| Part             | 2C/603 | Stock PC<br>10BE | 26D/626 | 32D/630 |
| 320-RKW          | 18     | 37               |         | 31      |
| 320C             | 18     | 37               |         | 31      |
| 320CL            | 18     | 37               |         | 31      |
| 320CXL           |        | 37               |         | 31      |
| 321              | 21     | 32               |         | 27      |
| 322              | 21     | 33               |         | 28      |
| 325              |        | 54               | 46      |         |
| 330              |        | 50               |         | 44      |

**ASSA ABLOY**

The global leader in  
door opening solutions



Stops

| Solid Cast Wall Stops - DuraFlex Bumpers |                |                   |                  |        |                   |
|--|----------------|-------------------|------------------|--------|-------------------|
| Part                                     | 3/605<br>4/606 | 10/612<br>10B/613 | Stock PC<br>10BE | 15/619 | 26/625<br>26D/626 |
| 400                                      | 14             | 15                | 16               | 14     | 14                |
| 401                                      | 14             | 15                | 16               | 14     | 14                |
| 402                                      | 14             | 15                | 16               | 14     | 14                |
| 403                                      | 14             | 15                | 16               | 14     | 14                |
| 404                                      | 14             | 15                | 16               | 14     | 14                |
| 405                                      | 14             | 15                | 16               | 14     | 14                |

| Wrought Wall Stops - DuraFlex Bumpers |                |                     |                   |         |
|---------------------------------------|----------------|---------------------|-------------------|---------|
| Part                                  | 3/605<br>4/606 | 10/612<br>10BE/613E | 26/625<br>26D/626 | 32D/630 |
| 406                                   | 9              | 9                   | 8                 | 6       |
| 409                                   | 9              | 9                   | 8                 | 6       |

| Solid Cast Wall Stops - DuraFlex Bumper |                |                   |                  |        |                   |
|---|----------------|-------------------|------------------|--------|-------------------|
| Part                                    | 3/605<br>4/606 | 10/612<br>10B/613 | Stock PC<br>10BE | 15/619 | 26/625<br>26D/626 |
| 412                                     |                |                   | 25               | 22     | 22                |
| 415                                     | 33             | 33                | 37               | 32     | 32                |
| 416                                     |                |                   | 25               | 22     | 22                |

| Wrought Wall Stops - DuraFlex Bumpers |       |                  |         |  |
|---------------------------------------|-------|------------------|---------|--|
| Part                                  | 3/605 | Stock PC<br>10BE | 32D/630 |  |
| 426                                   | 9     | 8                | 6       |  |

| Solid Cast Wall Stop - DuraFlex Bumper |                |                   |                  |                   |
|--|----------------|-------------------|------------------|-------------------|
| Part                                   | 3/605<br>4/606 | 10/612<br>10B/613 | Stock PC<br>10BE | 26/625<br>26D/626 |
| 430-RKW                                | 11             | 11                | 12               | 10                |

| Wall Stops - DuraFlex Bumpers |      |       |  |  |
|-------------------------------|------|-------|--|--|
| Part                          | Gray | White |  |  |
| 431-RKW                       | 3    |       |  |  |
| 432W                          |      | 3     |  |  |

| Light Duty Dome Stops - DuraFlex Bumper |  |         |                  |         |
|---|--|---------|------------------|---------|
| Part                                    |  | 10B/613 | Stock PC<br>10BE | 26D/626 |
| 438                                     |  | 9       | 8                | 6       |
| 439                                     |  | 10      | 9                | 8       |

| Dome Stops |                |                   |                  |        |                   |
|------------|----------------|-------------------|------------------|--------|-------------------|
| Part       | 3/605<br>4/606 | 10/612<br>10B/613 | Stock PC<br>10BE | 15/619 | 26/625<br>26D/626 |
| 440        | 10             | 11                | 12               | 32     | 10                |
| 441        | 12             | 13                | 13               | 36     | 11                |
| 441CU      | 14             | 15                | 16               |        | 14                |
| 441H       | 14             | 15                | 16               | 56     | 14                |
| 442        | 11             | 12                | 14               | 44     | 12                |
| 443        | 13             | 13                | 14               | 48     | 12                |

| Cast Riser (for 440 & 441 Dome Stops) |   |   |   |  |   |
|---------------------------------------|---|---|---|--|---|
| Part                                  | 8 | 8 | 8 |  | 6 |
| 444                                   | 8 | 8 | 8 |  | 6 |

| Heavy Duty Door Stop |                |         |                  |        |        |         |        |
|----------------------|----------------|---------|------------------|--------|--------|---------|--------|
| Part                 | 3/605<br>4/606 | 10B/613 | Stock PC<br>10BE | 10/612 | 15/619 | 26D/626 | 26/625 |
| 445                  | 26             | 29      | 18               | 29     | 29     | 15      | 29     |
| 445H                 | 38             | 43      | 29               | 38     | 42     | 25      | 37     |

| Door Stop |    |    |    |    |    |    |    |
|-----------|----|----|----|----|----|----|----|
| Part      | 27 | 31 | 33 | 31 | 31 | 29 | 29 |
| 446       | 27 | 31 | 33 | 31 | 31 | 29 | 29 |

| Riser (for 440 & 442 Dome Stops) |      |         |  |  |  |  |  |
|----------------------------------|------|---------|--|--|--|--|--|
| Part                             | Mill | Painted |  |  |  |  |  |
| 449                              | 9    | 9       |  |  |  |  |  |

| Curved Roller Stop - DuraFlex Bumper |                |                   |                  |                   |
|--------------------------------------|----------------|-------------------|------------------|-------------------|
| Part                                 | 3/605<br>4/606 | 10/612<br>10B/613 | Stock PC<br>10BE | 26/625<br>26D/626 |
| 455                                  | 37             | 37                | 41               | 36                |

| Straight Roller Stop - DuraFlex Bumpers |                |                   |                  |                   |
|---|----------------|-------------------|------------------|-------------------|
| Part                                    | 3/605<br>4/606 | 10/612<br>10B/613 | Stock PC<br>10BE | 26/625<br>26D/626 |
| 456-RKW                                 | 37             | 37                | 41               | 36                |
| 456B Gray (replacement bumper)          |                |                   |                  | 4                 |
| 456L                                    | 42             | 42                | 46               | 40                |

| Kick Down Door Stop - DuraFlex Bumper |                            |                         |                           |  |
|---------------------------------------|----------------------------|-------------------------|---------------------------|--|
| Part                                  | Polished<br>Brass<br>(BRS) | Dull<br>Bronze<br>(BRZ) | Bright<br>Chrome<br>(CRM) |  |
| 458                                   | 12                         | 12                      | 12                        |  |

| Spring Loaded Plunger Stop - DuraFlex Bumper |                |                             |                  |                   |
|--|----------------|-----------------------------|------------------|-------------------|
| Part   | 3/605<br>4/606 | 10/612<br>10B/613<br>15/619 | Stock PC<br>10BE | 26/625<br>26D/626 |
| 459  | 42             | 45                          | 50               | 43                |

| Kick Down Door Stop - DuraFlex Bumper |                    |    |    |    |
|---------------------------------------|--------------------|----|----|----|
| Part                                  | ALM, BRS, BRZ, ORB |    |    | 16 |
| 460                                   | ALM, BRS, BRZ, ORB |    |    | 16 |
| 461                                   | 32                 | 32 | 30 | 31 |
| 461B Gray (replacement bumper)        |                    |    |    | 3  |
| 461L                                  | 44                 | 43 | 49 | 42 |

| Heavy Duty Door Stops |        |         |         |       |
|-----------------------|--------|---------|---------|-------|
| Part                  | 2C/603 | 26D/626 | 32D/630 | Black |
| 462                   | 31     |         |         |       |
| 463-RKW               |        |         | 42      |       |
| 464-RKW               |        | 80      |         |       |
| 465                   |        | 52      |         |       |
| 466-RKW               |        |         |         | 24    |
| 467-RKW               |        |         |         | 31    |
| 468-RKW               |        |         |         | 77    |

| Door Stops - DuraFlex Bumpers |                |                   |                  |                   |
|-------------------------------|----------------|-------------------|------------------|-------------------|
| Part                          | 3/605<br>4/606 | 10/612<br>10B/613 | Stock PC<br>10BE | 26/625<br>26D/626 |
| 470                           | 31             | 33                | 37               | 32                |
| 471                           | 31             | 33                | 37               | 32                |
| 472                           | 44             | 46                | 51               | 44                |
| 473                           | 44             | 46                | 51               | 44                |
| 474                           | 31             | 33                | 37               | 32                |
| 475                           | 31             | 33                | 37               | 32                |
| 476                           | 44             | 46                | 51               | 44                |
| 477                           | 44             | 46                | 51               | 44                |
| 480                           | 31             | 33                | 37               | 32                |
| 480H                          | 33             | 36                | 40               | 34                |
| 481                           | 38             | 42                | 46               | 40                |
| 481H                          | 42             | 44                | 49               | 42                |
| 481MP Powder Coat Finish      |                |                   |                  | 54                |
| 482                           | 32             | 36                | 40               | 34                |
| 483                           | 32             | 36                | 40               | 34                |
| 485                           | 46             | 53                | 58               | 51                |

| Angle Door Stop - DuraFlex Bumper |        |  |  |  |
|-----------------------------------|--------|--|--|--|
| Part                              | 2C/603 |  |  |  |
| 486                               | 13     |  |  |  |

| Heavy Duty Wall Stop - DuraFlex Bumper |         |  |  |  |
|--|---------|--|--|--|
| Part                                   | 26D/626 |  |  |  |
| 487                                    | 34      |  |  |  |

Prices Effective September 1, 2017

Copyright © 2017, Rockwood Manufacturing Company, an ASSA ABLOY Group company. All rights reserved.  
Reproduction in whole or in part without the express written permission of Rockwood Manufacturing Company is prohibited.

ASSA ABLOY

The global leader in  
door opening solutions

Door Stops (con't)

| Door Stops   |                           |                            |                          |                   |
|--|---------------------------|----------------------------|--------------------------|-------------------|
| Part   | 3/605<br>4/606            | 10/612<br>10B/613          | Stock PC<br>10BE         | 14/618<br>15/619  |
| 488  | 44                        | 49                         | 56                       | 49                |
| 489  | 54                        | 60                         | 69                       | 60                |
| Door Holder & Stop                                 |                           |                            |                          |                   |
| Part   | 26D/626                   |                            |                          |                   |
| 490  | 46                        |                            |                          |                   |
| Automatic Door Holder & Stop                       |                           |                            |                          |                   |
| Part   | 3/605<br>4/606            | 10/612<br>10B/613          | Stock PC<br>10BE         | 26/625<br>26D/626 |
| 491-RKW  | 72                        | 79                         | 87                       | 75                |
| 491R   | 78                        | 83                         | 92                       | 80                |
| 491S   | 84                        | 88                         | 98                       | 85                |
| 494-RKW  | 81                        | 86                         | 96                       | 83                |
| 494R   | 84                        | 89                         | 99                       | 86                |
| 494S   | 89                        | 96                         | 106                      | 92                |
| Door Stops - DuraFlex Bumpers                      |                           |                            |                          |                   |
| 505-RKW  | 17                        | 17                         | 19                       | 16                |
| 508  | 28                        | 28                         | 30                       | 27                |
| 517 Polished Brass (BRS), Burnished Aluminum (ALM) |                           |                            |                          | 9                 |
| 518  | 20                        | 20                         | 22                       | 19                |
| 519  | 20                        | 20                         | 22                       | 19                |
| 520 White (replacement bumper)                     |                           |                            |                          | 3                 |
| Part   | Antique<br>Brass<br>(ANT) | Polished<br>Brass<br>(BRS) | Bright<br>Nickel<br>(NP) |                   |
| 525  | 4                         | 4                          | 4                        |                   |
| 526  |                           | 5                          | 5                        |                   |
| 528  | 8                         | 8                          | 8                        |                   |

Flush Bolts, Guides & Strikes

| Flush Bolts, Guides & Strikes                |                |                   |                  |                   |
|--|----------------|-------------------|------------------|-------------------|
| Part   | 3/605<br>4/606 | 10/612<br>10B/613 | Stock PC<br>10BE | 26/625<br>26D/626 |
| 550  | 40             | 42                | 45               | 40                |
| 550G   | 6              | 6                 | 6                | 5                 |
| 550S   | 6              | 6                 | 6                | 5                 |
| 554  | 45             | 45                | 48               | 43                |
| 554G   | 30             | 30                | 32               | 29                |
| 554S   | 30             | 30                | 32               | 29                |
| 555  | 29             | 31                | 35               | 27                |
| 555B (1 1/2" standard bolt head)             |                | 6                 |                  |                   |
| 555B (extra long bolt head - specify length) |                | 19                |                  |                   |
| 555G   | 5              | 5                 | 5                | 4                 |
| 555S   | 5              | 5                 | 5                | 4                 |
| 555ROD/per ft. (specify length)              |                | 7                 |                  |                   |
| 555 x 18BFB                                  |                |                   |                  | 130               |
| 556WS  |                |                   |                  | 79                |
| 557  | 42             | 48                | 52               | 46                |
| 557S   | 6              | 6                 | 6                | 5                 |
| 557 x 19BFB                                  |                |                   |                  | 144               |
| 570  | 23             | 24                | 26               | 24                |

**ASSA ABLOY**

The global leader in door opening solutions

Gravity Door Coordinator

| Gravity Door Coordinators |                |                   |                  |                   |
|---------------------------|----------------|-------------------|------------------|-------------------|
| Part                      | 3/605<br>4/606 | 10/612<br>10B/613 | Stock PC<br>10BE | 26/625<br>26D/626 |
| 576                       | 92             | 99                | 107              | 93                |
| 576B Gray                 |                |                   | 5                |                   |

Surface Bolts

| Surface Bolts            |                                       |                  |         |         |
|--------------------------|---------------------------------------|------------------|---------|---------|
| Part                     | 3/605<br>10/612<br>10B/613<br>Painted | Stock PC<br>10BE | 26D/626 | 32D/630 |
| 580-8                    | 35                                    | 43               | 38      | 63      |
| 580-12                   | 45                                    | 46               | 42      |         |
| 580-18                   | 123                                   | 138              | 123     |         |
| 580-24                   | 132                                   | 148              | 132     |         |
| 582-8                    |                                       |                  |         | 99      |
| 582-12                   |                                       |                  |         | 123     |
| Heavy Duty Surface Bolts |                                       |                  |         |         |
| 585-12                   |                                       |                  | 133     |         |
| 585-24                   |                                       |                  | 165     |         |

Roller Latches

| Roller Latches      |                |                   |                  |                   |
|---------------------|----------------|-------------------|------------------|-------------------|
| Part                | 3/605<br>4/606 | 10/612<br>10B/613 | Stock PC<br>10BE | 26/625<br>26D/626 |
| 590                 | 47             | 50                | 53               | 47                |
| 590DA (Strike Only) | 83             | 83                | 83               | 83                |
| 590SO               | 16             | 16                | 17               | 15                |
| 591                 | 53             | 57                | 60               | 54                |
| 591SO               | 19             | 19                | 19               | 17                |
| 592                 | 47             | 50                | 53               | 47                |
| 592SO               | 16             | 16                | 17               | 15                |
| 593                 | 87             | 94                | 100              | 89                |
| 593SO               | 16             | 16                | 17               | 15                |
| 594                 | 53             | 57                | 60               | 54                |
| 594SO               | 16             | 16                | 17               | 15                |

Hospital Push/Pull Latches

| Hospital Push/Pull Latches |                  |         |       |
|----------------------------|------------------|---------|-------|
| Part                       | Stock PC<br>10BE | 32D/630 | 32DMS |
| 596                        | 273              | 244     | 277   |
| 596L                       | 303              | 275     | 306   |
| 596S                       | 273              | 244     | 277   |
| 596BS2                     |                  | 66      |       |
| 596BS5                     |                  | 68      |       |
| 596BS7                     |                  | 103     |       |
| Engraving (set)            |                  | 60      |       |
| Lead Lining                |                  | 84      |       |
| Latchbolt Only             |                  | 60      |       |
| 596STRK2 (Strike Only)     |                  | 28      |       |
| 596STRK5 (Strike Only)     |                  | 28      |       |

Gate Latch

| Gate Latch         |       |                   |                  |         |
|--------------------|-------|-------------------|------------------|---------|
| Part               | 4/606 | 10/612<br>10B/613 | Stock PC<br>10BE | 26D/626 |
| 602                | 42    | 42                | 44               | 40      |
| 602 Spring (25 pk) |       |                   |                  | 12      |

Prices Effective September 1, 2017

Copyright © 2017, Rockwood Manufacturing Company, an ASSA ABLOY Group company. All rights reserved. Reproduction in whole or in part without the express written permission of Rockwood Manufacturing Company is prohibited.

## Door Guards

| Door Guards            |                     |                      |                     |   |
|------------------------|---------------------|----------------------|---------------------|---|
| Part                   | Antique Brass (ANT) | Polished Brass (BRS) | Bright Chrome (CRM) |   |
| 603                    | 12                  | 12                   | 12                  |   |
| 603 Shim Clear Plastic |                     |                      |                     | 6 |
| Part                   | 3/605<br>4/606      | 10/612<br>10B/613    | 26/625<br>26D/626   |   |
| 604                    | 30                  | 30                   | 29                  |   |
| 604 Shim Clear Plastic |                     |                      |                     | 6 |

## Door Guard Protection Plate

| Door Guard Protection Plate |                |       |                   |                   |
|-----------------------------|----------------|-------|-------------------|-------------------|
| Part                        | 3/605<br>4/606 | 5/609 | 10/612<br>10B/613 | 26/625<br>26D/626 |
| 605                         | 11             | 11    | 12                | 11                |
| 605SMS                      | 11             | 10    | 12                | 11                |

## Wall Guard

| Wall Guard |           |       |
|------------|-----------|-------|
| Part       | Pack Size | Clear |
| 606-RKW    | 55/sheet  | 62    |

## Privacy Door Latch

| Privacy Door Latch |          |     |                    |
|--------------------|----------|-----|--------------------|
| Part               | BRS/DBRS | ORB | CRM, DCRM,<br>STNN |
| PDL (607)          | 49       | 49  | 46                 |

## Door Silencers

| Door Silencers |           |       |             |
|----------------|-----------|-------|-------------|
| Part           | Pack Size | Clear | Gray Rubber |
| 608-RKW        | 100       |       | 16          |
| 608CA          | 300       | 109   |             |
| 609            | 100       |       | 16          |

## Door Knockers

| Door Knockers |                |                   |                  |                   |
|---------------|----------------|-------------------|------------------|-------------------|
| Part          | 3/605<br>4/606 | 10/612<br>10B/613 | Stock PC<br>10BE | 26/625<br>26D/626 |
| 611           | 68             | 68                | 73               | 66                |
| 614           | 36             | 39                | 42               | 37                |
| 614V          | 46             | 48                | 51               | 46                |

## Door Viewers

| Door Viewers |                      |                      |                     |                     |
|--------------|----------------------|----------------------|---------------------|---------------------|
| Part         | Antique Bronze (ANT) | Polished Brass (BRS) | Bright Chrome (CRM) | Satin Nickel (STNN) |
| 619          | 13                   | 13                   | 13                  | 13                  |
| 620          | 11                   | 11                   | 11                  |                     |
| 621          | 12                   | 12                   | 12                  |                     |
| 622          | 13                   | 13                   | 13                  | 14                  |

## Door Viewer Washers

| Door Viewer Washers |                      |                      |
|---------------------|----------------------|----------------------|
| Part                | Stainless Steel (SS) | Polished Brass (BRS) |
| 619W 1/2" Hole      | 7                    | 7                    |
| 626W 9/16" Hole     | 7                    | 7                    |

## Door Viewers with Covers

| Door Viewers with Covers |           |                      |                      |                     |                    |
|--------------------------|-----------|----------------------|----------------------|---------------------|--------------------|
| Part                     | Pack Size | Antique Bronze (ANT) | Polished Brass (BRS) | Bright Chrome (CRM) | Dull Chrome (DCRM) |
| 620VC                    | 10        | 80                   | 80                   | 80                  |                    |
| 622VC                    | 10        | 90                   | 90                   | 80                  |                    |
| 624                      |           | 14                   | 14                   | 14                  |                    |
| 626                      |           | 18                   | 11                   | 18                  | 15                 |
| 627                      |           |                      |                      | 22                  |                    |
| 628                      |           |                      |                      | 20                  |                    |
| 629                      |           |                      |                      | 23                  |                    |

## Surface Bolts

| Surface Bolts |       |         |                  |         |
|---------------|-------|---------|------------------|---------|
| Part          | 3/605 | 10B/613 | Stock PC<br>10BE | 26D/626 |
| 630-4         | 34    | 38      | 42               | 37      |
| 630-8         | 61    | 67      | 66               | 59      |
| 630-12        | 93    | 103     | 111              | 99      |
| 630-24        | 175   | 193     | 209              | 188     |

## Residential Flush Bolts

| Residential Flush Bolts |       |       |         |
|-------------------------|-------|-------|---------|
| Part                    | 3/605 | 5/609 | 26D/626 |
| 640                     | 12    | 12    | 11      |
| 640RE                   | 12    | 12    | 11      |

## Card Holder

| Card Holder |                |                   |                  |         |
|-------------|----------------|-------------------|------------------|---------|
| Part        | 3/605<br>4/606 | 10/612<br>10B/613 | Stock PC<br>10BE | 26D/626 |
| 651         | 18             | 18                | 19               | 17      |

## Decals

| Decals  |       |
|---------|-------|
| Part    | Price |
| 660     | 10    |
| 661     | 10    |
| 662-RKW | 10    |

## 670 Series Engraved Signs

| 670 Series Engraved          |                        |        |                |        |         |                  |                   |         |
|------------------------------|------------------------|--------|----------------|--------|---------|------------------|-------------------|---------|
| Part                         | Black or Brown Plastic | 28/628 | 3/605<br>4/606 | 10/612 | 10B/613 | Stock PC<br>10BE | 26/625<br>26D/626 | 32D/630 |
| 670 (1"H Letters or smaller) | 9                      | 15     | 17             | 18     | 17      | 18               | 16                | 15      |
| 670 (Over 1" up to 3")       | 13                     | 20     | 21             | 21     | 21      | 25               | 20                | 22      |
| 670M                         | 18                     | 32     | 36             | 36     | 41      | 44               | 35                | 39      |
| 670W                         | 20                     | 44     | 49             | 50     | 51      | 61               | 46                | 53      |
| 670R                         | 22                     | 64     | 68             | 67     | 70      | 89               | 66                | 78      |
| 674H (PUSH)                  | 21                     | 27     | 38             | 39     | 44      | 46               | 37                | 41      |
| 674L (PULL)                  | 21                     | 27     | 38             | 39     | 44      | 46               | 37                | 41      |

Available in .125" thick plastic or .050" thick metal. Pricing is per letter for Part 670—minimum of 3 letters; per sign for Part's 670M, 670W, 670R. Call for pricing on multi-line signs.

## BF680 Series Barrier Free Signs

| BF680 Series Barrier Free |                                   |        |                |        |          |                  |                   |         |
|---------------------------|-----------------------------------|--------|----------------|--------|----------|------------------|-------------------|---------|
| Part                      | Black, Blue, Brown or Red Plastic | 28/628 | 3/605<br>4/606 | 10/612 | 10BL/614 | Stock PC<br>10BE | 26/625<br>26D/626 | 32D/630 |
| BF680                     | 14                                | 28     | 27             | 26     | 29       | 36               | 26                | 32      |
| BF680M                    | 31                                | 71     | 67             | 66     | 69       | 92               | 64                | 79      |
| BF680W                    | 44                                | 103    | 98             | 98     | 103      | 141              | 94                | 123     |
| BF680R                    | 62                                | 150    | 142            | 142    | 151      | 218              | 138               | 190     |

Standard 1" letter height. Grade 2 Braille translations. Available in .125" non-glare plastic or .050" thick metal. Pricing is per letter for Part BF680—minimum of 3 letters per sign for Part's BF680M, BF680W, BF680R. Screw mounting provided. Self-adhesive mounting available.

## BF Series ADA Tactile Signs

| BF Series ADA Tactile |                                   |        |                |                    |                  |                   |         |
|-----------------------|-----------------------------------|--------|----------------|--------------------|------------------|-------------------|---------|
| Part                  | Black, Blue, Brown or Red Plastic | 28/628 | 3/605<br>4/606 | 10/612<br>10BL/614 | Stock PC<br>10BE | 26/625<br>26D/626 | 32D/630 |
| BF683                 | 54                                | 174    | 164            | 164                | 176              | 158               | 154     |
| BF684                 | 54                                | 174    | 164            | 164                | 176              | 158               | 154     |
| BF685                 | 54                                | 174    | 164            | 164                | 176              | 158               | 154     |
| BF686                 | 64                                | 200    | 190            | 190                | 206              | 184               | 179     |
| BF687                 | 57                                | 187    | 177            | 177                | 191              | 171               | 166     |
| BF688                 | 57                                | 187    | 177            | 177                | 191              | 171               | 166     |
| BF689                 | 64                                | 200    | 190            | 190                | 206              | 184               | 179     |

Standard 1" letter height. Grade 2 Braille translations. Available in .125" non-glare plastic or .050" thick metal. Screw mounting provided. Self-adhesive mounting available.

## BFM Series ADA Molded Plastic Signs

| BFM Series ADA Molded Plastic |       |      |
|-------------------------------|-------|------|
| Part                          | Black | Blue |
| BFM682                        | 22    | 22   |
| BFM684                        | 22    | 22   |
| BFM685                        | 22    | 22   |
| BFM686                        | 22    | 22   |
| BFM687                        | 22    | 22   |
| BFM688                        | 22    | 22   |
| BFM689                        | 22    | 22   |

Standard 5/8" letter height. Grade 2 Braille translations. Self-adhesive mounting.

## ASSA ABLOY

The global leader in  
door opening solutions

Prices Effective September 1, 2017

Copyright © 2017, Rockwood Manufacturing Company, an ASSA ABLOY Group company. All rights reserved.  
Reproduction in whole or in part without the express written permission of Rockwood Manufacturing Company is prohibited.

## Auxiliary Hardware

| Hand Rail Brackets - Specify Wood or Metal Rail       |                 |                                      |                   |                   |                   |                       |
|---|-----------------|--------------------------------------|-------------------|-------------------|-------------------|-----------------------|
| Part  | 3/605           | 4/606                                | 10/612<br>10B/613 | Stock PC<br>10BE  | 26D/626           |                       |
| 700   | 65              | 74                                   | 74                | 77                | 72                |                       |
| 701   | 61              | 70                                   | 70                | 73                | 67                |                       |
| 702   | 57              | 65                                   | 65                | 67                | 63                |                       |
| Coat Hooks  |                 |                                      |                   |                   |                   |                       |
| Part  | 3/605           | 4/606<br>10/612<br>10B/613<br>26/625 | Stock PC<br>10BE  | 15/619            | 15A/620           | 26D/626               |
| 790   | 12              | 16                                   | 14                | 16                | 19                | 12                    |
| 796   | 13              | 17                                   | 14                | 17                | 19                | 12                    |
| 802   | 13              | 20                                   | 15                | 19                | 20                | 13                    |
| 806   | 15              | 21                                   | 16                | 20                | 21                | 14                    |
| Ball Knob   |                 |                                      |                   |                   |                   |                       |
| Part  | 3/605<br>26/625 | 4/606<br>10/612<br>10B/613           | Stock PC<br>10BE  | 15/619            | 15A/620           | 26D/626               |
| 841   | 12              | 16                                   | 13                | 16                | 17                | 11                    |
| Utility Pull  |                 |                                      |                   |                   |                   |                       |
| Part  | 3/605           | 4/606                                | 10/612<br>10B/613 | Stock PC<br>10BE  | 26/625<br>26D/626 | Burnished<br>Aluminum |
| 845   | 28              | 28                                   | 32                | 34                | 31                | 10                    |
| Wire Pulls - Specify Door Thickness                   |                 |                                      |                   |                   |                   |                       |
| Part  | 3/605<br>4/606  | 10/612<br>10B/613                    | Stock PC<br>10BE  | 26/625<br>26D/626 | 32D/630           | 32DMS                 |
| 850   | 25              | 27                                   | 26                | 24                |                   |                       |
| 851   | 25              | 27                                   | 26                | 24                |                   |                       |
| 852   | 25              | 27                                   | 26                | 24                |                   |                       |
| 853   | 25              | 27                                   | 23                | 24                | 21                | 25                    |
| 856-RKW   | 28              | 29                                   | 31                | 27                |                   |                       |
| Flush Pulls   |                 |                                      |                   |                   |                   |                       |
| Part  | 3/605           | 10B/613                              | Stock PC<br>10BE  | 26D/626           | 32D/630           |                       |
| 860   | 8               | 9                                    | 9                 |                   | 8                 |                       |
| 870   | 6               | 7                                    | 6                 |                   | 5                 |                       |
| 872   | 20              | 23                                   | 21                | 19                |                   |                       |
| Edge Pulls  |                 |                                      |                   |                   |                   |                       |
| 880   | 18              | 19                                   |                   | 18                |                   |                       |
| 885-RKW   | 43              | 48                                   | 50                | 46                |                   |                       |
| Pocket Door Pulls - For use on 1 3/8" to 1 3/4" Doors |                 |                                      |                   |                   |                   |                       |
| Part  | 3/605           | 10B/613                              | 26/625            | 26D/626           |                   |                       |
| 890   | 18              | 20                                   | 17                | 17                |                   |                       |
| 891   | 19              | 21                                   | 18                | 18                |                   |                       |
| Magnetic Catches                                      |                 |                                      |                   |                   |                   |                       |
| Part  | Brass           | Aluminum                             |                   |                   |                   |                       |
| 900   | 11              | 11                                   |                   |                   |                   |                       |
| 901   | 13              | 13                                   |                   |                   |                   |                       |
| Adjustable Ball Catches                               |                 |                                      |                   |                   |                   |                       |
| Part  | 3/605           | 26D/626                              |                   |                   |                   |                       |
| 910   | 11              | 10                                   |                   |                   |                   |                       |
| 910RC   | 11              | 10                                   |                   |                   |                   |                       |
| 911   | 12              | 11                                   |                   |                   |                   |                       |
| 911RC   | 12              | 11                                   |                   |                   |                   |                       |

## Coordinators

| Carry Bar for 2600 Series Coordinators            |                          |                |                   |                   |
|---|--------------------------|----------------|-------------------|-------------------|
| Part  | Black<br>Prime<br>Coated | 3/605<br>4/606 | 10/612<br>10B/613 | 26/625<br>26D/626 |
| 1100  | 36                       | 65             | 65                | 63                |
| Mounting Brackets (For Soffit Applied Hardware)   |                          |                |                   |                   |
| Part  | Black<br>Prime<br>Coated | 28/689         |                   |                   |
| 2601AB  | 29                       | 40             |                   |                   |
| 2601C   | 29                       | 40             |                   |                   |
| 2600 Series Coordinators w/Filler and Filler Bars |                          |                |                   |                   |
| NX2648-<br>NX2654                                 | 133                      | 147            |                   |                   |
| 2655-2660   | 145                      | 158            |                   |                   |
| 2661-2672   | 145                      | 158            |                   |                   |
| 2673-2696   | 162                      | 204            |                   |                   |
| L2662-<br>L26112                                  | 169                      | 211            |                   |                   |
| FB-1  | 26                       | 31             |                   |                   |
| FB-2  | 29                       | 37             |                   |                   |
| 1700 Universal Door Coordinator                   |                          |                |                   |                   |
| 1700  | 106                      | 117            |                   |                   |

## Flush Bolts

| Flush Bolts              |                                     |                  |        |         |         |
|--------------------------|-------------------------------------|------------------|--------|---------|---------|
| Part                     | 3/605<br>4/606<br>10/612<br>10B/613 | Stock PC<br>10BE | 26/625 | 26D/626 | 32D/630 |
| 2805                     | 99                                  | 107              | 99     | 96      | 96      |
| 2840                     | 99                                  | 107              | 99     | 96      | 96      |
| 2842                     | 194                                 | 209              | 194    | 159     | 187     |
| 2845                     | 194                                 | 209              | 194    | 187     | 187     |
| 2848                     | 194                                 | 209              | 194    | 187     | 187     |
| 2849                     | 194                                 | 209              | 194    | 187     | 187     |
| 2905                     | 103                                 | 112              | 103    | 100     | 100     |
| 2940                     | 103                                 | 112              | 103    | 100     | 100     |
| 2942                     | 205                                 | 222              | 205    | 199     | 170     |
| 2945                     | 205                                 | 222              | 205    | 199     | 199     |
| 2948                     | 194                                 | 209              | 194    | 187     | 187     |
| 2949                     | 194                                 | 209              | 194    | 187     | 187     |
| 2960                     | 242                                 | 262              | 242    | 235     | 235     |
| 2962                     | 242                                 | 262              | 242    | 235     | 235     |
| BFB (wood or metal door) |                                     |                  |        |         | 99      |
| CPK2840                  | 19                                  | 20               | 19     | 18      | 18      |

Overhead Holders & Stops

| Heavy Duty Concealed - Stop Only                    |                  |         |
|---|------------------|---------|
| Part  | 10B/613          | 32D/630 |
| OH101S  | 347              | 320     |
| OH102S  | 347              | 320     |
| OH103S  | 347              | 320     |
| OH104S  | 347              | 320     |
| OH105S  | 347              | 320     |
| OH101H  | 347              | 320     |
| OH102H  | 347              | 320     |
| OH103H  | 347              | 320     |
| OH104H  | 347              | 320     |
| OH105H  | 347              | 320     |
| Standard Duty Concealed - Multi-function            |                  |         |
| OH201M  | 196              | 146     |
| OH202M  | 196              | 146     |
| OH203M  | 196              | 146     |
| OH204M  | 196              | 146     |
| OH205M  | 196              | 146     |
| Heavy Duty Surface Mounted - Stop Only              |                  |         |
| OH901S  | 329              | 285     |
| OH902S  | 329              | 285     |
| OH903S  | 329              | 285     |
| OH904S  | 329              | 285     |
| OH905S  | 329              | 285     |
| OH901H  | 329              | 285     |
| OH902H  | 329              | 285     |
| OH903H  | 329              | 285     |
| OH904H  | 329              | 285     |
| OH905H  | 329              | 285     |
| Standard Duty Surface Mounted - Multi-function      |                  |         |
| OH1001M   | 233              | 158     |
| OH1002M   | 233              | 158     |
| OH1003M   | 233              | 158     |
| OH1004M   | 233              | 158     |
| OH1005M   | 233              | 158     |
| Overhead Stops with Aluminum Channel (Coming Soon!) |                  |         |
| Part  | Brushed Aluminum |         |
| OH103S-ALM  | *                |         |
| OH203S-ALM  | *                |         |
| OH903S-ALM  | *                |         |
| OH1003S-ALM   | *                |         |

\*Prices available upon launch.

Covers

| Latch Guard Covers - .062" Thick (Specify Handing) |       |        |         |               |         |
|--|-------|--------|---------|---------------|---------|
| Part   | 3/605 | 10/612 | 10B/613 | Stock PC 10BE | 32D/630 |
| BFLG10   | 227   | 227    | 227     | 116           | 106     |
| BFLG12   | 244   | 244    | 244     | 122           | 110     |
| BFLG16   | 274   | 274    | 274     | 135           | 123     |
| Vertical Rod Covers - .050" Thick                  |       |        |         |               |         |
| BFRC12   | 60    | 64     | 64      | 44            | 40      |
| BFRC24   | 96    | 102    | 102     | 63            | 56      |

**ASSA ABLOY**

The global leader in door opening solutions

Prices Effective September 1, 2017

Copyright © 2017, Rockwood Manufacturing Company, an ASSA ABLOY Group company. All rights reserved. Reproduction in whole or in part without the express written permission of Rockwood Manufacturing Company is prohibited.

## Pivots

| Standard Head        |                |                   |                  |                   |
|----------------------|----------------|-------------------|------------------|-------------------|
| Part                 | 3/605<br>4/606 | 10/612<br>10B/613 | Stock PC<br>10BE | 26/625<br>26D/626 |
| CP10                 | 250            | 274               | 285              | 265               |
| CP10HD               | 364            | 387               | 404              | 376               |
| Standard Head Pivot  |                |                   |                  |                   |
| CP20                 | 250            | 274               | 285              | 265               |
| CP20HD               | 364            | 387               | 404              | 376               |
| Standard Floor       |                |                   |                  |                   |
| CP40                 | 250            | 274               | 285              | 265               |
| CP40HD               | 364            | 387               | 404              | 376               |
| Standard Floor Pivot |                |                   |                  |                   |
| CP50                 | 250            | 274               | 285              | 265               |
| CP50HD               | 364            | 387               | 404              | 376               |

Prices are for 1 3/4" thick wood doors. Pivots for thicker doors are priced on application. Allow 4 weeks delivery. NOTE: Pivots are 3/8" x 7/8" wide; HD (heavy duty) pivots are 1/2" x 1" wide.

## Custom Strikes

| Custom Strikes                                    |          |                                     |                  |                   |         |        |
|---|----------|-------------------------------------|------------------|-------------------|---------|--------|
| Part  | Quantity | 3/605<br>4/606<br>10/612<br>10B/613 | Stock PC<br>10BE | 26/625<br>26D/626 | 32D/630 | 32/629 |
| CS-ASA1,<br>CS-ASA2,<br>CS-OM,<br>CS-T,<br>590-DA | Up to 5  | 62                                  | 61               | 66                | 54      | 65     |
|   | 6 to 10  | 58                                  | 60               | 61                | 53      | 61     |
|   | 11 to 20 | 53                                  | 54               | 57                | 48      | 56     |
|   | 21 +     | 51                                  | 52               | 53                | 46      | 53     |

.090" Thick (\$94.50 minimum charge. Made to your specifications.)

## Filler Plates & Shims

| Filler Plates & Shims |           |       |
|-----------------------|-----------|-------|
| Part                  | Pack Size | Price |
| DF86                  | 25        | 150   |
| DFF4                  | 25        | 100   |
| DFF5                  | 25        | 125   |
| DHF4B                 | 25        | 125   |
| DHF4S                 | 25        | 125   |
| DHF5B                 | 25        | 125   |
| DHF5S                 | 25        | 125   |
| FBF48                 | 25        | 125   |
| FBS48                 | 25        | 100   |
| FC161                 | 25        | 125   |
| FD160                 | 25        | 125   |
| HS42                  | 50        | 150   |
| HS44                  | 50        | 150   |
| HS52                  | 50        | 150   |

Sold in pack quantities only.

| Part   | Pack Size | Price |
|--------|-----------|-------|
| HS54   | 50        | 150   |
| LA86   | 25        | 300   |
| LF161  | 25        | 100   |
| SFASA  | 25        | 100   |
| SF160  | 25        | 100   |
| SFB160 | 25        | 125   |

## Angle Plates

| Angle Plates      |             |                                     |
|-------------------|-------------|-------------------------------------|
| Part              | Description | Pricing                             |
| KB1150<br>Style A | One-Sided   | Fax or Email Dimensions for Pricing |
| KB1151<br>Style C | Two-Sided   | Fax or Email Dimensions for Pricing |
| KB1152<br>Style B | Bottom      | Fax or Email Dimensions for Pricing |

.050" Thick - Refer to page 41 for Angle Plate Fasteners. Add \$35 list per bend to plates price.

## Trim Protector Bars

| Heavy Duty - 3/8" thick stainless for heavy traffic.<br>5/8" in over 8" CTC.                                 |       |                   |                  |         |       |
|--|-------|-------------------|------------------|---------|-------|
| Part   | CTC   | Stock PC<br>10BE  | 32D/630          | 32DMS   |       |
| HD2230   | 8"    | 112               | 103              | 112     |       |
| HD2240   | 8"    | 112               | 103              | 112     |       |
| HD2250   | 8"    | 112               | 103              | 112     |       |
| Lever - 3/8" thick for heavy traffic. 5/8" in over standard CTC.   |       |                   |                  |         |       |
| Part   | 3/605 | 10/612<br>10B/613 | Stock PC<br>10BE | 32D/630 | 32DMS |
| R101LPB  | 190   | 218               | 138              | 128     | 138   |
| R102LPB  | 231   | 285               | 179              | 166     | 179   |
| R111LPB  | 204   | 243               | 152              | 140     | 152   |
| R112LPB  | 243   | 298               | 206              | 190     | 206   |
| R115LPB  | 218   | 257               | 165              | 152     | 165   |
| Exit Device - 3/8" thick stainless for heavy traffic.<br>Field cutting hinge end of exit device is required. |       |                   |                  |         |       |
| R116EDPL   |       |                   | 317              | 292     | 317   |
| R116EDPH   |       |                   | 317              | 292     | 317   |
| Standard Duty - 3/16" thick stainless for moderate traffic.  |       |                   |                  |         |       |
| SD1230   |       |                   | 56               | 52      | 56    |
| SD1240   |       |                   | 56               | 52      | 56    |
| SD1250   |       |                   | 56               | 52      | 56    |
| SD1260   |       |                   | 56               | 52      | 56    |



### Door Plates Hundred Square Inch Size Chart

To calculate the list price of kick plate, use the hundred square inch number times the list price. Use the next higher even number for odd or fractional sizes. (Example: 9" x 33 1/2" — price as 10" x 34" which is 3.40 square inches.) Take that number times the list price from the following page. (Example: 32D list \$19 x 3.40 = \$64.60)

| H/W | 24"   | 26"   | 28"   | 30"   | 32"   | 34"   | 36"   | 38"   | 40"   | 42"   | 44"   | 46"   | 48"   |
|-----|-------|-------|-------|-------|-------|-------|-------|-------|-------|-------|-------|-------|-------|
| 4"  | 0.96  | 1.04  | 1.12  | 1.20  | 1.28  | 1.36  | 1.44  | 1.52  | 1.60  | 1.68  | 1.76  | 1.84  | 1.92  |
| 6"  | 1.44  | 1.56  | 1.68  | 1.80  | 1.92  | 2.04  | 2.16  | 2.28  | 2.40  | 2.52  | 2.64  | 2.76  | 2.88  |
| 8"  | 1.92  | 2.08  | 2.24  | 2.40  | 2.56  | 2.72  | 2.88  | 3.04  | 3.20  | 3.36  | 3.52  | 3.68  | 3.84  |
| 10" | 2.40  | 2.60  | 2.80  | 3.00  | 3.20  | 3.40  | 3.60  | 3.80  | 4.00  | 4.20  | 4.40  | 4.60  | 4.80  |
| 12" | 2.88  | 3.12  | 3.36  | 3.60  | 3.84  | 4.08  | 4.32  | 4.56  | 4.80  | 5.04  | 5.28  | 5.52  | 5.76  |
| 14" | 3.36  | 3.64  | 3.92  | 4.20  | 4.48  | 4.76  | 5.04  | 5.32  | 5.60  | 5.88  | 6.16  | 6.44  | 6.72  |
| 16" | 3.84  | 4.16  | 4.48  | 4.80  | 5.12  | 5.44  | 5.76  | 6.08  | 6.40  | 6.72  | 7.04  | 7.36  | 7.68  |
| 18" | 4.32  | 4.68  | 5.04  | 5.40  | 5.76  | 6.12  | 6.48  | 6.84  | 7.20  | 7.56  | 7.92  | 8.28  | 8.64  |
| 20" | 4.80  | 5.20  | 5.60  | 6.00  | 6.40  | 6.80  | 7.20  | 7.60  | 8.00  | 8.40  | 8.80  | 9.20  | 9.60  |
| 22" | 5.28  | 5.72  | 6.16  | 6.60  | 7.04  | 7.48  | 7.92  | 8.36  | 8.80  | 9.24  | 9.68  | 10.12 | 10.56 |
| 24" | 5.76  | 6.24  | 6.72  | 7.20  | 7.68  | 8.16  | 8.64  | 9.12  | 9.60  | 10.08 | 10.56 | 11.04 | 11.52 |
| 26" | 6.24  | 6.76  | 7.28  | 7.80  | 8.32  | 8.84  | 9.36  | 9.88  | 10.40 | 10.92 | 11.44 | 11.96 | 12.48 |
| 28" | 6.72  | 7.28  | 7.84  | 8.40  | 8.96  | 9.52  | 10.08 | 10.64 | 11.20 | 11.76 | 12.32 | 12.88 | 13.44 |
| 30" | 7.20  | 7.80  | 8.40  | 9.00  | 9.60  | 10.20 | 10.80 | 11.40 | 12.00 | 12.60 | 13.20 | 13.80 | 14.40 |
| 32" | 7.68  | 8.32  | 8.96  | 9.60  | 10.24 | 10.88 | 11.52 | 12.16 | 12.80 | 13.44 | 14.08 | 14.72 | 15.36 |
| 34" | 8.16  | 8.84  | 9.52  | 10.20 | 10.88 | 11.56 | 12.24 | 12.92 | 13.60 | 14.28 | 14.96 | 15.64 | 16.32 |
| 36" | 8.64  | 9.36  | 10.08 | 10.80 | 11.52 | 12.24 | 12.96 | 13.68 | 14.40 | 15.12 | 15.84 | 16.56 | 17.28 |
| 38" | 9.12  | 9.88  | 10.64 | 11.40 | 12.16 | 12.92 | 13.68 | 14.44 | 15.20 | 15.96 | 16.72 | 17.48 | 18.24 |
| 40" | 9.60  | 10.40 | 11.20 | 12.00 | 12.80 | 13.60 | 14.40 | 15.20 | 16.00 | 16.80 | 17.60 | 18.40 | 19.20 |
| 42" | 10.08 | 10.92 | 11.76 | 12.60 | 13.44 | 14.28 | 15.12 | 15.96 | 16.80 | 17.64 | 18.48 | 19.32 | 20.16 |
| 44" | 10.56 | 11.44 | 12.32 | 13.20 | 14.08 | 14.96 | 15.84 | 16.72 | 17.60 | 18.48 | 19.36 | 20.24 | 21.12 |
| 46" | 11.04 | 11.96 | 12.88 | 13.80 | 14.72 | 15.64 | 16.56 | 17.48 | 18.40 | 19.32 | 20.24 | 21.16 | 22.08 |
| 48" | 11.52 | 12.48 | 13.44 | 14.40 | 15.36 | 16.32 | 17.28 | 18.24 | 19.20 | 20.16 | 21.12 | 22.08 | 23.04 |

### Options

| Option       | Add                 | 12"H or Less | Over 12" - 48"H |
|--------------|---------------------|--------------|-----------------|
| <b>BEV</b>   | Beveled Edges       | 6            | 10              |
| <b>HVBEV</b> | Heavy Beveled Edges | 7            | 12              |
| <b>CSK</b>   | Countersunk Holes   | 7            | 12              |
| <b>SA</b>    | Self-Adhesive Mount | 17           | 36              |
| <b>CFC</b>   | CFC                 | 40           |                 |
|              | Cut for Louver      | 124          |                 |
|              | Notch for Armor     | 57           |                 |
|              | Add Row of Screws   | 18           |                 |
|              | UL & WH Listing     | 18           |                 |
|              | TEK (SS)            | 42/c         |                 |
|              | TEK (Brass)         | 78/c         |                 |
|              | TORX                | 72/c         |                 |

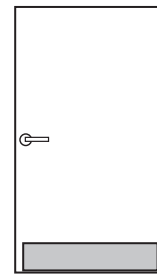

Mop Plate  
Up to 8"H x 48"W

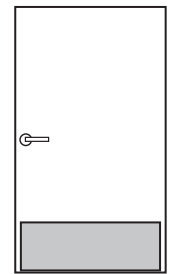

Kick Plate  
6" to 12"H x 48"W

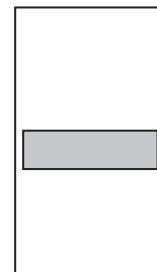

Stretcher Plate  
6" to 12"H and up to 48"W

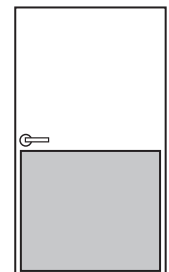

Armor Plate  
Up to 48"H x 48"W

### Screw Quantity Chart

| Height/Length | 17" - 24" | 25" - 32" | 33" - 40" | 41" - 48" |
|---------------|-----------|-----------|-----------|-----------|
| 4" - 12"      | 8 pcs.    | 10 pcs.   | 12 pcs.   | 14 pcs.   |
| 13" - 18"     | 10 pcs.   | 12 pcs.   | 14 pcs.   | 16 pcs.   |
| 19" - 24"     | 12 pcs.   | 14 pcs.   | 16 pcs.   | 18 pcs.   |
| 25" - 32"     | 16 pcs.   | 18 pcs.   | 20 pcs.   | 22 pcs.   |
| 33" - 40"     | 18 pcs.   | 20 pcs.   | 22 pcs.   | 24 pcs.   |
| 40" - 48"     | 20 pcs.   | 22 pcs.   | 24 pcs.   | 26 pcs.   |

**ASSA ABLOY**

The global leader in  
door opening solutions

Prices Effective September 1, 2017

Copyright © 2017, Rockwood Manufacturing Company, an ASSA ABLOY Group company. All rights reserved. Reproduction in whole or in part without the express written permission of Rockwood Manufacturing Company is prohibited.

## Door Plates

| K1038 Economy Duty Metal Door Plates - .038" Thick   |         |                |       |                   |                  |                   |         |        |       |        |
|--|---------|----------------|-------|-------------------|------------------|-------------------|---------|--------|-------|--------|
| Height   | 32D/630 |                |       |                   |                  |                   |         |        |       |        |
| Up to 16"  | 16      |                |       |                   |                  |                   |         |        |       |        |
| > 16" up to 48"  | 16      |                |       |                   |                  |                   |         |        |       |        |
| K1050 & K1050F Custom Size Metal Plates - .050" Thick (UL Listed)  |         |                |       |                   |                  |                   |         |        |       |        |
| See page 30 for other available options. For fire rated openings order K1050F and add \$15.75 per plate (maximum size 54"H x 46 1/2"W). K1050F screw mounted plates are UL approved for steel fire doors and frames rated up to and including 3 hours; wood composite type fire doors rated up to 1 1/2 hours. |         |                |       |                   |                  |                   |         |        |       |        |
| Height   | 28/628  | 3/605<br>4/606 | 9/611 | 10/612<br>10B/613 | Stock PC<br>10BE | 26/625<br>26D/626 | 32D/630 | 32/629 | 32DMS | 32D316 |
| 4", 6", 8", 10", 12"   | 11      | 40             | 60    | 49                | 23               | 52                | 19      | 33     | 27    | 48     |
| Special Height <12"  | 14      | 46             | 61    | 52                | 27               | 52                | 24      | 34     | 27    | 48     |
| 12.1" ≤ 36"  | 12      | 46             | 71    | 56                | 25               |                   | 21      | 32     | 25    | 45     |
| 36.1" ≤ 48"  | 12      | 52             | 80    | 63                | 25               |                   | 21      | 32     | 25    | 45     |

NOTE: Door Plate list pricing below is per Hundred Square Inches. Refer to "Hundred Square Inch Size Chart" on page 30 to calculate the list price of each door plate and other available options. See page 41 for special kick plate fasteners.



### K1050-1 - K1050-8 & K1050A-1 - K1050A-8 (.050" Thick) Shaped Metal Plates Add-On Chart

| Add unit price below to list price for kick plate from above chart. Prices are based on same size and same shape. |                       |                        |                        |
|---|-----------------------|------------------------|------------------------|
| Pieces  | Up to 16"H<br>32D/630 | >16" - 36"H<br>32D/630 | >36" - 48"H<br>32D/630 |
| 1 - 10 Pieces   | 77                    | 88                     | 93                     |
| 11 - 20 Pieces  | 57                    | 68                     | 74                     |
| 21+ Pieces  | 50                    | 61                     | 67                     |

To calculate Shapes™ metal plate price use the largest height x width dimension of the size required to make your design. Refer to "Hundred Square Inch Size Chart" on page 30 and the list price for 32D K1050 kick plates above. Then add the per plate charge using the appropriate row and column from the Shaped Metal Plates Add-On Chart on the left. See calculation example below.

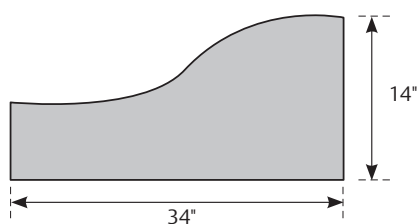

**Example: 14" x 34" Per Plate Price Calculation:**  
4.76 (Plate size from page 30) x \$21 (K1050 List Price above) + \$77 (Shapes™ Add On Price) = \$176.96 each.

## Door Plates

| K1062 Heavy Duty Metal Plates - .062" Thick         |   |                          |                           |                       |                  |         |         |
|---|---|--------------------------|---------------------------|-----------------------|------------------|---------|---------|
| Height  | Stock PC<br>10BE  | 32D/630                  | 32DMS                     |                       |                  |         |         |
| Up to 24"   | 30  | 27                       | 30                        |                       |                  |         |         |
| >24" up to 36"                                      | 30  | 27                       | 30                        |                       |                  |         |         |
| >36" up to 48"                                      |   | 27                       | 30                        |                       |                  |         |         |
| K1125 Extra Heavy Duty Metal Plates - .125" Thick   |   |                          |                           |                       |                  |         |         |
| Height  | 28/628  | 3/605<br>4/606           | 9/611                     | 10/612<br>10B/613     | Stock PC<br>10BE | 32D/630 | ALM DIA |
| Up to 48"   | 37  | 130                      | 149                       | 140                   | 75               | 68      | 38      |
| K2060 Heavy Duty Plastic Plates - .060" Thick       |   |                          |                           |                       |                  |         |         |
| Part  | Beige<br>#72005   | Calcutta Black<br>#52000 | Chocolate Brown<br>#72010 | Pewter Gray<br>#52001 |                  |         |         |
| K2060<br>Up to 48"                                  | 14  | 14                       | 14                        | 14                    |                  |         |         |
| K2060SA<br>Up to 48"                                | 19  | 19                       | 19                        | 19                    |                  |         |         |
| K2060SA-F   | UL approved for use on 90-minute wood doors and 3-hour metal doors; order K2060SA-F. Add \$15 additional per plate. Maximum size for UL label is 48"H x 42"W. |                          |                           |                       |                  |         |         |
| K2125 Extra Heavy Duty Plastic Plates - .125" Thick |   |                          |                           |                       |                  |         |         |
| Part  | Beige<br>#72005   | Calcutta Black<br>#52000 | Chocolate Brown<br>#72010 | Pewter Gray<br>#52001 |                  |         |         |
| Up to 48"   | 21  | 21                       | 21                        | 21                    |                  |         |         |
| K3125 Laminate Plastic Plates - .125" Thick         |   |                          |                           |                       |                  |         |         |
| Height  | Beige   | Black                    | Brown                     | Pewter Gray           | White            |         |         |
| Up to 48"   | 12  | 12                       | 12                        | 12                    | 12               |         |         |
| K4125 Clear Plastic Plates - .125" Thick            |   |                          |                           |                       |                  |         |         |
| Height  | Clear   |                          |                           |                       |                  |         |         |
| Up to 48"   | 12  |                          |                           |                       |                  |         |         |

**ASSA ABLOY**The global leader in  
door opening solutions

Prices Effective September 1, 2017

Copyright © 2017, Rockwood Manufacturing Company, an ASSA ABLOY Group company. All rights reserved.  
Reproduction in whole or in part without the express written permission of Rockwood Manufacturing Company is prohibited.

## Architectural Finishes

Most of Rockwood's products are available in all of the following architectural finishes. The catalog indicates exceptions. This finish list is grouped by base metal.

| Base Metal                                 | Description                                  | Price Book Code | Rockwood Code | BHMA Code |
|--|--|-----------------|---------------|-----------|
| Aluminum                                   | Satin  | 27              | US27          | 627       |
| Aluminum                                   | Clear Anodized                               | 28              | US28          | 628       |
| Aluminum                                   | Light Bronze Anodized                        | 311             | 311           | —         |
| Aluminum                                   | Medium Bronze Anodized                       | 312             | 312           | —         |
| Aluminum                                   | Dark Bronze Anodized                         | 313             | 313           | 710       |
| Aluminum                                   | Extra Dark Bronze Anodized                   | 314             | 314           | —         |
| Aluminum                                   | Black Anodized                               | 315             | 315           | 711       |
| Aluminum                                   | White Powder Coat                            | WPC             | WPC           | —         |
| Aluminum                                   | Red Powder Coat                              | RPC             | RPC           | —         |
| Aluminum                                   | Black Powder Coat                            | BPC             | BPC           | —         |
| Brass                                      | Polished Clear Coated                        | 3               | US3           | 605       |
| Brass                                      | Polished No Coating                          | 3NL             | US3NL         | —         |
| Brass                                      | Satin Clear Coated                           | 4               | US4           | 606       |
| Brass                                      | Satin Oxidized Relieved                      | 5               | US5           | 609       |
| Brass                                      | Satin Nickel Plated Clear Coated             | 15              | US15          | 619       |
| Brass                                      | Satin Nickel Blackened Relieved Clear Coated | 15A             | US15A         | 620       |
| Brass                                      | Flat Black Powder Coated                     | 19              | US19          | 622       |
| Brass                                      | Polished Chrome Plated                       | 26              | US26          | 625       |
| Brass                                      | Satin Chrome Plated                          | 26D             | US26D         | 626       |
| Bronze*                                    | Polished Clear Coated                        | 9               | US9           | 611       |
| Bronze*                                    | Satin Clear Coated                           | 10              | US10          | 612       |
| Bronze*                                    | Satin Black Oxidized Oil Rubbed              | 10A             | US10A         | —         |
| Bronze*                                    | Satin Oxidized Oil Rubbed                    | 10B             | US10B         | 613       |
| Bronze*                                    | Satin Oxidized Clear Coated                  | 10BL            | US10BL        | 614       |
| Bronze*                                    | Dark Oxidized Statuary Clear Coated          | 20A             | US20A         | 624       |
| Stainless Steel                            | Polished                                     | 32              | US32          | 629       |
| Stainless Steel                            | Satin  | 32D             | US32D         | 630       |
| <b>Special Finishes (see descriptions)</b> |  |                 |               |           |
| Stainless Steel                            | Satin MicroShield® Coated                    | 32DMS***        | US32DMS***    | —         |
| Stainless Steel                            | Polished 316 Alloy                           | 32316***        | US32316***    | —         |
| Stainless Steel                            | Satin 316 Alloy                              | 32D316***       | US32D316***   | —         |
|  | Dark Oxidized Satin Bronze, Equivalent       | 10BE            | US10BE        | (613E)    |
|  | Black Suede Powder Coat                      | BSP             | BSP           | —         |

## Special Finishes Description

**32DMS (MicroShield®):** As part of its promise to provide innovative solutions to their customers, ASSA ABLOY Group companies offer the MicroShield® technology, a silver-based antimicrobial coating designed to inhibit the spread of germs and bacteria.

**32316 and 32D316** are made from alloy 316 stainless steel containing molybdenum and extra nickel giving it substantially higher corrosion resistance than the standard stainless steels typically used in door hardware. This finish is ideal for use in coastal, urban, and industrial areas that have harsh environmental conditions. **32316 (polish)** finishes offer the best corrosion resistance and should be used in caustic environments.

**10BE Dark Oxidized Satin Bronze equivalent:** This finish provides the richness and warmth of the 10B/613 "living" finish, but maintains its original color and appearance and will not fade or wear over time. The 10BE finish is offered by Corbin Russwin, McKinney, Norton, Rixson, Rockwood, SARGENT and Yale, providing visual consistency between ASSA ABLOY Group brands.

\* On most bronze finishes we will supply solid bronze material. Where solid bronze material is not available, we will use brass as a base material with a bronze look powder coat in its place.

\*\*\* Available on select items as indicated by the finish icon throughout the catalog.



MicroShield® is a registered trademark of Yale Security Inc., an ASSA ABLOY Group company.

**ASSA ABLOY**

The global leader in  
door opening solutions

### Set Mounting Charges

| Mounting Spec # | Door Type    | Pull Type          | Mounting Type |               |            | Add On   |
|-----------------|--------------|--------------------|---------------|---------------|------------|----------|
|                 |              |                    | Pull Free End | Push Free End | Common End |          |
| T1              | Metal & Wood | Straight or Offset | 12            | 12            | 5          | 24       |
| T1HD            | Metal & Wood | Straight or Offset | 12HD          | 12HD          | 5HD        | 31       |
| T2              | Glass        | Straight or Offset | 15            | 15            | 13         | 29       |
| T2HD            | Glass        | Straight or Offset | 15HD          | 15HD          | 13HD       | 36       |
| T3*             | Metal & Wood | Straight or Offset | 1             | 1             | 5          | Included |
| T3HD            | Metal & Wood | Straight or Offset | 1HD           | 1HD           | 5HD        | 17       |
| T4              | Metal        | Straight           | 6             | 6             | 5          | 12       |
| T4HD            | Metal        | Straight           | 6HD           | 6HD           | 5HD        | 27       |
| T4              | Metal        | Offset             | 17            | 17            | 16         | 21       |
| T4HD            | Metal        | Offset             | 17HD          | 17HD          | 16HD       | 29       |
| T5              | Wood         | Straight or Offset | 8             | 8             | 5          | 21       |

\*T3 is the standard mounting method for Metal and Wood Doors.  
NOTE: Heavy Duty (HD) mounting features hex drive for positive tightening and large overall size for superior strength. Recommended for high frequency and rough service openings.

### Mounting Types

| Pull Style                       | PULL ON ONE SIDE OF DOOR |                |          |           |          |          |          |          | PULL ON BOTH SIDES OF DOOR (BTB) |          |          |          |           |
|----------------------------------|--------------------------|----------------|----------|-----------|----------|----------|----------|----------|----------------------------------|----------|----------|----------|-----------|
|                                  | Thru Bolt                | Deco Thru Bolt |          | Concealed |          |          |          |          | Conehead/Set Screw               |          |          |          | Lug Plate |
| Door Type                        | Wood/Metal               |                | Glass    | Metal     | Metal    | Wood     | Wood     | Wood     | Wood/Metal                       |          | Glass    |          | Any       |
| Coneheads                        | NA                       | NA             | NA       | Single    | Single   | Single   | Double   | Double   | Single                           | Double   | Single   | Double   | Single    |
| Mounting Type                    | Type 1                   | Type 12        | Type 15  | Type 6    | Type 6R  | Type 8   | Type 17  | Type 17R | Type 5                           | Type 16  | Type 13  | Type 18  | Type 9    |
| Standard (STD) Bolt Size         | 1/4"-20                  | 1/4"-20        | 1/4"-20  | 1/4"-20   | 1/4"-20  | 1/4"-20  | 1/4"-20  | 1/4"-20  | 1/4"-20                          | 1/4"-20  | 1/4"-20  | 1/4"-20  | 1/4"-20   |
| Price                            | INCL                     | 24.00          | 26.00    | 10.00     | 12.00    | 10.00    | 14.00    | 16.00    | 10.00                            | 14.00    | 17.00    | 20.00    | 25.00     |
| Heavy Duty (HD) Bolt Size        | 5/16"-18                 | 5/16"-18       | 5/16"-18 | 5/16"-18  | 5/16"-18 | 5/16"-18 | 5/16"-18 | 5/16"-18 | 5/16"-18                         | 5/16"-18 | 5/16"-18 | 5/16"-18 |           |
| Price                            | 5.00                     | 29.00          | 31.00    | 14.00     | 17.00    | 14.00    | 18.00    | 20.00    | 14.00                            | 18.00    | 21.00    | 25.00    |           |
| Extra Heavy Duty (XHD) Bolt Size | 3/8"-16                  | 3/8"-16        | 3/8"-16  |           |          |          |          |          |                                  |          |          |          |           |
| Price                            | 10.00                    | 29.00          | 31.00    |           |          |          |          |          |                                  |          |          |          |           |

| Straight Pulls |        |                           |         |         |        |         |        |         |          |                           |         |         |         |        |
|----------------|--------|---------------------------|---------|---------|--------|---------|--------|---------|----------|---------------------------|---------|---------|---------|--------|
| Pull Type      | Dia.   | MAXIMUM BOLT SIZE ALLOWED |         |         |        |         |        |         |          | MAXIMUM BOLT SIZE ALLOWED |         |         |         |        |
|                |        | Type 1                    | Type 12 | Type 15 | Type 6 | Type 6R | Type 8 | Type 17 | Type 17R | Type 5                    | Type 16 | Type 13 | Type 18 | Type 9 |
| Straight       | 1/2"   | STD                       | STD     | STD     |        |         | STD    |         |          |                           |         | STD     |         |        |
| Straight       | 5/8"   | HD                        | HD      | HD      | HD     |         | HD     |         |          |                           |         | HD      |         | HD     |
| Straight       | 1"     | HD                        | HD      | HD      | HD     | HD      | HD     |         |          |                           |         | HD      |         | STD    |
| Straight       | 1 1/4" | HD                        | HD      | HD      | HD     | HD      | HD     |         |          |                           |         | HD      |         | STD    |
| Straight       | 1 1/2" | HD                        | HD      | HD      | HD     | HD      | HD     |         |          |                           |         | HD      |         | STD    |

| Offset Pulls |        |                           |         |         |        |         |        |         |          |                           |         |         |         |        |
|--------------|--------|---------------------------|---------|---------|--------|---------|--------|---------|----------|---------------------------|---------|---------|---------|--------|
| Pull Type    | Dia.   | MAXIMUM BOLT SIZE ALLOWED |         |         |        |         |        |         |          | MAXIMUM BOLT SIZE ALLOWED |         |         |         |        |
|              |        | Type 1                    | Type 12 | Type 15 | Type 6 | Type 6R | Type 8 | Type 17 | Type 17R | Type 5                    | Type 16 | Type 13 | Type 18 | Type 9 |
| Offset       | 1/2"   | STD                       | STD     | STD     |        |         |        |         |          |                           |         | STD     |         |        |
| Offset       | 5/8"   | HD                        | HD      | HD      |        |         |        |         |          |                           |         | STD     |         |        |
| Offset       | 1"     | XHD                       | XHD     | XHD     |        |         |        | HD      | STD      |                           | HD      | HD      |         |        |
| Offset       | 1 1/4" | XHD                       | XHD     | XHD     |        |         |        | HD      | STD      |                           | HD      | HD      |         |        |
| Offset       | 1 1/2" | XHD                       | XHD     | XHD     |        |         |        | HD      | STD      |                           | HD      | HD      |         |        |



The global leader in door opening solutions

Prices Effective September 1, 2017

Copyright © 2017, Rockwood Manufacturing Company, an ASSA ABLOY Group company. All rights reserved. Reproduction in whole or in part without the express written permission of Rockwood Manufacturing Company is prohibited.

NOTE: Heavy Duty (HD) mounting features hex drive for positive tightening and large overall size for superior strength. Recommended for high frequency and rough service openings.

Free End  
Thru Bolt

**TYPE 1 - Thru Bolt Wood or Metal Door**

Labels: Pull, Finish Washer, Flat Head Machine Screw, Outside, Inside

| Type | Bolt Size | Drill Size | Price |
|------|-----------|------------|-------|
| 1    | 1/4"-20   | 9/32       | Incl. |
| 1HD  | 5/16"-18  | 11/32      | 5.00  |
| 1XHD | 3/8"-16   | 13/32      | 10.00 |

**TYPE 12 - Decorative Thru Bolt Wood or Metal Door**

Labels: Pull, Thru Bolt

| Type  | Bolt Size | Drill Size | Price |
|-------|-----------|------------|-------|
| 12    | 1/4"-20   | 9/32       | 24.00 |
| 12HD  | 5/16"-18  | 11/32      | 29.00 |
| 12XHD | 3/8"-16   | 13/32      | 29.00 |

**TYPE 15 - Decorative Thru Bolt Glass Door**

Labels: Plastic Washers, Pull, Thru Bolt, Neoprene Bushing 5/8" Dia. Hole

| Type  | Bolt Size | Drill Size | Price |
|-------|-----------|------------|-------|
| 15    | 1/4"-20   | 5/8        | 26.00 |
| 15HD  | 5/16"-18  | 5/8        | 31.00 |
| 15XHD | 3/8"-16   | 5/8        | 31.00 |

**TYPE 6 - Surface Concealed Metal Door**

Minimum diameter of pull is 5/8"

Labels: Cone Head Machine Screw, Pull, Set Screw, Reinforcement by others

For doors with rivnuts specify Type 6R

| Type | Bolt Size | Drill Size   | Price |
|------|-----------|--------------|-------|
| 6    | 1/4"-20   | 1/4"-20 Tap  | 10.00 |
| *6HD | 5/16"-18  | 5/16"-18 Tap | 14.00 |

**TYPE 6R - Surface Concealed Metal Door**

Minimum diameter of pull is 1"

Labels: Cone Head Machine Screw, Pull, Set Screw, Rivnut

| Type | Bolt Size | Drill Size | Price |
|------|-----------|------------|-------|
| 6    | 1/4"-20   | N/A        | 12.00 |
| *6HD | 5/16"-18  | N/A        | 17.00 |

**TYPE 8 - Surface Concealed Wood Door**

Labels: Cone Head Machine Screw, Pull, Knife Thread Insert, 1/4"-20 Set Screw

| Type | Bolt Size | Drill Size     | Price |
|------|-----------|----------------|-------|
| 8    | 1/4"-20   | 23/64-9/16 dp. | 10.00 |
| *8HD | 5/16"-18  | 7/16-9/16 dp.  | 14.00 |

Free End  
Concealed

**TYPE 17 - Surface Concealed Metal Door**

Minimum diameter of pull is 1"

Labels: Cone Head Machine Screw, Pull, Set Screws, Reinforcement by others

| Type | Bolt Size | Drill Size   | Price |
|------|-----------|--------------|-------|
| 17   | 1/4"-20   | 1/4"-20 Tap  | 14.00 |
| 17HD | 5/16"-18  | 5/16"-18 Tap | 18.00 |

**TYPE 17R - Surface Concealed Metal Door**

Minimum diameter of pull is 1"

Labels: Cone Head Machine Screw, Pull, Set Screws, Rivnut

| Type  | Bolt Size | Drill Size | Price |
|-------|-----------|------------|-------|
| 17R   | 1/4"-20   | N/A        | 16.00 |
| 17RHD | 5/16"-18  | N/A        | 20.00 |

\*HD mountings feature 2 set screws 180° apart.

**ASSA ABLOY**

The global leader in  
door opening solutions

NOTE: Y base plates are recommended on wood or glass doors to make a stable and durable mounting (see page 40 for details).  
NOTE: Heavy Duty (HD) mounting features hex drive for positive tightening and large overall size for superior strength.  
Recommended for high frequency and rough service openings.

**Flush Pull Mounting**

Type 10 Mounting applies to the 94 Series Flush Pulls

**TYPE 10 - Surface Mounted Wood or Metal Door**

| Type | Bolt Size | Drill Size | Price |
|------|-----------|------------|-------|
| 10   | #8-32     | 9/32       | 14.00 |

**Wire or Small Post Mount Pull Mounting**

NOTE: This mounting should only be used on pulls with mounting points that are 1/2" in diameter.

**TYPE 55 - Back-to-Back Wood or Metal Door**

| Type | Bolt Size | Drill Size | Price |
|------|-----------|------------|-------|
| 55   | #8-32     | 13/64      | 14.00 |

**Common End Back-to-Back**

**TYPE 5 - Back-to-Back Wood or Metal Door**  
Minimum diameter of pull is 5/8"

| Type | Bolt Size | Drill Size | Price |
|------|-----------|------------|-------|
| 5    | 1/4"-20   | 9/32       | 10.00 |
| 5HD  | 5/16"-18  | 11/32      | 14.00 |

**TYPE 9 - Back-to-Back w/Lug Plate Any Door Type**  
Minimum diameter of pull is 5/8"

| Type | Bolt Size | Drill Size | Price |
|------|-----------|------------|-------|
| 9    | 1/4"-20   | N/A        | 25.00 |

**TYPE 11XHD - Back-to-Back w/Spanner Collar - Wood or Metal Door**  
Minimum diameter of pull is 1"

| Type  | Bolt Size | Drill Size | Price |
|-------|-----------|------------|-------|
| 11XHD | 3/8"-16   | 13/32      | 29.00 |

**TYPE 13 - Back-to-Back Glass Door**

| Type  | Bolt Size | Drill Size | Price |
|-------|-----------|------------|-------|
| 13    | 1/4"-20   | 5/8        | 17.00 |
| *13HD | 5/16"-18  | 5/8        | 21.00 |

**TYPE 14XHD - Back-to-Back Glass Door**  
Minimum diameter of pull is 1"

| Type  | Bolt Size | Drill Size | Price |
|-------|-----------|------------|-------|
| 14XHD | 3/8"-16   | 5/8        | 31.00 |

**TYPE 16 - Back-to-Back Wood or Metal Door**  
1" diameter offset pulls only

| Type | Bolt Size | Drill Size | Price |
|------|-----------|------------|-------|
| 16   | 1/4"-20   | 9/32       | 14.00 |
| 16HD | 5/16"-18  | 11/32      | 18.00 |

**TYPE 18 - Back-to-Back Glass Door**

| Type | Bolt Size | Drill Size | Price |
|------|-----------|------------|-------|
| 18   | 1/4"-20   | 5/8        | 20.00 |
| 18HD | 5/16"-18  | 5/8        | 25.00 |

\*HD mountings feature 2 set screws 180° apart.

## Push and Pull Bar Mounting Details

### Sizing of Push Bars

#### Flush Doors

- Door width:
- minus 5" for bent end bars
  - minus 5" for square end post mount bars
  - minus 7" for round end post mount bars

#### Stile and Rail Doors or Doors with Lites

- Door width:
- minus width of one stile

CAUTION: Always confirm bars will not interfere with jamb or cause pinching hazard.

CAUTION: On narrow stile doors, be sure push bar base fits on the stile and bar does not interfere with the stop.

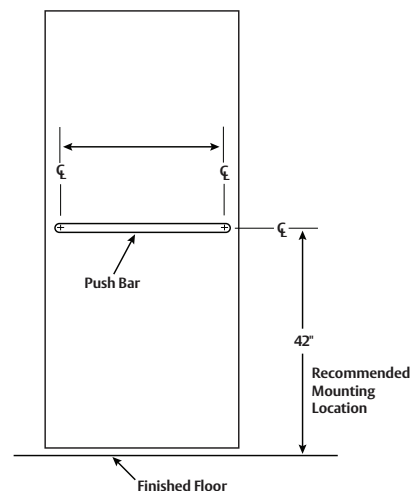

### Handing of Doors

The handing of a door is determined from the outside of the opening.

Standing outside the door:

- If the hinges are on the right, it is a right hand door.
- If the hinges are on the left, it is a left hand door.
- If the door opens away from you, it is a regular bevel door.
- If the door opens toward you, it is a reverse bevel door.

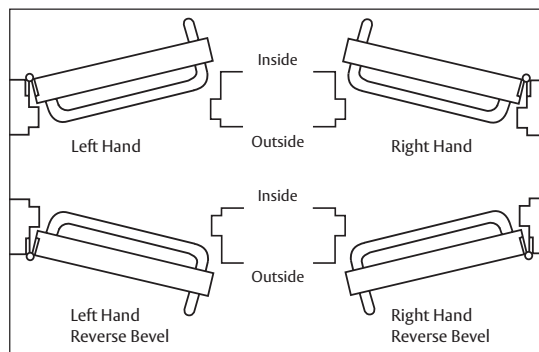

#### TYPICAL MOUNTING

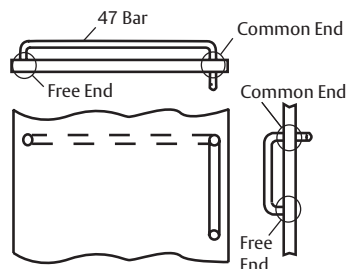



## Thru Bolt Mounting - For 1 3/4" Wood and Metal Doors

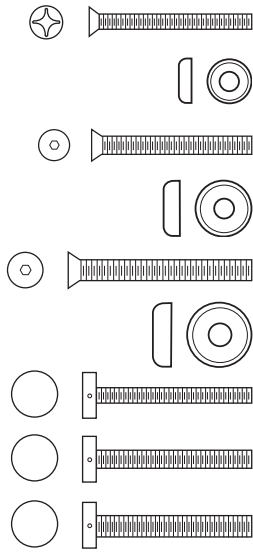

| Part   | Description  | Mounting Type | Price |
|--------|--|---------------|-------|
| SP1004 | 1/4"-20 x 2 1/4" Flat Head Machine Screw Thru Bolt         | 1             | 1.50  |
| SP1005 | 1/4"-20 Finishing Washer                                   | 1             | 0.90  |
| SP1053 | 5/16"-18 x 2 1/2" Socket Flat Head Machine Screw Thru Bolt | 1HD           | 3.20  |
| SP1054 | 5/16"-18 Finishing Washer                                  | 1HD           | 1.20  |
| SP1001 | 3/8"-16 x 2 1/2" Socket Flat Head Machine Screw Thru Bolt  | 1XHD          | 5.00  |
| SP1002 | 3/8"-16 Finishing Washer                                   | 1XHD          | 1.50  |
| SP1003 | 1" Diameter Decorative Thru Bolt<br>1/4"-20 x 2 1/4"       | 12            | 13.60 |
| SP1055 | 1" Diameter Decorative Thru Bolt<br>5/16"-18 x 2 1/4"      | 12HD          | 16.20 |
| SP1041 | 1 1/4" Diameter Decorative Thru Bolt<br>3/8"-16 x 2 1/4"   | 12XHD         | 16.20 |

## Back-to-Back Mounting - For 1 3/4" Wood and Metal Doors

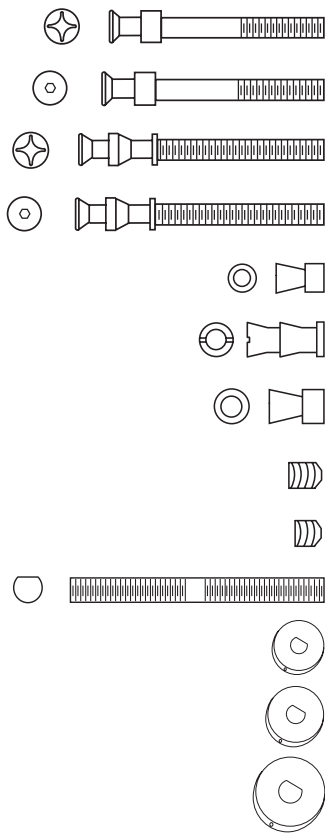

| Part   | Description   | Mounting Type | Price |
|--------|---|---------------|-------|
| SP1025 | 1/4"-20 x 2 1/4" Cone Head Machine Screw  | 5             | 3.50  |
| SP1056 | 5/16"-18 x 2 1/4" Cone Head Machine Screw   | 5HD           | 5.60  |
| SP1052 | 1/4"-20 x 2 1/4" Double Cone Head Machine Screw<br>(for use with offset pulls)      | 16            | 4.20  |
| SP1057 | 5/16"-18 x 2 1/4" Double Cone Head Machine Screw<br>(for use with offset pulls)     | 16HD          | 6.80  |
| SP1027 | 1/4"-20 Cone Head Union (Used to Convert Cone Head to Thru Bolt Hole)               | N/A           | 3.50  |
| SP1079 | 1/4"-20 Double Cone Head Union (Used to Convert Double Cone Head to Thru Bolt Hole) | N/A           | 6.20  |
| SP1068 | 5/16"-18 Cone Head Union (Used to Convert Cone Head to Thru Bolt Hole)              | N/A           | 5.60  |
| SP1026 | 1/4"-20 x 5/16" Set Screws (Standard)   | N/A           | 0.90  |
| SP1065 | 1/4"-20 x 3/16" Set Screw (Short)   | N/A           | 1.10  |
| SP1032 | 3/8"-16 x 2 7/8" LH/RH Bolt   | 11            | 7.40  |
| SP1071 | Spanner Collar 1" Diameter for LH/RH Bolt   | 11            | 11.10 |
| SP1033 | Spanner Collar 1 1/4" Diameter for LH/RH Bolt                                       | 11            | 11.10 |
| SP1072 | Spanner Collar 1 1/2" Diameter for LH/RH Bolt                                       | 11            | 12.40 |

**ASSA ABLOY**The global leader in  
door opening solutions

Prices Effective September 1, 2017

Copyright © 2017, Rockwood Manufacturing Company, an ASSA ABLOY Group company. All rights reserved.  
Reproduction in whole or in part without the express written permission of Rockwood Manufacturing Company is prohibited.

## Concealed Mounting - For 1 3/4" Wood and Metal Doors

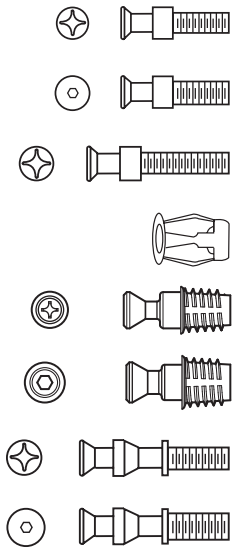

| Part   | Description   | Mounting Type | Price |
|--------|---|---------------|-------|
| SP1039 | 1/4"-20 x 1/2" Cone Head Machine Screw  | 6 / 6R        | 3.50  |
| SP1058 | 5/16"-18 x 1/2" Cone Head Machine Screw   | 6HD           | 5.60  |
| SP1021 | 1/4"-20 x 1 1/8" Cone Head Machine Screw; For Use with Jack Nut - Type 7 Mount  | 7             | 3.50  |
| SP1030 | 1/4"-20 Jack Nut Insert; Mounting Anchor for Concealed Mounting on Hollow Doors | 7             | 3.70  |
| SP1080 | 1/4"-20 Cone Head / Knife Thread Insert   | 8             | 5.90  |
| SP1082 | 5/16"-18 Cone Head / Knife Thread Insert  | 8HD           | 5.90  |
| SP1051 | 1/4"-20 x 1/2" Double Cone Head Machine Screw                                   | 17 / 17R      | 5.60  |
| SP1059 | 5/16"-18 x 1/2" Double Cone Head Machine Screw                                  | 17HD          | 6.80  |

## Bushings & Washers - For 1/2" Glass Doors

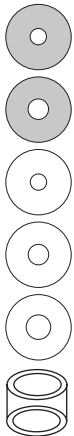

| Part   | Description   | Mounting Type  | Price |
|--------|---|----------------|-------|
| SP1022 | Stainless Steel Washer for 1/4"-20 Cone Head Machine Screw .032" Thick  | 13             | 1.50  |
| SP1060 | Stainless Steel Washer for 5/16"-18 Cone Head Machine Screw .060" Thick | 13HD           | 1.50  |
| SP1023 | Plastic Washer for 1/4"-20 Bolt; Specify Size                           | 13             | 1.30  |
| SP1061 | Plastic Washer for 5/16"-18 Bolt; Specify Size                          | 13HD           | 1.40  |
| SP1062 | Plastic Washer for 3/8"-16 Bolt; Specify Size                           | 14             | 1.40  |
| SP1024 | Glass Door Bushing for 5/8" Hole in Glass; Specify Size                 | 13 / 13HD / 14 | 1.50  |

## Thru Bolt Mounting - For 1/2" Glass Doors

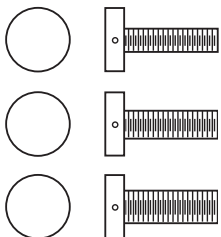

| Part   | Description  | Mounting Type | Price |
|--------|--|---------------|-------|
| SP1020 | 1" Diameter Decorative Thru Bolt; 1/4"-20 x 1 1/8"     | 15            | 13.60 |
| SP1063 | 1" Diameter Decorative Thru Bolt; 5/16"-18 x 1 1/8"    | 15HD          | 16.20 |
| SP1040 | 1 1/4" Diameter Decorative Thru Bolt; 3/8"-16 x 1 1/8" | 15XHD         | 16.20 |

Prices Effective September 1, 2017

Copyright © 2017, Rockwood Manufacturing Company, an ASSA ABLOY Group company. All rights reserved. Reproduction in whole or in part without the express written permission of Rockwood Manufacturing Company is prohibited.

**ASSA ABLOY**

The global leader in door opening solutions

## Back-to-Back Mounting - For 1/2" Glass Doors

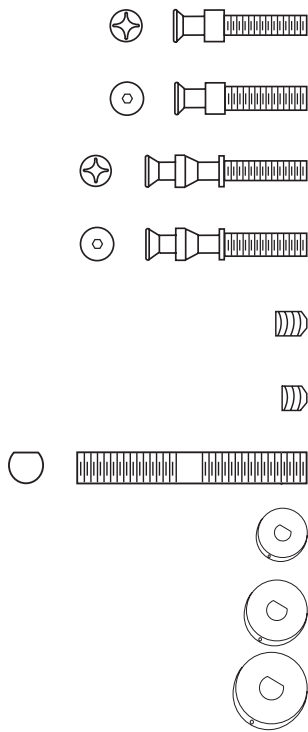

| Part   | Description                                      | Mounting Type | Price |
|--------|--|---------------|-------|
| SP1021 | 1/4"-20 x 1 1/8" Cone Head Machine Screw         | 13            | 3.50  |
| SP1064 | 5/16"-18 x 1 1/8" Cone Head Machine Screw        | 13HD          | 5.60  |
| SP1067 | 1/4"-20 x 1 1/8" Double Cone Head Machine Screw  | 18            | 5.60  |
| SP1066 | 5/16"-18 x 1 1/8" Double Cone Head Machine Screw | 18HD          | 6.80  |
| SP1026 | 1/4"-20 x 5/16" Set Screw (Standard)             | N/A           | 0.90  |
| SP1065 | 1/4"-20 x 3/16" Set Screw (Short)                | N/A           | 1.10  |
| SP1031 | 3/8"-16 x 1 3/4" LH/RH Bolt                      | 14            | 7.40  |
| SP1071 | Spanner Collar 1" Diameter for LH/RH Bolt        | 14            | 11.10 |
| SP1033 | Spanner Collar 1 1/4" Diameter for LH/RH Bolt    | 14            | 11.10 |
| SP1072 | Spanner Collar 1 1/2" Diameter for LH/RH Bolt    | 14            | 12.40 |

## Y Base Plates

Specify bolt hole size and finish. Standard pulls require two plates.

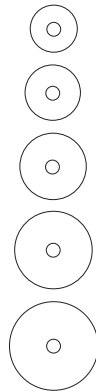

| Part   | Description                   | For Use With                | Price |
|--------|-------------------------------|-----------------------------|-------|
| SP1073 | 1/8" Thick x 1 1/16" Diameter | 3/4" Diameter Pulls         | 13.60 |
| SP1074 | 1/8" Thick x 1 1/4" Diameter  | 1" Diameter Pulls and Posts | 13.60 |
| SP1075 | 1/8" Thick x 1 1/2" Diameter  | 1" Diameter Pulls and Posts | 13.60 |
| SP1076 | 1/8" Thick x 1 3/4" Diameter  | 1" Diameter Pulls and Posts | 13.60 |
| SP1077 | 1/8" Thick x 2" Diameter      | 1" Diameter Pulls and Posts | 13.60 |

## Flush Pull Fasteners

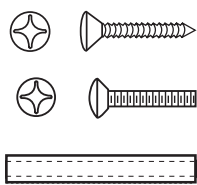

| Part   | Description                               | Door Type     | Price |
|--------|---|---------------|-------|
| SP1006 | #8 x 3/4" Oval Head Sheet Metal Screw     | Wood or Metal | 0.60  |
| SP1007 | #8-32 x 3/4" Oval Head Machine Screw      | Metal         | 0.60  |
| SP1034 | #8-32 x 1 5/8" Brass Sleeve Machine Screw | Wood or Metal | 3.70  |

**ASSA ABLOY**The global leader in  
door opening solutions

Prices Effective September 1, 2017

Copyright © 2017, Rockwood Manufacturing Company, an ASSA ABLOY Group company. All rights reserved.  
Reproduction in whole or in part without the express written permission of Rockwood Manufacturing Company is prohibited.

### Plate Fasteners

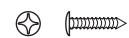

| Part   | Description   | For Use With                         | Price   |
|--------|---|--------------------------------------|---------|
| SP1008 | #6 x 5/8" Oval Head Sheet Metal Screw                             | Push and Pull Plates;<br>Kick Plates | 16.10/c |
| SP1009 | #6 x 3/4" Truss Head Sheet Metal Screw                            | Plastic / Laminate<br>Kick Plates    | 16.10/c |
| SP1050 | #6 x 5/8" Pan Head (TEK) Self-Drilling Screw -<br>Stainless Steel | Stainless Steel Kick Plates          | 40.30/c |
| SP1069 | #6 x 5/8" Pan Head (TEK) Self-Drilling Screw -<br>Brass Plated    | Brass Kick Plates                    | 74.60/c |

### Sex Nuts

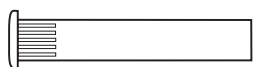
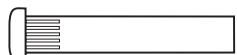
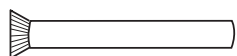

| Part   | Description               | For Use With                 | Price |
|--------|---------------------------|------------------------------|-------|
| SP1018 | #8-32 Flat Head Sex Nut   | <b>94</b> Series Flush Pulls | 4.70  |
| SP1019 | #10-24 x 1 9/16" Sex Nut  | <b>580</b> Surface Bolts     | 2.70  |
| SP1070 | 1/4"-20 x 1 9/16" Sex Nut | <b>585</b> Surface Bolts     | 6.40  |

### Tamperproof Torx® Head Security Fasteners

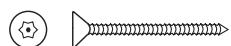
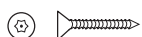

| Part    | Description   | For Use With  | Price |
|---------|---|---|-------|
| SP1016  | #6 x 1/2" Button Head Sheet Metal Screw                 | Kick Plates<br>(Stainless Steel)  | 0.80  |
| SP1016B | #6 x 1/2" Button Head Sheet Metal Screw<br>Brass Plated | Kick Plates<br>(Stainless Steel)  | 2.30  |
| SP1042  | #6 x 5/8" Oval Head Sheet Metal Screw                   | Push and Pull Plates<br>(Stainless Steel)                                   | 0.80  |
| SP1042B | #6 x 5/8" Oval Head Sheet Metal Screw<br>Brass Plated   | Push and Pull Plates<br>(Stainless Steel)                                   | 2.90  |
| SP1017  | #8 x 3/4" Flat Head Sheet Metal Screw                   | <b>94</b> Flush Pulls, <b>131</b> Door<br>Pulls, and <b>555</b> Flush Bolts | 1.90  |
| SP1035  | #8-32 x 3/4" Flat Head Machine Screw                    | <b>94</b> Flush Pulls, <b>131</b> Door<br>Pulls, and <b>555</b> Flush Bolts | 1.90  |
| SP1037  | #12 x 1 1/2" Flat Head Wood Screw                       | <b>440/442</b> Door Stops   | 2.30  |
| SP1038  | 1/4"-20 x 2 1/2" Flat Head Machine Screw                | Door Pulls Type 1 Mount   | 3.50  |

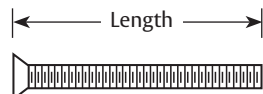

Standard Thru Bolt for Countersunk Holes

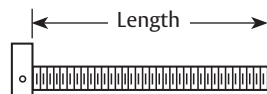

Decorative Thru Bolt for Wood or Metal Doors

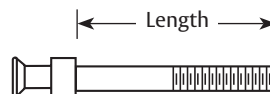

Cone Head Bolt for Back-to-Back Wood or Metal Doors

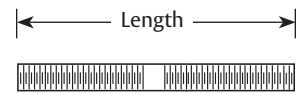

LH/RH Bolt without Heads

**Mounting Kits for Door Pulls**

| Part                 | Mounting Type | Description  | Price |
|----------------------|---------------|--|-------|
| <b>KIT1</b>          | 1             | 2 ea. 1/4"-20 x 2 1/4" Thru Bolts and 2 ea. Finish Washers; Specify Finish   | 4.10  |
| <b>KIT1HD</b>        | 1HD           | 2 ea. 5/16"-18 x 2 1/2" Thru Bolts and 2 ea. Finish Washers; Specify Finish  | 8.10  |
| <b>KIT1XHD</b>       | 1XHD          | 2 ea. 3/8"-16 x 2 1/2" Thru Bolts and 2 ea. Finish Washers; Specify Finish   | 11.90 |
| <b>KIT5</b>          | 5             | 2 ea. 1/4"-20 x 2 1/4" Cone Head Bolts and 2 ea. Set Screws  | 8.10  |
| <b>KIT5HD</b>        | 5HD           | 2 ea. 5/16"-18 x 2 1/4" Cone Head Bolts and 4 ea. Set Screws   | 12.10 |
| <b>KIT6</b>          | 6             | 2 ea. 1/4"-20 x 1 1/2" Cone Head Bolts and 2 ea. Set Screws  | 8.10  |
| <b>KIT6HD</b>        | 6HD           | 2 ea. 5/16"-18 x 1 1/2" Cone Head Bolts and 4 ea. Set Screws   | 12.10 |
| <b>KIT11</b>         | 11            | 2 ea. 3/8"-16 x 3 1/2" LH/RH Bolt and 2 ea. Spanner Collars for 1 3/4" Doors; Specify Pull Diameter and Finish   | 30.90 |
| <b>KIT12-1</b>       | 12            | 2 ea. 1/4"-20 x 2 1/4" Decorative Thru Bolts; 1" Dia.; Specify Finish  | 27.20 |
| <b>KIT12-1HD</b>     | 12HD          | 2 ea. 5/16"-18 x 2 1/4" Decorative Thru Bolts; 1" Dia.; Specify Finish   | 32.50 |
| <b>KIT12-1.25XHD</b> | 12XHD         | 2 ea. 3/8"-16 x 2 1/4" Decorative Thru Bolts; 1 1/4" Dia.; Specify Finish  | 35.50 |
| <b>KIT12-1.5XHD</b>  | 12XHD         | 2 ea. 3/8"-16 x 2 1/4" Decorative Thru Bolts; 1 1/2" Dia.; Specify Finish  | 41.30 |
| <b>KIT13</b>         | 13            | 2 ea. 1/4"-20 x 1 1/8" Cone Head Bolts; 2 ea. Metal Washers; 4 ea. Plastic Washers; 2 ea. Bushings for 1/2" Glass Doors; 2 ea. Set Screws; Specify if other than 1/2" Glass  | 15.00 |
| <b>KIT13HD</b>       | 13HD          | 2 ea. 5/16"-18 x 1 1/8" Cone Head Bolts; 2 ea. Metal Washers; 4 ea. Plastic Washers; 2 ea. Bushings for 1/2" Glass Doors; 4 ea. Set Screws; Specify if other than 1/2" Glass | 18.90 |
| <b>KIT14</b>         | 14            | 2 ea. 3/8"-16 x 2 1/4" LH/RH Bolt; 2 ea. Spanner Collars; 2 ea. Bushings; 4 ea. Washers for 1/2" Glass Doors; Specify Pull Diameter and Finish                               | 36.90 |
| <b>KIT15</b>         | 15            | 2 ea. 1/4"-20 x 1 1/8" Decorative Thru Bolts; 1" Dia.; 2 ea. Bushings; 4 ea. Plastic Washers; Specify Finish and Glass Thickness/Hole Size                                   | 32.50 |
| <b>KIT15HD</b>       | 15HD          | 2 ea. 5/16"-18 x 1 1/8" Decorative Thru Bolts; 1" Dia.; 2 ea. Bushings; 4 ea. Plastic Washers; Specify Finish and Glass Thickness/Hole Size                                  | 38.10 |
| <b>KIT15-1.25XHD</b> | 15XHD         | 2 ea. 3/8"-16 x 1 1/8" Decorative Thru Bolts; 1 1/4" Dia.; 2 ea. Bushings; 4 ea. Plastic Washers; Specify Finish and Glass Thickness/Hole Size                               | 41.30 |
| <b>KIT15-1.5XHD</b>  | 15XHD         | 2 ea. 3/8"-16 x 1 1/8" Decorative Thru Bolts; 1 1/2" Dia.; 2 ea. Bushings; 4 ea. Plastic Washers; Specify Finish and Glass Thickness/Hole Size                               | 47.30 |
| <b>KIT16</b>         | 16            | 2 ea. 1/4"-20 x 2 1/4" Double Cone Head Bolts and 4 ea. Set Screws   | 12.10 |
| <b>KIT16HD</b>       | 16HD          | 2 ea. 5/16"-18 x 2 1/4" Double Cone Head Bolts and 4 ea. Set Screws  | 15.00 |

| Part             | Mounting Type | Description   | Price |
|------------------|---------------|---|-------|
| <b>KIT17</b>     | 17            | 2 ea. 1/4"-20 x 1 1/2" Double Cone Head Bolts and 4 ea. Set Screws  | 12.10 |
| <b>KIT17HD</b>   | 17HD          | 2 ea. 5/16"-18 x 1 1/2" Double Cone Head Bolts and 4 ea. Set Screws   | 15.00 |
| <b>KIT18</b>     | 18            | 2 ea. 1/4"-20 x 1 1/8" Double Cone Head Bolts; 2 ea. Metal Washers; 4 ea. Plastic Washers; 2 ea. Bushings for 1/2" Glass Doors; Specify if other than 1/2" Glass and 4 ea. Set Screws                                     | 20.80 |
| <b>KIT18HD</b>   | 18HD          | 2 ea. 5/16"-18 x 1 1/8" Double Cone Head Bolts; 2 ea. Metal Washers; 4 ea. Plastic Washers; 2 ea. Bushings for 1/2" Glass Doors; Specify if other than 1/2" Glass and 4 ea. Set Screws                                    | 23.80 |
| <b>KIT-T1</b>    | T1            | 1 ea. 1/4"-20 X 2 1/4" Cone Head Bolt; 1 ea. 1/4"-20 Cone Head Union; 2 ea. Set Screws; 2 ea. 1/4"-20 x 2 1/4" — 1" Dia. Decorative Thru Bolts; Specify Finish  | 35.40 |
| <b>KIT-T2</b>    | T2            | 1 ea. 1/4"-20 X 1 1/8" Cone Head Bolt; 1 ea. 1/4"-20 Cone Head Union; 2 ea. Set Screws; 2 ea. 1/4"-20 x 1 1/8" — 1" Dia. Decorative Thru Bolts; 1 ea. Metal Washer; 6 ea. Plastic Washers; 3 ea. Bushings; Specify Finish | 44.10 |
| <b>KIT-T3</b>    | T3            | 1 ea. 1/4"-20 X 2 1/4" Cone Head Bolt; 1 ea. 1/4"-20 Cone Head Union; 2 ea. Set Screws; 2 ea. 1/4"-20 x 2 1/4" Thru Bolts; 2 ea. Finish Washers; Specify Finish   | 12.10 |
| <b>KIT-T4</b>    | T4            | 1 ea. 1/4"-20 X 2 1/4" Cone Head Bolt; 2 ea. 1/4"-20 x 1 1/2" Cone Head Bolts; 3 ea. Set Screws   | 12.10 |
| <b>KIT-T5</b>    | T5            | 1 ea. 1/4"-20 X 2 1/4" Cone Head Bolt; 2 ea. 1/4"-20 x 1 1/2" Cone Head Wood Screws; 3 ea. Set Screws   | 12.10 |
| <b>KITRM1.25</b> | 11x1XHD       | 2 ea. 3/8"-16 x 2 1/2" Thru-Bolts; 2 ea. Finish Washers; 1 ea. 3/8"-16 x 3 1/2" LH/RH Bolt; 1 ea. 1 1/4" Spanner Collar; Specify Finish   | 27.50 |
| <b>KITRM360</b>  | 11x 12XHD     | 2 ea. 3/8"-16 x 2 1/4" Decorative Thru Bolts 1 1/4" Dia.; 1 ea. 3/8"-16 x 3 1/2" LH/RH Bolt; 1 ea. 1 1/4" Spanner Collar; Specify Finish  | 50.90 |
| <b>KITRM360G</b> | 14x 15XHD     | 2 ea. 3/8"-16 x 2 1/4" Decorative Thru Bolts 1 1/4" Dia.; 1 ea. 3/8"-16 x 3 1/2" LH/RH Bolt; 1 ea. 1 1/4" Spanner Collar; 3 ea. Bushings; 6 ea. Plastic Washers; Specify Finish   | 59.80 |
| <b>KITRM1.5</b>  | 11x1XHD       | 2 ea. 3/8"-16 x 2 1/2" Thru Bolts; 2 ea. Finish Washers; 1 ea. 3/8"-16 x 3 1/2" LH/RH Bolt; 1 ea. 1 1/2" Spanner Collar; Specify Finish   | 30.30 |
| <b>KITRM380</b>  | 11x 12XHD     | 2 ea. 3/8"-16 x 2 1/4" Decorative Thru Bolts 1 1/2" Dia.; 1 ea. 3/8"-16 x 3 1/2" LH/RH Bolt; 1 ea. 1 1/2" Spanner Collar; Specify Finish  | 59.80 |
| <b>KITRM380G</b> | 14x 15XHD     | 2 ea. 3/8"-16 x 2 1/4" Decorative Thru Bolts 1 1/2" Dia.; 1 ea. 3/8"-16 x 3 1/2" LH/RH Bolt; 1 ea. 1 1/2" Spanner Collar; 3 ea. Bushings; 6 ea. Plastic Washers; Specify Finish   | 68.50 |

**ASSA ABLOY**

The global leader in door opening solutions

Prices Effective September 1, 2017

Copyright © 2017, Rockwood Manufacturing Company, an ASSA ABLOY Group company. All rights reserved. Reproduction in whole or in part without the express written permission of Rockwood Manufacturing Company is prohibited.



ASSA ABLOY is the global leader in door opening solutions, dedicated to satisfying end-user needs for security, safety and convenience

**ASSA ABLOY**



300 Main Street  
Rockwood, Pennsylvania 15557  
P: 800-458-2424 • F: 800-922-9212  
[www.rockwoodmfg.com](http://www.rockwoodmfg.com) • [orders.rockwood@assaabloy.com](mailto:orders.rockwood@assaabloy.com)

(In Canada)  
Door Security Solutions Canada  
160 Four Valley Drive  
Vaughan, ON L4K 4T9  
P: 800-461-3007  
[www.assaabloy.ca](http://www.assaabloy.ca)