

STEELCRAFT®

Price book 4

Effective August 12, 2017 • Rev 8/17



This price list supersedes and cancels all previous price lists. Prices shown are subject to change without notice.

Administrative Offices

Allegion Administrative Office
11819 N. Pennsylvania St.
Carmel, IN 46032
allegion.com/us

Placing orders

You can place orders with Allegion via the fax number or email listed below:

Blue Ash Purchase Orders
Fax#: 1-800-356-7178
Email: Steelcraft_Order_Entry@allegion.com

West Coast Service Center Purchase Orders
Fax#: 1-888-485-4747
Email: SteelcraftOrderEntryChino@allegion.com

List Price Estimating

Blue Ash and West Coast Service Center
Email: Steelcraftestimating@allegion.com

Customer Care

Our Customer Care Representatives are available for questions or assistance.

You can reach them at **877-671-7011** (Press 1 for Sales Support | Press 2 for Product Support | Press 3 for SSC) or through the email addresses listed below:

Sales Support

<p>Carolinas <i>(North Carolina, South Carolina, Virginia)</i> Carolinas_Sales_Support@allegion.com</p> <p>Central <i>(Arkansas, Illinois, Iowa, Kansas, Missouri, Nebraska, Oklahoma)</i> Central_Sales_Support@allegion.com</p> <p>Chicago <i>(Illinois-Northern, Wisconsin)</i> Chicago_Sales_Support@allegion.com</p> <p>Florida Florida_Sales_Support@allegion.com</p> <p>Great Lakes <i>(New York, Pennsylvania)</i> Great_Lakes_Sales_Support@allegion.com</p> <p>Metro New York Metro_New_York_Sales_Support@allegion.com</p>	<p>Michigan Michigan_Sales_Support@allegion.com</p> <p>Mid Atlantic <i>(Delaware, Maryland, New Jersey)</i> Mid_Atlantic_Sales_Support@allegion.com</p> <p>Midwest <i>(Indiana, Kentucky, Ohio, West Virginia)</i> Midwest_Sales_Support@allegion.com</p> <p>Mountain States <i>(Colorado, Idaho, Montana, Nevada, Utah, Wyoming)</i> Mountain_States_Sales_Support@allegion.com</p> <p>New England <i>(Connecticut, Main, Massachusetts, New Hampshire, Rhode Island, Vermont)</i> New_England_Sales_Support@allegion.com</p> <p>North Central <i>(Minnesota, North Dakota, South Dakota)</i> North_Central_Sales_Support@allegion.com</p>	<p>Northern California Northern_California_Sales_Support@allegion.com</p> <p>Northwest <i>(Alaska, Oregon, Washington)</i> Northwest_Sales_Support@allegion.com</p> <p>South <i>(Alabama, Georgia, Louisiana, Mississippi, Tennessee)</i> South_Sales_Support@allegion.com</p> <p>Southern California <i>(California-Southern, Hawaii)</i> Southern_California_Sales_Support@allegion.com</p> <p>Southwest <i>(Arizona, New Mexico)</i> Southwest_Sales_Support@allegion.com</p> <p>Texas Texas_Sales_Support@allegion.com</p>
---	---	--

Technical Product Support

Doors and Frames
Doors_Frames_TechProdSupport@allegion.com

Request for Quote

<p>Carolinas <i>(North Carolina, South Carolina, Virginia)</i> Carolinas.Quotes@allegion.com</p> <p>Central <i>(Arkansas, Illinois, Iowa, Kansas, Missouri, Nebraska, Oklahoma)</i> Central.Quotes@allegion.com</p> <p>Chicago <i>(Illinois-Northern, Wisconsin)</i> Chicago.Quotes@allegion.com</p> <p>Florida Florida.Quotes@allegion.com</p> <p>Great Lakes <i>(New York, Pennsylvania)</i> GreatLakes.Quotes@allegion.com</p> <p>Metro New York Metro.Quotes@allegion.com</p>	<p>Michigan Michigan.Quotes@allegion.com</p> <p>Mid Atlantic <i>(Delaware, Maryland, New Jersey)</i> MidAtlantic.Quotes@allegion.com</p> <p>Midwest <i>(Indiana, Kentucky, Ohio, West Virginia)</i> Midwest.Quotes@allegion.com</p> <p>Mountain States <i>(Colorado, Idaho, Montana, Nevada, Utah, Wyoming)</i> Mtn.States.Quotes@allegion.com</p> <p>New England <i>(Connecticut, Main, Massachusetts, New Hampshire, Rhode Island, Vermont)</i> NewEngland.Quotes@allegion.com</p> <p>North Central <i>(Minnesota, North Dakota, South Dakota)</i> NorthCentral.Quotes@allegion.com</p>	<p>Northern California NoCal.Quotes@allegion.com</p> <p>Northwest <i>(Alaska, Oregon, Washington)</i> Northwest.Quotes@allegion.com</p> <p>South <i>(Alabama, Georgia, Louisiana, Mississippi, Tennessee)</i> South.Quotes@allegion.com</p> <p>Southern California <i>(California-Southern, Hawaii)</i> SoCal.Quotes@allegion.com</p> <p>Southwest <i>(Arizona, New Mexico)</i> Southwest.Quotes@allegion.com</p> <p>Texas Texas.Quotes@allegion.com</p>
---	---	--

TABLE OF CONTENTS

TERMS AND CONDITIONS

Terms and Conditions 4
 Warranty..... 8

ORDERING INFORMATION 9

PROGRAMS

Blue Ash10
 West Coast Service Center10

RAPID FRAME OPTIONS 11

RAPID DOOR OPTIONS 12

FRAMES

Frame Product Information15
 Flush Frames16
 Drywall (Slip-On Frames) 28
 Custom Frame Construction Options 32
 Stainless Steel Frames 35
 Thermal Break Frames 36

DOORS

Door Product Information 43
 Full Flush Doors 44
 Embossed Panel Doors 52
 Full Glass Entrance Doors 54
 Storm Resistant Doors 56
 Integrated Door System 62
 Glass Lights 64
 Custom Door Options 66
 Stainless Steel Doors 68
 Falcon Doors 69

HARDWARE PREPS

Coordinators 73
 Closers 73
 Flushbolts 73
 Rescue Hardware 73
 Hinges 74
 Holders and Stops 74
 Locks and Strikes 75
 Pivots 76
 Push/Pulls 76

STICKS

Lineal Inch Stick Pricing 78
 Stick Lengths (TSF Parts) 83
 Transom Frames Without Transom Bars 90
 Borrowed Light Frames 93
 Laminated Transom Panels 97

PARTS

Frame Parts 100
 Door Parts 110

STOCK (BLUE ASH)

Frame Components 120
 Welded 3 Sided Frames 122
 Stick Lengths 123
 Frame Kwik-Paks 124
 Door (Units & Kwik Paks) 125

WEST COAST SERVICE CENTER

Modified Stock 127
 Frame Components 129
 Doors (Units) 130

Prices subject to change without notice.

Terms and Conditions

Allegion General Terms and Conditions of Sale and Service

1. GENERAL/ACCEPTANCE. (a) This Agreement contains the only terms and conditions by which Company will quote and sell Deliverables to Customer; (b) The terms "purchase order" or "order" for the purposes of this Agreement include the term "request for quotation," as appropriate; (c) This Agreement supersedes all pre-printed or boilerplate terms and conditions set forth in any purchase order issued by Customer; (d) No reference herein to Customer's purchase order will in any way incorporate different or additional terms and conditions, all of which Company hereby expressly objects to; (e) **ANY ACCEPTANCE BY COMPANY OF CUSTOMER'S PURCHASE ORDER IS EXPRESSLY CONDITIONED ON THE CUSTOMER'S ASSENT TO AND ACCEPTANCE OF THE TERMS AND CONDITIONS CONTAINED IN THIS AGREEMENT;** (f) Company reserves the right to decline any order, in whole or in part, for any reason.

2. ORDERS.

a. **Order Processing.** When Customer wishes to place an order for Deliverables, it will deliver to Company a purchase order. All such purchase orders must (i) be in a written format acceptable to Company, (ii) be legible, (iii) include a purchase order number, (iv) include Customer's account number, invoice address, ship to address, shipping method, shipper's letter of instruction for international shipments, part number, pricing, and designated contact information, (v) include, if applicable, any special configuration ID numbers, necessary programming information, special factory instructions, and requested specifications regarding a particular finish, handling, design, backset, or strike, and (vi) reference any applicable pricing discounts under an ongoing buying program or based on a written quote from Company, along with the applicable buying program number or quotation number.

b. **Minimum Orders.** In the event the order value does not meet any required minimum net Deliverable value, Company may, at its sole discretion, (i) increase the quantity of items in the order to meet the minimum net Deliverable value requirement; (ii) apply a minimum order charge; (iii) reject the order, or (iv) waive the requirement, provided that the waiver of a requirement for one order shall not constitute a waiver of the requirement for any future orders.

c. **Acceptance of Purchase Orders.** Company will endeavor to (i) acknowledge receipt of each purchase order issued in accordance with this Agreement, and (ii) notify Customer whether Company accepts or rejects the purchase order. If Company fails to accept or reject a purchase order within a reasonable time period, such failure to respond will be deemed a rejection of the entire order.

d. **Changes to Order/ Cancellation of Orders.** Additional terms and conditions regarding order changes and cancellations are available on the Allegion customer website, **WHICH TERMS ARE EXPRESSLY INCORPORATED HEREIN BY REFERENCE.** Unless otherwise provided herein, Customer acknowledges that (i) requesting a Change Order may cause a delay in the scheduled shipment date, a longer lead time or result in a new scheduled shipment date; (ii) Orders may not be changed after 48 hours of Company's order acknowledgment; (iii) After 48 hours of Company's order acknowledgment, all changes to an accepted purchase order will be subject to a Change Order charge of 25% of the net Deliverable value, plus the cost of labor and fabrication or raw material that Company incurred prior to the receipt of the Change Order from Customer, or that may be required due to the Change Order; (iv) the requested change may result in additional charges for labor, fabrication, and raw material, and (v) if Customer cancels an order or portion of an order that includes Deliverables that have been manufactured and prepped for shipping, a 45% restocking fee will apply. Notwithstanding the foregoing, Customer cannot change or cancel credential orders, reader orders, biometrics orders or any non-cataloged, special, Custom or nonstandard items once they have been placed. All cancelled orders for a Non Recurring Expense (NRE), credential orders, reader orders, biometrics orders, and/or Custom orders will be subject to a cancellation charge of 100% of the acknowledged price.

e. **Add-ons.** Add-on orders will not be accepted. Additions to orders will be entered as separate stand-alone orders and must qualify for all terms of sale, including discounts, on an individual basis.

f. **Fast-Track Orders.** No changes or cancellations will be accepted on the 24-Hour Fast Track Program. For 3-day Fast Track orders, changes and cancellations may only be requested by Customer within 24 hours of Company's order acknowledgment if the order has not shipped. For 5-Day Fast Track orders, changes and cancellations may only be requested by Customer if the order has not shipped and if the request is made to Company within 48 hours of Company's order acknowledgment. Return Material Authorization (RMA) for Deliverables must be processed through Fast Track Customer Service.

g. **Steelcraft Orders.** For all Steelcraft Standard orders, changes or cancellations are allowed without penalty only if made within 48 hours of Company's order acknowledgment, and provided that the order has not shipped. Some exceptions do apply – please consult the factory. Changes are not allowed on Rapid Program or Express Program orders after the order has been entered and acknowledged. After 48 hours of Company's order acknowledgment for Standard orders and all Rapid and Express orders, all changes or cancellations are subject to a charge of 40% of the order. Unless otherwise specified by Company in writing, any changes to orders acknowledged by Company that affect the delivery date will be deemed a new order and will require acknowledgement by Company as provided in this Section. Additional products, features, terms and conditions regarding the Rapid Program are available on the Allegion customer website, **WHICH TERMS ARE EXPRESSLY INCORPORATED HEREIN BY REFERENCE.**

3. PRICES, INVOICES AND PAYMENT.

a. **Prices.** The prices in Company's Price Book are subject to change at any time, without notice to Customer. Company may charge Customer additional amounts if Customer requests special packing, marking, shipment, product modification, or engineering services. Oral prices specified by Company are null and void. Quote numbers must be referenced on Customer's purchase order in order for the Company's quoted pricing to apply. Orders that do not reference a quote number will receive buy program pricing or book net pricing. Quoted prices are for those specific products quoted for a specified job, and are subject to the Price Book in effect at the time the quote was issued by Company.

b. **Taxes.** Prices do not include any present or future federal, state or local property, license, privilege, sales, use, excise, gross receipts or other like taxes or assessments which may result from transactions or any services performed in connection therewith. Any taxes, charges, or duties imposed by any governmental authority on the sale of Deliverables will be paid by Customer, in addition to the selling price specified by Company.

c. **Payment Terms.** Company will deliver to Customer an invoice with each shipment of Deliverables hereunder. Customer will pay all invoiced amounts within 35 days of the invoice date, provided that Customer may take a 2% discount if Customer pays in cash and Company receives said payment within 20 days of the invoice date. For the avoidance of doubt, cash discounts do not apply to credit card payments. Customer will make all payments in United States dollars. Past due invoices will be subject to a late payment service charge of 1.5% per month on any overdue unpaid balance, equivalent to 18% per annum, or the maximum

rate permitted by law, whichever is less. Customer shall reimburse Company for all costs of collection, including, without limitation, reasonable attorneys' fees, for any overdue amount owed by Customer to Company, and such collection costs shall also be subject to interest charges.

4. QUOTATIONS.

a. **Project Quotations.** Project or new construction quotes are restricted to the specific project quoted for the quantities, finishes, and series of Deliverables referenced on the quote. Company reserves the right to require proof of sale of Company products for any quoted project.

b. **Stock Quotations.** Deliverables fulfilling stock quotations may only be used for the following: i) Stocking of the Customer's shelves for small, quick-turn, discretionary projects, or ii) Sale to a general contractor or installer for new construction. Stock quotations may not be used for any project containing any Company no-substitution, specified products. Deliverables purchased under Stock Quotations cannot be redistributed to other Customer branch locations or re-sold to other resellers or used for aftermarket sales, end-user annual contracts or sold over the counter to any walk in trade.

c. **General.** All quotes are subject to this Agreement, unless otherwise specified by Company, and are subject to change at any time prior to Company's acceptance of a purchase order referencing the applicable quote number. Company, its representatives and employees reserve the right, in their sole discretion and for any reason, to refuse a Customer's request to quote a price other than the standard list price, regardless of whether Company or its representatives or employees have previously quoted discounted prices to the Customer on some or all of its orders. Customer's failure to comply with this Section 4 will be considered a material breach of this Agreement, and will entitle Company to immediately terminate any purchase orders and/or Customer's ability to distribute Company's products.

5. SECURITY INTEREST. Customer grants Company, and Company retains, a purchase money security interest and lien on any and all of Customer's rights, title and interest in each Deliverable sold by Company to Customer, wherever located, until the invoice for the applicable Deliverable(s) is paid in full, including any late charges and costs of collection. Customer authorizes Company to, and will assist Company in, taking all necessary steps to perfect and maintain Company's interest in such Deliverables.

6. CREDIT TERMS. Unless Customer pre-pays all of its purchase orders in advance, its purchase orders will be subject to the credit limit and other terms of credit ("Credit Terms") set forth in Company's credit application, which Credit Terms Customer acknowledges are subject to change by Company at any time. Company reserves the right to request payment in advance of shipment or any order or to request adequate assurances for Customer's payment of an order and may withhold or stop shipment, without any liability to Company, until Customer submits payment or adequate assurance of payment.

7. RESALE OF DELIVERABLES. Customer agrees and warrants that it will offer Company products in support of Company-written specifications and will maintain sufficient inventory to adequately support End Users, installers, and/or general contractors' needs. Company may implement an MSRP or a resale pricing programs at any time in its sole discretion. Failure to comply with such program(s) will be considered a material breach of this Agreement, and will entitle Company to immediately terminate any purchase order and/or Customer's ability to distribute Company's products. Customer shall, at its own expense, gain and maintain sufficient knowledge of the industry and products competitive with Deliverables so as to be able to (a) explain in detail to End Users, installers, and/or general contractors the differences between the Deliverables and competing products, (b) ensure that an adequate number of trained, capable and qualified technical personnel with sufficient knowledge of the Deliverables and who have obtained all necessary licenses and permits are available to assist End Users, installers, and/or general contractors, and (c) respond to such End Users, installers, and/or general contractors with respect to the general operation and use of the Deliverables including, but not limited to, (1) acting as a liaison between the End Users, installers and/or general contractors and Company in matters requiring Company participation, (2) providing general product information and configuration support on standard protocols and features, (3) collecting relevant technical problem identification information, and (4) posting and distributing any warranty information concerning the Products in accordance with Company's instructions. Customer is responsible for all service and support resulting from the re-sale of any Deliverable to End-Users, installers and/or general contractors, examples of which may include, but are not limited to, support activities such as installation, initialization, software set-up, training, trouble-shooting, technical support and field service. In the event Customer is unwilling or unable to perform said support activities, Company reserves the right to recover from Customer any and all expenses incurred by Company to resolve the aforementioned End-User, installer and/or general contractor issues. Technical product training is recommended for Customer in order to fully service and support Deliverables purchased from Company that are resold to End-Users, installers and/or general contractors.

8. DEFAULT. If Customer is in default of payment or otherwise with respect to any purchase order or other contract with Company, Company shall have the right, in addition to all other legal remedies and without prejudice to any of its right hereunder, to defer further shipments under that or any other purchase order until such default is corrected and to declare all outstanding bills of Customer to be immediately due and payable.

9. INSPECTION AND DELIVERY.

a. **Inspection.** Customer will inspect all Deliverables immediately after receiving them. Customer will be deemed to have accepted the Deliverables unless Customer notifies Company in writing of any nonconformance within 10 days of delivery and provides Company written evidence reasonably documenting that nonconformance. Inspection of Deliverables at Company's facility is not permitted.

b. **Delivery.** Delivery schedules for Deliverables are based upon current production capacities, material or component availability, and inventory, and may be changed by Company as conditions require. Delivery schedules for services are based upon Company's prompt receipt of, and prompt access to, Customer's equipment and all information necessary to complete the services. In no event will any delivery date be construed as falling within the meaning of "time is of the essence." Partial delivery shall be accepted by Customer and paid for at the price and on the terms stated herein. Any partial delivery shall constitute a separate sale, and payment shall be separately made when due. If any part of a delivery hereunder is not delivered by Company in accordance with Customer's purchase order, this Agreement shall not be affected thereby.

10. TITLE & RISK OF LOSS. Unless otherwise specified by Company, (i) where the Customer is located in the United States, all Deliverables will be sold "Uniform Commercial Code, FOB

Origin, Company's factory"; and (ii) where the Customer is located outside of the United States, all Products will be sold "Ex-works, Company's factory (Incoterms 2010)." In either instance, title and risk of loss will pass to Customer upon delivery to the carrier at Company's factory, provided, however, as set forth herein, Company shall retain a security interest in the Deliverables until full payment has been made therefore, and Customer agrees, upon request, to do all things and acts necessary to protect Company's interest by adequately insuring the Deliverables against loss or damage from any cause and to have Company named as an additional insured. Customer will promptly provide Company with a copy of the relevant certificate of insurance upon Company's request.

11. SHIPPING.

a. **Freight Charges.** Company will ship all Deliverables in accordance with Company's freight shipment guidelines, which are set forth on the My Allegion Portal ("Freight Shipping Guidelines"), **WHICH TERMS ARE EXPRESSLY INCORPORATED HEREIN.**

b. **Rush Charges.** Expedited order options are available as set forth in Company's freight shipping guidelines.

c. **Packing and Marking.** Company will pack, mark, and ship Deliverables according to its standard procedures for shipment, unless the parties agree, in writing, that Company will comply with any special instructions provided by Customer. Special instructions may result in an increased price.

d. **International Shipments.** For all international orders, a Shipper's letter of instruction must be submitted in writing with the order. Failure to do so will result in the order being rejected. Complete adherence to this order requirement will be strictly enforced. Company will not be held liable for any charges resulting from delays due to lack of complete required information being supplied.

e. Once received by the Company, a Customer purchase order can only be combined with any other order or combined with Company brands (to qualify for freight allowances) in accordance with the Company's freight shipment guidelines, which are set forth on the My Allegion Portal ("Freight Shipping Guidelines").

12. CLAIMS. All claims must be submitted in writing to Company as follows: (i) All claims for prices must be submitted within thirty (30) days from the date of invoice; (ii) All claims regarding Deliverable quantity or incorrect orders must be submitted within ten (10) days from the date of delivery; (iii) All claims for damage to Deliverables (while in the care, custody, and control of Company) must be submitted within thirty (30) days from the date of invoice; (iv) All claims for loss or damage to Deliverables while in the care, custody, and/or control of a carrier will be the responsibility of Customer, unless otherwise agreed by the parties.

13. PRODUCT CHANGES. Company's product policy is one of ongoing update and revision, and accordingly, Company reserves the right to change, without notice, the design of, or the process of manufacturing, the Deliverables covered by this Agreement.

14. PRODUCT USAGE LIMITATION. Customer agrees: (i) not to sell or use a Deliverable in any manner contrary to the manner in which the Deliverable is intended to be used; and/or (ii) not to modify the design of any Deliverable for use with another product without the prior written consent of Company.

15. PRODUCT RETURNS. Unless otherwise agreed by the parties in writing, Deliverables that are correctly furnished by Company per the purchase order may not be returned unless Customer receives written authorization from Company. If returns are authorized by Company, a return merchandise authorization ("RMA") number must be provided by Company. Deliverables identified under such RMA must be returned to Company within 90 days of issuance of the RMA. Such RMA number and any accompanying RMA documents, the original invoice number, and a written explanation for the return must be included with the returned Deliverables in order for Company to inspect and approve a credit for the return. **For warranty returns,** a credit in the amount of the original purchase price will only be issued if, after Company's receipt and inspection of the returned Deliverables, Company confirms, in its sole discretion, the defect is valid and approves the return. **For non-warranty returns/convenience returns,** in the event Company approves such a return, in its sole discretion, the following shall apply: (a) the total amount of Deliverables requested to be returned shall be a minimum of \$250.00; (b) a credit will be made to Customer's account in the amount of the original purchase price less freight and a handling charge of 45% of the net material on the original invoice; and (c) only Deliverables that are new, current, standard, non-obsolete, non-specially manufactured, unused, in their original condition as at the time of sale by Company to Customer, in their original packaging and in Customer's inventory less than 180 days from the date of shipment by the Company, and not ordered as part of a master key solution may be considered by Company for return. Such credit will only be issued if, after Company's receipt and inspection of Deliverables, Company approves the return. The amount of final credit will be determined upon receipt at the factory and following Company's inspection and analysis of the condition of the returned material. Company retains the right to deny credit to anyone for any reason.

16. CONFIDENTIAL INFORMATION.

a. **Non-Use And Non-Disclosure.** Customer shall not use the Confidential Information of the Company except for the purpose of performing its obligations under this Agreement or exercising the rights granted herein (the "Purpose"). Customer shall protect Confidential Information of the Company from disclosure and unauthorized use in the same manner that it protects its own Confidential Information, but in no event shall such standard of care be less than reasonable care. Customer may disclose Confidential Information of the Company only to its employees who require such information for the Purpose and who are subject to confidentiality obligations at least as protective as those set forth herein.

b. **Proprietary Information and Advice.** (a) All designs, data, and specifications provided by Company are proprietary and may not be disclosed or reused by Customer without the prior written consent of Company; (b) Company assumes no obligation or liability for any advice given by Company, the results obtained, or damages incurred as a result of such advice, and all such advice is given and accepted at Customer's risk.

c. **Return.** Upon the termination or expiration of a purchase order or this Agreement or upon the request of the Company, the Customer agrees to end all further use of, to immediately return to the Company the original version of, and to delete or destroy all copies of, any and all Confidential Information of the Company.

17. TRADEMARKS. Except as agreed to by Company in writing, Customer agrees not to (a) use Company's name in any form of publicity; or (b) use, create, register or market, directly or indirectly, in whole or in part, Company's names, logos, brands, or any other trademarks, or names that are now or may hereafter be owned by Company, as part of Customer's corporate or business name, as part of an internet domain name, uniform

resource locator (URL), or in any way connected with Customer's business, trade address or other designations. Upon termination of this Agreement or upon the request of company for any reason, any use of Company's trademarks or names will be immediately discontinued.

18. LIMITED WARRANTY.

COMPANY MAKES NO OTHER WARRANTIES EXCEPT THOSE STATED IN COMPANY'S LIMITED WARRANTY IN EFFECT ON THE DATE COMPANY ACCEPTS EACH APPLICABLE PURCHASE ORDER ("LIMITED WARRANTY"). THE LIMITED WARRANTY MAY BE FOUND IN THE APPLICABLE PRICE BOOK AND ON THE ALLEGION CUSTOMER WEBSITE, WHICH TERMS ARE EXPRESSLY INCORPORATED HEREIN BY REFERENCE. COMPANY WILL MAIL CUSTOMER A HARD COPY OF THIS WARRANTY UPON CUSTOMER'S WRITTEN REQUEST. IN THE EVENT THAT CERTAIN DELIVERABLE WARRANTIES ARE NOT FURNISHED BY THE COMPANY TO CUSTOMER, COMPANY WARRANTS ONLY TO CUSTOMER THAT THE DELIVERABLES WILL BE FREE FROM DEFECTS IN MATERIAL AND WORKMANSHIP FOR A PERIOD OF 12 MONTHS FROM THE DATE OF SHIPMENT OF THE DELIVERABLES. COMPANY'S SOLE OBLIGATION UNDER THIS WARRANTY IS LIMITED TO REPAIRING OR REPLACING, AT COMPANY'S OPTION, THE DEFECTIVE DELIVERABLE, PROVIDED WRITTEN NOTICE OF THE DEFECT OR NONCONFORMANCE IS PROVIDED BY CUSTOMER WITHIN 30 DAYS OF DISCOVERY OF THE DEFECT OR NONCONFORMANCE. COMPANY DISCLAIMS ALL OTHER WARRANTIES, EXPRESS OR IMPLIED, WITH RESPECT TO THE DELIVERABLES, INCLUDING BUT NOT LIMITED TO, ANY IMPLIED WARRANTIES OF NON-INFRINGEMENT, MERCHANTABILITY, OR FITNESS FOR A PARTICULAR PURPOSE.

a. **Exclusions.** The provisions of this Limited Warranty do not apply to Deliverables that: (A) are not the proper size for the application; (B) are not installed in accordance with Company's published installation instructions; (C) are installed with improper or incorrect parts and/or are used for purposes for which they are not designed or intended; (D) have been repaired or altered without the Company's prior written consent; (E) have been subjected to misuse, abuse, negligence or accident; (F) have been improperly stored, installed, maintained or operated; (G) have been used in violation of written instructions provided by Company to Customer; (H) have been subjected to improper temperature, humidity, or other environmental conditions, or (I) have been affected by normal wear and tear. In addition, the provisions of this Limited Warranty do not apply to any defects or issues with the design or performance of equipment or products not manufactured by Company, nor does it apply to any code compliance or permit requirements for the assembly, installation, erection or construction of any goods. Company is not responsible for loss or damage resulting from use of Deliverables in conjunction with parts or systems not manufactured by Company. Accessories or products furnished by the Company, but manufactured by others, shall carry whatever warranty the manufacturers have conveyed to the Company and which can be passed to Customer.

b. **Services.** Company warrants that its services will be free from defects in material and workmanship for a period of 12 months from the date of completion of the particular items of service. Company's sole obligation under this service warranty is limited to repair or reperformance, at its option of the service, provided however, if repair or reperformance is either impractical or impossible, the Company will refund to Customer that portion of the price paid to Company for any defective service, provided written notice of the defect or nonconformance is provided by Customer within 30 days of discovery of the nonconformance.

c. **Notification.** Customer agrees to immediately notify Company in writing if any claim is made against Customer for any damages caused by any modules, parts, products, service or other Deliverables which may be the direct result of any defect in the manufacture of such aforementioned products. Customer agrees to cooperate with Company and its counsel in the defense of such claim and Customer agrees not to settle such claim without Company's written consent. If Customer fails to notify Company of such claim or fails to cooperate in such defense as aforesaid, then Company shall be discharged from any obligations under this Section and shall have no further liability to Customer.

d. **Exceptions.** The following costs and expenses are not covered by the provisions of these limited warranties: (i) labor costs for the removal and reinstallation of Deliverables or other manufacturer's products; (ii) shipping and freight expenses required to return Deliverables to Company; (iii) normal maintenance; and (iv) economic losses. In addition, the provisions of this warranty are not applicable to anything other than defects in Company's material (products only) or workmanship.

19. LIMITATION OF REMEDIES.

CUSTOMER'S EXCLUSIVE AND SOLE REMEDY ON ACCOUNT OF, OR IN RESPECT OF, THE FURNISHING OF NON-CONFORMING DELIVERABLES, SHALL BE TO (A) SECURE REPAIR OR REPLACEMENT OF THE PRODUCTS; OR (B) SECURE REPAIR OR RE-PERFORMANCE OF THE SERVICES OR TO OBTAIN A REFUND OF THE PRICE PAID FOR THE DEFECTIVE SERVICE, ALL AT COMPANY'S OPTION. IN NO EVENT WILL THE COMPANY'S MAXIMUM LIABILITY EXCEED THE SELLING PRICE FOR THE DELIVERABLE. THE WARRANTY, OBLIGATIONS AND LIABILITIES OF COMPANY (INCLUDING ITS SUPPLIERS) AND THE RIGHTS AND REMEDIES OF CUSTOMER ARE EXCLUSIVE AND ARE IN LIEU OF AND CUSTOMER HEREBY WAIVES AND RELEASES ALL OTHER WARRANTIES, OBLIGATIONS, REPRESENTATIONS OR LIABILITIES EXPRESS OR IMPLIED ARISING BY LAW, IN CONTRACT, TORT (INCLUDING NEGLIGENCE OR STRICT LIABILITY) OR OTHERWISE, INCLUDING BUT NOT LIMITED TO (I) ANY IMPLIED WARRANTY OF MERCHANTABILITY OR FITNESS FOR A PARTICULAR PURPOSE OR ANY WARRANTY IMPLIED THROUGH COURSE OF PERFORMANCE, COURSE OF DEALING, OR USAGE OF TRADE OR (II) CLAIMS ARISING OUT OF THE NEGLIGENCE OF COMPANY OR COMPANY'S SUPPLIERS OR (III) ANY OTHER CLAIM ARISING OUT OF, CONNECTED WITH, OR RESULTING FROM THE PERFORMANCE OF COMPANY OR FROM THE DESIGN, MANUFACTURE, SALE, REPAIR, LEASE OR USE OF THE DELIVERABLE, OR ANY COMPONENT THEREOF, DELIVERED OR RENDERED HEREUNDER OR OTHERWISE.

20. INDEMNIFICATION AND LIMITATION OF LIABILITY. a. Customer shall indemnify, defend and hold Company, and its officers, directors, employees, customers, Affiliates, suppliers, users and agents, (collectively the "Indemnitees") harmless from and against any and all damages, claims, losses, expenses, costs, obligations, liabilities, including without limiting the generality of the foregoing, liabilities for court costs and attorneys' fees,

Terms and Conditions

suffered directly or indirectly by an Indemnitee by reason of, or arising out of any injury, death or loss to any person, or injury to any property (collectively, "Damages"), received or sustained by any person(s) or property, arising out of, occasioned by, attributable or related to (i) any breach of any representation or warranty made by Customer, its officers, directors, employees, affiliates, users, agents, representatives or customers to Company or any third party, (ii) any failure by Customer to perform or fulfill any of its covenants, acts and/or omissions to Company or to any third party, or (iii) any litigation, proceeding or claim by any third party relating in any way to the obligations of Customer and/or the Deliverables sold by Company to Customer hereunder. Customer shall not consummate any settlement of any indemnified claim without the Indemnitees' prior written consent. Customer's obligation to indemnify Indemnitees will continue in full force and effect notwithstanding the termination or expiration of any order under this Agreement. In any claim against an Indemnitee by an employee of Customer or any subcontractor or anyone directly or indirectly employed by any of them or anyone for whose acts they may be liable, the indemnification obligations set forth in this Section shall not be limited in any way by or for Customer or any subcontractor under any applicable worker's compensation act, disability or other employee benefit act, or insurance coverage. This provision shall survive termination of any order or Agreement. **IN NO EVENT WILL COMPANY, ITS OFFICERS, DIRECTORS, EMPLOYEES, CUSTOMERS, AFFILIATES, USERS AND AGENTS, (NOR COMPANY'S SUPPLIERS) BE LIABLE FOR ANY INCIDENTAL, CONSEQUENTIAL, INDIRECT, SPECIAL, OR PUNITIVE DAMAGES OF ANY KIND OR NATURE UNDER ANY CIRCUMSTANCES INCLUDING, BUT NOT LIMITED TO, LOSS OF USE OF THE PRODUCTS, SERVICE INTERRUPTION, LOSS OF PROFITS, LOSS OF REVENUE, LOSS OF INTEREST, LOST GOODWILL, LOSS OF DATA, WORK STOPPAGE, IMPAIRMENT OF OTHER GOODS, LOSS BY REASON OF SHUTDOWN OR NON-OPERATION, INCREASED EXPENSES OF OPERATION, OR CLAIMS OF CUSTOMER'S CUSTOMERS, OR ANY OTHER LOSSES OR DAMAGES ARISING OUT OF ANY LACK OR LOSS OF USE OF THE DELIVERABLES WHETHER BASED ON CONTRACT, WARRANTY, TORT (INCLUDING, BUT NOT LIMITED TO, STRICT LIABILITY OR NEGLIGENCE), PATENT INFRINGEMENT, OR OTHERWISE, EVEN IF ADVISED OF THE POSSIBILITY OF SUCH DAMAGES.**

b) **INTELLECTUAL PROPERTY INDEMNITY.** Company makes no representation or warranty to the Customer that the Deliverables shall not infringe any intellectual property rights including, without limitations, claims arising from patent, copyright, trademark, trade secret, or other intellectual property infringement. Customer agrees to hold Company harmless from and defend the Company against any such claim of intellectual property infringement, including any Damages resulting from that claim, the cost of complying with any preliminary or permanent injunction, and all other costs of defense (including the attorneys' fees and costs), in connection with the foregoing.

c) To the extent that applicable law does not permit any limitations set out in this Agreement, such limitation shall not be applied or invoked. Nothing in this Agreement will be interpreted to disclaim liability of Company or the Indemnitees for gross negligence or willful misconduct. The limitations of remedy and liability herein shall not be interpreted to affect Company's obligations, if any, for claims for (i) property damage, (ii) personal injury, or (iii) wrongful death asserted by persons who are not parties to or beneficiaries of this Agreement. Further, the limitations of remedy and liability herein shall not be interpreted to limit Company's or Customer's right, if permitted by applicable law, to assert a claim for contribution among joint tortfeasors in connection with a claim by a person who is not a party to this Agreement.

21. CERTIFICATIONS. Certification of Deliverables for compliance with UL and ANSI standards are tested and performed by third-party independent laboratories. Any field modification or alteration of certified Deliverables will void certification and Company is not liable to Customer to certify any modified or altered Deliverable.

22. TERM FOR CLAIMS. NO ACTION ARISING OUT OF ANY CLAIMED BREACH OF THIS AGREEMENT BY COMPANY MAY BE BROUGHT BY CUSTOMER MORE THAN ONE (1) YEAR AFTER THE CAUSE OF ACTION HAS ARISEN.

23. CONSUMER PRODUCTS WITH RESPECT TO "CONSUMER PRODUCTS" AS DEFINED UNDER THE MAGNUSON-MOSS WARRANTY ACT ("MMWA"), THE FOLLOWING STATEMENTS ARE MADE. (A) SOME STATES OR LOCAL LAWS DO NOT ALLOW LIMITATIONS ON HOW LONG AN IMPLIED WARRANTY LASTS, SO THE ABOVE LIMITATION MAY NOT APPLY TO YOU; (B) IF ANY IMPLIED WARRANTY IS PROVIDED UNDER THE MMWA, IT IS LIMITED TO THE DURATION OF THE WARRANTY PROVIDED IN SECTION 18 ABOVE. (C) SOME STATES OR LOCAL LAWS DO NOT ALLOW THE EXCLUSION OR LIMITATION OF INCIDENTAL OR CONSEQUENTIAL DAMAGES, SO THE ABOVE LIMITATION OR EXCLUSION MAY NOT APPLY TO YOU; AND (D) THIS WARRANTY GIVES YOU SPECIFIC LEGAL RIGHTS AND YOU MAY ALSO HAVE OTHER RIGHTS WHICH VARY FROM STATE TO STATE OR LOCATION TO LOCATION.

24. FORCE MAJEURE/EXCUSABLE DELAY. Any delay or failure of Company to perform its obligations hereunder will be excused to the extent that it is caused by an event or occurrence beyond Company's control such as, by way of example and not by way of limitation, acts of God, acts by any governmental authority (whether valid or invalid), governmental laws and regulations not presently in effect, fires, floods, windstorms, explosions, riots, natural disasters, wars, sabotage, accidents, labor problems (including, without limitation, lockouts, strikes, and slowdowns) at Company's facility, its source plant or their suppliers, inability to obtain power, material, labor equipment, or transportation, or court injunction or order. The delivery date will be extended for a time equal to that of the delay and the schedule for Company's performance will be deemed adjusted to that effect.

25. ENTIRE AGREEMENT AND AMENDMENT. This Agreement, together with the attachments, exhibits, webpages, or supplements specifically referenced and incorporated herein, constitute the entire agreement between Company and Customer with respect to the matters contained herein and supersede all previous communications, representations, or agreements, either oral or written between Company and Customer. No agreement or understanding varying or expanding this Agreement will be binding upon either party unless it is in writing and signed by a duly authorized representative of each party hereto.

26. CONFLICTS. In the event of any conflict or inconsistency between the terms of any agreement, or any part of an agreement or the various documents (including, but not limited to, electronic documents) between Company and Customer, unless the parties agree otherwise in writing, the various components of the agreements shall be given the following precedence (in descending order of precedence): a) any master agreement or long term agreement between Company and Customer; b) any specific terms, conditions and/or warranties of the individual products or Deliverables; c) the terms and conditions of this Agreement; and d) any purchase order.

27. UNSATISFACTORY CREDIT/TERMINATION FOR INSOLVENCY OR DEFAULT.

Customer shall furnish Company with statements evidencing Customer's financial condition as Company may, from time to time, reasonably request, and shall notify Company immediately of any and all events that may have a material adverse effect on Customer's business or financial condition. If Company determines, in its sole discretion, that Customer's financial condition or creditworthiness is inadequate or unsatisfactory, then in addition to Company's other rights, Company may without liability or penalty, take any of the following actions: (i) modify the payment terms for any outstanding and/or future purchases; (ii) cancel any previously accepted orders; (iii) delay any further shipment of Deliverables to Customer; or (iv) any combination of the above.

Company may immediately terminate an order from Customer by giving written notice to Customer in the event of the happening of any of the following or any other comparable event: (i) insolvency of the Customer; (ii) filing of a petition in bankruptcy by or against the Customer; (iii) appointment of a receiver or trustee for the Customer; (iv) execution of an assignment for the benefit of creditors by the Customer, all of which will allow Company to demand reclamation of all affected orders; (v) Customer ceases or threatens to cease to trade; (vi) Company determines that Customer does not meet or no longer meets the credit requirements of Company or Customer's credit account is closed; (vii) any Customer violation of law, specifically including, without limitation, those laws set forth in this Agreement.

In the event of termination in accordance with this section, Company will not be obligated to accept any existing or additional orders from Customer and Company will be released from its obligation to deliver under orders accepted prior to such termination. The rejection or termination of any order by Company will not entitle Customer to any termination or severance compensation, or to any payment in respect to any goodwill established by Customer, or render Company liable for damages on account of the loss of prospective profits, or on account of any loss, expenditure, investment or obligation incurred or made by Customer.

No action taken under this Section 27 by Company (nor any failure of Company to act under this Section 27) will constitute a waiver by Company of any of its rights to enforce Customer's obligations, including the obligation of Customer to make payments as required under this Agreement. Upon termination of any order, all amounts owed by Customer to Company will become immediately due and payable, whether or not otherwise then due or payable.

28. CREDIT RISK ON RESALE OF DELIVERABLES. Customer is responsible for all credit risks with respect to, and for collecting payment for, all Deliverables sold to third parties (including End Users, installers, and/or general contractors) whether or not Customer has made full payment to Company for such Deliverables. The inability of Customer to collect payment for any Deliverable shall not affect Customer's obligation to pay Company for any Deliverable.

29. GOVERNING LAW; VENUE; AND EXPENSES. Any dispute or claim relating to this Agreement shall be governed by and construed according to the laws of the State of Indiana (excluding its conflict of laws principles); and not by the provisions of the 1980 United Nations Convention on the International Sale of Goods. Any disputes or claims shall be instituted and maintained in the courts of the State of Indiana. Customer consents to the exercise of jurisdiction over it by such courts and agrees that Indiana is not an inconvenient forum for any action arising from or relating to this Agreement. Customer agrees to pay for all expenses (including, but not limited to, collection costs, court costs and attorneys' fees) incurred by Company in enforcing the obligations of Customer under this Agreement.

30. RELATIONSHIP OF THE PARTIES. Nothing in this Agreement or any other document creates an employment, partnership, joint venture, or agency relationship between Company and Customer, including that of franchisee/franchisor. No party will have any power or authority to enter into any commitment on behalf of or otherwise bind the any other party on any matter. No employee of Customer will be deemed to be an employee of Company. If any provision of this Agreement is deemed to create a franchise relationship or business opportunity between the Parties, then Company may terminate any purchase order or this Agreement or the Parties shall negotiate in good faith to modify this Agreement so as to effect the original intent of the Parties as closely as possible in a mutually acceptable manner in order that the transactions contemplated hereby are consummated as a reseller agreement and not a franchise or business opportunity agreement.

31. SETOFF. Customer does not have the right to setoff or to back charge against any amounts which become payable to Company under this Agreement or otherwise. Company will not accept responsibility for backcharges for the cost of material or labor by Customer or any third party.

32. ELECTRONIC COMMUNICATIONS AND ELECTRONIC SIGNATURES. Both parties expressly agree to electronic transactions and acknowledge that documents they sign electronically will bind them to the same extent as a paper signature. Customer represents and warrants to Company that only employees authorized to bind Customer legally shall electronically sign any document under this Agreement. Customer shall comply with any method of electronic communication/payment processing specified by Company, including electronic funds transfer, pay-on-receipt processes/systems, order transmission, releases, electronic signature, and electronic communication systems, including, without limitation, the use of electronic data interchange ("EDI") portals. Notwithstanding the foregoing, e-mails, even those containing a signature block of one of Company's representatives, shall not constitute a signed writing.

33. COMPLIANCE WITH APPLICABLE LAWS.

a. General. Company and Customer will comply with all applicable federal, state and municipal laws, regulations, codes, ordinances and orders that pertain to the Deliverables, including but not limited to full compliance with any applicable provisions of The Health Insurance Portability and Accountability Act. Where the Customer is located outside the United States, or where the customer intends to ship the product outside the United States, the Customer shall be responsible for compliance with all U.S. export laws, and for filing all U.S. Electronic Export Information, as applicable.

b. The Customer acknowledges and agrees that: (i) it shall not violate applicable laws and regulations in performing its duties under this Agreement; (ii) it does not and shall not engage in any conduct that shall violate any applicable anti-bribery or anti-corruption laws or regulations; (iii) it (and its owners, officers, directors, employees and agents) shall not pay, offer, promise or authorize the payment of, either directly or indirectly, anything of value (including but not limited to cash, gifts and entertainment) to (a) any government official or employee of any government; (b) any official or employee of any department, agency, or instrumentality of a government; (c) any employee of any corporation or entity owned or

controlled by a government; (d) any family member of such officials or employees; (e) any political party, party official, or political candidate; or (f) any other persons, owners, officers, directors, employees and agents of any corporation or entity; to improperly or illegally assist in obtaining or retaining business (including but not limited to any contracts, avoidance of duties or reduction of tariffs, reduction of taxes or to obtain money owed, or to obtain regulatory approval) or for the purpose of causing, soliciting or inducing the sale and purchase of the Deliverables by any party, and (iv) it has full knowledge of and will comply with the Company's Code of Conduct for Business Partners as set forth on the Allegion customer website, **WHICH IS HEREBY INCORPORATED BY REFERENCE.**

c. The Customer shall indemnify and hold the Company harmless from any claim, demand, expense or cost arising from any breach of this Article.

d. The Customer shall permit the Company to conduct an audit or review of the Customer's financial books and records and business operations at such other times that the Company considers it necessary to confirm compliance with this provision. Such audit may be conducted by representatives of the Company or, at the Company's sole discretion, by a certified public accounting firm selected by the Company. The Customer shall cooperate with any inquiries from the Company's Ethics & Compliance Group.

e. A violation of this provision constitutes a material breach of this Agreement and the Company may terminate any purchase order or this Agreement immediately, with no opportunity to cure, in accordance with Section 27 of this Agreement.

f. Notwithstanding the foregoing provisions of this Section 33, (i) Company is not responsible for obtaining or maintaining any permits for the performance of services or the verification or compliance with any code requirements relative to the performance of services, (ii) to the extent any sale of Deliverables pursuant to this Agreement may require approval of the U.S. Government, Company's obligations under this Agreement are conditioned upon the grant of such approval and upon compliance by Customer with any restrictions imposed by the U.S. Government in connection with such approval, and (iii) in the event the Deliverables are to be used in a nuclear facility, the Customer shall, prior to such use, arrange for insurance or governmental indemnity protecting Company against liability. The Customer hereby releases and agrees to indemnify Company and its suppliers for any nuclear damage including, but not limited to, loss of use, in any manner arising out of the nuclear incident, whether alleged to be due, in whole or in part by Company or its suppliers.

g. **No Inducements.** Each party represents to each other that neither it nor any person acting on its behalf has, in contravention of any applicable law, given or offered to give or will give or offer to give, any sum of money or other material consideration to any person, directly or indirectly, as an inducement to obtain business hereunder or to influence the granting of licenses or other governmental permissions to enter into this Agreement or perform obligations hereunder.

h. **Equal Employment Opportunity.** Company is a U.S. federal contractor that complies with Executive Order 11246, as amended, and applicable regulations in 41 CFR Parts 60-1 through 60-60, 29 U.S.C. § 793 and applicable regulations in 41 CFR § 60-741; and 38 U.S.C. § 4212 and applicable regulations in 41 CFR Part 60-250 and 60-300. **THE FOLLOWING PROVISIONS ARE INCORPORATED HEREIN BY REFERENCE:** Executive Order 11246, as amended by Executive Order 13672, and 41 CFR § 60-4.3(a); Executive Order 11701 and 41 CFR §§ 60-250.5(a), 60-300.5; Executive Order 11758 and 41 CFR § 60-741.5(a); U.S. immigration laws, including the L-1 Visa Reform Act of 2004 and the H-1B Visa Reform Act of 2004; and Executive Order 13496.

i. **Ethical Business Conduct.** Customer shall adopt and comply with Company's Business Partner Code of Conduct which is **EXPRESSLY INCORPORATED HEREIN BY REFERENCE.**

34. REPRESENTATIONS AND WARRANTIES. Customer represents, warrants and covenants to Company that: (a) it has the right, power, and authority to enter into this Agreement and fully perform its obligations hereunder; (b) it has all necessary rights in and to its respective Content and Marks for use within the scope of this Agreement, including the licenses granted herein; and (c) it complies, and at all times shall comply, with all laws, rules, and regulations in effect that are applicable to its performance under this Agreement, including obtaining all such approvals and/or permits as may be required hereunder.

35. NO THIRD-PARTY BENEFICIARY. Each party is entering into this Agreement solely based on the representations contained herein for its own purposes and not for the benefit of any third party.

36. NOTICES AND CHANGE OF ADDRESS. All notices or other communications under this Agreement shall be in writing and delivered in person, or sent by receipted courier, express mail, e-mail, or postage prepaid certified or registered mail, addressed to the party for whom it is intended, at the addresses set forth in this Agreement. Either party may change its address for notice by giving written notice to the other party. Any notice or other communication shall be deemed given no later than the date actually received. Notice by courier, express mail, certified mail, or registered mail shall be deemed given on the date it is officially recorded as delivered and, in the absence of such record of delivery, it shall be rebuttably presumed to have been delivered on the third Business Day after it was deposited. Notices sent by e-mail require tangible confirmation of receipt from addressee.

37. ASSIGNMENT. Customer may not assign this Agreement without the prior written consent of Company. Company may assign its rights and delegate its duties under this Agreement, without the prior consent of Customer, to an Affiliate, or to a third party in the event of a spin-off, merger, business combination, consolidation or sale of all, or substantially all, of its assets or business that are related to this Agreement. The rights and duties in this Agreement shall bind and inure to the benefit of any such assignee.

38. SEVERABILITY. If any provision of this Agreement is held to be invalid, illegal, or unenforceable under any statute, regulation, ordinance, executive order, or other rule of law, that provision will be deemed severed to the extent necessary to comply with such statute, regulation, ordinance, order, or rule. In the event such provision is deemed severed, the parties will negotiate in good faith to arrive at an alternative arrangement approximating the original business objective of the parties. The remaining terms and conditions of this Agreement will remain in effect.

39. NO IMPLIED WAIVER. The failure of either party at any time to require performance by the other party of any provision of this Agreement will in no way affect the right to require such performance at any time thereafter, nor will the waiver of either party of a breach of any provision of this Agreement constitute a waiver of any succeeding breach of the same or any other provision.

40. MISCELLANEOUS. (a) This Agreement does not make either party the agent or legal representative of the other party. Neither party is authorized to create any obligation on behalf of the other party including, but not limited to, the obligation for payment of any service or warranty obligation hereunder; (b) The rights and remedies herein reserved to

Company are cumulative and additional to any other rights and remedies provided at law or equity; (c) The official text of this Agreement is in the English language. If this Agreement is translated into another language, the English text will govern any question with respect to interpretation; (d) The headings in this Agreement are for convenience of reference only and do not affect the meaning of this Agreement in any manner.

DEFINITIONS.

Capitalized terms have the meanings set forth in this Section, or in the Section in which they first appear in this Agreement.

"Agreement" means these Allegion Terms and Conditions of Sale and Service, together with any applicable Country Supplement or Region Supplement provided by Company, and all of the documents referenced herein or therein.

"Affiliate" means any Person that directly or indirectly, through one or more intermediaries, controls, is controlled by, or is under common control with, the Company. The term "control" (including the terms "controlled by" and "under common control with") means the possession, directly or indirectly, of the power to direct or cause the direction of the management and policies of a Person, whether through the ownership of voting securities, by contract or otherwise.

"Business Day" means any day except Saturday, Sunday or any other day on which commercial banks located in the United States are authorized or required by Law to be closed for business.

"Company" means Schlage Lock Company, LLC or any subsidiary or affiliate thereof selling products that are part of the Allegion product portfolio. Schlage Lock Company and/or its subsidiary or affiliates will be severally but not jointly liable under the Agreement.

"Company Marks" refers to the Marks of Company.

"Confidential Information" shall mean any and all information provided by either party to the other party pertaining to the disclosing party's business. Confidential Information shall include, but not be limited to, any bidding lists, formulae for products, manufacturing processes, production techniques, packaging processes, methods, research materials, ideas, marketing plans and related materials, quality standards, test results and data, apparatus, engineering drawings, contract documents, computer software, hardware, or firmware, business activities information such as financial information, reports, projections, books and records, customer and supplier information, and operations, customer and supplier lists and data, specifications, know how, and other Proprietary Information or Trade Secrets (as defined herein) that either party may furnish to the other party. Confidential Information shall not include information that: (a) is or becomes publicly known if such public knowledge or disclosure is not the result of any act or failure to act on the part of the receiving party; (b) is, at the time of disclosure, already known to the Receiving Party without utilizing the Confidential Information; (c) is information disclosed to the Receiving Party by a third party which is not to the Receiving Party's knowledge, after inquiry of the third party, under a duty of confidentiality to the Disclosing Party; or (d) is independently developed by the Receiving Party without the use of Confidential Information. The Receiving Party shall have the burden of proof as to prior knowledge and absence of breach. Confidential Information may be furnished in any tangible or intangible form including, but not limited to, writings, drawings, computer and other electronic media, logic diagrams, component specifications, graphs, prototypes, samples, or verbal communications and regardless of whether such information is marked or designated as "confidential." For the avoidance of doubt, all information, knowledge or data disclosed by Company to Customer, regardless of whether disclosed in written, tangible, oral, visual or other form, including, without limitation, sample products, equipment, software, or other objects or material, provided by Company to Customer, and all information, knowledge or data which was obtained by Customer from visits to Company's facilities, shall be considered "Confidential Information" under this Agreement.

"Content" means all information (including without limitation any text, music, sound, photographs, video, graphics, data or software), in any medium, on a particular Company Web page or Website or in Marketing Materials.

"Customer" means the purchaser of Deliverables from Company.

"Deliverables" means any good or service or both purchased by Customer from Company under these General Terms and Conditions of Sale and Service.

"End Users" means the purchaser that (a) has acquired a Deliverable from Customer for (i) its own and its Affiliate's/Affiliates' internal use and not for resale, remarketing or distribution or (ii) incorporation into its own products and (b) is an individual or entity, other than any federal, state or local agency, office or division.

"IP" means all intellectual property and industrial property rights comprising or relating to/ of the following: (a) Patents; (b) Trademarks; (c) internet domain names, whether or not Trademarks, registered by any authorized private registrar or Governmental Authority, web addresses, web pages, website and URLs; (d) works of authorship, expressions, designs and design registrations, whether or not copyrightable, including copyrights and copyrightable works, software and firmware, application programming interfaces, architecture, files, records, schematics, data, data files, and databases and other specifications and documentation; (e) Trade Secrets; and (f) all other intellectual property and industrial property rights, and all rights, interests and protections that are associated with, equivalent or similar to, or required for the exercise of, any of the foregoing, however arising, in each case whether registered or unregistered and including all registrations and applications for, and renewals or extensions of, such rights or forms of protection pursuant to the Laws of any jurisdiction throughout in any part of the world.

"Marketing Materials" means all marketing brochures, buckslips, pamphlets, emails, text, call scripts or other material, whether in printed format, audio or audiovisual format, or in any other format, that contain any (i) Content relating to the Company Deliverables or (ii) Company Marks.

"Marks" means collectively the domain names, trademarks, trade names, service marks, trade dress, logos, and the like used or provided by either party for use in connection with this Agreement.

"Patents" means all patents (including all reissues, divisionals, provisionals, continuations and continuations-in-part, re-examinations, renewals, substitutions and extensions thereof), patent applications, and other patent rights and any other Governmental Authority-issued indicia of invention ownership (including inventor's certificates, petty patents and patent utility models).

"Person" means a person or entity.

"Price Books" mean Company's current Price Book in effect for the applicable Deliverable being purchased by Customer.

"Trade Secrets" means and includes business or technical information of either party, including processes, formulas, devices, techniques, compilations and other material that a party attempts to maintain in secret and that derive commercial value for such party from not being generally known to the public or readily ascertainable through independent development or reverse engineering.

Warranty

LIMITED WARRANTY

Company warrants only to Customer that Products will be free from defects in material and workmanship for a period of 12 months from the date of shipment of the Products. Company's sole obligation under this warranty is limited to repairing or replacing, at its option, the defective Products.

The provisions of this limited Product warranty do not apply to Products:

- A. Used for the purposes for which they are not designed or intended
- B. Have been repaired or altered without Company's prior written consent
- C. Have been subjected to misuse, abuse, negligence, or accident
- D. Have been improperly stored, installed, maintained, or operated
- E. Have been used in violation of written instructions provided by Company to Customer
- F. Have been subjected to improper temperature, humidity, or other environmental conditions
- G. Have been affected by normal wear and tear; or
- H. Based on Company's examination, do not disclose to Company's satisfaction nonconformance to the warranty

In the event that certain Service warranties are not attached to this Agreement or separately furnished, Company warrants only to Customer that the Services will be free from defects in material and workmanship for a period of 6 months from the date of completion of the particular items of Service. Company's sole obligation under this warranty is limited to repairing or reperformance, at its option, of the Service; provided however, if repair or reperformance is either impractical or impossible, the Company will refund to Customer that portion of the price paid to the Company for the defective item of Service. This warranty only applies if the company is given written notice of the defect or nonconformance by the Customer within 30 days of discovery.

The provisions of this limited Service warranty does not apply to any defects or issues with the design or performance of equipment or products not manufactured by Company, nor does it apply to any code compliance or permit requirements for the assembly, installation, erection, or construction of any goods.

NO OTHER WARRANTIES, EXPRESS OR IMPLIED, ARE MADE WITH RESPECT TO THE PRODUCTS OR SERVICES INCLUDING, BUT NOT LIMITED TO, ANY IMPLIED WARRANTY OF MERCHANTABILITY OR FITNESS FOR A PARTICULAR PURPOSE.

The following costs and expenses are not covered by the provisions of these limited warranties:

- (i) Labor costs for the removal and reinstallation of Products or other manufacturer's products;
- (ii) Shipping and freight expenses required to return Products to Company;
- (iii) Normal maintenance; and
- (iv) Economic losses.

In addition, the provisions of this warranty are not applicable to anything other than defects in Company's material (products only) or workmanship.

Signature: _____ Name: _____

Job Name: _____ Date: _____



STEELCRAFT®

9017 Blue Ash Road
Cincinnati, Ohio 45242
(513) 766-4300
(513) 745-6657 FAX

GENERAL INFORMATION:

1. A purchase order without complete information is **not considered an order**. Prior to sending your order, please make sure that you have all necessary information (templates if required, shipping destinations, and all other information pertinent to the order).
2. Please include all necessary information within the individual order line. While efforts will be made to question, conflicting information between a header page and an individual order line will default to the order line detail.
3. Shipping lead-time for weekly scheduled orders is calculated from the following week that final information is received.
4. Order cutoff is 12:00 midnight EST/EDT, and is based on the program and facility:
 - Blue Ash – Customer ship date for all programs
 - West Coast Service Center – Thursday for all programs

EXCEPTIONS:

1. The cutoff dates will be adjusted for weeks with holidays. Refer to the Weekly Lead-Time Bulletin for any schedule adjustments.
2. Orders containing products with different shipping schedules will be scheduled per the longest lead-time product.
 - **Steelcraft does not split orders based on lead-times.**
3. Orders requiring changes 48 hours after acknowledgment will be subject to cancellation charges and / or revised shipping schedules.
 - **Changes are not allowed on Rapid Program or Express Program orders after the order has been entered and acknowledged.**
4. Consult Customer Service at 1-877-671-7011 for items not shown in the price list.
5. Check all acknowledgments carefully, and immediately, for discrepancies. If an error is identified please contact Customer Care immediately.
6. Expedite requests will be considered and accommodated when possible. Orders that are expedited are subject to a discount reduction. Contact Customer Care for considerations and discounting detail.

ORDER SUBMISSION:

Orders are submitted to Steelcraft through OEW (Order Entry Works), fax or e-mail:

1. **OEW orders (Steelcraft's preferred method of receiving orders):**
 - Orders receive an additional discount, contact your local Sales Office for discount information.
 - Stock orders and select Standard (4-week) program orders also receive an additional discount, contact your local Sales Office for discount information.
 - Additional products and features are available when ordered through OEW. See Programs page for details.
2. **Faxed and e-mailed orders:**
 - Orders must be submitted on Steelcraft order forms.
 - Refer to Allegion's Distributor Portal to download order forms.
 - Rapid Program orders must be submitted through OEW to receive quoted discounts.
 - Orders will be processed on a first come first served basis with OEW orders taking precedence.
 - Shop drawings and hardware schedules are not considered a purchase order

BLUE ASH:**EXPRESS STOCK:****2 day lead-time from 1pm EST cutoff**

- Applies to all KWIK-PAK doors, frames and stock package part.
- Orders accepted through OEW only and subject to a 2 point reduction from current buying program discount.

EXPRESS FRAMES:**3 day lead time from order date and cutoff time**

- Applies to all 3-sided frames as shown on program bulletin.
- Buying program less 4 points
- Available through OEW only
- See program page for additional information.

STOCK:**5 day lead-time from order cutoff day**

- Applies to all stock products listed in the Stock section of this Price Book or on order form Steelcraft Cat. #663 and non-shaded items in Parts Section.

RAPID:**10 day lead-time from order cutoff day**

- When ordering via OEW all door and frame products are available with the below exceptions. See Rapid Programs Section.

Door exceptions:

- Stainless steel
- Factory installation
 - INPACT™ Integrated Door System
 - Installed astragals
 - LM9300 devices
 - Von Duprin Concealed Vertical Cables
- Paladin™ Tornado Doors
- Factory finished paint
- GRAINTECH™ factory stained

Frame exceptions:

- Stainless steel
- 12 gauge frames
- All elevations other than four (4) sided borrowed light frames and current stick-shop material
- Factory welding will add (1) week for 3-sided material and (2) weeks for elevations
- FT-Series frames
- Pocket frames

STICK SHOP – Stock elevations:**10 day lead-time from order cutoff day**

- Applies to all stock stick material in the Stick section of the Price Book.
- All material is saw cut and notched as ordered.

STANDARD - Non-stock doors, frames and elevations:**4 week lead-time from order cutoff day****WEST COAST SERVICE CENTER:**

All material will ship out of the West Coast Service Center.

EXPRESS STOCK:**1 day lead-time from 1pm EST cutoff**

- Applies to all stock products listed in the West Coast Stock section of the Price Book.
- Orders accepted through OEW only and subject to a 2 point reduction from current buying program discount.

STOCK & MODIFIED STOCK:**5 day lead-time from order cutoff day**

- All frame and door material listed in the West Coast Stock section of the Price Book.
- Refer to the modified stock pages in the Stock section of the Price Book.
- Blue Ash stock can be ordered through the RAPID program.

EXPRESS FRAME:**7 day lead-time from 1pm EST cutoff**

- Applies to nearly all frame product listed in the Frame section of the Price Book. See program sell sheet for details.
- Contact Customer Service for availability.
- All frames must be ordered as A-60 galvanized.

RAPID:**12 day lead-time from order cutoff day**

- When ordering via OEW all door and frame products are available with the below exceptions. See Rapid Programs Section.

Door exceptions:

- Stainless steel
- Factory installation
 - INPACT™ Integrated Door System
 - Installed astragals
 - LM9300 devices
 - Von Duprin Concealed Vertical Cables
- Paladin™ Tornado Doors
- Factory finished paint
- GRAINTECH™ factory stained

Frame exceptions:

- Stainless steel
- 12 gauge frames
- All elevations other than four (4) sided borrowed light frames and current stick-shop material
- Factory welding will add (1) week for 3-sided material and (2) weeks for elevations
- FT-Series frames
- Pocket frames

STICK SHOP – Stock elevations:**12 day lead-time from order cutoff day**

- Applies to all stock stick material in the Stick section of the Price Book.
- All material is die-mitered for standard profile product from service center.

STANDARD - Non-stock door, frames and elevations:**4-5 week lead-time from order cutoff day**

Prices subject to change without notice.

RAPID FRAME OPTIONS

		Expanded offerings when order placed through OEW
Frame Series: <ul style="list-style-type: none"> • F Series • DW Series • K Series • MU Series • FE Series 	<ul style="list-style-type: none"> • Knocked down (KD) only • Prep for 1 3/4" thick door • Variations in rabbet, stop and returns are not available • 2" face jambs and 2" or 4" face heads 	
Frame Material: <ul style="list-style-type: none"> • 16 Gauge • 14 Gauge • CRS or A 60 	<ul style="list-style-type: none"> • F, MU, DW, FE or K • F, FE • F, MU, DW, FE or K..... 	<ul style="list-style-type: none"> • DW, MU or K • G 90 available
Jamb Depth Range (min / max): <ul style="list-style-type: none"> • F and MU: (Note: Wire masonry anchors only for jamb depths larger than 9 1/2") <ul style="list-style-type: none"> • Single Rabbet • Unequal Rabbet • Equal Rabbet • Cased Open • K / DW • FE (masonry anchors only) 	<ul style="list-style-type: none"> • 3 3/4" to 14 3/4" • 4 1/2" to 14 3/4" • 4 7/8" to 14 3/4" • 4 1/2" to 14 3/4" • 4 1/2" to 14 3/4" • 5 3/4", 6 3/4", 7 3/4" and 8 3/4"..... 	<ul style="list-style-type: none"> • Special jamb depths • 5 3/4" – 14" jamb depth
Frame Opening Sizes (min / max): <ul style="list-style-type: none"> • Jamb • Head 	<ul style="list-style-type: none"> • Equal to series (min/max) sizes 	
Frame Face Sizes: (3-sided and component pieces, double rabbet) <ul style="list-style-type: none"> • 2" face jambs and 2" or 4" face heads 	<ul style="list-style-type: none"> • F, MU, DW, FE or K Series 	<ul style="list-style-type: none"> • Special faces (1 1/4", 1 1/2", 1 3/4") • 1" face • F and MU Series • FN Series
Frame Hardware: <ul style="list-style-type: none"> • Hinges • Continuous Hinges • Two (2) pair of hinges • Strikes • Closers • Flushbolts • Silencers • Deadlock Strikes • Standard CYL and ASA • Coordinators 	<ul style="list-style-type: none"> • Blank, 4 1/2" or 5" at standard Steelcraft locations and special vertical locations • With or without reinf. Default is without reinf. unless specified otherwise • In lieu of 1 1/2 pair • ASA, RPD, or VRPD reinf. at standard Steelcraft locations and special vertical location..... • RA, PA, TJ or full-width..... • Standard, non templated and standard or special location for unequal pairs of doors • Factory punched for field installation • Preps ordered by Steelcraft Cat. #535 only..... • Strike preps in head. Location to centerline of strike required 	<ul style="list-style-type: none"> • Pivot preps • CVRPD • 12 ga. head reinf. channel • Concealed (track in door) • Manufacturers numbers • Electric strikes • Door position switches • Electric hinges • Power transfers • Soffit, face or templated
Labels: <ul style="list-style-type: none"> • UL labels and ITS/WHI labels 	<ul style="list-style-type: none"> • Available where applicable. Indicate hourly rating 	<ul style="list-style-type: none"> • FM labels
Frame Products: <ul style="list-style-type: none"> • Dutch frames • Borrowed Lights - Four (4) sided KD • Communicating • Pierce and dimple • Jamb Anchors • Base anchor 	<ul style="list-style-type: none"> • 4 1/2" through 14 3/4" jamb depth. 6'8", 7'0" and 7'2" heights (non-label only) • 4 1/2" to 14 3/4" jamb depth maximum dependent on frame series. Glazing beads required on labeled only • Equal and unequal rabbet 4 1/2" to 14 3/4" jamb depth maximum, dependent on frame series • EMA anchors. Anchors not included • Lock in standard jamb depth wood or steel stud anchors (not available on FE) • Lock in universal wood or steel stud anchors (not available on FE) • Masonry T-Anchors 5 3/4", 6 3/4", 7 3/4" and 8 3/4" jamb depth • Welded in F, MU and FE 	<ul style="list-style-type: none"> • Hospital stops • Welded in wood stud steel stud 4" and 6 1/2" nailing clip or EMA hat anchors • Weld in anchors available on FE • F, DW, MU and K • Kerf frame

Prices subject to change without notice.

		Expanded offerings when order placed through OEW
Door Series: <ul style="list-style-type: none"> • L Series • B Series • CE Series • SL Series 	<ul style="list-style-type: none"> • LF Series (honeycomb, polystyrene or polyurethane) • BF Series (standard and STC stiffened) • CF Series • SZ Series 	<ul style="list-style-type: none"> • H, HF, HE and HW Series • LW and BW Series • A14 Series • T and TW Series
Door Material: <ul style="list-style-type: none"> • 20 Gauge • 18 Gauge • 16 Gauge • CRS or A 60 	<ul style="list-style-type: none"> • G 90 available (L and • L, CE • L, B, CE, SZ • L, B, CE..... • L, B..... 	<ul style="list-style-type: none"> • H Series) • 14 gauge (L, B, T and H Series) • H Series • H Series
Door Opening Sizes (min / max): <ul style="list-style-type: none"> • Height • Width • Pairs of doors • Wide inactive 	<ul style="list-style-type: none"> • 3'0" to 10'0" height in 1/8" increments • 1'6" to 4'0" single door width in 1/8" increments • Available 4'0" to 8'0" in width. Standard Z- astragal or Double Egress astragal 	
NOTE: Refer to the Steelcraft Tech Data Manual for maximum width and height limitations by door series.		
Door Design Type: <ul style="list-style-type: none"> • F (Flush) • Glass lights • Dutch door 	<ul style="list-style-type: none"> • Designer Trim 1/4" or 1/2" thick glass only • Light or louver cutout - label or non-label • Dutch doors 6'8", 7'0" and 7'2" heights only, single swing, non-label • 1 3/4" transom panels • Laminated panels 	<ul style="list-style-type: none"> • Lights for glass over 1/2" thick
Door Hardware: <ul style="list-style-type: none"> • Hinges • Continuous Hinges • Two (2) pair of hinges • Locks • 86 Lock sectional trim • Mortise exits • Rim exits • Surface VR exit • Deadlocks • Closers • Holders and Stops • Flushbolts • Steel caps 	<ul style="list-style-type: none"> • Blank, 4 1/2" or 5" at standard Steelcraft and special vertical locations • With or without reinf. Default is without reinf. unless specified otherwise • In lieu of 1 1/2 pair • 161, 61L, 86, 86ED, 86EDR, RPD, VRPD, PP, Blank, ASA, ASAV at standard Steelcraft and special • Per Steelcraft Cat. #652 • Per Steelcraft Cat. #556 • Per Steelcraft Cat. #541 • Per Steelcraft Cat. #705 • Per Steelcraft Cat. #535..... • Standard closer reinf. top of door • OEW orders only • 6", 12", 24" or 36" top and 12" bottom standard or non-templated • Top and / or bottom caps screwed in 	<ul style="list-style-type: none"> • Pivot preps • High frequency hinge • Roller latch • Combo locks • Manufacturers numbers • Manufacturers numbers • Manufacturers numbers • Manufacturers numbers • Manufacturers numbers • Concealed VR exit • Full width • Concealed (track in door) • Electric strikes • Door position switches • Electric hinges • Power transfers • Raceway • Magnetic switch • Flush top channel
Labels: <ul style="list-style-type: none"> • UL labels and ITS/WHI labels 	<ul style="list-style-type: none"> • Available where applicable. Indicate hourly rating 	
Finish:		<ul style="list-style-type: none"> • Omit prime paint

Prices subject to change without notice.

TABLE OF CONTENTS

FRAME PRODUCT INFORMATION 15

FLUSH FRAMES

F16 and FN16-Series 16
F14 and FN14-Series 18
F12-Series 20
MU16-Series 22
MU14-Series 24
FE16 and DE16-Series 26
FE14 and DE14-Series 26
FS16-Series 35
MS16-Series 35
KS16-Series 35
FT16 and FT14-Series 36
Paladin™-Series Tornado Resistant Frames (refer to door section) 59

DRYWALL (SLIP-ON) FRAMES

DW16 and K16-Series 28
DW14 and K14-Series 30

CUSTOM FRAMES CONSTRUCTION OPTIONS 32

Prices subject to change without notice.

FRAME PRICING GUIDELINES AND POLICIES: The following guidelines and policies are followed when applying pricing to frames. Refer to the following price pages for the appropriate frame series and options.

GENERAL:

Three (3) sided frames and components (jambs and heads) are supplied standard factory prime painted and knock down for field assembly. Special profile frames, depending on profile and specification requirements, are supplied as die mitered pieces, ready for field or factory welding prior to installation.

ANCHORS:

Standard frames and jamb components include the following standard anchors:

1. F and MU-Series frames:

- Anchor quantities:
 - 3 per jamb up to 7'6"
 - 4 per jamb over 7'6"
- Standard anchors at no charge:
 - Wire masonry, "T"-masonry, wood stud or steel stud
 - Adjustable base anchors
- Optional deduct for frames without anchors:
 - Deduct anchor price per individual price sheets
- Optional special anchors with an up charge:
 - Optional masonry EMA, "Tube and Strap" and other anchors available from the parts section of this price book
 - Optional weld-in anchors and anchors for special profile frames are available (see custom frame options page)

2. FE and DE-Series frames:

- Masonry wall anchor quantities:
 - 3 per jamb up to 7'6"
 - 4 per jamb over 7'6"
- Stud (wood or steel) wall anchor quantities (weld-in):
 - 4 per jamb up to 7'6"
 - 5 per jamb over 7'6"
- Standard anchors at no charge:
 - Wire masonry supplied standard
 - Welded in base anchors
- Optional deduct for frames without anchors:
 - Deduct anchor price per individual price sheets
- Optional special anchors with an up charge:
 - Optional masonry EMA "Tube and Strap" and other anchors available from the parts section of this price book
 - Optional weld-in anchors and anchors for special profile frames are available (see custom frame options page)

3. DW and K-Series frames:

- Adjustable compression anchor supplied standard
- Base anchors:
 - DW-Series frames supplied standard with twist-in base anchors
 - K-Series frames supplied with face pierced and dimpled for visible anchoring

FRAME COMPONENTS (JAMBS and HEADS):

1. Hinge Jamb preps:

- Number of hinges based on door height:
 - 2 hinges – up to 5'0" high
 - 3 hinges – 5'0" and up to and including 7'6" high
- **NOTE:** 6'8" high frames for 1³/₈" doors are standard with 2 hinge preps
- 4 hinges – over 7'6" high
- Standard hinge prep at no charge:
 - 4¹/₂" Universal hinge preps
 - 4¹/₂" standard weight prep for DW and K-Series
- Optional hinge preps at no charge:
 - 5" Universal hinge preps
 - Blank hinge - no hinge preps, no reinf.
 - Continuous hinge - no reinforcing standard
- Optional hinge preps with an up charge:
 - Refer to the individual price pages and the hardware preps section of this price book

2. Strike Jamb preps (one prep included):

- Standard strike prep at no charge:
 - 4⁷/₈" ANSI strike (ANSI/BHMA A156.115.1-2)
 - 3 preps for field installed silencers
- Optional strike preps at no charge:
 - 2³/₄" ANSI strike (ANSI/BHMA A156.115.3)
 - Blank strike
- No strike preps, no reinf.
- Optional strike preps with an up charge:
 - Refer to the individual price pages and the hardware preps section of this price book

3. Head preps:

- Single door openings:
 - Up to and including 4'0" door opening size
 - No prep as standard
 - Optional preps with an up charge:
- Refer to the individual price pages and the hardware preps section of this price book
- Double door openings:
 - All door opening sizes over 4'0"
 - 2 silencer preps located from the centerline
 - Optional preps at no charge
- Omit silencer preps for single door
 - Optional preps with an up charge
- Refer to the individual price pages and the hardware preps section of this price book

Prices subject to change without notice.

COMPLETE FRAME PRICING

Single Frame		JAMB DEPTH				
Width	Height	3"-5 ⁷ / ₈ "	6"-7 ⁷ / ₈ "	8"-9 ⁷ / ₈ "	10"-11 ⁷ / ₈ "	12"-14 ³ / ₄ "
1'6" thru 3'0"	6'8"	207	219	245	286	330
	7'0"	213	232	255	296	339
	7'2"	227	240	258	307	349
	8'0"	252	264	288	331	377
	9'0"	268	288	306	357	406
Over 3'0" thru 4'0"	10'0"	284	301	321	367	417
	6'8"	220	232	254	299	342
	7'0"	226	245	264	309	351
	7'2"	240	253	267	320	361
	8'0"	265	277	297	344	389
Over 3'0" thru 4'0"	9'0"	281	301	315	370	418
	10'0"	297	314	330	380	429

Double Frame		JAMB DEPTH				
Width	Height	3"-5 ⁷ / ₈ "	6"-7 ⁷ / ₈ "	8"-9 ⁷ / ₈ "	10"-11 ⁷ / ₈ "	12"-14 ³ / ₄ "
4'0" thru 6'0"	6'8"	268	282	310	356	403
	7'0"	274	290	316	362	407
	7'2"	286	304	320	372	421
	8'0"	326	342	362	416	467
	9'0"	344	366	386	446	497
Over 6'0" thru 8'0"	10'0"	358	382	402	454	507
	6'8"	279	288	325	370	418
	7'0"	285	296	331	376	422
	7'2"	297	310	335	386	436
	8'0"	337	348	377	430	482
Over 8'0" thru 10'0"	9'0"	355	372	401	460	512
	10'0"	369	388	417	468	522
	6'8"	294	305	341	389	435
	7'0"	300	313	347	395	439
	7'2"	312	327	351	405	453
Over 8'0" thru 10'0"	8'0"	352	365	393	449	499
	9'0"	370	389	417	479	529
	10'0"	384	405	433	487	539

COMPONENT PART PRICING

JAMB DEPTH						
Part	Height	3"-5 ⁷ / ₈ "	6"-7 ⁷ / ₈ "	8"-9 ⁷ / ₈ "	10"-11 ⁷ / ₈ "	12"-14 ³ / ₄ "
Strike Jamb	6'8"	78	82	90	106	121
	7'0"	81	91	97	113	128
	7'2"	89	92	98	119	131
	8'0"	94	97	107	121	136
	9'0"	101	109	113	132	150
Hinge Jamb	10'0"	110	114	120	138	156
	6'8"	93	96	106	121	138
	7'0"	96	100	109	124	140
	7'2"	102	107	111	129	147
	8'0"	122	126	132	151	170
Hinge Jamb	9'0"	131	138	144	166	185
	10'0"	138	146	152	170	190

JAMB DEPTH						
Part	Width	4 ³ / ₄ "-5 ⁷ / ₈ "	6"-7 ⁷ / ₈ "	8"-9 ⁷ / ₈ "	10"-11 ⁷ / ₈ "	12"-12 ³ / ₄ "
Head	Thru 3'0"	36	41	49	59	71
	Thru 4'0"	49	54	58	72	83
	Thru 5'0"	76	81	89	105	116
	Thru 6'0"	82	90	98	114	127
	Thru 8'0"	93	96	113	128	142
	Thru 10'0"	108	113	129	147	159

NOTES:

1. Jamb Depths:

- 4 1/2" and larger are double rabbet as standard
- 3" thru 4 3/8" are supplied single rabbet
- All frames listed are available in jamb depth increments of 1/8"

2. Door Opening Sizes:

- Standard frame sizes are listed
- Any non-standard frame width and / or height is priced as the next larger size frame category.

See page 34 for special size limit.

- Maximum size:
 - Single: 4'0" x 10'0"
 - Double: 10'0" x 10'0"

3. FN-Series Frames (1" Face):

- Available as double rabbet only
- Weld-in fixed base anchor standard

4. Cased Open Frames:

- Priced as two (2) strike jambs and head from Component Part Pricing
- Weld-in fixed base anchor standard

LABELED FRAMES:	Single	Pair
UL		
• Metal label (includes closer reinf.)	33	48
• 3 hr. in stud partition (includes closer reinf. and stiffeners in head)	43	74
ITS/WHI		
• Metal label (includes closer reinf.)	33	48
• Mylar label (closer reinf. NOT included)	12	24
FM		
• Mylar label (includes closer reinf.)	33	48

Refer to the Steelcraft Tech Data Manual for all labeled approvals.

16 GAUGE FLUSH FRAMES

FOR 1³/₄" OR 1³/₈" DOORS

Standard Construction Options: Per frame

GALVANNEALED A-60 STEEL:	Thru 5⁷/₈"	Over 5⁷/₈"
• Complete frame	\$36	\$41
• Per jamb	\$14	\$16
• Per head	\$8	\$9

GALVANIZED G-90 STEEL:	Thru 5⁷/₈"	Over 5⁷/₈"
• Complete frame	\$55	\$65
• Per jamb	\$21	\$24
• Per head	\$13	\$17
• Maximum opening height 9'10"		

4" FACE HEAD:	Thru 4'0"	Over 4'0"
	\$40	\$56

MARK NUMBERSN/C

EQUAL RABBETN/C

DUTCH FRAME:	Non-Labeled	Labeled
	\$39	\$99

COMMUNICATING FRAMES:

- Single openings only \$49
- Specify if doors swing from the same or opposite jambs

SPECIAL PROFILE FRAMES:

- Refer to page 32 for pricing
- Special anchor charges will apply

HOSPITAL SANITARY STOPS (4", 5¹/₂" and 6" high standard):

- Single rabbet 45° only \$147
- Double rabbet 45° \$147
- Double rabbet 90° \$147

ANCHORS (Factory welded or prepped):

	Per frame	
	Thru 9 ¹ / ₈ "	Over 9 ¹ / ₈ "
• Welded-in standard anchors (in lieu of loose)		
• Base	N/C	N/C
• Jambs thru 7'6"	\$30	\$48
• Jambs over 7'6" thru 10'0"	\$40	\$64
• Each additional	\$5	\$8
• EMA (pierce and dimple only)		
• Jambs thru 7'1"	\$20	\$40
• Jambs over 7'1" thru 8'9"	\$25	\$50
• Jambs over 8'9" thru 10'0"	\$30	\$60
• Each additional	\$2.50	\$5
• EMA (pierce, dimple, weld-in anchors with bolts)		
• Jambs thru 7'1"	\$148	\$296
• Jambs over 7'1" thru 8'9"	\$185	\$370
• Jambs over 8'9" thru 10'0"	\$222	\$444
• Each additional	\$18.50	\$37

ANCHORS (Standard loose / lock-in):

- Deletion of anchors (deduct from standard frame price)

	Per jamb	Per frame
• Base	\$2.30	\$4.60
• Jambs thru 7'6"	\$5.65	\$11.30
• Jambs over 7'6"	\$6.95	\$13.90

12 GAUGE HEAD REINFORCING CHANNEL:
(2" face only, full jamb depth) \$150

Standard Hardware Options: Per prep

SPECIAL VERTICAL HARDWARE LOCATIONS:

- Hinge and lockN/C

CLOSERS:

- Surface mounted:
 - 14" strap installed \$16
(specify regular, parallel arm or top jamb)
 - Closer sleeve installed..... \$35
- Concealed in head (per template) \$193
- ALLE Concealed in head (per template) \$175

HINGES:

- 5" Universal in lieu of 4¹/₂"N/C
- Additional hinge prep (4¹/₂" or 5") \$14
- High frequency prep..... \$16
- Continuous hinge:
 - No reinf. (blank jamb)N/C
 - Full length reinf. \$54

STRIKES:

- Additional ASA (4⁷/₈" ANSI A115.1-2) \$14
- Additional Cylindrical (2³/₄" ANSI A115.3) \$14
(minimum 7" above or below standard strike)
- Double Cylindrical (2³/₄") on 4" centers \$27
- Deadlock (non-lip)..... \$15
- Flushbolts:
 - Steelcraft reversible \$42
 - Standard (ANSI 115.4) \$42
- Surface Bolt reinf. \$20
- Exit Devices:
 - Rim reinf. only \$16
 - Vertical Rod reinf. only \$20
 - Vertical Rod Mortise strike (each)..... \$51
- Roller latch (each) \$30

ELECTRICAL PREPS:

- Power transfer units (i.e. EPT2, EPT10, etc.)..... \$95
- Electric hinge prep..... \$36
- Electric strike prep \$62
- Door position switch (1¹/₂" to 1" dia.) \$36
- Magnetic switch (rectangular and mortised)..... \$96

NOTES:

1. Power transfers, electric strikes and concealed closers are not available on FN-Series frames.
2. Electric preps come standard with mortar guards on standard profile products, including knock-outs.

 Indicates products that have EPD documentation available and meet LEED v4.

COMPLETE FRAME PRICING

Single Frame		JAMB DEPTH				
Width	Height	3"-5 ⁷ / ₈ "	6"-7 ⁷ / ₈ "	8"-9 ⁷ / ₈ "	10"-11 ⁷ / ₈ "	12"-14 ³ / ₄ "
1'6" thru 3'0"	6'8"	258	266	296	340	385
	7'0"	273	282	306	348	400
	7'2"	278	285	313	351	407
	8'0"	301	313	342	385	435
	9'0"	311	328	353	398	448
Over 3'0" thru 4'0"	10'0"	326	340	369	412	460
	6'8"	263	272	303	348	390
	7'0"	278	288	313	356	405
	7'2"	283	291	320	359	412
	8'0"	306	319	349	393	440
	9'0"	316	334	360	406	453
	10'0"	331	346	376	420	465

Double Frame		JAMB DEPTH				
Width	Height	3"-5 ⁷ / ₈ "	6"-7 ⁷ / ₈ "	8"-9 ⁷ / ₈ "	10"-11 ⁷ / ₈ "	12"-14 ³ / ₄ "
4'0" thru 6'0"	6'8"	311	322	358	401	445
	7'0"	319	332	364	403	451
	7'2"	327	336	372	409	463
	8'0"	363	374	420	459	507
	9'0"	373	398	430	467	515
Over 6'0" thru 8'0"	10'0"	393	406	450	487	531
	6'8"	324	333	367	418	460
	7'0"	332	343	373	420	466
	7'2"	340	347	381	426	478
	8'0"	376	385	429	476	522
Over 8'0" thru 10'0"	9'0"	386	409	439	484	530
	10'0"	406	417	459	504	546
	6'8"	359	374	419	462	515
	7'0"	367	384	425	464	521
	7'2"	375	388	433	470	533
	8'0"	411	426	481	520	577
	9'0"	421	450	491	528	585
	10'0"	441	458	511	548	601

COMPONENT PART PRICING

		JAMB DEPTH				
Part	Height	3"-5 ⁷ / ₈ "	6"-7 ⁷ / ₈ "	8"-9 ⁷ / ₈ "	10"-11 ⁷ / ₈ "	12"-14 ³ / ₄ "
Strike Jamb	6'8"	94	97	107	121	137
	7'0"	105	108	114	128	149
	7'2"	106	109	117	128	150
	8'0"	111	118	122	137	156
	9'0"	116	121	128	146	165
	10'0"	121	129	134	150	169
Hinge Jamb	6'8"	108	111	119	136	153
	7'0"	112	116	122	137	156
	7'2"	116	118	126	140	162
	8'0"	134	137	150	165	184
	9'0"	139	149	155	169	188
	10'0"	149	153	165	179	196
		JAMB DEPTH				
Part	Width	4 ³ / ₄ "-5 ⁷ / ₈ "	6"-7 ⁷ / ₈ "	8"-9 ⁷ / ₈ "	10"-11 ⁷ / ₈ "	12"-12 ³ / ₄ "
Head	Thru 3'0"	56	58	70	83	95
	Thru 4'0"	61	64	77	91	100
	Thru 5'0"	95	100	120	129	139
	Thru 6'0"	95	100	120	129	139
	Thru 8'0"	108	111	129	146	154
	Thru 10'0"	143	152	181	190	209

NOTES:

1. Jamb Depths:

- 4¹/₂" and larger are double rabbet as standard
- 3" thru 4³/₈" are supplied single rabbet
- All frames listed are available in jamb depth increments of 1/8"

2. Door Opening Sizes:

- Standard frame sizes are listed
- Any non-standard frame width and / or height is priced as the next larger size frame category

See page 34 for special size limit.

- Maximum size:

- Single: 4'0" x 10'0"

- Double: 10'0" x 10'0"

3. FN-Series Frames (1" Face):

- Available as double rabbet only
- Weld-in fixed base anchor standard

4. Cased Open Frames:

- Priced as two (2) strike jambs and head from Component Part Pricing
- Weld-in fixed base anchor standard

LABELED FRAMES:	Single	Pair
UL		
• Metal label (includes closer reinf.)	33	48
• 3 hr. in stud partition (includes closer reinf. and stiffeners in head)	43	74
ITS/WHI		
• Metal label (includes closer reinf.)	33	48
• Mylar label (closer reinf. NOT included)	12	24
FM		
• Mylar label (includes closer reinf.)	33	48

Refer to the Steelcraft Tech Data Manual for all labeled approvals.

14 GAUGE FLUSH FRAMES FOR 1³/₄" DOORS

Standard Construction Options: Per frame

GALVANNEALED A-60 STEEL:	Thru 5⁷/₈"	Over 5⁷/₈"
• Complete frame	\$36	\$41
• Per jamb	\$14	\$16
• Per head	\$8	\$9

GALVANIZED G-90 STEEL:	Thru 5⁷/₈"	Over 5⁷/₈"
• Complete frame	\$55	\$65
• Per jamb	\$21	\$24
• Per head	\$13	\$17
• Maximum opening height 9'10"		

4" FACE HEAD:	Thru 4'0"	Over 4'0"
	\$40	\$56

MARK NUMBERSN/C

EQUAL RABBETN/C

DUTCH FRAME:	Non-Labeled	Labeled
	\$39	\$99

COMMUNICATING FRAMES:

- Single openings only \$49
- Specify if doors swing from the same or opposite jambs

SPECIAL PROFILE FRAMES:

- Refer to page 32 for pricing
- Special anchor charges will apply

HOSPITAL SANITARY STOPS (4", 5¹/₂" and 6" high standard):

- Single rabbet 45° only \$147
- Double rabbet 45° \$147
- Double rabbet 90° \$147

ANCHORS (Factory welded or prepped):

	Per frame	
	Thru 9 ¹ / ₈ "	Over 9 ¹ / ₈ "
• Welded-in standard anchors (in lieu of loose)		
• Base	N/C	N/C
• Jambs thru 7'6"	\$30	\$48
• Jambs over 7'6" thru 10'0"	\$40	\$64
• Each additional	\$5	\$8
• EMA (pierce and dimple only)		
• Jambs thru 7'1"	\$20	\$40
• Jambs over 7'1" thru 8'9"	\$25	\$50
• Jambs over 8'9" thru 10'0"	\$30	\$60
• Each additional	\$2.50	\$5
• EMA (pierce, dimple, weld-in anchors with bolts)		
• Jambs thru 7'1"	\$148	\$296
• Jambs over 7'1" thru 8'9"	\$185	\$370
• Jambs over 8'9" thru 10'0"	\$222	\$444
• Each additional	\$18.50	\$37

ANCHORS (Standard loose / lock-in):

- Deletion of anchors (deduct from standard frame price)

	Per jamb	Per frame
• Base	\$2.30	\$4.60
• Jambs thru 7'6"	\$5.65	\$11.30
• Jambs over 7'6"	\$6.95	\$13.90

12 GAUGE HEAD REINFORCING CHANNEL:
(2" face only, full jamb depth) \$150

Standard Hardware Options: Per prep

SPECIAL VERTICAL HARDWARE LOCATIONS:

- Hinge and lockN/C

CLOSERS:

- Surface mounted:
 - 14" strap installed \$16
(specify regular, parallel arm or top jamb)
 - Closer sleeve installed..... \$35
- Concealed in head (per template) \$193
- ALLE Concealed in head (per template) \$175

HINGES:

- 5" Universal in lieu of 4¹/₂"N/C
- Additional hinge prep (4¹/₂" or 5") \$14
- High frequency prep..... \$16
- Continuous Hinge:
 - No reinf. (blank Jamb).....N/C
 - Full length reinf. \$54

STRIKES:

- Additional ASA (4⁷/₈" ANSI A115.1-2) \$14
- Additional Cylindrical (2³/₄" ANSI A115.3)..... \$14
(minimum 7" above or below standard strike)
- Double Cylindrical (2³/₄" on 4" centers) \$27
- Deadlock (non-lip) \$15
- Flushbolts:
 - Steelcraft reversible \$42
 - Standard (ANSI 115.4) \$42
- Surface Bolt reinf. \$20
- Exit Devices:
 - Rim reinf. only \$16
 - Vertical Rod reinf. only \$20
 - Vertical Rod Mortise strike (each)..... \$51
- Roller latch (each) \$30

ELECTRICAL PREPS:

- Power transfer units (i.e. EPT2, EPT10, etc.) \$95
- Electric hinge prep..... \$36
- Electric strike prep \$62
- Door position switch (1/2" to 1" dia.)..... \$36
- Magnetic switch (rectangular and mortised)..... \$96

NOTES:

1. Power transfers, electric strikes and concealed closers are not available on FN-Series frames.
2. Electric preps come standard with mortar guards on standard profile products, including knock-outs.

 Indicates products that have EPD documentation available and meet LEED v4.

COMPLETE FRAME PRICING

Single Frame		JAMB DEPTH				
Width	Height	4 ³ / ₄ "-5 ⁷ / ₈ "	6"-7 ⁷ / ₈ "	8"-9 ⁷ / ₈ "	10"-11 ⁷ / ₈ "	12"-12 ³ / ₄ "
1 ⁶ " thru 3'0"	6' 8"	464	479	558	648	718
	7' 0"	479	501	583	685	760
	7'2"	484	511	586	698	771
	8' 0"	535	558	648	757	850
Over 3'0" thru 4'0"	8'8"	575	605	711	827	934
	6' 8"	482	498	578	667	750
	7' 0"	497	520	603	704	792
	7'2"	502	530	606	717	803
8' 0"	553	577	668	776	882	
	8'8"	593	624	731	846	966

Double Frame		JAMB DEPTH				
Width	Height	4 ³ / ₄ "-5 ⁷ / ₈ "	6"-7 ⁷ / ₈ "	8"-9 ⁷ / ₈ "	10"-11 ⁷ / ₈ "	12"-12 ³ / ₄ "
Over 4'0" thru 6'0"	6' 8"	555	568	652	730	802
	7' 0"	571	590	680	772	856
	7'2"	573	606	682	788	866
	8' 0"	635	656	756	854	952
Over 6'0" thru 8'0"	8'8"	681	698	822	924	1046
	6' 8"	586	603	701	810	915
	7' 0"	602	625	729	852	969
	7'2"	604	641	731	868	979
8' 0"	666	691	805	934	1065	
	8'8"	712	733	871	1004	1159

COMPONENT PART PRICING

		JAMB DEPTH				
Part	Height	4 ³ / ₄ "-5 ⁷ / ₈ "	6"-7 ⁷ / ₈ "	8"-9 ⁷ / ₈ "	10"-11 ⁷ / ₈ "	12"-12 ³ / ₄ "
Strike Jamb	6' 8"	168	173	203	240	271
	7' 0"	175	184	214	256	286
	7'2"	179	186	216	261	292
	8' 0"	199	208	241	287	328
	8'8"	216	234	271	322	365
Hinge Jamb	6' 8"	195	199	229	261	291
	7' 0"	203	210	243	282	318
	7'2"	204	218	244	290	323
	8' 0"	235	243	281	323	366
	8'8"	258	264	314	358	413
		JAMB DEPTH				
Part	Width	4 ³ / ₄ "-5 ⁷ / ₈ "	6"-7 ⁷ / ₈ "	8"-9 ⁷ / ₈ "	10"-11 ⁷ / ₈ "	12"-12 ³ / ₄ "
Head	Thru 3'0"	101	107	126	147	156
	Thru 4'0"	119	126	146	166	188
	Thru 6'0"	165	170	194	208	220
	Thru 8'0"	196	205	243	288	333

NOTES:

1. Jamb are shipped 2" longer and heads 4" longer than nominal door opening size:

- Jamb and head have square ends as standard
- Machine miter and notch not available
- Frames must be saw mitered and welded for final assembly
- Silencer preps are not available

2. Jamb Depths and Profiles:

- All frames are equal rabbet as standard
 - Jamb depths less than 5³/₄" are unequal rabbet
- All frames listed are available in jamb depth increments of 1/8"
- All frames have 3/4" high stops

3. Door Opening Sizes:

- Standard frame sizes are listed
- Any non-standard frame width and / or height is priced as the next larger size frame category
- Maximum size:
 - Single: 4'0" x 8'8"
 - Double: 8'0" x 8'8"
- All members over 8'0" in overall length are supplied as galvanized, add A-60 charges

4. Cased Open Frames:

- Priced as two (2) strike jamb and head from Component Part Pricing
- Weld-in fixed base anchor standard

LABELED FRAMES:	Single	Pair
UL		
• Metal label (includes closer reinf.)	33	48
• 3 hr. in stud partition (includes closer reinf. and stiffeners in head)	43	74
ITS/WHI		
• Metal label (includes closer reinf.)	33	48
• Mylar label (closer reinf. NOT included)	12	24
FM		
• Mylar label (includes closer reinf.)	not available	not available

Refer to the Steelcraft Tech Data Manual for all labeled approvals. F12 Series must be welded from by factory for factory label application.

12 GAUGE FLUSH FRAMES FOR 1³/₄" DOORS

F12-SERIES

FRAMES

Standard Construction Options: Per frame

GALVANNEALED A-60 STEEL:	Thru 5⁷/₈"	Over 5⁷/₈"
• Complete frame	\$98	\$121
• Per jamb	\$39	\$49
• Per head	\$20	\$23

GALVANIZED G-90 STEEL: not available

4" FACE HEAD:	Thru 4'0"	Over 4'0"
	\$40	\$56

MARK NUMBERS: N/C

EQUAL RABBET standard

DUTCH FRAME:	Non-Labeled	Labeled
	\$39	not available

COMMUNICATING FRAMES:

- Single openings only \$49
- Specify if doors swing from the same or opposite jambs

SPECIAL PROFILE FRAMES:

- Refer to page 32 for pricing
- Special anchor charges will apply

HOSPITAL SANITARY STOPS not available

ANCHORS (Factory welded or prepped):

	Per frame	
	Thru 9 ¹ / ₈ "	Over 9 ¹ / ₈ "
• Welded-in standard anchors (in lieu of loose)		
• Base	N/C	N/C
• Jambs thru 7'6"	\$30	\$48
• Jambs over 7'6" thru 10'0"	\$40	\$64
• Each additional	\$5	\$8
• EMA (pierce and dimple only)		
• Jambs thru 7'1"	\$20	\$40
• Jambs over 7'1" thru 8'9"	\$25	\$50
• Jambs over 8'9" thru 10'0"	\$30	\$60
• Each additional	\$2.50	\$5
• EMA (pierce, dimple, weld-in anchors with bolts)		
• Jambs thru 7'1"	\$148	\$296
• Jambs over 7'1" thru 8'9"	\$185	\$370
• Jambs over 8'9" thru 10'0"	\$222	\$444
• Each additional	\$18.50	\$37

ANCHORS (Standard loose / lock-in):

• Deletion of anchors (deduct from standard frame price)		
	Per jamb	Per frame
• Base	\$2.30	\$4.60
• Jambs thru 7'6"	\$5.65	\$11.30
• Jambs over 7'6"	\$6.95	\$13.90

12 GAUGE HEAD REINFORCING CHANNEL not available

Standard Hardware Options: Per prep

SPECIAL VERTICAL HARDWARE LOCATIONS:

- Hinge and lock N/C

CLOSERS:

- Surface mounted
- 14" strap installed \$16
(specify regular, parallel arm or top jamb)
- Concealed in head not available

HINGES:

- 5" Universal in lieu of 4¹/₂" N/C
- Additional hinge prep (4¹/₂" or 5") \$14
- High frequency prep \$16
- Continuous hinge:
 - No reinf. (blank Jamb) N/C
 - Full length reinf. \$54

STRIKES:

- Additional ASA (4⁷/₈" ANSI A115.1-2) \$14
- Additional Cylindrical (2³/₄" ANSI A115.3) \$14
(minimum 7" above or below standard strike)
- Double Cylindrical (2³/₄" on 4" centers) \$27
- Deadlock (non-lip) \$15
- Flushbolts:
 - Steelcraft reversible \$42
 - Standard (ANSI 115.4) \$42
- Exit Devices:
 - Rim reinf. only \$16
 - Vertical Rod reinf. only \$20

ELECTRICAL PREPS:

- Power transfer units (i.e. EPT2, EPT10, etc.) \$95
- Electric hinge prep \$36
- Electric strike prep \$62
- Door position switch (1¹/₂" to 1" dia.) \$36
- Magnetic Switch (rectangular and mortised) \$96

NOTE:

1. Electric preps come standard with mortar guards on standard profile products, including knock-outs.

Prices subject to change without notice.

 Indicates products that have EPD documentation available and meet LEED v4.

COMPLETE FRAME PRICING

Single Frame		JAMB DEPTH				
Width	Height	3 ¹ / ₄ "-5 ⁷ / ₈ "	6"-7 ⁷ / ₈ "	8"-9 ⁷ / ₈ "	10"-11 ⁷ / ₈ "	12"-14 ³ / ₄ "
1 ⁶ " thru 3'0"	6' 8"	224	246	286	330	376
	7' 0"	239	260	298	342	387
	7' 2"	243	265	305	353	399
	8' 0"	268	282	331	378	422
Over 3'0" thru 4'0"	9'0"	292	309	357	409	454
	6' 8"	228	252	296	336	381
	7' 0"	243	266	308	348	392
	7' 2"	247	271	315	359	404
8' 0"	272	288	341	384	427	
	9'0"	296	315	367	415	459

Double Frame		JAMB DEPTH				
Width	Height	3 ¹ / ₄ "-5 ⁷ / ₈ "	6"-7 ⁷ / ₈ "	8"-9 ⁷ / ₈ "	10"-11 ⁷ / ₈ "	12"-14 ³ / ₄ "
4'0" thru 6'0"	6' 8"	265	282	333	387	426
	7' 0"	279	298	343	397	434
	7' 2"	283	304	353	415	454
	8' 0"	321	326	393	453	492
Over 6'0" thru 8'0"	9'0"	347	368	431	497	536
	6' 8"	279	294	349	402	442
	7' 0"	293	310	359	412	450
	7' 2"	297	316	369	430	470
8' 0"	335	338	409	468	508	
	9'0"	361	380	447	512	552

COMPONENT PART PRICING

		JAMB DEPTH				
Part	Height	3 ¹ / ₄ "-5 ⁷ / ₈ "	6"-7 ⁷ / ₈ "	8"-9 ⁷ / ₈ "	10"-11 ⁷ / ₈ "	12"-14 ³ / ₄ "
Strike Jamb	6' 8"	82	92	109	125	143
	7' 0"	90	98	116	132	150
	7' 2"	92	100	118	134	152
	8' 0"	98	106	124	140	156
	9'0"	109	112	131	149	166
Hinge Jamb	6' 8"	93	100	119	135	152
	7' 0"	100	108	124	140	156
	7' 2"	102	111	129	149	166
	8' 0"	121	122	149	168	185
	9'0"	134	143	168	190	207
		JAMB DEPTH				
Part	Width	3 ¹ / ₄ "-5 ⁷ / ₈ "	6"-7 ⁷ / ₈ "	8"-9 ⁷ / ₈ "	10"-11 ⁷ / ₈ "	12"-14 ³ / ₄ "
Head	Thru 3'0"	49	54	58	70	81
	Thru 4'0"	53	60	68	76	86
	Thru 6'0"	79	82	95	117	122
	Thru 8'0"	93	94	111	132	138

NOTES:

1. Jamb Depths:

- 4 1/2" and larger are double rabbet as standard
- 3 1/4" thru 4 3/8" are supplied double rabbet with a 9/16" rabbet on the non-door side
- All frames listed are available in jamb depth increments of 1/8"

2. Door Opening Sizes:

- Standard frame sizes are listed
- Any non-standard frame width and / or height is priced as the next larger size frame category
- Maximum size:
 - Single: 4'0" x 9'0"
 - Double: 8'0" x 9'0"

3. Cased Open Frames:

- Priced as two (2) strike jambs and head from Component Part Pricing
- Weld-in fixed base anchor standard

LABELED FRAMES:	Single	Pair
UL		
• Metal label (includes closer reinf.)	33	48
• 3 hr. in stud partition (includes closer reinf. and stiffeners in head)	43	74
ITS/WHI		
• Metal label (includes closer reinf.)	33	48
• Mylar label (closer reinf. NOT included)	12	24
FM		
• Mylar label (includes closer reinf.)	not available	not available

Refer to the Steelcraft Tech Data Manual for all labeled approvals.

Prices subject to change without notice.

16 GAUGE MULTI-USE FRAMES

FOR 1³/₄" OR 1³/₈" DOORS

MU16-SERIES

FRAMES

Standard Construction Options: Per frame

GALVANNEALED A-60 STEEL:	Thru 5⁷/₈"	Over 5⁷/₈"
• Complete frame	\$36	\$41
• Per jamb	\$14	\$16
• Per head	\$8	\$9

GALVANIZED G-90 STEEL:	Thru 5⁷/₈"	Over 5⁷/₈"
• Complete frame	\$55	\$65
• Per jamb	\$21	\$24
• Per head	\$13	\$17
• Maximum opening height 9'0"		

4" FACE HEAD:	Thru 4'0"	Over 4'0"
	\$40	\$56

MARK NUMBERS N/C

EQUAL RABBET N/C

DUTCH FRAME:	Non-Labeled	Labeled
	\$39	\$99

COMMUNICATING FRAMES:

- Single openings only \$49
- Specify if doors swing from the same or opposite jambs

SPECIAL PROFILE FRAMES:

- Refer to page 32 for pricing
- Special anchor charges will apply

HOSPITAL SANITARY STOPS (4", 5¹/₂" and 6" high standard):

- Single rabbet 45° only \$147
- Double rabbet 45° \$147
- Double rabbet 90° \$147

ANCHORS (Factory welded or prepped):

	Per frame	
	Thru 9 ¹ / ₈ "	Over 9 ¹ / ₈ "
• Welded-in standard anchors (in lieu of loose)		
• Base	N/C	N/C
• Jambs thru 7'6"	\$30	\$48
• Jambs over 7'6" thru 10'0"	\$40	\$64
• Each additional	\$5	\$8
• EMA (pierce and dimple only)		
• Jambs thru 7'1"	\$20	\$40
• Jambs over 7'1" thru 8'9"	\$25	\$50
• Jambs over 8'9" thru 10'0"	\$30	\$60
• Each additional	\$2.50	\$5
• EMA (pierce, dimple, weld-in anchors with bolts)		
• Jambs thru 7'1"	\$148	\$296
• Jambs over 7'1" thru 8'9"	\$185	\$370
• Jambs over 8'9" thru 10'0"	\$222	\$444
• Each additional	\$18.50	\$37

ANCHORS (Standard loose / lock-in):

- Deletion of anchors (deduct from standard frame price)

	Per jamb	Per frame
• Base	\$2.30	\$4.60
• Jambs thru 7'6"	\$5.65	\$11.30
• Jambs over 7'6"	\$6.95	\$13.90

12 GAUGE HEAD REINFORCING CHANNEL:
(2" face only, full jamb depth) \$150

Standard Hardware Options: Per prep

SPECIAL VERTICAL HARDWARE LOCATIONS:

- Hinge and lock N/C

CLOSERS:

- Surface mounted:
 - 14" strap installed \$16
(specify regular, parallel arm or top jamb)
 - Closer sleeve installed \$35
- Concealed in head (per template) \$193
- ALLE Concealed in head (per template) \$175

HINGES:

- 5" Universal in lieu of 4¹/₂" N/C
- Additional hinge prep (4¹/₂" or 5") \$14
- High frequency prep \$16
- Continuous Hinge:
 - No reinf. (blank Jamb) N/C
 - Full length reinf. \$54

STRIKES:

- Additional ASA (4⁷/₈" ANSI A115.1-2) \$14
- Additional Cylindrical (2³/₄" ANSI A115.3) \$14
- Double Cylindrical (2³/₄" on 4" centers) \$27
- Deadlock (non-lip) \$15
- Flushbolts:
 - Steelcraft reversible \$42
 - Standard (ANSI 115.4) \$42
- Surface Bolt reinf. \$20
- Exit Devices:
 - Rim reinf. only \$16
 - Vertical Rod reinf. only \$20
 - Vertical Rod Mortise strike (each) \$51
- Roller latch (each) \$30

ELECTRICAL PREPS:

- Power transfer units (i.e. EPT2, EPT10, etc.) \$95
- Electric hinge prep \$36
- Electric strike prep \$62
- Door position switch (1/2" to 1" dia.) \$36
- Magnetic switch (rectangular and mortised) \$96

NOTE:

1. Electric preps come standard with mortar guards on standard profile products, including knock-outs.

COMPLETE FRAME PRICING

Single Frame		JAMB DEPTH				
Width	Height	3 ¹ / ₄ "-5 ⁷ / ₈ "	6"-7 ⁷ / ₈ "	8"-9 ⁷ / ₈ "	10"-11 ⁷ / ₈ "	12"-14 ³ / ₄ "
1 ⁶ / ₈ " thru 3'0"	6' 8"	276	303	341	382	431
	7' 0"	296	315	361	401	450
	7' 2"	301	327	366	407	459
	8' 0"	324	358	398	441	489
Over 3'0" thru 4'0"	9'0"	347	391	431	472	527
	6' 8"	280	305	344	391	442
	7' 0"	300	317	364	410	461
	7' 2"	305	329	369	416	470
8' 0"	328	360	401	450	500	
	9'0"	351	393	434	481	538

Double Frame		JAMB DEPTH				
Width	Height	3 ¹ / ₄ "-5 ⁷ / ₈ "	6"-7 ⁷ / ₈ "	8"-9 ⁷ / ₈ "	10"-11 ⁷ / ₈ "	12"-14 ³ / ₄ "
4'0" thru 6'0"	6' 8"	329	357	396	437	482
	7' 0"	347	375	420	463	508
	7' 2"	353	387	426	473	524
	8' 0"	383	431	468	517	560
Over 6'0" thru 8'0"	9'0"	405	473	522	567	618
	6' 8"	348	369	411	456	501
	7' 0"	366	387	435	482	527
	7' 2"	372	399	441	492	543
8' 0"	402	443	483	536	579	
	9'0"	424	485	537	586	637

COMPONENT PART PRICING

		JAMB DEPTH				
Part	Height	3 ¹ / ₄ "-5 ⁷ / ₈ "	6"-7 ⁷ / ₈ "	8"-9 ⁷ / ₈ "	10"-11 ⁷ / ₈ "	12"-14 ³ / ₄ "
Strike Jamb	6' 8"	101	116	128	146	165
	7' 0"	112	119	136	152	171
	7' 2"	114	125	138	153	172
	8' 0"	122	134	149	165	184
	9'0"	134	146	155	171	193
Hinge Jamb	6' 8"	116	125	138	153	172
	7' 0"	125	134	150	166	185
	7' 2"	128	140	153	171	193
	8' 0"	143	162	174	193	211
	9'0"	154	183	201	218	240
		JAMB DEPTH				
Part	Width	3 ¹ / ₄ "-5 ⁷ / ₈ "	6"-7 ⁷ / ₈ "	8"-9 ⁷ / ₈ "	10"-11 ⁷ / ₈ "	12"-14 ³ / ₄ "
Head	Thru 3'0"	59	62	75	83	94
	Thru 4'0"	63	64	78	92	105
	Thru 6'0"	97	107	120	131	138
	Thru 8'0"	116	119	135	150	157

NOTES:

1. Jamb Depths:

- 4¹/₂" and larger are double rabbet as standard
- 3¹/₄" thru 4³/₈" are supplied double rabbet with a ⁹/₁₆" rabbet on the non-door side
- All frames listed are available in jamb depth increments of ¹/₈"

2. Door Opening Sizes:

- Standard frame sizes are listed
- Any non-standard frame width and / or height is priced as the next larger size frame category
- Maximum size:
 - Single: 4'0" x 9'0"
 - Double: 8'0" x 9'0"

3. Cased Open Frames:

- Priced as two (2) strike jambs and head from Component Part Pricing
- Weld-in fixed base anchor standard

LABELED FRAMES:	Single	Pair
UL		
• Metal label (includes closer reinf.)	33	48
• 3 hr. in stud partition (includes closer reinf. and stiffeners in head)	43	74
ITS/WHI		
• Metal label (includes closer reinf.)	33	48
• Mylar label (closer reinf. NOT included)	12	24
FM		
• Mylar label (includes closer reinf.)	not available	not available

Refer to the Steelcraft Tech Data Manual for all labeled approvals.

Prices subject to change without notice.

14 GAUGE MULTI-USE FRAMES

FOR 1³/₄" DOORS

MU14-SERIES

FRAMES

Standard Construction Options: Per frame

GALVANNEALED A-60 STEEL:	Thru 5⁷/₈"	Over 5⁷/₈"
• Complete frame	\$36	\$41
• Per jamb	\$14	\$16
• Per head	\$8	\$9

GALVANIZED G-90 STEEL:	Thru 5⁷/₈"	Over 5⁷/₈"
• Complete frame	\$55	\$65
• Per jamb	\$21	\$24
• Per head	\$13	\$17
• Maximum opening height 9'0"		

4" FACE HEAD:	Thru 4'0"	Over 4'0"
	\$40	\$56

MARK NUMBERS N/C

EQUAL RABBET N/C

DUTCH FRAME:	Non-Labeled	Labeled
	\$39	\$99

COMMUNICATING FRAMES:
 • Single openings only \$49
 • Specify if doors swing from the same or opposite jambs

SPECIAL PROFILE FRAMES:
 • Refer to page 32 for pricing
 • Special anchor charges will apply

HOSPITAL SANITARY STOPS (4", 5¹/₂" and 6" high standard):
 • Single rabbet 45° only \$147
 • Double rabbet 45° \$147
 • Double rabbet 90° \$147

ANCHORS (Factory welded or prepped):

	Per frame	
	Thru 9¹/₈"	Over 9¹/₈"
• Welded-in standard anchors (in lieu of loose)		
• Base	N/C	N/C
• Jambs thru 7'6"	\$30	\$48
• Jambs over 7'6" thru 10'0"	\$40	\$64
• Each additional	\$5	\$8
• EMA (pierce and dimple only)		
• Jambs thru 7'1"	\$20	\$40
• Jambs over 7'1" thru 8'9"	\$25	\$50
• Jambs over 8'9" thru 10'0"	\$30	\$60
• Each additional	\$2.50	\$5
• EMA (pierce, dimple, weld-in anchors with bolts)		
• Jambs thru 7'1"	\$148	\$296
• Jambs over 7'1" thru 8'9"	\$185	\$370
• Jambs over 8'9" thru 10'0"	\$222	\$444
• Each additional	\$18.50	\$37

ANCHORS (Standard loose / lock-in):
 • Deletion of anchors (deduct from standard frame price)

	Per jamb	Per frame
• Base	\$2.30	\$4.60
• Jambs thru 7'6"	\$5.65	\$11.30
• Jambs over 7'6"	\$6.95	\$13.90

12 GAUGE HEAD REINFORCING CHANNEL:
 (2" face only, full jamb depth) \$150

Standard Hardware Options: Per prep

SPECIAL VERTICAL HARDWARE LOCATIONS:
 • Hinge and lock N/C

CLOSERS:
 • Surface mounted:
 • 14" strap installed \$16
 (specify regular, parallel arm or top jamb)
 • Closer sleeve installed \$35
 • Concealed in head (per template) \$193
 • ALLE Concealed in head (per template) \$175

HINGES:
 • 5" Universal in lieu of 4¹/₂" N/C
 • Additional hinge prep (4¹/₂" or 5") \$14
 • High frequency prep \$16
 • Continuous hinge:
 • No reinf. (blank Jamb) N/C
 • Full length reinf. \$54

STRIKES:
 • Additional ASA (4⁷/₈" ANSI A115.1-2) \$14
 • Additional Cylindrical (2³/₄" ANSI A115.3) \$14
 (minimum 7" above or below standard strike)
 • Double Cylindrical (2³/₄" on 4" centers) \$27
 • Deadlock (non-lip) \$15
 • Flushbolts:
 • Steelcraft reversible \$42
 • Standard (ANSI 115.4) \$42
 • Surface Bolt reinf. \$20
 • Exit Devices:
 • Rim reinf. only \$16
 • Vertical Rod reinf. only \$20
 • Vertical Rod Mortise strike (each) \$51
 • Roller latch (each) \$30

ELECTRICAL PREPS:
 • Power transfer units (i.e. EPT2, EPT10, etc.) \$95
 • Electric hinge prep \$36
 • Electric strike prep \$62
 • Door position switch (1/2" to 1" dia.) \$36
 • Magnetic switch (rectangular and mortised) \$96

NOTE:
 1. Electric preps come standard with mortar guards on standard profile products, including knock-outs.

FE16 / DE16 COMPLETE FRAME PRICING

JAMB DEPTH						
Width	Height	4 ³ / ₄ "-5 ⁷ / ₈ "	6"-7 ⁷ / ₈ "	8"-9 ⁷ / ₈ "	10"-11 ⁷ / ₈ "	12"-14"
5'0" thru 6'0"	6' 8"	680	695	719	764	805
	7' 0"	682	701	725	772	811
	7'2"	694	703	729	778	815
	8' 0"	726	745	767	808	855
	9'0"	738	763	781	820	865
Over 6'0" thru 8'0"	10' 0"	748	779	793	838	877
	6' 8"	693	705	734	778	825
	7' 0"	695	711	740	786	831
	7'2"	707	713	744	792	835
	8' 0"	739	755	782	822	875
Over 6'0" thru 8'0"	9'0"	751	773	796	834	885
	10' 0"	761	789	808	852	897

FE16 / DE16 COMPONENT PART PRICING

JAMB DEPTH						
Part	Height	4 ³ / ₄ "-5 ⁷ / ₈ "	6"-7 ⁷ / ₈ "	8"-9 ⁷ / ₈ "	10"-11 ⁷ / ₈ "	12"-14"
Hinge Jamb	6' 8"	196	200	207	223	239
	7' 0"	197	203	210	227	242
	7'2"	203	204	212	230	244
	8' 0"	219	225	231	245	264
	9'0"	225	234	238	251	269
	10' 0"	230	242	244	260	275
JAMB DEPTH						
Part	Height	4 ³ / ₄ "-5 ⁷ / ₈ "	6"-7 ⁷ / ₈ "	8"-9 ⁷ / ₈ "	10"-11 ⁷ / ₈ "	12"-14"
Head	Thru 6'0"	288	295	305	318	327
	Thru 8'0"	301	305	320	332	347

FE14 / DE14 COMPLETE FRAME PRICING

JAMB DEPTH						
Width	Height	4 ³ / ₄ "-5 ⁷ / ₈ "	6"-7 ⁷ / ₈ "	8"-9 ⁷ / ₈ "	10"-11 ⁷ / ₈ "	12"-14"
5'0" thru 6'0"	6' 8"	729	738	788	828	869
	7' 0"	743	758	794	830	877
	7'2"	755	762	804	834	887
	8' 0"	789	800	846	882	929
	9'0"	797	816	856	892	937
Over 6'0" thru 8'0"	10' 0"	813	830	872	914	955
	6' 8"	744	753	805	846	885
	7' 0"	758	773	811	848	893
	7'2"	770	777	821	852	903
	8' 0"	804	815	863	900	945
Over 6'0" thru 8'0"	9'0"	812	831	873	910	953
	10' 0"	828	845	889	932	971

FE14 / DE14 COMPONENT PART PRICING

JAMB DEPTH						
Part	Height	4 ³ / ₄ "-5 ⁷ / ₈ "	6"-7 ⁷ / ₈ "	8"-9 ⁷ / ₈ "	10"-11 ⁷ / ₈ "	12"-14"
Hinge Jamb	6' 8"	212	215	231	245	261
	7' 0"	219	225	234	246	265
	7'2"	225	227	239	248	270
	8' 0"	242	246	260	272	291
	9'0"	246	254	265	277	295
	10' 0"	254	261	273	288	304
JAMB DEPTH						
Part	Width	4 ³ / ₄ "-5 ⁷ / ₈ "	6"-7 ⁷ / ₈ "	8"-9 ⁷ / ₈ "	10"-11 ⁷ / ₈ "	12"-14"
Head	Thru 6'0"	305	308	326	338	347
	Thru 8'0"	320	323	343	356	363

NOTES:

1. Jamb Depths and Profiles:

- Right hand FE and DE frames are standard
- Minimum non-labeled jamb depth is 4³/₄"
- Minimum labeled jamb depth is 5³/₄"
- All frames listed are available in jamb depth increments of 1/8"

2. Door Opening Sizes:

- Standard frame sizes are listed
- Any non-standard frame width and / or height is priced as the next larger size frame category
- Maximum size:
 - Double: 8'0" x 10'0"

3. Frame Head Components:

- FE and DE heads are 1/8" undersized in door opening width

4. Double Egress Hinging Applications:

- **FE Series frames** are designed for use with conventional butt hinges. For pocket pivot and swing clear hinging applications special profile and special anchoring charges are applicable
- **DE-Series frames** are designed for use with pocket pivot and / or swing clear hinging applications
 - Must be welded

LABELLED FRAMES:	Pair
UL • Metal label (includes closer reinf.)	48
ITS/WHI • Metal label (includes closer reinf.)	48
FM	not available

Refer to the Steelcraft Tech Data Manual for all labeled approvals.

Prices subject to change without notice.

16 AND 14 GAUGE DOUBLE EGRESS FRAMES FOR 1³/₄" DOORS

Standard Construction Options: **Per frame**

GALVANNEALED A-60 STEEL:	Thru 5⁷/₈"	Over 5⁷/₈"
• Complete frame	\$36	\$41
• Per jamb	\$14	\$16
• Per head	\$8	\$9
GALVANIZED G-90 STEEL:	Thru 5⁷/₈"	Over 5⁷/₈"
• Complete frame	\$55	\$65
• Per jamb	\$21	\$24
• Per head	\$13	\$17
• Maximum opening height 9'10"		

4" FACE HEAD: **Over 4'0"**
\$56

MARK NUMBERS N/C

SPECIAL PROFILE FRAMES:
• Refer to page 32 for pricing
• Special anchor charges will apply

HOSPITAL SANITARY STOPS not available

ANCHORS (Factory welded or prepped):

	Per frame	
	Thru 9¹/₈"	Over 9¹/₈"
• Welded-in standard anchors (in lieu of loose)		
• Base	N/C	N/C
• Jambs thru 7'6"	\$30	\$48
• Jambs over 7'6" thru 10'0"	\$40	\$64
• Each additional	\$5	\$8
• EMA (pierce and dimple only)		
• Jambs thru 7'1"	\$20	\$40
• Jambs over 7'1" thru 8'9"	\$25	\$50
• Jambs over 8'9" thru 10'0"	\$30	\$60
• Each additional	\$2.50	\$5
• EMA (pierce, dimple, weld-in anchors with bolts)		
• Jambs thru 7'1"	\$148	\$296
• Jambs over 7'1" thru 8'9"	\$185	\$370
• Jambs over 8'9" thru 10'0"	\$222	\$444
• Each additional	\$18.50	\$37

ANCHORS (Standard loose, wire masonry):

• Deletion of anchors (deduct from standard frame price)

	Per jamb	Per frame
• Base	\$2.30	\$4.60
• Jambs thru 7'6"	\$5.65	\$11.30
• Jambs over 7'6"	\$6.95	\$13.90

12 GAUGE HEAD REINFORCING CHANNEL:
(2" face only, full jamb depth) \$150

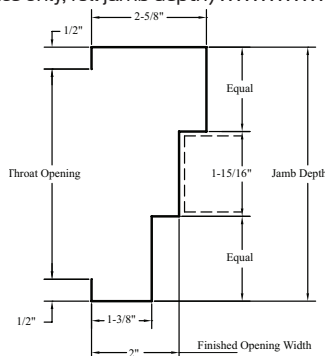

**Jamb Detail
FE**

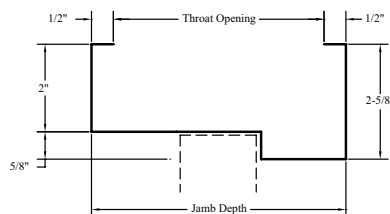

**Head Detail
DE and FE**

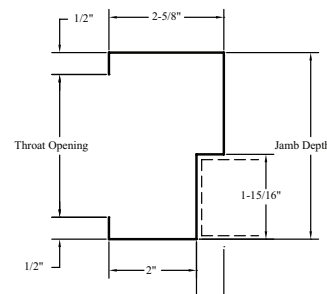

**Jamb Detail
DE**

Standard Hardware Options: **Per prep**

SPECIAL VERTICAL HARDWARE LOCATIONS:
• Hinge and lock N/C

CLOSERS:
• Surface mounted
• 14" strap installed \$16
(specify regular, parallel arm or top jamb)
• Concealed in head (per template) \$193
• ALLE Concealed in head (per template) \$175
(masonry or non-label only)

HINGES:
• 5" Universal in lieu of 4¹/₂" N/C
• Additional hinge prep (4¹/₂" or 5") \$14
• High frequency prep \$16
• Continuous hinge:
• No reinf. (blank Jamb) N/C
• Full length reinf. \$54

STRIKES:
• Exit Devices:
• Vertical Rod reinf. only \$20
• Vertical Rod Mortised strike (each) \$51

ELECTRICAL PREPS:
• Power transfer units (i.e. EPT2, EPT10, etc.) \$95
• Electric hinge prep \$36
• Electric strike prep \$62
• Door position switch (1/2" to 1" dia.) \$36
• Magnetic switch (rectangular and mortised) \$96

NOTE:
1. Electric preps come standard with mortar guards. Standard profile guards will have knock-outs included.
2. Electric preps come standard with mortar guards on standard profile products, including knock-outs.

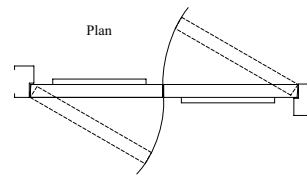

COMPLETE FRAME PRICING

Single Frame		JAMB DEPTH				
Width	Height	3 ¹ / ₄ "-5 ⁷ / ₈ "	6"-7 ⁷ / ₈ "	8"-9 ⁷ / ₈ "	10"-11 ⁷ / ₈ "	12"-14 ³ / ₄ "
1 ⁶ " thru 3'0"	6' 8"	213	241	285	328	373
	7' 0"	230	255	296	341	385
	7' 2"	232	260	304	352	397
	8' 0"	259	277	328	377	420
Over 3'0" thru 4'0"	9'0"	281	301	355	407	452
	6' 8"	222	247	288	335	380
	7' 0"	239	261	299	348	392
	7' 2"	241	266	307	359	404
8' 0"	268	283	331	384	427	
	9'0"	290	307	358	414	459

Double Frame		JAMB DEPTH				
Width	Height	3 ¹ / ₄ "-5 ⁷ / ₈ "	6"-7 ⁷ / ₈ "	8"-9 ⁷ / ₈ "	10"-11 ⁷ / ₈ "	12"-14 ³ / ₄ "
4'0" thru 6'0"	6' 8"	263	282	331	378	422
	7' 0"	279	298	339	390	430
	7' 2"	281	304	351	408	450
	8' 0"	321	326	391	446	488
	9'0"	343	362	431	488	532
Over 6'0" thru 8'0"	6' 8"	277	294	347	393	436
	7' 0"	293	310	355	405	444
	7' 2"	295	316	367	423	464
	8' 0"	335	338	407	461	502
	9'0"	357	374	447	503	546

COMPONENT PART PRICING

		JAMB DEPTH				
Part	Height	3 ¹ / ₄ "-5 ⁷ / ₈ "	6"-7 ⁷ / ₈ "	8"-9 ⁷ / ₈ "	10"-11 ⁷ / ₈ "	12"-14 ³ / ₄ "
Strike Jamb	6' 8"	81	92	109	125	142
	7' 0"	90	98	116	132	150
	7' 2"	91	100	118	134	152
	8' 0"	98	106	122	140	156
	9'0"	109	112	129	149	166
Hinge Jamb	6' 8"	92	100	118	134	152
	7' 0"	100	108	122	140	156
	7' 2"	101	111	128	149	166
	8' 0"	121	122	148	168	185
	9'0"	132	140	168	189	207
		JAMB DEPTH				
Part	Width	3 ¹ / ₄ "-5 ⁷ / ₈ "	6"-7 ⁷ / ₈ "	8"-9 ⁷ / ₈ "	10"-11 ⁷ / ₈ "	12"-14 ³ / ₄ "
Head	Thru 3'0"	40	49	58	69	79
	Thru 4'0"	49	55	61	76	86
	Thru 6'0"	79	82	95	110	118
	Thru 8'0"	93	94	111	125	132

NOTES:

1. Jamb Depths:

- 4¹/₂" and larger are double rabbet as standard
- 3¹/₄" thru 4³/₈" are supplied double rabbet with a ⁹/₁₆" rabbet on the non-door side
- All frames listed are available in jamb depth increments of ¹/₈"

2. Door Opening Sizes:

- Standard frame sizes are listed
- Any non-standard frame width and / or height is priced as the next larger size frame category
- Maximum size:
 - Single: 4'0" x 9'0"
 - Double: 8'0" x 9'0"

3. Anchors:

- Frame prices include one (1) adjustable compression anchor in each jamb
- Jamb depths over 9 ¹/₈" include two (2) compression anchors per jamb
- DW-Series frames include two (2) twist-in base anchors per jamb
- K-Series frames have a countersunk hole in the face of each jamb near the base for fastening to the floor runner (screws not included)

4. Cased Open Frames:

- Priced as two (2) strike jambs and head from Component Part Pricing

LABELED FRAMES:	Single	Pair
UL		
• Metal label (includes closer reinf.)	33	48
ITS/WHI		
• Metal label (includes closer reinf.)	33	48
• Mylar label (closer reinf. NOT included)	12	24
FM		
• Mylar label (includes closer reinf.)	33	48

Refer to the Steelcraft Tech Data Manual for all labeled approvals.

Prices subject to change without notice.

16 GAUGE DRYWALL FRAMES

FOR 1³/₄" OR 1³/₈" DOORS

DW16 and K16-SERIES

FRAMES

Standard Construction Options: Per frame

GALVANNEALED A-60 STEEL:	Thru 5⁷/₈"	Over 5⁷/₈"
• Complete frame	\$36	\$41
• Per jamb	\$14	\$16
• Per head	\$8	\$9
GALVANIZED G-90 STEEL:	Thru 5⁷/₈"	Over 5⁷/₈"
• Complete frame	\$55	\$65
• Per jamb	\$21	\$24
• Per head	\$13	\$17
• Maximum opening height 9'0"		

4" FACE HEAD:	Thru 4'0"	Over 4'0"
	\$40	\$56

MARK NUMBERS N/C

EQUAL RABBET N/C

DUTCH FRAME:
Non-Labeled only \$39

COMMUNICATING FRAMES:
• Single openings only \$49
• Doors must swing from opposite jambs

SPECIAL PROFILE FRAMES:
• Refer to page 32 for pricing

HOSPITAL SANITARY STOPS (4", 5¹/₂" and 6" high standard):
• Double rabbet 45° \$147
• Double rabbet 90° \$147

ANCHORS:
• DW-Series with twist-in base anchors N/C
• K-Series with visible exposed base anchor preps N/C
• Deletion of anchors (deduct from standard frame price)

	Per jamb	Per frame
• DW-Series base	\$2.30	\$4.60

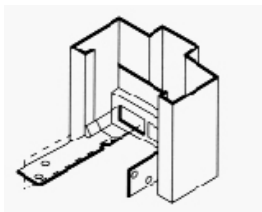

DW Base Anchor

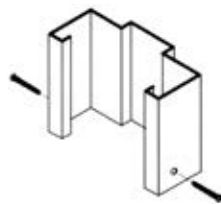

K Base Anchor

12 GAUGE HEAD REINFORCING CHANNEL not available

Standard Hardware Options: Per prep

SPECIAL VERTICAL HARDWARE LOCATIONS:
• Hinge and lock N/C

CLOSERS:
• Surface mounted:
• 14" strap installed \$16
(specify regular, parallel arm or top jamb)
• Closer sleeve installed \$35
• Concealed in head (per template) \$193
• ALLE Concealed in head (per template) \$175

HINGES:
• 5" standard or heavy weight in lieu of 4¹/₂" N/C
• 4¹/₂" or 5" Universal in lieu of standard weight N/C
• Additional hinge prep (4¹/₂" or 5") \$14
• High frequency prep \$16
• Continuous hinge:
• No reinf. (blank Jamb) N/C
• Full length reinf. \$54

STRIKES:
• Additional ASA (4⁷/₈" ANSI A115.1-2) \$14
• Additional Cylindrical (2¹/₄" ANSI A115.3) \$14
(minimum 7" above or below standard strike)
• Double Cylindrical (2¹/₄" on 4" centers) \$27
• Deadlock (non-lip) \$15
• Flushbolts:
• Steelcraft reversible \$42
• Standard (ANSI 115.4) \$42
• Surface Bolt reinf. \$20
• Exit Devices:
• Rim reinf. only \$16
• Vertical Rod reinf. only \$20
• Vertical Rod Mortise strike (each) \$51
• Roller latch (each) \$30

ELECTRICAL PREPS:
• Power transfer units (i.e. EPT2, EPT10, etc.) \$95
• Electric hinge prep \$36
• Electric strike prep \$62
• Door position switch (1¹/₂" to 1" dia.) \$36
• Magnetic switch (rectangular and mortised) \$96

Prices subject to change without notice.

COMPLETE FRAME PRICING

Single Frame		JAMB DEPTH				
Width	Height	3 ¹ / ₄ "-5 ⁷ / ₈ "	6"-7 ⁷ / ₈ "	8"-9 ⁷ / ₈ "	10"-11 ⁷ / ₈ "	12"-14 ³ / ₄ "
1 ⁶ / ₂ " thru 3'0"	6' 8"	273	301	336	376	431
	7' 0"	292	314	358	399	447
	7' 2"	298	328	367	403	458
	8' 0"	319	357	402	434	488
Over 3'0" thru 4'0"	9'0"	343	389	427	468	525
	6' 8"	277	309	339	385	437
	7' 0"	296	322	361	408	453
	7' 2"	302	336	370	412	464
8' 0"	323	365	405	443	494	
	9'0"	347	397	430	477	531

Double Frame		JAMB DEPTH				
Width	Height	3 ¹ / ₄ "-5 ⁷ / ₈ "	6"-7 ⁷ / ₈ "	8"-9 ⁷ / ₈ "	10"-11 ⁷ / ₈ "	12"-14 ³ / ₄ "
4'0" thru 6'0"	6' 8"	329	357	394	437	487
	7' 0"	347	377	422	467	507
	7' 2"	355	393	426	473	523
	8' 0"	381	431	480	511	557
	9'0"	403	473	518	567	619
Over 6'0" thru 8'0"	6' 8"	348	369	405	452	503
	7' 0"	366	389	433	482	523
	7' 2"	374	405	437	488	539
	8' 0"	400	443	491	526	573
	9'0"	422	485	529	582	635

COMPONENT PART PRICING

		JAMB DEPTH				
Part	Height	3 ¹ / ₄ "-5 ⁷ / ₈ "	6"-7 ⁷ / ₈ "	8"-9 ⁷ / ₈ "	10"-11 ⁷ / ₈ "	12"-14 ³ / ₄ "
Strike Jamb	6' 8"	102	116	128	144	165
	7' 0"	112	119	136	152	171
	7' 2"	114	125	143	153	174
	8' 0"	122	135	151	165	187
	9'0"	135	146	157	171	193
Hinge Jamb	6' 8"	116	125	138	153	175
	7' 0"	125	135	152	168	185
	7' 2"	129	143	154	171	193
	8' 0"	142	162	181	190	210
	9'0"	153	183	200	218	241
		JAMB DEPTH				
Part	Width	3 ¹ / ₄ "-5 ⁷ / ₈ "	6"-7 ⁷ / ₈ "	8"-9 ⁷ / ₈ "	10"-11 ⁷ / ₈ "	12"-14 ³ / ₄ "
Head	Thru 3'0"	55	60	70	79	91
	Thru 4'0"	59	68	73	88	97
	Thru 6'0"	97	107	118	131	137
	Thru 8'0"	116	119	129	146	153

NOTES:

1. Jamb Depths:

- 4¹/₂" and larger are double rabbet as standard
- 3¹/₄" thru 4³/₈" are supplied double rabbet with a ⁹/₁₆" rabbet on the non-door side
- All frames listed are available in jamb depth increments of ¹/₈"

2. Door Opening Sizes:

- Standard frame sizes are listed
- Any non-standard frame width and / or height is priced as the next larger size frame category
- Maximum size:
 - Single: 4'0" x 9'0"
 - Double: 8'0" x 9'0"

3. Anchors:

- Frame prices include one (1) adjustable compression anchor in each jamb
- Jamb depths over 9 ¹/₈" include two (2) compression anchors per jamb
- DW-Series frames include two (2) twist-in base anchors per jamb
 - K-Series frames have a countersunk hole in the face of each jamb near the base for fastening to the floor runner (screws not included)

4. Casework Frames:

- Priced as two (2) strike jambs and head from Component Part Pricing

LABELED FRAMES:	Single	Pair
UL		
• Metal label (includes closer reinf.)	33	48
ITS/WHI		
• Metal label (includes closer reinf.)	33	48
• Mylar label (closer reinf. NOT included)	12	24
FM		
• Mylar label (includes closer reinf.)	33	48

Refer to the Steelcraft Tech Data Manual for all labeled approvals.

Prices subject to change without notice.

14 GAUGE DRYWALL FRAMES FOR 1³/₄" DOORS

Standard Construction Options: Per frame

GALVANNEALED A-60 STEEL:	Thru 5⁷/₈"	Over 5⁷/₈"
• Complete frame	\$36	\$41
• Per jamb	\$14	\$16
• Per head	\$8	\$9
GALVANIZED G-90 STEEL:	Thru 5⁷/₈"	Over 5⁷/₈"
• Complete frame	\$55	\$65
• Per jamb	\$21	\$24
• Per head	\$13	\$17
• Maximum opening height 9'0"		

4" FACE HEAD:	Thru 4'0"	Over 4'0"
	\$40	\$56

MARK NUMBERS N/C

EQUAL RABBET N/C

DUTCH FRAME:
Non-Labeled only \$39

COMMUNICATING FRAMES:
• Single openings only \$49
• Doors must swing from opposite jambs

SPECIAL PROFILE FRAMES:
• Refer to page 32 for pricing

HOSPITAL SANITARY STOPS (4", 5¹/₂" and 6" high standard):
• Double rabbet 45° \$147
• Double rabbet 90° \$147

ANCHORS:
• DW-Series with twist-in base anchors N/C
• K-Series with visible exposed base anchor preps N/C
• Deletion of anchors (deduct from standard frame price)

	Per jamb	Per frame
• DW-Series base	\$2.30	\$4.60

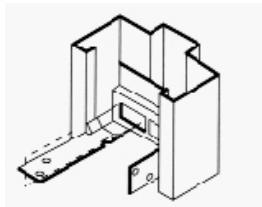

DW Base Anchor

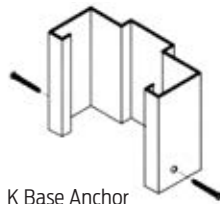

K Base Anchor

12 GAUGE HEAD REINFORCING CHANNEL not available

Standard Hardware Options: Per prep

SPECIAL VERTICAL HARDWARE LOCATIONS:
• Hinge and lock N/C

CLOSERS:
• Surface mounted
• 14" strap installed \$16
(specify regular, parallel arm or top jamb)
• Closer sleeve installed \$35
• Concealed in head (per template) \$193
• ALLE Concealed in head (per template) \$175

HINGES:
• 5" standard or heavy weight in lieu of 4¹/₂" N/C
• 4¹/₂" or 5" Universal in lieu of standard weight N/C
• Additional hinge prep (4¹/₂" or 5") \$14
• High frequency prep \$16
• Continuous hinge:
• No reinf. (blank Jamb) N/C
• Full length reinf. \$54

STRIKES:
• Additional ASA (4⁷/₈" ANSI A115.1-2) \$14
• Additional Cylindrical (2³/₄" ANSI A115.3) \$14
(minimum 7" above or below standard strike)
• Double Cylindrical (2³/₄" on 4" centers) \$27
• Deadlock (non-lip) \$15
• Flushbolts:
• Steelcraft reversible \$42
• Standard (ANSI 115.4) \$42
• Surface Bolt reinf. \$20
• Exit Devices:
• Rim reinf. only \$16
• Vertical Rod reinf. only \$20
• Vertical Rod Mortise strike (each) \$51
• Roller latch (each) \$30

ELECTRICAL PREPS:
• Power transfer units (i.e. EPT2, EPT10, etc.) \$95
• Electric hinge prep \$36
• Electric strike prep \$62
• Door position switch (1/2" to 1" dia.) \$36
• Magnetic switch (rectangular and mortised) \$96

Prices subject to change without notice.

FRAME PROFILES

Standard Frame Parameters

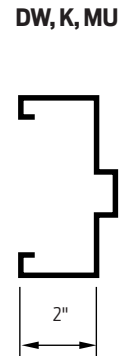
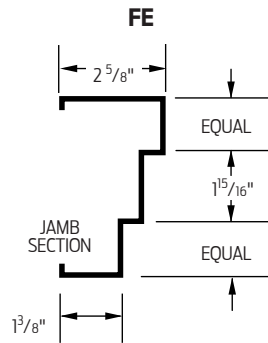
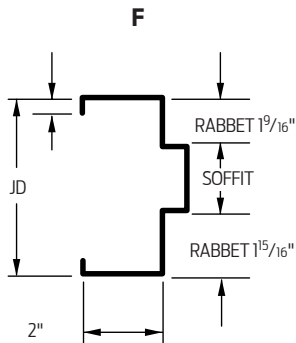

1. F-Series frames are double rabbeted when soffit dimensions are:
 - a) 1 1/4" or more on label frames with masonry strap anchors
 - b) 1 1/4" or more on label frames with existing wall anchors
 - c) 1" or more on all other F-Series frames
 (Frames will be single rabbet only when necessary, due to above minimum soffit dimensions)

1. Available double rabbet only -see minimum soffit dimensions listed in F-Series frame column
2. Maximum backbends 3/4"

1. Minimum JD 4 3/4" non-label, 5 3/4" label
2. Frames with faces as shown above are supplied with mitered corners and include corner tabs for KD assembly

1. Minimum soffit dimension is 1"
2. Single rabbet frames have one door rabbet and one 9/16" dummy rabbet

UNIT PRICE –

SPECIAL PROFILES: include any one or any combination (where applicable) of the following:

- Special face dimension 1 1/8" thru 2 1/2" max • F (2", 1 1/2" and 1" face standard)
- Special backbend dimension 3/8" thru 1" max • F, FN, DE, FE (1/2" and 7/16" on 5 3/4" frames only)
- Omit backends-SUA only (label and non-label), weld-in anchor (add)
- 3/4" thru 1 1/4" high stops in lieu of standard 5/8" stops
- Add to standard jamb depth frame
- FE jambs with pocket pivots, special profile per jamb

ADD PER FRAME

\$35
\$36

SPECIAL JAMB DEPTH OVER 14 3/4" F, MU, 14 or 16 gauge:

- Whole frame 14 3/4" jamb depth thru 20" jamb depth
- Component part 14 3/4" jamb depth thru 20" jamb depth

\$90
\$30

NOTES:

1. Frames with face dimensions over 2 1/2" must be priced as lineal inch from the Sticks section.
2. Consult factory for frames and profile options not shown above for pricing and availability.

Prices subject to change without notice.

CUSTOM FRAME OPTIONS

SPECIAL DOOR RABBET

	Single	Double
· Doors over 1 ³ / ₄ " thru 3" thick.....	\$188	\$263



NOTES:

1. Applicable frame series: labeled and non-labeled F, FN and MU (16 and 14 gauge only)
2. Includes special backset strike and regular or heavy weight hinge preps
3. Frame must be welded by factory or others
4. Price is for die mitered frame

Total Door frame prep (Model 100)

	Single	Double
· Prep for single and double frames	\$150	\$150

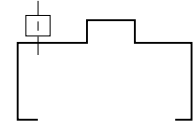

NOTES:

1. F-Series frame: labeled (UL only) and non-labeled
2. Prep includes blank hinge and strike jamb, 5/8" x 5/8" steel tube welded to strike jamb

WELDED FRAMES

	Face weld	Complete profile
· Die mitered corner	\$74	\$135

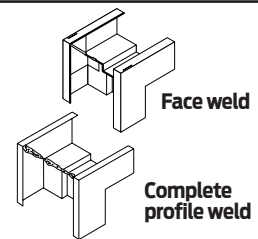

NOTE:

1. Three (3) sided frames: F, FN, FE, DE and MU-Series

LEAD LINED FRAME PREP

	UNIT PRICE PER FRAME
Applicable frame series: F and MU-Series (labeled and non-labeled)	
· Lead clips only (installed in frame throat)	\$125

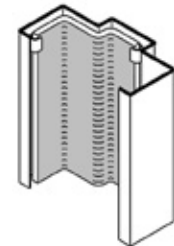

NOTES:

1. Lead furnished and installed by others
2. Wire masonry anchors only (labeled & non-labeled)
3. See Steelcraft Tech Data Manual for further details

POCKET FRAME

	UNIT PRICE PER FRAME
Add to F-Series frame	\$170

NOTE:

1. Weld-in frame anchors are not included in the above price
2. Available KD only from the factory
3. 1/2" back bends only

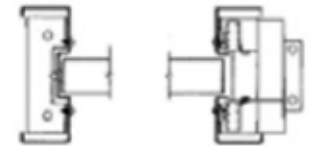

ROUGH BUCK FRAME

	UNIT PRICE PER FRAME
Applicable frame series: F-Series non-labeled only	
· 14 gauge rough buck frame \$29 / lineal foot	
· 14 gauge rough buck end cap (each).....	\$105



NOTES:

1. Rough buck is 14 gauge only. Specify frame as 16 or 14 gauge
2. Add price to F-Series frame price. Refer to the Steelcraft Tech Data Manual for details

EMA "TUBE and STRAP"

	UNIT PRICE PER FRAME	
	Thru 9¹/₈"	Over 9¹/₈"
Pierce, dimple, weld-in anchors with bolts:		
· Jamb thru 7'1"	\$192	\$344
· Jamb over 7'1" thru 8'9".....	\$240	\$430
· Jamb over 8'9" thru 10'0".....	\$288	\$516
· Each additional.....	\$24	\$43

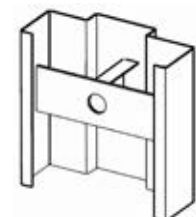

Prices subject to change without notice.

WELDED JAMB END-CAP FILLER**UNIT PRICE PER END**

Applicable standard profile frame series: frame series: F and MU-Series, 16 and 14 gauge

- Saw mitered corner.....\$103
- Square end\$103

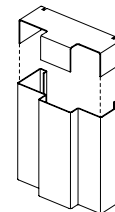
**NAILING STRAP ANCHOR****UNIT PRICE PER FRAME**

Applicable frame series: F and MU-Series, welded-in

- Jambs thru 7'6".....\$30
- Jambs over 7'6"\$40

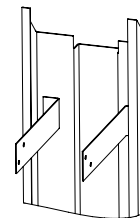
**NAIL FLANGE RETURN****PRICE PER LINEAL INCH**

Applicable frame series: F-Series, 16 and 14 gauge

Add for nailing flange on one or both returns \$0.51

NOTES:

1. Add total lineal inch charge to the applicable frame price
2. When ordering, specify the location of the nailing flange
 - Nailing flange return on door rabbet side
 - Nailing flange return on opposite side of door rabbet
 - Nailing flange return on both sides

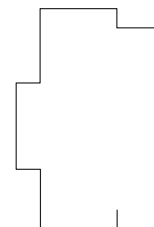
**SPECIAL SIZE (height)****UNIT PRICE PER FRAME**

- Frames over 10'0" thru 11'0".....\$64

NOTES:

1. Add to 10'0" frame price, F-Series only

12 GAUGE REINF. OPTIONS**UNIT PRICE PER PREP**

- Regular, parallel arm or top jamb\$25
- ASA strike (4 7/8" ANSI A115.1-2).....\$45
- Continuous hinge reinf., full length.....\$75

KERFED FRAME OPTION

Integral Kerf Frame (Includes Seal) for Air Infiltration, Weather Seal and Smoke & Draft Control

Available on F, DW, K and MU-Series Frames

UNIT PRICE PER FRAME

- Preparation for Single and Double Frames.....\$123

NOTES:

1. 8'0" x 8'0" max opening size
2. Unequal, equal and single rabbet profiles
3. 16 gauge only

**CONTINUOUS MORTAR GUARD**

Factory installed, 18 gauge, full length mortar guard

Available on F & MU-Series frames.....\$158

Prices subject to change without notice.

WELDED FRAMES AND KD FRAMES

3 Sided Frame 304 Alloy		JAMB DEPTH						
Width	Height	up to 6	over 6 - up to 7	over 7 up to 8	over 8 up to 9	over 9 up to 10	over 10 up to 11	over 11 up to 12
3' 0	7' 0	1,250	1,320	1,390	1,460	1,530	1,590	1,660
3' 0	8' 0	1,350	1,420	1,490	1,560	1,630	1,690	1,760
4' 0	7' 0	1,350	1,420	1,490	1,560	1,630	1,690	1,760
4' 0	8' 0	1,450	1,520	1,590	1,660	1,730	1,790	1,860
5' 0	7' 0	1,500	1,570	1,640	1,710	1,780	1,840	1,910
5' 0	8' 0	1,600	1,670	1,740	1,810	1,880	1,940	2,010
6' 0	7' 0	1,500	1,570	1,640	1,710	1,780	1,840	1,910
6' 0	8' 0	1,600	1,670	1,740	1,810	1,880	1,940	2,010
7' 0	7' 0	1,560	1,630	1,700	1,770	1,840	1,900	1,970
7' 0	8' 0	1,660	1,730	1,800	1,870	1,940	2,000	2,070
8' 0	7' 0	1,640	1,710	1,780	1,850	1,920	1,980	2,050
8' 0	8' 0	1,740	1,810	1,880	1,950	2,020	2,080	2,150

3 Sided Frame 316 Alloy		JAMB DEPTH						
Width	Height	up to 6	over 6 - up to 7	over 7 up to 8	over 8 up to 9	over 9 up to 10	over 10 up to 11	over 11 up to 12
3' 0	7' 0	1,630	1,720	1,810	1,890	1,980	2,070	2,160
3' 0	8' 0	1,760	1,850	1,940	2,020	2,110	2,200	2,290
4' 0	7' 0	1,750	1,840	1,930	2,010	2,100	2,190	2,280
4' 0	8' 0	1,890	1,980	2,070	2,150	2,240	2,330	2,420
5' 0	7' 0	1,930	2,020	2,110	2,190	2,280	2,370	2,460
5' 0	8' 0	2,060	2,150	2,240	2,320	2,410	2,500	2,590
6' 0	7' 0	1,930	2,020	2,110	2,190	2,280	2,370	2,460
6' 0	8' 0	2,060	2,150	2,240	2,320	2,410	2,500	2,590
7' 0	7' 0	2,010	2,100	2,190	2,270	2,360	2,450	2,540
7' 0	8' 0	2,150	2,240	2,330	2,410	2,500	2,590	2,680
8' 0	7' 0	2,100	2,190	2,280	2,360	2,450	2,540	2,630
8' 0	8' 0	2,240	2,330	2,420	2,500	2,590	2,680	2,770

ELEVATION OPTIONS:

- 4" head up to 4' 75
- 4" head up to 8' 100

ANCHOR OPTIONS (all stainless steel):

- Masonry T MT 0
- Wire Anchors MW 0
- Metal Stud MS 0
- Wood Stud WS 0
- Prep for Exp Bolts* XB 250
- * (includes SS bolts)

PROFILE OPTIONS (backbends and cased open):

- double rabbet single return (DRSR) 0
- double rabbet double return (DRDR) 150
- single rabbet single return (SRSR) 0
- single rabbet double return (SRDR) 150
- cased opening single return (COSR) 0
- cased opening double return (CODR) 150

LABEL (Intertek WH):

- up to 3 hours 75

WELDED FRAME CORNERS:

- #4 satin frame face corners are ground smooth to match jambs

DOOR POSITION SWITCH:

- Door position switch (1/2" to 1" dia.) 0

Prices subject to change without notice.

HARDWARE PREP OPTIONS

- HINGES:**
- 4 1/2" Reg Weight (45X) 0
 - 4 1/2" Extra Heavy (H45X) 0
 - 5" Extra Heavy (H50X) 0
 - Continuous Hinge Reinforcement (CH) 0
(drilling and tapping not included)
 - Electric Hinge (EH) 50

- LATCHING:**
- 4 7/8" ASA Strike (ASA) 0
 - 2 3/4" T Strike (T) 0
 - 2 3/4" Deadlock Strike (DL) 0
 - 3 1/2" Deadlock Strike (DLS312) 0
 - 4 7/8" Deadlock Strike (DLS478) 0
 - Electric Strike (ES) 150
 - Rim Exit Device Reinforcement (RE) 0
 - Surface Vertical Rod Exit Device (SVRE) 0
 - ASA Flush Bolts (FB) 0
 - Surface Bolts (SB) 0
 - Surface Closer (CL) 0
 - Surface Overhead Holder/Stop (OS) 0
 - Concealed Closer (CC) 130
 - Concealed Overhead Stop/Holder (COS) 130
 - Concealed Vertical Rod Exit Device (CVRE) 0
 - Electric Power Transfer (EPT) 150

For Custom Options:
 Please call or e-mail request for quote prior to order being placed.
 Customer Care: 1-877-671-7011 (ask for estimating)
 e-mail: Steelcraftestimating@allegion.com

COMPLETE 16 GAUGE FRAME PRICING

Single Frame		JAMB DEPTH				
Width	Height	5 ³ / ₄ "-5 ⁷ / ₈ "	6"-7 ⁷ / ₈ "	8"-9 ⁷ / ₈ "	10"-11 ⁷ / ₈ "	12"-12 ³ / ₄ "
1'6" thru 3'0"	6'8"	974	989	1048	1115	1185
	7'0"	983	998	1060	1129	1202
	7'2"	988	1003	1065	1137	1210
	8'0"	1010	1026	1095	1172	1253
	9'0"	1036	1054	1130	1215	1304
	10'0"	1062	1082	1165	1258	1355
Over 3'0" thru 4'0"	6'8"	988	1003	1065	1137	1210
	7'0"	996	1012	1077	1151	1227
	7'2"	1001	1017	1083	1158	1236
	8'0"	1023	1040	1112	1194	1278
	9'0"	1049	1068	1147	1237	1329
	10'0"	1076	1096	1182	1280	1380

Double Frame		JAMB DEPTH				
Width	Height	5 ³ / ₄ "-5 ⁷ / ₈ "	6"-7 ⁷ / ₈ "	8"-9 ⁷ / ₈ "	10"-11 ⁷ / ₈ "	12"-12 ³ / ₄ "
4'0" thru 6'0"	6'8"	1040	1059	1135	1223	1312
	7'0"	1049	1068	1147	1237	1329
	7'2"	1054	1073	1153	1244	1338
	8'0"	1076	1096	1182	1280	1380
	9'0"	1102	1124	1217	1323	1432
	10'0"	1128	1152	1252	1366	1483
Over 6'0" thru 8'0"	6'8"	1066	1085	1165	1256	1350
	7'0"	1074	1094	1177	1270	1367
	7'2"	1079	1099	1182	1278	1375
	8'0"	1101	1122	1212	1313	1418
	9'0"	1127	1150	1247	1356	1469
	10'0"	1154	1179	1282	1399	1520
Over 8'0" thru 9'8"	6'8"	1065	1085	1168	1262	1359
	7'0"	1073	1094	1179	1276	1376
	7'2"	1078	1099	1185	1283	1385
	8'0"	1100	1122	1214	1319	1427
	9'0"	1126	1150	1249	1362	1478
	10'0"	1153	1178	1284	1405	1530

COMPONENT PART PRICING

		JAMB DEPTH				
Part	Height	5 ³ / ₄ "-5 ⁷ / ₈ "	6"-7 ⁷ / ₈ "	8"-9 ⁷ / ₈ "	10"-11 ⁷ / ₈ "	12"-12 ³ / ₄ "
Strike Jamb	6'8"	332	338	362	389	417
	7'0"	337	343	368	396	425
	7'2"	339	345	370	400	429
	8'0"	350	357	385	417	451
	9'0"	363	371	403	439	476
	10'0"	376	385	420	460	502
Hinge Jamb	6'8"	344	350	374	401	429
	7'0"	349	355	380	408	437
	7'2"	351	357	382	412	441
	8'0"	362	369	397	429	463
	9'0"	375	383	415	451	488
	10'0"	388	397	432	472	514

		JAMB DEPTH				
Part	Width	5 ³ / ₄ "-5 ⁷ / ₈ "	6"-7 ⁷ / ₈ "	8"-9 ⁷ / ₈ "	10"-11 ⁷ / ₈ "	12"-12 ³ / ₄ "
Head	Thru 3'0"	298	301	312	326	339
	Thru 4'0"	311	315	330	347	365
	Thru 5'0"	338	343	365	390	416
	Thru 6'0"	364	371	400	433	467
	Thru 8'0"	377	385	418	454	493
	Thru 9'0"	388	397	432	472	514

NOTES:

General FT (Frame Thermal) information:

- Each component is assembled at the factory (see tech data)
- 3-Sided frames are die-mitered with corner tabs for knocked down (KD) assembly
- Factory welded option is face weld only
- Available in Galvannealed A-60 steel only
- Weld-in anchors welded from factory only

1. Jamb Depths:

- Double Rabbet Profile only
 - Unequal (Std) or Equal Rabbet
 - Single rabbet not available

- All frames listed are available in jamb depth increments of 1/8"

2. Door Opening Sizes:

- Standard frame sizes are listed
- Any non-standard frame width and / or height is priced as the next larger size frame category
- All components listed are available in length increments of 1/8"
- Available sizes:
 - Single: 1'6" x 6'8" thru 4'0" x 10'0"
 - Double: 4'0" x 6'8" thru 9'8" x 10'0"

3. Labeled Frames not available

NOTE:

- 1. *1/2" backbends on all JD including 5-3/4"

Prices subject to change without notice.

Standard Construction Options: Per frame

4" FACE HEAD:	Thru 4'0"	Over 4'0"
	\$40	\$56

MARK NUMBERS (required):	N/C
EQUAL RABBET:	N/C
DUTCH FRAME:	N/A
COMMUNICATING FRAME:	N/A
SPECIAL PROFILE FRAME:	N/A
HOSPITAL SANITARY STOPS:	N/A
SILENCER PREPS:	N/A

ANCHORS (Factory welded only): Per frame/All JD

- Weld-in nailing strap anchors only (indicate single or double layer drywall)
 - Weld-in base (uses FT Anchor as base) N/C
 - Jambs thru 7'6" \$48
 - Jambs over 7'6" thru 8'0" \$64
 - Each additional \$8
- EMA (pierce, dimple, weld-in FT anchors with bolts only)
 - Jambs thru 7'1" \$296
 - Jambs over 7'1" thru 8'0" \$370
 - Each additional location \$37

ANCHORS (Wire masonry loose, base weld-in): Per frame/All JD

- Weld-in base (uses FT Anchor as base) N/C
- Jambs thru 7'6" \$12
- Jambs over 7'6" thru 8'0" \$16

WELDED FRAME:

- Die mitered corner, face weld only \$74

12 GAUGE HEAD REINFORCING CHANNEL:

- (2" face only, full jamb depth) N/A

Standard Hardware Options: Per prep

SPECIAL VERTICAL HARDWARE LOCATIONS:	
• Hinge and strike	N/C

CLOSERS/HOLDERS:

- Surface mounted:
 - 14" (14 gauge) strap installed \$16 (specify regular, parallel arm or top jamb)
 - Closer sleeve installed N/A
- Concealed in head (per template) N/A
- ALLE Concealed in head (per template) N/A
- Shoe bracket in the head (e.g. GJ-104 Holder) \$51

HINGES:

- 5" Universal in lieu of 4 1/2" N/C
- Additional hinge prep (4 1/2" or 5") \$14
- High frequency prep N/A
- Continuous hinge:
 - No reinf. (blank jamb) N/C
 - Full length reinf. \$54

STRIKES:

- Additional ASA (4 7/8" ANSI A115.1-2) \$14
- Additional Cylindrical (2 3/4" ANSI A115.3) \$14 (minimum 7" above or below standard strike)
- Double cylindrical (2 3/4") on 4" centers \$27
- Deadlock (non-lip) \$15
- Flushbolts:
 - Steelcraft reversible \$42
 - Standard (ANSI 115.4) \$42
- Surface Bolt reinf. \$20
- Exit Devices:
 - Rim reinf. only \$16
 - Vertical Rod reinf. only \$20
- Vertical Rod Mortise strike (each) N/A (see tech data for soffit mounted hardware restrictions)

ELECTRICAL PREPS:

- Power transfer units (i.e. EPT2, EPT10, etc.) \$95
- Electric hinge prep \$36
- Electric strike prep \$62
- Door position switch (1/2" or 1" dia.) \$36
- Magnetic switch (rectangular and mortised) N/A

NOTES:

1. Electric preps come standard with mortar guards
2. Avoid or take special care where hardware might interfere with the soffit, stop, and weather stripping; installation may be limited. On this page, certain options are omitted or listed as N/A where most hardware choices will cause problems. See technical data sheets for additional information.
3. Anchors
 - No default; anchors must be specified when ordered
 - EMA is not offered as punch and dimple only
 - To maintain thermal break and strength, all FT frames with welded anchors have 2 anchors at each vertical location (1 in each rabbet)

Prices subject to change without notice.

COMPLETE 14 GAUGE FRAME PRICING						
Single Frame		JAMB DEPTH				
Width	Height	5 ³ / ₄ "-5 ⁷ / ₈ "	6"-7 ⁷ / ₈ "	8"-9 ⁷ / ₈ "	10"-11 ⁷ / ₈ "	12"-12 ³ / ₄ "
1'6" thru 3'0"	6'8"	1017	1052	1125	1166	1264
	7'0"	1027	1063	1139	1182	1284
	7'2"	1032	1069	1147	1190	1294
	8'0"	1057	1097	1182	1230	1343
	9'0"	1088	1132	1225	1277	1402
10'0"	1118	1166	1268	1325	1461	
Over 3'0" thru 4'0"	6'8"	1032	1069	1147	1190	1294
	7'0"	1042	1080	1161	1206	1313
	7'2"	1047	1086	1168	1214	1323
	8'0"	1072	1115	1204	1254	1373
	9'0"	1103	1149	1247	1301	1432
10'0"	1133	1183	1290	1349	1491	

Double Frame		JAMB DEPTH				
Width	Height	5 ³ / ₄ "-5 ⁷ / ₈ "	6"-7 ⁷ / ₈ "	8"-9 ⁷ / ₈ "	10"-11 ⁷ / ₈ "	12"-12 ³ / ₄ "
4'0" thru 6'0"	6'8"	1093	1138	1233	1285	1412
	7'0"	1103	1149	1247	1301	1432
	7'2"	1108	1155	1254	1309	1442
	8'0"	1133	1183	1290	1349	1491
	9'0"	1163	1218	1333	1397	1550
10'0"	1193	1252	1376	1445	1610	
Over 6'0" thru 8'0"	6'8"	1119	1166	1265	1320	1453
	7'0"	1129	1177	1279	1336	1472
	7'2"	1134	1183	1287	1344	1482
	8'0"	1159	1211	1322	1384	1532
	9'0"	1189	1246	1365	1432	1591
10'0"	1220	1280	1408	1479	1650	
Over 8'0" thru 9'8"	6'8"	1120	1169	1272	1329	1466
	7'0"	1130	1180	1286	1345	1486
	7'2"	1135	1186	1293	1353	1496
	8'0"	1161	1215	1329	1393	1545
	9'0"	1191	1249	1372	1441	1605
10'0"	1221	1283	1415	1488	1664	

COMPONENT PART PRICING						
JAMB DEPTH						
Width	Height	5 ³ / ₄ "-5 ⁷ / ₈ "	6"-7 ⁷ / ₈ "	8"-9 ⁷ / ₈ "	10"-11 ⁷ / ₈ "	12"-12 ³ / ₄ "
Strike Jamb	6'8"	349	363	393	409	449
	7'0"	354	369	400	417	458
	7'2"	357	372	404	421	463
	8'0"	369	386	421	441	488
	9'0"	385	403	443	465	518
	10'0"	400	420	464	489	547
Hinge Jamb	6'8"	360	374	404	420	460
	7'0"	365	380	411	428	469
	7'2"	368	383	415	432	474
	8'0"	380	397	432	452	499
	9'0"	396	414	454	476	529
	10'0"	411	431	475	500	558

JAMB DEPTH						
Part	Width	5 ³ / ₄ "-5 ⁷ / ₈ "	6"-7 ⁷ / ₈ "	8"-9 ⁷ / ₈ "	10"-11 ⁷ / ₈ "	12"-12 ³ / ₄ "
Head	Thru 3'0"	307	314	329	337	356
	Thru 4'0"	323	331	350	360	385
	Thru 5'0"	353	366	393	408	445
	Thru 6'0"	383	400	436	456	504
	Thru 8'0"	398	417	457	480	534
	Thru 9'10"	411	431	475	500	558

NOTES:**General FT (Frame Thermal) information:**

- Each component is assembled at the factory (see tech data)
- 3-Sided frames are die-mitered with corner tabs for knocked down (KD) assembly
- Factory welded option is face weld only
- Available in Galvannealed A-60 steel only
- Weld-in anchors welded from factory only

1. Jamb Depths:

- Double Rabbet Profile only
 - Unequal (Std) or Equal Rabbet
 - Single rabbet not available

- All frames listed are available in jamb depth increments of 1/8"

2. Door Opening Sizes:

- Standard frame sizes are listed
- Any non-standard frame width and / or height is priced as the next larger size frame category
- All components listed are available in length increments of 1/8"
- Available sizes:
 - Single: 1'6" x 6'8" thru 4'0" x 10'0"
 - Double: 4'0" x 6'8" thru 9'8" x 10'0"

3. Labeled Frames not available**NOTE:**

1. *1/2" backbends on all JD including 5-3/4"

Prices subject to change without notice.

Standard Construction Options: Per frame

4" FACE HEAD:	Thru 4'0"	Over 4'0"
	\$40	\$56

MARK NUMBERS (required):	N/C
EQUAL RABBET:	N/C
DUTCH FRAME:	N/A
COMMUNICATING FRAME:	N/A
SPECIAL PROFILE FRAME:	N/A
HOSPITAL SANITARY STOPS:	N/A
SILENCER PREPS:	N/A

ANCHORS (Factory welded only): Per frame/All JD

- Weld-in nailing strap anchors only (indicate single or double layer drywall)
 - Weld-in base (uses FT Anchor as base) N/C
 - Jambs thru 7'6" \$48
 - Jambs over 7'6" thru 8'0" \$64
 - Each additional \$8
- EMA (pierce, dimple, weld-in FT anchors with bolts only)
 - Jambs thru 7'1" \$296
 - Jambs over 7'1" thru 8'0" \$370
 - Each additional location \$37

ANCHORS (Wire masonry loose, base weld-in): Per frame/All JD

- Weld-in base (uses FT Anchor as base) N/C
- Jambs thru 7'6" \$12
- Jambs over 7'6" thru 8'0" \$16

WELDED FRAME:

- Die mitered corner, face weld only \$74

12 GAUGE HEAD REINFORCING CHANNEL:

- (2" face only, full jamb depth) N/A

Standard Hardware Options: Per prep**SPECIAL VERTICAL HARDWARE LOCATIONS:**

- Hinge and strike N/C

CLOSERS/HOLDERS:

- Surface mounted:
 - 14" (14 gauge) strap installed \$16 (specify regular, parallel arm or top jamb)
 - Closer sleeve installed N/A
- Concealed in head (per template) N/A
- ALLE Concealed in head (per template) N/A
- Shoe bracket in the head (e.g. GJ-104 Holder) \$51

HINGES:

- 5" Universal in lieu of 4 1/2" N/C
- Additional hinge prep (4 1/2" or 5") \$14
- High frequency prep N/A
- Continuous hinge:
 - No reinf. (blank jamb) N/C
 - Full length reinf. \$54

STRIKES:

- Additional ASA (4 7/8" ANSI A115.1-2) \$14
- Additional Cylindrical (2 3/4" ANSI A1115.3) \$14 (minimum 7" above or below standard strike)
- Double cylindrical (2 3/4") on 4" centers \$27
- Deadlock (non-lip) \$15
- Flushbolts:
 - Steelcraft reversible \$42
 - Standard (ANSI 115.4) \$42
- Surface Bolt reinf. \$20
- Exit Devices:
 - Rim reinf. only \$16
 - Vertical Rod reinf. only \$20
 - Vertical Rod Mortise strike (each) N/A (see tech data for soffit mounted hardware restrictions)

ELECTRICAL PREPS:

- Power transfer units (i.e. EPT2, EPT10, etc.) \$95
- Electric hinge prep \$36
- Electric strike prep \$62
- Door position switch (1/2" or 1" dia.) \$36
- Magnetic switch (rectangular and mortised) N/A

NOTES:

1. Electric preps come standard with mortar guards
2. Avoid or take special care where hardware might interfere with the soffit, stop, and weather stripping; installation may be limited. On this page, certain options are omitted or listed as N/A where most hardware choices will cause problems. See technical data sheets for additional information.
3. Anchors
 - No default; anchors must be specified when ordered
 - EMA is not offered as punch and dimple only
 - To maintain thermal break and strength, all FT frames with welded anchors have 2 anchors at each vertical location (1 in each rabbet)

Prices subject to change without notice.

TABLE OF CONTENTS

DOOR PRODUCT INFORMATION.....43

FULL FLUSH DOORS

L-Series..... 44
SL-Series 46
B-Series..... 48
T-Series..... 50
LS-Series 68
SZ-Series 69

EMBOSSED PANEL DOORS

CE-Series 52

FULL GLASS ENTRANCE DOORS

A14-Series 54

STORM RESISTANT DOORS

H-Series Hurricane Resistant..... 56
Paladin™-Series Tornado Resistant Doors and Frames..... 58

INTEGRATED DOOR SYSTEM

INPACT™ Doors..... 62

GLASS LIGHTS

Standard Light Sizes 64
Factory Installed Kits 65

CUSTOM DOORS OPTIONS

GRAINTECH™ 66
Construction Options and Finish Paint 67

Prices subject to change without notice.

DOOR PRICING GUIDELINES AND POLICIES: The following guidelines and policies are followed when applying pricing to doors. Refer to the following price pages for the appropriate door series and options. Product specific price pages will override information printed on this page below and are subject to change without notice.

GENERAL:

Doors are supplied standard with factory applied primer, visible edge seams, beveled vertical edges and prepared for the noted hardware. Standard cores and options are as follows:

- L-Series: standard core is honeycomb
 - Option: polystyrene, polyurethane
- SL-Series: standard core is honeycomb, square vertical edges
 - Option: polystyrene
- B-Series: standard core is welded steel stiffeners with fiberglass batt insulation
 - Option: STC - Stiffened
- T-Series: standard core is mineral board
 - Option: none
- CE-Series: standard core is polystyrene
 - Option: none
- A14-Series: standard core is honeycomb
 - Option: none
- H-Series: standard core is honeycomb
 - Option: polystyrene, polyurethane welded steel stiffeners, mineral board
- Paladin™-Series: standard core is welded steel stiffeners
 - Option: none
- INPACT™ Integrated Door System: standard core is honeycomb
 - Option: polystyrene, polyurethane
- LS-Series: standard core is polystyrene
 - See LS section for any and all standards and options
- SZ-Series: Limited offering
 - See SZ section for any and all standards and options

SINGLE DOOR – HARDWARE PREPS:

The following hardware prep options are standard and included in single door pricing:

1. Hinge preps:

- Standard prep at no charge:
 - 4 1/2" Universal hinge preps
- Optional preps at no charge:
 - Blank hinge – no preps, no reinf.
 - 5" Universal hinge preps
 - Continuous hinge - no reinforcing standard
- Optional hinge preps with an up charge:
 - Refer to the individual price pages and the hardware preps section of this price book
- Number of hinges based on door height:
 - 2 hinges – up to 5'0" high
 - 3 hinges – up to and including 7'6" high
 - 4 hinges – over 7'6" high

2. Lock prep (one prep included):

- Standard prep at no charge:
 - Cylindrical / Bored lock - 161, 61L
 - Mortise lock - 86, 86ED
 - Blank lock – no prep, no reinf.
- Optional preps at no charge:
 - Cylindrical / Bored lock - 161ED
 - Mortise lock - sectional trim per template (ANSI A115.1)
 - Deadlock in lieu of standard lock
 - Cylindrical / Bored 161 or 160-4
 - Mortise 86

PAIRS OF DOOR – HARDWARE PREPS:

Price as two (2) single doors and add the appropriate pair charge which includes standard hardware locking preps and a standard astragal. The following options are standard and included in pricing for pairs of door:

1. Hinge preps – both leaves:

- Standard and optional preps same as single doors
- Number of hinges same as single doors

2. Active leaf lock prep:

- Standard and optional preps same as single doors

3. Inactive leaf prep:

NOTE: Due to hardware and astragal applications the inactive leaf options carry an up charge. Refer to the appropriate door series for further information.

- Standard preps with added pair charge
 - Locking / latching hardware with Z-Astragal included in pair of door charge:
 - Two (2) ANSI Flushbolt preps, one (1) 4 7/8" ANSI strike with Z-Astragal
 - Two (2) Surface Bolt reinf., one (1) 4 7/8" ANSI strike with Z-Astragal
 - Locking / latching hardware without an astragal included in pair of door charge:
 - Wide inactive leaf
 - Two (2) mortised ANSI Flushbolt preps, one (1) 4 7/8" ANSI strike
 - Two (2) Surface Bolt reinf., one (1) 4 7/8" ANSI strike

FLUSH DOOR PRICING

Door Width	20 GA.	18 GA.	16 GA.	14 GA.
UP TO 6'8" HIGH				
1'6" thru 2'8"	539	604	733	894
Over 2'8" thru 3'0"	562	616	768	945
Over 3'0" thru 3'6"	-	758	868	1,031
Over 3'6" thru 4'0"	-	827	925	1,067
UP TO 7'0" HIGH				
1'6" thru 2'8"	557	627	761	964
Over 2'8" thru 3'0"	583	643	792	1,004
Over 3'0" thru 3'6"	-	789	910	1,074
Over 3'6" thru 4'0"	-	853	948	1,106
UP TO 7'2" HIGH				
1'6" thru 2'8"	603	697	781	1,011
Over 2'8" thru 3'0"	639	726	815	1,034
Over 3'0" thru 3'6"	-	804	916	1,123
Over 3'6" thru 4'0"	-	919	1,045	1,212
UP TO 8'0" HIGH				
1'6" thru 2'8"	795	889	1,004	1,239
Over 2'8" thru 3'0"	815	912	1,034	1,268
Over 3'0" thru 3'6"	-	1,021	1,119	1,327
Over 3'6" thru 4'0"	-	1,101	1,147	1,338
UP TO 9'0" HIGH				
1'6" thru 3'0"	-	1,187	1,212	1,630
Over 3'0" thru 3'6"	-	1,320	1,397	1,642
Over 3'6" thru 4'0"	-	1,404	1,531	1,715
UP TO 10'0" HIGH				
1'6" thru 3'0"	-	1,328	1,470	1,669
Over 3'0" thru 4'0"	-	1,462	1,566	1,796

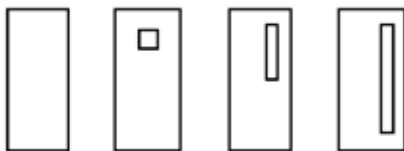

F V N, N3, N4, N5 LNL

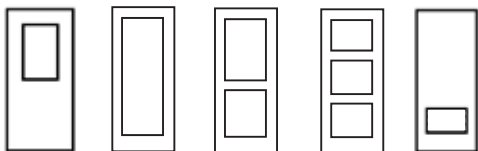

G FG FG2 FG3 LOUVER CUTOUT

Typical Elevations

NOTES:

1. Minimum size 1'6" x 2'0" / maximum size 4'0" x 10'0".
2. 20 gauge max size 3'0" x 8'0".
3. All FG door designs require full perimeter channels, max size 4'0" x 8'0". FG, FG2 and FG3 not available in 20 gauge.
4. Von Duprin 338 Filler Plate (Package Number 1205) may be required with use of existing frame in some applications. Refer to the Parts Section for package quantity and pricing.

Standard Construction Options:

Per leaf

PAIRS OF DOORS OR INACTIVE LEAVES (price pairs of doors as 2 single leaves):

- Conventional locking / latching hardware - add per pair \$86
 - **With Astragal** – Includes ANSI Flushbolt prep or Surface Bolt reinf. and 4 7/8" ANSI strike
 - **Without Astragal** – Includes wide inactive leaf, ANSI Flushbolt prep, or Surface Bolt reinf. and 4 7/8" ANSI strike
- Exit hardware and push pull without astragal - add per pair
 - Standard inactive leaf door width sizes N/C
 - Wide inactive leaf \$86
 - Add all appropriate hardware prep charges

GLASS LIGHTS: Designer Trim for 1/4" or 1/2" thick glass (1/4" standard):

- Standard size V, N3, N4 or N5 \$148
- Standard size G, N, LNL \$188
- Full Glass (FG) non-label only \$254
- Full Glass (FG2) label and non-label \$381
- Full Glass (FG3) label and non-label \$572
- Special size and glass thicknesses refer to page 65

LIGHT / LOUVER CUTOUTS ONLY (per cutout):

- Non-labeled cutout only \$35
- Labeled and non-labeled cutout with channels \$112

NON-STANDARD SIZE WIDTHS and HEIGHTS price as next larger size door

CORE MATERIAL OPTIONS:

- Honeycomb standard
- Polystyrene \$27
- Polyurethane (non-labeled only) \$127

GALVANNEALED A-60 STEEL \$79

GALVANIZED G-90 STEEL \$313

- 18, 16 or 14 gauge only
- Maximum 3'8" x 10'0" door size

EDGE SEAM CONSTRUCTION OPTION:

- LF (Filled) \$69
- LW (Welded) 18, 16 and 14 gauge doors only \$100

UNDERCUT / FLOOR CLEARANCE (3/4" standard):

- Under 3/8" price as next larger size

TOP CAPS FACTORY INSTALLED:

- Screw-in (top or bottom) \$21

MARK NUMBERS N/C

DUTCH DOOR (shelf not included, shipped loose):

- Non-label \$230
- Label 16 or 18 gauge (add to a labeled door price) \$308
- Half shelf \$284
- Full shelf (non-labeled only) \$483
- Optional top latch into bottom \$209

LABELLED DOORS:	Single	Pair
UL: Metal label (includes closer reinf.)		
• 3, 1 1/2, 1 or 3/4 hour	67	134
• 20 minute	41	82
ITS/WHI: Metal label (includes closer reinf.)		
• 3, 1 1/2, 1, 3/4 hour or 20 minute	67	134
• 1 1/2 hour Mylar label (does not include closer reinf.) (max. 4'0" x 7'2" single / 8'0" x 7'2" pair)	9	18
• Cross-corridor smoke barrier Mylar label (includes closer reinf.)	67	134
FM: Mylar label (includes closer reinf.)		
• 3, 1 1/2 or 3/4 hour	67	134
ASTM E-330: (Uniform Static Air Pressure)	9	18

Refer to the TD Manual for all labeled approvals

Standard Hardware Options: Per prep

SPECIAL VERTICAL HARDWARE LOCATIONS:

- Hinge and lock N/C

CLOSERS / HOLDERS / STOPS:

- Surface Mounted:
 - Closer – 20" reinf. only \$27
 - Holder / Stop – full door width reinf. \$54
- Concealed or semi-concealed (per template) \$258
- ALLE Concealed or semi-concealed (per template) \$222

PUSH / PULL REINF. \$26

HINGES:

- 5" Universal in lieu of 4 1/2" Universal N/C
- Additional hinge prep \$14
- High frequency prep \$45
- Continuous hinge (full/half mortise or surface)
 - No internal reinf. N/C
 - Internal edge or face reinf. \$67

LOCKS / LATCHES:

- Cylindrical Locks:
 - 3 3/4" or 5" backset \$34
- Mortise Locks:
 - Additional 86, 86ED at any one location \$38
(Minimum 12" from center to center)
- Hotel, Card Reader Locks:
 - (CISA™, Simplex, Tesa, VingCard) \$38

DOUBLE COMBO LOCKS:

- (2) 161 preps on 4" centers \$42
(160-4 or 160 centerlines may be 3 5/8" or 5 1/2")

DEADLOCKS:

- Deadlock prep at any one location \$45
(Minimum 7" above or below cylindrical lock)
Includes cylindrical, tubular or mortise type
- ALLE Deadlock prep per template \$38
- Additional 161 prep \$15
(Minimum 7" above or below standard lock)
- Standard 161, 160-4 or 86 in lieu of standard location N/C

STRIKES:

- Additional ASA (4 7/8" ANSI A115.1)
 - with or without astragal \$40
- Deadlock (non-lip) \$51
- Open Back Strike \$117

Standard Hardware Options: Per prep

ROLLER LATCH:

- Lock edge \$61
- Top edge \$61

EXIT DEVICES:

- Rim:
 - Reinf. only \$34
 - Prep per template \$36
 - ALLE prep per template \$34
- Mortise:
 - Prep per template \$59
 - ALLE prep per template \$49
- Surface Vertical Rod:
 - Reinf. only \$56
 - Prep per template \$69
 - ALLE prep per template \$58
- Concealed Vertical Rod:
 - Top and bottom rods (per template) \$424
 - Top rod only (per template) \$424
 - ALLE Concealed Vertical Rod \$310
- Von Duprin Concealed Vertical Cable:

Hardware Prep Only:

- Top and bottom latch (98/9949 or 33/3549A) \$310
- LBL (less bottom latch) (98/9949 or 33/3549A) \$310
(Refer to Note 4 for Retrofit Application Requirements)

Hardware Prep and Factory Installed Cables:

- Top and bottom latch (98/9949 or 33/3549A) \$1362
- LBL (less bottom latch) (98/9949 or 33/3549A) \$1362
(Refer to Note 4 for Retrofit Application Requirements)

• Von Duprin INPACT™:

Hardware Prep Only:

- Mortise exit device \$310
- Vertical Rod (top rod only) \$310
- Vertical top and bottom rod \$310

Hardware Prep and Factory Installed Device:

(See pages 56-57 - INPACT™ Integrated Door System section for factory installed device)

- Schlage Multipoint Lock: LM/LMV9300 \$2102
(includes vertical rod installation)

ELECTRICAL PREPS:

- Power transfer units (i.e. EPT2, EPT10, etc.) \$97
- Electric hinge prep \$18
- Electric strike prep \$103
- Door position switch (1/2" to 1" dia.) \$15
- Magnetic switch (rectangular and mortised) \$76
- Wiring raceway (with conduit) \$135

NOTE: Individual hardware preps do not include price or provisions for wiring raceways in the door. Raceways are an option to the hardware preps and must be ordered separately.

Prices subject to change without notice.

Indicates products that have EPD documentation available and meet LEED v4.

FLUSH DOOR PRICING

Door Width	20 GA.	18 GA.
UP TO 6'8" HIGH		
1'6" thru 2'8"	511	600
Over 2'8" thru 3'0"	530	616
Over 3'0" thru 3'6"	-	759
Over 3'6" thru 4'0"	-	826
UP TO 7'0" HIGH		
1'6" thru 2'8"	539	620
Over 2'8" thru 3'0"	547	631
Over 3'0" thru 3'6"	-	788
Over 3'6" thru 4'0"	-	853
UP TO 7'2" HIGH		
1'6" thru 2'8"	594	679
Over 2'8" thru 3'0"	611	697
Over 3'0" thru 3'6"	-	805
Over 3'6" thru 4'0"	-	857
UP TO 8'0" HIGH		
1'6" thru 2'8"	-	-
Over 2'8" thru 3'0"	769	867
Over 3'0" thru 3'6"	-	1,005
Over 3'6" thru 4'0"	-	1,090

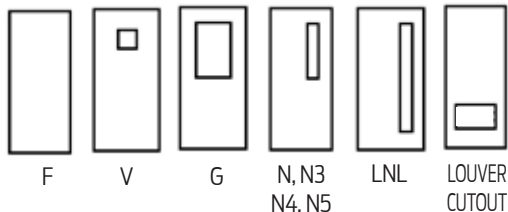

Typical Elevations

Standard Construction Options:

Per leaf

PAIRS OF DOORS OR INACTIVE LEAVES (price pairs of doors as 2 single leaves):

- Conventional locking / latching hardware - add per pair \$86
 - With Astragal – Includes ANSI Flushbolt prep or Surface Bolt reinf. and 4 7/8" ANSI strike
 - Without Astragal – Includes wide inactive leaf, ANSI Flushbolt prep, or Surface Bolt reinf. and 4 7/8" ANSI strike
- Non-latching hardware without astragal - add per pair N/C
 - For Rim, Vertical Rod and Push Pull applications
 - Blank lock edges, add all required hardware reinf.

GLASS LIGHTS Designer Trim for 1/4" or 1/2" thick glass (1/4" standard):

- Standard size V, N3, N4 or N5.....\$148
- Standard size G, N\$188
- Standard size LNL non-label only\$188
- Full Glass (FG) not available
- Special size and glass thicknessrefer to page 59

LOUVER CUTOUTS ONLY (per cutout):

- Non-labeled cutout only\$35
- Labeled and non-labeled cutout with channels \$112

NON-STANDARD SIZE WIDTHS and HEIGHTSprice as next larger size door

CORE MATERIAL OPTIONS:

- Honeycomb standard
- Polystyrene\$27
- Polyurethane (non-labeled only)\$127

GALVANNEALED A-60 STEEL\$79

EDGE SEAM CONSTRUCTION OPTIONnot available

UNDERCUT / FLOOR CLEARANCE (3/4" standard):

- Under 3/8" price as next larger size

TOP CAPS FACTORY INSTALLED:

- Screw-in cap (top or bottom) \$21

MARK NUMBERSN/C

DUTCH DOORnot available

LABELED DOORS:	Single	Pair
UL: Metal label (includes closer reinf.)		
· 3, 1 1/2, 1 or 3/4 hour	67	134
· 20 minute	41	81
ITS/WHI: Metal label (includes closer reinf.)		
· 3, 1 1/2, 1, 3/4 hour or 20 minute	67	134
· 1 1/2 hour Mylar label (does not include closer reinf.) (max. 4'0" x 7'2" single / 8'0" x 7'2" pair)	9	18
· Cross-corridor smoke barrier Mylar label	67	134
FM: Mylar label (includes closer reinf.)		
· 3, 1 1/2 or 3/4 hour	67	134
ASTM E-330: (Uniform Static Air Pressure)	not available	not available

Refer to the Steelcraft Tech Data Manual for all labeled approvals.

NOTE:

- Minimum size 1'6" x 6'8" / maximum size 4'0" x 8'0"

Prices subject to change without notice.

Standard Hardware Options: Per prep

SPECIAL VERTICAL HARDWARE LOCATIONS:

- Hinge and lockN/C

CLOSERS / HOLDERS / STOPS:

- Surface Mounted:
 - Closer – 20" reinf. only \$27
 - Holder / Stop – full door width reinf. \$54
 - Concealed or semi-concealedN/A
 - ALLE Concealed or semi-concealedN/A

PUSH / PULL REINF...... not available

HINGES:

- 5" not available
- Additional hinge prep \$14
- High frequency prep..... not available
- Continuous hinge (full/half mortise or surface)
 - No internal reinf..... N/C
 - Internal edge or face reinf..... \$67

LOCKS / LATCHES:

- Cylindrical Locks:
 - 3 3/4" or 5" backset not available
- Mortise Locks:
 - Additional 86, 86ED at any one location.....\$38
(Minimum 12" from center to center)
- Hotel, Card Reader Locks..... not available

DOUBLE COMBO LOCKS..... not available

DEADLOCKS:

- Deadlock prep at any one location.....\$45
(Minimum 7" above or below cylindrical lock)
Includes cylindrical, tubular or mortise type
- ALLE Deadlock prep per template\$38
- Additional 161 prep \$15
(Minimum 7" above or below standard lock)
- Standard 161, 160-4 or 86
in lieu of standard location..... not available

STRIKES:

- Additional ASA (4 7/8" ANSI A115.1)
with or without astragal not available
- Deadlock (non-lip) \$51
- Open Back Strike not available

Standard Hardware Options: Per prep

ROLLER LATCH not available

EXIT DEVICES:

- Rim
- Reinf. only.....\$34

ELECTRICAL PREPS..... not available

Prices subject to change without notice.

FLUSH DOOR PRICING

Door Width	18 GA.	16 GA.	14 GA.
UP TO 6'8" HIGH			
1'6" thru 2'8"	768	882	1,096
Over 2'8" thru 3'0"	777	926	1,144
Over 3'0" thru 3'6"	911	1,022	1,248
Over 3'6" thru 4'0"	992	1,078	1,321
UP TO 7'0" HIGH			
1'6" thru 2'8"	797	913	1,152
Over 2'8" thru 3'0"	804	953	1,190
Over 3'0" thru 3'6"	940	1,052	1,290
Over 3'6" thru 4'0"	1,006	1,102	1,359
UP TO 7'2" HIGH			
1'6" thru 2'8"	836	934	1,155
Over 2'8" thru 3'0"	858	969	1,208
Over 3'0" thru 3'6"	957	1,063	1,299
Over 3'6" thru 4'0"	1,010	1,109	1,372
UP TO 8'0" HIGH			
1'6" thru 3'0"	1,038	1,166	1,413
Over 3'0" thru 3'6"	1,141	1,262	1,500
Over 3'6" thru 4'0"	1,238	1,350	1,577
UP TO 9'0" HIGH			
1'6" thru 3'0"	1,377	1,493	1,781
Over 3'0" thru 3'6"	1,483	1,610	1,840
Over 3'6" thru 4'0"	1,508	1,641	1,888
UP TO 10'0" HIGH			
1'6" thru 3'0"	1,454	1,596	1,797
Over 3'0" thru 3'6"	1,565	1,628	1,923
Over 3'6" thru 4'0"	1,607	1,699	2,049

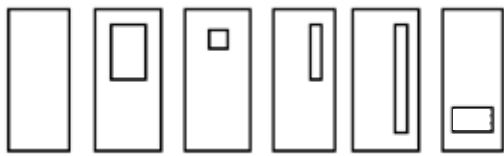

Typical Elevations

Standard Construction Options:

Per leaf

PAIRS OF DOORS OR INACTIVE LEAVES (price pairs of doors as 2 single leaves):

- Conventional locking / latching hardware - add per pair \$86
 - With Astragal – Includes ANSI Flushbolt prep or Surface Bolt reinf. and 4 7/8" ANSI Strike
 - Without Astragal – Includes wide inactive leaf, ANSI Flushbolt prep, or Surface Bolt reinf. and 4 7/8" ANSI strike
- Exit hardware and push pull without astragal - add per pair
 - Standard inactive leaf door width sizes N/C
 - Wide inactive leaf \$86
 - Add all appropriate hardware prep charges

GLASS LIGHTS Designer Trim for 1/4" or 1/2" thick glass (1/4" standard):

- Standard size V, N3, N4 or N5.....\$148
- Standard size G, N.....\$188
- Standard size LNL non-label only\$188
- Full Glass (FG) not available
- Special size and glass thicknesses..... refer to page 59

LIGHT / LOUVER CUTOUTS ONLY (per cutout):

- Non-Labeled cutout only..... not available
- Labeled and non-labeled cutout with channels\$112

NON-STANDARD SIZE WIDTHS and HEIGHTS price as next larger size door

CORE MATERIAL OPTIONS:

- Steel stiffened N/C
- STC-stiffened N/C

GALVANNEALED A-60 STEEL\$79

GALVANIZED G-90 STEEL not available

EDGE SEAM CONSTRUCTION OPTION:

- BF (Filled)\$69
- BW (Welded) \$100

UNDERCUT / FLOOR CLEARANCE (3/4" standard):

- Under 3/8" price as next larger size door

TOP CAPS FACTORY INSTALLED:

- Screw-in cap (top or bottom) \$21

MARK NUMBERS N/C

DUTCH DOOR (shelf not included, shipped loose):

- Non-label \$230
- Label 14, 16 or 18 gauge not available
- Half shelf \$284
- Full shelf (non-labeled only) \$483
- Optional top latch into bottom..... \$209

LABELED DOORS:	Single	Pair
UL: Metal label (includes closer reinf.)		
• 3, 1 1/2, 1 or 3/4 hour	67	134
• 20 minute	41	82
ITS/WHI:	not available	not available
FM:	not available	not available
ASTM E-330: (Uniform Static Air Pressure)	9	18

Refer to the Steelcraft Tech Data Manual for all labeled approvals.

NOTES:

- Minimum size 1'6" x 2'0" / maximum size 4'0" x 10'0"
- Von Duprin 338 Filler Plate (Package Number 1205) may be required with use of existing frame in some applications. Refer to the Parts Section for package quantity and pricing.

Prices subject to change without notice.

Standard Hardware Options: Per prep

SPECIAL VERTICAL HARDWARE LOCATIONS:
 • Hinge and lock N/C

CLOSERS / HOLDERS / STOPS:
 • Surface Mounted:
 • Closer – 20" reinf. only \$27
 • Holder / Stop – full door width reinf. \$54
 • Concealed or semi-concealed (per template) \$258
 • ALLE Concealed or semi-concealed (per template) \$222

PUSH / PULL REINF. \$26

HINGES:
 • 5" Universal in lieu of 4 1/2" Universal N/C
 • Additional hinge prep \$14
 • High frequency prep \$45
 • Continuous hinge (full / half mortise or surface)
 • No internal reinf. N/C
 • Internal edge or face reinf. \$67

LOCKS / LATCHES:
 • Cylindrical Locks:
 • 3 3/4" or 5" backset \$34
 • Mortise Locks:
 • Additional 86, 86ED at any one location \$38
 (Minimum 12" from center to center)
 • Hotel, Card Reader Locks:
 (CISA™, Simplex, Tesa, VingCard) \$38

DOUBLE COMBO LOCKS:
 • (2) 161 preps on 4" centers \$42
 (160-4 or 160 centerlines may be 3 5/8" or 5 1/2")

DEADLOCKS:
 • Deadlock prep at any one location \$45
 (Minimum 7" above or below cylindrical lock)
 Includes cylindrical, tubular or mortise type
 • ALLE Deadlock prep per template \$38
 • Additional 161 prep \$15
 (Minimum 7" above or below standard lock)
 • Standard 161, 160-4 or 86 in lieu of standard location N/C

STRIKES:
 • Additional ASA (4 7/8" ANSI A115.1)
 with or without astragal \$40
 • Deadlock (non-lip) \$51
 • Open Back Strike \$117

Standard Hardware Options: Per prep

ROLLER LATCH:
 • Lock edge \$61
 • Top edge \$61

EXIT DEVICES:
 • Rim:
 • Reinf. only \$34
 • Prep per template \$36
 • ALLE prep per template \$34
 • Mortise:
 • Prep per template \$59
 • ALLE prep per template \$49
 • Surface Vertical Rod:
 • Reinf. only \$56
 • Prep per template \$69
 • ALLE prep per template \$58
 • Concealed Vertical Rod:
 • Top and bottom rods (per template) \$424
 • Top rod only (per template) \$424
 • ALLE Concealed Vertical Rod \$310
 • Von Duprin Concealed Vertical Cable:
 Hardware Prep Only:
 • Top and bottom latch (98/9949 or 33/3549A) \$310
 • LBL (less bottom latch) (98/9949 or 33/3549A) \$310
 (Refer to **Note 2** for Retrofit Application Requirements)
 Hardware Prep and Factory Installed Cables:
 • Top and bottom latch (98/9949 or 33/3549A) \$1362
 • LBL (less bottom latch) (98/9949 or 33/3549A) \$1362
 (Refer to **Note 2** for Retrofit Application Requirements)
 • Von Duprin INPACT™ not available
 • Schlage MultiPoint Lock: LM/LMV9300 \$2102
 (includes vertical rod installation)

ELECTRICAL PREPS:
 • Power transfer units (i.e. EPT2, EPT10, etc.) \$97
 • Electric hinge prep \$18
 • Electric strike prep \$103
 • Door position switch (1/2" to 1" dia.) \$15
 • Magnetic switch (rectangular and mortised) \$76
 • Wiring raceway (with conduit) \$135
NOTE: Individual hardware preps do not include price or provisions for wiring raceways in the door. Raceways are an option to the hardware preps and must be ordered separately.

Prices subject to change without notice.

FLUSH DOOR PRICING

Door Width	20 GA.	18 GA.	16 GA.	14 GA.
UP TO 6'8" HIGH				
1'6" thru 2'8"	965	1,053	1,194	1,321
Over 2'8" thru 3'0"	989	1,080	1,235	1,387
Over 3'0" thru 3'6"	-	1,216	1,336	1,487
Over 3'6" thru 4'0"	-	1,290	1,398	1,538
UP TO 7'0" HIGH				
1'6" thru 2'8"	976	1,064	1,224	1,382
Over 2'8" thru 3'0"	1,002	1,097	1,261	1,437
Over 3'0" thru 3'6"	-	1,247	1,370	1,534
Over 3'6" thru 4'0"	-	1,319	1,424	1,580
UP TO 7'2" HIGH				
1'6" thru 2'8"	1,053	1,102	1,241	1,399
Over 2'8" thru 3'0"	1,084	1,171	1,279	1,451
Over 3'0" thru 3'6"	-	1,266	1,382	1,562
Over 3'6" thru 4'0"	-	1,323	1,433	1,617
UP TO 8'0" HIGH				
1'6" thru 2'8"	1,238	1,350	1,457	1,691
Over 2'8" thru 3'0"	1,270	1,382	1,495	1,743
Over 3'0" thru 3'6"	-	1,503	1,641	1,838
Over 3'6" thru 4'0"	-	1,579	1,724	1,934
UP TO 9'0" HIGH				
1'6" thru 2'8"	-	1,551	1,674	1,983
Over 2'8" thru 3'0"	-	1,583	1,712	2,034
Over 3'0" thru 3'6"	-	1,741	1,902	2,115
Over 3'6" thru 4'0"	-	1,835	2,016	2,251

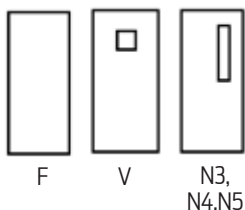

Typical Elevations

NOTES:

1. Maximum size 4'0" x 9'0" in 18, 16 and 14 gauge material
2. Maximum size 3'0" x 8'0" in 20 gauge material
3. Minimum size 1'6" x 2'0"
4. Von Duprin 338 Filler Plate (Package Number 1205) may be required with use of existing frame in some applications. Refer to the Parts Section for package quantity and pricing.

Standard Construction Options:

Per leaf

PAIRS OF DOORS OR INACTIVE LEAVES (price pairs of doors as 2 single leaves):

- Conventional locking / latching hardware - add per pair \$86
 - **With Astragal** - Includes ANSI Flushbolt prep or Surface Bolt reinf. and 4 7/8" ANSI strike
 - **Without Astragal** - Includes wide inactive leaf, ANSI Flushbolt prep, or Surface Bolt reinf. and 4 7/8" ANSI strike
- Exit hardware and push pull without astragal - add per pair
 - Standard inactive leaf door width sizes N/C
 - Wide inactive leaf \$86
 - Add all appropriate hardware prep charges

GLASS LIGHTS Designer Trim for 1/4" or 1/2" thick glass (1/4" standard):

- Standard size V, N3, N4 or N5 \$148
- Standard size G, N, LNL not available
- Full Glass (FG) non-label only not available

LIGHT CUTOUTS ONLY (per cutout):

- Cutout with channels \$112

NON-STANDARD SIZE WIDTHS and HEIGHTS price as next larger size door

CORE MATERIAL OPTIONS not available

GALVANNEALED A-60 STEEL \$79

GALVANIZED G-90 STEEL \$293

- 18, 16 or 14 gauge only
- Maximum 3'8" x 10'0" door size

EDGE SEAM CONSTRUCTION OPTION:

- TF (Filled) \$69
- TW (Welded) 18, 16 and 14 gauge doors only \$100

UNDERCUT / FLOOR CLEARANCE (3/4" standard):

- Under 3/8" price as next larger size door

TOP CAPS FACTORY INSTALLED:

- Screw-in cap (top or bottom) \$21

MARK NUMBERS N/C

DUTCH DOOR not available

LABELED DOORS:	Single	Pair
UL: Metal label (includes closer reinf.) • 3 or 1 1/2,	standard	standard
ITS/WHI:	not available	not available
FM: Mylar label (includes closer reinf.) • 3, 1 1/2	standard	standard
ASTM E-330: (Uniform Static Air Pressure)	9	18

Refer to the Steelcraft Tech Data Manual for all labeled approvals.

Prices subject to change without notice.

Standard Hardware Options: Per prep

SPECIAL VERTICAL HARDWARE LOCATIONS:
 • Hinge and lockN/C

CLOSERS / HOLDERS / STOPS:
 • Surface Mounted:
 • Closer – 20" reinf. only \$27
 • Holder / Stop – full door width reinf. \$54
 • Concealed or semi-concealed (per template) \$258
 • ALLE Concealed or semi-concealed (per template) \$222

PUSH / PULL REINF\$26

HINGES:
 • 5" Universal in lieu of 4 1/2" UniversalN/C
 • Additional hinge prep \$14
 • High frequency prep \$45
 • Continuous hinge (full / half mortise or surface)
 • No internal reinf.N/C
 • Internal edge or face reinf. \$67

LOCKS / LATCHES:
 • Cylindrical Locks:
 • 3 3/4" or 5" backset \$34
 • Mortise Locks:
 • Additional 86, 86ED at any one location \$38
 (Minimum 12" from center to center)
 • Hotel, Card Reader Locks:
 (CISA™, Simplex, Tesa, VingCard) \$38

DOUBLE COMBO LOCKS not available

DEADLOCKS:
 • Deadlock prep at any one location \$45
 (Minimum 7" above or below cylindrical lock)
 Includes cylindrical, tubular or mortise type
 • ALLE Deadlock prep per template. \$38
 • Additional 161 prep \$15
 (Minimum 7" above or below standard lock)
 • Standard 161, 160-4 or 86 in lieu of standard location N/C

STRIKES:
 • Additional ASA (4 7/8" ANSI A115.1)
 with or without astragal \$40
 • Deadlock (non-lip) not available
 • Open Back Strike not available

Standard Hardware Options: Per prep

ROLLER LATCH not available

EXIT DEVICES:
 • Rim:
 • Reinf. only \$34
 • Prep per template \$36
 • ALLE prep per template \$34
 • Mortise:
 • Prep per template \$59
 • ALLE prep per template \$49
 • Surface Vertical Rod (450°):
 • Reinf. only \$56
 • Prep per template \$69
 • ALLE prep per template \$58
 • Concealed Vertical Rod (450°):
 • Top and bottom rods (per template) \$424
 • Top rod only (per template) \$424
 • ALLE Concealed Vertical Rod \$310
 • Von Duprin Concealed Vertical Cable (450°):

Hardware Prep Only:
 • Top and bottom latch (98/9949 or 33/3549A) \$310
 • LBL (less bottom latch) (98/9949 or 33/3549A) \$310
(Refer to Note 4 for Retrofit Application Requirements)

Hardware Prep and Factory Installed Cables:
 • Top and bottom latch (98/9949 or 33/3549A) \$1362
 • LBL (less bottom latch) (98/9949 or 33/3549A) \$1362
(Refer to Note 4 for Retrofit Application Requirements)

• Von Duprin INPACT™ (450°):
Hardware Prep Only:
 • Mortise exit device \$310
 • Vertical Rod (top rod only) \$310
 • Vertical top and bottom rod \$310

Hardware Prep and Factory Installed Device:
(See pages 56-57 - INPACT™ Integrated Door System section for factory installed device)

ELECTRICAL PREPS:
 • Power transfer units (i.e. EPT2, EPT10, etc.) \$97
 • Electric hinge prep \$18
 • Electric strike prep \$103
 • Door position switch (1/2" to 1" dia.) \$15
 • Magnetic switch (rectangular and mortised) \$76
 • Wiring raceway (with conduit) \$135

NOTE: Individual hardware preps do not include price or provisions for wiring raceways in the door. Raceways are an option to the hardware preps and must be ordered separately.

Prices subject to change without notice.

1 3/4" EMBOSSED PANEL
GALVANNEALED AND POLYSTYRENE CORE

	E6			E4TL			E8	HD2		HD2A	
Door Width	CE20	CE18	CE16	CE20	CE18	CE16	CE20	HD218	HD216	HD2A18	HD2A16
6'8" HIGH											
2'6"	687	837	959	-	-	-	-	-	-	-	-
2'8"	687	837	959	-	-	-	839	963	1,070	1,006	1,116
3'0"	717	851	1,015	995	1,167	1,272	846	989	1,097	1,031	1,135
3'4"	-	997	-	-	1,428	-	-	1,101	1,220	1,136	1,260
3'6"	-	997	-	-	1,428	-	-	1,101	1,220	-	-
3'8"	-	1,064	-	-	1,441	-	-	1,266	1,415	-	-
7'0" HIGH											
2'6"	717	900	990	994	1,150	1,262	-	-	-	-	-
2'8"	717	900	990	994	1,150	1,262	900	1,008	1,119	1,043	1,158
3'0"	746	900	1,030	1,023	1,177	1,301	882	1,035	1,147	1,063	1,195
3'4"	-	1,015	-	-	1,445	-	-	1,114	1,235	1,155	1,282
3'6"	-	1,015	-	-	1,445	-	-	1,114	1,235	-	-
3'8"	-	1,130	-	-	1,493	-	-	1,324	1,469	-	-
8'0" HIGH											
3'0"	933	1,095	1,288	1,208	1,344	1,564	-	-	-	-	-

NOTES:

1. Door heights between 7'0" and 8'0" are not available.
2. 8'0" door height is available in 3'0" width only.
3. CE-Series doors are A-40 galvalneal.
4. Min width 2'8" on HD embossment.
5. Max. width for HD2A design is 3'4"
6. Von Duprin 338 Filler Plate (Package Number 1205) may be required with use of existing frame in some applications. Refer to the Parts Section for package quantity and pricing.

LABELED DOORS:	Single	Pair
UL: Metal label (includes closer reinf.)		
• 3, 1 1/2, 1 or 3/4 hour	67	134
• 20 minute	41	82
ITS/WHI:	not available	not available
FM:	not available	not available
ASTM E-330: (Uniform Static Air Pressure)	9	18

Refer to the Steelcraft Tech Data Manual for all labeled approvals.

Standard Construction Options:

Per leaf

PAIRS OF DOORS OR INACTIVE LEAVES:

- (price pairs of doors as 2 single leaves)
- Conventional locking / latching hardware - add per pair..... \$86
 - With Astragal – Includes ANSI Flushbolt prep or Surface Bolt reinf. and 4 7/8" ANSI strike
 - Without Astragal – Includes wide inactive leaf, ANSI Flushbolt prep, or Surface Bolt reinf. and 7/8" ANSI strike
- Exit hardware and push pull without astragal - add per pair
 - Standard inactive leaf door width sizes N/C
 - Wide inactive leaf..... \$86
 - Add all appropriate hardware prep charges

GLASS LIGHTS:

- Designer Trim for 1/4" or 1/2" thick glass (1/4" standard):
 - See glass light chart for all prices
 - NNL, N, V, N3, N4 or N5 not available
 - Full Glass (FG)..... not available

LOUVER CUTOUTS ONLY not available

NON-STANDARD SIZE WIDTHS and HEIGHTS not available

CORE MATERIAL OPTIONS not available

GALVANNEALED A-60 STEEL not available

GALVANIZED G-90 STEEL not available

EDGE SEAM CONSTRUCTION OPTION:

- CEF (Filled)..... \$69
- CEW (Welded) not available

UNDERCUT / FLOOR CLEARANCE (3/4" standard):

- Under 3/8" price as next larger size

TOP CAPS FACTORY INSTALLED:

- Screw-in cap (top or bottom) \$21

MARK NUMBERS..... N/C

DUTCH DOOR not available

Prices subject to change without notice.

1 3/4" EMBOSSED PANEL

GALVANNEALED AND POLYSTYRENE CORE

CE-SERIES

DOORS

Standard Hardware Options: Per prep

SPECIAL VERTICAL HARDWARE LOCATIONS:
 • Hinge and lockN/C

CLOSERS / HOLDERS / STOPS:
 • Surface Mounted:
 • Closer – 20" reinf. only \$27
 • Holder / Stop – full door width reinf. \$54
 • Concealed or semi-concealed (per template) \$258
 • ALLE Concealed or semi-concealed (per template).....\$222

PUSH / PULL REINF \$26

HINGES:
 • 5" Universal in lieu of 4 1/2" Universal N/C
 • Additional hinge prep \$14
 • High frequency prep \$45
 • Continuous hinge (full / half mortise or surface)
 • No internal reinf.N/C
 • Internal edge or face reinf.\$67

LOCKS / LATCHES:
 • Cylindrical Locks:
 • 3 3/4" or 5" backset \$34
 • Mortise Locks:
 • Additional 86, 86ED at any one location\$38
 (Minimum 12" from center to center)
 • Hotel, Card Reader Locks:
 (CISA™, Simplex, Tesa, VingCard)..... \$38

DOUBLE COMBO LOCKS:
 • (2) 161 preps on 4" centers \$42
 (160-4 or 160 centerlines may be 3 5/8" or 5 1/2")

DEADLOCKS:
 • Deadlock prep at any one location.....\$45
 (Minimum 7" above or below cylindrical lock)
 Includes cylindrical, tubular or mortise type
 • ALLE Deadlock prep per template..... \$38
 • Additional 161 prep \$15
 (Minimum 7" above or below standard lock)
 • Standard 161, 160-4 or 86 in lieu of standard location..... N/C

STRIKES:
 • Additional ASA (4 7/8" ANSI A115.1)
 with or without astragal \$40
 • Deadlock (non-lip) \$51
 • Open Back Strike \$117

Standard Hardware Options: Per prep

ROLLER LATCH:
 • Lock edge..... \$61
 • Top edge..... \$61

EXIT DEVICES:
 • Rim:
 • Reinf. only \$34
 • Prep per template \$36
 • ALLE prep per template \$34
 • Mortise:
 • Prep per template \$59
 • ALLE Prep per template \$49
 • Surface Vertical Rod:
 • Reinf. only \$56
 • Prep per template \$69
 • ALLE prep per template \$58
 • Concealed Vertical Rod:
 • Top and bottom rods (per template) \$424
 • Top rod only (per template) \$424
 • ALLE Concealed Vertical Rod..... \$310
 • Von Duprin Concealed Vertical Cable:
 Hardware Prep Only:
 • Top and bottom latch (98/9949 or 33/3549A) \$310
 • LBL (less bottom latch) (98/9949 or 33/3549A) \$310
 (Refer to **Note 5** for Retrofit Application Requirements)
 Hardware Prep and Factory Installed Cables:
 • Top and bottom latch (98/9949 or 33/3549A) \$1362
 • LBL (less bottom latch) (98/9949 or 33/3549A) \$1362
 (Refer to **Note 5** for Retrofit Application Requirements)
 • Von Duprin INPACT™ not available

ELECTRICAL PREPS:
 • Power transfer units (i.e. EPT2, EPT10, etc.) \$97
 • Electric hinge prep \$18
 • Electric strike prep \$103
 • Door position switch (1/2" to 1" dia.) \$15
 • Magnetic switch (rectangular and mortised) \$76
 • Wiring raceway (with conduit)..... \$135
NOTE: Individual hardware preps do not include price or provisions for wiring raceways in the door. Raceways are an option to the hardware preps and must be ordered separately.

Prices subject to change without notice.

ENTRANCE DOOR PRICING

Door Width	FG	FG2	FG3
UP TO 6'8" HIGH			
2'0" thru 2'8"	1,282	1,538	1,848
Over 2'8" thru 3'0"	1,312	1,558	1,880
Over 3'0" thru 3'6"	1,345	1,590	1,978
Over 3'6" thru 4'0"	1,386	1,611	1,989
Over 3'8" thru 4'0"	1,428	1,651	2,000
UP TO 7'0" HIGH			
2'0" thru 2'8"	1,322	1,558	1,880
Over 2'8" thru 3'0"	1,353	1,587	1,909
Over 3'0" thru 3'6"	1,386	1,622	1,941
Over 3'6" thru 4'0"	1,428	1,651	1,984
Over 3'8" thru 4'0"	1,466	1,701	2,023
UP TO 7'2" HIGH			
2'0" thru 2'8"	1,345	1,569	1,901
Over 2'8" thru 3'0"	1,374	1,599	1,932
Over 3'0" thru 3'6"	1,411	1,646	1,967
Over 3'6" thru 4'0"	1,452	1,677	2,010
Over 3'8" thru 4'0"	1,494	1,717	2,051
UP TO 8'0" HIGH			
2'0" thru 2'8"	1,429	1,759	2,028
Over 2'8" thru 3'0"	1,471	1,782	2,116
Over 3'0" thru 3'6"	1,502	1,813	2,146
Over 3'6" thru 4'0"	1,524	1,854	2,167
Over 3'8" thru 4'0"	1,565	1,865	2,178

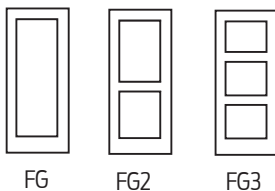

Typical Elevations

Standard Construction Options:

Per leaf

PAIRS OF DOORS OR INACTIVE LEAVES (price pairs of doors as 2 single leaves):

- Conventional locking / latching hardware - add per pair \$86
 - With Astragal - Includes ANSI Flushbolt prep or Surface Bolt reinf. and 4 7/8" ANSI strike
 - Without Astragal - Includes wide inactive leaf, ANSI Flushbolt prep, or Surface Bolt reinf. and 4 7/8" ANSI strike
- Exit hardware and push pull without astragal - add per pair
 - Standard inactive leaf door width sizes N/C
 - Wide inactive leaf \$86
 - Add all appropriate hardware prep charges

GLASS LIGHTS refer to pricing table

- Special glass thicknesses refer to page 59

LIGHT / LOUVER CUTOUTS ONLY N/C

NON-STANDARD SIZE WIDTHS and HEIGHTS price as next larger size door

CORE MATERIAL OPTIONS:

- Honeycomb standard

GALVANNEALED A-60 STEEL \$79

GALVANIZED G-90 STEEL \$313

- Maximum 3'8" x 8'0" door size

EDGE SEAM CONSTRUCTION OPTION:

- AF (Filled) standard
- AW (Welded) not available

UNDERCUT / FLOOR CLEARANCE (3/4" standard):

- Under 3/8" price as next larger size

TOP CAPS FACTORY INSTALLED:

- Screw-in cap (top or bottom) \$21

MARK NUMBERS N/C

DUTCH DOOR not available

LABELED DOORS:	Single	Pair
UL: Metal label (includes closer reinf.)		
· 3, 1 1/2, 1 or 3/4 hour	67	134
· 20 minute	41	82
ITS/WHI:	not available	not available
FM:	not available	not available
ASTM E-330: (Uniform Static Air Pressure)	not available	not available

Refer to the Steelcraft Tech Data Manual for all labeled approvals.

NOTES:

- Minimum size 2'0" x 6'8" / maximum size 4'0" x 8'0"
- Top rail 6 1/4" minimum thru 24" maximum to expose glass
- Bottom rail 11 1/4" minimum thru 24" maximum to exposed glass
- Bottom surface bolt must be thru bolted
- Von Duprin 338 Filler Plate (Package Number 1205) may be required with use of existing frame in some applications. Refer to the Parts Section for package quantity and pricing.

Prices subject to change without notice.

Standard Hardware Options: Per prep

SPECIAL VERTICAL HARDWARE LOCATIONS:
 • Hinge and lock N/C

CLOSERS / HOLDERS / STOPS:
 • Surface Mounted:
 • Closer – 20" reinf. only \$27
 • Holder / Stop – full door width reinf. \$54
 • Concealed or semi-concealed (per template) \$258
 • ALLE Concealed or semi-concealed (per template) \$222

PUSH / PULL REINF. \$26

HINGES:
 • 5" Universal in lieu of 4 1/2" Universal N/C
 • Additional hinge prep \$14
 • High frequency prep \$45
 • Continuous hinge (full / half mortise or surface)
 • No internal reinf. N/C
 • Internal edge or face reinf. \$67

LOCKS / LATCHES:
 • Cylindrical Locks:
 • 3 3/4" or 5" backset not available
 • Mortise Locks:
 • Additional 86, 86ED at any one location \$38
 (Minimum 12" from center to center)
 • Hotel, Card Reader Locks:
 (CISA™, Simplex, Tesa, VingCard) \$38

DOUBLE COMBO LOCKS:
 • (2) 161 preps on 4" centers \$42
 (160-4 or 160 centerlines may be 3 5/8" or 5 1/2")

DEADLOCKS:
 • Deadlock prep at any one location \$45
 (Minimum 7" above or below cylindrical lock)
 Includes cylindrical, tubular or mortise type
 • ALLE Deadlock prep per template \$38
 • Additional 161 prep \$15
 (Minimum 7" above or below standard lock)
 • Standard 161, 160-4 or 86 in lieu of standard location N/C

STRIKES:
 • Additional ASA (4 7/8" ANSI A115.1)
 with or without astragal \$40
 • Deadlock (non-lip) \$51
 • Open Back Strike \$117

Standard Hardware Options: Per prep

ROLLER LATCH:
 • Lock edge \$61
 • Top edge \$61

EXIT DEVICES:
 • Rim:
 • Reinf. only \$34
 • Prep per template \$36
 • ALLE prep per template \$34
 • Mortise:
 • Prep per template \$59
 • ALLE prep per template \$49
 • Surface Vertical Rod:
 • Reinf. only \$56
 • Prep per template \$69
 • ALLE prep per template \$58
 • Concealed Vertical Rod:
 • Top and bottom rods (per template) \$424
 • Top rod only (per template) \$424
 • ALLE Concealed Vertical Rod \$310
 • Von Duprin Concealed Vertical Cable:
 Hardware Prep Only:
 • Top and bottom latch (98/9949 or 33/3549A) \$310
 • LBL (less bottom latch) (98/9949 or 33/3549A) \$310
 (Refer to **Note 5** for Retrofit Application Requirements)
 Hardware Prep and Factory Installed Cables:
 • Top and bottom latch (98/9949 or 33/3549A) \$1362
 • LBL (less bottom latch) (98/9949 or 33/3549A) \$1362
 (Refer to **Note 5** for Retrofit Application Requirements)
 • Von Duprin INPACT™ not available

ELECTRICAL PREPS:
 • Power transfer units (i.e. EPT2, EPT10, etc.) \$97
 • Electric hinge prep \$18
 • Electric strike prep \$103
 • Door position switch (1/2" to 1" dia.) \$15
 • Magnetic switch (rectangular and mortised) \$76
 • Wiring raceway (with conduit) \$135
NOTE: Individual hardware preps do not include price or provisions for wiring raceways in the door. Raceways are an option to the hardware preps and must be ordered separately.

Prices subject to change without notice.

FLUSH DOOR PRICING

Door Width	H16	H14	H16-E6
UP TO 6'8" HIGH			
1'6" thru 2'8"	915	1,057	1,110
Over 2'8" thru 3'0"	962	1,124	1,168
Over 3'0" thru 3'6"	1,056	1,230	-
Over 3'6" thru 4'0"	1,123	1,276	-
UP TO 7'0" HIGH			
1'6" thru 2'8"	943	1,115	1,146
Over 2'8" thru 3'0"	981	1,172	1,191
Over 3'0" thru 3'6"	1,094	1,276	-
Over 3'6" thru 4'0"	1,151	1,324	-
UP TO 7'2" HIGH			
1'6" thru 2'8"	962	1,134	-
Over 2'8" thru 3'0"	1,000	1,191	-
Over 3'0" thru 3'6"	1,104	1,305	-
Over 3'6" thru 4'0"	1,161	1,362	-
UP TO 8'0" HIGH			
1'6" thru 3'0"	1,226	1,485	1,487
Over 3'0" thru 3'6"	1,320	1,553	-
Over 3'6" thru 4'0"	1,368	1,597	-
UP TO 9'0" HIGH			
1'6" thru 3'0"	1,533	1,840	-
Over 3'0" thru 3'6"	1,667	1,941	-
Over 3'6" thru 4'0"	1,710	1,978	-

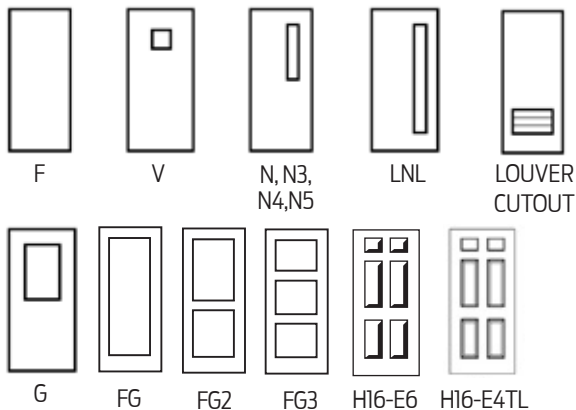

Typical Elevations

NOTES:

Standard items included with flush and glazed doors:

1. A-60 galvanized, honeycomb core, prime painted
2. 3/8" undercut
3. Florida Building Code label
4. HE-Series:
 - A-40 galvanized
 - Polystyrene core
 - E6 and E4TL panel designs
 - Add \$257 list for E4TL
5. Approved hardware required
6. Reference CE-Series for available HE16 door widths
7. HE16 8'0" High available in 3'0" width only
8. Opening heights over 8'0" are not FBC or Miami-Dade approved

Standard Construction Options:

Per leaf

PAIRS OF DOORS OR INACTIVE LEAVES (price pairs of doors as 2 single leaves):

- Conventional locking / latching hardware - add per pair \$86
 - With Astragal – Includes 4 7/8" ANSI strike prep and Surface Bolt reinf. (flushbolts not available)
 - Without Astragal – Requires two (2) active leaves
- Push pull without astragal not available

GLASS LIGHTS Designer Trim for 1/4" or 1/2" thick glass (1/2" standard):

- Standard size V, N3, N4 or N5 non-label only \$204
- Standard size G, N, LNL non-label only \$250
- Full Glass (FG) non-label only \$311
- Full Glass (FG2) non-label only \$494
- Full Glass (FG3) non-label only \$741
- Special size and glass thicknesses refer to page 59

LIGHT / LOUVER CUTOUTS ONLY (per cutout):

- Non-labeled cutout only not available
- Labeled and non-labeled cutout with channels \$112

NON-STANDARD SIZE WIDTHS and HEIGHTS .. price as next larger size door

CORE MATERIAL OPTIONS:

- Honeycomb standard
- Polystyrene \$27
- Vertical steel stiffened (20 gauge stiffeners only) \$127
- Polyurethane (non-labeled only) \$127
- Temperature Rise (TH-Series) \$276

GALVANNEALED A-60 STEEL N/C

GALVANIZED G-90 STEEL \$313

- 16 or 14 gauge only
- Maximum 3'8" x 10'0" door size
- Not with stiffened core

EDGE SEAM CONSTRUCTION OPTION:

- HF (Filled) \$69
- HW (Welded) H-Series only \$100

UNDERCUT / FLOOR CLEARANCE (3/8" standard):

- Under 3/8" N/C

TOP CAPS FACTORY INSTALLED:

- Screw-in cap (top) N/C

MARK NUMBERS N/C

DUTCH DOOR not available

LABELED DOORS:	Single	Pair
UL: Metal label (includes closer reinf.)		
• 3, 1 1/2, 1 or 3/4 hour	67	134
• 20 minute	41	82
ITS/WHI:	not available	not available
FM:	not available	not available
Dade County label	9	18

Refer to the Steelcraft Tech Data Manual for all fire and storm labeled approvals.

Prices subject to change without notice.

Standard Hardware Options: **Per prep**

SPECIAL VERTICAL HARDWARE LOCATIONS:

- Hinge and lock not available

CLOSERS / HOLDERS / STOPS:

- Surface Mounted:
 - Closer – 20" reinf. only \$27
 - Holder / Stop – full door width reinf. \$54
- Concealed or semi-concealed not available
- ALLE Concealed or semi-concealed not available

PUSH / PULL REINF not available

HINGES:

- 5" Universal in lieu of 4 1/2" Universal N/C
- Additional hinge prep \$14
- High frequency prep \$45
- Continuous hinge (full / half mortise or surface)
 - No internal reinf. not available
 - Internal edge or face reinf. \$67

LOCKS / LATCHES:

- Cylindrical Locks:
 - 161 or 61L
- 2 3/4" backset N/C
- Mortise Locks:
 - Additional 86, 86ED at any one location \$38
(Minimum 12" from center to center)
- Hotel, Card Reader Locks:
 - (Locknetics) \$38

DOUBLE COMBO LOCKS:

- (2) 161 preps on 4" centers \$42
(160-4 or 160 centerlines may be 3 5/8" or 5 1/2")

DEADLOCKS:

- Deadlock prep at any one location \$45
(Minimum 7" above or below cylindrical lock)
Includes cylindrical, tubular or mortise type
- ALLE Deadlock prep per template \$38
- Additional 161 prep \$15
(Minimum 7" above or below standard lock)
- Standard 161, 160-4 or 86 in lieu of standard location not available

STRIKES:

- Additional ASA (4 7/8" ANSI A115.1) with astragal \$40
- Deadlock (non-lip) \$51
- Open Back Strike not available

Standard Hardware Options: **Per prep**

ROLLER LATCH not available

EXIT DEVICES:

- Rim:
 - Reinf. only \$34
 - Prep per template \$36
 - ALLE prep per template \$34
- Mortise:
 - Prep per template \$59
 - ALLE prep per template \$49
- Surface Vertical Rod:
 - Reinf. only \$56
 - Prep per template \$69
 - ALLE prep per template \$58
- Concealed Vertical Rod:
 - Top and bottom rods (per template) \$424
 - Top rod only (per template) \$424
 - ALLE Concealed Vertical Rod \$310
- Von Duprin INPACT™ not available

ELECTRICAL PREPS:

- Power transfer units (i.e. EPT2, EPT10, etc.) \$97
- Electric hinge prep \$18
- Electric strike prep \$103
- Door position switch (1/2" to 1" dia.) \$15
- Magnetic switch (rectangular and mortised) \$76
- Wiring raceway (with conduit) \$135

NOTE: Individual hardware preps do not include price or provisions for wiring raceways in the door. Raceways are an option to the hardware preps and must be ordered separately.

Prices subject to change without notice.

1 3/4" TORNADO RESISTANT DOORS

3-SIDED & GLASS DOOR PRICING

Door Width	14 Gauge
UP TO 6'8" HIGH	
Single 3'0" thru 4'0"	4,764
Pairs 6'0" thru 8'0"	9,528
UP TO 7'0" HIGH	
Single 3'0" thru 4'0"	5,104
Pairs 6'0" thru 8'0"	10,208
UP TO 7'2" HIGH	
Single 3'0" thru 4'0"	5,558
Pairs 6'0" thru 8'0"	11,116
UP TO 8'0" HIGH	
Single 3'0" thru 4'0"	6,011
Pairs 6'0" thru 8'0"	12,022

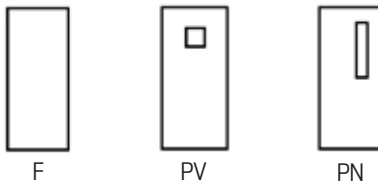

Available Elevations

*4-SIDED & SHUTTER PRICING

Door Width	14 Gauge
UP TO 6'8" HIGH	
Single 2'8" thru 4'0"	4,764
Pairs 5'4" thru 8'0"	9,528
UP TO 7'0" HIGH	
Single 2'8" thru 4'0"	5,104
Pairs 5'4" thru 8'0"	10,208
UP TO 7'2" HIGH	
Single 2'8" thru 4'0"	5,558
Pairs 5'4" thru 8'0"	11,116
UP TO 8'0" HIGH	
Single 2'8" thru 4'0"	6,011
Pairs 5'4" thru 8'0"	12,022

*Available as Flush doors only; no glass allowed

NOTES:

- 3-sided, Minimum size 3'0" x 6'8" / maximum size 8'0" x 8'0"
- 4-sided, Minimum size 2'8" x 4'3" / maximum size 8'0" x 8'0"
- Glass light assembly only available with standard factory installed glass
- All hardware functions must be specified. Refer to the Tornado Resistant Approvals in the Steelcraft Tech Data Manual
- Paired opening prices shown are for applications with or without astragals
- See above for undercuts (1/4" max between door and finished floor/threshold)

Standard Construction Options:..... Per leaf

PAIRS OF DOORS OR INACTIVE LEAVES (price pairs of doors as 2 single leaves):

- Conventional locking / latching hardware - add per pair\$86
 - With Astragal – Includes Surface Bolt reinf. and 4 7/8" ANSI strike (not recommended with panic exit hardware)
 - Without Astragal – Includes wide inactive leaf, SB360 Surface bolt reinf. and 4 7/8" ANSI strike\$86
- Push pull without astragal not available

GLASS LIGHT ASSY: Factory installed and approved Glass and Trim, 3-Sided Only (no shutters)

- Paladin Vision (PV) non-label (9 1/2" x 9 1/2") \$4,210
- Paladin Vision (PVF) label (9 1/2" x 9 1/2") \$8,300
- Paladin Narrow (PN) non-label (4 1/8" x 26 11/16") \$4,560
- Paladin Narrow (PNF) label (4 1/8" x 26 11/16") \$8,650

NON-STANDARD SIZE WIDTHS and HEIGHTS..... price as next larger size door LIGHT / LOUVER CUTOUTS ONLY..... not available

CORE MATERIAL OPTIONS not available

GALVANIZED A-60 STEEL..... standard

GALVANIZED G-90 STEEL..... not available

EDGE SEAM CONSTRUCTION OPTION:

- PF (Filled) not available
- PW (Welded and Seam filled) standard

UNDERCUT / FLOOR CLEARANCE (3/4" standard for 1/2" ADA saddle threshold):

(See hardware installation instructions and Steelcraft tech data for undercut guidance. Typical undercut must provide 1/4" max between bottom of door and top of finished floor/threshold; critical distance - bottom of door to top of strike 1/8-1/4" for LM and 1/8" for WS devices).

12 GA TOP CHANNEL SERVES AS TOP CAP..... standard

MARK NUMBERS..... N/C

DUTCH DOOR not available

Available Sizes:

	Single		Pair	
	Min.	Max.	Min.	Max.
3-Sided & Glass	3'0" x 6'8"	4'0" x 8'0"	6'0" x 6'8"	8'0" x 8'0"
4-Sided & Shutters	2'8" x 4'3"	4'0" x 8'0"	5'4" x 4'3"	8'0" x 8'0"

LABELED DOORS:

	Single	Pair
UL:	not available	not available
ITS/WHI: Metal label (includes closer reinf.) *3, 1 1/2, 1, 3/4 hour or 20 min	\$67	\$134
FM:	not available	not available
ICC500-2014 / FEMA 361/320 Label	N/C	N/C

*Glass lights rated up to 1-1/2 hours max

Refer to the Steelcraft Tech Data Manual for all labeled approvals.

Prices subject to change without notice.

Standard Hardware Options:

Per prep

SPECIAL VERTICAL HARDWARE LOCATIONS:

- Hinge and lockN/C

SURFACE MOUNTED CLOSERS / HOLDERS / STOPS:

- Surface Mounted Closers:
 - 20" reinfstandard
 - Holder / Stop – full door width reinf \$50

- Approved models - LCN 4000T, 4010, 4010T, 4020, 4020T, 4030, 4030T, 4040XP, 4040XPT, 4050, 4110, 4110T

- Approved models - FALCON SC70 (heavy duty), SC80A, SC60A

- Concealed or semi-concealed (per template)..... not available
- ALLE Concealed or semi-concealed (per template) not available
- Surface Overhead Holder/Stopspecify reinf in available closer preps

- Approved models - GJ 79S (extra heavy duty), 70S, 90S, 81S (Confirm that your choice opens 180 deg if needed and as configured).

- Surface Floor & Wall Stops / Holders..... thru bolted (no prep)

- Approved models - IVES (attached to exterior with steel screws per manufacturers instructions. Interior application must use IVES FS495 thru bolted to the door, at the bottom only) only, min 6" from lock or strike side of door.

PUSH / PULL REINF not available

HINGES:

- 5" Universal in lieu of 4 1/2" UniversalN/C

- Approved models: IVES 3CB1, 3CB1HW, 3CB1NRP, 3CB1HWNRP, 3CB1SH, 3CB1HWSH, 5BB1, BB1HW,5BB1NRP, 5BB1HWNRP, 5BB1SH, 5BB1HWSH, 5BB1WT, 5BB1HW WT

- Additional hinge prep\$14

- High frequency prep\$45

- Continuous hinge (full-edge mounted only)N/C

- Approved models - IVES Alum Geared: 112HD, 112XY, 224HD, 224XY

- Approved models - IVES Steel Pin & Barrel: 600,700,700CS, 705

- Approved models - IVES Electric: TW8, TWP

LOCKS / LATCHES:

- Schlage MultiPoint, lever with CVR (concealed vertical rods)

Hardware Prep and Factory Installed CVR Assembly:

- 3-point: LM/LMV9300 (rose or escutcheon trim) \$2,102
- IVES SB360 Top and bottom surface bolts for inactive leaf.....N/C

EXIT DEVICES:

- Von Duprin, panic bar exit with SVR (surface rods, reinf only)

Hardware Prep Only:

- 2-point: WS98/9927(F).....N/C
- 3-point: WS98/9957(F)N/C

NOTES:

1. Only approved models are allowed; for more information on approvals see Tech Data, tornado section.
2. WS available as EO (exit only); NL (night latch) not available.

Prices subject to change without notice.

Standard Hardware Options:

Per prep

DOUBLE COMBO LOCKS: not available

DEADLOCKS: not available

STRIKES: not available

ROLLER LATCH:

- Lock edge:..... not available
- Top edge:..... not available

Electrical Preps (Reviewed by engineering / not available in OEM):

- Power transfer units (i.e. EPT2, EPT10, etc) \$90

- Approved models - Von Duprin EPT2, EPT1

- Electric hinge prep\$18

- Auto Operators.....N/C (specify reinf in available closer preps)

- Approved models - LCN 9953 for pairs, 9542 for singles (must be mounted to exterior/storm side of storm shelter or safe room). MUST order 5" heavy weight hinges and high frequency hinge reinforcements.

- Electric door closerN/C (specify reinf in available closer preps)

- Approved models - LCN Sentronic 4040SE, 4310ME (must be mounted to exterior/storm side of storm shelter or safe room).

- Magnetic Hold open.....specify reinf in available closer preps

- Approved models - LCN SEM 7800 (extenders not permitted on inswing applications. Locate away from hardware/rod locations to avoid interference).

- Door position switch (round 1/2" to 1" dia) \$15

- Approved models - Schlage 679-05, Sentrol 1078/1076 (must be mortised into the edge or top of the door, and into the door rabbet of the jamb or head of the frame).

- Magnetic switch (rectangular and mortised) \$76

- Approved models - Schlage 7764, Sentrol 2757, Securitron MSS-1 high security (must be mortised into the edge or top of the door, and into the door rabbet of the jamb or head of the frame).

- Wiring raceway (with conduit) \$135

KICK PLATES: no preps

- Approved models - IVES 8400 (metal or plastic), 8402 (metal) (must be secured with steel screws, 48" max height bottom of door only).

THRESHOLDS & GASKETING: no preps

- Approved models - ZERO (must not impede or affect the function of the opening or latching hardware)

FP14 COMPLETE FRAME PRICING						
Single Frame		JAMB DEPTH				
Width	Height	5 3/4"-5 7/8"	6"-7 7/8"	8"-9 7/8"	10"-11 7/8"	12"-14 3/4"
2'8" thru 4'0"	6'8"	537	581	630	674	763
	7'0"	575	618	666	709	798
	7'2"	637	679	727	771	861
	8'0"	697	739	787	832	922

Double Frame		JAMB DEPTH				
Width	Height	5 3/4"-5 7/8"	6"-7 7/8"	8"-9 7/8"	10"-11 7/8"	12"-14 3/4"
5'4" thru 8'0"	6'8"	673	718	767	808	896
	7'0"	703	748	795	838	926
	7'2"	765	806	857	900	988
	8'0"	825	868	917	960	1048

Paladin frames cannot be ordered as separate components

Available Sizes:	Single		Pair	
	Min.	Max.	Min.	Max.
3-Sided & Glass	3'0" x 6'8"	4'0" x 8'0"	6'0" x 6'8"	8'0" x 8'0"
4-Sided & Shutters	2'8" x 4'3"	4'0" x 8'0"	5'4" x 4'3"	8'0" x 8'0"

Standard Construction Options:

Per leaf

GALVANNEALED A-60 STEEL	N/C
4" FACE HEAD	\$39
MARK NUMBERS.....	N/C
DUTCH FRAME.....	not available
COMMUNICATING FRAME.....	not available
SPECIALPROFILE FRAMES.....	not available
HOSPITAL STOPS.....	not available

ANCHORS:

• New Masonry (e.g. new block and poured on site)	Per Frame
• Masonry-T.....	N/C
• Weld-in base anchor.....	N/C

Per prep

- Existing Masonry (MUST specify wall type on order)
- EMA TSCONC - Concrete walls (e.g. pre-fab and tilt-up)
- EMA TSBLOCK - Concrete-filled CMU Block walls
- Per prep:
 - Tube and Strap anchor, P&D, factory installation..... \$25
 - Bolts for 2" face jambs and heads..... \$5
 - Bolts for 4" face heads..... \$15
 - (lowest EMA serves as base anchor)

4 SIDED FRAME:

- Add for sill section..... \$85

12 GAUGE HEAD REINFORCING CHANNELstandard

LABELED FRAMES:	Single	Pair
UL:	not available	not available
ITS/WHI: Metal label (includes closer reinf.) *3, 1 1/2, 3/4 hour or 20 min (1 hr not avail)	\$75	\$75
FM:	not available	not available
ICC500-2014 / FEMA 361/320 Label	N/C	N/C

*Glass lights rated up to 1-1/2 hours max
Refer to the Steelcraft Tech Data Manual for all labeled approvals.

NOTES:

1. Jamb Depths
 - All FP frames are double rabbet only
 - Max JD 14 3/4". All frames listed are available in jamb depth increments of 1/8".
2. Door Opening Sizes
 - Standard frame sizes are listed.
 - Any non-standard frame width and / or height is priced as the next larger size frame category.
 - Available sizes displayed above.
3. Only available in 2" face with 2" or 4" face heads.
4. Case Open Frames are not available.
5. New Masonry anchors (Masonry T) and Existing Masonry anchors (installed Tube and Strap with punch and dimple) are required and will be added to the end of your order based on opening size and wall construction. See Steelcraft tech data for correct usage.

Prices subject to change without notice.

Standard Hardware Options:

Per prep

SPECIAL VERTICAL HARDWARE LOCATIONS:

- Hinge and lockN/C

SURFACE MOUNTED CLOSERS / HOLDERS / STOPS:

- Surface Mounted Closers:
 - 14" strap installedN/C
(Specify regular or parallel)

- Approved models - LCN 4000T, 4010, 4010T, 4020, 4020T, 4030, 4030T, 4040XP, 4040XPT, 4050, 4110, 4110T

- Approved models - FALCON SC70 (heavy duty), SC80A, SC60A

- Concealed or semi-concealed (per template)..... not available
- ALLE Concealed or semi-concealed (per template)..... not available
- Surface Overhead Holder/Stopspecify reinf in available closer preps

- Approved models - GJ 79S (extra heavy duty), 70S, 90S, 81S (79 series does not open 180 deg so application should be confirmed).

HINGES:

- 5" Universal in lieu of 4 1/2" UniversalN/C

- Approved models: IVES 3CB1, 3CB1HW, 3CB1NRP, 3CB1HWNRP, 3CB1SH, 3CB1HWSH, 5BB1, BB1HW,5BB1NRP, 5BB1HWNRP, 5BB1SH, 5BB1HWSH, 5BB1WT, 5BB1HW WT

- Additional hinge prep\$14

- High frequency prep\$16

- Continuous hinge (full-edge mounted only)N/C

- Approved models - IVES Alum Geared: 112HD, 112XY, 224HD, 224XY

- Approved models - IVES Steel Pin & Barrel: 600, 700, 700CS, 705

- Approved models - IVES Electric: TW8, TWP

Standard Hardware Options:

Per prep

STRIKES:

- Von Duprin
 - Vertical Rod reinf for 2-point: WS98/9927(F)N/C
 - Rim and Vertical Rod reinf for 3-point: WS98/9957(F)N/C
- Schlage
 - Vertical Rod reinf for 3-point: LM/LMV9300N/C
- IVES
 - SB360 Top and bottom surface bolts for inactive leafN/C
- Additional strikes not available
- Roller latch not available

Electrical Preps (Reviewed by engineering / not available in OEW):

- Power transfer units (i.e. EPT2, EPT10, etc) \$89

- Approved models - Von Duprin EPT2, EPT1

- Electric hinge prep\$36

- Auto OperatorsN/C (specify reinf in available closer preps)

- Approved models - LCN 9953 for pairs, 9542 for singles (must be mounted to exterior/storm side of storm shelter or safe room). MUST order 5" heavy weight hinges and high frequency hinge reinforcements.

- Electric door closerN/C (specify reinf in available closer preps)

- Approved models - LCN Sentronic 4040SE, 4310ME (must be mounted to exterior/storm side of storm shelter or safe room).

- Door position switch (round 1/2" to 1" dia) \$36

- Approved models - Schlage 679-05, Sentrol 1078/1076 (must be mortised into the edge or top of the door, and into the door rabbet of the jamb or head of the frame).

- Magnetic switch (rectangular and mortised) \$96

- Approved models - Schlage 7764, Sentrol 2757, Securitron MSS-1 high security (must be mortised into the edge or top of the door, and into the door rabbet of the jamb or head of the frame).

THRESHOLDS & GASKETING:no preps

- Approved models - ZERO (must not impede or affect the function of the opening or latching hardware).

NOTES:

1. Only approved models are allowed; for more information on approvals see Tech Data, tornado section.
2. Junction boxes provided with most electrical preps. Knockouts are designed to support 1/2" or 3/4" conduit.
3. Electrical preps will be reviewed by engineering and are not available in OEW.

Prices subject to change without notice.

INPACT™ DOOR SYSTEM PRICING

Door Width	L18	L16
UP TO 6'8" HIGH		
3'0"	3,066	3,257
Over 3'0" thru 3'6"	3,345	3,527
Over 3'6" thru 3'8"	3,389	3,578
Over 3'8" thru 4'0"	3,523	3,719
UP TO 7'0" HIGH		
3'0"	3,079	3,320
Over 3'0" thru 3'6"	3,380	3,578
Over 3'6" thru 3'8"	3,429	3,626
Over 3'8" thru 4'0"	3,551	3,768
UP TO 7'2" HIGH		
3'0"	3,170	3,389
Over 3'0" thru 3'6"	3,423	3,625
Over 3'6" thru 3'8"	3,473	3,675
Over 3'8" thru 4'0"	3,614	3,822
UP TO 8'0" HIGH		
3'0"	3,417	3,673
Over 3'0" thru 3'6"	3,703	3,919
Over 3'6" thru 3'8"	3,778	3,994
Over 3'8" thru 4'0"	3,919	4,142
UP TO 9'0" HIGH		
3'0"	3,725	3,980
Over 3'0" thru 3'6"	3,835	4,011
Over 3'6" thru 3'8"	3,886	4,085
Over 3'8" thru 4'0"	4,026	4,226
UP TO 10'0" HIGH		
3'0"	3,860	4,115
Over 3'0" thru 3'6"	3,970	4,146
Over 3'6" thru 3'8"	4,021	4,220
Over 3'8" thru 4'0"	4,161	4,361

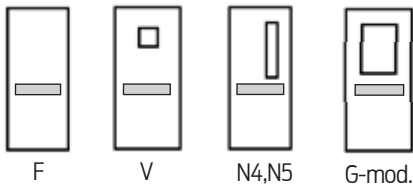

NOTES:

1. Minimum size 2'6" x 6'8" maximum size 4'0" X 10'0"
2. When ordering INPACT™ Door Systems the INPACT™ System Order Form must be used (download available online)
3. Warranty for INPACT™ Door System is based upon component warranties. Doors are one year from date of delivery
4. Half glass G light doors require a modified glass to accommodate the exit device location. Refer to the Tech Data Manual for glass size details
5. No deducts for omissions
6. GRAINTECH™ option add per page 60
7. See L or T-Series Doors for Prep Only (hardware ordered separately)

The Standard INPACT™ Door System includes:

- DOOR CONSTRUCTION:** Cold-rolled steel, honeycomb core
- STANDARD DOOR FINISH:** Factory applied primer
- Finish Paint and GRAINTECH™ available refer to pages 60-61
- EXIT DEVICE:** INPACT recessed fire-rated exit device model 9447EO-F, LBR (less bottom rod)
- EXIT FINISH:** US26D (Satin Chrome)
- HINGE:** Full mortise continuous hinge
- FIRE RATING:** (also see Options on the next page)
- 3 hour, single door, available using 94/9575-F
 - 3 hour, double door, same swing
 - 90 minute, double door, double egress
- GLASS LIGHTS** Designer Trim for 1/4" or 1/2" thick glass (1/4" standard):
- Standard size V, N4 or N5 \$148
 - Standard size G (see note 4) not available
 - Non-standard size V, N, G \$204
 - Non-standard size for labeled doors
 - Special size and glass thicknesses refer to page 59
- LIGHT / LOUVER CUTOUTS ONLY** (per cutout):
- Non-labeled cutout only \$35
 - Labeled and non-labeled cutout with channels \$112
- NON-STANDARD SIZE WIDTHS and HEIGHTS** price as next larger size door
- CORE MATERIAL OPTIONS:**
- Honeycomb Standard
 - Polystyrene \$27
 - Polyurethane (non-labeled only) \$127
- GALVANNEALED STEEL (A-60)** \$79
- GALVANIZED STEEL (G-90)** \$313
- 18, 16 or gauge only
 - Maximum 3'8" x 10'0" door size
- EDGE SEAM CONSTRUCTION OPTION:**
- LF (Filled) \$69
 - LW (Welded) not available
- UNDERCUT / FLOOR CLEARANCE:**
- 3/8" standard used with Concealed Vertical Rods N/C
 - 3/4" standard used with Mortise Locks N/C
 - Under 3/8" price as next larger size
- TOP CAPS FACTORY INSTALLED:**
- Screw-in cap (top or bottom) \$21
- MARK NUMBERS** N/C

LABELED SYSTEMS:	Per Leaf
UL:	
Door - Metal label (includes closer reinf.)	
Hardware - Fire Exit Hardware	
· 3, 1 1/2, 1 or 3/4 hour	67
· 20 minute	41
ITS/WHI:	not available
FM:	not available

Refer to the Steelcraft Tech Data Manual for all labeled approvals.

Prices subject to change without notice.

EXIT DEVICE OPTIONS:

· Concealed Vertical Rods – Top and Bottom Rod or LBR (Less Bottom Rod)

Device	US26D	US28	313AN	US10	US4	US3 US26	Standard Trim / Control	Description
94/9547EO-F	N/C	N/C	N/C	5	61	148	not available	Exit Only, No Outside Trim Plate
94/9547DT-F	358	278	298	363	359	517	550DT	Dummy Trim
94/9547L-F	535	455	491	580	596	750	940L	Lever, Key Locks & Unlocks Lever
94/9547L-BE-F	535	455	491	580	596	750	940L-BE	Lever, Blank Escutcheon, Always Operable
94/9547L-DT-F	603	523	560	646	664	786	940L-DT	Lever, Dummy Trim
94/9547TL-F	885	805	825	918	813	1,087	550DT/376T	Thumbturn Retracts Latch bolt

Other device options:

Per Leaf

· 48 Bottom Latch Assembly (used with longer latchbolt rod, needed for special floor clearances over 3/8")\$174

· Mortise Lock Device

Device	US26D	US28	313AN	US10	US4	US3 US26	Standard Trim / Control	Description
94/9575EO-F	227	227	227	245	304	389	not available	Exit Only, No Outside Trim Plate
94/9575DT-F	585	503	541	603	602	758	550DT	Dummy Trim
94/9575NL-F	585	503	541	603	602	758	550DT	Night Latch, Dummy Trim
94/9575L-F	762	680	734	820	839	991	940L	Lever, Key Locks & Unlocks Lever
94/9575L-BE-F	762	680	734	820	839	991	940L-BE	Lever, Blank Escutcheon, Always Operable
94/9575L-DT-F	830	748	803	886	907	1,027	940L-DT	Lever, Dummy Trim

NOTE: Concealed Vertical Rod and Mortise Lock Devices available as Panic or Fire Exit, specified on order form. Fire Exit Hardware cannot be mechanically dogged but can be dogged electronically (fire exits must positively latch when closed)

HINGE OPTIONS:

Device	US26D	US28	313AN
224HD Ives Continuous Geared Hinge	not available	N/C	N/C

CLOSER OPTIONS:

Device	689	690	696
4040XP with PA bracket and Std. Cover	N/C	N/C	N/C

NOTE: Hinge and Closer Shipped loose for field installation.

ELECTRICAL OPTIONS:

Per Prep

- LX – Latchbolt Monitoring Switch\$196
- QEL – Quiet Electric Latch Retraction\$693
- QEL LX – QEL with Latchbolt Monitoring\$889
- Door Prep for EPT\$97
- Continuous Hinge EPT prep\$106

Prices subject to change without notice.

GLASS LIGHT LOCATIONS

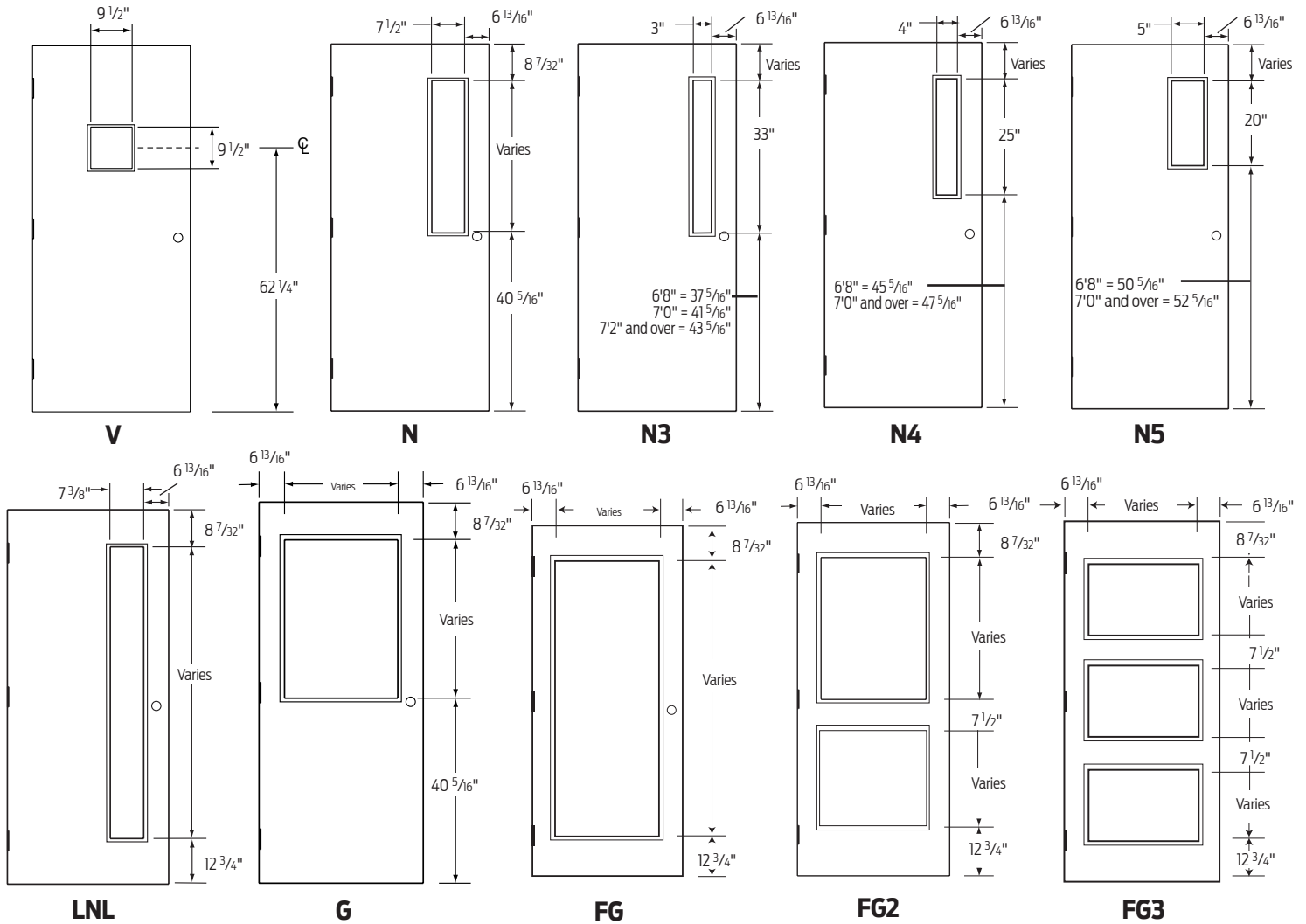

NOTES:

1. Glass light size and locations shown are Steelcraft standards
2. Dimensions shown are exposed glass sizes
3. See Tech Data Manual for additional information and glass cutting sizes
4. Glazing tape or putty glazing may be used
5. Glass cutting size equals exposed glass dimensions plus $1\frac{3}{16}''$
6. All FG doors ordered as cutout only will be priced and supplied with perimeter channels
7. Dimensions vary on special height doors
8. Exit device hardware may interfere with the Steelcraft standard N, N3 and G glass lights
Ordering options:
 - a. Order door with special glass light
 - b. Order door with special exit device hardware location
9. Not applicable to A14-Series. Refer to Steelcraft Tech Data Manual.

Prices subject to change without notice.

UNIT PRICE PER LEAF

NON-STANDARD LIGHT SIZES USING DEZIGNER TRIM

Applicable door series: labeled and non-labeled L, SL, B, T, CE and H-Series

- VS, NS or GS (n/a on T-Series)
 - Non-labeled \$204
 - Labeled \$228

Applicable door series: labeled and non-labeled L and A14-Series

- FGS (not available labeled) \$290
- FG2S \$435
- FG3S \$652

Applicable door series: non-labeled H-Series

- FGS (not available labeled) \$348
- FG2S (not available labeled) \$522
- FG3S (not available labeled) \$782

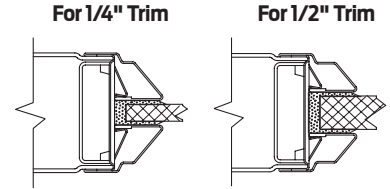

NOTE: Non-standard light sizes are any that vary from elevations shown on Standard Light Sizes page.

MULTIPLE LIGHTS USING DEZIGNER TRIM

Applicable door series: labeled and non-labeled L-Series

- Standard light sizes, add per additional light type V, N3, N4 or N5 \$148
- Non-standard light sizes, add per additional light type \$204

GLASS LIGHTS USING OVERLAPPING STEEL TRIM (FOR 1/4" THRU 1" GLASS)

Applicable door series: labeled and non-labeled L, SL, B, T, CE, H and HE-Series

- Any standard or non-standard size V, N, N3, N4, N5, G or LNL \$333
- Any standard or non-standard size FG L, H* and A14-Series only \$445
- Any standard or non-standard size FG2 L, H* and A14-Series only \$572
- Any standard or non-standard size FG3 L, H* and A14-Series only \$763

** Use 1" Trim only on H-Series doors*

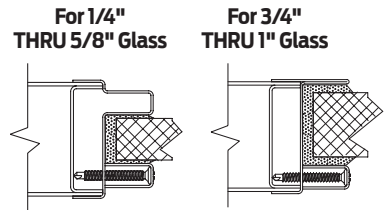

GLASS LIGHTS USING FLUSH MOUNTED STEEL TRIM (FOR 1/4" OR 1" GLASS)

Applicable door series: labeled or non-labeled L, SL, B and T-Series only (1/4" glass)

- Any standard or non-standard size V, N3, N4 or N5 \$334
- Any standard or non-standard size G, N or LNL \$366
- Any standard or non-standard size FG L-Series only \$435
- Any standard or non-standard size FG2 L-Series only \$583
- Any standard or non-standard size FG3 L-Series only \$651

Applicable door series: labeled or non-labeled L, SL, B, and T-Series only (1" glass)

- Any standard or non-standard size V, N3, N4 or N5 \$413
- Any standard or non-standard size G, N or LNL \$445
- Any standard or non-standard size FG L-Series only \$514
- Any standard or non-standard size FG2 L-Series only \$662
- Any standard or non-standard size FG3 L-Series only \$763

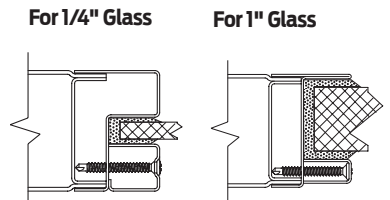

NOTES: Standard size V, N3, N4 and N5 may be placed at a non-standard location at no extra charge.

Not available on 14 GA doors

CIRCULAR / OVAL LIGHT CUTOUTS ONLY

Applicable door series: see below

- Cutout only, no perimeter channel L-Series \$126
- Cutout with perimeter channel L and B-Series \$252

NOTES:

1. Perimeter channels are required for all labeled doors and B-Series doors.
2. Consult factory for minimum stile and rail requirements.

Circular or Oval Cutout

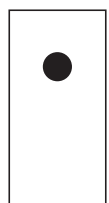

Prices subject to change without notice.

FLUSH DOORS: L, T and H-SERIES

Type	Door Width	Factory Stained	Prime Painted
Single Door	Up to 3'4"	613	84
	Over 3'4" up to 4'0"	650	103
Double Door	Up to 3'4"	1226	168
	Over 3'4" up to 4'0"	1300	206
Dutch door	Up to 4'0"	1226	167
Transom panels	Up to 8'0" x 4'0" (1 3/4")	650	103

EMBOSSED PANEL: CE-18 and CE-16 SERIES (E6, HD2 and HD2A designs only)

Type	Door Width	Factory Stained	Prime Painted
Single Door	Up to 3'4"	743	84
	Over 3'4" up to 4'0"	780	103
Double Door	Up to 3'4"	1486	168
	Over 3'4" up to 4'0"	1560	206

NOTES:

1. Max. width for HD2A design is 3'4"

GLASS LIGHT OPTIONS

L-Series V, N3, N5, N4, NL, G, FG, FG2 and FG3:		
Door Width	Factory Stained	Prime Painted
Single doors: Up to 3'4" wide	706	112
Over 3'4" up to 4'0" wide	743	139
Double doors: Up to 3'4" wide	1412	224
Over 3'4" up to 4'0" wide	1486	278

CE-Series E4TL:		
Door Width	Factory Stained	Prime Painted
Single doors: Up to 3'4" wide	836	112
Over 3'4" up to 4'0" wide	873	139
Double doors: Up to 3'4" wide	1672	224
Over 3'4" up to 4'0" wide	1746	278

OTHER OPTIONS:

	Factory Stained	Prime Only
• Factory stained astragal (not EP4 material)	N/C	N/C
• Custom color set up charge - add per custom color	\$165	not available
• Prime stained steel dutch door shelf	not available	\$113

NOTES:**Factory Stained:**

1. Not available on doors with Seam Filled Edges
2. L-Series doors available in 18 and 16 gauge, label or non-label with honeycomb, polystyrene or polyurethane core
3. T-Series doors available in 18 and 16 gauge with temperature rise core
4. CE-Series doors, available in 18 and 16 gauge, label or non-label with polystyrene core
5. H-16 Series doors, label or non-label with honeycomb, polystyrene, polyurethane or temperature rise core
6. Add prices shown above to the list price of a galvanized door.
7. Maximum height 10'0" 18 and 16 gauge
8. For extra quart of stain please specify on order and list price is \$100

Prime Painted (for field staining):

1. Not available on doors with Seam Filled Edges
2. Prime painted stainable doors are ready for staining and top coating labor and material by others
3. Add prices shown above to the list price of a galvanized door

Prices subject to change without notice.

CUSTOM DOOR OPTIONS

CONSTRUCTION

DOORS

DOORS - FINISH PAINT INFORMATION

Colors available on all Door Series and Sizes; CRS or Galvanneated A-60.
Add two additional weeks to our Standard, 4-week, lead time.

NET PRICES

- **Set-up per color, per order** \$300 (net)
- **Price per leaf** \$55 (net)

NOTE: 1. Non-standard colors are available, consult Customer Care for pricing, lead time and request form to complete.

DOORS OMIT PRIME

- **Omit prime paint - Limits manufacturers warranty** \$65

Standard Colors

P2807 Rookwood Brown	P6128 Blonde
P2820 Downing Earth	P6130 Mannered Gold
P2821 Downing Stone	P6300 Burgundy
P2822 Downing Sand	P6314 Luxurious Red
P2837 Aurora Brown	P7598 Sierra Redwood
P2841 Weathered Shingle	P7603 Poolhouse
P2850 Chelsea Gray	P7622 Homberg Gray
P6006 Black Bean	P7623 Cascades
P6074 Spalding Gray	P7630 Raisin

ASTRAGALS - FACTORY ATTACHED

UNIT PRICE
PER LEAF

- **Flat bar type** –14 gauge, surface applied tack welded to face of door \$87
(push side mount / pull side mount)
- **2 Piece astragal** – 2 piece astragal (price covers attachment to both leaves) \$155
(push side mount / pull side mount)
- **Z-Astragal** \$133

NOTE:

1. Applicable door series: labeled and non-labeled L, A14, B, T, CE-Series



AUTOMATIC DOOR BOTTOM

- **Auto door bottom prep (recessed channel)** \$161

NOTES:

1. 14 gauge channel installed
2. Edge prep not included

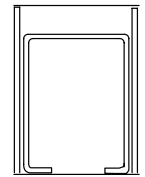

TOP / BOTTOM CHANNEL APPLICATIONS

- **Special depth (inverted top or bottom) recessed greater than 3/4" deep** \$135

NOTES:

1. Standard inverted 14 gauge top or bottom channel
2. Specify depth

- **Flush and filled 18 gauge channel**

- Screwed and Sealed into top channel \$158

- **Recessed 18 gauge channel (screwed-in)**

- Recessed 1/8" below top of door \$21

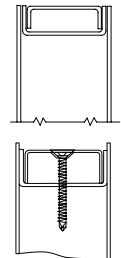

MONO RAIL

- **Applicable door series: non-labeled L and B-Series only**

- Rectangular cutout and channel installed \$319

NOTE:

1. Consists of rectangular cutout in corner or edge of door L and B-Series; maximum size is 8" wide x 24" high

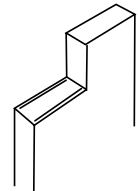

DOOR VIEWER

- Prep per template (max diameter = 3") \$17

MAIL SLOT

- Cutout only \$35
- Cutout with channels \$112

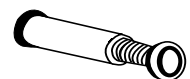

CLOSER

- 12 ga closure reinforcement \$38

Prices subject to change without notice.

1 3/4" STAINLESS STEEL DOORS 18 GA & 16 GA
#4 BRUSHED SATIN OR 2B MILL FINISH, POLYSTYRENE CORE

FLUSH - Type 304 SS		SEAMLESS DOOR EDGE		INTERLOCKING DOOR EDGE	
Width	Height	18 GA	16 GA	18 GA	16 GA
3' 0	7' 0	2,800	3,300	2,540	3,040
3' 0	7' 6	2,910	3,430	2,650	3,170
3' 0	8' 0	3,010	3,560	2,750	3,300
3' 6	7' 0	3,040	3,570	2,780	3,380
3' 6	7' 6	3,150	3,700	2,880	3,440
3' 6	8' 0	3,250	3,830	2,980	3,570
4' 0	7' 0	3,280	3,850	3,020	3,580
4' 0	7' 6	3,390	3,980	3,130	3,720
4' 0	8' 0	3,490	4,100	3,230	3,840

FLUSH - Type 316 SS		SEAMLESS DOOR EDGE		INTERLOCKING DOOR EDGE	
Width	Height	18 GA	16 GA	18 GA	16 GA
3' 0	7' 0	4,000	4,500	3,780	4,240
3' 0	7' 6	4,170	4,730	3,910	4,460
3' 0	8' 0	4,350	4,860	4,080	4,600
3' 6	7' 0	4,400	4,930	4,130	4,670
3' 6	7' 6	4,570	5,160	4,300	4,900
3' 6	8' 0	4,740	5,290	4,480	5,030
4' 0	7' 0	4,780	5,360	4,520	5,100
4' 0	7' 6	4,950	5,580	4,680	5,320
4' 0	8' 0	5,130	5,720	4,870	5,450

ELEVATION OPTIONS

	F	G	V	N	BL
--	---	---	---	---	----

FLUSH (F)	Type 304 SS	Type 316 SS
HALF GLASS (G)	275	325
10"x10" VISION (V)	200	250
NARROW LITE (N)	200	250
BOTTOM LOUVER	625	825
TOP LOUVER	625	825

Note: Lite kits are based upon 3/16" - 5/16" thick glass by others.

CORE OPTIONS

Polystyrene (STY).....	0
Honeycomb (HC).....	250
Polyurethane (URE).....	300

TOP and BOTTOM END CHANNELS

Inverted U Channel.....	0
Close Top Flush (CTF).....	150
Close Bottom Flush (CBF).....	150
Cap & Seal Top (SEALT).....	200
Cap & Seal Bottom (SEALB).....	200

LABEL (Intertek WH)

up to 3 hours.....	100
--------------------	-----

HARDWARE PREP OPTIONS

HINGES:

4 1/2" Reg Weight (45X).....	0
4 1/2" Extra Heavy (H45X).....	0
5" Extra Heavy (H50X).....	0
Continuous Hinge Reinforcement (CH).....	250
(drilling & tapping not included)	
Electric Hinge (EH).....	0
Cylindrical Lock (161).....	0
Cylindrical Deadlock (161D).....	0
Mortise Lock (MD).....	0
Mortise Deadlock (86D).....	0
Rim Exit Device (RE).....	0
Surface Vertical Rod Exit Device (SVRE).....	0
Concealed Vertical Rod Exit Device (CVRE).....	150
Surface Closer (CL).....	0
Concealed Closer (CC).....	150
Surface Overhead Stop / Holder (OS).....	0
Concealed Overhead Stop / Holder (COS).....	150
Electric Power Transfer (EPT).....	50
Conduit Raceway (COND).....	250
4 7/8" ASA Strike (ASA).....	0
2 3/4" T Strike (T).....	0
2 3/4" Deadlock Strike (DL).....	0
3 1/2" Deadlock Strike (DLS312).....	0
Electric Strike (ES).....	150
Flat Bar Astragal (AST).....	0
ASA Flush Bolts (FBX12).....	0
Auto Flush Bolts - Top Only (AFB1212).....	0
Auto Flush Bolts - Bottom Only (AFB12).....	0
Flushbolts Bottom Only (FB12B).....	0
Surface Bolts (SB).....	0

Prices subject to change without notice.

Call For Custom Options
 Due to fluctuations in cost stainless steel, prices are subject to change

Customer Care: 1-877-671-7011 (ask for estimating)
 e-mail: Steelcraftestimating@allegion.com

FLUSH DOOR PRICING - GALVANNEALED AND POLYSTYRENE

Door Width	SZ18 20-Pack	SZ18 10-Pack	SZ18 Singles
6'8" HIGH			
2'6" thru 3'0"	8561	4409	449
Over 3'0" thru 3'6"	9996	5148	525
Over 3'6" thru 4'0"	10690	5506	561
7'0" HIGH			
2'6" thru 3'0"	8853	4559	465
Over 3'0" thru 3'6"	10287	5298	540
Over 3'6" thru 4'0"	10982	5656	577



Typical Elevations

FLUSH DOOR PRICING - CRS AND HONEYCOMB

Door Width	SZ18 20-Pack	SZ18 10-Pack	SZ18 Singles
6'8" HIGH			
2'6" thru 3'0"	7644	3936	401
Over 3'0" thru 3'6"	9078	4675	477
Over 3'6" thru 4'0"	9773	5033	513
7'0" HIGH			
2'6" thru 3'0"	7927	4082	416
Over 3'0" thru 3'6"	9361	4821	491
Over 3'6" thru 4'0"	10056	5179	528

Standard Construction Options: Per leaf

- INACTIVE LEAVES** (price pairs of doors as 2 single leaves):
Note: Due to hardware and astragal applications the inactive leaf options carry an up charge.
- Locking / latching hardware with Z-Astragal included in door charge. Hardware and Prep options..... \$86
 - Two (2) ANSI Flushbolt preps, one (1) 4 7/8" ANSI strike with Z-Astragal, or
 - Two (2) Surface Bolt reinf., one (1) 4 7/8" ANSI strike with Z-Astragal
 - Wide inactive leaf not available
- CORE AND MATERIAL:** (see pricing tables above)
- Honeycomb & CRS will be default if not indicated
- 18 GAUGE STEEL**standard
- NON-STANDARD SIZE WIDTHS** ... price as next larger size door
- UNDERCUT / FLOOR CLEARANCE** (3/4" standard)
- 3/4" or 3/8" only N/C
- TOP CAPS** (Loose) not included, available from 'Parts'

NOTES:

1. **ALL construction and hardware options are shown on this page.**
2. Minimum size 2'6" x 6'8" / maximum size 4'0" x 7'0".
3. Available in 6'8" and 7'0" heights only.
4. For expanded options, please see SL and L-Series doors.

Standard Hardware, Preps and Options:

- CLOSERS / HOLDERS / STOPS:**
- Surface Mounted:
 - Closer – 20" reinf. only.....standard
- HINGES:**
- (3) Non-handed 4-1/2" square hingesstandard
 - Special Vertical Hardware Locations N/C
 - Additional hingesnot available
 - Continuous hinge (no internal reinf.)..... N/C
- LOCK / LATCH OPTIONS:**
- Cylindrical Locks: 161 or 61L N/C
 - Mortise Locks: 86ED N/C
 - Special Vertical Hardware Locations..... N/C
 - Additional locksnot available
 - Blank locknot available
- STRIKES:**
- ASA (4 7/8" ANSI A115.1)standard
 - Strike Prep in Steelcraft or alternate locations..... N/C
 - Additional strikesnot available
 - Blank strike.....not available
- EXIT DEVICE PREP:**
- Rim Reinf. only \$34

LABELED DOORS:	Single	Pair
UL:	*not available	*not available
ITS/WHI: • 11/2 Mylar label	standard	standard
FM:	*not available	*not available
ASTM E-330 (Uniform Static Air Pressure)	*not available	*not available

*Refer to the Steelcraft Tech Data Manual for all labeled approvals.

Prices subject to change without notice.

TABLE OF CONTENTS

COORDINATORS.....73

CLOSERS73

FLUSHBOLTS73

RESCUE HARDWARE.....73

HINGES 74

HOLDERS AND STOPS..... 74

LOCKS AND STRIKES75

PIVOTS..... 76

PUSH / PULLS..... 76

Prices subject to change without notice.

COORDINATORS / CLOSERS / FLUSHBOLTS / RESCUE HARDWARE

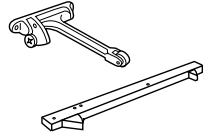
HARDWARE DEVICE	PREP PRICING		Illustration
	DOOR	FRAME	
COORDINATORS			
Face mounted strap reinf.	not applicable	16	
Soffit mounted full length reinf.	not applicable	48	

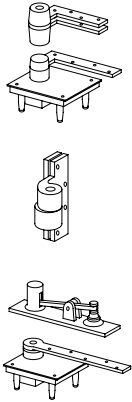
HARDWARE DEVICE	PREP PRICING		Illustration
	DOOR	FRAME	
CLOSERS - FLOOR MOUNTED CONCEALED			
Single acting Top prep in frame and door, bottom arm in door	437	102	
Single acting Intermediate (when specified)	124	59	
Double acting (includes aluminum nosing) Top prep frame and door, bottom arm in door	437	102	

HARDWARE DEVICE	PREP PRICING		Illustration
	DOOR	FRAME	
FLUSHBOLTS			
ANSI A115.4 manual or automatic (universal strike)	86	42	
Non-ANSI manual or automatic	267	69	

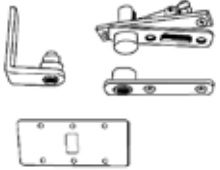

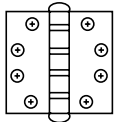
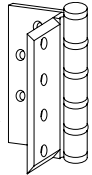
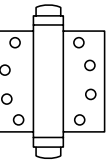
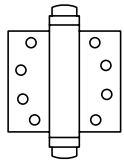
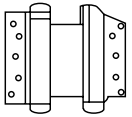
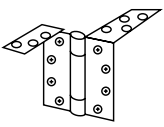
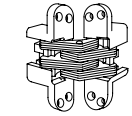
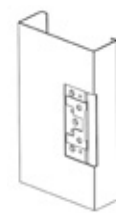
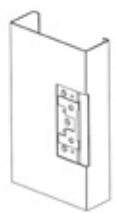

HARDWARE DEVICE	PREP PRICING		Illustration
	DOOR	FRAME	
RESCUE HARDWARE			
· Pivot, Emergency Release stop	437	211	
· Double Lip strike	not applicable	114	

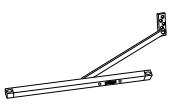
Prices subject to change without notice.

HARDWARE DEVICE	PREP PRICING		Illustration
	DOOR	FRAME	
HINGES			
Butt hinges:			
· 4" x 4" standard weight (L-Series, 20 gauge doors only)	34	33	
· Non-standard size / non-template prep			
1 1/2 pair	219	165	
2 pair	292	220	
· Special heavy weight hinge in lieu of universal	15	15	
(4 1/2" or 5" heavy weight hinge for F & MU-Series)			
· Double mortise or over mortise	37	23	
(4 1/2" or 5" standard or heavy weight prep)			
· Surface mounted hinge (reinf. only)			
1 1/2 pair	81	60	
2 pair	108	80	
· Full jamb depth reinf. (universal 4 1/2" or 5")			
(per prep) thru 8 7/8"	not applicable	35	
9" thru 20"	not applicable	65	
Spring hinges, single-acting type:			
· 4 1/2" or 5" templated hinge	N/C	N/C	
· Non-template hinge	250	84	
(reinf. only, no holes)	375	126	
Spring hinges, double-acting type (prices include nosing applied to lock side of door):			
· 4 1/2" or 5" templated hinge	105	N/C	
· Non-template hinge	250	84	
· Reinf. only (no holes)	375	126	
NOTE: Special door size may be required for clearance.			
Anchor hinge (mortised and reinf.):			
· No drill holes, untapped	360	360	
· Factory drilled and tapped	458	467	
(frame must be welded, welding charges not included, price includes 5" hinge preps)			
Invisible hinge (SOSS)			
(L-Series doors and F-Series frames)			
1 1/2 pair	585	585	
2 pair	780	780	
Cased open frame hinge prep - add to cased open frame price:			
· Single door opening	not applicable	42	
· Double door opening	not applicable	84	
NOTE: For use with applied stop (not included).			

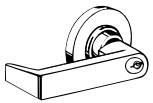
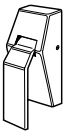
HARDWARE DEVICE	PREP PRICING		Illustration
	DOOR	FRAME	
HOLDERS AND STOPS			
· Concealed (track in door)	242	72	
· Surface reinf. in frame and door	50	16	
· ALLE concealed (track in door)	214	64	

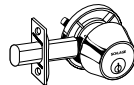
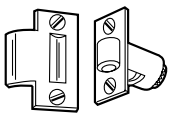
LOCKS AND STRIKES

HARDWARE DEVICE	PREP PRICING		Illustration
	DOOR	FRAME	
LOCKS AND STRIKES			
• Government 161 - with thru-bolt trim holes.....	15.....	not applicable	
• Special backset - 161 and 61L (3 3/4" or 5")	34.....	not applicable	
• Hospital push / pull latch at any one location (special backset included, 5" standard).....	48.....	not applicable	
• Push button access control lock	38.....	not applicable	
• Non-ANSI mortise lock or Government 85 (prep at any one location).....	180.....	not applicable	
• Unit / Mono / Rigid Lock	50.....	not applicable	
• Dummy trim reinf.	24.....	not applicable	
• Deadlock - at any one location cylindrical, mortise or tubular type (minimum 7" above or below standard lock prep)	45.....	15	
• ALLE Deadlock - at any one location.....	38.....	15	
• Roller latch prep in lock edge or top of door	61.....	30	
• 161 lock edge	N/C.....		
• ANSI strike preps.....	N/C.....	N/C	
• Double acting door - lock or strike prep.....	150.....	not applicable	
• Exit alarm lock reinf.	38.....	not applicable	
(reinf. only, cylinder holes not included)			
• Magnetic / shear lock - mortised prep in top of door	255.....	160	
• Security jamb locks (lock prep in strike jamb, strike prep in door edge)			
• Jamb lock for 2" face frame.....	120.....	113	
Folger Adams NS400 Series or Brinks 3526			
• Jamb Lock for 8" face frame	120.....	567	
Folger Adams 120 Series or Airteq 9700			
NOTE: Special frame profile and anchor charges are applicable.			
Cased open frame strike prep - add to cased open frame price:			
• Single door opening.....	not applicable.....	42	
NOTE: For use with applied stop (stop not included).			

Prices subject to change without notice.

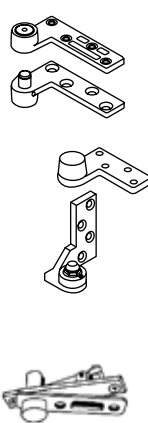
HARDWARE DEVICE	PREP PRICING		Illustration
	DOOR	FRAME	
PIVOTS			
<ul style="list-style-type: none"> • Single acting: <ul style="list-style-type: none"> • Mortised preps: <ul style="list-style-type: none"> • Top and bottom prep in door, top prep only in frame 330 73 • Top and bottom prep in door and frame 330 175 • Intermediate prep in door and frame per prep 124 59 • Surface mounted: <ul style="list-style-type: none"> • Top, intermediate or bottom per reinf. 49 49 • Double acting: <ul style="list-style-type: none"> • Top and bottom prep in door. Includes nosing on lock or hinge edge 330 75 • Top prep only in cased open frame • Reinforcing pivot (for use in conjunction with standard 4 1/2" or 5" hinges): <ul style="list-style-type: none"> • Reinf. only for top pivot in face of door and frame 128 68 • Pocket pivots (see notes below): <ul style="list-style-type: none"> • F-Series and DE-Series double egress 1 1/2 pair 456 384 per jamb 2 pair 608 512 per jamb • FE-Series double egress 1 1/2 pair 456 384 per jamb 2 pair 608 512 per jamb 			
<p>Notes:</p> <ol style="list-style-type: none"> 1. Most pocket pivot preps require a frame face larger than 2". 2. Frames must be welded. Add applicable welding charges. 3. FE-Series double egress frames require special frame profile and special anchors charges. 			

HARDWARE DEVICE	PREP PRICING		Illustration
	DOOR	FRAME	
PUSH / PULLS			
<ul style="list-style-type: none"> • Flush pull - at any one location <ul style="list-style-type: none"> • Cutout and reinf. 72 not applicable • Push / pulls <ul style="list-style-type: none"> • Plate reinf. 24 not applicable • Bar reinf. 44 not applicable • Light weight impact door reinf. (i.e., Eliason Easy Swing) not applicable 78 			

Prices subject to change without notice.

TABLE OF CONTENTS

LINEAL INCH STICK PRICING

F16-Series.....	78
F14-Series.....	79
Cut and notch options.....	80
Cut, notch and weld options.....	81
Options (construction and hardware).....	82

STICKS LENGTHS (TSF PARTS)

TSF nomenclature.....	83
F16 and FN16-Series.....	85
F14 and FN14-Series.....	87
Options (construction and hardware).....	87

TRANSOM FRAMES WITHOUT TRANSOM BARS

F16 and FN16-Series.....	90
F14 and FN14-Series.....	91
DW16 and MU16-Series.....	92

BORROWED LIGHT FRAMES

F16-Series.....	93
F14-Series.....	94
DW16-Series.....	95
DW14-Series.....	96

LAMINATED TRANSOM PANELS

1¾" L-Series, fixed or removable.....	97
Open edge, ½" and ¾" thick.....	97

OPEN SECTION

Frame Section	Description	3" - 5 ⁷ / ₈ "		6" - 7 ⁷ / ₈ "		8" - 9 ⁷ / ₈ "		10" - 11 ⁷ / ₈ "		12" - 14 ³ / ₄ "	
		CRS	GALV	CRS	GALV	CRS	GALV	CRS	GALV	CRS	GALV
	2" face only	0.95	1.10	1.05	1.17	1.34	1.46	1.59	1.79	1.94	2.13
	1" thru 4" face	1.29	1.44	1.40	1.52	1.78	1.92	2.09	2.24	2.54	2.66
	Over 4" face	Use sill section pricing									

CLOSED SECTION (MULLIONS)



Frame Section	Description	3" - 5 ⁷ / ₈ "		6" - 7 ⁷ / ₈ "		8" - 9 ⁷ / ₈ "		10" - 11 ⁷ / ₈ "		12" - 14 ³ / ₄ "	
		CRS	GALV	CRS	GALV	CRS	GALV	CRS	GALV	CRS	GALV
	2" face only	2.13	2.36	2.43	2.69	2.71	2.90	3.16	3.52	3.79	4.14
	1" thru 4" face	2.77	2.97	3.20	3.33	3.47	3.60	4.13	4.39	4.72	5.13
	Over 4" thru 8"	3.54	3.70	4.02	4.16	4.35	4.48	4.94	5.48	5.90	6.21
	Over 8" thru 12"	3.79	3.96	4.30	4.45	4.66	4.80	5.29	5.86	6.31	6.64

SILL SECTION

Frame Section	Description	3 ³ / ₄ " - 5 ⁷ / ₈ "		6" - 7 ⁷ / ₈ "		8" - 9 ⁷ / ₈ "		10" - 11 ⁷ / ₈ "		12" - 14 ³ / ₄ "	
		CRS	GALV	CRS	GALV	CRS	GALV	CRS	GALV	CRS	GALV
	4 ¹ / ₈ " thru 8 ¹ / ₈ " face	-	2.41	-	2.90	-	3.12	-	3.34	-	3.69
	8 ¹ / ₄ " thru 16 ¹ / ₈ " face	-	2.73	-	3.15	-	3.33	-	3.77	-	4.18

NOTE: Sill sections are available in galvanized only.

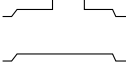
CORNER POSTS AND FILLER PLATES

Frame Section	Description	3 ³ / ₄ " - 5 ⁷ / ₈ "		6" - 7 ⁷ / ₈ "		8" - 9 ⁷ / ₈ "		10" - 11 ⁷ / ₈ "		12" - 14 ³ / ₄ "	
		CRS	GALV	CRS	GALV	CRS	GALV	CRS	GALV	CRS	GALV
	2-way or 3-way corner post (4 ³ / ₄ " min.)	4.08	4.27	4.30	4.47	4.49	4.70	5.23	5.45	6.20	6.33
	Filler plates - weld-in with or without stop	1.08	1.20	1.19	1.31	1.26	1.39	1.40	1.52	1.70	1.82
	Filler plates - snap in with stop only	1.43	1.56	1.48	1.60	1.52	1.64	1.68	1.79	1.75	1.87

NOTES:

- Jamb Depths over 14³/₄" thru 20"
 - Open section multiply 12" thru 14³/₄" column by 1.1
 - Closed section multiply 12" thru 14³/₄" column by 1.2
- See special profile Options page for MU profile Pricing.
- G-90 galvanize - multiply "GALV" price by 1.25 (maximum height 120")
- Sill sections 16¹/₄" thru 18" face, multiply price by 1.6
 - MU-Series sill, 4" face max

Prices subject to change without notice.

OPEN SECTION

Frame Section	Description	3" - 5 ⁷ / ₈ "		6" - 7 ⁷ / ₈ "		8" - 9 ⁷ / ₈ "		10" - 11 ⁷ / ₈ "		12" - 14 ³ / ₄ "	
		CRS	GALV	CRS	GALV	CRS	GALV	CRS	GALV	CRS	GALV
	2" face only	1.13	1.26	1.31	1.43	1.65	1.79	1.86	1.99	2.30	2.47
	1" thru 4" face	1.50	1.68	1.63	1.78	2.10	2.21	2.34	2.47	2.95	3.08
	Over 4" face	Use sill section pricing									

CLOSED SECTION (MULLIONS)

Frame Section	Description	3" - 5 ⁷ / ₈ "		6" - 7 ⁷ / ₈ "		8" - 9 ⁷ / ₈ "		10" - 11 ⁷ / ₈ "		12" - 14 ³ / ₄ "	
		CRS	GALV	CRS	GALV	CRS	GALV	CRS	GALV	CRS	GALV
	2" face only	2.47	2.66	3.01	3.17	3.27	3.43	3.72	3.93	4.42	4.62
	1" thru 4" face	3.17	3.36	3.81	3.97	4.14	4.29	4.77	4.94	5.49	5.97
	Over 4" thru 8"	4.01	4.19	4.43	4.64	4.90	5.09	5.50	5.65	6.67	7.05
	Over 8" thru 12"	4.12	4.38	4.77	4.98	5.25	5.41	5.61	5.74	7.02	7.15

SILL SECTION

Frame Section	Description	3 ³ / ₄ " - 5 ⁷ / ₈ "		6" - 7 ⁷ / ₈ "		8" - 9 ⁷ / ₈ "		10" - 11 ⁷ / ₈ "		12" - 14 ³ / ₄ "	
		CRS	GALV	CRS	GALV	CRS	GALV	CRS	GALV	CRS	GALV
	4 ¹ / ₈ " thru 8 ¹ / ₈ " face	-	2.83	-	3.41	-	3.83	-	4.09	-	4.53
	8 ¹ / ₄ " thru 16 ¹ / ₈ " face	-	3.22	-	3.63	-	4.02	-	4.39	-	5.49

NOTE: Sill sections are available in galvanized only.

CORNER POSTS AND FILLER PLATES

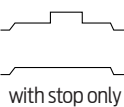
Frame Section	Description	3 ³ / ₄ " - 5 ⁷ / ₈ "		6" - 7 ⁷ / ₈ "		8" - 9 ⁷ / ₈ "		10" - 11 ⁷ / ₈ "		12" - 14 ³ / ₄ "	
		CRS	GALV	CRS	GALV	CRS	GALV	CRS	GALV	CRS	GALV
	2-way or 3-way corner post (4 ³ / ₄ " min.)	4.41	4.58	4.74	4.89	5.29	5.53	5.90	6.12	6.93	7.10
	Filler plates - weld-in with or without stop	1.24	1.41	1.32	1.48	1.41	1.57	1.65	1.81	2.08	2.24
	Filler plates - snap in	1.47	1.63	1.57	1.73	1.66	1.83	1.75	1.91	2.20	2.36

NOTES:

- Jamb Depths over 14 ³/₄" thru 20"
 - Open section multiply 12" thru 14 ³/₄" column by 1.1
 - Closed section multiply 12" thru 14 ³/₄" column by 1.2
- See special profile Options page for MU profile Pricing.
- G-90 galvanize - multiply "GALV" price by 1.25 (maximum height 120")
- Sill sections 16 ¹/₄" thru 18" face, multiply price by 1.6
 - MU-Series sills, 4" face max

Prices subject to change without notice.

The following prices are to be used for frame elevations that are to be cut and notched by Steelcraft. Welding charges are not included in the prices shown.

MITERED CORNER – OPEN SECTION:	Per end	
<ul style="list-style-type: none"> • Cut on a 45° angle \$10 Corner tabs or clips are not included on saw miter material 		

NOTCHED – OPEN SECTION:	Per end	
<ul style="list-style-type: none"> • Square end cut and notch for butt welding thru 4" face \$10 		

NOTCHED – CLOSED SECTION:	Per end	
<ul style="list-style-type: none"> • Square end cut and notch for butt welding \$13 		

NOTCHED – SILL SECTION:	Per end	
<ul style="list-style-type: none"> • Square end cut and notch for butt welding over 4" face \$13 		

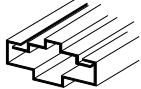
FILLER PLATES INSTALLED OPEN SECTION:	Per length	
<ul style="list-style-type: none"> • Square end, cut and notched and tackwelded thru 36" \$33 over 36" \$49 		

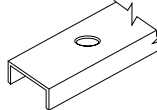
GLAZING BEADS:		
NOTES:		
<ul style="list-style-type: none"> 1. Beads are not included in stick section pricing. They may be ordered from the Parts Section in stick lengths not available 		

HARDWARE PREP:	Per strike	
<ul style="list-style-type: none"> • 4 7/8" ASA or 2 3/4" CYL strike prep \$14 		
<ul style="list-style-type: none"> • 4 1/2" x 4 1/2" or 5" hinge prep \$14 	Per hinge	
NOTES:		
<ul style="list-style-type: none"> 1. Prices are for standard hinge and strike prep in an open or closed section 2. For special hardware preps, refer to hardware Options page 		

SPECIAL ANGLE MITER OR NOTCH:	Per setup
<ul style="list-style-type: none"> • Setup charge \$660 	
NOTES:	
<ul style="list-style-type: none"> 1. For any frame requiring a special angle end cut other than 45° or 90° 2. This set-up charge is for each frame or multiple like frames of the same jamb depth requiring a different miter or notch angle 	

PARTIAL SIDE LIGHT NOTCH:	Per piece	
<ul style="list-style-type: none"> • Add to closed section price F-Series only \$24 		

Prices subject to change without notice.





LINEAL INCH STICK PRICING

FACTORY ASSEMBLY AND WELD

CUT, NOTCH and WELD OPTIONS

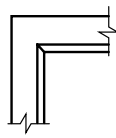
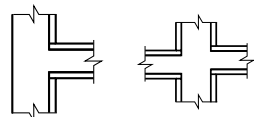
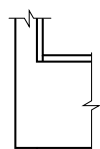
STICKS

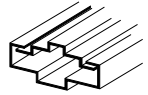
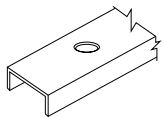
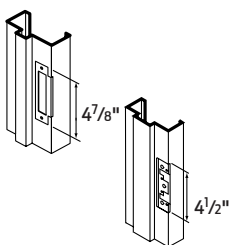
The following prices are to be used for frame elevations that are to be cut, notched and welded by Steelcraft. The units are shipped as a complete unit unless prohibited by shipping size limitations.

MITERED OR BUTTED CORNER JOINT:		Per joint	
· Face weld and finished smooth	1" to 2" face.....	\$56	
	Over 2" to 4" face.....	\$76	
· Complete profile	1" to 4" face.....	\$85	
MULLION "T" JOINT:			
· Face weld and finished smooth	1" to 2" face.....	\$64	
	Over 2" to 4" face.....	\$76	
	Over 4" to 12" face.....	\$93	
SILL-BUTTED CORNER JOINT:			
· Face weld and finished smooth	1" to 2" face.....	\$56	
	Over 2" to 4" face.....	\$76	
	Over 4" to 12" face.....	\$85	
	Over 12" to 18" face.....	\$93	
FIELD SPLICING JOINTS:			
· Open section.....		\$62	
· Closed section		\$62	
· Sill section		\$62	
FILLER PLATES INSTALLED IN OPEN SECTION:			
· Square end, cut and notched and tackwelded.....	thru 36".....	\$33	
at 12" on center and seams are visible	over 36".....	\$49	
GLAZING BEADS (Pre-cut and installed):		Per inch	
· 1", 5/8", or 7/16" wide		\$0.58/in	
NOTES: 1. 1" x 5/8" is standard unless specified. 2. Stick lengths may be purchased from Parts Section			
HARDWARE PREP:		Per strike	
· 4 7/8" ASA or 2 3/4" CYL strike prep.....		\$14	
		Per hinge	
· 4 1/2" x 4 1/2" or 5" hinge prep.....		\$14	
NOTES: 1. Prices are for standard hinge and strike prep in an open or closed section 2. For special hardware preps, refer to hardware Options page			
SPECIAL ANGLE MITER OR NOTCH:		Per setup	
· Set-up charge.....		\$660	
NOTES: 1. For any frame requiring a special angle end cut other than 45° or 90° 2. This set-up charge is for each frame or multiple like frames of the same jamb depth requiring a different miter or notch angle			
PARTIAL SIDE LIGHT NOTCH:		Per piece	
Add to closed section price F-Series only.....		\$24	

Prices subject to change without notice.

STANDARD CONSTRUCTION OPTIONS Add per inch

SPECIAL PROFILE (open or closed section):

- Special backbends
 $\frac{3}{8}$ " minimum thru $1\frac{7}{8}$ " maximum \$0.51
- MU and DW-Series \$0.12
- $\frac{3}{4}$ " thru $1\frac{1}{4}$ " high stops ($\frac{5}{8}$ " standard) \$0.51
- Center glazed, open or closed section \$0.85
- Special angle corner post \$0.51

MARK NUMBERS:

- | | |
|---------------------------------|-----------------|
| | Per unit |
| • Per piece..... | \$1.27 |
| • Per factory welded unit | \$3.80 |

REMOVABLE MULLION PREP \$60

TRANSOM PANEL PREP \$23

- Transom panels (refer Laminated Transom Panel page)

Per frame

UL LABELED FRAME \$32

- Applies to factory welded frames only
- Factory labeled elevations must be shipped welded
- Does not include closer reinf.

12 GAUGE HEAD REINFORCING CHANNEL:

- 2" face only - full jamb depth \$150

LOOSE ANCHORS:

- Anchors must be ordered from the Parts Section

WELD-IN ANCHORS:

- | | | |
|--|--------------------|--------------------|
| • Welded-in standard anchors: | Thru 9 1/8" | Over 9 1/8" |
| • Base | N/C | N/C |
| • Per jamb anchor | \$5 | \$8 |
| • EMA (pierce and dimple only) | | |
| • Per prep..... | \$2.50 | \$5 |
| • EMA (pierce, dimple, weld-in anchors with bolts) | | |
| • Per EMA anchor..... | \$18.50 | \$37 |

HOSPITAL SANITARY STOPS (4", 5 1/2" and 6" high standard):

- | | |
|---------------------------|-----------------|
| • Open sections: | Per prep |
| • Double rabbet 45° | \$73.50 |
| • Double rabbet 90° | \$69.50 |
| • Closed sections: | |
| • Double rabbet 45° | \$80 |
| • Double rabbet 90° | \$80 |

STANDARD HARDWARE OPTIONS Add per stick

SPECIAL VERTICAL HARDWARE LOCATIONS:

- Hinge and strike N/C

HINGES:

- 5" universal in lieu of 4 1/2" N/C
- High frequency prep (per hinge prep)..... \$16
- Heavyweight hinge prep (per hinge prep) \$15

STRIKES:

- CYL strike in lieu of ASA N/C
- Deadlock strike (non-tip)..... \$15
- Flushbolts:
 - Steelcraft reversible..... \$42
 - Standard (ANSI A115.4)..... \$42
- Rim exit device reinf. \$16
- Vertical Rod reinf. \$20
- Vertical Rod Mortise strike (each) \$51

CLOSERS:

- Surface strap (14", 14 gauge) \$16
 (Specify regular parallel arm or top jamb)

NOTES:

1. Construction and hardware options shown on this page are applicable to linear inch pricing pages
2. 12 gauge perimeter, 2" to 4" face, multiply 14 gauge lineal price by 1.6
 - Closed section components are supplied as 14ga with matching profile
 - All frames have 3/4" high stops
 - Jamb depths 5" and under are unequal rabbet profile. All other jamb depths are equal rabbet profile.







Prices subject to change without notice.

TSF PARTS LIST

Sticks are frame components used by the distributor to produce transom, transom / sidelight, sidelight and borrowed light frames. The components are cut to length, notched or mitered, assembled and welded into an assembly by the distributor to meet the requirements of the opening.































Sticks are commonly identified as TSF (Transom Sidelight Frame) sections. Each component has a unique TSF number that identifies it from another section. The frame jamb depth and gauge of steel are also used in the identification and ordering since the TSF number is only a basic identification number.













Stick components are available in 12'1" (open sections), 10'6" (closed sections) lengths and pre-sized lengths for 6'8", 7'0", 7'2" and 8'0" door heights. Sections can be blank (no cutouts), have strike or hinge preps to match doors and other three sided frames. See the exact TSF number for the hardware prep that is included.

Single Rabbet	Double Rabbet	TSF #	Description	Single Rabbet	Double Rabbet	TSF #	Description
		TSF-6	6'8" Double Hinge Mullion			TSF-33	7'2" Double Strike Mullion
		TSF-7	6'8" Double Strike Mullion			TSF-34 R/L	7'2" Hinge and Strike Mullion
		TSF-8 R/L	6'8" Hinge and Strike Mullion			TSF-35 R/L	7'2" Single Hinge Mullion
		TSF-9 R/L	6'8" Single Hinge Mullion			TSF-36 R/L	7'2" Single Strike Mullion
		TSF-10 R/L	6'8" Single Strike Mullion			TSF-39 R/L	7'2" End Hinge Jamb 12'1"
		TSF-11	7'0" Double Hinge Mullion			TSF-40	Cased Open Section 12'1"
		TSF-12	7'0" Double Strike Mullion			TSF-41 R/L	Single Strike Mullion 10'6" (All heights)
		TSF-13 R/L	7'0" Hinge and Strike Mullion			TSF-42 R/L	6'8" Single Hinge Mullion 10'6"
		TSF-14 R/L	7'0" Single Hinge Mullion			TSF-43 R/L	7'0" Single Hinge Mullion 10'6"
		TSF-15 R/L	7'0" Single Strike Mullion			TSF-44 R/L	7'2" Single Hinge Mullion 10'6"
		TSF-16	Blank Mullion 2" Face 10'6"			TSF-45 R/L	6'8" Hinge and Strike Mullion 10'6"
		TSF-20	7'0" Blank Mullion			TSF-46 R/L	7'0" Hinge and Strike Mullion 10'6"
		TSF-21	Blank Rail 2" Face 12'1"			TSF-47 R/L	7'2" Hinge and Strike Mullion 10'6"
		TSF-22	Filler with 5/8" Stop 12'1"	Not Available		TSF-51	2 Way Corner Post 1-9/16" Rabbet Outside 10'6"
		TSF-23	Blank Rail 4" Face 12'1"	Not Available		TSF-52	2 Way Corner Post 1-15/16" Rabbet Outside 10'6"
		TSF-24 R/L	6'8" End Hinge Jamb 12'1"	Not Available		TSF-53	3 Way Corner Post 1-9/16" Rabbet Outside 10'6"
		TSF-25 R/L	7'0" End Hinge Jamb 12'1"	Not Available		TSF-54	3 Way Corner Post 1-15/16" Rabbet Outside 10'6"
		TSF-26 R/L	End Strike Jamb 12'1" (All Heights)				
		TSF-27	Filler without Stop 12'1"				
		TSF-32	7'2" Double Hinge Mullion				

Prices subject to change without notice.

TSF PARTS LIST

Single Rabbet	Double Rabbet	TSF #	Description
See TSF 93		TSF-56	6'8" Removable Mullion Double Strike
See TSF 94		TSF-57	7'0" Removable Mullion Double Strike
See TSF 96		TSF-58	7'2" Removable Mullion Double Strike
See TSF 98		TSF-59	8'0" Removable Mullion Double Strike
		TSF-80	8'0" Double Hinge Mullion
		TSF-81	8'0" Double Strike Mullion
		TSF-82 R/L	8'0" Hinge and Strike Mullion
		TSF-83 R/L	8'0" Single Strike Mullion
		TSF-84 R/L	8'0" Single Strike Mullion
		TSF-85 R/L	8'0" End Hinge Jamb 10'6"
		TSF-86	8'0" Blank Mullion
		TSF-87 R/L	8'0" Single Hinge Mullion 10'6"
		TSF-88 R/L	8'0" Hinge and Strike Mullion 10'6"
Not Available		TSF-89	Snap-in Filler with 5/8" Stop 12'1"
	See TSF-56	TSF-93	6'8" Removable Mullion Double Strike
	See TSF-57	TSF-94	7'0" Removable Mullion Double Strike
Not Available		TSF-95	5/8" Stop 12'1"
	See TSF-58	TSF-96	7'2" Removable Mullion Double Strike
	See TSF-59	TSF-98	8'0" Removable Mullion Double Strike
		TSF-99	Blank Mullion 4" Face 10'6"

Single Rabbet	Double Rabbet	TSF #	Description
Not Available		TSF-102	Un-assembled Transom Bar Side A 1-9/16" 10'6"
Not Available		TSF-103	Un-assembled Transom Bar Side B 1-15/16" 10'6"
		TSF-104	Flush Sill Section Galvannealed 8-1/8" High 12'1"
		TSF-105	Flush Sill Section Galvannealed 6-1/8" High 12'1"
		TSF-106	Flush Sill Section Galvannealed 16-1/8" High 12'1"
Not Available		TSF-132 R/L	Blank Partial Sidelite Mullion 40" Notch 10'6"
Not Available		TSF-133 R/L	Single Strike Partial Sidelite Mullion with 40" Notch 10'6"
Not Available		TSF-134 R/L	Blank Partial Sidelite Mullion 40" Notch 7'0"
Not Available		TSF-135 RL	Single Strike Partial Sidelite Mullion 40" Notch 7'0"

Prices subject to change without notice.

STICK LENGTHS (TSF PARTS)

F16 and FN16-SERIES

STICKS

OPEN SECTIONS (12'1" LENGTHS)

TSF #	Description	3"-5 ⁷ / ₈ "		6"-7 ⁷ / ₈ "		8"-9 ⁷ / ₈ "		10"-11 ⁷ / ₈ "		12"-14 ³ / ₄ "	
		CRS	GALV	CRS	GALV	CRS	GALV	CRS	GALV	CRS	GALV
21	Blank rail	137	160	152	169	194	211	231	259	281	308
23	Blank rail - 4" face	188	209	203	220	258	278	303	324	368	386
40	Cased open blank rail	137	160	152	169	194	211	231	259	281	308
24	Hinge jamb 6'8" locations	179	202	194	211	236	253	273	301	323	350
25	7'0" locations	179	202	194	211	236	253	273	301	323	350
39	7'2" locations	179	202	194	211	236	253	273	301	323	350
85	8'0" locations	193	216	208	225	250	267	287	315	337	364
26	Strike jamb - all	151	174	166	183	208	225	245	273	295	322

SILL SECTIONS AND FILLER PLATES (12'1" LENGTHS)

TSF #	Description	3 ³ / ₄ "-5 ⁷ / ₈ "		6"-7 ⁷ / ₈ "		8"-9 ⁷ / ₈ "		10"-11 ⁷ / ₈ "		12"-14 ³ / ₄ "	
		CRS	GALV	CRS	GALV	CRS	GALV	CRS	GALV	CRS	GALV
105	Sill 6 ¹ / ₈ " full jamb depth	-	349	-	421	-	453	-	484	-	536
104	Sill 8 ¹ / ₈ " full jamb depth	-	349	-	421	-	453	-	484	-	536
106	Sill 16 ¹ / ₈ " full jamb depth	-	396	-	456	-	483	-	546	-	606
107	Sill 8 ¹ / ₈ " rec. 1 ⁹ / ₁₆ " deep	-	349	-	421	-	453	-	484	-	536
108	Sill 8 ¹ / ₈ " rec. 1 ⁵ / ₁₆ " deep	-	349	-	421	-	453	-	484	-	536
22	Filler plate with stop	157	174	173	190	183	201	203	220	247	264
27	Filler plate without stop	157	174	173	190	183	201	203	220	247	264
89	Snap-in filler plate with stop	208	225	215	233	220	238	243	259	254	271

CORNER POSTS (10'6" LENGTHS)

TSF #	Description	4 ³ / ₄ "-5 ⁷ / ₈ "		6"-7 ⁷ / ₈ "		8"-9 ⁷ / ₈ "		10"-11 ⁷ / ₈ "		12"-14 ³ / ₄ "	
		CRS	GALV	CRS	GALV	CRS	GALV	CRS	GALV	CRS	GALV
51	2-Way post 1 ⁹ / ₁₆ " outside	514	538	542	564	566	592	659	686	781	798
52	2-Way post 1 ⁵ / ₁₆ " outside	514	538	542	564	566	592	659	686	781	798
53	3-Way post 1 ⁹ / ₁₆ " outside	514	538	542	564	566	592	659	686	781	798
54	3-Way post 1 ⁵ / ₁₆ " outside	514	538	542	564	566	592	659	686	781	798

CLOSED SECTION MULLIONS (10'6" LENGTHS)

TSF #	Description	3"-5 ⁷ / ₈ "		6"-7 ⁷ / ₈ "		8"-9 ⁷ / ₈ "		10"-11 ⁷ / ₈ "		12"-14 ³ / ₄ "	
		CRS	GALV	CRS	GALV	CRS	GALV	CRS	GALV	CRS	GALV
16	Blank mullion	268	298	306	338	341	365	398	444	477	522
99	Blank mullion - 4" face	349	375	403	419	437	453	520	553	595	646
41	Single strike - all	282	312	320	352	355	379	412	458	491	536
42	Single hinge 6'8" locations	310	340	348	380	383	407	440	486	519	564
43	7'0" locations	310	340	348	380	383	407	440	486	519	564
44	7'2" locations	310	340	348	380	383	407	440	486	519	564
87	8'0" locations	324	354	362	394	397	421	454	500	533	578
45	Hinge and strike 6'8" locations	324	354	362	394	397	421	454	500	533	578
46	7'0" locations	324	354	362	394	397	421	454	500	533	578
47	7'2" locations	324	354	362	394	397	421	454	500	533	578
88	8'0" locations	338	368	376	408	411	435	468	514	547	592

Prices subject to change without notice.

CLOSED SECTION MULLIONS (Pre-cut to a specific opening height)

TSF #	Description	3" - 5 ⁷ / ₈ "		6" - 7 ⁷ / ₈ "		8" - 9 ⁷ / ₈ "		10" - 11 ⁷ / ₈ "		12" - 14 ³ / ₄ "		
		CRS	GALV	CRS	GALV	CRS	GALV	CRS	GALV	CRS	GALV	
FIXED MULLIONS												
20	Blank	7'0" door height	192	212	217	239	240	257	278	309	331	361
86		8'0" door height	217	240	246	271	273	291	316	351	377	411
10	Single strike	6'8" door height	197	216	221	242	244	259	280	309	330	358
15		7'0" door height	206	226	231	253	254	271	292	323	345	375
36		7'2" door height	210	230	236	258	260	276	298	330	353	383
84		8'0" door height	231	254	260	285	287	305	330	365	391	425
7	Double strike	6'8" door height	211	230	235	256	258	273	294	323	344	372
12		7'0" door height	220	240	245	267	268	285	306	337	359	389
33		7'2" door height	224	244	250	272	274	290	312	344	367	397
81		8'0" door height	245	268	274	299	301	319	344	379	405	439
8	Strike and hinge	6'8" door height	239	258	263	284	286	301	322	351	372	400
13		7'0" door height	248	268	273	295	296	313	334	365	387	417
34		7'2" door height	252	272	278	300	302	318	340	372	395	425
82		8'0" door height	287	310	316	341	343	361	386	421	447	481
9	Single hinge	6'8" door height	225	244	249	270	272	287	308	337	358	386
14		7'0" door height	234	254	259	281	282	299	320	351	373	403
35		7'2" door height	238	258	264	286	288	304	326	358	381	411
83		8'0" door height	273	296	302	327	329	347	372	407	433	467
6	Double hinge	6'8" door height	267	286	291	312	314	329	350	379	400	428
11		7'0" door height	276	296	301	323	324	341	362	393	415	445
32		7'2" door height	280	300	306	328	330	346	368	400	423	453
80		8'0" door height	329	352	358	383	385	403	428	463	489	523

TSF #	Description	3" - 5 ⁷ / ₈ "		6" - 7 ⁷ / ₈ "		8" - 9 ⁷ / ₈ "		10" - 11 ⁷ / ₈ "		12" - 14 ³ / ₄ "		
		CRS	GALV	CRS	GALV	CRS	GALV	CRS	GALV	CRS	GALV	
REMOVABLE MULLIONS (Minimum jamb depth 4-3/4" / double rabbet only)												
56	Double strike	6'8" door height	271	290	295	316	318	333	354	383	404	432
57		7'0" door height	280	300	305	327	328	345	366	397	419	449
58		7'2" door height	284	304	310	332	334	350	372	404	427	457
59		8'0" door height	305	328	334	359	361	379	404	439	465	499

MISCELLANEOUS CLOSED SECTION MULLIONS

TSF #	Description	4 ¹ / ₂ " - 5 ⁷ / ₈ "		6" - 7 ⁷ / ₈ "		8" - 9 ⁷ / ₈ "		10" - 11 ⁷ / ₈ "		12" - 14 ³ / ₄ "	
		CRS	GALV	CRS	GALV	CRS	GALV	CRS	GALV	CRS	GALV
102	Slide together mullion - part A	128	141	166	181	190	197	225	255	273	301
103	Slide together mullion - part B	119	136	119	136	119	136	119	136	119	136
132	Partial notch side light mullion 10'6" blank	292	322	330	362	365	389	422	468	501	546
133	Partial notch side light mullion 10'6" single ASA strike	306	336	344	376	379	403	436	482	515	560
134	Partial notch side light mullion 7'0" blank	216	236	241	263	264	281	302	333	355	385
135	Partial notch side light mullion 7'0" single ASA strike	230	250	255	277	278	295	316	347	369	399

NOTES:

- Slide together mullion parts are field assembled. When assembled, part "B" forms the door rabbet. Refer to the TSF Parts List in this section.
- Partial notch side light mullions have a 40" long notch from bottom of frame and a minimum jamb depth of 4 1/2"

Prices subject to change without notice.

STICK LENGTHS (TSF PARTS)

F14 and FN14-SERIES

STICKS

OPEN SECTIONS (12'1" LENGTHS)

TSF #	Description	3"-5 ⁷ / ₈ "		6"-7 ⁷ / ₈ "		8"-9 ⁷ / ₈ "		10"-11 ⁷ / ₈ "		12"-14 ³ / ₄ "		
		CRS	GALV	CRS	GALV	CRS	GALV	CRS	GALV	CRS	GALV	
21	Blank rail	164	183	189	208	239	259	270	289	333	358	
23	Blank rail - 4" face	217	244	236	258	304	321	340	358	428	447	
40	Cased open blank rail	164	183	189	208	239	259	270	289	333	358	
24	Hinge jamb	6'8" locations	206	225	231	250	281	301	312	331	375	400
25		7'0" locations	206	225	231	250	281	301	312	331	375	400
39		7'2" locations	206	225	231	250	281	301	312	331	375	400
85		8'0" locations	220	239	245	264	295	315	326	345	389	414
26	Strike jamb - all	178	197	203	222	253	273	284	303	347	372	

SILL SECTIONS AND FILLER PLATES (12'1" LENGTHS)

TSF #	Description	3 ³ / ₄ "-5 ⁷ / ₈ "		6"-7 ⁷ / ₈ "		8"-9 ⁷ / ₈ "		10"-11 ⁷ / ₈ "		12"-14 ³ / ₄ "	
		CRS	GALV	CRS	GALV	CRS	GALV	CRS	GALV	CRS	GALV
105	Sill 6 ¹ / ₈ " full jamb depth	-	410	-	495	-	555	-	594	-	657
104	Sill 8 ¹ / ₈ " full jamb depth	-	410	-	495	-	555	-	594	-	657
106	Sill 16 ¹ / ₈ " full jamb depth	-	467	-	527	-	583	-	636	-	796
107	Sill 8 ¹ / ₈ " rec. 1 ⁹ / ₁₆ " deep	-	410	-	495	-	555	-	594	-	657
108	Sill 8 ¹ / ₈ " rec. 1 ⁵ / ₁₆ " deep	-	410	-	495	-	555	-	594	-	657
22	Filler plate with stop	180	204	192	215	204	227	240	262	301	324
27	Filler plate without stop	180	204	192	215	204	227	240	262	301	324
89	Snap-in filler plate with stop	213	236	227	250	241	266	254	277	319	342

CORNER POSTS (10'6" LENGTHS)

TSF #	Description	4 ³ / ₄ "-5 ⁷ / ₈ "		6"-7 ⁷ / ₈ "		8"-9 ⁷ / ₈ "		10"-11 ⁷ / ₈ "		12"-14 ³ / ₄ "	
		CRS	GALV	CRS	GALV	CRS	GALV	CRS	GALV	CRS	GALV
51	2-Way post 1 ⁹ / ₁₆ " outside	556	577	597	616	666	697	743	771	874	895
52	2-Way post 1 ⁵ / ₁₆ " outside	556	577	597	616	666	697	743	771	874	895
53	3-Way post 1 ⁹ / ₁₆ " outside	556	577	597	616	666	697	743	771	874	895
54	3-Way post 1 ⁵ / ₁₆ " outside	556	577	597	616	666	697	743	771	874	895

CLOSED SECTION MULLIONS (10'6" LENGTHS)

TSF #	Description	3"-5 ⁷ / ₈ "		6"-7 ⁷ / ₈ "		8"-9 ⁷ / ₈ "		10"-11 ⁷ / ₈ "		12"-14 ³ / ₄ "		
		CRS	GALV	CRS	GALV	CRS	GALV	CRS	GALV	CRS	GALV	
16	Blank mullion	311	336	379	399	413	433	468	495	557	582	
99	Blank mullion - 4" face	400	423	480	500	522	541	602	623	692	752	
41	Single strike - all	325	350	393	413	427	447	482	509	571	596	
42	Single hinge	6'8" locations	353	378	421	441	455	475	510	537	599	624
43		7'0" locations	353	378	421	441	455	475	510	537	599	624
44		7'2" locations	353	378	421	441	455	475	510	537	599	624
87		8'0" locations	367	392	435	455	469	489	524	551	613	638
45	Hinge and strike	6'8" locations	367	392	435	455	469	489	524	551	613	638
46		7'0" locations	367	392	435	455	469	489	524	551	613	638
47		7'2" locations	367	392	435	455	469	489	524	551	613	638
88		8'0" locations	381	406	449	469	483	503	538	565	627	652

Prices subject to change without notice.

CLOSED SECTION MULLIONS (Pre-cut to a specific opening height)

TSF #	Description	3" - 5 ⁷ / ₈ "		6" - 7 ⁷ / ₈ "		8" - 9 ⁷ / ₈ "		10" - 11 ⁷ / ₈ "		12" - 14 ³ / ₄ "		
		CRS	GALV	CRS	GALV	CRS	GALV	CRS	GALV	CRS	GALV	
FIXED MULLIONS												
20	Blank	7'0" door height	221	237	266	279	288	302	325	343	384	401
86		8'0" door height	250	269	302	317	327	343	370	390	437	457
10	Single strike	6'8" door height	225	240	268	280	289	302	324	342	381	397
15		7'0" door height	235	251	280	293	302	316	339	357	398	415
36		7'2" door height	240	256	286	299	309	322	347	365	407	425
84		8'0" door height	264	283	316	331	341	357	384	404	451	471
7	Double strike	6'8" door height	239	254	282	294	303	316	338	356	395	411
12		7'0" door height	249	265	294	307	316	330	353	371	412	429
33		7'2" door height	254	270	300	313	323	336	361	379	421	439
81		8'0" door height	278	297	330	345	355	371	398	418	465	485
8	Strike and hinge	6'8" door height	267	282	310	322	331	344	366	384	423	439
13		7'0" door height	277	293	322	335	344	358	381	399	440	457
34		7'2" door height	282	298	328	341	351	364	389	407	449	467
82		8'0" door height	320	339	372	387	397	413	440	460	507	527
9	Single hinge	6'8" door height	253	268	296	308	317	330	352	370	409	425
14		7'0" door height	263	279	308	321	330	344	367	385	426	443
35		7'2" door height	268	284	314	327	337	350	375	393	435	453
83		8'0" door height	306	325	358	373	383	399	426	446	493	513
6	Double hinge	6'8" door height	295	310	338	350	359	372	394	412	451	467
11		7'0" door height	305	321	350	363	372	386	409	427	468	485
32		7'2" door height	310	326	356	369	379	392	417	435	477	495
80		8'0" door height	362	381	414	429	439	455	482	502	549	569
REMOVABLE MULLIONS (Minimum jamb depth 4 ³ / ₄ " / double rabbet only)												
56	Double strike	6'8" door height	299	314	342	354	363	376	398	416	455	471
57		7'0" door height	309	325	354	367	376	390	413	431	472	489
58		7'2" door height	314	330	360	373	383	396	421	439	481	499
59		8'0" door height	338	357	390	405	415	431	458	478	525	545

NOTE:

1. Single rabbet removable mullion is 3" jamb depth only. See TSF Parts List in the section.

MISCELLANEOUS CLOSED SECTION MULLIONS

TSF #	Description	4 ¹ / ₂ " - 5 ⁷ / ₈ "		6" - 7 ⁷ / ₈ "		8" - 9 ⁷ / ₈ "		10" - 11 ⁷ / ₈ "		12" - 14 ³ / ₄ "	
		CRS	GALV	CRS	GALV	CRS	GALV	CRS	GALV	CRS	GALV
102	Slide together mullion - part A	147	162	214	226	237	249	272	290	328	345
103	Slide together mullion - part B	143	152	143	152	143	152	143	152	143	152
132	Partial notch side light mullion 10'6" blank	335	360	403	423	437	457	492	519	581	606
133	Partial notch side light mullion 10'6" single ASA strike	349	374	417	437	451	471	506	533	595	620
134	Partial notch side light mullion 7'0" blank	245	261	290	303	312	326	349	367	408	425
135	Partial notch side light mullion 7'0" single ASA strike	259	275	304	317	326	340	363	381	422	439

NOTES:

- Slide together mullion parts are field assembled. When assembled, part "B" forms the door rabbet. Refer to the TSF Parts List in this section.
- Partial notch side light mullions have a 40" long notch from bottom of frame and a minimum jamb depth of 4¹/₂"

Prices subject to change without notice.

CONSTRUCTION OPTIONS: Add per stick

SPECIAL PROFILE OPEN, SILL AND FILLER PLATE SECTIONS:

- Special face dimension:
 - 1" thru 4" face \$34
 - Over 4" thru 8" \$47
 - Over 8" thru 18" \$58
- Special backbends:
 - 3/8" min thru 17/8" max \$27
 - MU-Series \$16
- 3/4" thru 1 1/4" high stops \$27

SPECIAL PROFILE MULLIONS:

NOTE: Special profile mullions will not be internally reinf.

- Special face dimensions
 - 1" thru 4" face (2" & TSF 99 - 4" are standard) \$34
 - Over 4" thru 8" \$47
 - Over 8" thru 18" \$58
- Single rabbet \$27
 - 3/4" thru 1 1/4" high stops \$27

REMOVABLE MULLION PREP \$60

MARK NUMBERS \$1.27

HARDWARE OPTIONS: Add per stick

SPECIAL VERTICAL HARDWARE LOCATIONS:

- Hinge and strike N/C

HINGES:

- Additional hinge prep (4 1/2" or 5") \$14
- 5" universal in lieu of 4 1/2" N/C
- High frequency prep (per hinge prep) \$16

STRIKES:

- Additional 4 7/8" ASA strike \$14
- 2 3/4" CYL strike in lieu of 4 7/8" ASA N/C
- Additional CYL strike \$14
- Deadlock strike (non-lip) \$15
- Rim exit device reinf. \$16

NOTES:

1. Construction and hardware options shown on this page are applicable to Stick Lengths (TSF Parts) pricing shown in this section
2. Special profile open, sill and filler plate pricing does not apply to standard sizes

Prices subject to change without notice.

TRANSOM FRAMES WITHOUT TRANSOM BAR FOR USE WITH TRANSOM PANELS

K/D COMPLETE FRAME

Description		3"-5 ⁷ / ₈ "		6"-7 ⁷ / ₈ "		8"-9 ⁷ / ₈ "		10"-11 ⁷ / ₈ "		12"-14 ³ / ₄ "		
Opening Width	Overall Frame Height	CRS	GALV	CRS	GALV	CRS	GALV	CRS	GALV	CRS	GALV	
SINGLE FRAMES												
2'0" thru 3'0"	8'0" thru 8'6"	336	372	359	387	428	455	488	533	569	614	
	8'6" thru 9'0"	351	390	376	406	449	479	514	562	600	648	
	9'0" thru 9'6"	362	403	389	420	465	496	533	583	623	673	
	9'6" thru 10'0"	373	416	401	434	481	514	552	605	646	699	
	10'0" thru 10'6"	385	429	414	448	497	531	571	626	670	724	
	10'6" thru 11'0"	396	443	426	462	513	548	590	648	693	750	
3'2" thru 4'0"	11'0" thru 11'6"	408	456	439	476	529	566	609	669	716	775	
	8'0" thru 8'6"	348	386	373	402	445	474	509	557	594	641	
	8'6" thru 9'0"	363	404	390	421	466	498	534	585	625	675	
	9'0" thru 9'6"	374	417	402	435	482	515	554	607	648	701	
	9'6" thru 10'0"	386	430	415	449	498	532	573	628	672	726	
	10'0" thru 10'6"	397	444	428	463	514	550	592	649	695	752	
DOUBLE FRAMES	10'6" thru 11'0"	409	457	440	477	531	567	611	671	718	777	
	11'0" thru 11'6"	420	470	453	491	547	585	630	692	741	803	
	4'0" thru 6'0"	8'0" thru 8'6"	398	440	425	457	504	536	574	626	667	718
		8'6" thru 9'0"	413	457	442	476	525	559	599	654	698	752
		9'0" thru 9'6"	424	471	454	490	541	576	618	676	721	778
		9'6" thru 10'0"	436	484	467	504	557	594	637	697	744	803
10'0" thru 10'6"		447	497	480	518	573	611	656	719	767	829	
10'6" thru 11'0"		458	510	492	532	589	629	676	740	791	854	
6'2" thru 8'0"	11'0" thru 11'6"	470	523	505	546	605	646	695	761	814	880	
	8'0" thru 8'6"	429	476	460	496	548	584	626	685	731	788	
	8'6" thru 9'0"	444	494	477	514	569	607	652	713	762	822	
	9'0" thru 9'6"	455	507	489	528	585	624	671	735	785	848	
	9'6" thru 10'0"	467	520	502	542	601	642	690	756	808	873	
	10'0" thru 10'6"	478	533	514	556	617	659	709	777	831	899	
6'2" thru 8'0"	10'6" thru 11'0"	490	547	527	570	633	677	728	799	855	924	
	11'0" thru 11'6"	501	560	539	584	649	694	747	820	878	950	

NOTES:

- Refer to page 76 of this section for options available for transom frames.
- Frames are prepared for 4 1/2" hinges and 4 7/8" ASA strike set at 6'8", 7'0" and 7'2" door heights.
- Prices do not include transom panels or attachment assemblies for panels.
- Prices include standard loose jamb and base anchors.
- See Parts Section for removable transom bar installation kits.
- G-90 galvanize - multiply "GALV" price by 1.25 (maximum height 120")

CONSTRUCTION OPTIONS:

Add per frame

TRANSOM PANEL PREP NON-LABEL \$23
(for frames to be used with Steelcraft transom panels)

REMOVABLE TRANSOM BAR, 16 gauge only (NON-LABEL):

- 2'4" thru 4'0".....CRS \$297
- GALV \$316
- Over 4'0" thru 8'0"CRS \$383
- GALV \$421

TRANSOM PANEL PREP UL LABEL (F and FN only):

- (for frames to be used with Steelcraft transom panels)
- Single..... \$210
- Double..... \$257

TRANSOM PANEL PREP:

- Wood panels (single frame only) \$152
- Steel panels See Laminated Transom Panel page
- Includes mounting assembly for Steelcraft transom panels
- Panels are priced separately and shipped with frame

Refer to the Steelcraft Tech Data Manual for labeled approval.

Prices subject to change without notice.

K/D COMPLETE FRAME PRICES

Description		3"- 5 ⁷ / ₈ "		6"- 7 ⁷ / ₈ "		8"- 9 ⁷ / ₈ "		10"- 11 ⁷ / ₈ "		12"-14 ³ / ₄ "	
Opening Width	Overall Frame Height	CRS	GALV	CRS	GALV	CRS	GALV	CRS	GALV	CRS	GALV
SINGLE FRAMES											
2'0" thru 3'0"	8'0" thru 8'6"	380	410	420	450	501	534	551	582	654	695
	8'6" thru 9'0"	398	430	441	473	527	562	581	613	691	735
	9'0" thru 9'6"	411	445	457	490	547	584	603	637	718	764
	9'6" thru 10'0"	425	460	472	508	567	605	626	661	746	794
	10'0" thru 10'6"	439	476	488	525	586	627	648	685	773	824
	10'6" thru 11'0"	452	491	504	542	606	648	670	709	801	853
3'2" thru 4'0"	8'0" thru 8'6"	394	426	437	469	522	557	575	607	684	727
	8'6" thru 9'0"	412	446	458	492	549	585	605	639	720	767
	9'0" thru 9'6"	426	462	473	509	568	607	628	663	748	797
	9'6" thru 10'0"	440	477	489	526	588	628	650	687	776	826
	10'0" thru 10'6"	453	492	505	543	608	650	672	711	803	856
	10'6" thru 11'0"	467	507	520	561	628	671	695	735	831	886
DOUBLE FRAMES	8'0" thru 8'6"	448	483	495	530	588	626	646	681	764	812
	8'6" thru 9'0"	467	504	516	553	614	655	676	713	801	852
	9'0" thru 9'6"	480	519	532	570	634	676	698	737	829	881
	9'6" thru 10'0"	494	534	547	587	654	697	721	761	856	911
	10'0" thru 10'6"	507	549	563	604	674	719	743	785	884	941
	10'6" thru 11'0"	521	564	579	622	694	740	765	809	911	970
6'2" thru 8'0"	8'0" thru 8'6"	486	525	538	577	642	685	708	747	840	894
	8'6" thru 9'0"	504	545	559	600	669	713	738	779	877	933
	9'0" thru 9'6"	518	560	575	617	689	735	760	803	905	963
	9'6" thru 10'0"	531	575	590	635	708	756	782	827	932	993
	10'0" thru 10'6"	545	591	606	652	728	778	805	850	960	1022
	10'6" thru 11'0"	558	606	622	669	748	799	827	874	987	1052
11'0" thru 11'6"	572	621	637	686	768	821	849	898	1015	1082	

NOTES:

1. Refer to page 76 of this section for options available for transom frames.
2. Frames are prepared for 4 1/2" hinges and 4 7/8" ASA strike set at 6'8", 7'0" and 7'2" door heights.
3. Prices do not include transom panels or attachment assemblies for panels.
4. Prices include standard loose jamb and base anchors.
5. See Parts Section for removable transom bar installation kits.
6. G-90 galvanize - multiply "GALV" price by 1.25 (maximum height 120")

CONSTRUCTION OPTIONS:

Add per frame

TRANSOM PANEL PREP NON-LABEL \$23
 (for frames to be used with Steelcraft transom panels)

REMOVABLE TRANSOM BAR, 16 gauge only (NON-LABEL):

- 2'4" thru 4'0" CRS \$297
 GALV \$316
- Over 4'0" thru 8'0" CRS \$383
 GALV \$421

TRANSOM PANEL PREP UL LABEL (NON-LABEL):
 (for frames to be used with Steelcraft transom panels)

- Single \$210
- Double \$257

TRANSOM PANEL PREP:

- Wood panels (single frame only) \$152
- Steel panels See Laminated Transom Panel page
 - Includes mounting assembly for Steelcraft transom panels
 - Panels are priced separately and shipped with frame

Refer to the Steelcraft Tech Data Manual for labeled approval.

Prices subject to change without notice.

4-SIDED, K/D BORROWED LIGHT FRAMES

Description		3" - 5 ⁷ / ₈ "		6" - 7 ⁷ / ₈ "		8" - 9 ⁷ / ₈ "	
Glass Opening Width	Glass Opening Height	CRS	GALV	CRS	GALV	CRS	GALV
SINGLE FRAMES							
2'0" thru 3'0"	2'0" thru 2'6"	228	248	241	257	279	294
	2'8" thru 3'4"	249	272	264	282	307	324
	3'6" thru 4'0"	270	296	287	307	335	355
	4'8" thru 5'4"	305	336	325	348	382	405
	5'8" thru 6'10"	340	375	363	390	428	455
3'2" thru 4'0"	2'0" thru 2'6"	259	283	274	293	319	338
	2'8" thru 3'4"	280	307	297	318	347	368
	3'6" thru 4'0"	301	330	320	343	376	398
	4'8" thru 5'4"	336	370	358	384	422	448
	5'8" thru 6'10"	371	410	396	426	469	499
4'0" thru 6'0"	2'0" thru 2'6"	298	328	318	340	372	395
	2'8" thru 3'4"	319	351	340	365	400	425
	3'6" thru 4'0"	340	375	363	390	428	455
	4'8" thru 5'4"	375	415	401	431	475	505
	5'8" thru 6'10"	410	455	439	473	522	556
6'2" thru 8'0"	2'0" thru 2'6"	354	391	378	406	447	475
	2'8" thru 3'4"	375	415	401	431	475	505
	3'6" thru 4'0"	396	439	424	456	503	535
	4'8" thru 5'4"	431	478	462	498	550	586
	5'8" thru 6'10"	466	518	500	540	597	636

NOTES:

1. For borrowed lights larger than sizes shown, price as lineal inch
2. Refer to page 76 of this section for options available for 4 sided frames
3. Prices include standard loose jamb and base anchors
4. Prices for rabbeted and cased open
5. Cased open borrowed light does not include glazing bead
6. Minimum size 1'0" x 1'0"
7. G-90 galvanize - multiply "GALV" price by 1.25 (maximum height 120")

CONSTRUCTION OPTIONS:

Per frame

Deduct anchors: thru 4'0" deduct \$8
 over 4'0" high.....deduct \$12

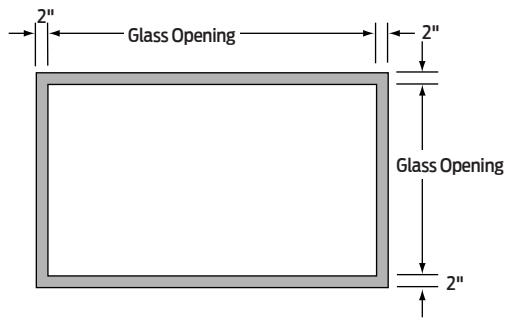

Prices subject to change without notice.

4-SIDED, K/D BORROWED LIGHT FRAME

Description		3"-5 ⁷ / ₈ "		6"-7 ⁷ / ₈ "		8"-9 ⁷ / ₈ "	
Glass Opening Width	Glass Opening Height	CRS	GALV	CRS	GALV	CRS	GALV
SINGLE FRAMES							
2'0" thru 3'0"	2'0" thru 2'6"	253	269	275	291	319	337
	2'8" thru 3'4"	277	296	302	321	353	374
	3'6" thru 4'0"	301	323	330	351	387	410
	4'8" thru 5'4"	342	367	375	401	443	470
	5'8" thru 6'10"	383	412	421	450	499	530
3'2" thru 4'0"	2'0" thru 2'6"	288	308	314	334	368	390
	2'8" thru 3'4"	312	334	342	364	401	426
	3'6" thru 4'0"	336	361	369	394	435	462
	4'8" thru 5'4"	377	406	415	444	491	522
	5'8" thru 6'10"	418	450	461	493	547	582
4'0" thru 6'0"	2'0" thru 2'6"	334	358	366	391	431	458
	2'8" thru 3'4"	358	385	394	420	465	494
	3'6" thru 4'0"	383	412	421	450	499	530
	4'8" thru 5'4"	423	456	467	500	555	590
	5'8" thru 6'10"	464	501	513	549	611	650
6'2" thru 8'0"	2'0" thru 2'6"	399	429	440	470	521	554
	2'8" thru 3'4"	423	456	467	500	555	590
	3'6" thru 4'0"	448	483	494	530	588	626
	4'8" thru 5'4"	488	527	540	579	644	687
	5'8" thru 6'10"	529	572	586	629	700	747

NOTES:

1. For borrowed lights larger than sizes shown, price as lineal inch
2. Refer to page 76 of this section for options available for 4 sided frames
3. Prices include standard loose jamb and base anchors
4. Prices for rabbeted and cased open
5. Cased open borrowed light does not include glazing bead
6. Minimum size 1'0" x 1'0"
7. G-90 galvanize - multiply "GALV" price by 1.25 (maximum height 120")

CONSTRUCTION OPTIONS:

Per frame

Deduct anchors: thru 4'0"..... deduct \$8
 over 4'0" high..... deduct \$12

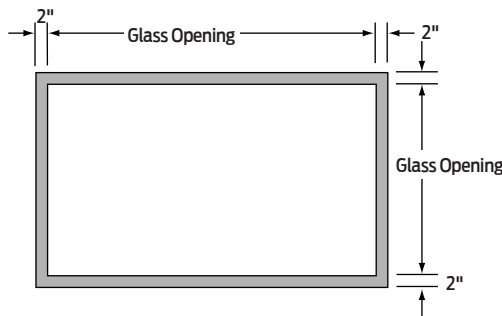

Prices subject to change without notice.

4-SIDED, K/D BORROWED LIGHT FRAME

Description		4 1/2" - 5 7/8"		6" - 7 7/8"		8" - 9"	
Glass Opening Width	Glass Opening Height	CRS	GALV	CRS	GALV	CRS	GALV
SINGLE FRAMES							
2'0" thru 3'0"	2'0" thru 2'6"	244	264	257	272	295	310
	2'8" thru 3'4"	267	290	282	299	325	342
	3'6" thru 4'0"	290	316	307	327	355	374
	4'8" thru 5'4"	329	359	349	372	405	428
	5'8" thru 6'10"	367	402	390	417	456	482
3'2" thru 4'0"	2'0" thru 2'6"	277	301	293	311	338	357
	2'8" thru 3'4"	301	327	318	339	368	389
	3'6" thru 4'0"	324	353	343	366	399	421
	4'8" thru 5'4"	362	397	385	411	449	475
	5'8" thru 6'10"	401	440	426	456	499	529
4'0" thru 6'0"	2'0" thru 2'6"	321	350	340	363	395	418
	2'8" thru 3'4"	344	376	365	390	425	450
	3'6" thru 4'0"	367	402	390	417	456	482
	4'8" thru 5'4"	406	446	432	462	506	536
	5'8" thru 6'10"	445	489	474	507	556	590
6'2" thru 8'0"	2'0" thru 2'6"	383	420	407	435	476	504
	2'8" thru 3'4"	406	446	432	462	506	536
	3'6" thru 4'0"	429	472	457	489	536	568
	4'8" thru 5'4"	468	515	499	534	586	622
	5'8" thru 6'10"	507	558	540	580	637	676

NOTES:

- Prices above include loose glazing beads, cut to length, with self-drilling attaching screws
- Maximum sizes as listed
- Minimum size 1'6" x 1'6"
- DW frames have compression anchors in head and sill only. MU-Series frames are the same prices as shown.
- Jambs are mitered with corner tabs
- Prices for rabbeted and cased open
- Cased open borrowed light does not include glazing bead
- For borrowed lights other than sizes shown, price as lineal inch
- G-90 galvanize - multiply "GALV" price by 1.25 (maximum height 120")

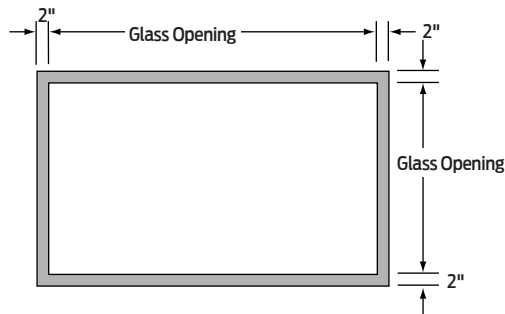

Prices subject to change without notice.

4-SIDED, K/D BORROWED LIGHT FRAME

Description		4'½" - 5'⅞"		6" - 7'⅞"		8" - 9"	
Glass Opening Width	Glass Opening Height	CRS	GALV	CRS	GALV	CRS	GALV
SINGLE FRAMES							
2'0" thru 3'0"	2'0" thru 2'6"	268	285	290	307	335	353
	2'8" thru 3'4"	295	314	320	339	371	391
	3'6" thru 4'0"	321	343	350	371	406	430
	4'8" thru 5'4"	365	391	399	424	466	493
	5'8" thru 6'10"	410	439	448	477	526	557
3'2" thru 4'0"	2'0" thru 2'6"	306	326	333	353	387	408
	2'8" thru 3'4"	333	355	363	385	422	447
	3'6" thru 4'0"	360	384	392	417	458	485
	4'8" thru 5'4"	404	432	442	470	518	549
	5'8" thru 6'10"	448	480	491	523	577	612
4'0" thru 6'0"	2'0" thru 2'6"	357	381	389	414	454	481
	2'8" thru 3'4"	383	410	419	445	490	519
	3'6" thru 4'0"	410	439	448	477	526	557
	4'8" thru 5'4"	454	487	498	531	585	621
	5'8" thru 6'10"	498	535	547	584	645	685
6'2" thru 8'0"	2'0" thru 2'6"	427	458	468	499	550	583
	2'8" thru 3'4"	454	487	498	531	585	621
	3'6" thru 4'0"	480	516	527	563	621	659
	4'8" thru 5'4"	525	564	577	616	681	723
	5'8" thru 6'10"	569	612	626	669	740	787

NOTES:

1. Prices above include loose glazing beads, cut to length, with self-drilling attaching screws
2. Maximum sizes as listed
3. Minimum size 1'6" x 1'6"
4. DW frames have compression anchors in head and sill only. MU-Series frames are the same prices as shown.
5. Jambs are mitered with corner tabs
6. Prices for rabbeted and cased open
7. Cased open borrowed light does not include glazing bead
8. For borrowed lights other than sizes shown, price as lineal inch
9. G-90 galvanize - multiply "GALV" price by 1.25 (maximum height 120")

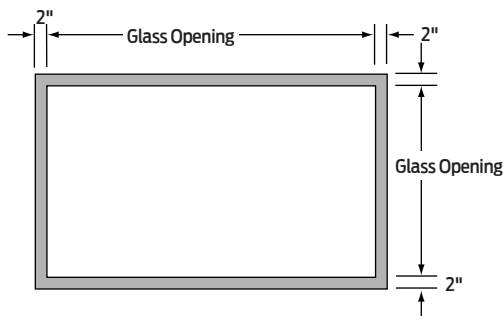

Prices subject to change without notice.

L-SERIES 1 3/4" PANELS

Panel Height	Gauges			
	Non-labeled		Labeled	
	L20	L18	L16	L18
3'0" Wide				
1'0"	358	366	381	489
2'0"	418	437	465	556
3'0"	479	505	549	625
4'0"	544	572	629	698
4'0" Wide				
1'0"	377	389	407	511
2'0"	459	483	520	603
3'0"	542	572	629	698
4'0"	622	666	744	790
6'0" Wide				
1'0"	418	437	465	598
2'0"	544	572	629	738
3'0"	664	713	797	874
4'0"	786	852	965	1012
8'0" Wide				
1'0"	459	483	520	645
2'0"	622	666	744	828
3'0"	786	852	965	1012
4'0"	949	1035	1191	1198

CONSTRUCTION OPTIONS:

Per panel

GALVANNEALED STEEL (A-60)\$79

CORE MATERIAL OPTION

- Polystyrene\$27
- Polyurethane (non-labeled only)\$194

MARK NUMBERS N/C

HARDWARE OPTIONS: (Flush panels only)

Per prep

CLOSER REINF.\$27

FLUSHBOLT STRIKE PREP\$42

SURFACE BOLT\$27

NOTES:

- L-Series panels have beveled top and bottom edges and recessed side channels with honeycomb core
- Sizes other than listed are priced as the next larger size category
- Labeled panels must be ordered and shipped with UL labeled transom frames
- Labeled panels include closer reinf
- UL label transom panels are for use with transom frames without transom bars only
 - 20 gauge panels not available labeled
 - Panels include attached astragal
- Refer to the Parts Section for transom panel installation kits

3/8" AND 1/2" OPEN EDGE PANELS

Description	Base price per panel	Add per square foot					
		20 Gauge		18 Gauge		16 Gauge	
		CRS	GALV	CRS	GALV	CRS	GALV
NON-FIRE RATED PANELS							
Fiberboard core, 3/8" thick	100	not available		31	36	not available	
FIRE RATED LAMINATED PANELS							
Mineral board, 1/2" thick	100	31	36	32	37	33	38

NOTES:

- Open edge panels are typically installed in side light or transom frames with glazing bead
- Glazing beads are not included in panel price
- When pricing, convert the total panel area to square feet:
 - Round both the length and width sizes to the next larger equal foot length
 - Example - for pricing, an 18" x 36" 3/8" thick 18 ga CRS panel would be sized as 2' x 3' = 6 sq. ft.
 - **Step #1** add base price for panel\$100
 - **Step #2** add for panel area (6 x \$29)\$186

Total panel cost = \$286

Prices subject to change without notice.

TABLE OF CONTENTS

FRAME PARTS

Anchors

- Jamb – Wood and Steel Stud 100
- Jamb – Masonry 102
- Base – All 103
- Drywall 104
- Miscellaneous 104

Closer Reinf. 105

Corner Clip Reinf. 105

Glazing Bead 106

Hardware Filler Plates 106

Hardware Reinf. Plates 107

Miscellaneous Frame Parts

- Hospital Stop Kits 108
- Lead Lining Clips 108
- Silencers 108
- Kerfed Frame Seals 108
- Splice Sleeves and Reinf. 109
- Throat Fillers 109
- Transom Bar and Panel Kits 109
- Weatherstripping 109
- Finishes and Coatings 118

DOOR PARTS

- Astragals – “Z” Type 110
- Astragals – 2 piece 111
- Caps and Channels 112
- Door Shelves and Filler Plates 113
- Glass Trim 114

Miscellaneous Door Parts

- Hardware Reinf. 117
- Nosing – Double Acting Doors 117
- Sweeps 117
- Screws 117
- Paint – Primer 118
- Finishes and Coatings 118
- GRAINTECH™ – Stains 118
- Sample Products 118

PARTS ORDERING INFORMATION

1. Order all items as listed by **PACKAGE NUMBER** only. Use the **PART NUMBER** (located in the description column) only when a package number is not indicated or when ordering quantities less than the package quantity (See note 2).
2. The following procedure is required when ordering quantities less than the package quantity:
 - a. **A broken package charge of \$35.00 net will be applied to each line item**
 - b. Order by **PART NUMBER**
 - c. Where the **PART NUMBER** is listed as "not available" parts are only available in package quantities
3. Stock parts will ship either with the Stock or Express Stock program. Non-Stock (Shaded) parts will ship with our Standard 4-week program

Prices subject to change without notice.

JAMB ANCHORS - WOOD AND STEEL STUD (LOCK-IN)

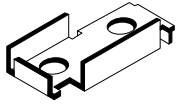
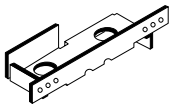
Item Description	Part Number	Package Number	Package Quantity	Package Price	Illustration
STEEL STUD – CLOSED					
For use on F-Series frames, 2" face only					
4 ³ / ₄ " JD (2 ¹ / ₂ " stud size)	not available	1011	100	187	
5 ³ / ₄ " JD (3 ⁵ / ₈ " stud size)	not available	1012			
5 ³ / ₄ " JD (3 ⁵ / ₈ " stud size)	not available	1019 Bulk 55 gallon drum	560	1,000	
6 ³ / ₄ " JD (3 ⁵ / ₈ " stud size)	not available	2611	100	200	
7 ³ / ₄ " JD	not available	2890	50	106	
8 ³ / ₄ " JD	not available	2612			
WOOD STUD					
For use on F-Series frames, 2" face only					
4 ³ / ₄ " JD	not available	1014	100	219	
5 ³ / ₄ " JD	not available	1015			
5 ³ / ₄ " JD	not available	1018 Bulk 55 gallon drum	450	905	
6 ³ / ₄ " JD	not available	1016	100	219	
7 ³ / ₄ " JD	not available	2891	50	114	
8 ³ / ₄ " JD	not available	1017			

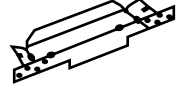

JAMB ANCHORS - WOOD AND STEEL STUD (LOCK-IN)

Item Description	Part Number	Package Number	Package Quantity	Package Price	Illustration
WOOD/STEEL STUD UNIVERSAL, ADJUSTABLE					
For use on F or MU-Series frames, 2" face only					
4 ¹ / ₂ " to 4 ³ / ₄ " JD	not available	2780	100	178	
4 ⁷ / ₈ " to 5" JD	not available	2781			
5 ¹ / ₈ " to 5 ¹ / ₄ " JD	not available	2782			
5 ³ / ₈ " to 5 ¹ / ₂ " JD	not available	2783			
5 ⁵ / ₈ " to 5 ³ / ₄ " JD	not available	2784			
5 ⁵ / ₈ " to 5 ³ / ₄ " JD	not available	1201	300	520	
5 ⁷ / ₈ " to 6"	not available	2785	100	178	
5 ⁷ / ₈ " to 6"	not available	1202	300	450	
6 ¹ / ₈ " to 6 ¹ / ₄ " JD	not available	2786	100	178	
6 ³ / ₈ " to 6 ¹ / ₂ " JD	not available	2787			
6 ⁵ / ₈ " to 6 ³ / ₄ " JD	not available	2788	50	95	
6 ⁷ / ₈ " to 7" JD	not available	2789			
7 ¹ / ₈ " to 7 ¹ / ₄ " JD	not available	2790			
7 ³ / ₈ " to 7 ¹ / ₂ " JD	not available	2791	200	370	
7 ⁵ / ₈ " to 7 ³ / ₄ " JD	not available	2792			
7 ⁵ / ₈ " to 7 ³ / ₄ " JD	not available	1203	200	370	
7 ⁷ / ₈ " to 8" JD	not available	2793	50	95	
8 ¹ / ₈ " to 8 ¹ / ₄ " JD	not available	2794			
8 ¹ / ₈ " to 8 ¹ / ₄ " JD	not available	1204	200	370	
8 ³ / ₈ " to 8 ¹ / ₂ " JD	not available	2795	50	95	
8 ⁵ / ₈ " to 8 ³ / ₄ "	not available	2796			
8 ⁷ / ₈ " to 9"	not available	2797			
9 ¹ / ₈ " to 9 ¹ / ₄ "	not available	2798			
9 ³ / ₈ " to 9 ¹ / ₂ "	not available	2799			

NOTE: Shaded items are non-stock

Prices subject to change without notice.

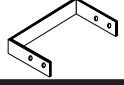
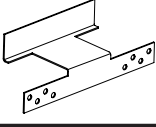
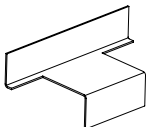
JAMB ANCHORS - WOOD AND STEEL STUD (WELD-IN)

Item Description	Part Number	Package Number	Package Quantity	Package Price	Illustration
"Z" STEEL STUD (WELD-IN) FOR SPECIAL PROFILE FRAMES					
For use on F and MU-Series frames					
Galv 6'0" length 1" x 7/8" x 1"	not available	5500	10	200	
WOOD STUD (WELD-IN)					
For use on F, FN and MU-Series frames					
For 3 1/2" stud width	not available	5508	50	225	
For 5 1/2" stud width	not available	5509			
WOOD STUD (WELD-IN)					
For use on F and MU-Series frames, 2" face only					
5" to 5 7/8" JD	not available	5511	50	140	
6" to 6 7/8" JD	not available	5512			
7" to 7 7/8" JD	not available	5513			
8" to 8 7/8" JD	not available	5514			
STEEL STUD (WELD-IN)					
For use on F and MU-Series frames, 2" face only					
5" to 5 7/8" JD	not available	5515	50	150	
6" to 6 7/8" JD	not available	5516			
7" to 7 7/8" JD	not available	5517			
8" to 8 7/8" JD	not available	5518			
STEEL AND WOOD STUD					
For use on FN-Series frames, 1" face only					
For single layer drywall	not available	5311	50	133	
For double layer drywall	not available	5310		183	

JAMB ANCHORS - WOOD AND STEEL STUD (WELD-IN)

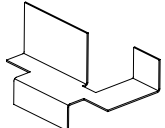
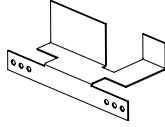
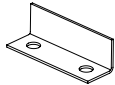
Item Description	Part Number	Package Number	Package Quantity	Package Price	Illustration
STEEL STUD – CLOSED (WELD-IN)					
For use on FE-Series frames					
5 3/4" JD head	not available	2032	24	195	
6 3/4" JD head	not available	2033			
7 3/4" JD head	not available	2034			
5 3/4" JD jamb	not available	2035	40	187	
6 3/4" JD jamb	not available	2036			
7 3/4" JD jamb	not available	2037			
WOOD STUD (WELD-IN)					
For use on FE-Series frames					
5 3/4" JD head	not available	2038	24	195	
6 3/4" JD head	not available	2047			
7 3/4" JD head	not available	2048			
5 3/4" JD jamb	not available	2049	40	187	
6 3/4" JD jamb	not available	2074			
7 3/4" JD jamb	not available	2075			
BASE (WELD-IN)					
For use on FE-Series frames					
1 3/8" face and greater	not available	2077	50	110	



Prices subject to change without notice.

NOTE: Shaded items are non-stock

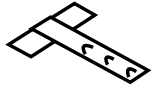
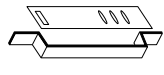
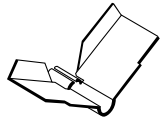
JAMB ANCHORS - MASONRY

Item Description	Part Number	Package Number	Package Quantity	Package Price	Illustration
WIRE MASONRY, 3/16" WIRE, GALVANNEALED					
For use on F, FE, DE, FN and MU-Series frames					
All JD	not available	2840	100	160	
All JD Anchors skidded (54 boxes, 100 anchors each)	not available	9915	5,400	8,100	
"T" MASONRY, 16 GAUGE GALVANNEALED					
For use on F Series, 2" face frames only					
5 ³ / ₄ " JD	not available	5100	50	100	
6 ³ / ₄ " JD	not available	5101			
7 ³ / ₄ " JD	not available	5102			
8 ³ / ₄ " JD	not available	5090			
YOKE AND STRAP MASONRY - WELD-IN					
For use on F, FE, DE, FN and MU-Series frames					
Set contains (1) each	not available not available	1095	50 Sets	330	
EXISTING OPENING - BUTTERFLY ANCHORS					
For use on F-Series double rabbeted frames					
4 ³ / ₄ " JD	not available	4229	24	112	
5 ³ / ₄ " JD	not available	4230			
5 ³ / ₄ " JD	not available	4265	400	1,530	
6 ³ / ₄ " and 7 ³ / ₄ " JD	not available	4231	24	112	
8 ³ / ₄ " JD	not available	4232			

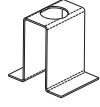
JAMB ANCHORS - EXISTING MASONRY (WELD-IN)

Item Description	Part Number	Package Number	Package Quantity	Package Price	Illustration
EXISTING OPENING - WELD-IN EMA "HAT"					
For use on F, FE, DE and MU-Series frames					
Std 2" face + ⁵ / ₈ " stop	not available	5535	24	96	
Std 2" face + ⁵ / ₈ " stop	not available	5519	400	1,500	
Face + stop = 2" (F CO, FE)	not available	5532	24	96	
Std 1" face + ⁵ / ₈ " stop	not available	5536			
Std 1 1/2" face + ⁵ / ₈ " stop	not available	5533			
Std 1 3/4" face + ⁵ / ₈ " stop	not available	5534			
BOLT AND EXPANSION SHIELD					
For use on F, FE, DE and MU-Series frames					
³ / ₈ " bolt and expansion shield	not available	4162	24	120	

NOTE: Shaded items are non-stock

Prices subject to change without notice.

BASE ANCHORS

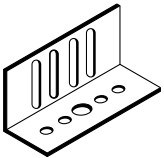
Item Description	Part Number	Package Number	Package Quantity	Package Price	Illustration
ADJUSTABLE BASE ANCHOR					
For use on F and MU-Series frames					
4 ³ / ₄ " JD	not available	1067	100	210	
5 ³ / ₄ ", 6 ³ / ₄ " and 7 ³ / ₄ " JD	not available	1068			
5 ³ / ₄ ", 6 ³ / ₄ " and 7 ³ / ₄ " JD	not available	1020 Bulk 55 gallon drum	800	1,500	
8 ³ / ₄ " JD	not available	1069	50	165	

BASE ANCHORS

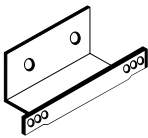
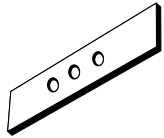
Item Description	Part Number	Package Number	Package Quantity	Package Price	Illustration
WOOD STUD BASE ANCHOR					
For use on F-Series double rabbeted frames					
4 ³ / ₄ " JD	not available	1075	100	203	
5 ³ / ₄ " JD	not available	1076			
6 ³ / ₄ " JD	not available	1077			
7 ³ / ₄ " JD	not available	2892	25	85	
8 ³ / ₄ " JD	not available	1078			
BASE ANCHOR ATTACHING STRAP					
For use on F-Series double rabbeted frames					
4 ³ / ₄ " JD	not available	1115	50	60	
5 ³ / ₄ " JD	not available	1116			
6 ³ / ₄ " JD	not available	1117			
7 ³ / ₄ " JD	not available	2874			
8 ³ / ₄ " JD	not available	1118			

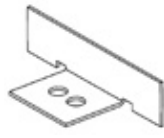
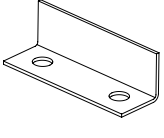

BASE ANCHORS (WELD-IN)

Item Description	Part Number	Package Number	Package Quantity	Package Price	Illustration
BASE ANCHOR					
For use on F and MU-Series double rabbeted frames					
4 ³ / ₄ " JD	not available	5520	100	230	
5 ³ / ₄ " JD	not available	5521			
6 ³ / ₄ " JD	not available	5522			
7 ³ / ₄ " JD	not available	5523			
8 ³ / ₄ " JD	not available	5524			
For use on F and FN-Series cased open frames					
F-Series all jamb depths	not available	2077	50	110	
FN-Series all jamb depths	not available	5526			

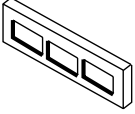

Prices subject to change without notice.

NOTE: Shaded items are non-stock

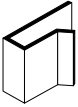
ANCHORS - DRYWALL

Item Description	Part Number	Package Number	Package Quantity	Package Price	Illustration
COMPRESSION ANCHOR					
For use on DW and K-Series frames, 2" face only					
Rabbeted frames	not available	3010	50	600	
Cased open frames	not available	3011			
BASE ANCHOR ATTACHING STRAP, FOR TWIST-IN BASE ANCHOR					
For use on DW-Series frames					
5 1/2" to 5 7/8" JD	not available	3012	50	300	
6 1/2" to 6 7/8" JD	not available	3013			
7 5/8" to 8 1/8" JD	not available	3014			
8 1/4" to 8 3/4" JD	not available	3015			
TWIST-IN BASE ANCHOR					
For use on DW-Series frames					
All jamb depths	not available	2848	100	120	
SECURITY JAMB ANCHOR					
For use on DW, K and MU-Series frames					
5/8" thick gypsum board	not available	2509	100	320	
1/2" thick gypsum board	not available	2510			
Two (2) layers 5/8" thick gypsum board	not available	2511			

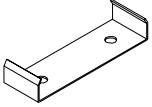
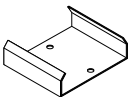
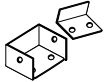
ANCHORS – MISCELLANEOUS



Item Description	Part Number	Package Number	Package Quantity	Package Price	Illustration
BASE ANCHORS FOR MULLION STICK ASSEMBLIES					
For use on F-Series sticks, 2" face only					
4 3/4" JD	not available	1085	25	250	
5 3/4" JD	not available	1086			
6 3/4" JD	not available	1087			
7 3/4" JD	not available	2875			
8 3/4" JD	not available	1088			
BASE ANCHORS - FOR SILL STICK ASSEMBLIES					
For use on F-Series sticks					
4 3/4" JD	not available	1099	10	150	
5 3/4" JD	not available	1100			
6 3/4" JD	not available	1101			
7 3/4" JD	not available	2877			
8 3/4" JD	not available	1102			
REMOVABLE VERTICAL MULLION ANCHOR, TOP AND BASE ASSEMBLY					
For use on F-Series frames, screws included					
Double rabbet	not available	2118	1 Set	38	
Single rabbet	not available	1104	1 Set	30	
CEILING STRUT ANCHOR					
For use on F-Series frames					
Adjustable for 8'0" to 12'0" ceiling heights	not available	1120	10	360	

NOTE: Shaded items are non-stock

Prices subject to change without notice.

CLOSER REINF. AND CORNER CLIPS

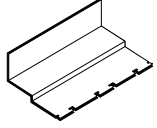
CLOSER REINF. AND CORNER CLIPS

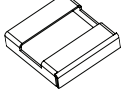
Item Description	Part Number	Package Number	Package Quantity	Package Price	Illustration
SLEEVE - FULL PROFILE					
For use on F, DW, K and MU-Series frames, 2" face only					
5 5/8" JD	not available	2595	6	165	
5 3/4" JD	not available	2199			
5 7/8" JD	not available	2596			
6 3/4" JD	not available	2542			
7 3/4" JD	not available	2879			
8 1/4" JD	not available	2469			
8 3/4" JD	not available	2468			
SLEEVE - HALF PROFILE, REINF. 115/16" RABBET ONLY					
For use on F, DW, K and MU-Series frames, 2" face only					
4 3/4" JD	not available	9612	6	99	
5 3/4" JD	not available	9616			
5 7/8" JD	not available	9617			
6 3/4" JD	not available	9624			
SLEEVE - HALF PROFILE, REINF. 115/16" RABBET ONLY					
F-Series frames, 2" face (25 right and 25 left)	not available	2910	25 Sets	100	
DW and K-Series frames, 2" face only	not available	2912	100	150	
F-Series frames, 4" face only	not available	2911	100	150	

Prices subject to change without notice.

NOTE: Shaded items are non-stock

GLAZING BEADS - FOR ALL STICK ASSEMBLIES, PRIME PAINTED

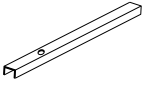
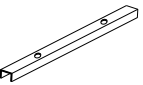
Item Description	Part Number	Package Number	Package Quantity	Package Price	Illustration
18 GAUGE, GALVANIZED, 1 HOLE PUNCHED					
5/8" wide x 5/8" high x 120"	not available	4703	10	210	
1" wide x 5/8" high x 120"	not available	4704			
18 GAUGE, GALVANIZED, PRE-PUNCHED ON 9 1/2" CENTERS					
7/16" wide x 5/8" high x 120"	not available	4700	10	265	
5/8" wide x 5/8" high x 120"	not available	4701			
1" wide x 5/8" high x 120"	not available	4702			
18 GAUGE, GALVANIZED, PRE-PUNCHED ON 10" CENTERS					
1" wide x 3/4" high x 96"	not available	9658	10	265	
3/4" wide x 3/4" wide x 96"	not available	9659			

HARDWARE FILLER PLATES

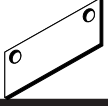
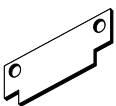
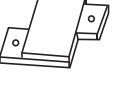



Item Description	Part Number	Package Number	Package Quantity	Package Price	Illustration
HINGE FILLER PLATES, SCREWS INCLUDED					
For use on F, FN, FE, DE, DW, K and MU-Series frames					
3 1/2" regular weight	not available	1191	12	105	
4 1/2" regular weight	not available	1192			
5" regular weight	not available	1193			
STRIKE FILLER PLATES, SCREWS INCLUDED					
For use on F, FN, DW, K and MU-Series frames					
ASA 4 7/8" ANSI-A115.1 and .2	not available	1194	12	84	
CYL 2 3/4" ANSI A115.3 for 1 9/16" rabbet	not available	1195			
CYL 2 3/4" ANSI A115.3 for 1 15/16" rabbet	not available	1196			
Reversible flushbolt strike filler	not available	5525	25	50	
VON DUPRIN 338 LATCH FILLER PLATE					
For use with retrofit application of Von Duprin Concealed Vertical Cable Device					
338 strike filler plate	not available	1205	4	232	

NOTE: Shaded items are non-stock

Prices subject to change without notice.

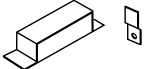
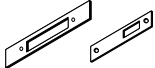
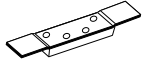
HARDWARE REINF. PLATES

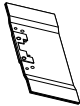
HARDWARE REINF. PLATES

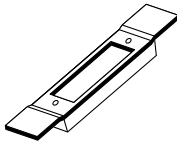
Item Description	Part Number	Package Number	Package Quantity	Package Price	Illustration	
ELECTRONIC POWER TRANSFER						
For use on 14 & 16 gauge frames with butt hinges						
Power transfer reinf. (Ex. EPT10)	not available	2930	6	111		
FLUSHBOLT STRIKE REINF.						
For use on F, FN, DW, K and MU-Series frames						
ANSI-A115.4 flushbolt strike, handed Two (2) reinf. plates and One (1) plaster guard per kit	not available	2040	4 Kits	76		
ANSI-A115.4 flushbolt strike, Reversible one (1) strike plate and One (1) reinf. and screws per kit		2899		72		
HINGE REINF. PLATES						
For use on F, FN, FE, DE, DW, K and MU-Series frames						
3 1/2" Regular weight, 10 gauge	not available	1183	40	466		
4 1/2" Universal, 7 gauge	not available	7001		320		
4 1/2" Universal, 7 gauge, bulk	not available	1141	200	1,072		
5" Universal, 7 gauge	not available	9920	40	466		
HIGH FREQUENCY REINF.						
F and DE-Series	not available	1188	12	94		
FE-Series	not available	1197				
HINGE REINF. PLATES - FULL JAMB DEPTH (4 1/2" X 4 1/2" HINGES ONLY)						
For use on F, DW, K and MU-Series frames						
5 3/4" JD	not available	3375	12	522		
6 3/4" JD	not available	3376		532		
7 3/4" JD	not available	3377		544		
8 3/4" JD	not available	3378		558		
HINGE SHIMS						
For use on F, DW, K and MU-Series frames						
For 4 1/2" hinge	not available	3529	200	283		
STRIKE REINF.						
For use on F, DW, K and MU-Series frames						
ASA 4 7/8" ANSI-A115.1 and .2 for 1 9/16" rabbet	not available	2907	20	99		
ASA 4 7/8" ANSI-A115.1 and .2 for 1 15/16" rabbet	not available	1189		109		
CYL 2 3/4" ANSI-A115.3 for 1 9/16" or 1 15/16" rabbet	not available	1190		114		
For use on FN Series frames						
ASA 4 7/8" ANSI-A115.1 and .2 for 1 9/16" rabbet	not available	2908	20	99		
ASA 4 7/8" ANSI-A115.1 and .2 for 1 15/16" rabbet	not available	1189		109		
CYL 2 3/4" ANSI-A115.3 for 1 9/16" or 1 15/16" rabbet	not available	2506		114		

Prices subject to change without notice.

NOTE: Shaded items are non-stock

HOSPITAL STOP KITS

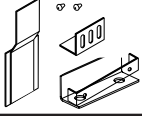
Item Description	Part Number	Package Number	Package Quantity	Package Price	Illustration
HOSPITAL STOP KIT FOR 45° CUT-OFF					
For use on F and FN Series frames					
5 1/2" high for 5 3/4" JD	not available	2369	5 Kits	135	
5 1/2" high for 6 3/4" JD	not available	2370			
5 1/2" high for 8 3/4" JD	not available	2217			

LEAD LINING CLIPS

Item Description	Part Number	Package Number	Package Quantity	Package Price	Illustration
For use on F, FN and MU-Series frames					
Clip only	not available	5507	30	120	

SILENCERS

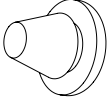
Item Description	Part Number	Package Number	Package Quantity	Package Price	Illustration
SILENCERS					
For use on F, FN, FE, DE, DW and MU-Series frames					
Open section frames	not available	Q146-100	100	33	
	not available	Q146-1000	1000	300	
Closed section frames	not available	Q146-2500	2500	675	
	not available	Q175-25	25	12	

KERFED FRAME SEALS

Item Description	Part Number	Package Number	Package Quantity	Package Price	Illustration
KERFED FRAME SEAL PIECES, BRONZE VINYL					
37" Lengths	not available	5371	10	45	
82" Lengths	not available	5375		98	
86" Lengths	not available	5376		105	
97" Lengths	not available	5377		120	
120" Lengths	not available	5378		142	

NOTE: Shaded items are non-stock



Prices subject to change without notice.

MISCELLANEOUS FRAME PARTS

FRAME

PARTS

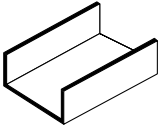
SPLICE SLEEVES

Item Description	Part Number	Package Number	Package Quantity	Package Price	Illustration
SPLICE SLEEVES - OPEN SECTION					
For use on F-Series frames, 2" face only					
4 ³ / ₄ " JD	not available	1128	6	96	
5 ³ / ₄ " JD	not available	1129			
6 ³ / ₄ " JD	not available	1130			
7 ³ / ₄ " JD	not available	2878			
8 ³ / ₄ " JD	not available	1131			
SPLICE SLEEVES - CLOSED SECTION					
For use on F-Series frames, 2" face only					
All jamb depths	not available	2462	12	86	



SPLICE REINF.

Item Description	Part Number	Package Number	Package Quantity	Package Price	Illustration
MULLION SPLICE CLIPS					
For use on F-Series frames, 2" face only					
All JD, double rabbeted 48 screws and 24 clips included	not available	1122	12 Sets	150	

THROAT FILLER

Item Description	Part Number	Package Number	Package Quantity	Package Price	Illustration
THROAT FILLER PIECE					
For use on DW, F and MU-Series frames					
87" long filler piece	not available	2518	50	615	

TRANSOM BAR AND PANEL KITS

Item Description	Part Number	Package Number	Package Quantity	Package Price	Illustration
K/D TRANSOM BAR CLIP					
For use on F-Series frames, 2" face only					
All jamb depths Four (4) angle brackets with screws	not available	2041	3 Sets	45	
ATTACHING KIT FOR 1 3/4" TRANSOM PANEL, NON-LABEL ONLY					
For use on F, FN, DW, K and MU-Series frames					
All jamb depths Two (2) angle brackets and Two (2) clips with screws	not available	2668	10	140	
MOUNTING CHANNELS FOR 1 3/4" TRANSOM PANELS, LABELED					
For use on F, FN and MU-Series frames					
96" long channels Four (4) verticals and Four (4) horizontal channels with screws	not available	4335	4	224	





WEATHERSTRIPPING

Item Description	Part Number	Package Number	Package Quantity	Package Price	Illustration
PS-074 WEATHERSTRIP PIECES, SELF ADHESIVE, BLACK VINYL					
36" lengths	not available	5372	50	200	
86" lengths	not available	5373		500	
120" lengths	not available	5374		634	

Prices subject to change without notice.

NOTE: Shaded items are non-stock

ASTRAGALS - OVERLAPPING "Z" TYPE FOR INACTIVE LEAF MOUNTING

Item Description	Part Number	Package Number	Package Quantity	Package Price	Illustration
ASA 4 7/8" STRIKE AND ANSI FLUSHBOLT PREP					
For use on L, B, CE, A14 and T-Series doors					
6'8" R/L	not available	1285	1	84	
7'0" R	not available	1286			
7'0" L	not available	1287			
7'2" R	not available	1288			
7'2" L	not available	1289			
8'0" R @ 12" from top	not available	1292			
8'0" L @ 12" from top	not available	1293			
8'0" R @ 24" top and 12" bottom	not available	1294			
8'0" L @ 24" top and 12" bottom	not available	1295			
ASA 4 7/8" STRIKE PREP					
For use on L, B, CE, A14 and T-Series doors					
6'8" R/L	not available	1242	1	70	
7'0" R	not available	1243			
7'0" L	not available	1244			
7'2" R	not available	1245			
7'2" L	not available	1246			
8'0" R	not available	1269			
8'0" L	not available	1270			
SQUARE EDGE ASA 4 7/8" STRIKE AND ANSI FLUSHBOLT PREP					
For use on SL and SZ-Series doors					
6'8" R/L	not available	1304	1	84	
7'0" R	not available	1305			
7'0" L	not available	1306			
SQUARE EDGE ASA 4 7/8" STRIKE PREP					
For use on SL and SZ-Series doors					
6'8" R/L	not available	1274	1	70	
7'0" R	not available	1275			
7'0" L	not available	1276			
SQUARE EDGE BLANK					
For use on SL and SZ-Series doors					
7'0" Blank	not available	1310	1	50	

ASTRAGALS - OVERLAPPING "Z" TYPE FOR ACTIVE LEAF MOUNTING

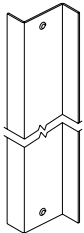
Item Description	Part Number	Package Number	Package Quantity	Package Price	Illustration
BLANK					
For use on L, B, CE, A14 and T-Series doors					
6'8" R	not available	15500	1	50	
6'8" L	not available	15501			
7'0" R	not available	15502			
7'0" L	not available	15503			
7'2" R	not available	15504			
7'2" L	not available	15505			
8'0" R	not available	15506			
8'0" L	not available	15507			

NOTES:

1. Z-Astragals are handed the same as the inactive leaf of pairs of doors.
2. Refer to the Steelcraft Tech Data Manual general section for handing illustrations and the Doors section for application details.
3. Astragals are prime painted, mounting screws are included.

NOTE: Shaded items are non-stock

Prices subject to change without notice.

2 PC ASTRAGALS - FOR ACTIVE LEAF MOUNTING RIGHT HAND APPLICATIONS

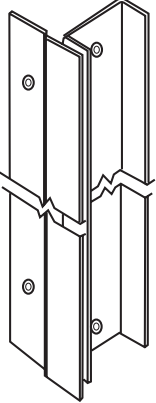
Item Description	Part Number	Package Number	Package Quantity	Package Price	Illustration	
ASA STRIKE AND FLUSHBOLT PREP						
For use on L-Series doors right hand application						
6'8"	not available	A001	1	100		
7'0"	not available	A003				
7'2"	not available	A004				
8'0"	not available	A006				
ASA STRIKE PREP ONLY						
6'8"	not available	A015	1	100		
7'0"	not available	A017				
7'2"	not available	A018				
8'0"	not available	A020				
FLUSHBOLT PREP ONLY						
6'8"	not available	A022	1	100		
7'0"	not available	A024				
7'2"	not available	A025				
8'0"	not available	A027				

2 PC ASTRAGALS - FOR ACTIVE LEAF MOUNTING LEFT HAND APPLICATIONS

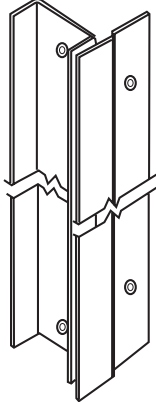
Item Description	Part Number	Package Number	Package Quantity	Package Price	Illustration	
ASA STRIKE AND FLUSHBOLT PREP						
For use on L-Series doors left hand application						
6'8"	not available	A029	1	100		
7'0"	not available	A031				
7'2"	not available	A032				
8'0"	not available	A034				
ASA STRIKE PREP ONLY						
6'8"	not available	A043	1	100		
7'0"	not available	A045				
7'2"	not available	A046				
8'0"	not available	A048				
FLUSHBOLT PREP ONLY						
6'8"	not available	A050	1	100		
7'0"	not available	A052				
7'2"	not available	A053				
8'0"	not available	A055				

ASTRAGALS - FLAT TYPE FOR ACTIVE LEAF MOUNTING

Item Description	Part Number	Package Number	Package Quantity	Package Price
FLAT BAR TYPE, 14 GAUGE FLAT STEEL, PRIME PAINTED, WITH MOUNTING HOLES AND SCREWS				
For use on L, B, CE, T and A14-Series doors				
7' 0" length x 1 1/2" wide	not available	15700	1	43
8' 0" length x 1 1/2" wide	not available	15750		

NOTES:

- Two piece astragals are handed the same as the inactive leaf of pairs of doors.
- Refer to the Steelcraft Tech Data Manual general section for handing illustrations and the Doors section for application details.
- Astragals are prime painted, mounting screws are included.

Prices subject to change without notice.

NOTE: Shaded items are non-stock

CAPS - STEEL TOP OR BOTTOM MOUNT

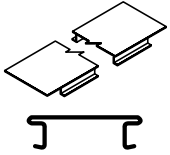
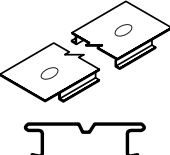
Item Description	Part Number	Package Number	Package Quantity	Package Price	Illustration
SNAP-IN TYPE, 24 GAUGE PRIME PAINTED					
For use on L, B, CE, A14 and T-Series doors					
2'0"	not available	9630	6	81	
2'4"	not available	9631			
2'6"	not available	9632			
2'8"	not available	9633			
2'10"	not available	9634			
3'0"	not available	9635			
3'4"	not available	9636			
3'6"	not available	9637			
3'8"	not available	9638			
3'10"	not available	9639			
4'0"	not available	9640			
SCREW-IN TYPE, 24 GAUGE PRIME PAINTED, DIMPLED FOR SCREW MOUNTING, SCREWS INCLUDED					
For use on L, B, CE, A14 and T-Series doors					
2'8"	not available	9633D	6	90	
3'0"	not available	9630D			
3'6"	not available	9632D			
4'0"	not available	9640D			
For use on SL and SZ-Series doors					
3'0"	not available	9656D	6	90	

CHANNELS

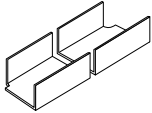
Item Description	Part Number	Package Number	Package Quantity	Package Price	Illustration	
TOP AND BOTTOM END CHANNELS, 14 GAUGE						
For use on L, B, A14 and T-Series doors (set contains 2 top and 2 bottom channel)						
3'0" door width	not available	4145	4	145		
4'0" door width	not available	4146		155		
REINF. CHANNEL, 18 GAUGE						
For cutouts in 13/4" doors						
15/8" wide x 93" long x 1/2" legs	not available	5501	10	275		

NOTE: Shaded items are non-stock

Prices subject to change without notice.

DUTCH DOOR SHELVES

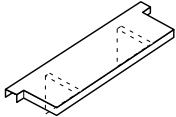
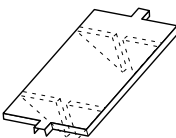
Item Description	Part Number	Package Number	Package Quantity	Package Price	Illustration
HALF SHELF - 7" WIDE					
For use on L and B-Series doors					
2'0"	not available	1332	1	284	
2'4"	not available	1333			
2'6"	not available	1334			
2'8"	not available	1335			
2'10"	not available	4109			
3'0"	not available	1336			
3'4"	not available	1337			
3'6"	not available	1338			
3'8"	not available	1339			
3'10"	not available	1340			
4'0"	not available	1341			
FULL SHELF - 12" WIDE					
For use on L and B-Series doors					
2'0"	not available	4110	1	483	
2'4"	not available	4111			
2'6"	not available	4112			
2'8"	not available	4113			
2'10"	not available	4114			
3'0"	not available	4115			
3'4"	not available	4116			
3'6"	not available	4117			
3'8"	not available	4118			
3'10"	not available	4119			
4'0"	not available	4120			

FILLER PLATES

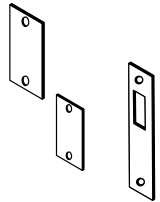
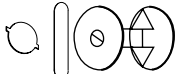
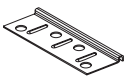
Item Description	Part Number	Package Number	Package Quantity	Package Price	Illustration	
HINGE FILLER PLATES, 12 GAUGE, PRIME PAINTED						
4 1/2" regular weight	not available	1401	12	108		
LOCK EDGE FILLER PLATES						
161 edge (plastic) 1 1/8" wide x 2 1/4" long	not available	3293	12	95		
86 edge 1 1/8" wide x 8" long x 1/8" thick	not available	1404	6	63		
86 edge slotted filler allows for attachment of ASA strike	not available	2198		130		
LOCK FACE FILLER PLATES						
161 filler assembly (2 pieces)	not available	1405	2 Sets	44		
161 punch-out plate	not available	1422	100	200		
86 punch-out plate	not available	1424				
SQUARE EDGE HINGE FILLER PLATE, 20 GAUGE, PRIME PAINTED						
For use on SL and SZ-Series doors						
4 1/2" standard weight	not available	5531	100	162		





NOTES:

1. Dutch door shelves are prime painted. Mounting brackets and screws are included.

Prices subject to change without notice.

NOTE: Shaded items are non-stock

DEZIGNER TRIM KITS, standard sizes for 1/4" glass (3/8" glazing pocket)

Item Description	Exposed Glass Size	Part Number	Package Number	Package Quantity	Package Price	Illustration	
VISION AND NARROW LIGHTS							
V - vision light	9 1/2" x 9 1/2"	not available	10075	2 Kits	122		
N3 - narrow light	3" x 33"	not available	10164				
N4 - narrow light	4" x 25"	not available	10072				
N5 - narrow light	5" x 20"	not available	10165				
NARROW LIGHTS							
N for 6'8" high door	7 1/2" x 30 5/8"	not available	10066	2 Kits	185		
N for 7'0" high door	7 1/2" x 34 5/8"	not available	10068				
N for 7'2" high door	7 1/2" x 36 5/8"	not available	10069				
N for 8'0" high door	7 1/2" x 46 5/8"	not available	10071				
LONG NARROW LIGHTS							
LNL for 6'8" high door	7 1/2" x 58 1/8"	not available	10166	2 Kits	197		
LNL for 7'0" high door	7 1/2" x 62 1/8"	not available	10167				
LNL for 7'2" high door	7 1/2" x 64 1/8"	not available	10168				
LNL for 8'0" high door	7 1/2" x 74 1/8"	not available	10169				
HALF GLASS LIGHTS							
For 2'6" wide doors							
G for 6'8" high door	16 1/4" x 30 5/8"	not available	10012	2 Kits	197		
G for 7'0" high door	16 1/4" x 34 5/8"	not available	10014				
G for 7'2" high door	16 1/4" x 36 5/8"	not available	10015				
G for 8'0" high door	16 1/4" x 46 5/8"	not available	10170				
For 2'8" wide doors							
G for 6'8" high door	18 1/4" x 30 5/8"	not available	10018	2 Kits	203		
G for 7'0" high door	18 1/4" x 34 5/8"	not available	10020				
G for 7'2" high door	18 1/4" x 36 5/8"	not available	10021				
G for 8'0" high door	18 1/4" x 46 5/8"	not available	10171				
For 3'0" wide doors							
G for 6'8" high door	22 1/4" x 30 5/8"	not available	10030	2 Kits	215		
G for 7'0" high door	22 1/4" x 34 5/8"	not available	10032				
G for 7'2" high door	22 1/4" x 36 5/8"	not available	10033				
G for 8'0" high door	22 1/4" x 46 5/8"	not available	10172				
For 3'6" wide doors							
G for 6'8" high door	28 1/4" x 30 5/8"	not available	10042	2 Kits	233		
G for 7'0" high door	28 1/4" x 34 5/8"	not available	10044				
G for 7'2" high door	28 1/4" x 36 5/8"	not available	10045				
G for 8'0" high door	28 1/4" x 46 5/8"	not available	10173				
For 4'0" wide doors							
G for 6'8" high door	34 1/4" x 30 5/8"	not available	10060	2 Kits	248		
G for 7'0" high door	34 1/4" x 34 5/8"	not available	10062				
G for 7'2" high door	34 1/4" x 36 5/8"	not available	10063				
G for 8'0" high door	34 1/4" x 46 5/8"	not available	10174				
DEZIGNER TRIM KITS NON-STANDARD SIZE FOR 1/4" GLASS							
NET CUTOUT DIMENSION MUST BE SPECIFIED ON ORDER							
Special size light kit (see note #6)	As specified	not available	10217-SPCL	1 Kit	190		

NOTES:

- The parts above are standard size Dezigner Trim kits for L, B, SL and T-Series doors.
- 3/8" glazing pocket for use with 1/4" glass.
- Cutout of door and installation is by the distributor.
- The packages listed include parts for two (2) doors with mounting clips.
- Labeled doors require spacer channels (package #10332) when glass size exceeds 12" in either direction.
- Dezigner Trim light kits for non-standard sizes are ordered by the noted package number. Cutout width and height must also be specified.

NOTE: Shaded items are non-stock

Prices subject to change without notice.



GLASS TRIM - 1/2" GLASS

FOR DISTRIBUTOR INSTALLATION

DOOR

PARTS

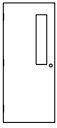
DEZIGNER TRIM KITS, standard sizes, for 1/2" glass (5/8" glazing pocket)

Item Description	Exposed Glass Size	Part Number	Package Number	Package Quantity	Package Price	Illustration	
VISION AND NARROW LIGHTS							
V - vision light	9 1/2" x 9 1/2"	not available	10175	2 Kits	134		
N3 - narrow light	3" x 33"	not available	10177				
N4 - narrow light	4" x 25"	not available	10176				
N5 - narrow light	5" x 20"	not available	10178				
NARROW LIGHTS							
N for 6'8" high door	7 1/2" x 30 5/8"	not available	10179	2 Kits	203		
N for 7'0" high door	7 1/2" x 34 5/8"	not available	10180				
N for 7'2" high door	7 1/2" x 36 5/8"	not available	10181				
N for 8'0" high door	7 1/2" x 46 5/8"	not available	10182				
LONG NARROW LIGHTS							
LNL for 6'8" high door	7 1/2" x 58 1/8"	not available	10183	2 Kits	216		
LNL for 7'0" high door	7 1/2" x 62 1/8"	not available	10184				
LNL for 7'2" high door	7 1/2" x 64 1/8"	not available	10185				
LNL for 8'0" high door	7 1/2" x 74 1/8"	not available	10186				
HALF GLASS LIGHTS							
For 2'6" wide doors							
G for 6'8" high door	16 1/4" x 30 5/8"	not available	10187	2 Kits	216		
G for 7'0" high door	16 1/4" x 34 5/8"	not available	10188				
G for 7'2" high door	16 1/4" x 36 5/8"	not available	10189				
G for 8'0" high door	16 1/4" x 46 5/8"	not available	10190				
For 2'8" wide doors							
G for 6'8" high door	18 1/4" x 30 5/8"	not available	10191	2 Kits	224		
G for 7'0" high door	18 1/4" x 34 5/8"	not available	10192				
G for 7'2" high door	18 1/4" x 36 5/8"	not available	10193				
G for 8'0" high door	18 1/4" x 46 5/8"	not available	10194				
For 3'0" wide doors							
G for 6'8" high door	22 1/4" x 30 5/8"	not available	10195	2 Kits	236		
G for 7'0" high door	22 1/4" x 34 5/8"	not available	10196				
G for 7'2" high door	22 1/4" x 36 5/8"	not available	10197				
G for 8'0" high door	22 1/4" x 46 5/8"	not available	10198				
For 3'6" wide doors							
G for 6'8" high door	28 1/4" x 30 5/8"	not available	10199	2 Kits	257		
G for 7'0" high door	28 1/4" x 34 5/8"	not available	10200				
G for 7'2" high door	28 1/4" x 36 5/8"	not available	10201				
G for 8'0" high door	28 1/4" x 46 5/8"	not available	10202				
For 4'0" wide doors							
G for 6'8" high door	34 1/4" x 30 5/8"	not available	10203	2 Kits	273		
G for 7'0" high door	34 1/4" x 34 5/8"	not available	10204				
G for 7'2" high door	3 1/4" x 36 5/8"	not available	10205				
G for 8'0" high door	34 1/4" x 46 5/8"	not available	10206				
DEZIGNER TRIM KITS NON-STANDARD SIZE FOR 1/2" GLASS							
NET CUTOUT DIMENSION MUST BE SPECIFIED ON ORDER							
Special size light kit (see note #6)	As specified	not available	10218-SPCL	1 Kit	190		

NOTES:

1. The parts above are standard size Dezigner Trim kits for L, B, SL and T-Series doors.
2. 5/8" glazing pocket for use with 1/2" glass.
3. Cutout of door and installation is by the distributor.
4. The packages listed include parts for two (2) doors with mounting clips.
5. Labeled doors require spacer channels (package #10332) when glass size exceeds 12" in either direction.
6. Dezigner Trim light kits for non-standard sizes are ordered by the noted package number. Cutout width and height must also be specified.

Prices subject to change without notice.

NOTE: Shaded items are non-stock

DEZIGNER TRIM PARTS

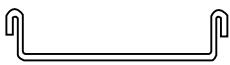
Item Description	Part Number	Package Number	Package Quantity	Package Price	Illustration
TRIM CLIPS AND SPACERS					
Mounting clips (for use with distributor cutout, 1/4" glass)	not available	10333	250	192	
Mounting clips (for use with distributor cutout, 1/2" glass)	not available	10335	250	192	
Label spacer channel	not available	10332	50	50	

CHANNEL AND BEAD TRIM PARTS

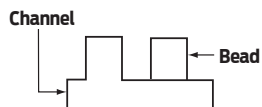
Item Description	Part Number	Package Number	Package Quantity	Package Price	Illustration
STEEL GLASS TRIM PIECES, FOR INSULATED GLASS THRU 5/8" THICK					
For use on L, B, A14 and T-Series doors					
93" length (3/4" high stops)	not available	3435	4 sets	243	

NOTE: Shaded items are non-stock





Prices subject to change without notice.

MISCELLANEOUS DOOR PARTS

DOOR

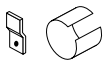
PARTS

HARDWARE REINF.

Item Description	Part Number	Package Number	Package Quantity	Package Price	Illustration
DEADLOCK KITS					
Strike reinf. Two (2) reinf. per kit	not available	2042	4 Kits	67	
Schlage B-Series kit Two (2) reinf. and One (1) spacer per kit	not available	2585		78	
FLUSHBOLT KITS					
ANSI Flushbolt reinf channel for use with or without astragal	not available	2453	2 Kits	26	
ANSI Flushbolt reinf angle for use with or without astragal	not available	2454	2 Kits	84	
HINGES					
4 1/2" Universal 7 gauge wire spacer included	not available	8531	40	292	
5" Universal 7 gauge wire spacer included	not available	9921			
LOCK REINF. BOXES					
161 x 2 3/4" backset	not available	4148	10	85	
86 x 2 3/4" backset	not available	4149	4	65	

NOSING - DOUBLE ACTING DOOR APPLICATIONS

Item Description	Part Number	Package Number	Package Quantity	Package Price	Illustration
EXTRUDED ALUMINUM					
For use on beveled edge doors only					
7'0" length	not available	2620	1	75	
8'0" length	not available	2621			

SWEEPS

Item Description	Part Number	Package Number	Package Quantity	Package Price	Illustration
FAS-SEAL DOOR BOTTOM SWEEP					
For use on L, B, CE, A14, H and T-Series doors					
3'0"	not available	8424	25	337	
4'0"	not available	5251		400	

SCREWS

Item Description	Part Number	Package Number	Package Quantity	Package Price
MISCELLANEOUS FASTENERS				
8 - 18 x 1 1/4" phillips OH type B Self drilling for glazing bead	not available	4169	144	88
1/4" - 20 phillips RHMS Type AB for adjustable base anchor	not available	4167		60
8 x 1/2" phillips Self drilling for astragals	not available	4168		43
8 - 18 x 5/8" phillips TSSMS type AB for UL DW and K-Series heads	not available	9930		

Prices subject to change without notice.

NOTE: Shaded items are non-stock

PAINT

Item Description	Part Number	Package Quantity	Package Price
PRIMER - STEELCRAFT BEIGE			
Beige: one (1) gallon can, water base	200	2 Cans (2 gallons total)	291
Beige: five (5) gallon pail, water base	205	2 Pails (10 gallons total)	970
Beige: one (1) gallon can, solvent base	2519	2 Cans (2 gallons total)	291
Beige: 16 ounce spray can, 13 ounce net, solvent base	8421	12 Cans	232
Stainable primer, quart	8282	1	48
FRAME BACK COATING			
Asphaltic Coating*: 16 ounce spray can	8430	12 Cans	576
Asphaltic Coating*: one (1) gallon can	210	2 Cans (2 gallons total)	124
Asphaltic Coating*: five (5) gallon pail	211	1 Pail (5 gallons total)	272

* Bituminous Alternative (Modified Asphaltic Emulsion), Certified up to 3-hours in fire rated masonry applications, sprayable, VOC & HAPS Free

GRAINTECH™ STAINS

Item Description	Part Number	Package Quantity	Package Price
STANDARD COLOR STAINS			
Ash	8270	1 Quart	100
Birch	8271		
Mahogany	8272		
Maple	8273		
Oak	8274		
Walnut	8275		

SAMPLE PRODUCTS

Item Description	Part Number	Package Quantity	Package Price
DOOR AND FRAME SAMPLES			
Suitcase samples	7170	1	168 Net
Typical wall section display	7152	1	48 Net
GRAINTECH™ door - Oak Finish	32	1	75 Net
Miniature B-Series door (16" x 18")	04500	1	106 Net
Dezigner Trim sample	7330	1	22 Net
Stainable steel panel - primed finish	5230	1	6 Net
GRAINTECH™ color chip set (6 colors)	4001	1	18 Net
CE-Series embossed panel section	7297	1	6 Net

NOTE: Shaded items are non-stock

Prices subject to change without notice.

TABLE OF CONTENTS

BLUE ASH

FRAME COMPONENTS

F16-Series 118
 F16-Series Galvannealed 119
 F14-Series Galvannealed 119
 FE16-Series Double Egress 120
 DW16-Series 120

WELDED 3 SIDED FRAMES

F16-Series 120

STICK LENGTHS

F16-Series 121
 F14-Series 121

FRAME KWIK-PAKS

F16-Series 55 Pak Components 122
 DW16-Series 48 Pak Components 122

DOORS (UNITS AND KWIK-PAKS)

L20-Series 6'8" Flush Doors 123
 L18-Series Flush Doors 123
 SL18-Series (Square Edge) Flush Doors 123
 SZ18-Series (Square Edge) Flush Doors 124

WEST COAST SERVICE CENTER

MODIFIED STOCK

Frames 125
 Doors 126

FRAME COMPONENTS

F16-Series 127
 K16-Series 127

DOORS (UNITS)

L18-Series Flush Doors 128
 SL18-Series Flush Doors 129
 SZ18-Series Flush Doors 129

ORDERING INFORMATION

STOCK

1. Mark numbers on stock products are not available.
2. All stock hinge jambs and doors, as indicated, have a Warnock Hersey (WH) mylar label attached.
3. Standard loose jamb and base anchors are included with all **Stock Frame** orders. Sticks do not include anchors.
4. Items marked with (*) indicate **KWIK-PAK** availability.
5. Orders shall be placed using OEW or Steelcraft order forms.

KWIK-PAKS

1. KWIK-PAK products are at the following bulk rates:
 Doors: 20 Pak prices are 5% less
 10 Pak prices are 3% less (Blue Ash Only)
 Frames: 55 Pak prices are 8% less
 48 Pak prices are 5% less
2. Frames do not include jamb or base anchors. DW-Series frames have base anchor attaching strap installed.
3. Quoted discounts do not apply to the Kwik-Pak product discounts.

WEST COAST STOCK AND MODIFIED STOCK

1. Orders for modified stock are limited to 20 doors and/or frames per order.
2. Quantities are subject to availability of each SKU. Please see current inventory levels in the West Coast stock section.
3. Welded 3-sided frames are included in the modified stock program.
4. For access to Blue Ash stock please order through the OEW RAPID program.

Prices subject to change without notice.

F16-SERIES JAMB COMPONENTS

Height	Description			5 ³ / ₄ "		7 ³ / ₄ "		8 ¹ / ₄ "		8 ³ / ₄ "	
				Part #	List \$	Part #	List \$	Part #	List \$	Part #	List \$
JAMB COMPONENTS											
6'8"	SJ	R	ASA	292*	78	713	82	7460	90	384	90
	SJ	R	BLK	7414	78						
	SJ	L	ASA	295*	78	715	82	7461	90	387	90
	SJ	L	BLK	7415	78						
	HJ	R	WH	294*	93	714	96	7462	106	386	106
	HJ	L	WH	297*	93	716	96	7463	106	389	106
7'0"	SJ	R	ASA	302*	81	717*	91	802*	97	390*	97
	SJ	R	BLK	303*	81						
	SJ	L	ASA	305*	81	719*	91	806*	97	393*	97
	SJ	L	BLK	306*	81						
	EJ	R†		7416	81						
	EJ	L†		7417	81						
	HJ	R	Less WH	760*	96						
	HJ	L	Less WH	761*	96						
7'2"	SJ	R	ASA	312	89						
	SJ	L	ASA	315	89						
	HJ	R	WH	314	102						
	HJ	L	WH	317	102						
8'0"	SJ	R	ASA	318*	94						
	SJ	R	BLK	300	94						
	SJ	L	ASA	320*	94						
	SJ	L	BLK	301	94						
	HJ	R	WH	319*	122						
	HJ	L	WH	321*	122						

F16-SERIES HEAD COMPONENTS

Width	Description			5 ³ / ₄ "		7 ³ / ₄ "		8 ¹ / ₄ "		8 ³ / ₄ "	
				Part #	List \$	Part #	List \$	Part #	List \$	Part #	List \$
HEAD COMPONENTS											
2'0"	HD			7420	36						
2'4"	HD			7421	36						
2'6"	HD			324*	36						
2'8"	HD			325*	36						
3'0"	HD			326*	36	706*	41	808*	49	400*	49
	HD	4" Face		334*	76					7479*	89
3'4"	HD			327	49						
3'6"	HD			328	49						
3'8"	HD			329	49						
4'0"	HD			330*	49			7471	58		
	HD	4" Face		7428	89						
5'0"	HD	D		331	76						
6'0"	HD	D		333*	82			7473	98	407	98
	HD	D	FB Strike	349*	124						
	HD	D	4" Face	335	138						
8'0"	HD	D		336	93						

NOTES:

- † End Jamb (EJ R/L) are handed the same as Blank Hinge Jambs (HJ R/L BLK), and will be invoiced as Blank Strike Jambs.
- * Available as KWIK-PAK.

Prices subject to change without notice.

F16-SERIES GALVANNEALED JAMB COMPONENTS

Height	Description	5 ³ / ₄ " GALV		8 ³ / ₄ " GALV	
		Part #	List \$	Part #	List \$
JAMB COMPONENTS					
6'8"	SJ R ASA	685	92		
	SJ L ASA	687	92		
	HJ R WH	686	107		
	HJ L WH	688	107		
7'0"	SJ R ASA	681*	95	7527	113
	SJ R BLK	7510*	95		
	SJ L ASA	682*	95	7529	113
	SJ L BLK	7511*	95		
	HJ R WH	683*	110	7531	125
	HJ L WH	684*	110	7532	125
8'0"	SJ R ASA	7514	108		
	SJ L ASA	7515	108		
	HJ R WH	7516	136		
	HJ L WH	7517	136		

F16-SERIES GALVANNEALED HEAD COMPONENTS

Height	Description	5 ³ / ₄ " GALV		8 ³ / ₄ " GALV	
		Part #	List \$	Part #	List \$
HEAD COMPONENTS					
3'0"	HD	671*	44		
	HD 4" Face	340*	84	7520	98
4'0"	HD	7501	57		
	HD 4" Face	344	97		
6'0"	HD D	676	90		
	HD D 4" Face	347	146		

F14-SERIES GALVANNEALED JAMB AND HEAD COMPONENTS

Height	Description	5 ³ / ₄ " GALV	
		Part #	List \$
JAMB COMPONENTS			
7'0"	SJ R ASA	904*	119
	SJ L ASA	906*	119
	HJ R WH	905*	126
	HJ L WH	907*	126
Width	Description	5 ³ / ₄ " GALV	
Part #	List \$		
HEAD COMPONENTS			
3'0"	HD	908*	64
	HD 4" Face	7533*	98
4'0"	HD 4" Face	7535	109
6'0"	HD D 4" Face	7536	159

F14-SERIES GALVANNEALED KWIK-PAKS

Height	Description	5 ³ / ₄ " GALV	
		Part #	List \$
JAMBS - 2" FACE (55 PIECES PER PAK)			
7'0"	SJ R ASA	904	5,619
	SJ L ASA	906	5,619
	HJ R WH	905	5,973
	HJ L WH	907	5,973
Width	Description	5 ³ / ₄ " GALV	
Part #	List \$		
HEADS - 2" FACE (55 PIECES PER PAK)			
3'0"	HD	908	3,238
HEADS - 4" FACE (48 PIECES PER PAK)			
3'0"	HD 4" Face	7533	4,742

NOTES:

1. Stock frames listed as Galv are A-60 material.
2. * Available as KWIK-PAK.

Prices subject to change without notice.

FE16-SERIES DOUBLE EGRESS JAMB AND HEAD COMPONENTS

		5 ³ / ₄ "	
Height	Description	Part #	List \$
MITERED JAMB COMPONENTS			
6'8"	HJ R/R	7545	196
7'0"	HJ R/R	7546	197
		5 ³ / ₄ "	
Width	Description	Part #	List \$
MITERED HEAD COMPONENTS			
6'0"	HD R/R	7543	288
8'0"	HD R/R	7544	301

NOTES:

1. Door opening width for FE-Series heads is undersized 1/8".

DW16-SERIES JAMB AND HEAD COMPONENTS

		5 ³ / ₄ "		5 ⁷ / ₈ "		7 ¹ / ₈ "		8 ¹ / ₄ "	
Height	Description	Part #	List \$	Part #	List \$	Part #	List \$	Part #	List \$
JAMB COMPONENTS									
6'8"	SJ R ASA	519*	81	531*	81	750	92	7547	109
	SJ L ASA	521*	81	533*	81	752	92	7548	109
	HJ R WH	520*	92	532*	92	751	100	7549	118
	HJ L WH	522*	92	534*	92	753	100	7550	118
7'0"	SJ R ASA	523*	90	535*	90	754	100	7551*	116
	SJ L ASA	525*	90	537*	90	756	100	7552*	116
	HJ R Less WH			762*	100				
	HJ L Less WH			763*	100				
8'0"	HJ R WH	524*	100	536*	100	755	108	7553*	122
	HJ L WH	526*	100	538*	100	757	108	7554*	122
	SJ R ASA			540	98				
	SJ L ASA			544	98				
8'0"	HJ R WH			539	121				
	HJ L WH			545	121				
		5 ³ / ₄ "		5 ⁷ / ₈ "		7 ¹ / ₈ "		8 ¹ / ₄ "	
Height	Description	Part #	List \$	Part #	List \$	Part #	List \$	Part #	List \$
HEAD COMPONENTS									
2'6"	HD			541*	40				
2'8"	HD			542*	40				
3'0"	HD	530*	40	543*	40	759	49	7555*	58
4'0"	HD			547*	49				
6'0"	HD	514	79	549*	79				

F16-SERIES WELDED 3 SIDED FRAMES - 5³/₄" JAMB DEPTH

Width	Description				Part #	List \$	Pkg. Qty.	
6'8" HIGH								
3'0"	RH	WH	ASA	RA/PA Reinf.	CRS	10212	5,732	20 total (10 RH, 10 LH)
	LH	WH	ASA	RA/PA Reinf.	CRS			
7'0" HIGH								
3'0"	RH	WH	ASA	PA Reinf. 4" face	GALV	10207	8,384	24 total (12 RH, 12 LH)
	LH	WH	ASA	PA Reinf. 4" face	GALV			
	LH	WH	ASA	RA/PA Reinf.	CRS	10211	7,016	24 total (12 RH, 12 LH)
	RH	WH	ASA	RA/PA Reinf.	CRS			
	RH	WH	ASA	RA/PA Reinf.	GALV	10214	7,836	24 total (12 RH, 10 LH)
	RH	WH	ASA	RA/PA Reinf.	GALV			
	RH	WH	ASA	PA Reinf. 4" face	GALV	7674	8,384	24
	LH	WH	ASA	PA Reinf. 4" face	GALV	7675	8,384	24
RH	WH	ASA	RA/PA Reinf.	CRS	7676	7,016	24	
LH	WH	ASA	RA/PA Reinf.	CRS	7677	7,016	24	

NOTES:

1. Welded 3 sided frame miters are face welded and finished and do not include jamb or base anchors.
2. One temporary spreader (shipping bar) included on each frame.
3. *Available as KWIK-PAK.

Prices subject to change without notice.

F16-SERIES OPEN SECTION STICKS (12'1" LENGTH)

TSF#	Description	4 ³ / ₄ "		5 ³ / ₄ "		5 ³ / ₄ " GALV		6 ³ / ₄ "		7 ³ / ₄ "		8 ¹ / ₄ "		8 ³ / ₄ "	
		Part #	List \$	Part #	List \$	Part #	List \$	Part #	List \$	Part #	List \$	Part #	List \$	Part #	List \$
OPEN SECTION - SQUARE CUT BOTH ENDS															
21	Blank rail	551	137	571	137	572	160	585	152	590	152	820	194	594	194
23	Blank rail – 4" face			573	188	596	209	606	203	613	203	2291	258	620	258
40	Blank rail – cased open			583	137										
24	R single hinge 6'8"			574	179										
	L single hinge 6'8"			575	179										
25	R single hinge 7'0"			576	179										
	L single hinge 7'0"			577	179										
26	R strike jamb ASA			578	151										
	L strike jamb ASA			579	151										
SILL SECTION - SQUARE CUT BOTH ENDS															
104	81/8" full sill					629	349								
105	61/8" full sill					644	349								
FILLER PLATES - SQUARE CUT BOTH ENDS (FOR CONVERTING OPEN TO CLOSED SECTION)															
22	Weld-in with stop					627	174								
27	Weld-in w/o stop					628	174								
89	Snap-in with stop			771	208										

F16-SERIES CLOSED SECTION STICKS (10'6" LENGTHS)

TSF#	Description	4 ³ / ₄ "		5 ³ / ₄ "		5 ³ / ₄ " GALV		6 ³ / ₄ "		7 ³ / ₄ "		8 ¹ / ₄ "		8 ³ / ₄ "	
		Part #	List \$	Part #	List \$	Part #	List \$	Part #	List \$	Part #	List \$	Part #	List \$	Part #	List \$
CLOSED SECTION MULLION 10'6" OVERALL LENGTH - SQUARE CUT BOTH ENDS															
16	Blank mullion	5510	268	5691	268	5681	298	5841	306	5891	306	8211	341	59311	341
41	R single strike			2296	282										
	L single strike			2304	282										
43	R single hinge 7'0"			2297	310										
	L single hinge 7'0"			2305	310										

F16-SERIES CLOSED SECTION STICKS (OPENING HEIGHTS)

TSF#	Description	4 ³ / ₄ "		5 ³ / ₄ "		5 ³ / ₄ " GALV		6 ³ / ₄ "		7 ³ / ₄ "		8 ¹ / ₄ "		8 ³ / ₄ "	
		Part #	List \$	Part #	List \$	Part #	List \$	Part #	List \$	Part #	List \$	Part #	List \$	Part #	List \$
CLOSED SECTION MULLION 6'8" OVERALL LENGTH – NOTCHED FOR STOP AT HEAD															
10	R single strike 6'8"			564	197										
	L single strike 6'8"			565	197										
CLOSED SECTION MULLION 7'0" OVERALL LENGTH – NOTCHED FOR STOP AT HEAD															
20	Blank 7'0" mullion			570	192										
14	R single hinge 7'0"			562	234										
	L single hinge 7'0"			563	234										
15	R single strike 7'0"			566	206										
	L single strike 7'0"			567	206										

F14-SERIES OPEN SECTION STICKS (12'1" LENGTHS)

TSF#	Description	4 ³ / ₄ "		5 ³ / ₄ "		5 ³ / ₄ " GALV		6 ³ / ₄ "		7 ³ / ₄ "		8 ¹ / ₄ "		8 ³ / ₄ "	
		Part #	List \$	Part #	List \$	Part #	List \$	Part #	List \$	Part #	List \$	Part #	List \$	Part #	List \$
OPEN SECTION 12'1" LENGTHS															
21	Blank rail			608	164	603	183								
23	Blank rail – 4" face					581	244								
25	R single hinge 7'0"					587	225								
	L single hinge 7'0"					588	225								

F14-SERIES CLOSED SECTION STICK (10'6" LENGTHS)

TSF#	Description	4 ³ / ₄ "		5 ³ / ₄ "		5 ³ / ₄ " GALV		6 ³ / ₄ "		7 ³ / ₄ "		8 ¹ / ₄ "		8 ³ / ₄ "	
		Part #	List \$	Part #	List \$	Part #	List \$	Part #	List \$	Part #	List \$	Part #	List \$	Part #	List \$
CLOSED SECTION MULLION 10'6" OVERALL LENGTH - SQUARE CUT BOTH ENDS															
16	Blank mullion			8212	311	60211	336								

NOTE: All items marked as GALV are A-60 material.

Prices subject to change without notice.

F16-SERIES JAMB KWIK-PAKS

Height	Description	5 ³ / ₄ "		5 ³ / ₄ " GALV		7 ³ / ₄ "		8 ¹ / ₄ "		8 ³ / ₄ "	
		Part #	List \$	Part #	List \$	Part #	List \$	Part #	List \$	Part #	List \$
JAMBS (55 PIECES PER PAK)											
6'8"	SJ R ASA	292	3,545								
	SJ L ASA	295	3,545								
	HJ R WH	294	4,304								
	HJ L WH	297	4,304								
7'0"	SJ R ASA	302	3,696	681	4,405						
	SJ R BLK	303	3,696	7510	4,405						
	SJ L ASA	305	3,696	682	4,405						
	SJ L BLK	306	3,696	7511	4,405						
	HJ R Less WH	760	4,455								
	HJ L Less WH	761	4,455								
	HJ R WH	304	4,455	683	5,164						
	HJ L WH	307	4,455	684	5,164						
8'0"	SJ R ASA	318	4,345								
	SJ L ASA	320	4,345								
	HJ R WH	319	5,771								
	HJ L WH	321	5,771								
JAMBS (48 PIECES PER PAK)											
7'0"	SJ R ASA			717	3,787	802	4,061	390	4,061		
	SJ L ASA			719	3,787	806	4,061	393	4,061		
	HJ R WH			718	4,197	803	4,608	392	4,608		
	HJ L WH			720	4,197	807	4,608	395	4,608		

F16-SERIES HEAD KWIK-PAKS

Height	Description	5 ³ / ₄ "		5 ³ / ₄ " GALV		7 ³ / ₄ "		8 ¹ / ₄ "		8 ³ / ₄ "	
		Part #	List \$	Part #	List \$	Part #	List \$	Part #	List \$	Part #	List \$
HEADS - 2" FACE (55 PIECES PER PAK)											
2'6"	HD	324	1,822								
2'8"	HD	325	1,822								
3'0"	HD	326	1,822	671	2,226						
4'0"	HD	330	2,479								
6'0"	HD D	333	4,149								
	HD D FB	349	6,274								
HEADS - 2" FACE (48 PIECES PER PAK)											
3'0"	HD			706	1,870	808	2,234	400	2,234		
HEADS - 4" FACE (48 PIECES PER PAK)											
3'0"	HD 4" face	334	3,466	340	3,830						

DW16-SERIES JAMB KWIK-PAKS

Height	Description	5 ⁵ / ₈ "		5 ⁷ / ₈ "		8 ¹ / ₄ "	
		Part #	List \$	Part #	List \$	Part #	List \$
JAMBS (48 PIECES PER PAK)							
6'8"	SJ R ASA	519	3,589	531	3,589		
	SJ L ASA	521	3,589	533	3,589		
	HJ R WH	520	4,090	532	4,090		
	HJ L WH	522	4,090	534	4,090		
7'0"	SJ R ASA	523	3,999	535	3,999	7551	5,185
	SJ L ASA	525	3,999	537	3,999	7552	5,185
	HJ R Less WH			762	4,455		
	HJ L Less WH			763	4,455		
	HJ R WH	524	4,455	536	4,455	7553	5,458
	HJ L WH	526	4,455	538	4,455	7554	5,458

DW16-SERIES HEAD KWIK-PAKS

Height	Description	5 ⁵ / ₈ "		5 ⁷ / ₈ "		8 ¹ / ₄ "	
		Part #	List \$	Part #	List \$	Part #	List \$
HEADS (48 PIECES PER PAK)							
2'6"	HD			541	1,824		
2'8"	HD			542	1,824		
3'0"	HD	530	1,824	543	1,824	7555	2,645
4'0"	HD			547	2,234		
6'0"	HD D			549	3,602		

NOTES:

1. Must be ordered in Kwik-Pak quantities for pricing.

Prices subject to change without notice.

L20-SERIES FLUSH DOORS - BEVELED EDGES AND HANDED

Width	Description				Part #	Unit Door \$	10 PAK \$	20 PAK \$
6'8" HIGH								
3'0"	R/LHR	161		WH	173	562	5,451	10,678
	L/RHR	161		WH	174			
7'0" HIGH								
3'0"	R/LHR	161		WH	181	583	5,655	11,077
	L/RHR	161		WH	182			

L18-SERIES FLUSH DOORS - BEVELED EDGES AND HANDED

Width	Description				Part #	Unit Door \$	10 PAK \$	20 PAK \$				
6'8" HIGH												
3'0"	R/LHR	161		WH	047	616	5,975	11,704				
	L/RHR	161		WH	048							
	R/LHR	161	C	WH	066	643	6,237	12,217				
	L/RHR	161	C	WH	067							
	R/LHR	61L	C	WH	036							
	L/RHR	61L	C	WH	037							
	R/LHR	86ED	C	WH	076							
	L/RHR	86ED	C	WH	077							
	R/LHR	RPD	C	WH	7602	677	6,567	12,863				
	L/RHR	RPD	C	WH	7603							
	R/LHR	161	C	POLYS GALV	061	749	7,265	14,231				
	L/RHR	161	C	POLYS GALV	062							
7'0" HIGH												
3'0"	R/LHR	161		WH	058	643	6,237	12,217				
	L/RHR	161		WH	059							
	R/LHR	161	C	WH	068	670	6,499	12,730				
	L/RHR	161	C	WH	069							
	R/LHR	61L		WH	7617	643	6,237	12,217				
	L/RHR	61L		WH	7618							
	R/LHR	61L	C	WH	038	670	6,499	12,730				
	L/RHR	61L	C	WH	039							
	R/LHR	86ED	C	WH	082							
	L/RHR	86ED	C	WH	083							
	BLANK x BLANK C (Top and Bottom)								070	697	not available	
	R/LHR	161	C	POLYS GALV	090				776	7,527	14,744	
	L/RHR	161	C	POLYS GALV	091							
	R/LHR	86ED	C	POLYS GALV	084	710	6,887	13,490				
	L/RHR	86ED	C	POLYS GALV	085							
	R/LHR	INACTIVE	C ASA and FB		7619	704	6,829	13,376				
	L/RHR	INACTIVE	C ASA and FB		7620							
	R/LHR	RPD	C	WH	088	816	7,915	15,504				
	L/RHR	RPD	C	WH	089							
	3'6"	R/LHR	161	C	WH	064	880	8,536	16,720			
	L/RHR	161	C	WH	065							
	4'0"	R/LHR	161	C	WH	156	880	8,536	16,720			
		L/RHR	161	C	WH	157						
		R/LHR	86ED	C	WH	7630						
L/RHR		86ED	C	WH	7631							

SL18-SERIES FLUSH DOORS - SQUARE EDGES AND NON-HANDED

Width	Description				Part #	Unit Door \$	10 PAK \$	20 PAK \$
6'8" HIGH								
3'0"	R/L	161	C	WH	87150	643	6,237	not available
7'0" HIGH								
3'0"	R/L	161	C	WH	87300	658	6,383	not available
	R/L	86ED	C	WH	87310	658	6,383	

NOTES:

1. Inactive doors require astragal. Order astragals from Parts Section of this price book.
2. The nomenclature designation "C" indicates closer reinf.
3. 4'0" 20 PAK doors are shipped as two (2) 10 PAK skids.

Prices subject to change without notice.

SZ18-SERIES FLUSH DOORS - SQUARE EDGES AND NON-HANDED

Width	Description					Part #	20 PAK \$
6'8" HIGH							
3'0"	R/L	61L	C	WH	POLYS GALV	SZ001	8,561
	R/L	RPD	C	WH	POLYS GALV	SZ002	9,241
	R/L	86ED	C	WH	POLYS GALV	SZ003	8,561
	R/L	161	C	WH	POLYS GALV	SZ004	8,561
	R/L	61L	C	WH	HONEYCOMB CRS	SZ005	7,664
	R/L	RPD	C	WH	HONEYCOMB CRS	SZ006	8,234
	R/L	86ED	C	WH	HONEYCOMB CRS	SZ007	7,644
	R/L	161	C	WH	HONEYCOMB CRS	SZ008	7,644
7'0" HIGH							
3'0"	R/L	61L	C	WH	POLYS GALV	SZ010	8,853
	R/L	RPD	C	WH	POLYS GALV	SZ011	9,533
	R/L	86ED	C	WH	POLYS GALV	SZ012	8,853
	R/L	161	C	WH	POLYS GALV	SZ013	8,853
	R/L	61L	C	WH	HONEYCOMB CRS	SZ014	7,927
	R/L	RPD	C	WH	HONEYCOMB CRS	SZ015	8,607
	R/L	86ED	C	WH	HONEYCOMB CRS	SZ016	7,927
	R/L	161	C	WH	HONEYCOMB CRS	SZ017	7,927

NOTES:

1. The nomenclature designation "C" indicates closer reinf.
2. The nomenclature designation "WH" indicates 1-1/2 hour Mylar fire label.

Prices subject to change without notice.

WEST COAST SERVICE CENTER

AVAILABLE MODIFICATIONS TO STOCK FRAMES ONLY

FRAME MODS

STOCK

FRAME MOD PRICING See page 123 for stock frames available for modifications

Item		Each \$	Available Options & Notes
STANDARD CONSTRUCTION OPTIONS			
*Label (per jamb)	Remove and install new metal or mylar label	24	Metal: UL 3, 1-1/2, or 3/4 hour, 20 min; ITS/WHI 3, 1-1/2, or 3/4 hour, 20 min. Mylar: ITS/WHI 3 hr and 1-1/2 hr.
Welded 3-side frame	Face weld	74	
	Continuous weld	135	
Anchors (per anchor)	Existing Masonry -- Pierce & Dimple only	5	Standard Quantities: - Jamb thru 7'1" (4 per jamb) - Jamb over 7'1 thru 8'9" (5 per jamb)
	EMA **Hat anchor -- P&D, welded-in with bolts	22	
	EMA Tube & Strap -- P&D, welded-in with bolts	28	
	Stud Wall -- weld-in (typ 3 per jamb) 7	7	Jamb: Weld-in wood, Flush steel, Wood strap, Recessed Z, Compression jamb Base: Fixed base, Weld-in Wood stud base, L-shaped base
STANDARD HARDWARE OPTIONS			
Hinge preps	14 gauge Continuous hinge reinforcement	100	Available on blank jambs only
Strike preps	Deadlock strike prep 40	40	Non-lip, includes dust (mortar) box. CYL-48, CYL-60; ASA: Cat. #535: S43 (Corbin Russwin 424F83, Falcon "D" Series - P10018, Sargent 404 Schlage 10-055 Yale 541); S40 (Best 38HSI, Corbin Russwin 424F83, Sargent 405 Yale 30S); S27 (Best 38SHI, Corbin Russwin 381F94, Sargent 405, Yale 30S)
	RPD Rim Panic Strike prep	19	14ga, 44-9/16" top of reinforcement to bottom of frame
	SVRPD (Surface Vertical Rod) prep	19	14ga, welded to soffit of frame header
	Universal (reversible) Flush Bolt Strike prep	57	Only available on 6'0" heads. Includes mortar box.
Closers	RA (Regular arm), PA (Parallel arm), or Top Jamb	19	14ga. reinf.
	Overhead Stop and Holder	80	Glynn Johnson 100 series and ABH 1000 series only
Electric hardware preps	EPT frame prep	105	Von Duprin EPT2 and EPT10 only. Includes mortar box.
	Electric Hinges	54	Reinforcement supports all manufacturers/products
	Electric Strikes	70	Von Duprin (4211, 4212, 5100, 6210, 6211, 6400) Adams Rite (7100, 7128, 7140, 7170, 7240, 7270, 7440, 7400/7401, 7900) Dorma (ES84, ES72, ES86, ES-95, ES96F, ES-111-A, ES112-B) Folger Adams (112, 202, 502, 712, 712-75, 732) HES (732, 742-75, 1003 SERIES, 1006 SERIES, 4500, 5000-501, 5200-501, 7000-701, 7001, 7501, 8000/8300, 8500) RCI (F1114, F2164), Rofu (1702), Trine (4100)

NOTES:

- * Refer to TD Manual for all labeled approvals. The included WHI label must be relabeled if a different fire label is required or requested.
- ** Default anchor if no choice is specified

Prices subject to change without notice.

DOOR MOD PRICING See page 124 and 125 for stock frames available for modifications

Item	Each \$	Available on			Available Options & Notes	
		L	SL	SZ		
STANDARD CONSTRUCTION OPTIONS						
Glass Lights/ louvers (price per cutout)	Glass light/louwer cutout only	85	X	X	X	GS, NS, VS for lights and louvers. No trim available on mods. Specify DCS (door cutout size) and location.
	Glass light/louwer cutout with *channels	190	X	X	X	
	Full glass light cutout with *channels	245	X	X	X	FGS lights. No trim available on mods. Specify DCS and location.
	Door Viewer	25	X	X	X	
Door Edges	Filled Edge Seam	132	X	X		
Top or Bottom Caps	Screw-in	46	X	X	X	
	Sealed	158	X	X	X	
*Label (per leaf)	Remove and Install new metal label	49	X	X	X	Metal: UL 3, 1-1/2, 1, 3/4 hr, 20 min; ITS/WHI 3, 1-1/2, 1, 3/4 hr
STANDARD HARDWARE OPTIONS						
Locks - Primary	86ED lock function holes	67	X	X	X	Schlage L9010, L9040, L9050, L9070/L9080, L9453 only
**Locks - Secondary	Deadlock prep	71	X	X		161-48 only
Strikes - Secondary	Deadlock strike prep at 48" CL from frame bottom	67	X	X		Cat. #535: NA1, NA3 (w/ astragal) and NW1, NW3 (w/o astragal)
***Exit devices	Mortise or RIM exit device function holes	67	X	X		
Astragal Prep (price includes astragal)	Attached Z-astragal with ASA & FB	255	X	X	X	only available 12" from top and bottom to center FB
	Attached Flat bar astragal	171	X	X	X	Includes notching astragal for strike lip clearance
	Inactive leaf - Add ASA prep to stock 86ed	78	X	X	X	ANSI A115.1 & A115.2; CL 40-5/16" from frame bottom
	Inactive leaf - Add FB prep (top & bottom) to 86ed	172	X	X	X	
Electric hardware preps	EPT door prep	110	X	X		EPT2, EPT10 only. No raceways provided through mod stock.
	Electric hinge	25	X	X		Reinforcement supports all manufacturers/products

NOTES:

- * Refer to TD Manual for all labeled approvals. Standard 1.5 hr WHI labels must be replaced if requirements change based on modifications.
- ** One additional lock allowed per opening.
- *** Exit devices should mod an RPD door as the active leaf and an 86ED through bolted, if an inactive ASA strike is needed.
- Strike prep available as mod to 86ED stock doors for inactive leaf.
- Use RPD door for push/pull (blank lock side).
- Wide inactive not available for modified stock.
- Surface flushbolt reinforcement not available.

Prices subject to change without notice.

F16-SERIES JAMB COMPONENTS

Height	Description			5-3/4"		6-1/4"		7-3/4"		8-1/4"	
				Part #	List \$	Part #	List \$	Part #	List \$	Part #	List \$
JAMB COMPONENTS											
6'8"	SJ	R	ASA	292	78			713	82		
	SJ	R	BLK	7414	78						
	SJ	L	ASA	295	78			715	82		
	SJ	L	BLK	7415	78						
	HJ	R	WH	294	93			714	90		
	HJ	L	WH	297	93			716	90		
7'0"	SJ	R	ASA	302*	81	19048	91	717	91	802	97
	SJ	R	BLK	303	81						
	SJ	L	ASA	305*	81	19049	91	719	91	806	97
	SJ	L	BLK	306	81						
	EJ	R†						7449	85		
	EJ	L†						7450	85		
8'0"	HJ	R	WH	304*	96	19052	100	718	100	803	109
	HJ	L	WH	307*	96	19053	100	720	100	807	109
	HJ	R	WH	319	122						
	HJ	L	WH	321	122						
8'0"	SJ	R	ASA	318	94						
	SJ	L	ASA	320	94						

F16-SERIES HEAD COMPONENTS

Width	Description			5-3/4"		6-1/4"		7-3/4"		8-1/4"	
				Part #	List \$	Part #	List \$	Part #	List \$	Part #	List \$
HEAD COMPONENTS											
3'0"	HD			326*	36	19062	41	706	41	808	49
	HD	4" face		334	76						
3'6"	HD			328	49						
4'0"	HD			330	49						
6'0"	HD	D		333	82			19587	90		

K16-SERIES JAMBS AND HEAD

Height	Description			5-7/8"		8-1/4"	
				Part #	List \$	Part #	List \$
JAMB COMPONENTS							
6'8"	SJ	R	ASA	19156	79		
	SJ	L	ASA	19157	79		
	HJ	R	WH	19158	90		
	HJ	L	WH	19159	90		
7'0"	SJ	R	ASA	19160	88	19240	114
	SJ	L	ASA	19161	88	19241	114
	HJ	R	WH	19164	98	19242	120
	HJ	L	WH	19165	98	19243	120
Width	Description			5-7/8"		8-1/4"	
				Part #	List \$	Part #	List \$
HEAD COMPONENTS							
3'0"	HD			19174	40	19252	58
6'0"	HD	D		19177	79		

F16-SERIES JAMB AND HEAD KWIK-PAKS

Height	Description			5-3/4"	
				Part #	List \$
JAMBS - 2" FACE (55 PIECES PER PAK)					
7'0"	SJ	R	ASA	302	3,696
	SJ	L	ASA	305	3,696
	HJ	R	WH	304	4,455
	HJ	L	WH	307	4,455
Width	Description			5-3/4"	
				Part #	List \$
HEADS - 2" FACE (55 PIECES PER PAK)					
3'0"	HD			326	1,822

NOTES:

- † End Jambs (EJ R/L) handed same as Blank Hinge Jambs (HJ R/L BLK), and will be invoiced as Blank Strike Jambs.
- * Available as KWIK-PAK.
- Stock uses Steelcraft hinge and lock locations.

Prices subject to change without notice.

L18-SERIES FLUSH DOORS - BEVELED EDGES AND HANDED

Height	Description					Part #	Unit Door \$
6'8" HIGH							
3'0"	R/LHR	161	C	WH	HONEYCOMB / CRS	066	643
	L/RHR	161	C	WH	HONEYCOMB / CRS	067	643
	R/LHR	61L	C	WH	HONEYCOMB / CRS	036	643
	L/RHR	61L	C	WH	HONEYCOMB / CRS	037	643
	R/LHR	86ED	C	WH	HONEYCOMB / CRS	076	643
	L/RHR	86ED	C	WH	HONEYCOMB / CRS	077	643
	R/LHR	RPD	C	WH	HONEYCOMB / CRS	7602	677
L/RHR	RPD	C	WH	HONEYCOMB / CRS	7603	677	
7'0" HIGH							
3'0"	LHR	161	C	WH	POLYS / GALV	090	776
	L/RHR	161	C	WH	POLYS / GALV	091	776
	R/LHR	86ED	C	WH	POLYS / GALV	084	776
	L/RHR	86ED	C	WH	POLYS / GALV	085	776
	R/LHR	RPD	C	WH	POLYS / GALV	092	779
	L/RHR	RPD	C	WH	POLYS / GALV	093	779
	R/LHR	161	C	WH	HONEYCOMB / CRS	068	670
	L/RHR	161	C	WH	HONEYCOMB / CRS	069	670
	R/LHR	61L	C	WH	HONEYCOMB / CRS	038	670
	L/RHR	61L	C	WH	HONEYCOMB / CRS	039	670
	R/LHR	86ED	C	WH	HONEYCOMB / CRS	082	670
	L/RHR	86ED	C	WH	HONEYCOMB / CRS	083	670
	R/LHR	RPD	C	WH	HONEYCOMB / CRS	088	710
	L/RHR	RPD	C	WH	HONEYCOMB / CRS	089	710
R/LHR	INACTIVE	C ASA & FB		HONEYCOMB / CRS	7619	816	
L/RHR	INACTIVE	C ASA & FB		HONEYCOMB / CRS	7620	816	
3'6"	R/LHR	161	C	WH	HONEYCOMB / CRS	064	816
	L/RHR	161	C	WH	HONEYCOMB / CRS	065	816
	R/LHR	86ED	C	WH	HONEYCOMB / CRS	7626	816
	L/RHR	86ED	C	WH	HONEYCOMB / CRS	7627	816
	R/LHR	RPD	C	WH	HONEYCOMB / CRS	7622	850
	L/RHR	RPD	C	WH	HONEYCOMB / CRS	7623	850
4'0"	R/LHR	161	C	WH	HONEYCOMB / CRS	156	880
	L/RHR	161	C	WH	HONEYCOMB / CRS	157	880
	R/LHR	86ED	C	WH	HONEYCOMB / CRS	7630	880
	L/RHR	86ED	C	WH	HONEYCOMB / CRS	7631	880
	R/LHR	RPD	C	WH	HONEYCOMB / CRS	144	914
	L/RHR	RPD	C	WH	HONEYCOMB / CRS	145	914
8'0" HIGH							
3'0"	R/LHR	161	C		HONEYCOMB / CRS	7634	939
	L/RHR	161	C		HONEYCOMB / CRS	7635	939
	R/LHR	86ED	C		HONEYCOMB / CRS	7638	939
	L/RHR	86ED	C		HONEYCOMB / CRS	7639	939
	R/LHR	RPD	C		HONEYCOMB / CRS	7688	973
	L/RHR	RPD	C		HONEYCOMB / CRS	7689	973

NOTES:

1. Stock uses Steelcraft hinge and lock locations.

Prices subject to change without notice.

SL18-SERIES FLUSH DOORS - SQUARE EDGES AND NON-HANDED

Height	Description					Part #	Unit Door \$	10 PAK \$	20 PAK \$
6'8" HIGH									
3'0"	R/L	RPD	C	WH	HONEYCOMB / CRS	87148	677	n/a	n/a
	R/L	86ED	C	WH	HONEYCOMB / CRS	87170	643	n/a	n/a
	R/L	161	C	WH	HONEYCOMB / CRS	87150	643	n/a	n/a
7'0" HIGH									
3'0"	R/L	RPD	C	WH	HONEYCOMB / CRS	87102	692	n/a	n/a
	R/L	86ED	C	WH	HONEYCOMB / CRS	87310	658	n/a	n/a
	R/L	161	C	WH	HONEYCOMB / CRS	87300	658	n/a	n/a

SZ18-SERIES FLUSH DOORS - SQUARE EDGES AND NON-HANDED

Height	Description					Part #	Unit Door \$	10 PAK \$	20 PAK \$
6'8" HIGH									
3'0"	R/L	RPD	C	WH	POLYS / GALV	SZ002	483	n/a	9,241
	R/L	86ED	C	WH	POLYS / GALV	SZ003	449	n/a	8,561
	R/L	161	C	WH	POLYS / GALV	SZ004	449	n/a	8,561
	R/L	RPD	C	WH	HONEYCOMB / CRS	SZ006	435	n/a	8,324
	R/L	86ED	C	WH	HONEYCOMB / CRS	SZ007	401	n/a	7,644
	R/L	161	C	WH	HONEYCOMB / CRS	SZ008	401	n/a	7,644
7'0" HIGH									
3'0"	R/L	RPD	C	WH	POLYS / GALV	SZ011	499	n/a	9,533
	R/L	86ED	C	WH	POLYS / GALV	SZ012	465	n/a	8,853
	R/L	161	C	WH	POLYS / GALV	SZ013	465	n/a	8,853
	R/L	RPD	C	WH	HONEYCOMB / CRS	SZ015	450	n/a	8,607
	R/L	86ED	C	WH	HONEYCOMB / CRS	SZ016	416	n/a	7,927
	R/L	161	C	WH	HONEYCOMB / CRS	SZ017	416	n/a	7,927

NOTES:

1. Stock uses Steelcraft hinge and lock locations.

Prices subject to change without notice.

About Allegion

Allegion (NYSE: ALLE) creates peace of mind by pioneering safety and security. As a \$2 billion provider of security solutions for homes and businesses, Allegion employs more than 7,800 people and sells products in more than 120 countries across the world. Allegion comprises 23 global brands, including strategic brands CISA®, Interflex®, LCN®, Schlage® and Von Duprin®.

For more, visit www.allegion.com

aptiQ ■ LCN ■ **SCHLAGE** ■ STEELCRAFT ■ VON DUPRIN