

The Aluminum  
Hardware Authority



# 2017 PRICELIST

Effective Date: **February 1, 2017**

ASSA ABLOY, the global leader  
in door opening solutions



# 2017 Price List Adams Rite Architectural Hardware

## General Information

Table of Contents \_\_\_\_\_ 3-4

## Products

### DEADLOCKS

RT1050D RITE Touch@Digital Glass Door Lock \_\_\_\_\_ 5  
 1830 Bottom Rail Deadlock(Swingbolt) \_\_\_\_\_ 5  
 MS1837 Series MS® Two-Point Deadlock \_\_\_\_\_ 5  
 MS1847 Series MS® Deadlock/Deadlatch \_\_\_\_\_ 6  
 MS1850S, MS1850S-X5X Series MS® Deadlock \_\_\_\_\_ 6  
 MS1850S-X2X Series Short Throw Deadlock \_\_\_\_\_ 7  
 MS1850SN, MS1850SN-45X Series MS® Deadlock (ANSI Size) \_\_\_\_\_ 7  
 MS1861 Series MS® Bottom Rail Deadlock \_\_\_\_\_ 7  
 1875 Two-Point Deadlock \_\_\_\_\_ 8  
 MS+1890 Series MS® Deadlock/Deadlatch \_\_\_\_\_ 8  
 MS1950, MS1950-X5X Series MS® Deadlock \_\_\_\_\_ 9  
 2190, 2290 Dual Force® Interconnected Deadbolt/Deadlatch for Aluminum Stile Doors (2190); for Wood or Hollow Metal (2290) \_\_\_\_\_ 10  
 2331 Heavy Duty Deadbolt \_\_\_\_\_ 11  
 4070 Series Short Throw Deadbolt (Projection Style) \_\_\_\_\_ 11  
 4189, 4190 Flush Locksets (Including Deadlock) \_\_\_\_\_ 12  
 4430, 4431 Flush Locksets (Including Deadlock) \_\_\_\_\_ 12  
 5017 Wood Door Deadlock/Deadlatch \_\_\_\_\_ 13  
 5055 Wood Door Deadlock for Sliding Doors \_\_\_\_\_ 13

### DEADLATCHES

4300 Steel Hawk® Electrified Deadlatch (eLatch) \_\_\_\_\_ 13  
 4300 RITE Pack® \_\_\_\_\_ 14  
 4510 Standard Duty Deadlatch \_\_\_\_\_ 14  
 4530 Standard Duty Deadlatch \_\_\_\_\_ 15  
 4781 Two-Point Deadlatch with Paddle \_\_\_\_\_ 15  
 4900 Heavy Duty Deadlatch \_\_\_\_\_ 16  
 4920AN Heavy Duty Deadlatch (ANSI Size) \_\_\_\_\_ 16

### FLUSHBOLTS & PIVOTS

1870 Cylinder-Operated Flushbolt \_\_\_\_\_ 17  
 1870HM Cylinder-Operated Flushbolt \_\_\_\_\_ 17  
 1877 Cylinder-Operated Flushbolt \_\_\_\_\_ 18  
 MS1880, MS1881 Two-Point Flushbolts \_\_\_\_\_ 18  
 MS2180 Auto-Release Two-Point Flushbolt \_\_\_\_\_ 18  
 B1921, B1923 Reinforcing Pivots \_\_\_\_\_ 19

### EXIT DEVICES

8099 Dummy Pushbar \_\_\_\_\_ 19  
 3100, 8100 Surface Vertical Rod Exit Device \_\_\_\_\_ 20  
 8200 Narrow Stile Surface Vertical Rod Exit Device \_\_\_\_\_ 20  
 3300, 8300 Mortise Exit Device \_\_\_\_\_ 21  
 8400 Narrow Stile Mortise Exit Device \_\_\_\_\_ 22  
 3600, 8500 Metal Door Concealed Vertical Rod Exit Device \_\_\_\_\_ 23  
 8600 Narrow Stile Concealed Vertical Rod Exit Device \_\_\_\_\_ 23  
 3700, 8700 Rim Exit Device \_\_\_\_\_ 24  
 8800 Narrow Stile Rim Exit Device \_\_\_\_\_ 24  
 3900, 8900 Wood Door Concealed Vertical Rod Exit Device \_\_\_\_\_ 25  
 Accessories for Exit Devices \_\_\_\_\_ 25  
 Kitted Options for Exit Devices \_\_\_\_\_ 26  
 Modification Options for Exit Devices \_\_\_\_\_ 26

### ELECTRIC STRIKES

7100, 7101 Electric Strikes \_\_\_\_\_ 26  
 7110, 7111 Electric Strikes \_\_\_\_\_ 27  
 7130, 7131 Electric Strikes \_\_\_\_\_ 27  
 7140 Electric Strike \_\_\_\_\_ 27  
 7160 Electric Strike \_\_\_\_\_ 28  
 7170 Electric Strike \_\_\_\_\_ 28  
 7100 Series Electric Strikes Components \_\_\_\_\_ 29  
 7240 Fire-Rated Electric Strike \_\_\_\_\_ 29  
 7270 Fire-Rated Electric Strike \_\_\_\_\_ 30  
 7400, 7401 Ultraline Electric Strikes \_\_\_\_\_ 30  
 7410, 7411 Ultraline Electric Strikes \_\_\_\_\_ 31  
 7430, 7431 Ultraline Electric Strikes \_\_\_\_\_ 31  
 7440 Ultraline Electric Strikes \_\_\_\_\_ 31  
 74R1 Ultraline Electric Strikes \_\_\_\_\_ 32  
 74R2 Ultraline Electric Strikes \_\_\_\_\_ 32  
 7400 Series Electric Strikes Components \_\_\_\_\_ 33

**TRIM**

1000 Series Turns	34
3000 Fixed Pull	34
3080 Series Entry Trim	35
3090, 3090P/C eForce® Keyless Entry	36
A100-3090H Keyless Entry and Aperio® Hub Wholesale Kit	36
4060 Turn	37
4550 MS® Deadlock Lever	37
4560, 4565 Series Deadlatch Handles for 4300, 4500, 4900 Deadlatches	37
4560-010, 4565-010 Series Deadlatch Handles for MS+1890 Deadlock/Deadlatch	38
4568, 4569 Eurostyle Deadlatch Handles 4300, 4500, 4900 Deadlatches	38
4568-010, 4569-010 Series Deadlatch Handles for MS+1890 Deadlock/Deadlatch	39
4590 Deadlatch Paddle for 4300, 4500, 4900 Deadlatches	40
4590-1X Deadlatch Paddle for MS+1890, 2190 Deadlocks	40
4591 Deadlatch Paddle for 4300, 4500, 4900 Deadlatches	41
4591-1X Deadlatch Paddle for MS+1890, 2190 Deadlocks	41
4600 Heavy Duty Designer Deadlatch Handles	42

**CYLINDERS**

4024, 4025, 4029 Cylinder Pulls	43
4036 Mortise Cylinder	43
MS4043 Cylinder Guard	44
4066 Thumbturn	44
4580 Cam Disc	44
4581 Universal Cam Disc	45
8650 Cylinder Escutcheon Kit	45
8736 Rim Cylinder	45

**ACCESSORIES**

4014 Two-Point Conversion Kit	45
4015 Threshold Bolt	45
4016 Header Bolt	46
4085 Header Bolt (Pairs of Doors Only)	46
4089 Exit Indicator	46
4104 Mounting Bridges	47
91-0965 Universal Mounting Tab Kits for Installing MS® Locks & Latches	47

**STRIKES**

2190 Dual Force® Interconnected Deadbolt/Deadlatch Strikes	47
2290 Dual Force® Interconnected Deadbolt/Deadlatch Strikes	47
4000 Series MS® Deadlock Strikes	48
4800, MS 4804 Series Strikes	48
4901, 4902 Deadlatch Strikes	49
4304 Deadlatch Strike	49

**THICK DOOR KITS**

2190, 2290 Dual Force® Interconnected Deadbolt/Deadlatch Thick Door Kit	49
4568, 4569 Eurostyle Deadlatch Handles Thick Door Kits	50

**FACEPLATES**

MS1850S Deadlocks Faceplates	50
------------------------------	----

MS1850S, MS1950 Deadlock (Standard Bolt) Faceplates	50
MS1850S, MS1950 Deadlock (Hookbolt and Short Bolt) Faceplates	51
MS1850SN Deadlock (Standard Bolt) Faceplates	51
MS1850SN Deadlock (Hookbolt) Faceplates	51
1870 Flushbolt Faceplates	51
MS+1890 Deadlock Faceplates	52
2190 Dual Force® Interconnected Deadbolt/Deadlatch Faceplates	52
2331 Heavy Duty Deadbolt Faceplates	52
3300 Fire-Rated Mortise Exit Device Faceplates	52
4070 Short Throw Deadbolt Faceplates	52
4500 Standard Duty Deadlatch Faceplates	52
4530 Standard Duty Deadlatch Faceplates	53
4900 Heavy Duty Deadlatch Faceplates	53
4900 Heavy Duty Deadlatch Special Faceplates	53
4920, 8300 Faceplates	53
7100, 7160 Electric Strikes Faceplates	53
7101 Electric Strike Faceplates	53
7110 Electric Strike Faceplates	53
7111 Electric Strike Faceplates	53
7130 Electric Strike Faceplates	54
7131 Electric Strike Faceplates	54
7140, 7170 Electric Strike Faceplates	54

**POWER**

PS-1 Power Supply	54
PS-LR Power Supply	54
PS-SE Power Supply	54
4603, 4605, 4606 Transformer/Rectifier/Plezo Horn	55
4612 Power Transfer Device	55

**DEMO MOUNTS****DEADLOCKS & DEADLATCHES**

RT1050 RITE Touch® Digital Glass Door Lock	56
2190 Dual Force® Interconnected Deadbolt/Deadlatch	56
4300 Steel Hawk® Electrified Deadlatch (eLatch)	56

**ELECTRIC STRIKES**

7400 Ultraline Electric Strikes	56
---------------------------------	----

**EXIT DEVICES**

8400 Narrow Stile Mortise Exit Device	56
---------------------------------------	----

**TRIM**

3090, 3090P/C eForce® Keyless Entry	57
A100-3090H Keyless Entry and Aperio® Hub Wholesale Kit	57
4600 Heavy Duty Designer Deadlatch Handles	57

**General Information**

Adams Rite Limited Warranty/Terms and Conditions	58
--	----

**DEADLOCKS**

**RT1050D**

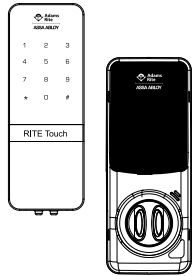

**RITE Touch® Digital Glass Door Lock**

MODELS	
<b>RT1050D</b> Digital glass door lock with thumbturn for single or double doors	\$612.00
<b>RT1050L</b> Digital glass door lock with lever, for single or double doors	\$612.00
<b>RT-5C-1050</b> Extra cards (package of 5 cards)	\$60.00

HOW TO ORDER Specify quantity and the following information.			
RITE TOUCH	MODEL	TRIM	
<b>RT</b>	<b>1050</b>	<b>D</b>	
	<b>1050</b> For single or double doors	<b>D</b> Thumbturn	
		<b>L</b> Accessibility lever	

**1830**

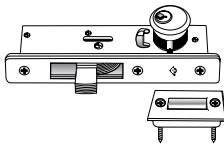

**Bottom Rail Deadlock (Swingbolt)**

MODEL & FINISHES	313, 628
<b>1830</b> Deadlock with 31/32", or 1-1/8" cylinder height	\$136.00

HOW TO ORDER Specify quantity and the following information. Order related products separately.		
PRODUCT NO.	DASH NO. (SPECIFY FOR CYLINDER HEIGHT AND LOCK DEPTH)	FINISH
<b>1830</b>	<b>-02</b>	<b>-628</b>
	<b>02</b> Cylinder Height 31/32" Dim. "A" 1-5/8"	<b>628</b> Clear Anodized
	<b>03</b> Cylinder Height 1-1/8" Dim. "A" 1-25/32"	<b>313</b> Dark Bronze Anodized

**MS1837**

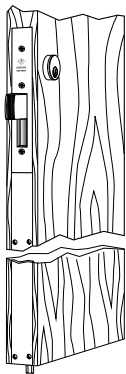

**Series MS® Two-Point Deadlock**

MODELS & FINISHES	313, 335, 628	605, 626
<b>MS1837</b> Deadlock includes 4001-011 strike, 36" cylinder height	\$240.00	\$325.00
<b>MS1837</b> Deadlock includes 4001-011 strike, contact factory for cylinder height other than 36" up to maximum cylinder height 65"	\$295.00	\$380.00

HOW TO ORDER Specify quantity and the following information. Order related products separately.			
PRODUCT NO.	FINISH		
<b>MS1837</b>	<b>-313</b>		
	<b>313</b> Dark Bronze Anodized	<b>626</b> Satin Chrome	
	<b>335</b> Black Anodized	<b>628</b> Clear Anodized	
	<b>605</b> Bright Brass		

If cylinder height other than 36" is required, specify exact height from bottom of door to cylinder center. Maximum cylinder height 65".



## MS1847

## Series MS® Deadlock/Deadlatch

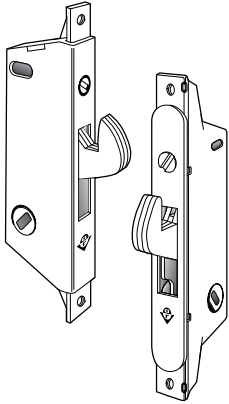
MODEL & FINISH	630
MS1847 Deadlock/deadlatch, stainless steel	\$59.00

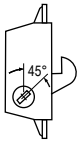
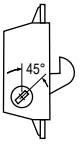
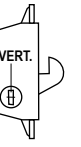
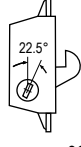
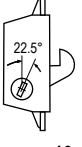

**HOW TO ORDER** Specify quantity and the following information. Order related products separately.

PRODUCT NO.	FACE SHAPE, HUB ANGLE, LOCK OR LATCH	FINISH
<b>MS1847</b>	<b>-02</b>	<b>-630</b>
	(See Configuration table below)	630 Satin Stainless
	 (Blank)  -02  -06  -09  -10  -11  -13	

MS1850S,  
MS1850S-X5X

## Series MS® Deadlock

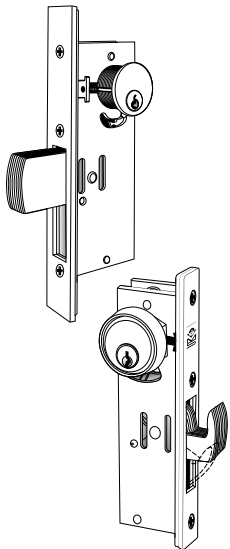

MODELS & BACKSETS	7/8"	31/32", 1-1/8", OR 1-1/2"
MS1850S Flat faceplate, 313, 335, or 628 finish, without strike plate	\$81.00	\$69.00
MS1851S Radius faceplate, 313, 335, or 628 finish, without strike plate	\$81.00	\$69.00
MS1851SW Radius faceplate with weatherstrip, 313, 335, or 628 finish, without strike plate	\$86.00	\$74.00
MS1852S Bevel faceplate, any handing, 313, 335, or 628 finish, without strike plate	\$81.00	\$69.00
SPECIAL MODEL	7/8"	31/32", 1-1/8", OR 1-1/2"
MS1853S-XXX-IB Without faceplate, without strike plate	\$74.00	\$62.00

Schoolhouse function for above deadlocks add \$36. Please contact factory for more information.

**HOW TO ORDER** Specify quantity and the following information. Order related products separately.

PRODUCT NO.	FACEPLATE	BACKSET	BOLT SHAPE	HANDING	FINISH
<b>MS185</b>	<b>0S</b>	<b>-2</b>	<b>1</b>	<b>0</b>	<b>-628</b>
	0S Flat	1 7/8"	1 Straight	5 LH or RHR	313 Dark Bronze Anodized
	1S Radius	2 31/32"	5 Hookbolt	6 RH or LHR	335 Black Anodized
	1SW Radius with weatherstrip	3 1-1/8"		0 Non-Handed*	628 Clear Anodized
	2S Bevel	4 1-1/2"			

\*Any flat or radius faceplate, except Schoolhouse.

1850S-X2X

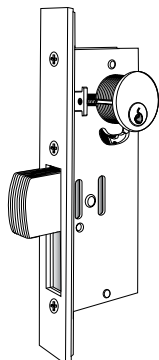

Series Short Throw Deadlock

MODELS & FINISHES		313, 628
<b>1850S</b> Flat faceplate, 31/32", 1-1/8", or 1-1/2" backset, without strike plate		\$69.00
<b>1851S</b> Radius faceplate, 313, 335, or 628 finish, without strike plate		\$69.00
<b>1852S</b> Bevel faceplate, any handing, 313, 335, or 628 finish, without strike plate		\$69.00
SPECIAL MODEL		
<b>1853S-X20-IB</b> Without faceplate, without strike plate		\$62.00

HOW TO ORDER Specify quantity and the following information. Order related products separately.					
PRODUCT NO.	FACEPLATE	BACKSET	BOLT SHAPE	HANDING	FINISH
<b>185</b>	<b>0S</b>	<b>2</b>	<b>-2</b>	<b>0</b>	<b>-628</b>
	<b>0S</b> Flat	<b>2</b> 31/32"	<b>2</b> Short Throw	<b>5</b> LH or RHR	<b>313</b> Dark Bronze Anodized
	<b>1S</b> Radius	<b>3</b> 1-1/8"		<b>6</b> RH or LHR	<b>628</b> Clear Anodized
	<b>2S</b> Bevel	<b>4</b> 1-1/2"		<b>0</b> Non-Handed*	

\*Any flat or radius faceplate.

MS1850SN,  
MS1850SN-45X

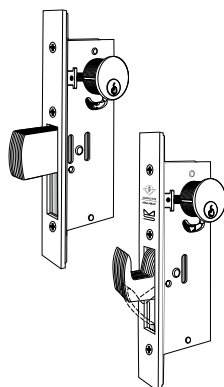

Series MS® Deadlock (ANSI Size)

MODELS		313, 335, 628
<b>MS1850SN</b> Flat faceplate, 1-1/2" backset, without strike plate		\$97.00
<b>MS1851SN</b> Radius faceplate, 1-1/2" backset, without strike plate		\$97.00
<b>MS1852SN</b> Bevel faceplate, any handing, 1-1/2" backset, without strike plate		\$97.00

HOW TO ORDER Specify quantity and the following information. Order related products separately.					
PRODUCT NO.	FACEPLATE	ANSI SIZE	BOLT SHAPE	HANDING	FINISH
<b>MS185</b>	<b>0</b>	<b>SN</b>	<b>-41</b>	<b>0</b>	<b>-628</b>
	<b>0</b> Flat		<b>41</b> Straight	<b>5</b> LH or RHR	<b>313</b> Dark Bronze Anodized
	<b>1</b> Radius		<b>45</b> Hookbolt	<b>6</b> RH or LHR	<b>335</b> Black Anodized
	<b>2</b> Bevel			<b>0</b> Non-Handed*	<b>628</b> Clear Anodized

\*Any flat or radius faceplate, except schoolhouse.

MS1861

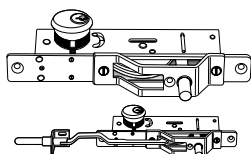

Series MS® Bottom Rail Deadlock

MODELS & FINISH		603
<b>MS1861-01</b> One-point deadlock, vertical bolt operation only		\$142.00
<b>MS1861-02</b> Two-point deadlock, horizontal and vertical operation		\$179.00

HOW TO ORDER Specify quantity and the following information. Order related products separately.			
PRODUCT NO.	BOLT OPERATION	FINISH	PACKAGING
<b>MS1861</b>	<b>-01</b>	<b>-603</b>	<b>-IB</b>
	<b>01</b> Vertical Bolt Only	<b>603</b> Zinc plated steel	<b>IB</b> Individually Boxed
	<b>02</b> Vertical and Horizontal Bolts		

If tube spacers are required, please specify quantity and length.

## 1875

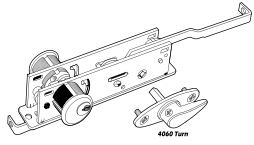

## Two Point Deadlock

MODEL & FINISH	603
1875 Two-point deadlock for roll-up doors	\$175.00

**HOW TO ORDER** Specify quantity and the following information. Order related products separately.

PRODUCT NO.	PACKAGING
1875	-IB
	IB Individually Boxed

## MS+1890

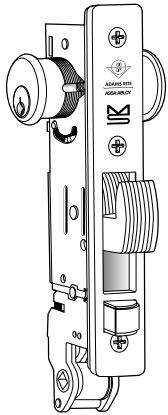

## Series MS® Deadlock/Deadlatch

MODELS & FINISHES	313, 335, 628
MS+1890 Flat faceplate, 31/32", 1-1/8", or 1-1/2" backset	\$238.00
MS+1891 Radius faceplate, 31/32", 1-1/8", or 1-1/2" backset	\$238.00
MS+1891W Radius faceplate with weatherstrip, 31/32", 1-1/8", or 1-1/2" backset	\$248.00
MS+1892 Bevel faceplate, any handing, 31/32", 1-1/8", or 1-1/2" backset	\$238.00
SPECIAL MODELS	
MS+1890, MS+1891, MS+1892 Flat, radius, or bevel faceplate, complete with flat / center hung 4" or 4-1/2" strike plate	\$250.00
MS+1893-XX-IB Without faceplate, without strike plate	\$184.00

**HOW TO ORDER** Specify quantity and the following information. Order related products separately.

PRODUCT NO.	FACEPLATE	BACKSET	STRIKE SHAPE/LIP LENGTH	HANDING	FINISH
MS+189	1	-3	02	6	-628
	0 Flat	2 31/32"	01 Flat/Standard Jamb	5 LH or RHR	313 Dark Bronze Anodized
	1 Radius	3 1-1/8"	02 Radius/Standard Stile	6 RH or LHR	335 Black Anodized
	1W Radius with weatherstrip	4 1-1/2"	17 Flat/Center Hung 4" Jamb		628 Clear Anodized
	2 Bevel		21 Flat/Center Hung 4-1/2" Jamb		

For door thickness other than 1-3/4", please contact factory.



**MS1950,  
MS1950-X5X**

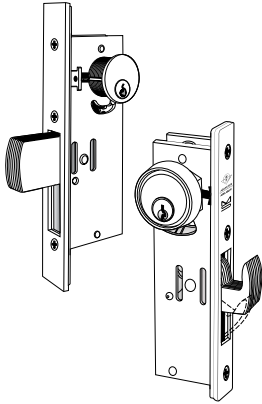

**Series MS® Deadlock**

<b>MODELS</b>		<b>313, 335, 628</b>
<b>MS1950</b>	Flat faceplate, 31/32", 1-1/8", or 1-1/2" backset, without strike plate	\$126.00
<b>MS1951</b>	Radius faceplate, 31/32", 1-1/8", or 1-1/2" backset, without strike plate	\$126.00
<b>MS1951W</b>	Radius faceplate with weatherstrip, 31/32", 1-1/8", or 1-1/2" backset, without strike plate	\$131.00
<b>MS1952</b>	Bevel faceplate, any handing, 31/32", 1-1/8", or 1-1/2" backset, without strike plate	\$126.00
<b>SPECIAL MODEL</b>		
<b>MS1953S-XXX-IB</b>	Without faceplate, without strike plate	\$119.00

Schoolhouse function for above deadlocks add \$36. Please contact factory for more information.

<b>HOW TO ORDER</b> Specify quantity and the following information. Order related products separately.					
PRODUCT NO.	FACEPLATE	BACKSET	BOLT SHAPE	HANDING	FINISH
<b>MS195</b>	<b>0</b>	<b>-2</b>	<b>1</b>	<b>0</b>	<b>-628</b>
	<b>0</b> Flat	<b>2</b> 31/32"	<b>1</b> Straight	<b>5</b> LH or RHR	<b>313</b> Dark Bronze Anodized
	<b>1</b> Radius	<b>3</b> 1-1/8"	<b>5</b> Hookbolt	<b>6</b> RH or LHR	<b>335</b> Black Anodized
	<b>1W</b> Radius with weatherstrip	<b>4</b> 1-1/2"		<b>0</b> Non-Handed*	<b>628</b> Clear Anodized
	<b>2</b> Bevel				

\*Any flat or radius faceplate except schoolhouse.

**2190, 2290**

**Dual Force® Interconnected Deadbolt/Deadlatch for Aluminum Stile Doors (2190); for Wood or Hollow Metal (2290)**

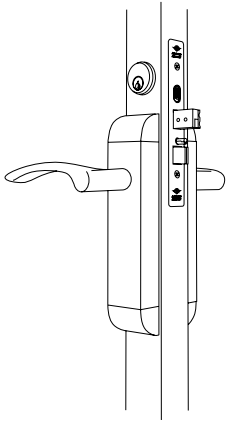

		STANDARD TRIM SET		ELECTRIFIED TRIM SET		LOW PROFILE TRIM		
MODELS & TRIM SETS		10B, US4, US32D	US3, US32	10B, US4, US32D	US3, US32	10B, US4, US32D	US3, US32	
<b>STANDARD LEVER</b>	<b>2190, 2290</b> Deadbolt/Deadlatch with standard lever (01, 02, 03), complete with strike plate	\$605.00	\$685.00	\$765.00	\$845.00	\$530.00	\$610.00	
	<b>2190</b> Deadbolt/Deadlatch with standard lever (01, 02, 03), complete with flat/center hung 4" or 4-1/2" strike plate	\$620.00	\$700.00	\$780.00	\$860.00	\$545.00	\$625.00	
	<b>2190, 2290</b> Deadbolt/Deadlatch with standard lever (01, 02, 03), without strike plate	\$580.00	\$660.00	\$740.00	\$820.00	\$505.00	\$585.00	
	<b>2190, 2290</b> Deadbolt/Deadlatch with designer lever series (MD through MW), complete with strike plate	\$650.00	\$730.00	\$810.00	\$890.00	\$575.00	\$655.00	
	<b>2190</b> Deadbolt/Deadlatch with with designer lever series (MD through MW), complete with flat/center hung 4" or 4-1/2" strike plate	\$665.00	\$745.00	\$825.00	\$905.00	\$590.00	\$670.00	
	<b>2190, 2290</b> Deadbolt/Deadlatch with designer lever series (MD through MW), without strike plate	\$625.00	\$705.00	\$785.00	\$865.00	\$550.00	\$630.00	
<b>MODELS &amp; FINISHES</b>		313, 335, 628					N/A	
<b>2190, 2290 BOXED LOCK</b> Less lever trim, with adjustable faceplate and choice of standard or radius strike							\$280.00	
<b>EK-2190</b> Electrification Kit for 2190, 2290; 12/24 VAC/VDC (not compatible with low profile trim)							\$164.00	

**HOW TO ORDER** Specify quantity and the following information. Order related products separately.

PRODUCT NO.	BACKSET	STRIKE	FACEPLATE FINISH	TRIM	HANDLE DESIGNATION	TRIM AND HANDLE FINISH	
<b>2190</b>	<b>-3</b>	<b>1</b>	<b>1</b>	<b>-1</b>	<b>01</b>	<b>32D</b>	
	3 1-1/8"	0 None	1 Clear Anodized 628	0 None	00 No Handle	03 Bright Brass (US3)	
	4 1-1/2"	1 Standard Flat	2 Dark Bronze Anodized 313	1 With Trim Set	<b>STANDARD SERIES:</b>	04 Satin Brass (US4)	
		2 Radius Strike	3 Black Anodized 335	2 With Electrified Trim Set		01 Curve	10B Dark Bronze (US10B)
		3 Flat/Center Hung 4"		3 Low Profile Trim		02 Round	32 Bright Stainless (US32)
		4 Flat/Center Hung 4-1/2"				03 Square	32D Satin Stainless (US32D)
					<b>DESIGNER SERIES:</b>		
					MD MG MJ MV (Handed)		
					ME MI MN (Handed) MW		

Trim options 1 and 2 are for outswinging doors only.

**HOW TO ORDER** Specify quantity and the following information. Order related products separately.

PRODUCT NO.	BACKSET	STRIKE	FACEPLATE FINISH	TRIM	HANDLE DESIGNATION	TRIM AND HANDLE FINISH	
<b>2290</b>	<b>-3</b>	<b>1</b>	<b>1</b>	<b>-1</b>	<b>01</b>	<b>32D</b>	
	3 1-1/8"	0 None	0 US to match trim finish	0 None	00 No Handle	03 Bright Brass (US3)	
	4 1-1/2"	1 Standard Flat	1 Clear Anodized 628	1 With Trim Set	<b>STANDARD SERIES:</b>	04 Satin Brass (US4)	
			2 Dark Bronze Anodized 313	2 With Electrified Trim Set		01 Curve	10B Dark Bronze (US10B)
			3 Black Anodized 335	3 Low Profile Trim		02 Round	32 Bright Stainless (US32)
					03 Square	32D Satin Stainless (US32D)	
					<b>DESIGNER SERIES:</b>		
					MD MG MJ MV (Handed)		
					ME MI MN (Handed) MW		

**2331**

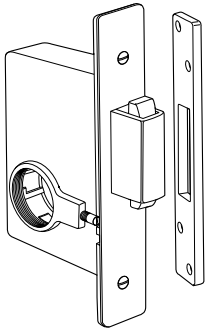

**Heavy Duty Deadbolt**

MODEL & FINISHES	121, 626	605, 625
2331 Deadbolt, 1-3/4" backset, complete with strike	\$298.00	\$325.00

**HOW TO ORDER** Specify quantity and the following information. Order related products separately.

PRODUCT NO.	FINISH
<b>2331</b>	<b>-626</b>
	121 To Match Dark Bronze Anodized 313
	605 Bright Brass
	625 Bright Chrome
	626 Satin Chrome

**4070**

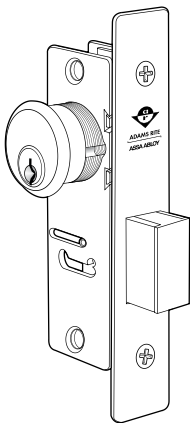

**Series Short Throw Deadbolt (Projection Style)**

MODELS & FINISHES	313, 335, 628
4070 Flat faceplate, 7/8", 31/32", or 1-1/8" backset, without strike plate	\$164.00
4071 Radius faceplate, 7/8", 31/32", or 1-1/8" backset, without strike plate	\$164.00
4072 Bevel faceplate, any handing, 7/8", 31/32", or 1-1/8" backset, without strike plate	\$164.00
SPECIAL MODEL	
4073-XX-IB Without faceplate, without strike plate	\$155.00

**HOW TO ORDER** Specify quantity and the following information. Order related products separately.

PRODUCT NO.	FACEPLATE	BACKSET	HANDING	FINISH
<b>407</b>	<b>2</b>	<b>-2</b>	<b>6</b>	<b>-628</b>
	0 Flat	1 7/8"	5 LH or RHR	313 Dark Bronze Anodized
	1 Radius	2 31/32"	6 RH or LHR	335 Black Anodized
	2 Bevel	3 1-1/8"	0 Non-Handed*	628 Clear Anodized

\*Any flat or radius faceplate.

**4189, 4190**

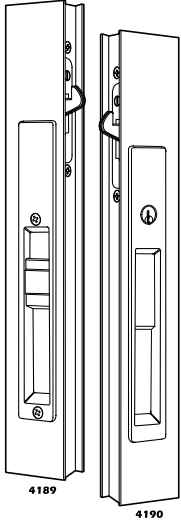

**Flush Locksets (Including Deadlock)**

MODELS & FINISHES	STANDARD LOCK FACE	STAINLESS STEEL LOCK FACE
<b>4189-IB</b> Flush lockset, 119, 121, or 130 finish, individually boxed	\$95.00	\$103.00
<b>4190-IB</b> Flush lockset, 119, 121, or 130 finish, individually boxed with cylinder	\$125.00	\$133.00
<b>4195-IB</b> Dummy flushset, 119, 121, or 130 finish, individually boxed	\$65.00	\$73.00
SPECIAL MODEL		
<b>4189-00</b> Flush operator without lock	\$75.00	
<b>4190-00</b> Flush operator without lock	\$105.00	

**HOW TO ORDER** Specify quantity and the following information. Order related products separately.

PRODUCT NO.	LOCKSET EXTERIOR	LOCK FACE	STILE THICKNESS	FINISH	KEYING OPTIONS	PACKAGING
<b>41</b>	<b>90</b>	<b>-09</b>	<b>-01</b>	<b>-130</b>	<b>-01</b>	<b>IB</b>
	89 Without Cylinder	00 Without Lock	01 1" to 1-3/8"	130 To match Clear Anodized 628	00 Without Cylinder	IB Individually Boxed
	90 With Cylinder	09 Radius	02 1-7/16" to 1-5/8"	121 To match Dark Bronze Anodized 313	01 Keyed Different	
	95 Dummy	09S Radius Stainless Steel	03 1-11/16" to 2"	119 To match Black Anodized 335	02 Keyed alike in pairs	
		10 Square				
		10S Square Stainless Steel				

Keyed alike 50 are available by special order in quantity of 50 locksets only. Please contact factory for ordering information.

**4430, 4431**

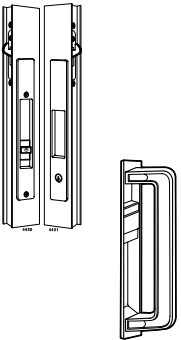

**Flush Locksets (Including Deadlock)**

MODELS & FINISH	STANDARD LOCK FACE	STAINLESS STEEL LOCK FACE
<b>4430-IB</b> ABS flush lockset, individually boxed	\$66.00	\$74.00
<b>4431-IB</b> ABS flush lockset with cylinder, individually boxed	\$100.00	\$108.00
<b>4432-IB</b> ABS dummy flushset, individually boxed	\$30.00	\$38.00
SPECIAL MODEL		
<b>4430-00</b> ABS operator without lock	\$46.00	
<b>4431-00</b> ABS operator without lock	\$80.00	

**Kitted Options**

MODELS & FINISHES	GRAY	335
<b>4413-01, 4413-02</b> Grip pull for use with 4189, 4190	\$22.00	
<b>4453-02-335-IB</b> Grip pull for use with 4430, 4431		\$35.00

**HOW TO ORDER** Specify quantity and the following information. Order related products separately.

PRODUCT NO.	LOCKSET EXTERIOR	LOCK FACE	STILE THICKNESS	KEYING OPTIONS	PACKAGING
<b>44</b>	<b>31</b>	<b>-09</b>	<b>-05</b>	<b>-01</b>	<b>-IB</b>
	30 Without Cylinder	00 Without Lock	00 1" to 1-5/16"	00 Without Cylinder	IB Individually Boxed
	31 With Cylinder	09 Radius	05 1-3/8" to 1-5/8"	01 Keyed Different	
	32 Dummy	09S Radius Stainless Steel	08 1-3/4" to 2"	02 Keyed alike in pairs	
		10 Square			
		10S Square Stainless Steel			

Keyed alike 50 are available by special order in quantity of 50 locksets only. Please contact factory for ordering information.

**5017**

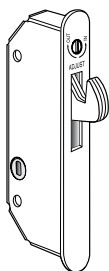

**Wood Door Deadlock/Deadlatch**

MODELS & FINISH		630
5017-00 Standard stainless steel deadlock		\$59.00
5017-02 Self-latching deadlock/deadlatch		\$59.00

**HOW TO ORDER** Specify quantity and the following information. Order related products separately.

PRODUCT NO.	LATCH CONFIGURATION
<b>5017</b>	<b>-00</b>
	00 Standard
	02 Self Latching

**5500**

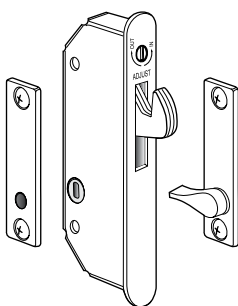

**Wood Door Deadlock for Sliding Doors**

MODELS		119, 626
5500-20 Lockset, strike, and trim included for 1-1/4", sliding wood doors		\$124.00

**HOW TO ORDER** Specify quantity and the following information. Order related products separately.

PRODUCT NO.	DOOR THICKNESS	FINISH
<b>5500</b>	<b>-20</b>	<b>-626</b>
	20 1-1/4" Thick	626 Satin Chrome
		119 to match Black Anodized 335

**DEADLATCHES**

**4300**

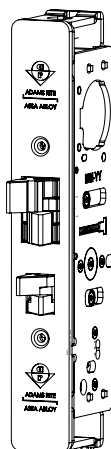

**Steel Hawk® Electrified Deadlatch (eLatch)**

MODELS & FINISHES		313, 335, 628
4300 Electrified deadlatch 31/32", 1-1/8", or 1-1/2" backset		\$413.00
4300M Monitored option, 31/32", 1-1/8", or 1-1/2" backset		\$473.00

SPECIAL MODELS		313, 335, 628
4300 Electrified deadlatch complete with flat / center hung 4" or 4-1/2" strike plate		\$433.00
4300M Electrified deadlatch with monitored option, complete with flat / center hung 4" or 4-1/2" strike plate		\$493.00

**HOW TO ORDER** Specify quantity and the following information. Order related products separately.

PRODUCT NO.	BACKSET	MONITORING	STRIKE	STIRKE SHAPE/LIP LENGTH	FACEPLATE FINISH
<b>4300</b>	<b>-3</b>	<b>M</b>	<b>-2</b>	<b>01</b>	<b>-628</b>
	2 31/32"	0 None	1 Surface Mount (4304)	01 Flat/Standard Jamb	313 Dark Bronze Anodized
	3 1-1/8"	M Monitored	2 Mortised (4901) 4-5/8"	02 Radius/Standard Stiles**	335 Black Anodized
	4 1-1/2"			17 Flat/Center Hung 4" Jamb**	628 Clear Anodized
				21 Flat/Center Hung 4-1/2" Jamb**	

\*\* See ACCESSORIES for available 4901 strike options.



P 800.872.3267 • F 800.232.7329  
 E orders.adamsrite@assaabloy.com  
 10027 S. 51st Street, Ste 102  
 Phoenix, Arizona 85044  
 www.adamsrite.com

**4300**

**RITE Pack®**

MODELS					313 & 628
<b>4300-20</b> 31/32" backset, flat and radius, 313 and 628 finish faceplates, surface mount or mortise strike					\$428.00
<b>4300-30</b> 1-1/8" backset, flat and radius, 313 and 628 finish faceplates, surface mount or mortise strike					\$428.00

HOW TO ORDER Specify quantity and the following information. Order related products separately.					
PRODUCT NO.	BACKSET	MONITORING	STRIKE	RITE PACK	
<b>4300</b>	<b>-3</b>	<b>0</b>	<b>-1</b>	<b>RP</b>	
	<b>2</b> 31/32"	<b>0</b> None	<b>1</b> Surface Mount (4304)		
	<b>3</b> 1-1/8"		<b>2</b> Mortised (4901) 4-5/8"		

**4510**

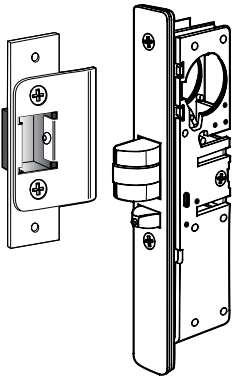

**Standard Duty Deadlatch**

MODELS & FINISHES		313, 335, 628
<b>4510</b>	Flat faceplate, 7/8", 31/32", 1-1/8", or 1-1/2" backset, complete with strike plate	\$81.00
<b>4511</b>	Radius faceplate, 7/8", 31/32", 1-1/8", or 1-1/2" backset, complete with strike plate	\$81.00
<b>4511W</b>	Radius faceplate with weatherstrip, 7/8", 31/32", 1-1/8", or 1-1/2" backset, complete with strike plate	\$86.00
<b>4512</b>	Bevel faceplate, 7/8", 31/32", 1-1/8", or 1-1/2" backset, complete with strike plate	\$81.00

  

SPECIAL MODELS		
<b>4510, 4511, 4512</b>	Flat, radius or bevel faceplate complete with flat / center hung 4" or 4-1/2" strike plate	\$101.00
<b>4510, 4511, 4512</b>	With faceplate, without strike plate	\$66.00
<b>4511W</b>	Radius faceplate with weatherstrip, without strike plate	\$71.00
<b>4513-XX-IB</b>	Without faceplate, without strike plate	\$59.00

HOW TO ORDER Specify quantity and the following information. Order related products separately.						
PRODUCT NO.	FACEPLATE	BACKSET	HANDING	STRIKE SIZE	STRIKE SHAPE/LIP LENGTH	FACEPLATE FINISH
<b>451</b>	<b>1</b>	<b>-3</b>	<b>6</b>	<b>-2</b>	<b>01</b>	<b>-628</b>
	<b>0</b> Flat	<b>1</b> 7/8"	<b>5</b> LH or RHR	<b>1</b> Mortised (4901) 4-5/8"	<b>01</b> Flat/Standard Jamb	<b>313</b> Dark Bronze Anodized
	<b>1</b> Radius	<b>2</b> 31/32"	<b>6</b> RH or LHR	<b>2</b> Mortised (4902) 2-5/8"	<b>02</b> Radius/Standard Stiles	<b>335</b> Black Anodized
	<b>1W</b> Radius with weatherstrip	<b>3</b> 1-1/8"			<b>17</b> Flat/Center Hung 4" Jamb	<b>628</b> Clear Anodized
	<b>2</b> Bevel	<b>4</b> 1-1/2"			<b>21</b> Flat/Center Hung 4-1/2" Jamb	

4530

Standard Duty Deadlatch

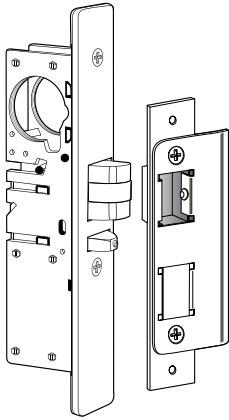

MODELS & FINISHES							313, 335, 628
4530 Flat faceplate, 7/8", 31/32", or 1-1/8" backset, complete with strike plate							\$99.00
4531 Radius faceplate, 7/8", 31/32", or 1-1/8" backset, complete with strike plate							\$99.00
4532 Bevel faceplate, 7/8", 31/32", or 1-1/8" backset, complete with strike plate							\$99.00
SPECIAL MODELS							
4530, 4531, 4532 Flat, radius or bevel faceplate complete with flat / center hung 4" or 4-1/2" strike plate							\$119.00
4530, 4531, 4532 With faceplate, any backset, without strike plate							\$84.00
4533-XX-IB Without faceplate, without strike plate							\$77.00
HOW TO ORDER Specify quantity and the following information. Order related products separately.							
PRODUCT NO.	FACEPLATE	BACKSET	HANDING	STRIKE SIZE	STRIKE SHAPE/LIP LENGTH	FACEPLATE FINISH	
<b>453</b>	<b>1</b>	<b>-3</b>	<b>6</b>	<b>-1</b>	<b>01</b>	<b>-628</b>	
	0 Flat	1 7/8"	5 LH or RHR	1 Mortised (4901) 4-5/8"	01 Flat/Standard Jamb	313 Dark Bronze Anodized	
	1 Radius	2 31/32"	6 RH or LHR	2 Mortised (4902) 2-5/8"	02 Radius/Standard Stiles	335 Black Anodized	
	2 Bevel	3 1-1/8"			17 Flat/Center Hung 4" Jamb	628 Clear Anodized	
					21 Flat/Center Hung 4-1/2" Jamb		

4781

Two-Point Deadlatch with Paddle



MODEL & FINISHES				313, 335, 628	US26D
4781 Paddle includes dogging feature				\$315.00	\$428.00
4781T Paddle with top rod only (less bottom rod)				\$295.00	\$408.00
HOW TO ORDER Specify quantity and the following information. Order related products separately.					
PRODUCT NO.		OPERATION		PADDLE FINISH	
<b>4781</b>	<b>T</b>	<b>-021</b>		<b>-628</b>	
	T Top rod only	021 Push to LEFT	313 Dark Bronze Anodized	US26D Satin Chrome	
	- Standard rod	041 Push to RIGHT	335 Black Anodized		
			628 Clear Anodized		

## 4900

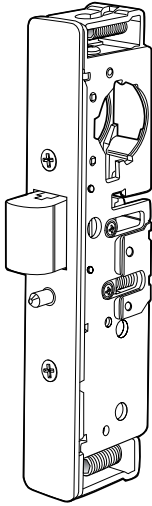

## Heavy Duty Deadlatch

MODELS & FINISHES	313, 335, 628
<b>4900</b> Flat and radius faceplates, 31/32", 1-1/8", or 1-1/2" backset, complete with strike plate	\$111.00
<b>4911W</b> Radius with weatherseal faceplate, 31/32", 1-1/8", or 1-1/2" backset, complete with strike plate	\$116.00
SPECIAL MODEL	
<b>4900</b> Flat and radius faceplates complete with flat / center hung 4" or 4-1/2" strike plate	\$131.00
<b>4900</b> Flat and radius faceplate, without strike plate	\$96.00
<b>4911W</b> Radius with weatherstrip faceplate, without strike plate	\$101.00
<b>4913-XX-IB</b> Without faceplate, without strike plate	\$89.00

**HOW TO ORDER** Specify quantity and the following information. Order related products separately.

PRODUCT NO.	FACEPLATE	BACKSET	HANDING	STRIKE SIZE	STRIKE SHAPE/LIP LENGTH	FACEPLATE FINISH
<b>49</b>	<b>00</b>	<b>-3</b>	<b>5</b>	<b>-2</b>	<b>01</b>	<b>-628</b>
	<b>00</b> Standard	<b>2</b> 31/32"	<b>5</b> LH or RHR	<b>1</b> Mortised (4901) 4-5/8"	<b>01</b> Flat/Standard Jamb	<b>313</b> Dark Bronze Anodized
	<b>11W</b> Radius with Weatherstrip	<b>3</b> 1-1/8"	<b>6</b> RH or LHR	<b>2</b> Mortised (4902) 2-5/8"	<b>02</b> Radius/Standard Stile	<b>335</b> Black Anodized
		<b>4</b> 1-1/2"			<b>17</b> Flat/Center Hung 4" Jamb	<b>628</b> Clear Anodized
					<b>21</b> Flat/Center Hung 4-1/2" Jamb	

## 4920AN

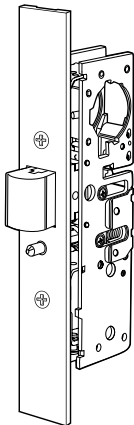

## Heavy Duty Deadlatch (ANSI Size)

MODELS & FINISHES	313, 335, 628
<b>4920AN</b> Flat faceplate, 1-1/2" or 2-3/4" backset, complete with 4506 strike plate	\$136.00
<b>4920AN</b> Flat faceplate, 1-1/2" or 2-3/4" backset, without strike plate	\$121.00
SPECIAL MODELS	
<b>4920AN</b> Flat faceplate, without strike plate	\$101.00
<b>4923AN-XX-IB</b> Without faceplate, without strike plate	\$80.00

**HOW TO ORDER** Specify quantity and the following information. Order related products separately.

PRODUCT NO.	BACKSET	HANDING	STRIKE	FACEPLATE FINISH
<b>4920AN</b>	<b>4</b>	<b>6</b>	<b>-602</b>	<b>-313</b>
	<b>4</b> 1-1/2"	<b>5</b> LH or RHR	<b>000</b> Less Strike	<b>313</b> Dark Bronze Anodized
	<b>5</b> 2-3/4"	<b>6</b> RH or LHR	<b>602</b> 4506 Strike	<b>335</b> Black Anodized
				<b>628</b> Clear Anodized



**FLUSHBOLTS & PIVOTS**

**1870**

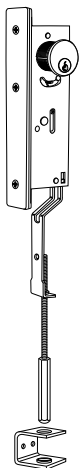

**Cylinder-Operated Flushbolt**

MODELS & CYLINDER HEIGHT	STANDARD 12" CYLINDER HEIGHT	CYLINDER HEIGHT OVER 12" (SPECIFY)
<b>1870</b> Flat faceplate, 313, 335, or 628 finish	\$115.00	\$150.00
<b>1871</b> Radius faceplate, 313, 335, or 628 finish	\$115.00	\$150.00
<b>1871W</b> Radius faceplate with weatherstrip, 313, 335, or 628 finish	\$120.00	\$155.00
<b>1872</b> Bevel faceplate, 313, 335, or 628 finish	\$115.00	\$150.00

For cylinder height greater than 12" up to maximum cylinder height 65" please contact factory.

**HOW TO ORDER** Specify quantity and the following information. Order related products separately.

PRODUCT NO.	FACEPLATE SHAPE	BACKSET	HANDING	FINISH
<b>187</b>	<b>0</b>	<b>-2</b>	<b>0</b>	<b>-628</b>
	<b>0</b> Flat	<b>2</b> 31/32"	<b>0</b> Non-Handed*	<b>313</b> Dark Bronze Anodized
	<b>1</b> Radius	<b>3</b> 1-1/8"	<b>5</b> LH or RHR	<b>335</b> Black Anodized
	<b>1W</b> Radius with weatherstrip		<b>6</b> RH or LHR	<b>628</b> Clear Anodized
	<b>2</b> Bevel			

\*Any flat or radius faceplate.

**1870HM**

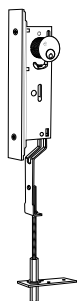

**Cylinder-Operated Flushbolt**

MODEL & CYLINDER HEIGHT	STANDARD 13-1/2" CYLINDER HEIGHT	CYLINDER HEIGHT OVER 13-1/2" (SPECIFY)
<b>1870HM</b> For hollow metal, 313, 335, or 628 finish, 1-1/4" backset	\$155.00	\$200.00

For cylinder height greater than 13-1/2" up to maximum cylinder height 65" please contact factory.

**HOW TO ORDER** Specify quantity and the following information. Order related products separately.

PRODUCT NO.	FACEPLATE SHAPE	HANDING	FINISH
<b>187</b>	<b>0HM</b>	<b>5</b>	<b>-628</b>
	<b>0HM</b> Flat	<b>0</b> Non-Handed	<b>313</b> Dark Bronze Anodized
			<b>335</b> Black Anodized
			<b>628</b> Clear Anodized

**1877**

**Cylinder-Operated Flushbolt**



MODEL & CYLINDER HEIGHT	STANDARD 13-1/2" CYLINDER HEIGHT	CYLINDER HEIGHT OVER 13-1/2" (SPECIFY)
<b>1877</b> For wood, 313 or 628 finish, 1-1/4" backset	\$193.00	\$238.00
<b>1877</b> For wood, 605 or 626 finish, 1-1/4" backset	\$273.00	\$318.00

For cylinder height greater than 13-1/2" up to maximum cylinder height 57-1/2" please contact factory.

**HOW TO ORDER** Specify quantity and the following information. Order related products separately.

PRODUCT NO.	FINISH	
<b>1877</b>	<b>-628</b>	
	313 Dark Bronze Anodized	626 Satin Chrome
	605 Bright Brass	628 Clear Anodized

**MS1880, MS1881**

**Two-Point Flushbolts**

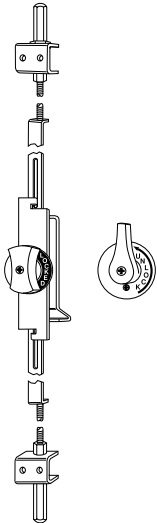

MODELS & FINISHES	119, 121, 682
<b>MS1880</b> Flushbolt with hourglass shaped turn	\$146.00
<b>MS1881</b> Flushbolt with teardrop shaped turn	\$146.00
MODEL	
<b>TDK-1880</b> Tall door kit for doors over 84", up to 144" maximum	\$27.00

**HOW TO ORDER** Specify quantity and the following information. Order related products separately.

PRODUCT NO.	TURN SHAPE	CYLINDER HEIGHT*	FINISH
<b>MS188</b>	<b>0</b>	<b>-01</b>	<b>-682</b>
<b>MS188</b>	0 Hourglass	01 31" to 35"	119 Black
	1 Teardrop	02 35-1/16" to 39"	121 Dark Bronze
		03 39-1/16" 43"	682 Satin Chrome
		04 43-1/16" to 47"	
		05 47-1/16" to 51"	

\*Distance from floor to cylinder centerline.

**MS2180**

**Auto-Release Two-Point Flushbolt**

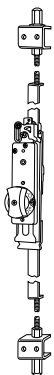

MODELS & FINISHES	119, 121, 130
<b>MS2180</b> Hourglass shaped turn, 7', 8', 9', 10' door height	\$222.00
<b>MS2181</b> Teardrop shaped turn, 7', 8', 9', 10' door height	\$222.00
<b>MS2182</b> Flush operator, 7', 8', 9', 10' door height	\$222.00

**HOW TO ORDER** Specify quantity and the following information. Order related products separately.

PRODUCT NO.	TURN SHAPE	DOOR HEIGHT (FROM FLOOR TO TOP OF DOOR)	FINISH TO MATCH
<b>MS218</b>	<b>0</b>	<b>-07</b>	<b>-130</b>
	0 Hourglass	07 Up to 7' Door	119 Black Anodized
	1 Teardrop	08 Up to 8' Door	121 Dark Bronze Anodized
	2 Flush Operator	09 Up to 9' Door	130 Clear Anodized
		10 Up to 10' Door	

**B1921, B1923**

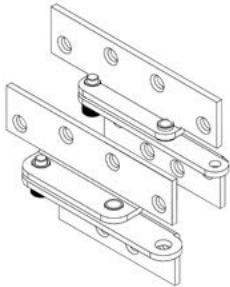

**Reinforcing Pivots**

MODELS & FINISH	
<b>B1921</b>	1/2" offset to match pivot point of 4" wide butt hinge \$82.00
<b>B1923</b>	3/4" offset to match pivot point of 4-1/2" wide butt hinge \$72.00

HOW TO ORDER Specify quantity and the following information. Order related products separately.	
PRODUCT NO.	MODEL
<b>B192</b>	<b>1</b>
	1 4"
	3 4-1/2"

**EXIT DEVICES**

Alarm option cannot be combined with any other Device Option or Monitoring Option. Split finishes (faceplate/pushbar) are not available. Matching end cap option available for US finishes only. Please contact factory for specific ordering questions.

**8099**

**Dummy Pushbar**



MODELS & FINISHES	313, 335, 628	US4, US32D	US3, US32
<b>8099-00</b> Dummy pushbar without mechanism, for doors NOT requiring an exit device.	\$225.00	\$485.00	\$545.00
<b>8099-M0</b> Active dummy bar without latching mechanism, without monitoring switches.	\$295.00		
<b>8099-M1</b> Active dummy bar with monitoring switch but without latching mechanism. May be wired normally open or normally closed to operate maglock, alarm or similar.	\$350.00	\$610.00	\$670.00
<b>8099-M2</b> Active dummy bar with two monitoring switches but without latching mechanism. May be wired normally open or normally closed to operate maglock, alarm or similar.	\$410.00	\$670.00	\$730.00

HOW TO ORDER Specify quantity and the following information. Order related products separately.					
PRODUCT NO.	MONITOR	DOOR TYPE	PUSHBAR FINISH	WIDTH	US FINISH
<b>8099</b>	<b>-M1</b>	<b>-3</b>	<b>0</b>	<b>36</b>	<b>-US32</b>
	<b>00</b> Inactive Dummy Bar	<b>3</b> Aluminum	<b>0</b> US Finish	<b>30</b> 30 inches	<b>US3</b> Bright Brass
	<b>M0</b> Active Dummy Bar, no monitoring switches	<b>4</b> Wood or hollow metal	<b>1</b> Clear Anodized 628	<b>36</b> 36 inches	<b>US4</b> Satin Brass
	<b>M1</b> Active Dummy Bar, one monitoring switch		<b>2</b> Dark Bronze Anodized 313	<b>42</b> 42 inches	<b>US32</b> Bright Stainless
	<b>M2</b> Active Dummy Bar, two monitoring switches		<b>3</b> Black Anodized 335	<b>48</b> 48 inches	<b>US32D</b> Satin Stainless

3100, 8100

Surface Vertical Rod Exit Device

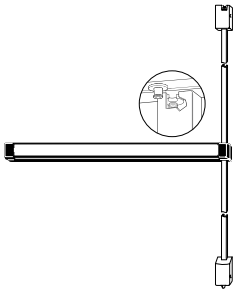

MODELS & FINISHES	313, 335, 628	US4, US32D	US3, US32
<b>8100</b> Surface vertical rod exit device for wood and hollow metal	\$890.00	\$1,150.00	\$1,350.00
<b>8100T</b> Top rod only (less bottom rod) SVR exit device	\$815.00	\$1,075.00	\$1,275.00
<b>3100</b> Fire-rated surface vertical rod exit device for wood and hollow metal	\$1,115.00	\$1,375.00	\$1,575.00
<b>3100T</b> Fire-rated top rod only (less bottom rod) for metal doors	\$1,040.00	\$1,300.00	\$1,500.00
<b>3100W</b> Fire-rated top rod only (less bottom rod) for wood doors	\$1,040.00	\$1,300.00	\$1,500.00

Kitted Options

MODELS & FINISHES	313, 335, 628	US32D	US32
<b>3055</b> Tall door kit for doors up to 10' tall, for use with 3100	\$125.00	\$160.00	\$195.00

**HOW TO ORDER** Specify quantity and the following information. Order related products separately.

MODEL	PUSHBAR FINISH	ROD TYPE	DEVICE OPTIONS	MONITORING OPTION	DOOR OPENING WIDTH On pair of doors, specify HALF of the total exit opening	US FINISH	END CAPS OPTION FOR US FINISH
<b>81</b>	<b>00</b>	<b>-</b>	<b>SE</b>	<b>M2</b>	<b>-30</b>	<b>-US32D</b>	<b>MEC</b>
<b>31</b> Fire Rated	<b>00</b> US Finish	<b>T</b> Top Rod only	<b>LR</b> Electric Latch Retraction	<b>M</b> Single Switch	<b>30</b> 30 inches	<b>US3</b> Bright Brass	<b>MEC</b> Matching End Caps
<b>81</b> Life-Safety	<b>11</b> Clear Anodized 628	<b>W</b> Top Rod only - Wood doors	<b>SE</b> Silent Electrification Latch Retraction	<b>M2</b> Dual Switch	<b>36</b> 36 inches	<b>US4</b> Satin Brass	
	<b>22</b> Dark Bronze Anodized 313	<b>-</b> Standard rod	<b>C</b> Cylinder Dogging (non-fire rated devices ONLY)	<b>(Blank)</b> No Monitor	<b>42</b> 42 inches	<b>US32</b> Bright Stainless	
	<b>33</b> Black Anodized 335		<b>ED</b> Electric Dogging		<b>48</b> 48 inches	<b>US32D</b> Satin Stainless	
			<b>(Blank)</b> No Option		<b>AXXB</b> Alarmed Exit Device where XX is door opening width		

\* Please note that 30" exit devices cannot accommodate monitoring options, except when ordered in conjunction with the SE option.

8200

Narrow Stile Surface Vertical Rod Exit Device

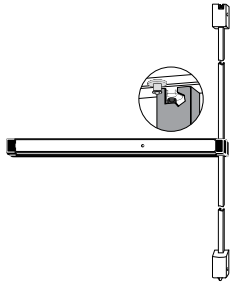

MODELS & FINISHES	313, 335, 628	US4, US32D	US3, US32
<b>8200</b> Narrow stile surface vertical rod exit device	\$837.00	\$1,097.00	\$1,297.00
<b>8200T</b> Top rod only (less bottom rod) SVR exit device	\$762.00	\$1,022.00	\$1,222.00
SPECIAL MODELS	313, 335, 628	US4, US32D	US3, US32
<b>8200-99</b> SVR exit device, less rods	\$762.00	\$1,022.00	\$1,222.00

Kitted Options

MODELS & FINISHES	313, 335, 628	US32D	US32
<b>8055-01</b> Tall door kit for doors up to 10' tall, for use with 8100, 8200	\$115.00	\$150.00	\$185.00

**HOW TO ORDER** Specify quantity and the following information. Order related products separately.

MODEL	PUSHBAR FINISH	ROD TYPE	DEVICE OPTIONS	MONITORING OPTION	DOOR OPENING WIDTH On pair of doors, specify HALF of the total exit opening	US FINISH	END CAPS OPTION FOR US FINISH
<b>82</b>	<b>00</b>	<b>-</b>	<b>ED</b>	<b>M2</b>	<b>-36</b>	<b>-US3</b>	
<b>82</b> Life-Safety	<b>00</b> US Finish	<b>T</b> Top Rod only	<b>LR</b> Electric Latch Retraction	<b>M</b> Single Switch	<b>30</b> 30 inches	<b>US3</b> Bright Brass	<b>MEC</b> Matching End Caps
	<b>11</b> Clear Anodized 628	<b>-</b> Standard rod	<b>SE</b> Silent Electrification Latch Retraction	<b>M2</b> Dual Switch	<b>36</b> 36 inches	<b>US4</b> Satin Brass	
	<b>22</b> Dark Bronze Anodized 313		<b>C</b> Cylinder Dogging	<b>(Blank)</b> No Option	<b>42</b> 42 inches	<b>US32</b> Bright Stainless	
	<b>33</b> Black Anodized 335		<b>ED</b> Electric Dogging		<b>48</b> 48 inches	<b>US32D</b> Satin Stainless	
			<b>(Blank)</b> No Option		<b>AXXB</b> Alarmed Exit Device where XX is door opening width		

**3300, 8300**

**Mortise Exit Device**

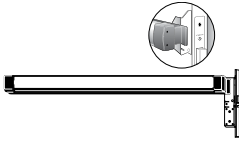

MODELS & FINISHES	313, 335, 628	US4, US32D	US3, US32
<b>8300</b> Mortise exit device for wood and hollow metal	\$683.00	\$1,003.00	\$1,103.00
<b>3300</b> Fire-rated mortise exit device for wood and hollow metal	\$983.00	\$1,303.00	\$1,403.00

**Kitted Options**

MODELS & FINISH	US32D
<b>4009-01</b> Open back strike for 1-3/4" thick doors	\$134.00

For complete list of kitted options for mortise exit devices, please refer to 8400 Narrow Stile Mortise Exit Devices on next page.

**HOW TO ORDER** Specify quantity and the following information. Order related products separately.

MODEL	FACEPLATE FINISH	FACE SHAPE	DEVICE OPTIONS	MONITORING OPTION	DOOR HANDING	PUSHBAR FINISH	DOOR OPENING WIDTH On pair of doors, specify HALF of the total exit opening	US FINISH	END CAPS OPTION
<b>83</b>	<b>3</b>	<b>0</b>	<b>ED</b>	<b>M</b>	<b>-7</b>	<b>3</b>	<b>A36B</b>		
<b>33</b> Fire Rated	<b>0</b> US Finish	<b>0</b> Flat (3300 only)	<b>LR</b> Electric Latch Retraction	<b>M</b> Single Switch	<b>7</b> RHR	<b>0</b> US Finish	<b>30</b> 30 inches	<b>US3</b> Bright Brass	<b>MEC</b> Matching End Caps
<b>83</b> Life-Safety	<b>1</b> Clear Anodized 628	<b>2</b> Bevel (8300 only)	<b>SE</b> Silent Electrification Latch Retraction	<b>M2</b> Dual Switch	<b>8</b> LHR	<b>1</b> Clear Anodized 628	<b>36</b> 36 inches	<b>US4</b> Satin Brass	
	<b>2</b> Dark Bronze Anodized 313		<b>C</b> Cylinder Dogging (non-fire rated devices ONLY)	<b>(Blank)</b> No Monitor		<b>2</b> Dark Bronze Anodized 313	<b>42</b> 42 inches	<b>US32</b> Bright Stainless	
	<b>3</b> Black Anodized 335		<b>ED</b> Electric Dogging			<b>3</b> Black Anodized 335	<b>48</b> 48 inches	<b>US32D</b> Satin Stainless	
			- Without Options				<b>AXXB</b> Alarmed Exit Device where XX is door opening width		

\*Please note that 30" exit devices cannot accommodate monitoring options, except when ordered in conjunction with the SE option.

8400

Narrow Stile Mortise Exit Device

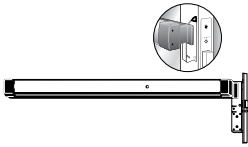

MODEL & FINISHES	313, 335, 628	US4, US32D	US3, US32
8400 Narrow stile mortise exit device	\$610.00	\$910.00	\$1,010.00

Please contact factory for information on the 8475 Midpanel Mortise Exit Device. Pricing is standard pricing plus unique door cutting charge for custom cut length.

Kitted Options

MODELS	US32D
8455-01 Long face strike for covering MS strike prep	\$97.00
8460-17-630 Long lip strike for jambs that project outward 2-1/4" beyond the centerline of door	\$74.00
91-0995-02-IP 2" thick door kit for use with 8300, 8400	\$16.00
91-0995-03-IP 2-1/4" thick door kit for use with 8300, 8400	\$16.00
91-0995-04-IP 2-1/2" thick door kit for use with 8300, 8400	\$19.00
91-0995-05-IP 2-3/4" thick door kit for use with 8300, 8400	\$24.00
91-0995-06 3" thick door kit for use with 8300, 8400	\$24.00
91-0325-01 Thermal door kit, 1/4" cladding, for use with 8400	\$78.00
91-0325-02 Thermal door kit, 1/2" cladding, for use with 8400	\$142.00

HOW TO ORDER Specify quantity and the following information. Order related products separately.

MODEL	FACEPLATE FINISH	FACE SHAPE	DEVICE OPTIONS	MONITORING OPTION	BACKSET	DOOR HANDING	PUSHBAR FINISH	DOOR OPENING WIDTH On pair of doors, specify HALF of the total exit opening	US FINISH	END CAPS OPTION FOR US FINISH
<b>84</b>	<b>1</b>	<b>4</b>	<b>SE</b>	<b>M2</b>	<b>-4</b>	<b>7</b>	<b>1</b>	<b>42</b>		
84 Life-Safety	0 US Finish	0 Flat, Radius, Bevel	LR Electric Latch Retraction	M Single Switch	2 31/32"	7 RHR	0 US Finish	30 30 inches	US3 Bright Brass	MEC Matching End Caps
	1 Clear Anodized 628	4 Radius w/ Weatherstrip*	SE Silent Electrification Latch Retraction	M2 Dual Switch	3 1-1/8"	8 LHR	1 Clear Anodized 628	36 36 inches	US4 Satin Brass	
	2 Dark Bronze Anodized 313		C Cylinder Dogging	(Blank) No Monitor	4 1-1/2"		2 Dark Bronze Anodized 313	42 42 inches	US32 Bright Stainless	
	3 Black Anodized 335		ED Electric Dogging				3 Black Anodized 335	48 48 inches	US32D Satin Stainless	
			- Without Options					AXXB Alarmed Exit Device where XX is door opening width		

\*Radius with weatherstrip faceplate is not available in US finishes.

3600, 8500

**Metal Door Concealed Vertical Rod Exit Device**

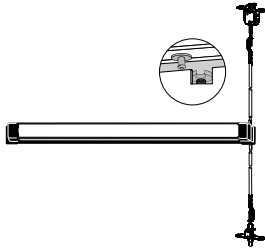

MODELS & FINISHES	313, 335, 628	US4, US32D	US3, US32
<b>8500</b> Concealed vertical rod exit device for hollow metal	\$636.00	\$936.00	\$996.00
<b>8500T</b> Top rod only (less bottom rod) CVR exit device	\$561.00	\$861.00	\$921.00
<b>3600</b> Fire-rated concealed vertical rod exit device for hollow metal	\$1,050.00	\$1,350.00	\$1,410.00
<b>3600T</b> Fire-rated top rod only (less bottom rod) CVR exit device	\$975.00	\$1,275.00	\$1,335.00

**Kitted Options**

MODEL	
<b>3655</b> Tall door kit for doors taller than 66" above bar height, up to 10'	\$54.00

**HOW TO ORDER** Specify quantity and the following information. Order related products separately.

MODEL	PUSHBAR FINISH	ROD TYPE	DEVICE OPTIONS	MONITORING OPTION	DOOR OPENING WIDTH On pair of doors, specify HALF of the total exit opening	US FINISH	END CAPS OPTION FOR US FINISH
<b>85</b>	<b>00</b>	<b>T</b>	<b>ED</b>	<b>M</b>	<b>-36</b>	<b>-US32D</b>	
<b>36</b> Fire Rated	<b>00</b> US Finish	<b>T</b> Top Rod only	<b>LR</b> Electric Latch Retraction	<b>M</b> Single Switch	<b>30</b> 30 inches	<b>US3</b> Bright Brass	<b>MEC</b> Matching End Caps
<b>85</b> Life-Safety	<b>11</b> Clear Anodized 628	- Standard rod	<b>SE</b> Silent Electrification Latch Retraction	<b>M2</b> Dual Switch	<b>36</b> 36 inches	<b>US4</b> Satin Brass	
	<b>22</b> Dark Bronze Anodized 313		<b>C</b> Cylinder Dogging (non-fire rated devices only)	<b>(Blank)</b> No Monitor	<b>42</b> 42 inches	<b>US32</b> Bright Stainless	
	<b>33</b> Black Anodized 335		<b>ED</b> Electric Dogging		<b>48</b> 48 inches	<b>US32D</b> Satin Stainless	
			<b>(Blank)</b> No Option		<b>AXXB</b> Alarmed Exit Device where XX is door opening width		

\*Please note that 30" exit devices cannot accommodate monitoring options, except when ordered in conjunction with the SE option.

8600

**Narrow Stile Concealed Vertical Rod Exit Device**

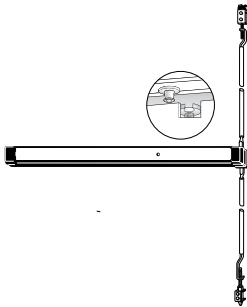

MODELS & FINISHES	313, 335, 628	US4, US32D	US3, US32
<b>8600</b> Narrow stile concealed vertical rod exit device	\$598.00	\$898.00	\$958.00
<b>8600T</b> Top rod only (less bottom rod) CVR exit device	\$533.00	\$823.00	\$883.00
SPECIAL MODELS	313, 335, 628	US4, US32D	US3, US32
<b>8600-99</b> CVR exit device, less rods	\$533.00	\$823.00	\$883.00

Please contact factory for information on the 8675 Midpanel CVR Exit Device. Pricing is standard pricing plus unique door cutting charge for custom cut length.

**Kitted Options**

MODEL	
<b>8655</b> Tall door kit for doors up to 10' for use with 8500, 8600	\$52.00

**HOW TO ORDER** Specify quantity and the following information. Order related products separately.

MODEL	PUSHBAR FINISH	ROD TYPE	DEVICE OPTIONS	MONITORING OPTION	DOOR OPENING WIDTH On pair of doors, specify HALF of the total exit opening	US FINISH	END CAPS OPTION FOR US FINISH
<b>86</b>	<b>22</b>	<b>T</b>	<b>SE</b>	<b>M2</b>	<b>-36</b>		
<b>86</b> Life-Safety	<b>00</b> US Finish	<b>T</b> Top Rod only	<b>LR</b> Electric Latch Retraction	<b>M</b> Single Switch	<b>30</b> 30 inches	<b>US3</b> Bright Brass	<b>MEC</b> Matching End Caps
	<b>11</b> Clear Anodized 628	- Standard rod	<b>SE</b> Silent Electrification Latch Retraction	<b>M2</b> Dual Switch	<b>36</b> 36 inches	<b>US4</b> Satin Brass	
	<b>22</b> Dark Bronze Anodized 313		<b>C</b> Cylinder Dogging	<b>(Blank)</b> No Monitor	<b>42</b> 42 inches	<b>US32</b> Bright Stainless	
	<b>33</b> Black Anodized 335		<b>ED</b> Electric Dogging		<b>48</b> 48 inches	<b>US32D</b> Satin Stainless	
			<b>(Blank)</b> No Option		<b>AXXB</b> Alarmed Exit Device where XX is door opening width		

## 3700, 8700

## Rim Exit Device



MODELS & FINISHES	313, 335, 628	US4, US32D	US3, US32
<b>8700</b> Rim exit device for wood and hollow metal	\$440.00	\$700.00	\$760.00
<b>3700</b> Fire-rated rim exit device for wood and hollow metal	\$740.00	\$1,000.00	\$1,060.00

## Kitted Options

MODELS	N/A
<b>3889-08</b> Mullion for doors up to 8' for use with 8700, 3700	\$513.00

**HOW TO ORDER** Specify quantity and the following information. Order related products separately.

MODEL	PUSHBAR FINISH	DEVICE OPTIONS	MONITORING OPTION	DOOR OPENING WIDTH On pair of doors, specify HALF of the total exit opening	US FINISH	END CAPS OPTION FOR US FINISH	VOLTAGE
<b>37</b>	<b>00</b>	<b>EL</b>	<b>M1</b>	<b>-36</b>	<b>-US3</b>	<b>MEC</b>	<b>-12</b>
<b>37</b> Fire Rated	<b>00</b> US Finish	<b>EL</b> Electric Latch Retraction (indicate 12V/24V)	<b>M</b> Single Switch	<b>30</b> 30 inches	<b>US3</b> Bright Brass	<b>MEC</b> Matching End Caps	<b>12</b> Volts
<b>87</b> Life-Safety	<b>01</b> Clear Anodized 628	<b>SE</b> Silent Electrification Latch Retraction	<b>M2</b> Dual Switch	<b>36</b> 36 inches	<b>US4</b> Satin Brass		<b>24</b> Volts
	<b>02</b> Dark Bronze Anodized 313	<b>C</b> Cylinder Dogging	<b>(Blank)</b> No Monitor	<b>42</b> 42 inches	<b>US32</b> Bright Stainless		(For EL Option Only)
	<b>03</b> Black Anodized 335	<b>ED</b> Electric Dogging		<b>48</b> 48 inches	<b>US32D</b> Satin Stainless		
		- Without Options		<b>AXXB</b> Alarmed Exit Device where XX is door opening width			

\*Please note that 30" exit devices cannot accommodate monitoring options, except when ordered in conjunction with the SE option.

## 8800

## Narrow Stile Rim Exit Device



MODEL & FINISHES	313, 335, 628	US4, US32D	US3, US32
<b>8800</b> Narrow stile rim exit device	\$423.00	\$683.00	\$743.00

## Kitted Options

MODELS	313, 628
<b>3890-08</b> Aluminum mullion for doors up to 8' for use with 8800	\$563.00
<b>3890-10</b> Aluminum mullion for doors up to 10' for use with 8800	\$588.00

**HOW TO ORDER** Specify quantity and the following information. Order related products separately.

MODEL	PUSHBAR FINISH	DEVICE OPTIONS	MONITORING OPTION	DOOR OPENING WIDTH On pair of doors, specify HALF of the total exit opening	US FINISH	END CAPS OPTION FOR US FINISH	VOLTAGE
<b>88</b>	<b>01</b>	<b>C</b>	<b>M2</b>	<b>-36</b>			<b>-12</b>
<b>88</b> Life-Safety	<b>00</b> US Finish	<b>EL</b> Electric Latch Retraction (indicate 12V/24V)	<b>M</b> Single Switch	<b>30</b> 30 inches	<b>US3</b> Bright Brass	<b>MEC</b> Matching End Caps	<b>12</b> Volts
	<b>01</b> Clear Anodized 628	<b>SE</b> Silent Electrification Latch Retraction	<b>M2</b> Dual Switch	<b>36</b> 36 inches	<b>US4</b> Satin Brass		<b>24</b> Volts
	<b>02</b> Dark Bronze Anodized 313	<b>C</b> Cylinder Dogging	<b>(Blank)</b> No Monitor	<b>42</b> 42 inches	<b>US32</b> Bright Stainless		(For EL Option Only)
	<b>03</b> Black Anodized 335	<b>ED</b> Electric Dogging		<b>48</b> 48 inches	<b>US32D</b> Satin Stainless		
		- Without Options		<b>AXXB</b> Alarmed Exit Device where XX is door opening width			



**3900, 8900**

**Wood Door Surface Concealed Vertical Rod Exit Device**

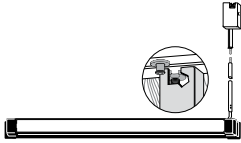

MODELS & FINISHES	313, 335, 628	US4, US32D	US3, US32
<b>8900</b> Surface concealed vertical rod exit device for wood	\$720.00	\$1,020.00	\$1,120.00
<b>3900</b> Fire-rated surface concealed vertical rod for wood	\$1,140.00	\$1,440.00	\$1,540.00

**Kitted Options**

MODEL		
<b>8955-01</b> Tall door kit for doors up to 10' for use with 8900		\$54.00
<b>3955-01</b> Tall door kit for doors up to 10' for use with 3900		\$54.00

**HOW TO ORDER** Specify quantity and the following information. Order related products separately.

MODEL	PUSHBAR FINISH	DEVICE OPTIONS	MONITORING OPTION	DOOR OPENING WIDTH On pair of doors, specify HALF of the total exit opening	US FINISH	END CAPS OPTION FOR US FINISH
<b>89</b>	<b>00</b>	<b>LR</b>	<b>M2</b>	<b>-36</b>	<b>-US32</b>	
<b>39</b> Fire Rated	<b>00</b> US Finish	<b>LR</b> Electric Latch Retraction	<b>M</b> Single Switch	<b>30</b> 30 inches	<b>US3</b> Bright Brass	<b>MEC</b> Matching End Caps
<b>89</b> Life-Safety	<b>11</b> Clear Anodized 628	<b>SE</b> Silent Electrification Latch Retraction	<b>M2</b> Dual Switch	<b>36</b> 36 inches	<b>US4</b> Satin Brass	
	<b>22</b> Dark Bronze Anodized 313	<b>C</b> Cylinder Dogging (non-fire rated devices only)	<b>(Blank)</b> No Monitor	<b>42</b> 42 inches	<b>US32</b> Bright Stainless	
	<b>33</b> Black Anodized 335	<b>ED</b> Electric Dogging		<b>48</b> 48 inches	<b>US32D</b> Satin Stainless	
		<b>(Blank)</b> No Option		<b>AXXB</b> Alarmed Exit Device where XX is door opening width		

\*Please note that 30" exit devices cannot accommodate monitoring options, except when ordered in conjunction with the SE option.

**ACCESSORIES FOR EXIT DEVICES**

OPTIONS & FINISHES	N/A	US4, US32D	US3, US32
<b>SE</b> Silent electrification motorized latch retraction	\$650.00		
<b>EL</b> Electric latch retraction for use with 3700, 8700, 8800 rim exit devices only	\$347.00		
<b>ELD</b> Electric latch retraction with mechanical dogging for rim exit devices only	\$396.00		
<b>LR</b> Electric latch retraction for use with CVR, Mortise and SVR exit devices.	\$594.00		
<b>ALARM</b> Battery-operated alarmed exit device. Alarm option cannot be combined with any other device option or monitoring options.	\$456.00		
<b>M1</b> Monitor/single signal switch	\$120.00		
<b>M2</b> Monitor/double signal switch	\$180.00		
<b>C</b> Cylinder dogging	\$48.00		
<b>ED</b> Electric dogging	\$406.00		
<b>MEC</b> Matching end caps. For US finishes only, not applicable to anodized finishes		\$79.00	\$102.00

## KITTED OPTIONS FOR EXIT DEVICES

MODELS & FINISHES	N/A	313, 335, 628	US4, US32D	US3, US32	119, 121, 652
<b>ALARM EXIT KIT</b> Kit for retrofitting an alarm function to an existing Adams Rite exit device. Includes new pushbar, end caps and installation hardware.		\$580.00	\$810.00	\$855.00	
<b>91-0897-01</b> Single signal switch kit, retrofits to 3000/8000	\$105.00				
<b>91-0897-02</b> Double signal switch kit, retrofits to 3000/8000	\$165.00				
<b>26-0584-XXX-MP</b> Sex bolts, 2 per bag, 2 kits required per exit device					\$25.00

## MODIFICATION OPTIONS FOR EXIT DEVICES

MODELS	ADD
<b>THICK DOOR</b> For doors thicker than 1-3/4" and/or door skins plus reinforcement thicker than those specified in the Adams Rite Master Reinforcement Sheet template, for CVR and Mortise Exit Devices	\$65.00
<b>UNIQUE DOOR</b> Cutting charges for non-standard custom cut lengths between 30" and 48"	\$85.00

Please note that thick door modification options are available for 8300, 8400, and 8600 series exit devices only.

## ELECTRIC STRIKES

## 7100, 7101

## Electric Strikes

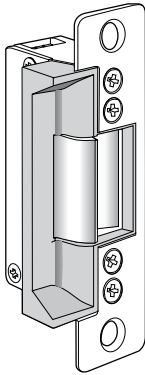

MODELS & FINISHES	313, 335, 628	626
<b>7100</b> For aluminum jambs	\$180.00	\$205.00
<b>7101</b> For radius aluminum stiles	\$180.00	
<b>7100-XX7, 7100-XX9</b> Monitoring signal switches	\$280.00	\$305.00

Lip Extensions up to 3" for center-hung or non-flush doors add \$32.

**HOW TO ORDER** Specify quantity and the following information. Order related products separately.

PRODUCT NO.	FACEPLATE SHAPE	VOLTAGE	CURRENT AND DUTY	FEATURES*	FINISH**	LIP EXTENSIONS (DIM. A) (Door Centerline to Jamb Edge)	
<b>710</b>	<b>0</b>	<b>-3</b>	<b>1</b>	<b>0</b>	<b>-628</b>	<b>-00</b>	
	<b>0</b> Flat	<b>3</b> 12 Volt	<b>1</b> DC Continuous or Intermittent	<b>0</b> Standard/Fail-Secure	<b>313</b> Dark Bronze Anodized	<b>00</b> 1-1/16" or less	<b>05</b> 2"
	<b>1</b> Radius	<b>5</b> 24 Volt	<b>4</b> AC Intermittent	<b>5</b> Fail-Safe	<b>335</b> Black Anodized	<b>01</b> 1-1/2"	<b>07</b> 2-1/4"
				<b>7</b> Monitored/ Fail-Safe	<b>626</b> Satin Chrome	<b>02</b> 1-5/8"	<b>09</b> 2-1/2"
				<b>9</b> Monitored/ Fail-Secure	<b>628</b> Clear Anodized	<b>03</b> 1-3/4"	<b>12</b> 2-7/8"

\*Fail-secure can be converted to fail-safe and vice versa. \*\*7101 available in 313, 335, 628 only.

7110, 7111

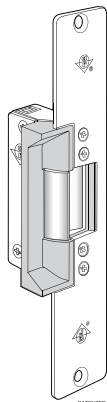

Electric Strikes

MODELS & FINISHES	652
7110 For wood jambs	\$215.00
7111 For wood jambs, long faceplate	\$215.00
7110-XX7, 7110-XX9 Monitoring signal switches	\$315.00

Lip Extensions up to 3" for center-hung or non-flush doors add \$32.

HOW TO ORDER Specify quantity and the following information. Order related products separately.							
PRODUCT NO.	FACEPLATE LENGTH	VOLTAGE	CURRENT AND DUTY	FEATURES*	FINISH	LIP EXTENSIONS (DIM. A) (Door Centerline to Jamb Edge)	
<b>711</b>	<b>0</b>	<b>-3</b>	<b>1</b>	<b>0</b>	<b>-652</b>	<b>-00</b>	
	0 7-15/16"	3 12 Volt	1 DC Continuous or Intermittent	0 Standard/Fail-Secure	652 Satin Chrome	00 1-1/16" or less	05 2"
	1 10-1/4"	5 24 Volt	4 AC Intermittent	5 Fail-Safe		01 1-1/2"	07 2-1/4"
				7 Monitored/ Fail-Safe		02 1-5/8"	09 2-1/2"
				9 Monitored/ Fail-Secure		03 1-3/4"	12 2-7/8"

\*Fail-secure can be field converted to fail-safe or vice-versa.

7130, 7131

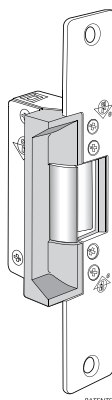

Electric Strikes

MODELS & FINISHES	313, 335, 628
7130 For aluminum jambs, pre-cut for MS lock strike plate	\$185.00
7131 For radius aluminum stiles, pre-cut for MS lock strike plate	\$185.00

Lip Extensions up to 3" for center-hung or non-flush doors add \$32.

HOW TO ORDER Specify quantity and the following information. Order related products separately.							
PRODUCT NO.	FACEPLATE SHAPE	VOLTAGE	CURRENT AND DUTY	FEATURES*	FINISH	LIP EXTENSIONS (DIM. A) (Door Centerline to Jamb Edge)	
<b>713</b>	<b>0</b>	<b>-3</b>	<b>1</b>	<b>0</b>	<b>-313</b>	<b>-00</b>	
	0 Flat	3 12 Volt	1 DC Continuous or Intermittent	0 Standard/Fail-Secure	313 Dark Bronze Anodized	00 1-1/16" or less	05 2"
	1 Radius	5 24 Volt	4 AC Intermittent	5 Fail-Safe	335 Black Anodized	01 1-1/2"	07 2-1/4"
					628 Clear Anodized	02 1-5/8"	09 2-1/2"
						03 1-3/4"	12 2-7/8"

\*Fail-secure can be field converted to fail-safe or vice-versa.

7140

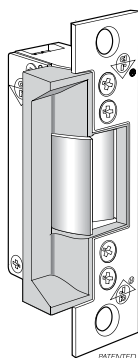

Electric Strike

MODEL & FINISHES	313, 335, 628	626
7140 ANSI size for hollow metal and wood jambs	\$180.00	\$205.00

Lip Extensions up to 3" for center-hung or non-flush doors add \$32.

HOW TO ORDER Specify quantity and the following information. Order related products separately.						
PRODUCT NO.	VOLTAGE	CURRENT AND DUTY	FEATURES*	FINISH	LIP EXTENSIONS (DIM. A) (Door Centerline to Jamb Edge)	
<b>7140</b>	<b>-3</b>	<b>1</b>	<b>0</b>	<b>-628</b>	<b>-00</b>	
	3 12 Volt	1 DC Continuous or Intermittent	0 Standard/Fail-Secure	313 Dark Bronze Anodized	00 1-1/16" or less	05 2"
	5 24 Volt	4 AC Intermittent	5 Fail-Safe	335 Black Anodized	50 1-3/8"	07 2-1/4"
				626 Satin Chrome	01 1-1/2"	09 2-1/2"
				628 Clear Anodized	02 1-5/8"	12 2-7/8"
					03 1-3/4"	

\*Fail-secure can be field converted to fail-safe or vice-versa.



P 800.872.3267 • F 800.232.7329  
 E orders.adamsrite@assaabloy.com  
 10027 S. 51st Street, Ste 102  
 Phoenix, Arizona 85044  
 www.adamsrite.com

**7160**

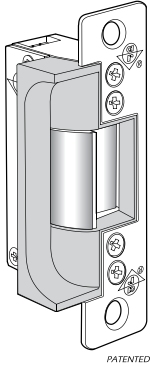

**Electric Strike**

MODELS & FINISHES	313, 335, 628	626
<b>7160</b> For aluminum jambs	\$225.00	\$250.00
<b>7160-XX7, 7160-XX9</b> Monitoring signal switches	\$325.00	\$350.00

Lip Extensions up to 3" for center-hung or non-flush doors add \$32.

HOW TO ORDER Specify quantity and the following information. Order related products separately.						
PRODUCT NO.	VOLTAGE	CURRENT AND DUTY	FEATURES*	FINISH	LIP EXTENSIONS (DIM. A) (Door Centerline to Jamb Edge)	
<b>7160</b>	<b>-3</b>	<b>1</b>	<b>0</b>	<b>-628</b>	<b>-00</b>	
	3 12 Volt	1 DC Continuous or Intermittent	0 Standard/Fail-Secure	313 Dark Bronze Anodized	00 1-1/16" or less	05 2"
	5 24 Volt	4 AC Intermittent	5 Fail-Safe	335 Black Anodized	01 1-1/2"	07 2-1/4"
			7 Monitor/Fail-Safe	626 Satin Chrome	02 1-5/8"	09 2-1/2"
			9 Monitor/Fail-Secure	628 Clear Anodized	03 1-3/4"	12 2-7/8"

\*Fail-secure can be field converted to fail-safe or vice-versa.

**7170**

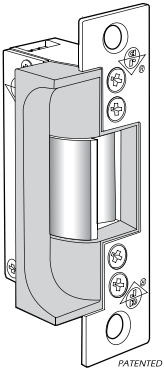

**Electric Strike**

MODELS & FINISHES	313, 335, 628	626
<b>7170</b> For hollow metal and wood jambs	\$225.00	\$250.00
<b>7170-XX7, 7170-XX9</b> Monitoring signal switches	\$325.00	\$350.00

Lip Extensions up to 3" for center-hung or non-flush doors add \$32.

HOW TO ORDER Specify quantity and the following information. Order related products separately.						
PRODUCT NO.	VOLTAGE	CURRENT AND DUTY	FEATURES*	FINISH	LIP EXTENSIONS (DIM. A) Door Centerline to Jamb Edge	
<b>7170</b>	<b>-3</b>	<b>1</b>	<b>0</b>	<b>-628</b>	<b>-00</b>	
	3 12 Volt	1 DC Continuous or Intermittent	0 Standard/Fail-Secure	313 Dark Bronze Anodized	00 1-1/16" or less	05 2"
	5 24 Volt	4 AC Intermittent	5 Fail-Safe	335 Black Anodized	50 1-3/8"	07 2-1/4"
			7 Monitor/Fail-Safe	626 Satin Chrome	01 1-1/2"	09 2-1/2"
			9 Monitor/Fail-Secure	628 Clear Anodized	02 1-5/8"	12 2-7/8"
					03 1-3/4"	

\*Fail-secure can be field converted to fail-safe or vice-versa.

Modular Packaging Program – Match strike body with faceplate kit for complete electric strike. Select 7103A for standard jambs and 7173A for radius stile mounting.

**7100 Series**

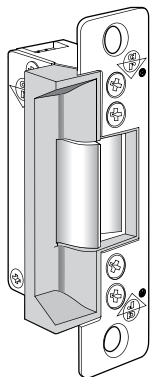

**Electric Strike Components**

STRIKE BODY KITS			
<b>7103A</b> For use with faceplate kits: FPK00, FPK01, FPK10, FPK11, FPK30, FPK31, FPK40			\$150.00
<b>7173A</b> For use with faceplate kits: FPK00, FPK11, FPK31			\$195.00
One strike body kit matched with one faceplate kit makes a complete electric strike assembly.			
FACEPLATE KITS & FINISHES	313,335, 628	626	605
<b>FPK00</b> For use with body kits: 7103A, 7173A	\$30.00	\$55.00	\$60.00
<b>FPK01</b> For use with body kit: 7103A	\$30.00		
FACEPLATE KITS & FINISHES		652	632
<b>FPK10</b> For use with body kit: 7103A		\$65.00	\$90.00
<b>FPK11</b> For use with body kits: 7103A, 7173A		\$65.00	\$90.00
FACEPLATE KITS & FINISHES	313,335, 628	626	605
<b>FPK30</b> For use with body kit: 7103A	\$35.00		
<b>FPK31</b> For use with body kits: 7103A, 7173A	\$35.00		
<b>FPK40</b> For use with body kit: 7103A	\$30.00	\$55.00	\$60.00
<b>FPK45</b> For use with body kit: 7103A, for installing electric strike in previous prep, 4901, 4501 strike cover.	\$35.00		

Faceplate kits contain all hardware to mount electric strike.

KITTED OPTIONS	
<b>91-0171-01-IP through -13-IP</b> Lip extension kits for use with 7100 through 7140	\$33.00
<b>91-0171-50-IP</b> Lip extension kits for use with 7100 through 7140 interior framing systems	\$33.00
<b>91-0172-01-IP through -13-IP</b> Lip extension kits for use with 7160 and 7170	\$33.00
<b>91-0172-50-IP</b> Lip extension kits for use with 7160 and 7170 interior framing systems	\$33.00

**7240 Series**

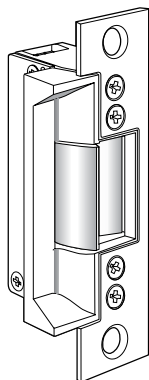

**Fire-Rated Electric Strikes**

MODELS & FINISH	630
<b>7240</b> Fire-rated, for cylindrical latches	\$340.00
<b>7240-50</b> Lip extension for interior frame systems	\$377.00
<b>7240-XX9</b> Monitoring signal switches	\$440.00

HOW TO ORDER Specify quantity and the following information. Order related products separately.					
PRODUCT NO.	VOLTAGE	CURRENT AND DUTY	FEATURES	FINISH	LIP EXTENSIONS (DIM. A) Door Centerline to Jam Edge for Interior Frames
<b>7240</b>	<b>-3</b>	<b>1</b>	<b>0</b>	<b>-630</b>	<b>-50</b>
	3 12 Volt	1 DC Continuous or Intermittent	0 Fail-Secure*	630 Satin Stainless	00 1-1/16" or less
	5 24 Volt	4 AC Intermittent	9 Monitor/Fail-Secure		50 1-3/8"

\*Not available fail-safe.

**7270 Series**

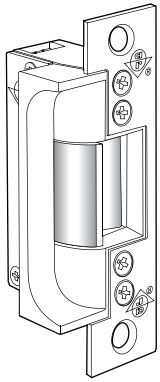

**Fire-Rated Electric Strikes**

MODELS & FINISH		630
<b>7270</b>	Fire-rated, for mortise latches	\$394.00
<b>7270-50</b>	Lip extension for interior frame systems	\$431.00
<b>7270-XX9</b>	Monitoring signal switches	\$494.00

**HOW TO ORDER** Specify quantity and the following information. Order related products separately.

PRODUCT NO.	VOLTAGE	CURRENT AND DUTY	FEATURES	FINISH	LIP EXTENSIONS (DIM. A) Door Centerline to Jam Edge for Interior Frames
<b>7270</b>	<b>-3</b>	<b>1</b>	<b>0</b>	<b>-630</b>	<b>-50</b>
	3 12 Volt	1 DC Continuous or Intermittent	0 Fail-Secure*	630 Satin Stainless	00 1-1/16" or less
	5 24 Volt	4 AC Intermittent	9 Monitor/Fail-Secure		50 1-3/8"

\*Not available fail-safe.

**7400, 7401**

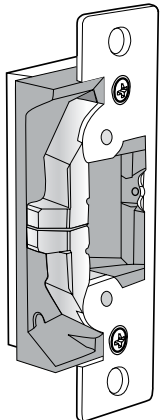

**Ultraline Electric Strikes**

MODELS & FINISHES	313, 335, 628	630	605, 606, 629	119, 121, 130
<b>7400</b> For radius jambs	\$250.00	\$275.00	\$285.00	
<b>7400M</b> Monitoring signal switches	\$350.00	\$375.00	\$385.00	
<b>7401</b> For radius aluminum stiles				\$250.00
<b>7401M</b> Monitoring signal switches				\$350.00

**HOW TO ORDER** Specify quantity and the following information. Order related products separately.

PRODUCT NO.	FACEPLATE SHAPE	FEATURES	FINISH		
<b>740</b>	<b>0</b>	<b>M</b>	<b>628</b>		
	0 Flat	- None	<b>7400 ONLY</b>		<b>7401 ONLY</b>
	1 Radius	M Monitored	313 Dark Bronze Anodized	628 Clear Anodized	119 To match 335 Black Anodized
		A Modular Pack - Body Kit	335 Black Anodized	629 Bright Stainless	121 To match 313 Dark Bronze Anodized
			605 Bright Brass	630 Satin Stainless	130 To match 628 Clear Anodized
			606 Satin Brass		

Fail-secure can be field converted to fail-safe or vice-versa.

**7410, 7411**

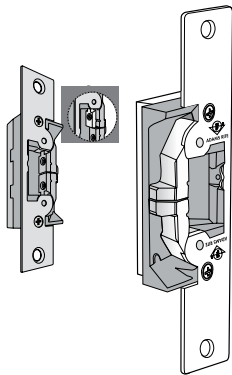

**Ultraline Electric Strikes**

MODELS & FINISHES	313, 335, 628	630
<b>7410</b> For wood jambs, 7-15/16" faceplate	\$280.00	\$305.00
<b>7410M</b> Monitoring signal switches	\$380.00	\$405.00
<b>7411</b> For wood jambs, 10-1/4" faceplate, not available in 335 Finish	\$280.00	\$305.00
<b>7411M</b> Monitoring signal switches		\$405.00

**HOW TO ORDER** Specify quantity and the following information. Order related products separately.

PRODUCT NO.	FACEPLATE LENGTH	FEATURES	FINISH	
<b>741</b>	<b>0</b>	-	<b>628</b>	
	<b>0</b> 7-15/16"	- None	<b>313</b> Dark Bronze Anodized	<b>628</b> Clear Anodized
	<b>1</b> 10-1/4"	<b>M</b> Monitored	<b>335</b> Black Anodized	<b>630</b> Satin Stainless

Fail-secure can be field converted to fail-safe or vice-versa.

**7430, 7431**

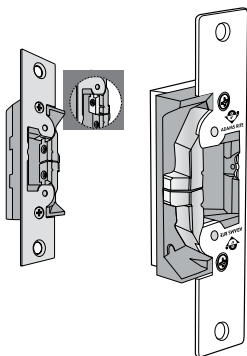

**Ultraline Electric Strikes**

MODELS & FINISHES	313, 335, 628	119, 121, 130
<b>7430</b> For aluminum jambs, flat faceplate	\$255.00	
<b>7430M</b> Monitoring signal switches	\$355.00	
<b>7431</b> For aluminum stiles, radius faceplate		\$255.00
<b>7431M</b> Monitoring signal switches, not available in 119 finish.		\$355.00

**HOW TO ORDER** Specify quantity and the following information. Order related products separately.

PRODUCT NO.	FACEPLATE SHAPE	FEATURES	FINISH	
<b>743</b>	<b>0</b>	<b>M</b>	<b>628</b>	
	<b>0</b> Flat	- None	<b>313</b> Dark Bronze Anodized	<b>119</b> To match 335 Black Anodized
	<b>1</b> Radius	<b>M</b> Monitored	<b>335</b> Black Anodized	<b>121</b> To match 313 Dark Bronze Anodized
			<b>628</b> Clear Anodized	<b>130</b> To match 628 Clear Anodized

Fail-secure can be field converted to fail-safe or vice-versa.

**7440**

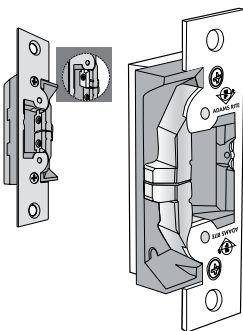

**Ultraline Electric Strikes**

MODELS & FINISHES	313, 335, 628	630	605, 606, 629
<b>7440</b> For steel and wood, jambs and doors	\$250.00	\$275.00	\$285.00
<b>7440M</b> Monitoring signal switches	\$350.00	\$375.00	\$385.00

**HOW TO ORDER** Specify quantity and the following information. Order related products separately.

PRODUCT NO.	FEATURES	FINISH		
<b>7440</b>	<b>M</b>	<b>628</b>		
	- None	<b>313</b> Dark Bronze Anodized	<b>606</b> Satin Brass	<b>629</b> Bright Stainless
	<b>M</b> Monitored	<b>335</b> Black Anodized	<b>628</b> Clear Anodized	<b>630</b> Satin Stainless
		<b>605</b> Bright Brass		

Fail-secure can be field converted to fail-safe or vice-versa.

**74R1**

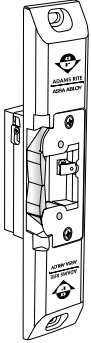

**Ultraline Electric Strikes**

MODELS & FINISHES		119, 121, 130
<b>74R1</b>	For use with rim exit devices with 3/4" latchbolt	\$337.00
<b>74R1M</b>	Monitoring signal switches	\$437.00

**HOW TO ORDER** Specify quantity and the following information. Order related products separately.

PRODUCT NO.	FEATURES	FINISH
<b>74R1</b>	<b>M</b>	<b>-130</b>
	- None	<b>119</b> To match 335 Black Anodized
	<b>M</b> Monitored	<b>121</b> To match 313 Dark Bronze Anodized
		<b>130</b> To match 628 Clear Anodized

Fail-secure can be field converted to fail-safe or vice-versa.

**74R2**

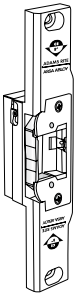

**Ultraline Electric Strike**

MODELS & FINISHES		119, 121, 130
<b>74R2</b>	For use with narrow stile rim exit devices with 1/2" latchbolt	\$337.00

**HOW TO ORDER** Specify quantity and the following information. Order related products separately.

PRODUCT NO.	FINISH
<b>74R2</b>	<b>-130</b>
	<b>119</b> To match 335 Black Anodized
	<b>121</b> To match 313 Dark Bronze Anodized
	<b>130</b> To match 628 Clear Anodized



Modular Packing Program - match strike body kit with faceplate kit for complete electric strike.  
 Select 7400A for standard jambs and 7401A for radius stile mounting. No finish designation required for strike body kits.

**7400 Series**

**Electric Strike Components**

STRIKE BODY KITS	
<b>7400A</b> Standard body, for use with faceplate kits: FPK7400, FPK7410, FPK7411, FPK7430, FPK7440, FPK7445	\$225.00
<b>7401A</b> Radius body, for use with faceplate kits: FPK7401, FPK7431	\$325.00

Match one strike body kit with one faceplate kit to make a complete electric strike assembly.

FACEPLATE KITS & FINISHES	313, 335, 628	630	605, 606, 629	119, 121,130
<b>FPK7400</b> For use with body kit: 7400A	\$25.00	\$50.00	\$60.00	
<b>FPK7401</b> For use with body kit: 7401A				\$25.00
<b>FPK7410</b> For use with body kit: 7400A	\$55.00	\$80.00		
<b>FPK7411</b> For use with body kit: 7400A, not available in 335 finish	\$60.00	\$85.00		
<b>FPK7430</b> For use with body kit: 7400A	\$30.00			
<b>FPK7431</b> For use with body kit: 7401A				\$30.00
<b>FPK7440</b> For use with body kit: 7400A	\$25.00	\$50.00	\$60.00	
<b>FPK7445</b> For use with body kit: 7400A, not available in 335 finish	\$35.00			

Faceplate kits contain all hardware to mount electric strike.

KITTED OPTIONS	
LEK7400 Lip extension kits for use with 7400 series electric strikes	\$42.00
VA7400-12 12 VDC adapter cable for 7400 electric strikes	\$12.00
VA7400-16VDC 16 VDC adapter kit for 7400 electric strikes	\$19.00
VA7400-24 24 VDC adapter cable for 7400 electric strikes	\$12.00
WDC7400 Wood door cover plate for use when mounting 7400 in the inactive leaf of a wood door pair (to simplify the mortising operation)	\$13.00
ELX ElectroLynx™ Adapter to connect Adams Rite products to the ElectroLynx system	\$31.00

HOW TO ORDER Specify quantity and the following information. Order related products separately.							
PRODUCT NO.	LIP EXTENSIONS (distance from vertical centerline of the door in the closed position to the edge of the jamb)						
<b>LEK7400-</b>	<b>-00</b>						
	<b>01</b> 1-1/2"	<b>03</b> 1-3/4"	<b>05</b> 2"	<b>07</b> 2-1/4"	<b>09</b> 2-1/2"	<b>11</b> 2-3/4"	<b>13</b> 3"
	<b>02</b> 1-5/8"	<b>04</b> 1-7/8"	<b>06</b> 2-1/8"	<b>08</b> 2-3/8"	<b>10</b> 2-5/8"	<b>12</b> 2-7/8"	<b>50</b> 1-3/8"

TRIM

1000

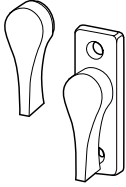

Series Turns

MODELS & FINISHES	119, 121, 130
<b>1000-01, 1000-02</b> Turn for use with MS1847 deadlock	\$26.00
<b>1000-11, 1000-21</b> Turn and escutcheon for use with MS1847 deadlock	\$26.00
<b>1004</b> Turn for use with 5015, 5017 deadlock	\$31.00
<b>1015</b> Turn for use with 5015, 5017 deadlock	\$31.00
<b>1016</b> Outside escutcheon	\$26.00

**HOW TO ORDER** Specify quantity and the following information. Order related products separately.

PRODUCT NO.	TURN TYPE	SPINDLE LENGTH						FINISH
1000	-21	-14			-130			
<p><b>TURN WITHOUT ESCUTCHEON</b> Furnished Unassembled</p> <p> <b>-01</b> Parallel Drive     <b>-02</b> Pencil Drive</p> <p><b>TURN WITH ESCUTCHEON</b> Furnished Assembled</p> <p> <b>-11</b> Parallel Drive     <b>-21</b> Pencil Drive</p>	<b>DASH CHART</b>						<p><b>119</b> To match 335 Black Anodized</p> <p><b>121</b> To match 313 Dark Bronze Anodized</p> <p><b>130</b> To match 628 Clear Anodized</p>	
	NO.	"L"	MM	NO.	"L"	MM		
	-11	17/32	13	-22	1-15/64	31		
	-12	39/64	15	-23	1-19/64	33		
	-13	43/64	17	-24	1-23/64	35		
	-14	47/64	19	-25	1-27/64	36		
	-15	51/64	20	-26	1-31/64	38		
	-16	55/64	22	-27	1-33/64	39		
	-17	59/64	23	-28	1-39/64	41		
	-18	63/64	25	-29	1-43/64	42		
	-19	1-3/64	26	-30	1-47/64	44		
	-20	1-7/64	28	-31	1-51/64	46		
-21	1-11/64	30	-32	1-55/64	47			

3000

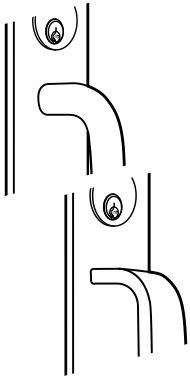

Fixed Pull

MODELS & FINISH	US32D
<b>3001</b> Tubular fixed pull for hollow metal or wood doors	\$194.00
<b>3002</b> Flat fixed pull for hollow metal or wood doors	\$212.00

**HOW TO ORDER** Specify quantity and the following information. Order related products separately.

PRODUCT NO.	HANDLE	CYLINDER HOLE	EXIT DEVICE	FINISH
<b>300</b>	<b>1</b>	<b>-1</b>	<b>1</b>	<b>-US32D</b>
	1 Round	1 Without Hole	1 Mortise, Rim	<b>US32D</b> Satin Stainless
	2 Flat	2 With Hole	2 CVR	
			3 SVR	

Not for use with the following narrow stile exit devices: 8200 SVR, 8400 Mortise, 8600 CVR, 8800 Rim exit devices.

3080

Series Entry Trim

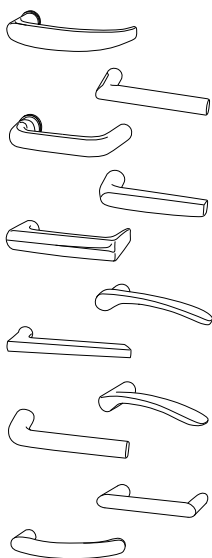

MODELS & FINISHES		STANDARD TRIM		ELECTRIFIED TRIM	
		US32D, 10B	US4, US3, US32	US32D, 10B	US4, US3, US32
STANDARD LEVER	<b>3080</b> Entry trim with standard lever (01, 02, 03)	\$340.00	\$370.00	\$665.00	\$705.00
	<b>3080-M</b> Entry trim with standard lever (01, 02, 03) with matching trim cover finish	\$430.00	\$460.00	\$755.00	\$795.00
	<b>3080-U</b> Entry trim with standard lever (01, 02, 03) with universal trim kit includes tailpieces and trimplates for use with all Adams Rite exit devices	\$365.00	\$395.00	\$690.00	\$730.00
	<b>3080-U, M</b> Entry trim with standard lever (01, 02, 03), matching trim cover and universal trim kit	\$455.00	\$485.00	\$780.00	\$820.00
DESIGNER LEVER	<b>3080-MX</b> Entry trim with designer lever series (MD through MW)	\$385.00	\$415.00	\$710.00	\$750.00
	<b>3080-MX, M</b> Entry trim with designer lever series (MD through MW) with matching trim cover	\$475.00	\$505.00	\$800.00	\$840.00
	<b>3080-MX, U</b> Entry trim with designer lever series (MD through MW) with universal trim kit	\$410.00	\$440.00	\$735.00	\$775.00
	<b>3080-MX, U, M</b> Entry trim with designer lever series (MD through MW), universal trim kit and matching trim cover	\$500.00	\$530.00	\$825.00	\$865.00

Tactile strip now available as a Kitted Option (below) for standard levers 01 and 03.

KITTED OPTIONS		
<b>91-0686</b>	Adaptor kit for 3080 trim and G86 exit device	\$28.00
<b>91-0118</b>	Tactile strip for 3080 standard levers 01, 03	\$36.00

**HOW TO ORDER** Specify quantity and the following information. Order related products separately.

PRODUCT NO.	ELECTRIFIED	HANDLE	HANDING	CYLINDER HOLE	EXIT DEVICE	VOLTAGE	FEATURES	TRIM COVER FINISH	FINISH
<b>3080</b>	<b>E</b>	<b>-01</b>	<b>-0</b>	<b>-3</b>	<b>7</b>	<b>-3</b>	<b>0</b>	<b>M</b>	<b>US32D</b>
(blank) Standard		<b>STANDARD HANDLES</b>	<b>0</b> No Handing	<b>3</b> With Hole	<b>1</b> SVR	<b>ELECTRIFIED TRIM ONLY</b>	<b>ELECTRIFIED TRIM ONLY</b>	- Standard (Black)	<b>US3</b> Bright Brass
<b>E</b> Electrified Trim		<b>01</b> Curve	<b>7</b> Left Hand*	<b>9</b> Without Hole	<b>3</b> Mortise	<b>3</b> 12 Volt DC	<b>0</b> Fail-Secure	<b>M</b> Matching Finish	<b>US4</b> Satin Brass
		<b>02</b> Round	<b>8</b> Right Hand*		<b>4</b> SCVR	<b>5</b> 24 Volt DC	<b>5</b> Fail-Safe		<b>US10B</b> Oil-Rubbed Bronze
		<b>03</b> Square			<b>6</b> CVR				<b>US32</b> Bright Stainless
		<b>DESIGNER SERIES</b>			<b>7</b> Rim				<b>US32D</b> Satin Stainless
		MD MJ			<b>U</b> Universal Kit				
		ME MN* (Handed)							
		MG MV* (Handed)							
		MI MW							

\*Handing must be specified for MN and MV Designer Levers.

## 3090, 3090P/C eForce® Keyless Entry

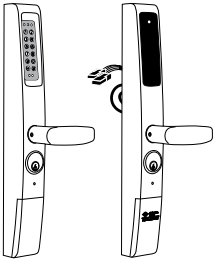

	KEYPAD	PROX	ICLASS
<b>MODELS &amp; FINISHES</b>	<b>626, 121</b>	<b>626, 121</b>	<b>626, 121</b>
For Adams Rite latches or 8000 Series Exit Devices, Yale 7200 series, Corbin Russwin ED4000 series exit devices only	<b>3090-01</b> \$664.00	<b>3090P-01</b> \$909.00	<b>3090C-01</b> \$949.00
For Adams Rite MS® deadlocks	<b>3090-02</b> \$684.00	<b>3090P-02</b> \$929.00	<b>3090C-02</b> \$969.00

### Kitted Options

MODELS	
<b>RSK-3090</b> Remote switch input connector	\$15.00
<b>3090-CABLE</b> 15 ft cable extension (ElectroLynx™ x pigtail) for 3090P/C	\$31.00
<b>3090-CABLE-EL</b> 15 ft cable extension (ElectroLynx™ x ElectroLynx™) for 3090P/C	\$37.00

#### HOW TO ORDER Specify quantity and the following information. Order related products separately.

PRODUCT NO.	COMPATIBLE PRODUCTS	FINISH
<b>3090</b>	<b>-01</b>	<b>-626</b>
	<b>01</b> Adams Rite latches or 8000 Series Exit Devices, Yale 7200 series, Corbin Russwin ED4000 series exit devices only	<b>121</b> To match 313 Dark Bronze Anodized
	<b>02</b> Adams Rite MS® deadlocks	<b>626</b> Satin Chrome

#### HOW TO ORDER Specify quantity and the following information. Order related products separately.

PRODUCT NO.	CREDENTIAL	COMPATIBLE PRODUCTS	FINISH
<b>3090</b>	<b>P</b>	<b>-01</b>	<b>-626</b>
	<b>P</b> 125 kHz HID® Prox	<b>01</b> Adams Rite latches or 8000 Series Exit Devices, Yale 7200 series, Corbin Russwin ED4000 series exit devices only	<b>121</b> To match 313 Dark Bronze Anodized
	<b>C</b> 13.56 MHz HID iCLASS	<b>02</b> Adams Rite MS® deadlocks	<b>626</b> Satin Chrome

## A100-3090H

### Keyless Entry and Aperio® Hub Wholesale Kit

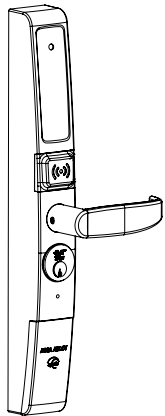

	FOR DEADLATCHES & EXITS	FOR DEADLOCKS
<b>MODELS &amp; FINISHES</b>	<b>121, 626</b>	<b>121, 626</b>
<b>A100-3090HC</b> Keyless entry paired with hub, iCLASS reader	\$1,730.00	\$1,750.00
<b>A100-3090HP</b> Keyless entry paired with hub, PROX reader	\$1,730.00	\$1,750.00

Special pricing program discounts apply to Aperio products. Please contact your sales representative for pricing information.

#### HOW TO ORDER Specify quantity and the following information. Order related products separately.

PRODUCT NO.	CREDENTIAL	COMPATIBLE PRODUCTS	FINISH
<b>A100-3090H</b>	<b>C</b>	<b>-1</b>	<b>-626</b>
	<b>P</b> 125 kHz HID® Prox	<b>1</b> Adams Rite latches or 8000 Series Exit Devices, Yale 7200 series, Corbin Russwin ED4000 series exit devices only (select REX enabled version).	<b>121</b> To match 313 Dark Bronze Anodized
	<b>C</b> 13.56 MHz HID iCLASS	<b>2</b> Adams Rite MS® deadlocks	<b>626</b> Satin Chrome

4060

Turn

MODEL & FINISH	130
4060 Turn for 1875 deadlock, 1-1/2", 1-3/4", or 2" door thickness	\$59.00

**HOW TO ORDER** Specify quantity and the following information. Order related products separately.

PRODUCT NO.	DOOR THICKNESS	FINISH
<b>4060</b>	<b>-05</b>	<b>-130</b>
	05 1-1/2"	130 To match 628 Clear Anodized
	06 1-3/4"	
	07 2"	

Please contact factory regarding mounting spacers, bolts, guides and strikes for particular door designs.

4550

MS® Deadlock Lever



MODEL & FINISHES	119, 121, 130
4550, 01 Deadlock lever, 1-3/4" to 2" door thickness	\$195.00
4550, 02 Deadlock lever, 2-1/8" to 2-3/8" door thickness	\$235.00

**HOW TO ORDER** Specify quantity and the following information. Order related products separately.

PRODUCT NO.	DOOR HAND	DOOR THICKNESS	RITECOAT FINISH
<b>4550</b>	<b>R</b>	<b>-01</b>	<b>-130</b>
	R RH or RHR	01 1-3/4" to 2"	119 To match 335 Black Anodized
	L LH or LHR	02 2-1/8" to 2-3/8"	121 To match 313 Dark Bronze Anodized
			130 To match 628 Clear Anodized

4560, 4565

Series Deadlatch Handles for 4300, 4500, 4900 Deadlatches

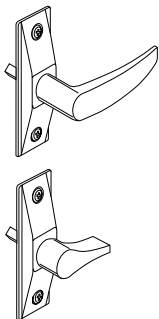

MODELS & FINISHES	119, 121, 130
4560-X01 For door thickness (01) 1-3/4" to 2"	\$51.00
4560-X02 For door thickness (02) 2-1/4" to 2-1/2"	\$71.00
4560-X03 For door thickness (03) 2-3/4" to 3"	\$71.00
4560-X04 For door thickness (04) 3-1/4"	\$71.00
4565-X01 For door thickness (01) 1-3/4" to 2"	\$51.00
4565-X02 For door thickness (02) 2-1/4" to 2-1/2"	\$71.00
4565-X03 For door thickness (03) 2-3/4" to 3"	\$71.00
4565-X04 For door thickness (04) 3-1/4"	\$71.00

## 4560-010, 4565-010

### Series Deadlatch Handles for MS+1890 Deadlock/Deadlatch

MODELS & FINISHES	119, 121, 130
<b>4560-011</b> For door thickness (11) 1-3/4"	\$38.00
<b>4560-012</b> For door thickness (12) 1-3/4" to 2-1/4"	\$48.00
<b>4560-013</b> For door thickness (13) 2-15/16" to 2-3/4"	\$48.00
<b>4565-011</b> For door thickness (11) 1-3/4"	\$38.00
<b>4565-012</b> For door thickness (12) 1-3/4" to 2-1/4"	\$48.00

#### HOW TO ORDER Specify quantity and the following information. Order related products separately.

PRODUCT NO.	HANDLE TYPE	HANDING	DOOR THICKNESS	FINISH
<b>456</b>	<b>0</b>	<b>-5</b>	<b>01</b>	<b>-130</b>
	<b>0</b> Lever	<b>0</b> Using MS+1890	<b>For 4300, 4500, 4900 Series Deadlatches</b>	<b>For MS+1890</b>
	<b>5</b> Turn	<b>5</b> LH or LHR	<b>01</b> 1-3/4" to 2"	<b>11</b> 1-3/4"
		<b>6</b> RH or RHR	<b>02</b> 2-1/4" to 2-1/2"	<b>12</b> 1-3/4" to 2-1/4"
			<b>03</b> 2-3/4" to 3"	<b>13</b> 2-5/16" to 2-3/4"
			<b>04</b> 3-1/4"	
				<b>119</b> To match 335 Black Anodized
				<b>121</b> To match 313 Dark Bronze Anodized
				<b>130</b> To match 628 Clear Anodized

## 4568, 4569

### Eurostyle Deadlatch Handles for 4300, 4500, 4900 Deadlatches

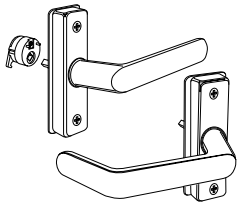

MODELS & FINISHES	119, 121, 130
<b>4568-X01</b> For door thickness (01) 1-3/4" to 2"	\$62.00
<b>4568-X02</b> For door thickness (02) 2-1/4" to 2-1/2"	\$77.00
<b>4568-X03</b> For door thickness (03) 2-3/4" to 3"	\$77.00
<b>4568-X04</b> For door thickness (04) 3-1/4"	\$77.00
<b>4569-X01</b> For door thickness (01) 1-3/4" to 2"	\$70.00
<b>4569-X02</b> For door thickness (02) 2-1/4" to 2-1/2"	\$85.00
<b>4569-X03</b> For door thickness (03) 2-3/4" to 3"	\$85.00
<b>4569-X04</b> For door thickness (04) 3-1/4"	\$85.00

**4568-010,  
4569-010**

**Series Deadlatch Handles for MS+1890 Deadlock/Deadlatch**

MODELS & FINISHES	119, 121, 130
<b>4568-011</b> For door thickness (11) 1-3/4" to 1-15/16"	\$50.00
<b>4568-012</b> For door thickness (12) 2" to 2-1/4"	\$60.00
<b>4568-013</b> For door thickness (13) 2-15/16" to 2-3/4"	\$60.00
<b>4568-014</b> For door thickness (14) 3"	\$60.00
<b>4569-011</b> For door thickness (11) 1-3/4" to 1-15/16"	\$55.00
<b>4569-012</b> For door thickness (12) 2" to 2-1/4"	\$65.00
<b>4569-013</b> For door thickness (13) 2-15/16" to 2-3/4"	\$65.00
<b>4569-014</b> For door thickness (14) 3"	\$65.00

HOW TO ORDER Specify quantity and the following information. Order related products separately.					
PRODUCT NO.	LEVER TYPE	HANDING	DOOR THICKNESS		FINISH
<b>456</b>	<b>8</b>	<b>-5</b>	<b>01</b>		<b>-130</b>
	<b>8</b> Straight	<b>0</b> Using MS+1890	<b>For 4300, 4500, 4900 Series Deadlatches</b>	<b>For MS+1890</b>	<b>119</b> To match 335 Black Anodized
	<b>9</b> Return End	<b>5</b> LH or LHR	<b>01</b> 1-3/4" to 2"	<b>11</b> 1-3/4" to 1-15/16"	<b>121</b> To match 313 Dark Bronze Anodized
		<b>6</b> RH or RHR	<b>02</b> 2-1/4" to 2-1/2"	<b>12</b> 2" to 2-1/4"	<b>130</b> To match 628 Clear Anodized
			<b>03</b> 2-3/4" to 3"	<b>13</b> 2-5/16" to 2-3/4"	
			<b>04</b> 3-1/4"	<b>14</b> 3"	

4590

**Deadlatch Paddle for 4300, 4500, 4900 Deadlatches**

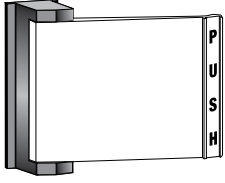

MODELS & FINISHES	313, 335, 628
4590-0X-00 For door thickness (00) 1-3/4"	\$102.00
4590-0X-01 For door thickness (01) 1-13/16" to 2"	\$122.00
4590-0X-02 For door thickness (02) 2-1/4" to 2-1/2"	\$122.00
4590-0X-03 For door thickness (03) 2-3/4" to 3"	\$122.00
4590-0X-04 For door thickness (04) 3-1/4"	\$122.00

4590-1X

**Deadlatch Paddle for MS+1890, 2190 Deadlocks**

MODELS & FINISHES	313, 335, 628
4590-1X-00 For door thickness (00) 1-3/4"	\$86.00
4590-1X-01 For door thickness (01) 1-3/4" to 2-1/4"	\$106.00
4590-1X-02 For door thickness (02) 2-5/16" to 2-1/2"	\$106.00
4590-1X-03 For door thickness (03) 2-9/16" to 2-3/4"	\$106.00

**HOW TO ORDER** Specify quantity and the following information. Order related products separately.

PRODUCT NO.	OPERATION		DOOR THICKNESS		FINISH*	
<b>4590</b>	<b>02</b>		<b>-00</b>		<b>-313</b>	
	<b>FIRST DASH FOR LATCH SERIES</b>	<b>OPERATION</b>	<b>USE</b>	<b>For 4300, 4500, 4900 Series Deadlatches</b>	<b>For MS+1890, 2190</b>	<b>313 Dark Bronze Anodized</b>
	-01 4300/4500/4900	<b>PULL TO LEFT</b> 	Outside of left hand reverse door or inside of right hand	00 1-3/4"	00 1-3/4"	335 Black Anodized
	-11 MS+1890/2190			01 1-13/16" to 2"	01 1-3/4" to 2-1/4"	628 Clear Anodized
	-02 4300/4500/4900	<b>PUSH TO LEFT</b> 	Outside of left hand door or inside of right hand reverse	02 2-1/4" to 2-1/2"	02 2-5/16" to 2-1/2"	
	-12 MS+1890/2190			03 2-3/4" to 3"	03 2-9/16" to 2-3/4"	
	-03 4300/4500/4900	<b>PULL TO RIGHT</b> 	Outside of right hand reverse door or inside or left hand	04 3-1/4"		
	-13 MS+1890/2190					
	-04 4300/4500/4900	<b>PUSH TO RIGHT</b> 	Outside of right hand door or inside of left hand reverse			
	-14 MS+1890/2190					
	<b>LH</b> 					
	<b>RH</b> 					
	<b>LHR</b> 					
	<b>RHR</b> 					

\*Finish applied to paddle assembly only, not escutcheon.



4591

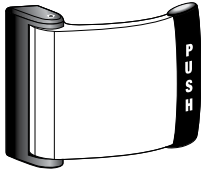

**Deadlatch Paddle for 4300, 4500, 4900 Deadlatches**

MODELS & FINISHES	313, 335, 628	US3, US26D
<b>4591-0X-00</b> For door thickness (00) 1-3/4"	\$122.00	\$230.00
<b>4591-0X-01</b> For door thickness (01) 1-13/16" to 2"	\$142.00	\$250.00
<b>4591-0X-02</b> For door thickness (02) 2-1/4" to 2-1/2"	\$142.00	\$250.00
<b>4591-0X-03</b> For door thickness (03) 2-3/4" to 3"	\$142.00	\$250.00
<b>4591-0X-04</b> For door thickness (04) 3-1/4"	\$142.00	\$250.00

4591-1X

**Deadlatch Paddle for MS+1890, 2190 Deadlocks**

MODELS & FINISHES	313, 335, 628	US3, US26D
<b>4591-1X-00</b> For door thickness (00) 1-3/4"	\$105.00	\$215.00
<b>4591-1X-01</b> For door thickness (01) 1-3/4" to 2-1/4"	\$125.00	\$235.00
<b>4591-1X-02</b> For door thickness (02) 2-5/16" to 2-1/2"	\$125.00	\$235.00
<b>4591-1X-03</b> For door thickness (03) 2-9/16" to 2-3/4"	\$125.00	\$235.00
MODELS		
<b>4591MA</b> Active paddle, latch activator with monitor switch	Add \$116.00	
<b>4591M</b> Paddle with switch, no latch activator	Add \$99.00	
<b>91-0914</b> Monitor switch kit for 4591, field installation	\$106.00	

**HOW TO ORDER** Specify quantity and the following information. Order related products separately.

PRODUCT NO.	OPTIONS**	OPERATION		DOOR THICKNESS		FINISH*	
4591	M	02		-00		-313	
- Standard Paddle	FIRST DASH FOR LATCH SERIES	OPERATION	USE	For 4300, 4500, 4900 Series Deadlatches	For MS+1890, 2190	313 Dark Bronze Anodized	
M Paddle w/ switch only	-01 4300/4500/4900	PULL TO LEFT		Outside of left hand reverse door or inside of right hand	00 1-3/4"	00 1-3/4"	335 Black Anodized
MA Active paddle w/ switch	-11 MS+1890/2190	PUSH TO LEFT		Outside of left hand door or inside of right hand reverse	01 1-13/16" to 2"	01 1-3/4" to 2-1/4"	628 Clear Anodized
	-02 4300/4500/4900				02 2-1/4" to 2-1/2"	02 2-5/16" to 2-1/2"	US3 Bright Brass
	-12 MS+1890/2190	PULL TO RIGHT		Outside of right hand reverse door or inside or left hand	03 2-3/4" to 3"	03 2-9/16" to 2-3/4"	US26D Satin Chrome
	-03 4300/4500/4900				04 3-1/4"		
	-13 MS+1890/2190	PUSH TO RIGHT		Outside of right hand door or inside of left hand reverse			
	-04 4300/4500/4900						
	-14 MS+1890/2190						

\*Finish applied to paddle assembly only, not escutcheon. \*\*M and MA options available on push paddles only, not pull paddles.

## 4600 Heavy Duty Designer Deadlatch Handles

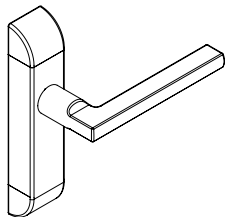

MODELS & FINISHES		LEVER OPERATOR FOR 4300, 4500, 4900 SERIES DEADLATCHES		LEVER OPERATOR FOR 2190, 2290 INTERCONNECTED DEADBOLT/DEADLATCH	
		10B, US32D	US3, US4, US32	10B, US32D	US3, US4, US32
STANDARD LEVER	<b>4600</b> Trim with standard lever (01, 02, 03)	\$130.00	\$155.00	\$115.00	\$140.00
	<b>4600-M</b> Trim with standard lever (01, 02, 03) with form 'C' switch option to indicate when lever is actuated	\$180.00	\$205.00	\$165.00	\$190.00
	<b>4600-Thick Door</b> Trim with standard lever (01, 02, 03) for door thickness greater than 1-7/8"	\$150.00	\$175.00	\$135.00	\$160.00
DESIGNER LEVER	<b>4600-MX</b> Trim with designer lever series (MD through MW)	\$175.00	\$200.00	\$160.00	\$185.00
	<b>4600-MX, M</b> Trim with designer lever series (MD through MW) with form 'C' switch option	\$225.00	\$250.00	\$210.00	\$235.00
	<b>4600-MX, Thick Door</b> Trim with designer lever series (MD through MW) for door thickness greater than 1-7/8"	\$195.00	\$220.00	\$180.00	\$205.00

### KITTED OPTIONS

<b>REX-4600</b> Request to exit kit	\$37.00
<b>DTK-4600</b> Fixed lever (dummy) kit	\$11.00
<b>TDK-4600-XX</b> Thick door kit. Specify door thickness.*	\$21.00
<b>TBK-4600-XX</b> Through-bolt mounting kit for back-to-back mounting on wood doors. Specify door thickness.*	\$26.00

\*For door thickness (01) 1-3/4", (02) 2", (03) 2-1/4", (04) 2-1/2" and (05) 2-3/4".

### HOW TO ORDER

Specify quantity and the following information. Order related products separately.

PRODUCT NO.	REX	HANDLE	HANDING**	DOOR THICKNESS	COMPATIBLE PRODUCTS	FINISH
<b>4600</b>	<b>M</b>	<b>-01</b>	<b>-5</b>	<b>1</b>	<b>1</b>	<b>-32D</b>
	(blank) Standard	<b>STANDARD HANDLES</b>	5 LH or LHR	1 1-3/4" to 1-7/8"	1 2190, 2290 Interconnected Deadbolt/Deadlatch	<b>US3</b> Bright Brass
	<b>M</b> Switch Option	<b>01</b> Curve	6 RH or RHR	2 2" to 2-1/8"	2 4300, 4500, 4900 Series Deadlatches	<b>US4</b> Satin Brass
		<b>02</b> Round		3 2-1/4" to 2-3/8"		<b>US10B</b> Oil-Rubbed Bronze
		<b>03</b> Square		4 2-1/2" to 2-5/8"		<b>US32</b> Bright Stainless
		<b>DESIGNER SERIES</b>		5 2-3/4" to 2-7/8"		<b>US32D</b> Satin Stainless
		MD MJ				
		ME MN* (Handed)				
		MG MV* (Handed)				
		MI MW				

\*Handing must be specified for MN and MV Designer Levers.

\*\*Handing - assuming lever on interior of door.

CYLINDERS

4024, 4025, 4026

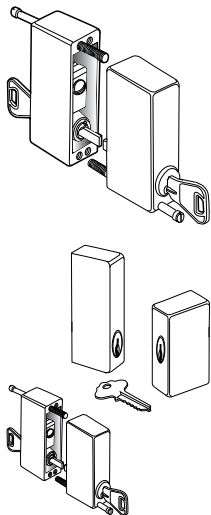

Cylinder Pulls

MODELS & FINISHES	119, 121, 130
4024-05 Cylinder pull, Schlage keyway	\$58.00
4024-06 Cylinder pull, Weiser keyway	\$58.00
4025-05 Cylinder pull, Schlage keyway	\$62.00
4025-06 Standard cylinder pull, Weiser keyway	\$62.00
4025-06, cyl x cyl Cylinder both sides pullset, Weiser keyway	\$124.00
4026-05 Cylinder pull for use with 5015, 5017 deadlock, Schlage keyway	\$66.00
4026-06 Cylinder pull for use with 5015, 5017 deadlock, Weiser keyway	\$66.00

Please contact factory for special cylinder requirements.

HOW TO ORDER Specify quantity and the following information. Order related products separately.		
PULL TYPE	PULL NO./CYLINDER INCLUDED	FINISH
<b>4024</b>	<b>-05</b>	<b>-130</b>
4024 Trim Plate Mounted	05 Schlage "C" Keyway	119 To match 335 Black Anodized
4025 Stile Mounted with through - screws	06 Weiser Keyway	121 To match 313 Dark Bronze Anodized
4026 For Wood Applications		130 To match 628 Clear Anodized

4036

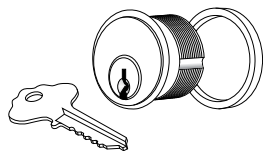

Mortise Cylinder

MODEL & FINISHES	313, 335, 628
4036 2 keys and 1/4" ring, KD, KA2, KA50 only	\$40.00
For 3300, 3600, 8300, 8400, 8600, or entry trim. Five pin. Can be installed directly in latch case of 8400, 8300, or 3300.	

HOW TO ORDER Specify quantity and the following information. Order related products separately.			
PRODUCT NO.	LOCK TYPE	KEY OPTIONS	FINISH
<b>4036</b>	<b>-01</b>	<b>-01</b>	<b>-628</b>
	01 For MS Lock, 4900 Deadlatches, 2190, etc.	01 Keyed different	313 Dark Bronze Anodized
	02 For 4070 Deadlock	02 Keyed alike in pairs	335 Black Anodized
	03 For 2331 Deadlock		628 Clear Anodized

Keyed alike 50 are available by special order in quantity of 50 cylinders only. Please contact factory for ordering information.

## MS4043

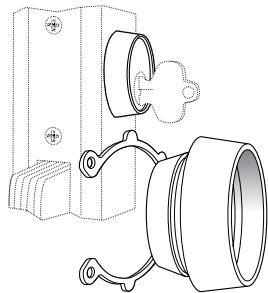

## Cylinder Guard

MODELS & FINISHES	119, 121, 130
<b>MS4043-00</b> Cylinder guard, 1/8" stile wall, 5 or 6 pin cylinder	\$35.00
<b>MS4043-01</b> Cylinder guard, 1/4" stile wall, 5 or 6 pin cylinder	\$40.00
<b>MS4043-02</b> Cylinder guard, 1/8" stile wall, 1-5/16" to 1-7/16" long cylinder	\$55.00

**HOW TO ORDER** Specify quantity and the following information. Order related products separately.

PRODUCT NO.	STILE WALL & CYLINDER	FINISH	
<b>MS4043</b>	<b>-01</b>	<b>-130</b>	
	<b>STILE WALL</b>	<b>CYLINDER</b>	<b>119</b> To match 335 Black Anodized
	<b>00</b> 1/8"	5 or 6 pin	<b>121</b> To match 313 Dark Bronze Anodized
	<b>01</b> 1/4"	5 or 6 pin	<b>130</b> To match 628 Clear Anodized
	<b>02</b> 1/8"	1-5/16" to 1-7/16" long	

## 4066

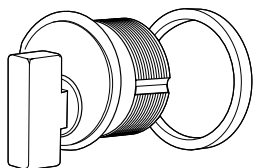

## Thumbturn

MODEL & FINISHES	130, 313, 335
<b>4066</b> Thumbturn cylinder with 1/4" ring	\$42.00

**HOW TO ORDER** Specify quantity and the following information. Order related products separately.

PRODUCT NO.	LOCK TYPE	FINISH	
<b>4066</b>	<b>-01</b>	<b>-130</b>	
	<b>01</b> For MS Lock, 4900 Deadlatches, 2190, etc	<b>130</b> To match 628 Clear Anodized	
	<b>02</b> For 4070 Deadlock	<b>313</b> Dark Bronze Anodized	
	<b>03</b> For 2331 Deadlock	<b>335</b> Black Anodized	

## 4580

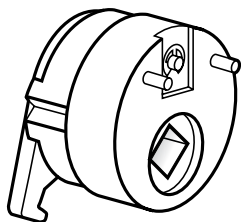

## Cam Disc

MODELS	
<b>4580-X00, 4580-X01</b> Included with lever handles, door thickness 2" or less	\$16.00
<b>4580-X02, 4580-X03</b> Included with lever handles, door thickness greater than 2"	\$24.00

**HOW TO ORDER** Specify quantity and the following information. Order related products separately.

PRODUCT NO.	HANDING	DOOR THICKNESS	
<b>4580</b>	<b>-5</b>	<b>00</b>	
	<b>5</b> LH	<b>00</b> 1-3/4"	
	<b>6</b> RH	<b>01</b> 2"	
		<b>02</b> 2-1/4"	
		<b>03</b> 2-3/4"	

**4581**

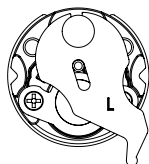

**Universal Cam Disc**

MODELS	
<b>4581-01-IP</b> Universal cam disc, non-handed, for 1-3/4" door thickness (included in 4600)	\$23.00
<b>4581-02-IP</b> Universal cam disc, non-handed, for 2" door thickness	\$31.00
<b>4581-03-IP</b> Universal cam disc, non-handed, for 2-1/4" door thickness	\$31.00

**HOW TO ORDER** Specify quantity and the following information. Order related products separately.

PRODUCT NO.	DOOR THICKNESS
<b>4581</b>	<b>01</b>
	01 1-3/4"
	02 2"
	03 2-1/4"

**8650**

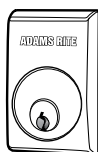

**Cylinder Escutcheon Kit**

MODELS & FINISHES	119, 121, 130	313, 335, 628	US4, US32D	US3, US32
<b>8650</b> Cylinder escutcheon kit for 3600, 8500, 8600 exit devices	\$34.00	\$59.00	\$67.00	\$77.00
<b>8650</b> For wall thickness over 1/8" *	\$64.00	\$89.00	\$97.00	\$107.00

\*Please contact factory for wall thickness greater than 1/8"

**8736**

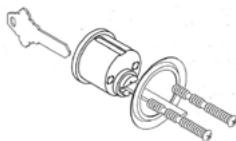

**Rim Cylinder**

MODEL & FINISHES	313, 335, 628
<b>8736</b> Rim cylinder for use with 3100, 3700, 8100, 8200, 8700, 8800 exit devices. Five pin.	\$44.00

**ACCESSORIES**

**4014**

**Two-Point Conversion Kit**

MODEL	
<b>4014-01</b> Two-point conversion kit for MS1861 Bottom Rail Deadbolt	\$35.00

**4015**

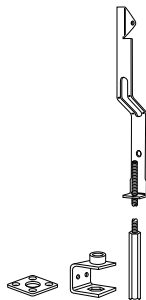

**Threshold Bolt**

MODEL & FINISHES	603
<b>4015-18-IB</b> Two-point converter, threshold bolt, standard cylinder height.	\$42.00
<b>4015-XX-IB</b> Two-point converter, threshold bolt, specify cylinder height greater than 53", 60" maximum.	\$64.00

**HOW TO ORDER** Specify quantity and the following information. Order related products separately.

PRODUCT NO.	ADD DASH NUMBER FOR "UNIVERSAL SIZE"	PACKAGING
<b>4015</b>	<b>-18</b>	<b>-IB</b>
		IB Individually Boxed

Please specify cylinder height if ordering in volume quantity for a specific cylinder height.

## 4016

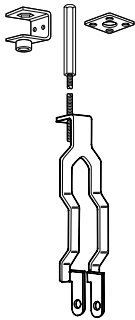

## Header Bolt

## MODEL

**4016** Three-point converter, provides upper bolt for MS1850/1870 Deadlocks

\$54.00

**HOW TO ORDER** Specify quantity and the following information. Order related products separately.

PRODUCT NO.	LOCK BACKSET	DOOR HEIGHT
<b>4016</b>	<b>-30</b>	<b>-01</b>
	10 1-1/2"	01 7' Door
	20 31/32"	02 10' Door
	30 1-1/8"	

## 4085

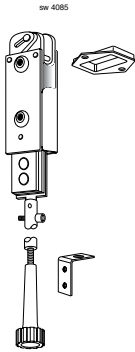

## Header Bolt (Pairs of Doors Only)

## MODELS &amp; FINISHES

**4085-01-IB** Positioner bolt and header strike, specify cylinder height for 7' door height

\$82.00

**4085-02-IB, 4085-03-IB, 4085-04-IB** Positioner bolt and header strike, specify cylinder height for door height greater than 7', door height 10' maximum. Contact factory for door height greater than 7'.

\$102.00

**HOW TO ORDER** Specify quantity and the following information. Order related products separately.

PRODUCT NO.	DIMENSION 'A'	PACKAGING	EXAMPLE			
<b>4085</b>	<b>-02</b>	<b>-IB</b>	<b>Door Height</b>	<b>Cylinder Height</b>	<b>=</b>	<b>A</b>
	01 30" - 52"	IB Individually Boxed	96"	-	40"	= 56"
	02 52" - 67"					
	03 67" - 79"					
	04 79" - 92"					

REFERENCE:  
 7' Door is 84"  
 8' Door is 96"  
 9' Door is 108"  
 10' Door is 120"

## 4089

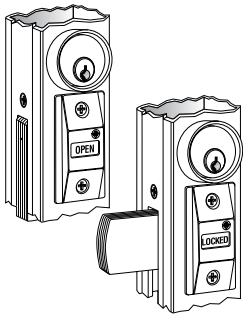

## Exit Indicator

## MODELS &amp; FINISHES

**4089-00, 4089-01** Indicator for 1-3/4" door, includes both UBC and IBC signs

**119, 121, 130**

\$52.00

**4089-20** Indicator for 2" to 2-1/2" door, includes both UBC and IBC signs

\$87.00

## ACCESSORIES

**91-0912** Adapter plate for converting MS1850/4089 installation to deadlatch and lever handle or paddle. Select 121 or 130 finish.

\$31.00

**20-0255-IP** Header sign "...During Business Hours"

\$7.00

**20-0256-IP** IBC header sign "...Building is Occupied"

\$7.00

**HOW TO ORDER** Specify quantity and the following information. Order related products separately.

	OPTIONS	FINISH
<b>4089</b>	<b>-01</b>	<b>-130</b>
	00 Standard 1-3/4" Door	119 To match 335 Black Anodized
	01 For Inverted Lock	121 To match 313 Dark Bronze Anodized
	20 For Doors up to 2-1/2"	130 To match 628 Clear Anodized

4104

**Mounting Bridges**

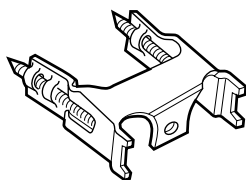

MODELS		
4104-01	Radius mounting bridge	\$9.00
4104-02	Flat mounting bridge	\$9.00
4104-03	Left hand bevel mounting bridge	\$9.00
4104-04	Right hand bevel mounting bridge	\$9.00

91-0965

**Universal Mounting Tab Kits for Installing MS® Locks & Latches**

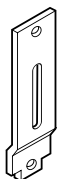

MODELS		
91-0965	Mounting tab kits for flat/radius stiles	\$14.00
91-0966	Mounting tab kits for beveled stiles, includes tabs for right hand and left hand bevel doors and mounting screws for clear and dark bronze.	\$14.00

**STRIKES**

2190

**Dual Force® Interconnected Deadbolt/Deadlatch Strikes**

MODELS & FINISHES	630	119, 121
2101-01 Standard flat strike with dust box	\$25.00	\$31.00
2101-02 Standard radius strike with dust box	\$25.00	\$31.00
2101-XX Strike with extended lip, 4.5" only, flat strike. Not available in 119 finish.	\$40.00	\$46.00
2102-01 Retrofit strike extended height 7-5/8" with dust box. Not available in 119 finish.	\$37.00	\$43.00

2290

**Dual Force® Interconnected Deadbolt/Deadlatch Strikes**

MODELS & FINISHES	630	119, 121
2206-01 Standard flat strike with dust box	\$25.00	\$31.00
2206-XX Strike with extended lip, specify dimension from strike centerline to frame face, to 4.5" maximum, flat strike only	\$40.00	

## 4000 Series

## Series MS® Deadlock Strikes

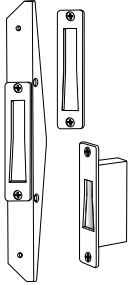

MODELS & FINISHES	630	313, 335, 628	US3, US26D	119, 121
<b>4000</b> Trim Strike		\$25.00		
<b>4001</b> Box Strike		\$25.00	\$45.00	
<b>MS4002</b> Armored Strike		\$52.00	\$72.00	
<b>4003</b> ANSI strike, available in 121 or US26D only			\$65.00	\$65.00
<b>4005</b> Strike for 4015 Threshold Bolt	\$18.00			
<b>4006</b> Strike for 1830 Bottom Rail Deadlock, also available in 130 finish	\$41.00			\$47.00
<b>4009-01</b> Open back strike for 3300, 8300 Series Mortise Exit Device	\$134.00			
<b>4170</b> Trim strike for 4070 Short Throw Deadbolt, not available in 335 finish		\$25.00		
<b>4505-01</b> Flat armored box strike for MS+1891 Deadlock/Deadlatch	\$45.00			\$51.00
<b>4505-02</b> Radius armored box strike for MS+1891 Deadlock/Deadlatch	\$45.00			\$51.00
<b>4505-17, 4505-21</b> Flat long lip armored box strike	\$57.00			\$63.00

**HOW TO ORDER** Specify quantity and the following information. Order related products separately.

STRIKE MODEL	TRIM PLATE SHAPE	COMPATIBLE DEADLOCK	TRIM PLATE CORNERS	FINISH
<b>4001</b>	<b>-0</b>	<b>1</b>	<b>1</b>	<b>-313</b>
<b>4000</b> Trim Strike	<b>0</b> Flat	<b>1</b> All Standard MS® locks with 1-3/8" Bolt Throw	<b>1</b> Square	<b>313</b> Dark Bronze Anodized
<b>4001</b> Box Strike	<b>1</b> Radius	<b>2</b> 1850A-020 with 3/4" Bolt Throw Only	<b>2</b> Round	<b>335</b> Black Anodized
<b>MS4002</b> Armored Strike		<b>3</b> All MS-050 "Hookbolt" locks		<b>628</b> Clear Anodized

## 4800, MS4804

## Series Strikes

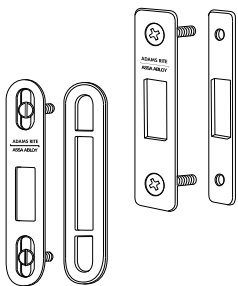

MODELS & FINISHES	603	630
<b>MS4804-10-630</b> Reinforcing strike and screws, two-part with reinforcement for strengthening metal jamb		\$18.00
<b>4801</b> Metal strike, specify dash number indicating shim quantity	\$14.00	\$21.00
<b>4802</b> Wood strike, specify dash number indicating shim quantity	\$14.00	\$21.00
<b>4810-01, 4810-02</b> Box strike for 5017 Wood Door Deadlock/Deadlatch	\$14.00	

**HOW TO ORDER** Specify quantity and the following information. Order related products separately.

PRODUCT NO.	TYPE OF JAMB	DIMENSION 'A'	FINISH
<b>480</b>	<b>1</b>	<b>-02</b>	<b>-630</b>
	<b>1</b> Metal	<b>01</b> 3/32"	<b>603</b> Zinc Plated Steel
	<b>2</b> Wood	<b>02</b> 3/16"	<b>630</b> Satin Stainless
		<b>03</b> 9/32"	



4901, 4902

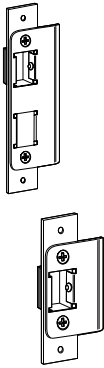

Deadlatch Strikes

MODELS & FINISHES	630	119, 121
4901-01 Flush mount flat strike, mortised with dust box	\$15.00	\$21.00
4901-02 Flush mount radius strike, mortised with dust box	\$15.00	\$21.00
4901-XX Extended lip strike, specify lip dim 'A', 2.5" maximum*	\$35.00	\$41.00
4902-01 Short box strike, flat with dust box, mounting plate	\$15.00	\$21.00
4902-02 Short type box strike, radius with dust box, mounting plate	\$15.00	\$21.00
4902-XX Extended lip strike, specify lip dim 'A', 2.5" maximum*	\$35.00	\$41.00
4506 Strike for use with 4920AN, not available in 119 finish	\$35.00	\$41.00

\*See dim. 'A' dash chart table below.

HOW TO ORDER Specify quantity and the following information. Order related products separately.						
PRODUCT NO.	STRIKE TYPE	FACEPLATE SHAPE				FINISH
490	1	-02				630
		STANDARD LIP				119 To match 335 Black Anodized
	1 Long	01 Flat				121 To match 313 Dark Bronze Anodized
	2 Short	02 Radius				630 Satin Stainless Steel
		LONG LIP FOR CENTER HUNG DOOR	DIM. 'A'	LONG LIP FOR CENTER HUNG DOOR	DIM. 'A'	
		03 2-1/4" Wide Jamb	1-1/8	13 3-1/2" Wide Jamb	1-3/4	
		05 2-1/2" Wide Jamb	1-1/4	15 3-3/4" Wide Jamb	1-7/8	
		07 2-3/4" Wide Jamb	1-3/8	17 4" Wide Jamb	2	
		09 3" Wide Jamb	1-1/2	19 4-1/4" Wide Jamb	2-1/8	
		11 3-1/4" Wide Jamb	1-5/8	21 4-1/2" Wide Jamb	2-1/4	

4304

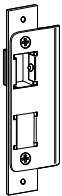

Deadlatch Strike

MODEL & FINISHES	630	119, 121
4304 Surface mount strike for 4300 Electrified Deadlatch	\$19.00	\$25.00

THICK DOOR KITS

2190, 2290

Dual Force® Interconnected Deadbolt/Deadlatch Thick Door Kit

MODELS	
2190-TDK-XX Thick door kit for 2190, 2290 standard exterior trim set. Specify door thickness.*	\$60.00
TDK-4600-XX Thick door kit for 2190, 2290 low profile trim set. Specify door thickness.*	\$21.00

\*For door thickness (01) 1-3/4", (02) 2", (03) 2-1/4", (04) 2-1/2", (05) 2-3/4", (06) 3", (07) 3-1/4".

## 4568, 4569

## Eurostyle Deadlatch Handle Thick Door Kits

## MODELS

91-0128-02, 91-0128-03, 91-0128-04 Thick door kits for 4568, 4569	\$16.00
26-0203-01, 26-0203-02, 26-0203-03 Thick door kits for 4568-11, 4569-11	\$16.00

## FACEPLATES

## MS1850S

## Deadlock Faceplates

## MODELS &amp; FINISHES

313, 628

BFK-MS1850-10 Blank faceplate kit, flat, 1" x 6-7/8"	\$21.00
BFK-MS1850-11 Blank faceplate kit, radius, 1" x 6-7/8"	\$21.00

MS1850S,  
MS1950

## Deadlock (Standard Bolt) Faceplates

## MODELS &amp; FINISHES

313, 335, 628

US4, US26D

US3, US26

24-0384-010 Flat faceplate	\$7.00	\$28.00	\$32.00
24-0384-110 Radius faceplate	\$7.00	\$28.00	\$32.00
24-0384-210 Left hand bevel faceplate	\$7.00	\$28.00	\$32.00
24-0384-310 Right hand bevel faceplate	\$7.00	\$28.00	\$32.00
24-0384-410 Radius with weatherstrip	\$10.00		
<b>SPECIAL MODELS</b>	<b>313, 628</b>		
24-0384-110-313-B100, 24-0384-110-628-B100 Radius faceplates, bulk package of 100 units	\$560.00		
24-0384-210-313-B100, 24-0384-210-628-B100 Left hand bevel faceplates, bulk package of 100 units	\$560.00		
24-0384-310-313-B100, 24-0384-310-628-B100 Right hand bevel faceplates, bulk package of 100 units	\$560.00		
24-0384-410-313-B100, 24-0384-410-628-B100 Radius with weatherstrip faceplates, bulk package of 100 units	\$800.00		

Please note that all 100 faceplates in the bulk package are of the same finish.

**MS1850S,  
MS1950****Deadlock (Hookbolt and Short Bolt) Faceplates**

MODELS & FINISHES	313, 335, 628	US4, US26D	US3, US26
24-0384-020 Flat faceplate	\$7.00	\$28.00	\$32.00
24-0384-120 Radius faceplate	\$7.00	\$28.00	\$32.00
24-0384-220 Left hand bevel faceplate	\$7.00	\$28.00	\$32.00
24-0384-320 Right hand bevel faceplate	\$7.00	\$28.00	\$32.00
24-0384-420 Radius with weatherstrip	\$10.00		
SPECIAL MODELS	313, 628		
24-0384-020-313-B100, 24-0384-020-628-B100 Flat faceplates, bulk package of 100 units	\$560.00		
24-0384-120-313-B100, 24-0384-120-628-B100 Radius faceplates, bulk package of 100 units	\$560.00		
24-0384-220-313-B100, 24-0384-220-628-B100 Left hand bevel faceplates, bulk package of 100 units	\$560.00		
24-0384-320-313-B100, 24-0384-320-628-B100 Right hand bevel faceplates, bulk package of 100 units	\$560.00		
24-0384-420-313-B100, 24-0384-420-628-B100 Radius with weatherstrip faceplates, bulk package of 100 units	\$800.00		

Please note that all 100 faceplates in the bulk package are of the same finish.

**MS1850SN****Deadlock (Standard Bolt) Faceplates**

MODELS & FINISHES	313, 335, 628	US4, US26D	US3, US26
24-0226-010 Flat faceplate	\$9.00	\$30.00	\$34.00
24-0226-110 Radius faceplate	\$9.00	\$30.00	\$34.00
24-0226-210 Left hand bevel faceplate	\$9.00	\$30.00	\$34.00
24-0226-310 Right hand bevel faceplate	\$9.00	\$30.00	\$34.00

**MS1850SN****Deadlock (Hookbolt) Faceplates**

MODELS & FINISHES	313, 335, 628	US4, US26D	US3, US26
24-0226-020 Flat faceplate	\$9.00	\$30.00	\$34.00
24-0226-120 Radius faceplate	\$9.00	\$30.00	\$34.00
24-0226-220 Left hand bevel faceplate	\$9.00	\$30.00	\$34.00
24-0226-320 Right hand bevel faceplate	\$9.00	\$30.00	\$34.00

**1870****Flushbolt Faceplates**

MODELS & FINISHES	313, 335, 628
24-0168-00 Flat faceplate	\$14.00
24-0168-01 Radius faceplate	\$14.00
24-0168-02 Left hand bevel faceplate	\$14.00
24-0168-03 Right hand bevel faceplate	\$14.00
24-0168-04 Radius with weatherstrip	\$17.00



P 800.872.3267 • F 800.232.7329  
 E [orders.adamsrite@assaabloy.com](mailto:orders.adamsrite@assaabloy.com)  
 10027 S. 51st Street, Ste 102  
 Phoenix, Arizona 85044  
[www.adamsrite.com](http://www.adamsrite.com)

## MS+1890

## Deadlock Faceplates

MODELS & FINISHES	313, 335, 628
24-0270-020 Flat faceplate	\$9.00
24-0270-120 Radius faceplate	\$9.00
24-0270-220 Left hand bevel faceplate	\$9.00
24-0270-320 Right hand bevel faceplate	\$9.00
24-0270-420 Radius with weatherstrip	\$12.00

## 2190

## Dual Force® Interconnected Deadbolt/Deadlatch Faceplates

MODELS & FINISHES	313, 628
91-0266-01-313-IP, 91-0266-01-628-IP Flat faceplate and radius faceplate kit for aluminum (2190)	\$36.00
91-0266-04-313-IP, 91-0266-04-628-IP Flat faceplate and radius faceplate kit for wood or hollow metal (2290)	\$36.00

## 2331

## Heavy Duty Deadbolt Faceplates

MODELS & FINISHES	121	US26D	US3
22-0170 Flat faceplate	\$36.00	\$36.00	\$40.00
22-0032 Strike plate	\$36.00	\$36.00	\$40.00

## 3300

## Fire-Rated Mortise Exit Device Faceplates

MODEL & FINISHES	335, 628
24-0015-020 Flat faceplate	\$9.00

## 4070

## Short Throw Deadbolt Faceplates

MODELS & FINISHES	313, 335, 628
24-0136-00 Flat faceplate	\$9.00
24-0136-10 Radius faceplate	\$9.00
24-0136-20 Left hand bevel faceplate	\$9.00
24-0136-30 Right hand bevel faceplate	\$9.00

## 4500

## Standard Duty Deadlatch Faceplates

MODELS & FINISHES	313, 335, 628
24-0017-0220 Flat faceplate	\$7.00
24-0017-1220 Radius faceplate	\$7.00
24-0017-2220 Left hand bevel faceplate	\$7.00
24-0017-3220 Right Hand bevel faceplate	\$7.00
24-0017-4220 Radius with weatherstrip	\$10.00
SPECIAL MODELS	628
24-0017-1220-628B100 Radius faceplates, bulk package of 100 units	\$560.00

Please note that all 100 faceplates in the bulk package are of the same finish.

## 4530

## Standard Duty Deadlatch Faceplates

MODELS & FINISHES	313, 335, 628
24-0016-020 Flat faceplate	\$12.00
24-0016-120 Radius faceplate	\$12.00
24-0016-220 Left hand bevel faceplate	\$12.00
24-0016-320 Right hand bevel faceplate	\$12.00

## 4900

## Heavy Duty Deadlatch Faceplates

MODELS & FINISHES	313, 335, 628	US4, US26D	US3, US26
24-0137-01 Flat or bevel faceplate	\$7.00	\$28.00	\$32.00
24-0137-02 Radius faceplate	\$7.00	\$28.00	\$32.00
24-0137-03 Radius with weatherstrip	\$10.00		

## 4900

## Heavy Duty Deadlatch Special Faceplates

MODELS & FINISHES	313, 628
24-0140 Radius with weatherstrip seal (1-1/8" x 6-7/8")	\$15.00
24-0144-01 Flat or beveled doors (1-1/8" x 7-1/4")	\$12.00
24-0144-03 Radius with weatherstrip (1-1/8" x 7-1/4")	\$15.00

## 4920, 8300

## Faceplates

MODEL & FINISHES	313, 335, 628
24-0138-01 Flat or bevel faceplate	\$21.00

## 7100, 7160

## Electric Strike Faceplates

MODEL & FINISHES	313, 335, 628
24-0685-01 Round corner faceplate (1-1/4" x 4-7/8")	\$10.00

## 7101

## Electric Strike Faceplates

MODEL & FINISHES	313, 335, 628
24-0685-02 Radius faceplate (1-1/4" x 4-7/8")	\$10.00

## 7110

## Electric Strike Faceplates

MODEL & FINISH	652
22-0558 Round corner faceplate (1-7/16" x 7-15/16")	\$17.00

## 7111

## Electric Strike Faceplates

MODEL & FINISH	652
22-0557 Round corner faceplate (1-7/16" x 10-1/4")	\$21.00

**7130 Electric Strike Faceplates**

MODEL & FINISHES	313, 335, 628
24-0686-01 Round corner faceplate (1-1/4" x 6-7/8")	\$15.00

**7131 Electric Strike Faceplates**

MODEL & FINISHES	313, 335, 628
24-0686-02 Radius faceplate (1-1/4" x 6-7/8")	\$15.00

**7140, 7170 Electric Strike Faceplates**

MODEL & FINISHES	313, 335, 628
24-0687-01 Radius faceplate (1-1/4" x 4-7/8")	\$10.00

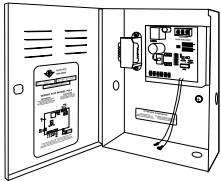
**POWER****PS-1****Power Supply**

MODEL	
PS-1 Power supply, 12/24 VDC boxed P/S 1 amp	\$298.00

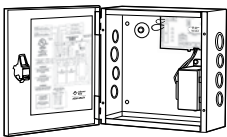
**PS-LR****Power Supply**

MODEL	
PS-LR Power supply for exit devices with LR latch retraction option	\$754.00

**Kitted Options**

MODEL	
BBK-LR Add-on board to the PS-LR, must be supplied with 2 each 12V - 7AH batteries (by others)	\$207.00

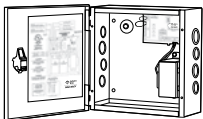
**PS-SE****Power Supply**

MODEL	
PS-SE Power supply for exit devices with SE latch retraction option	\$599.00

**Kitted Option**

MODEL	
BBK-SE Add-on board to the PS-SE, must be supplied with 2 each 12V - 7AH batteries (by others)	\$207.00

**4603, 4605,  
4606**

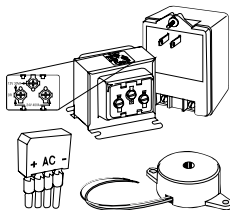

**Transformer/Rectifier/Piezo Horn**

MODELS	
4603 Rectifier	\$14.00
4605 Transformer, 115 VAC to 12/24 VAC	\$52.00
4606 Plug-in transformer, 115 VAC to 24 VAC only	\$86.00
29-0218 Piezo electric horn	\$19.00
ELX ElectroLynx™ Adapter to connect Adams Rite products to the ElectroLynx system	\$30.00

**4612**

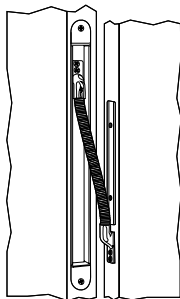

**Power Transfer Device**

MODELS	
4612-1 Wire transfer, 105° swing	\$162.00
4612-2 Wire transfer, 180° swing	\$208.00
4612-1-SC Wire transfer, swing clear 90° swing	\$278.00

## DEMO MOUNTS

## DEADLOCKS &amp; DEADLATCHES

## RT1050

## RITE Touch® Digital Glass Door Lock

## MODEL &amp; FINISH

RT1050D-DEMO RITE Touch digital glass door lock with thumbturn, for all-glass doors

\$750.00

## 2190

## Dual Force® Interconnected Deadbolt/Deadlatch

## MODELS &amp; FINISH

US32D

2190-MOUNT Dual Force® 2190 Interconnected Deadbolt/Deadlatch mounted complete with electrified trim set

\$1,000.00

## 4300

## Steel Hawk® Electrified Deadlatch (eLatch)

## MODELS &amp; FINISH

US32D

4300-MOUNT Steel Hawk® 4300 Electrified Deadlatch mounted complete with 4600 Heavy Duty Designer Deadlatch Lever Trim with MN designer lever

\$850.00

## ELECTRIC STRIKES

## 7400

## Ultraline Electric Strikes

## MODELS &amp; FINISH

7440-MOUNT UltraLine 7440 Electric Strike mounted complete with 4-7/8" faceplate, 628 finish

\$750.00

74R1-MOUNT UltraLine 74R1 Electric Strike for rim exit devices with 3/4" Pullman latches mounted complete, 130 finish

\$750.00

74R2-MOUNT UltraLine 74R2 Electric Strike for rim exit devices with 1/2" Pullman latches mounted complete, 130 finish

\$750.00

## EXIT DEVICES

## 8400

## Narrow Stile Mortise Exit Device

## MODELS &amp; FINISH

628

8400SE-MOUNT 8400 Series Narrow Stile Mortise Exit Device featuring SE Silent Electrification option

\$1,600.00



**TRIM**

**3090**

**eForce® Keyless Entry**

MODELS & FINISH		626
<b>3090-MOUNT</b>	eForce®3090-150 Keyless Entry Trim mounted complete with 4900 Heavy Duty Deadlatch	\$1,200.00
<b>3090C-MOUNT</b>	eForce®3090P Keyless Entry Trim with HID® iClass credentials mounted complete with 4900 Heavy Duty Deadlatch	\$1,450.00
<b>3090P-MOUNT</b>	eForce®3090P Keyless Entry Trim with HID® Prox credentials mounted complete with 4900 Heavy Duty Deadlatch	\$1,450.00

**A100-3090H**

**Keyless Entry and Aperio® Hub Wholesale Kit**

MODELS & FINISH		626
<b>A100-3090C-MOUNT</b>	Aperio® A100 Keyless Entry Control and Aperio Hub with HID® iClass credentials, mounted complete with 4900 Heavy Duty Deadlatch, 4600 Heavy Duty Designer Deadlatch Lever Trim	\$2,150.00
<b>A100-3090CK-MOUNT</b>	Aperio® A100 Keyless Entry Control and Aperio Hub with keypad and HID® iClass credentials, mounted complete with 4900 Heavy Duty Deadlatch, 4600 Heavy Duty Designer Deadlatch Lever Trim	\$2,150.00

**4600**

**Heavy Duty Designer Deadlatch Handles**

MODELS & FINISH		US32D
<b>4600-MOUNT</b>	4600 Heavy Duty Designer Deadlatch Lever Trim with MN designer levers, mounted complete with Dual Force® 2190 Deadbolt/Deadlatch (lock)	\$1,000.00

## Limited Warranty

Products sold under the Adams Rite brand in the United States of America are warranted free from defects in workmanship and materials under normal use and service.

This warranty does not cover defects or damage arising from improper installation, lack of or improper maintenance, improper storage, shipping and handling, corrosion, erosion, ordinary wear and tear, misuse, abuse, accident, unauthorized service, or use with unauthorized non-Adams Rite products or parts.

This warranty is void if any modification is made to the product, regardless of whether the modification causes or contributes to the alleged defect. All modifications are made at the risk of the party making the modification.

Should any defect of manufacture (in material or workmanship) occur in its products, Adams Rite, upon prompt notification and proof to its satisfaction that the product was defective in manufacture for the use intended by Adams Rite, will at its option, exchange the product, repair the product, or refund the price charged by Adams Rite, FOB factory within the stated time frame listed below.

- All mechanical products for five (5) years from date of manufacture
- Ultraline 7400 Electric Strikes for five (5) years from date of manufacture
- All electrical products for three (3) years from date of manufacture, with the exception of the exit devices with the SE option
- Exit devices with the SE option for one (1) year from date of manufacture. Adams Rite recommends that for optimal performance all exit devices with the SE option are installed and powered using PS-SE power supplies. Installing SE exit devices with PS-SE power supplies extends the warranty to five (5) years from date of manufacture.

## General RMA Procedure

Product repair or replacement, or associated charges, will not be accepted under this warranty unless prior authorization from Adams Rite has been given. Upon receipt of products returned for repair or replacement, Adams Rite will determine whether products qualify for repair or replacement under this warranty. Adams Rite has no liability to pay any costs of repair performed by anyone other than qualified personnel authorized by Adams Rite prior to the work being done.

Written notice of a product or component part believed to be defective as covered by this warranty should be sent to Adams Rite, 10027 S. 51st Street, Suite 102, Phoenix, Arizona 85044 or [customer.care@assaabloy.com](mailto:customer.care@assaabloy.com) and should include your name and address, an identification of the product or component part and a brief description of the defect. Notice of a product or component part believed to be defective as covered by this warranty may also be accepted over the telephone by Adams Rite, 800.872.3267.

Upon receipt of such notice, if the customer has an account with Adams Rite or a valid credit card, an advance replacement product may be ordered whereby Adams Rite will ship a replacement product to the customer free of charge. If Adams Rite does not receive the original defective product from the customer within 60 days, Adams Rite will charge the customer's account or credit card for the price of the advanced replacement product plus freight costs. Upon inspection of the returned product by Adams Rite, a decision will be made whether or not to charge the customer for the advanced replacement Adams Rite product. This decision will be made solely by Adams Rite in accordance with the provisions of these Terms. Obsolete products will not be accepted for return. Return Material Authorizations (RMAs) will be closed if the goods are not received within 60 days of issuance.

If Adams Rite receives original defective product from the customer within 60 days of RMA issuance, and if the customer is requesting credit for the

defective material, the customer must reference the valid Adams Rite Purchase Order number upon which the product was originally ordered. If the original Purchase Order number is not available, at Adams Rite's option a credit may be issued at the customer's current cost. This decision will be made solely by Adams Rite in accordance with the provisions of these Terms.

Transportation charges and insurance on all returned materials must be prepaid by the purchaser when merchandise is ordered in error. On goods returned for customer convenience, when the purchaser returns materials in compliance with these Terms which are accepted by Adams Rite, the purchaser may be issued a credit for 65% of the purchase price, with 35% charged by Adams Rite for handling and reprocessing. All refunds will be in the form of a credit.

Scrap in field may be allowed on select products for customers who have prior agreement with Adams Rite. In this case the original defective product will not have to be returned to Adams Rite. Items allowed under this program are subject to the discretion of Adams Rite and may change at any time. Only authorized product is allowed to be scrapped in the field. Unauthorized product scrapped in the field will be considered 'not returned' and the customer will be charged for the replacement or credit will be denied.

## Cancellation

As an industry leader, Adams Rite is committed to maintaining the highest standard of quality and ensuring strict compliance to industry codes. Adams Rite's proud history of customer service and manufacturing agility allow quick response times to customer's changing needs, which may include special orders or product modifications. Please be advised that all product modifications require special authorization to ensure the order fully meets customer's expectations. Customers are asked to allow for an extended lead time on all special orders. Please note that at Adams Rite's option, product modifications and other special orders cannot be changed, cancelled, or returned once a ship date has been provided on an order acknowledgement by Adams Rite.

Adams Rite prides itself on introducing new, industry-relevant, feature-rich products. Since new solutions will surpass the capabilities of older product lines, historical products may be subsequently discontinued. Every effort will be made to announce new product introductions as well as product discontinuations in a manner that allows customers advanced notice of these events. Once a product line is discontinued orders will be fulfilled in order of receipt, although Adams Rite cannot guarantee all orders can be filled. Repair services and spare parts for discontinued product lines will be available for some reasonable time period. Adams Rite reserves the right to replace discontinued product with an equivalent product as deemed by Adams Rite.

THIS WARRANTY IS IN LIEU OF ALL OTHER EXPRESS WARRANTIES. TO THE EXTENT PERMITTED BY LAW, ALL IMPLIED WARRANTIES ARE LIMITED TO THE DURATION OF THIS WARRANTY. ADAMS RITE IS A DIVISION OF HANCHETT ENTRY SYSTEMS, INC. HANCHETT ENTRY SYSTEMS, INC. SHALL NOT BE LIABLE FOR ANY INCIDENTAL OR CONSEQUENTIAL DAMAGES. SOME STATES DO NOT ALLOW LIMITATIONS ON HOW LONG AN IMPLIED WARRANTY LASTS OR THE EXCLUSION OR LIMITATION OF INCIDENTAL OR CONSEQUENTIAL DAMAGES, SO THE ABOVE LIMITATION OR EXCLUSIONS MAY NOT APPLY TO YOU. THIS WARRANTY GIVES YOU SPECIFIC LEGAL RIGHTS, AND YOU MAY ALSO HAVE OTHER RIGHTS WHICH VARY FROM STATE TO STATE.



**adamsrite.com**



Follow us on Twitter  
at @AdamsRite



Subscribe to our YouTube  
Channel at AdamsRiteMfg



Like us on Facebook  
at Adams Rite



Connect with us on LinkedIn  
at Adams Rite

## USA

Customer Support  
**1.800.872.3267**

**adamsrite.com**

**customer.care@assaabloy.com**

**phx.support@assaabloy.com**

**orders.adamsrite@assaabloy.com**

ASSA ABLOY Phoenix  
Phoenix, AZ

## CANADA

Customer Support  
**1.800.461.3007**

**assaabloy.ca**

**cavau-sales@assaabloy.com**

ASSA ABLOY DSS Canada  
Vaughan, Ontario



**ASSA ABLOY**

ASSA ABLOY is the global  
leader in door opening solu-  
tions, dedicated to satisfying  
end-user needs for security,  
safety and convenience

© 2017, Hanchett Entry Systems, Inc.,  
an ASSA ABLOY Group company.

ARM-030-1216