



PRICE LIST - MARCH 2017

	<u>PAGE #</u>
1000 SERIES ELECTROMAGNETIC LOCKS	
#MM300 - MINI-MAGNETIC LOCKS - CABINETS/DRAWERS	2
#1000 - INDUSTRIAL MAGNETIC LOCKS & ACCESSORIES	2
#1100 - MAGNETIC LOCKS - OUTSWING DOORS/ DELAYED EGRESS	3
#ML1100 - MORTISED MAGNETIC LOCKS & PULLS	3
#TJ1100 - MAGNETIC LOCKS - INSWING DOORS/ DELAYED EGRESS	4
#1100 - MAGNETIC LOCK - OPTIONS & CUSTOM HOUSINGS	5
#1100 - MAGNETIC LOCK - SPECIAL FINISHES	6
#1180 - MAGNETIC LOCK - FILLER PLATES	7
#1180 - MAGNETIC LOCK - FILLER PLATE-SPECIAL FINISHES	8
#1190 - MAGNETIC LOCK - ANGLE MOUNTING BRACKETS	9
#1190 - MAGNETIC LOCK - ANGLE MOUNTING BRACKET FINISHES	10
#1190 - MAGNETIC LOCK - Z-BRACKET SPACER BLOCKS	11
#1190 - ARMATURE MOUNTING BRACKETS-HERCULITE BRACKETS	12
3000 SERIES ELECTRIC STRIKES	
#3300 - ANSI STYLE STRIKES	13
#3400 - ELECTRIC DROP BOLTS	13
4000 SERIES POWER SUPPLIES & CONTROLLERS	
#4000 - PLUG-IN POWER SUPPLIES	14
#4200 - POWER SUPPLIES WITH SWITCHING REGULATOR	14
#4300 - ECONOMY MANTRAPS / INTERLOCKS 2 - DOORS	15
#4300- COMMUNICATING BATHROOM CONTROLLERS	15
#4700 - PLC MANTRAPS / INTERLOCKS 2 - 4 DOORS	16
#4800 - FIELD PROGRAMMABLE INTERLOCKS	17
#4900 - PLC MANTRAPS / INTERLOCKS UP TO 120 DOORS	18
5000 SERIES ACTUATING CONTROLS	
#5100 - MORTISE KEY SWITCHES	19
#5210 - PUSH BUTTON SWITCHES	20 & 21
#5230 - SNAP ACTION PUSH BUTTONS / UNDER DESK CONSOLES	22
#5240 - ELECTRIC KEY SWITCHES / UNDER DESK CONSOLES	23
#5276 - SWITCHES GUARDED / HEAVY DUTY & WATERPROOF	24 & 25
#5277 - PIEZO ELECTRIC SWITCHES	26
#5278 - TOUCHLESS ELECTRIC SWITCHES	26
#5286 - PUSH PLATE SWITCHES	27, 28, 29
#5287 - HEAVY DUTY PUSH BUTTON SWITCHES	30
6000 SERIES ACCESSORIES	
#6220 - DOOR CORDS	31
#6420 - PANIC EGRESS BARS	31
#6450 - LEVER TRIM DEVICE FOR PANIC EGRESS BARS	31
#6500 - EMERGENCY PULL STATIONS & ANTI TAMPER COVERS	32
#6612 - REX MOTION DETECTORS	32
7000 SERIES ANNUNCIATORS	
#7101 - DELAYED EGRESS SYSTEM	33
#7201 - HI-INTENSITY LED INDICATORS & PIEZO SOUNDERS	34
#7200 - MULTI-ZONE ANNUNCIATORS	35
#7281 - DOOR EXIT ALARM / ANNUNCIATORS	36
#7286 - DOOR PROP ALARM / ANNUNCIATORS	37
#7600 - MULTI-ZONE ANNUNCIATOR / CONTROLLERS	38
#7600 - ANNUNCIATOR PANEL & RACK SIZE INFORMATION	39
8000 SERIES ACCESS CONTROL SYSTEMS	
#8100 - KEYPAD ACCESS CONTROL	40
REPAIR PARTS & MISCELLANEOUS	
#1100 - ELECTROMAGNETIC LOCK PARTS	41
#5000 - ACTUATING CONTROL SWITCH PARTS	42
ELECTRICAL BOXES & ACCESSORIES	42
CREDIT APPLICATION & SALES POLICIES	43 & 44



MAGNETIC LOCKS

	<u>PART #</u>	<u>DESCRIPTION</u>	<u>LIST PRICE</u>
MINI SERIES	CABINET & DRAWER LOCKS		
	MM-300	<u>MINI-MITE LOCK</u> 300 LB MINI-MITE LOCK 12/24 VDC (DUAL VOLTAGE) WITH STAINLESS STEEL HOUSING (3-1/4" x 2-1/4" x 1-3/4" OVERALL)	\$210.00
	TJMM-300	FOR INSWING APPLICATIONS INCLUDES Z-BRACKET	\$310.00
	MM-D1	ACCESSORY ARMATURE ANGLE BRACKET	\$50.00
	MM-D2	TJ BACK MOUNTING BRACKET	\$50.00
	MM-ZD1	MINI MITE Z- BRACKET	\$80.00
	MM-300N	<u>NARROW MINI-MITE LOCK</u> 300 LB NARROW LINE MINI-MITE LOCK (SPECIFY 12 OR 24 VDC) STAINLESS STEEL ENCLOSURE	\$230.00
	TJMM-300N	FOR INSWING APPLICATIONS INCLUDES Z-BRACKET	\$330.00
	MM-N1	NARROW ANGLE BRACKET 1-1/2 x 1-1/2 x 6"	\$40.00
	MM-N2	TJ BACK MOUNTING BRACKET	\$40.00
	MM-ZN1	NARROW MINI-MITE Z- BRACKET	\$60.00
1000 SERIES	INDUSTRIAL ELECTROMAGNETIC LOCKS		
	1000	<u>INDUSTRIAL LOCK - OUTSWING DOORS</u> 1200 LB LOCK 12/24 VDC (DUAL VOLTAGE - FIELD SELECTABLE) FOR SURFACE MOUNTING ON OUTSWING DOORS STAINLESS STEEL HOUSING	\$395.00
	TJ-1000	1200 LB LOCK 12/24 VDC (DUAL VOLTAGE - FIELD SELECTABLE) FOR SURFACE MOUNTING ON INSWING DOORS INCLUDES ANGLE MOUNTING BRACKET AND ARMATURE "Z" BRACKET	\$480.00
	1095-00	<u>OPTIONAL MOUNTING BRACKET</u> USE FOR GATE OR SLIDING DOOR APPLICATIONS	\$50.00
	1099-00	<u>GATE/INSWING - CONVERSION KIT</u> KIT INCLUDES 1095-00 ANGLE BRACKET & 1096-00 Z-BRACKET FOR MOUNTING OF CONDUIT FITTED LOCKS OR TOP JAMB MOUNTING (IN-SWING DOORS) OF STANDARD INDUSTRIAL LOCK (KIT INCLUDED WITH TJ-1000)	\$168.00
	1096-00 Z-BRACKET		
	1000XCF	<u>1000 SERIES OPTIONS</u> xD ADD SPDT DOOR POSITION SWITCH (SINGLE) xCF ADD CONDUIT FITTING (FOR 1/2" RIGID CONDUIT) (THE 1000XCF COMES WITH 10' LEADS)	\$45.00 \$20.00

FILLER PLATES & ANGLE BRACKETS pgs. 8-12

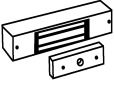
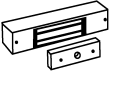
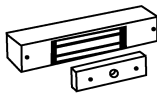
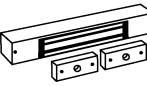
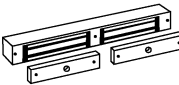
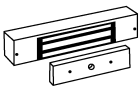
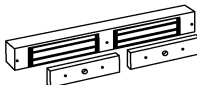
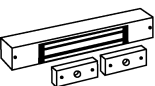

MAGNETIC LOCKS

	<u>PART #</u>	<u>DESCRIPTION</u>	<u>LIST PRICE</u>
1100 SERIES	ELECTROMAGNETIC LOCKS		
	1106	650 LB SINGLE MAGLOCK JUNIOR 650 LB LOCK 12/24 VDC DUAL VOLTAGE - (NOT AVAILABLE WITH XEDR USE 1107XEDR)	\$365.00
	1107	600LB DELAYED EGRESS ACTUATING LOCK NARROW 600 LB LOCK 12/24 VDC DUAL VOLTAGE **ADD xD or xEDR OPTIONS ONLY - NO FINISHES**	\$375.00
	1110	1200 LB SINGLE MAGLOCK SINGLE DOOR 1200 LB LOCK 12/24 VDC (DUAL VOLTAGE - FIELD SELECTABLE)	\$415.00
	1115	600 LB. SPLIT ARMATURE MAGLOCK SPLIT ARMATURE DOUBLE LOCK 12/24 VDC (DUAL VOLTAGE - FIELD SELECTABLE)	\$455.00
	1120	1200 LB DOUBLE MAGLOCK DOUBLE DOOR 1200 LB 12/24 VDC (DUAL VOLTAGE - FIELD SELECTABLE)	\$830.00
	1150	1500 LB SINGLE MAGLOCK SINGLE DOOR 1500 LB 12/24 VDC (DUAL VOLTAGE - FIELD SELECTABLE)	\$465.00
	1152	1500 LB DOUBLE MAGLOCK DOUBLE DOOR 1500 LB 12/24 VDC (DUAL VOLTAGE - FIELD SELECTABLE)	\$930.00
	1155	750 LB. SPLIT ARMATURE MAGLOCK SPLIT ARMATURE DOUBLE LOCK 12/24 VDC (DUAL VOLTAGE - FIELD SELECTABLE)	\$535.00

1100 SERIES MORTISED LOCK APPLICATIONS

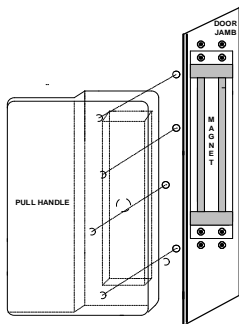

ML-1100	MORTISED MAGLOCKS MORTISED 1000 LB LOCK INCLUDES RECESSED MOUNTING BRACKET & ARMATURE 24 VDC ONLY	\$470.00
DPA1100	ALUMINUM DOOR PULLS DOOR PULL FOR #ML-1100 MORTISED LOCK	\$380.00
(SUFFIX) XDBA	<i>If DPA pull & ML lock are ordered together the armature will be factory mounted in the DPA pull</i> FOR DARK BRONZE ANODIZED FINISH PULL OTHER FINISHES AVAILABLE CHECK WITH FACTORY	ADD \$160.00

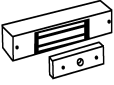
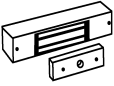
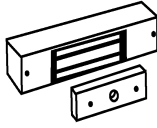
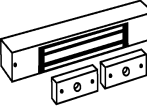
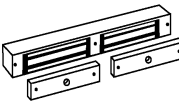
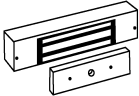
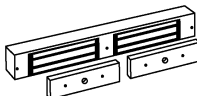
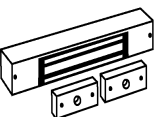
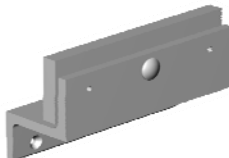
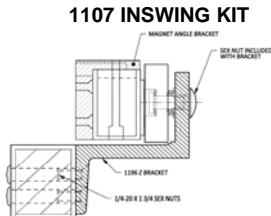

MAGNETIC LOCKS

	PART #	DESCRIPTION	LIST PRICE
TJ1100 SERIES IN-SWINGING DOOR APPLICATIONS			
	TJ1106	650 LB SINGLE MAGLOCK JUNIOR 650 LB LOCK 12/24 VDC (DUAL VOLTAGE - w/ Z-BRACKET FOR ARMATURE (NOT AVAILABLE WITH XEDR USE TJ1107XEDR)	\$445.00
	TJ1107	600LB DELAYED EGRESS ACTUATING LOCK NARROW 600 LB LOCK 12/24 VDC (DUAL VOLTAGE, INCLUDES Z-BRACKET FOR ARMATURE) **ADD xD or xEDR OPTIONS ONLY - NO FINISHES**	\$495.00
	TJ1110	1200 LB SINGLE MAGLOCK SINGLE DOOR 1200 LB LOCK 12/24 VDC (DUAL VOLTAGE - FIELD SELECTABLE, INCLUDES TOP JAMB LOCK HOUSING w/ Z-BRACKET FOR ARMATURE)	\$505.00
	TJ1115	600 LB. SPLIT ARMATURE MAGLOCK SPLIT ARMATURE DOUBLE LOCK 12/24 (DUAL VOLTAGE - FIELD SELECTABLE, INCLUDES TOP JAMB LOCK HOUSING w/ Z-BRACKET FOR ARMATURE)	\$585.00
	TJ1120	1200 LB DOUBLE MAGLOCK DOUBLE DOOR 1200 LB 12/24 (DUAL VOLTAGE - FIELD SELECTABLE, INCLUDES TOP JAMB LOCK HOUSING w/ Z-BRACKET FOR ARMATURE)	\$1,010.00
	TJ1150	1500 LB SINGLE MAGLOCK SINGLE DOOR 1500 LB 12/24 (DUAL VOLTAGE - FIELD SELECTABLE, INCLUDES TOP JAMB LOCK HOUSING w/ Z-BRACKET FOR ARMATURE)	\$585.00
	TJ1152	1500 LB DOUBLE MAGLOCK DOUBLE DOOR 1500 LB 12/24 (DUAL VOLTAGE - FIELD SELECTABLE, INCLUDES TOP JAMB LOCK HOUSING w/ Z-BRACKET FOR ARMATURE)	\$1,170.00
	TJ1155	750 LB. SPLIT ARMATURE MAGLOCK SPLIT ARMATURE DOUBLE LOCK 12/24 (DUAL VOLTAGE - FIELD SELECTABLE, INCLUDES TOP JAMB LOCK HOUSING w/ Z-BRACKET FOR ARMATURE)	\$815.00
		TYPICAL Z-BRACKET FOR MOUNTING ARMATURE INCLUDED WITH EACH TOP JAMB LOCK SEE PAGE 40 FOR Z-BRACKET PRICING AS A SPARE PART ONLY (ALL TJ LOCKS INCLUDE A Z-BRACKET)	
	1095-07	1107 SERIES INSWING - CONVERSION KIT KIT INCLUDES 1107302 ANGLE BRACKET & 1196-06 Z- BRACKET FOR TOP JAMB MOUNTING (IN-SWING DOORS) (KIT INCLUDED WITH TJ1107)	\$180.00
	1095-07XEDR	1107xEDR SERIES INSWING - CONV. KIT KIT INCLUDES 1107301 ANGLE BRACKET , 1196-06 Z- BRACKET W/SHIM & SPRING LOADED PLATE FOR TOP JAMB MOUNTING (KIT INCLUDED WITH TJ1107xEDR)	\$230.00



MAGNETIC LOCKS

1100 SERIES

PART # DESCRIPTION **OPTIONAL MAGNETIC LOCK FEATURES**

LIST PRICE

<u>(SUFFIX)</u>	<u>1100 SERIES OPTIONS (ADD TO LOCK):</u>	<u>(ADD)</u>
xL	ADD 1 LED (BICOLOR RED / GREEN)	\$30.00
xD	ADD SPDT DOOR POSITION SWITCH (SINGLE)	\$45.00
x2D	ADD 2 SPDT DOOR POSITION SWITCHES (1115/1120/1152/1155)	\$90.00
XDD	ADD DPDT DOOR POSITION SWITCH (NOT AVAILABLE FOR 1000 SERIES)	\$90.00
xB	ADD 1 MAGNETIC BOND SENSOR (NOT AVAILABLE FOR 1000,1115,1155 SERIES LOCKS)	\$90.00
x2B	ADD 2 MAGNETIC BOND SENSORS DOUBLE(1120/1152)	\$180.00
xCF	ADD CONDUIT FITTING (FOR 1/2" RIGID CONDUIT) (1000XCF HAS 10' LEADS, NOT AVAILABLE FOR 1107)	\$10.00 \$20.00
xCT	ADD COVER TAMPER SWITCH	\$44.00
xTS	ADD TAMPER RESISTANT SCREWS/DRIVER	\$12.00
xEDR	ADD ATTEMPTED EGRESS SWITCH & DOOR SWITCH w/ ARMATURE MOUNTING ASSEMBLY (FOR SINGLE DOOR w/ EDR SYSTEM-101) ONLY AVAILABLE WITH 1107 & 1110 SERIES	\$225.00

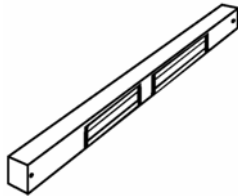

LW-

<u>FULL WIDTH HOUSINGS (ADD TO LOCK):</u>	<u>(ADD)</u>
ADD TO 1106/1110/1150 MAGLOCK FOR SINGLE LOCK HOUSINGS UP TO 48" WIDE	\$450.00
ADD TO 1115/1120/1152 MAGLOCK FOR DOUBLE LOCK HOUSINGS UP TO 72" WIDE	\$500.00

LW-



LV-

<u>FULL HEIGHT HOUSINGS (ADD TO LOCK):</u>	<u>(ADD)</u>
ADD TO 1106/1110/1150 MAGLOCK - FOR SINGLE LOCK HOUSINGS UP TO 96" LONG	\$480.00
ADD TO 1120/1152 MAGLOCK - FOR DOUBLE LOCK HOUSINGS UP TO 96" LONG	\$530.00

LV-

FOR OTHER CUSTOM LOCKS OR HOUSINGS (CALL FOR QUOTE)

FOR CUSTOM FINISHES (CALL FOR QUOTE)



MAGNETIC LOCKS

1100 SERIES	PART #	DESCRIPTION	LIST PRICE
		OPTIONAL SPECIAL LOCK FINISHES	
	<u>(SUFFIX)</u>	<u>ANODIZING (ADD TO LOCK PRICE):</u>	
	xDBA	DARK BRONZE ANODIZE (US10D) -	<u>(ADD)</u>
		ADD FOR 1106 SERIES	\$50.00
		1107 SERIES ANODIZING NOT OFFERED	N/A
		ADD FOR 1110 , 1115 SINGLE SERIES	\$60.00
		ADD FOR 1120 DOUBLE SERIES	\$90.00
		ADD FOR 1150, 1155 SINGLE SERIES	\$70.00
		ADD FOR 1152 DOUBLE SERIES	\$100.00
		ADD FOR TJ1106 TOP JAMB JR.	\$70.00
		ADD FOR TJ1110, TJ1115 TOP JAMB SINGLE	\$75.00
		ADD FOR TJ1120 TOP JAMB DOUBLE	\$120.00
		ADD FOR TJ1150, TJ1155 TOP JAMB SINGLE	\$80.00
		ADD FOR TJ1152 TOP JAMB DOUBLE	\$140.00
	<u>(SUFFIX)</u>	<u>PLATING (ADD TO LOCK PRICE):</u>	
	XUS26	POLISHED CHROME -	
	XUS26D	SATIN CHROME -	
	XUS3	POLISHED BRASS -	<u>(ADD)</u>
	XUS4	SATIN BRASS -	
		ADD FOR 1106 SERIES	\$300.00
		1107 SERIES PLATING NOT OFFERED	N/A
		ADD FOR 1110 , 1115 SINGLE SERIES	\$370.00
		ADD FOR 1120 DOUBLE SERIES	\$500.00
		ADD FOR 1150, 1155 SINGLE SERIES	\$380.00
		ADD FOR 1152 DOUBLE SERIES	\$540.00
		ADD FOR TJ1106 TOP JAMB JR.	\$420.00
		ADD FOR TJ1110,TJ1115 TOP JAMB SINGLE	\$590.00
		ADD FOR TJ1120 TOP JAMB DOUBLE	\$800.00
		ADD FOR TJ1150, TJ1155 TOP JAMB SINGLE	\$610.00
		ADD FOR TJ1152 TOP JAMB DOUBLE	\$840.00



MAGNETIC LOCKS

1180 SERIES

PART # FILLER PLATES

DESCRIPTION

LIST PRICE

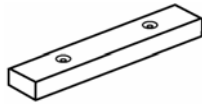

PART #	DESCRIPTION	LIST PRICE
3/8" FILLERS		
1183-00	3/8 x1" 1000 SERIES FILLER 8-1/4" LONG	\$33.00
1183-06	3/8 x1" 1106 SERIES FILLER 8-1/4" LONG	\$33.00
1183-07	3/8 x1-1/4" 1107 SERIES FILLER 8-1/4" LONG	\$54.00
1183-10	3/8 x1" 1110/1115 SERIES FILLER 12-1/2" LONG	\$45.00
1183-20	3/8 x1" 1120 SERIES FILLER 23" LONG	\$53.00
1183-50	3/8 x1" 1150/1155 SERIES FILLER 12" LONG	\$45.00
1183-52	3/8 x1" 1152 SERIES FILLER 24" LONG	\$56.00
EXTRA WIDE FILLER PLATES		
1183-00-W	EXTRA WIDE 3/8 x 1-1/2" 1000 FILLER 8-1/4" LONG	\$41.00
1183-06-W	EXTRA WIDE 3/8 x 1-3/4" 1106 FILLER 8-1/4" LONG	\$41.00
1183-10-W	EXTRA WIDE 3/8 x 1-3/4" 1110/1115 FILLER 12-1/2"	\$53.00
1183-20-W	EXTRA WIDE 3/8 x 1-3/4" 1120 FILLER 23" LONG	\$64.00
1183-50-W	EXTRA WIDE 3/8 x 2" 1150/1155 FILLER 12"	\$53.00
1183-52-W	EXTRA WIDE 3/8 x 2" 1150/1155 FILLER 24"	\$64.00
1/2" FILLERS		
1184-00	1/2"x1" 1000 SERIES FILLER 8-1/4" LONG	\$37.00
1184-06	1/2"x1" 1106 SERIES FILLER 8-1/4" LONG	\$37.00
1184-07	1/2 x1-1/4" 1107 SERIES FILLER 8-1/4" LONG	\$58.00
1184-10	1/2"x1" 1110/1115 SERIES FILLER 12-1/2" LONG	\$47.00
1184-20	1/2"x1" 1120 SERIES FILLER 23" LONG	\$60.00
1184-50	1/2"x1" 1150/1155 SERIES FILLER 12" LONG	\$47.00
1184-52	1/2"x1" 1152 SERIES FILLER 24" LONG	\$60.00
EXTRA WIDE FILLER PLATES		
1184-00-W	EXTRA WIDE 1/2 x 1-1/2" 1000 FILLER 8-1/4" LONG	\$47.00
1184-06-W	EXTRA WIDE 1/2 x 1-3/4" 1106 FILLER 8-1/4" LONG	\$47.00
1184-10-W	EXTRA WIDE 1/2 x 1-3/4" 1110/1115 FILLER 12-1/2"	\$57.00
1184-20-W	EXTRA WIDE 1/2 x 1-3/4" 1120 FILLER 23" LONG	\$70.00
1184-50-W	EXTRA WIDE 1/2 x 2" 1150/1155 FILLER 12" LONG	\$57.00
1184-52-W	EXTRA WIDE 1/2 x 2" 1152 FILLER 24" LONG	\$70.00
5/8" FILLERS		
1185-00	5/8"x1" 1000 SERIES FILLER 8-1/4" LONG	\$41.00
1185-06	5/8"x1" 1106 SERIES FILLER 8-1/4" LONG	\$41.00
1185-07	5/8 x1-1/4" 1107 SERIES FILLER 8-1/4" LONG	\$62.00
1185-10	5/8"x1" 1110/1115 FILLER 12-1/2" LONG	\$49.00
1185-20	5/8"x1" 1120 SERIES FILLER 23" LONG	\$64.00
1185-50	5/8"x1" 1150/1155 SERIES FILLER 12" LONG	\$50.00
1185-52	5/8"x1" 1152 SERIES FILLER 24" LONG	\$64.00
EXTRA WIDE FILLER PLATES		
1185-00-W	EXTRA WIDE 5/8 x 1-1/2" 1000 FILLER 8-1/4" LONG	\$53.00
1185-06-W	EXTRA WIDE 5/8 x 1-3/4" 1106 FILLER 8-1/4" LONG	\$53.00
1185-10-W	EXTRA WIDE 5/8 x 1-3/4" 1110 FILLER 12-1/2" LONG	\$61.00
1185-20-W	EXTRA WIDE 5/8 x 1-3/4" 1120 FILLER 23" LONG	\$76.00
1185-50-W	EXTRA WIDE 5/8 x 2" 1150 FILLER 12" LONG	\$61.00
1185-52-W	EXTRA WIDE 5/8 x 2" 1152 FILLER 24" LONG	\$76.00

1180 SERIES FILLER PLATE FOR FRAME WITH NARROW STOP

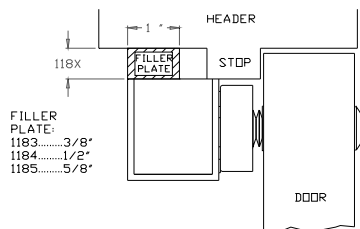

1180-W SERIES WIDE FILLER PLATE FOR FRAME WITH LIP STOP

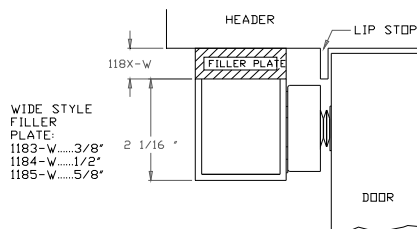



MAGNETIC LOCKS

1180 SERIES	PART #	DESCRIPTION	LIST PRICE
		CUSTOM FINISHES - STANDARD FILLER PLATES	
	<u>(SUFFIX)</u>	<u>SPECIAL FINISHES ADD TO FILLER PLATES</u>	<u>(ADD)</u>
	xDBA	ADD FOR DARK BRONZE ANODIZED -	\$24.00
	xUS26	ADD FOR POLISHED CHROME -	
	xUS26D	ADD FOR SATIN CHROME -	
	xUS3	ADD FOR POLISHED BRASS -	
	xUS4	ADD FOR SATIN BRASS -	
		1106 (SINGLE LOCK) FILLER PLATES	\$65.00
		1107 FINISHES NOT OFFERED	N/A
		1110/1115 (SINGLE LOCK) FILLER PLATES	\$70.00
		1150/1155 (SINGLE LOCK) FILLER PLATES	\$80.00
		1120 (DOUBLE LOCK) FILLER PLATES	\$110.00
		1152 (DOUBLE LOCK) FILLER PLATES	\$100.00



MAGNETIC LOCKS

1190 SERIES

PART # ANGLE BRACKETS

DESCRIPTION

LIST PRICE

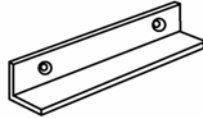

1" x 1" ANGLE BRACKET

1191-00	1"X1" 1000 SERIES ANGLE 8-1/4" LONG	\$42.00
1191-06	1"X1" 1106 & 1107 SERIES ANGLE 8-1/4" LONG	\$42.00
1191-10	1"X1" 1110/1115 SERIES ANGLE 12-1/2"LONG	\$55.00
1191-20	1"X1" 1120 SERIES ANGLE 23" LONG	\$75.00
1191-50	1"X1" 1150/1155 SERIES ANGLE 12"LONG	\$55.00
1191-52	1"X1" 1152 SERIES ANGLE 24" LONG	\$75.00

1-1/2" x 1-1/2" ANGLE BRACKET

1192-00	1-1/2"X 2" 1000 SERIES ANGLE 8-1/4"LONG	\$44.00
1192-06	1-1/2"X1-1/2" 1106 & 1107 SERIES ANGL 8-1/4"LONG	\$44.00
1192-10	1-1/2"X1-1/2" 1110/1115 SERIES ANGLE 12-1/2"LONG	\$58.00
1192-20	1-1/2"X1-1/2" 1120 SERIES ANGLE 23" LONG	\$75.00
1192-50	1-1/2"X1-1/2" 1150/1155 SERIES ANGLE 12"LONG	\$58.00
1192-52	1-1/2"X1-1/2" 1152 SERIES ANGLE 24" LONG	\$75.00

DEPTH X HEIGHT

2" x 1-1/2" ANGLE BRACKET

1193-00	2"X 2" 1000 SERIES ANGLE 8-1/4" LONG	\$60.00
1193-06	2"X1-1/2" 1106 & 1107 SERIES ANGLE 8-1/4" LONG	\$60.00
1193-10	2"X1-1/2" 1110/1115 SERIES ANGLE 12-1/2"LONG	\$77.00
1193-20	2"X1-1/2" 1120 SERIES ANGLE 23" LONG	\$95.00
1193-50	2"X1-1/2" 1150/1155 SERIES ANGLE 12"LONG	\$77.00
1193-52	2"X1-1/2" 1152 SERIES ANGLE 24" LONG	\$95.00

DEPTH X HEIGHT

2-1/2" x 2" ANGLE BRACKET

1194-00	2-3/8"X2" 1000 SERIES ANGLE 8-1/4" LONG	\$65.00
1194-06	2-1/2"X2" 1106 & 1107 SERIES ANGLE 8-1/4" LONG	\$65.00
1194-10	2-1/2"X2" 1110/1115 SERIES ANGLE 12-1/2"LONG	\$80.00
1194-20	2-1/2"X2" 1120 SERIES ANGLE 23" LONG	\$100.00
1194-50	2-1/2"X2" 1150/1155 SERIES ANGLE 12"LONG	\$80.00
1194-52	2-1/2"X2" 1152 SERIES ANGLE 24" LONG	\$100.00

1194 ANGLE BRACKET

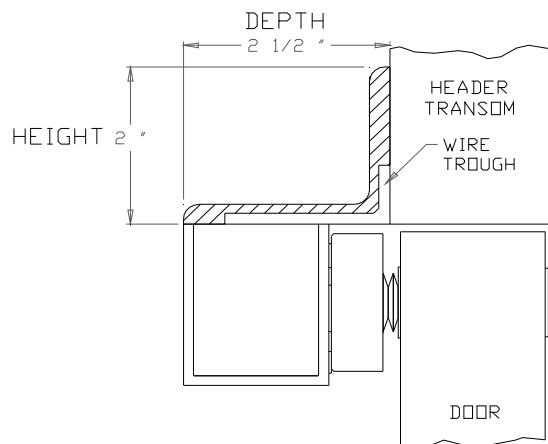



MAGNETIC LOCKS

1190 SERIES	PART #	DESCRIPTION	LIST PRICE
		CUSTOM FINISHES - ANGLE BRACKETS	
	<u>(SUFFIX)</u>	<u>SPECIAL FINISHES ADD TO ANGLE BRACKET:</u>	<u>(ADD)</u>
	xDBA	ADD FOR DARK BRONZE ANODIZED - ALL STANDARD ANGLE BRACKETS	\$26.00
	xUS26	ADD FOR POLISHED CHROME -	
	xUS26D	ADD FOR SATIN CHROME -	
	xUS3	ADD FOR POLISHED BRASS -	
	xUS4	ADD FOR SATIN BRASS -	
		1106 (SINGLE LOCK) ANGLE BRACKETS	\$75.00
		1107 FINISHES NOT OFFERED	N/A
		1110/1115 (SINGLE LOCK) ANGLE BRACKETS	\$85.00
		1150/1155 (SINGLE LOCK) ANGLE BRACKETS	\$100.00
		1120 (DOUBLE LOCK) ANGLE BRACKETS	\$160.00
		1152 (DOUBLE LOCK) ANGLE BRACKETS	\$170.00



MAGNETIC LOCKS

1190 SERIES

PART # DESCRIPTION
"Z" BRACKET ACCESSORIES

LIST PRICE

Z-BRACKET SPACERS & BLOCKS

1176-06S1	1/8" SPACER FOR 1106 & 1107	\$40.00
1176-00S1	1/8" SPACER FOR 1000	\$42.00
1176-10S1	1/8" SPACER FOR 1110/1150 (1120/1152, 2	\$44.00
1176-15S1	1/8" SPACER FOR 1115/1155 (2 REQUIRED)	\$38.00
1176-06S2	1/4" SPACER FOR 1106 & 1107	\$46.00
1176-00S2	1/4" SPACER FOR 1000	\$50.00
1176-10S2	1/4" SPACER FOR 1110/1150 (1120/1152, 2	\$52.00
1176-15S2	1/4" SPACER FOR 1115/1155 (2 REQUIRED)	\$42.00
1176-06B1	1" BLOCK FOR 1106 & 1107	\$88.00
1176-00B1	1" BLOCK FOR 1000	\$92.00
1176-10B1	1" BLOCK FOR 1110/1150 (1120/1152, 2 REQUIRED)	\$96.00
1176-15B1	1" BLOCK FOR 1115/1155 (2 REQUIRED)	\$84.00

SPECIAL FINISH Z-BRACKETS, SPACERS & BLOCKS (Call for quote)

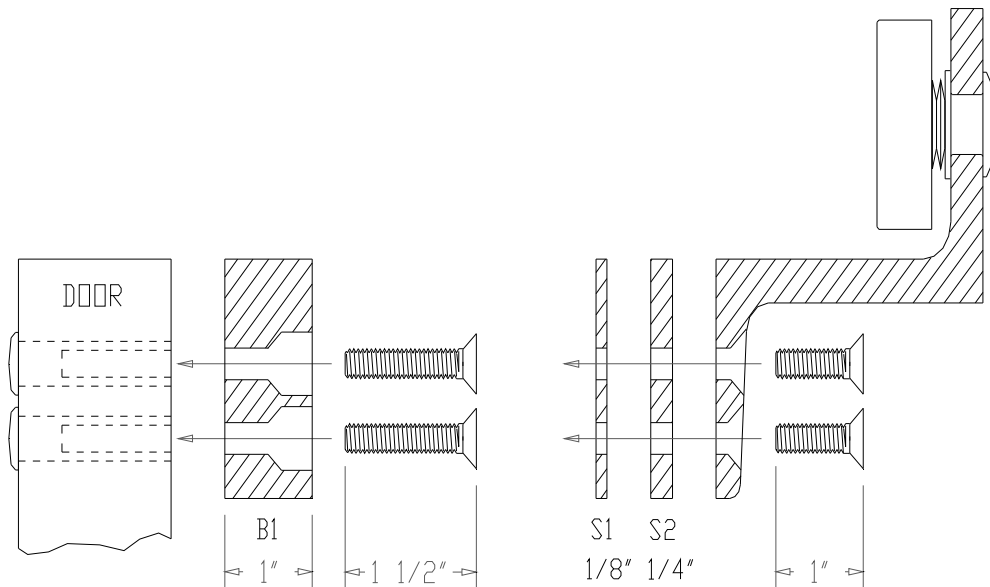



MAGNETIC LOCKS

1190 SERIES

PART # DESCRIPTION

ARMATURE MOUNTING BRACKETS

LIST PRICE

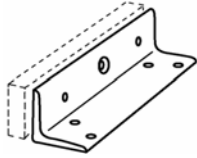

PART #	DESCRIPTION	LIST PRICE
	<u>2" x 2" ARMATURE BRACKET w/ SEX NUT</u>	
1195-06	ARMATURE BRACKET FOR 1106 & 1107 LOCKS	\$60.00
1195-10	ARMATURE BRACKET FOR 1110 LOCKS	\$72.00
1195-15L	ARMATURE BRACKET FOR LEFT ARMATURE 1115	\$58.00
1195-15R	ARMATURE BRACKET FOR RIGHT ARMATURE 1115	\$58.00
	<u>2-1/2" x 2-1/2" BRACKET w/ SEX NUT</u>	
	<u>FOR 1000 & 1150 SERIES LOCKS</u>	
1195-50	ARMATURE BRACKET FOR 1150 & 1000 LOCKS	\$80.00
1195-55L	ARMATURE BRACKET FOR 1155 LEFT ARMATURE	\$66.00
1195-55R	ARMATURE BRACKET FOR 1155 RIGHT ARMATURE	\$66.00
	<u>2-1/2" x 2-1/2" BRACKET w/ SEX NUT</u>	
1197-06	ARMATURE BRACKET FOR 1106 & 1107 LOCKS	\$76.00
1197-10	ARMATURE BRACKET FOR 1110 LOCKS	\$86.00
	<u>2-1/2" x 3" BRACKET w/ SEX NUT</u>	
	<u>FOR 1000 & 1150 SERIES LOCKS</u>	
1197-50	ARMATURE BRACKET FOR 1150 & 1000 LOCKS	\$98.00
	<u>(SUFFIX)</u>	
	<u>ARMATURE BRACKET SPECIAL FINISHES</u>	
xDBA	ADD FOR DARK BRONZE ANODIZED BRACKET	\$50.00
xUS3	ADD FOR POLISHED BRASS ARMATURE BRACKET	\$130.00
xUS26	ADD FOR POLISHED CHROME ARMATURE BRACKET	\$130.00
xUS4	ADD FOR SATIN BRASS ARMATURE BRACKET	\$130.00
xUS26D	ADD FOR SATIN CHROME ARMATURE BRACKET	\$130.00

1190 SERIES

HERCULITE GLASS DOOR BRACKETS

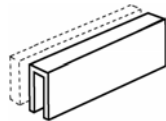

PART #	DESCRIPTION	LIST PRICE
	<u>1198 SERIES GLASS DOOR U-BRACKETS</u>	
	SATIN STAINLESS STEEL FINISH (SPECIFY GLASS THICKNESS)	
1198/50-06	1106 & 1107 SERIES U-BRACKET FOR 1/2" THICK	\$132.00
1198/75-06	1106 SERIES U-BRACKET FOR 3/4" THICK GLASS	\$140.00
1198/50-10	1110/1120 U-BRACKET FOR 1/2" THICK GLASS DOOR	\$132.00
1198/75-10	1110/1120 U-BRACKET FOR 3/4" THICK GLASS DOOR	\$140.00
1198/50-15	1115 SERIES U-BRACKET FOR 1/2" THICK GLASS	\$100.00
1198/75-15	1115 SERIES U-BRACKET FOR 3/4" THICK GLASS	\$110.00
1198/50-50	1150&1000 SERIES U-BRACKET FOR 1/2" GLASS	\$150.00
1198/75-50	1150&1000 SERIES U-BRACKET FOR 3/4" GLASS	\$160.00
1198/50-55	1155 SERIES U-BRACKET FOR 1/2" THICK GLASS	\$110.00
1198/75-55	1155 SERIES U-BRACKET FOR 3/4" THICK GLASS	\$120.00
	<u>(SUFFIX)</u>	
	<u>U-BRACKET SPECIAL FINISHES</u>	<u>(ADD)</u>
xUS3	ADD FOR POLISHED BRASS	\$130.00
xUS4	ADD FOR SATIN BRASS	\$130.00
xUS26	ADD FOR POLISHED CHROME	\$130.00
xUS26	STANDARD FINISH IS SATIN STAINLESS	



ELECTRIC STRIKES



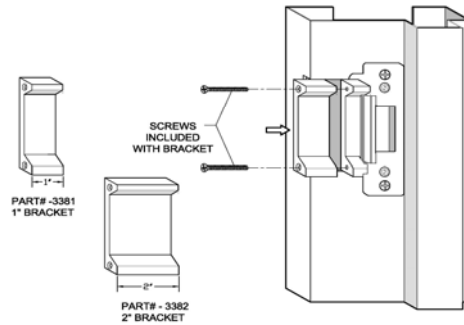

	<u>PART #</u>	<u>DESCRIPTION</u>	<u>LIST PRICE</u>
	3300 SERIES ELECTRIC STRIKES		
	<u>STANDARD ANSI STRIKES</u>		
	3300	12/24 DC ANSI STRIKE - FIELD SELECTABLE FAIL-SAFE/FAIL-SECURE FOR METAL DOOR FRAME	\$205.00
	3300xD	12/24 DC ANSI STRIKE WITH LATCH BOLT MONITOR SWITCH (SPDT) - FIELD SELECTABLE FAIL-SAFE/FAIL-SECURE FOR METAL DOOR FRAME	\$280.00
	3311	<u>WOOD FRAME STRIKE PLATE ONLY</u> CONVERTS ANSI STYLE TO 9" TALL STRIKE FOR WOOD DOOR FRAME	\$22.00
	<u>JAMB EXTENSION BRACKETS</u> FOR USE WITH DEEP DOOR JAMB APPLICATIONS		
	3381	1 INCH JAMB EXTENSION BRACKET	\$20.00
	3382	2 INCH JAMB EXTENSION BRACKET	\$20.00

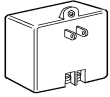
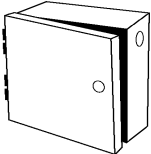
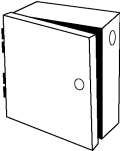

	3400 SERIES ELECTRIC DROPBOLT		
	3412	RECESS MOUNT DROPBOLT FAIL-SAFE 12VDC WITH BOLT MONITOR SWITCH (SPDT) - & FIELD SELECTABLE RELOCK TIMER. FOR HOLLOW METAL, OR WOOD DOOR FRAMES	\$325.00
	3402	SURFACE MOUNT DROPBOLT & RECEIVER FAIL-SAFE 12VDC WITH BOLT MONITOR SWITCH (SPDT) - & DOOR POSITION SWITCH (SPDT) WITH FIELD SELECTABLE RELOCK TIMER.	\$500.00
	3404	HERCULITE DOOR U-BRACKET & RECEIVER HOUSING FOR UP TO 1/2" THICK FRAMELESS GLASS DOORS	\$150.00

POWER SUPPLIES

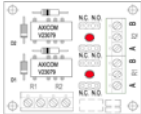
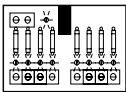

	<u>PART #</u>	<u>DESCRIPTION</u>	<u>LIST PRICE</u>
4000 SERIES		PLUG-IN POWER SUPPLIES	
		<u>WALL MOUNT PLUG IN POWER SUPPLIES</u>	
	4012	12 VOLT PLUG-IN POWER SUPPLY (1 AMP 12 VDC FOR USE WITH 1100 SERIES MAGLOCKS)	\$75.00
	4024	24 VOLT PLUG-IN POWER SUPPLY (1 AMP 24 VDC FOR USE WITH 1100 SERIES MAGLOCKS)	\$75.00
4200 SERIES		POWER SUPPLIES	
		<u>12/24 VDC POWER SUPPLIES</u>	
	4202	2 AMP POWER SUPPLY/CONTROLLER 12/24 VDC (FIELD SELECTABLE) w/ SWITCHING REGULATOR / FILTER / SURGE PROTECTION, BATTERY CHARGING CIRCUIT & FIRE ALARM RELAY FURNISHED IN 16" x 12" x 4" ELECTRICAL BOX - SEE SERIES 4200 OPTIONS	\$585.00
	4204	4 AMP POWER SUPPLY / CONTROLLER 12/24 VDC (FIELD SELECTABLE) SAME AS ABOVE	\$620.00
4200 SERIES		POWER SUPPLY OPTIONS	
		<u>4200 SERIES OPTIONS:</u>	
		ADD FOR LARGER ENCLOSURES AS REQUIRED TO ACCOMMODATE MULTIPLE OPTIONS BELOW	(ADD)
	(SUFFIX) /1518	15" x 18" x 4" ENCLOSURE REQUIRED TO ACCOMMODATE MULTIPLE FUSED OUTPUT BOARDS OR RELAY MODULES	\$160.00
	/2024	20" x 24" x 5" ENCLOSURE REQUIRED TO ACCOMMODATE MULTIPLE FUSED OUTPUT BOARDS OR RELAY MODULES	\$300.00
	xBAT	12/24 VDC - 14 AMP HOUR BATTERY PACK INCLUDES 2 EACH 7 AH 12 VOLT RECHARGEABLE BATTERIES w/ HOOK-UP CABLES	\$112.00
	xRM12 xRM24	RELAY MODULE w/ TWO (2) SPDT ISOLATION RELAYS DIMENSIONS 2" LONG X 1-3/4" WIDE (SPECIFY 12 OR 24VDC)	\$80.00
	xFO	8-ZONE FUSED OUTPUT BOARD (POWER DISTRIBUTION) 4-1/4" LONG X 3" WIDE	\$110.00
	xFO/AUX	8-ZONE FUSED OUTPUT BOARD (POWER DISTRIBUTION) w/ AUXILIARY POWER INTERRUPT RELAY 4-1/4" LONG X 3" WIDE	\$160.00
	xAO	ALARM RELAY OUTPUTS (AC POWER LOSS & LOW BATTERY ALERT)	\$80.00
	xCT	ENCLOSURE COVER TAMPER SWITCH	\$60.00
	xPC	110 VAC GROUNDED POWER CORD 6'-0" LONG	\$35.00
	xTERM	10 POSITION DOUBLE ROW TERMINAL 6 1/2" LONG	\$26.00



POWER SUPPLIES

<u>PART #</u>	<u>DESCRIPTION</u>	<u>LIST PRICE</u>
4300 SERIES	MANTRAPS & INTERLOCKS	

ALL 4300 INTERLOCKS ARE FACTORY PRE-CONFIGURED

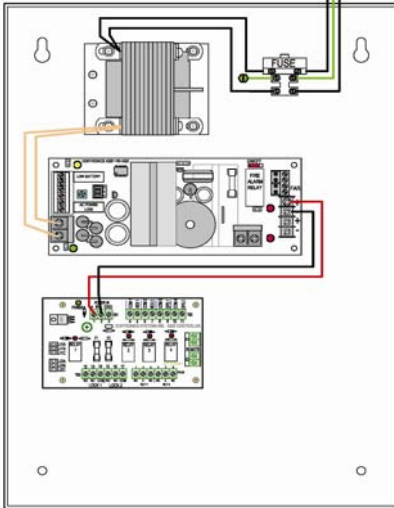

RELAY LOGIC 2-DOOR INTERLOCK CONTROLLERS ARE OFFERED IN STANDARD CONFIGURATIONS WHICH ALLOW FOR ONE DOOR STATUS AND ONE R-E-X INPUT PLUS ONE DPDT LOCK RELAY OUTPUT PER DOOR.

A 4204 POWER SUPPLY INCLUDED IN THE NEMA ENCLOSURE PROVIDES 4 AMPS OF 12 or 24 VDC POWER FOR MAGLOCKS, STRIKES & LED's. A FIRE ALARM RELAY INPUT IS STANDARD. THE NUMBER OF LOCKS AND TOTAL CURRENT DRAW MAY REQUIRE ADDITIONAL POWER .

REQUEST MANTRAP / INTERLOCK CHECK LIST FROM FACTORY TO PROPERLY CONFIGURE 4300 CONTROLLERS

STANDARD CONFIGURATIONS

43211-U	4300 SERIES 2 DOOR MANTRAP INTERLOCKS	
43211-LU	2-Doors – 1-Room - All Doors Normally Unlocked	\$950.00
43211-L	2-Doors – 1-Room - 1-Door Locked & 1-Door Unlocked	
	2-Doors – 1-Room - All Doors Normally Locked	
4300020	Controller board only	\$325.00
	COMMUNICATING BATH CONTROLLER	
43211-CB	2-Doors – 1-Room - Doors Normally Unlocked	\$985.00

SEE 4700 & 4900 SERIES ON FOLLOWING PAGES FOR MORE COMPLEX MANTRAP CONFIGURATIONS



POWER SUPPLIES

PART #

DESCRIPTION

LIST PRICE

4700 SERIES PLC MANTRAPS & INTERLOCKS

ALL 4700 INTERLOCKS ARE FACTORY PRE-PROGRAMMED

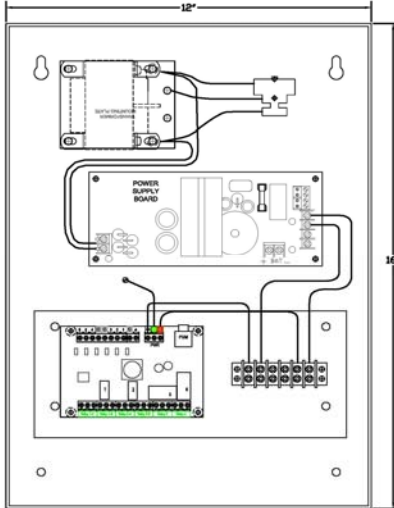

PLC BASED MULTI DOOR, INTERLOCK & MANTRAP CONTROLLERS ARE OFFERED IN STANDARD CONFIGURATIONS WHICH ALLOW FOR ONE DOOR STATUS AND ONE R-E-X INPUT PLUS ONE DPDT LOCK RELAY OUTPUT PER DOOR. A MAXIMUM OF 6-INPUTS AND 4-OUTPUTS CAPABILITY PLUS CUSTOM OPERATIONAL CHARACTERISTICS INCLUDING SEQUENCING AND TIMING MAY BE DESIGNED INTO THE UNIT UPON REQUEST.

A 4204 POWER SUPPLY INCLUDED IN THE NEMA ENCLOSURE PROVIDES 4 AMPS OF 12 or 24 VDC POWER FOR MAGLOCKS, STRIKES & LED's. A FIRE ALARM RELAY INPUT IS STANDARD. THE NUMBER OF LOCKS AND TOTAL CURRENT DRAW MAY REQUIRE ADDITIONAL POWER .

REQUEST MANTRAP / INTERLOCK CHECK LIST FROM FACTORY TO PROPERLY CONFIGURE 4700 PLC CONTROLLERS

STANDARD CONFIGURATIONS

	4700 SERIES 2 DOOR MANTRAP INTERLOCKS	
47211-U	2-Doors – 1-Room - All Doors Normally Unlocked	\$1,260.00
47211-LU	2-Doors – 1-Room - 1-Door Locked & 1-Door Unlocked	
47211-L	2-Doors – 1-Room - All Doors Normally Locked	
	4700 SERIES 3 DOOR MANTRAP INTERLOCKS	
47311-U	3-Doors – 1-Room - All Doors Normally Unlocked	\$1,300.00
47311-L2U	3-Doors – 1-Room - 1-Locked & 2-Unlocked	
47311-2LU	3-Doors – 1-Room - 2-Locked - 1-Unlocked (No Lights)	
47311-L	3-Doors – 1-Room - 3-Locked (No Lights)	
	4700 SERIES 4 DOOR MANTRAP INTERLOCKS	
47411-U	4-Doors – 1-Room - All Doors Normally Unlocked	\$1,425.00
	CUSTOM CONFIGURATION PROGRAMMING	
47000-PRGM	FACTORY PROGRAMMING TO CUSTOM APPLICATION SPECIFICATIONS QUOTED ON AN HOURLY BASIS	\$350.00

THE 4700 SERIES CONTROLLER IS LIMITED TO 6-INPUTS & 4-RELAY OUTPUTS TOTAL FOR DOOR LOCK & TRAFFIC LIGHT CONTROL.

SEE 4900 SERIES ON NEXT PAGE FOR MORE MANTRAP CONFIGURATIONS



POWER SUPPLIES

4800 SERIES

<u>PART #</u>	<u>DESCRIPTION</u>	<u>LIST PRICE</u>
---------------	--------------------	-------------------

NEW USER CONFIGURED INTERLOCKS

4800 INTERLOCKS ARE FIELD CONFIGURABLE

THE 4805 MANTRAP CONTROLLER ALLOWS THE USER TO INTERLOCK FROM TWO TO FIVE DOORS IN ANY COMBINATION AND CONFIGURE THE DOORS FOR LOCKED OR UNLOCKED, FAIL SAFE OR FAIL SECURE OPERATION IN THE FIELD. THE PLC BASED LOGIC GIVES THE INSTALLER COMPLETE CONTROL OVER THE INTERLOCK FUNCTIONS. EACH DOOR IN THE MANTRAP HAS AN INDEPENDENT CONTROL RELAY WITH OVERCURRENT PROTECTION BY FUSE AND WET OR DRY CONTACT SELECTOR. EACH DOOR ALSO HAS A DEDICATED TRAFFIC LIGHT OUTPUT THAT IS POWERED FOR DIRECT CONNECTION TO INDICATORS, A DEDICATED DOOR STATUS RELAY, A DOOR POSITION INPUT AS WELL AS A R-E-X INPUT FOR NORMALLY LOCKED DOORS.

THE SYSTEM FEATURES AN EMERGENCY UNLOCK FOR ALL DOORS WITH AN ALARM, AN INTERLOCK VIOLATION ALARM, AN ADJUSTABLE DOOR PROPPED OPEN TIMER, A PAUSE TIMER (TO ALLOW FOR AIR PURGE, AIR EQUALIZATION OR WASH-DOWN) AND A PANIC RELEASE TIMER.

THE INTERLOCK FUNCTION HAS A SHUNT INPUT THAT DEFEATS THE INTERLOCK FOR DAY/NIGHT MODE, BUT LEAVES THE ACCESS CONTROL SETTINGS UNAFFECTED.

A 4204 POWER SUPPLY INCLUDED IN A NEMA ENCLOSURE PROVIDES 4 AMPS OF 12 or 24 VDC POWER FOR MAGLOCKS, STRIKES & LED's. A FIRE ALARM RELAY INPUT IS STANDARD. THE NUMBER OF LOCKS AND TOTAL CURRENT DRAW MAY REQUIRE ADDITIONAL POWER .

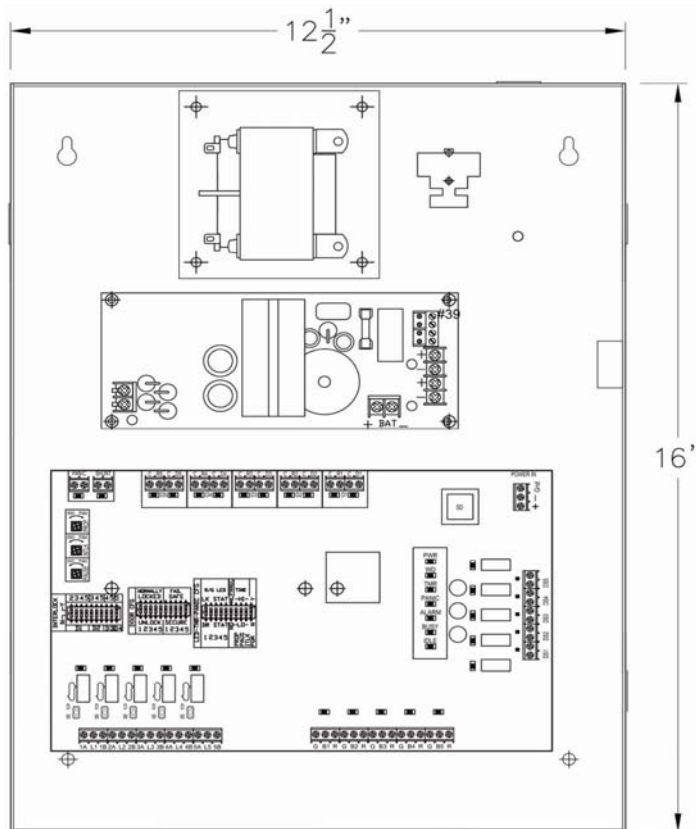

4800 SERIES 2-5 DOOR MANTRAP INTERLOCKS

48501	MOUNTED IN NEMA ENCLOSURE WITH 4AMP SUPPLY UP TO 5 DOORS FIELD CONFIGURED	\$1,990.00
48500	PLC BOARD ONLY (no enclosure) UP TO 5 DOORS FIELD CONFIGURED	\$1,250.00

SEE 4900 SERIES ON NEXT PAGE FOR MORE INTERLOCK CONFIGURATIONS



POWER SUPPLIES

PART #

DESCRIPTION

LIST PRICE

4900 SERIES

PLC MANTRAPS & INTERLOCKS

ALL 4900 INTERLOCKS ARE FACTORY PRE-PROGRAMMED

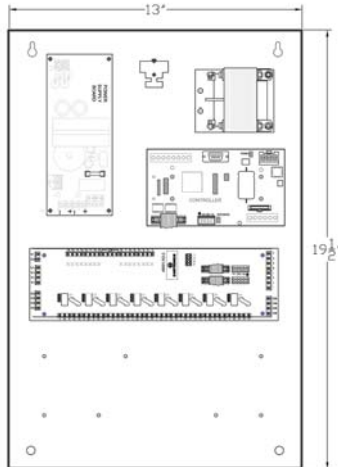

PLC BASED MULTI ROOM / MULTI DOOR, INTERLOCK & MANTRAP CONTROLLERS ARE OFFERED IN STANDARD CONFIGURATIONS WHICH ALLOW FOR ONE DOOR STATUS AND ONE R-E-X INPUT PLUS ONE DPDT LOCK RELAY OUTPUT PER DOOR. ADDITIONAL INPUT AND OUTPUT CAPABILITY PLUS CUSTOM OPERATIONAL CHARACTERISTICS INCLUDING SEQUENCING AND TIMING MAY BE DESIGNED INTO THE UNIT UPON REQUEST.
UP TO 120 TOTAL DOORS MAY BE CONFIGURED

A 4204 POWER SUPPLY INCLUDED IN THE NEMA ENCLOSURE PROVIDES 4 AMPS OF 12 or 24 VDC POWER FOR MAGLOCKS, STRIKES & LED's. A FIRE ALARM RELAY INPUT IS STANDARD. DEPENDENT UPON THE NUMBER OF LOCKS AND TOTAL CURRENT DRAW, ADDITIONAL POWER MAY BE REQUIRED.

REQUEST MANTRAP / INTERLOCK CHECK LIST FROM FACTORY TO PROPERLY CONFIGURE 4900 PLC CONTROLLERS

STANDARD CONFIGURATIONS

	4900 SERIES 2 DOOR MANTRAP INTERLOCKS	
49211-U	2-Doors – 1-Room - All Doors Normally Unlocked	\$2,350.00
49211-L	2-Doors – 1-Room - All Doors Normally Locked	
	4900 SERIES 3 DOOR MANTRAP INTERLOCKS	
49311-U	3-Doors – 1-Room - All Doors Normally Unlocked	\$2,550.00
49311-L	3-Doors – 1-Room - All Doors Normally Locked	
49311-LU	3-Doors – 1-Room - Doors Locked & Unlocked	
	4900 SERIES 4 DOOR MANTRAP INTERLOCKS	
49411D-U	4-Doors – 1-Room - All Doors Normally Unlocked	\$3,500.00
49411D-L	4-Doors – 1-Room - All Doors Normally Locked	
49411D-LU	4-Doors – 1-Room - Doors Locked & Unlocked	

*****MANY OTHER CONFIGURATIONS AVAILABLE CONTACT FACTORY***
OVER 4 DOORS & UP TO 120 DOORS CONTACT THE FACTORY FOR A QUOTE AS THESE
WILL BE CUSTOM CONFIGURED TO YOUR SPECIFICATIONS**

(SUFFIX)	PROGRAMMABLE I.O. WITH NUMERIC DISPLAY	(ADD)
	USER SELECTABLE MULTIFUNCTION PROGRAM	
	TIMER ALLOWS CUSTOM CONFIGURATION OF	
XDSP	INPUT/OUTPUT & TIMING FUNCTIONS	\$575.00
	CUSTOM CONFIGURATION PROGRAMMING	
49000-PRGM	FACTORY PROGRAMMING TO CUSTOM APPLICATION	\$350.00
	SPECIFICATIONS QUOTED ON AN HOURLY BASIS	

("DOORS" REFERS TO EACH OPENING WHICH MAY BE A PAIR OF DOORS)

ACTUATORS



5100 SERIES

KEY SWITCH CONTROLS

PART #

DESCRIPTION

LIST PRICE

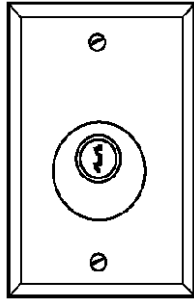

5141-25

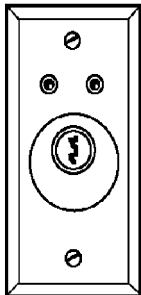

N5141-25XL2XK

5141 SERIES KEY SWITCHES (LESS CYLINDER)

<u>PART #</u>	<u>DESCRIPTION</u>	<u>LIST PRICE</u>
5141-23	FORM Z-DELAY ACTION KEY SWITCH ON SINGLE GANG PLATE (PNEUMATIC TIME DELAY)	\$280.00
5141-24	DPDT ALTERNATE ACTION KEY SWITCH ON SINGLE GANG PLATE	\$126.00
5141-25	DPDT MOMENTARY ACTION KEY SWITCH ON SINGLE GANG PLATE	\$114.00
5141-2/24	TWO POSITION KEY SWITCH ON SINGLE GANG PLATE w/ 2-DPDT MAINTAINED ACTION CONTACT SWITCHES	\$179.00
5141-2/25	TWO POSITION KEY SWITCH ON SINGLE GANG PLATE w/ 2-DPDT MOMENTARY ACTION CONTACT SWITCHES	\$155.00

(MOUNTING KIT INCLUDES CYLINDER NUT, PIN HEX SCREWS AND PIN HEX ALLEN WRENCH)

(SUFFIX)

xK
xKNR

xP15
xCS
xL
xCT

5141 KEY SWITCH OPTIONS (ADD TO ABOVE):

<u>DESCRIPTION</u>	<u>(ADD)</u>
STANDARD 1-1/8" MORTISE CYLINDER & 2 KEYS	\$40.00
CYLINDER WITH KEY NON-REMOVABLE IN "ON" POSITION (single switch Mom. configuration only)	\$50.00
ADD SPDT PUSH BUTTON SWITCH	\$28.00
ADD DC PIEZO SOUNDER (REQUIRES 2-GANG PLATE)	\$30.00
ADD 1 LED (BICOLOR RED / GREEN)	\$14.00
ADD 1 SPDT COVER TAMPER SWITCH	\$44.00

(SUFFIX)

xUS26
xUS3
xUS4

5141 KEY SWITCH FINISHES

<u>DESCRIPTION</u>	<u>(ADD)</u>
POLISHED CHROME	\$40.00
POLISHED BRASS FINISH	\$40.00
SATIN BRASS FINISH	\$40.00

(PREFIX)

N
D
WR

<u>DESCRIPTION</u>	<u>LIST PRICE</u>
WITH NARROW 1-3/4" SWITCH PLATE	\$6.00
WITH DOUBLE GANG SWITCH PLATE	\$12.00
WITH WEATHER RESISTANT SWITCH PLATE (1-GANG)	\$8.00

SEE #5240 SERIES & #7286 DOOR PROP ALARMS FOR OTHER KEY SWITCH CONFIGURATIONS

ACTUATORS



5210 SERIES

EXIT PUSH BUTTONS

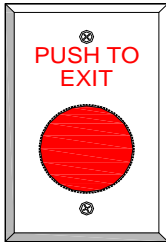

5211-MP23XE1



5216-MP23XE3

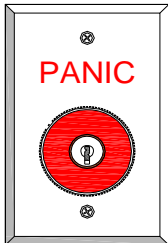

5211-MP23KRXE2

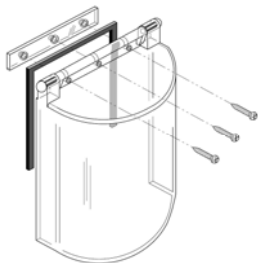

(ORDER AS LINE ITEM)----

PART #	DESCRIPTION	LIST PRICE
5211 PUSH BUTTONS 1-9/16" DIA		
5211-MP23*	1-9/16" DIA. MUSHROOM PUSH BUTTON (SPECIFY CAP COLOR) w/ DPST MOMENTARY (1-NO & 1-NC CONTACT) MOUNTED ON SINGLE GANG PLATE	\$118.00
5211-MP23PP*	1-9/16" DIA. MUSHROOM PUSH-PULL BUTTON (RED CAP) w/ DPST ALT ACTION (1-NO & 1-NC CONTACT) MOUNTED ON SINGLE GANG PLATE	\$146.00
5211-LMP23	1-9/16" DIA. ILLUMINATED PUSH BUTTON (RED CAP) w/ DPST MOMENTARY ACTION (1-NO & 1-NC CONTACT) MOUNTED ON SINGLE GANG PLATE	\$185.00
5211-MP23DA*	1-9/16"DIA. MUSHROOM PUSH BUTTON (SPECIFY CAP COLOR) w/PNEUMATIC 2-60 DELAY (FORM Z)	\$336.00
5216 PALM BUTTONS 2-3/8" DIA		
5216-MP23*	2-3/8" DIA. PALM BUTTON (SPECIFY CAP COLOR) w/ DPST MOMENTARY (1-NO & 1-NC CONTACT)	\$130.00
5216-MP24*	2-3/8" DIA. PALM BUTTON (SPECIFY CAP COLOR) w/ DPST ALT ACTION (1-NO & 1-NC CONTACT) MOUNTED ON SINGLE GANG PLATE	\$175.00
5216-MP23PP	2-3/8" DIA. PALM BUTTON (RED CAP) PUSH-PULL W/ DPST ALT ACTION (1-NO & 1-NC CONTACT)	\$156.00
5216-MP23DA*	2-3/8" DIA. PALM BUTTON (SPECIFY CAP COLOR) W/ PNEUMATIC 2-60 SEC. DELAY (FORM Z)	\$346.00
5211/16 LATCHING BUTTONS WITH KEY RESET		
5211-MP23/KR	1-9/16" DIA. DURESS PUSH BUTTON (RED CAP) DPST LATCHING/ KEY RESET (1-NO & 1-NC CONTACT) ON SINGLE GANG PLATE	\$250.00
5216-MP23/KR	2-3/8" DIA. DURESS PUSH BUTTON (RED CAP) DPST LATCHING WITH KEY RESET (1-NO & 1-NC CONTACT) ON SINGLE GANG PLATE	\$262.00
5211-028L	28 VOLT LAMPS- PKG. OF 4	\$16.00
5211 & 5216 PUSH BUTTON OPTIONS:		
(SUFFIX)		(ADD)
/R	* DESIGNATES RED CAP	'N/C
/G	* DESIGNATES GREEN CAP (NON STOCK ITEM)	'N/C
/B	* DESIGNATES BLACK CAP	'N/C
/BU	* DESIGNATES BLUE CAP (NON STOCK ITEM)	\$10.00
-02CB	ADDITIONAL NO CONTACT BLOCK (Requires 2-3/4"	\$18.00
-03CB	ADDITIONAL NC CONTACT BLOCK deep back box)	\$18.00
xL	ADD 1 LED BLACK BEZEL (BI-COLOR RED/GREEN)	\$14.00
xAT	ADJUSTABLE 1-60 SEC. TIMER DPDT OUTPUT	\$100.00
xFT	FIXED 30 SECOND TIMER DPDT RELAY OUTPUT	\$100.00
XTS	TAMPER PROOF SCREWS & HEX KEY	\$12.00
ENGRAVING OPTIONS (RED TEXT)		
(SUFFIX)		(ADD)
xE1	S/S PLATE ENGRAVED "PUSH TO EXIT"	\$18.00
xE2	S/S PLATE ENGRAVED "PANIC"	\$18.00
xE3	S/S PLATE ENGRAVED "EMERGENCY RELEASE"	\$18.00
xE4	S/S PLATE ENGRAVED "PUSH TO RELEASE"	\$18.00
xE5	ENGRAVED "PULL TO RELEASE"	\$18.00
xE6	PER PLATE FEE AFTER SET UP	\$24.00
XE6SETUP	CUSTOM ENGRAVING 1 SET UP FEE PER RUN	\$60.00
XHCP	HANDICAP LOGO BLUE ENGRAVING	\$40.00
5210 SERIES SWITCH PLATE OPTIONS		
(PREFIX)		(ADD)
WR	WEATHER RESISTANT 1-GANG PLATE	\$8.00
D	DOUBLE GANG SWITCH PLATE	\$12.00
N	NARROW 1-3/4" PLATE FOR FRAME MOUNTING	\$6.00
5210/COV	ANTI TAMPER PLEXIGLAS BUTTON COVER	\$65.00

ACTUATORS

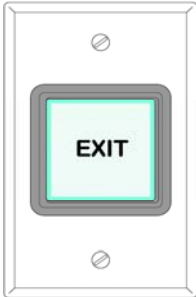

5215 SERIES

	<u>PART #</u>	<u>DESCRIPTION</u>	<u>LIST PRICE</u>
SQUARE EXIT PUSH BUTTONS			
<u>5215 ILLUMINATED SQUARE PUSH BUTTONS</u>			
 <p>5215-SPBxE1</p>	5215-SPB	1-1/2" ILLUMINATED SQUARE PUSH BUTTON (GREEN COLOR CAP ONLY) w/ SPDT MOMENTARY SWITCH CONTACTS MOUNTED ON SS SINGLE GANG PLATE LAMP BULBS ARE RATED @ 28VDC MAX	\$64.00
	5215-SPBxE1	1-1/2" ILLUMINATED SQUARE PUSH BUTTON "PUSH TO EXIT" LETTERING ON GREEN CAP w/ SPDT MOMENTARY SWITCH CONTACTS MOUNTED ON SS SINGLE GANG PLATE	\$68.00
	5215-SPBxE3	1-1/2" ILLUMINATED SQUARE PUSH BUTTON "EXIT" LETTERING ON GREEN CAP w/ SPDT MOMENTARY SWITCH CONTACTS MOUNTED ON SS SINGLE GANG PLATE	\$68.00
	5215-SPBxL	1-1/2" ILLUMINATED SQUARE PUSH BUTTON (GREEN CAP ONLY) w/ SPDT MOMENTARY SWITCH CONTACTS & BICOLOR LED MOUNTED ON SS SINGLE GANG PLATE	\$76.00
 <p>5215-SPBxE3</p>	5215-SPBxLxE1	1-1/2" ILLUMINATED SQUARE PUSH BUTTON "PUSH TO EXIT" LETTERING ON GREEN CAP w/ SPDT MOMENTARY SWITCH CONTACTS & BICOLOR LED MOUNTED ON SS SINGLE GANG PLATE	\$80.00
	5215-SPBxLxE3	1-1/2" ILLUMINATED SQUARE PUSH BUTTON "EXIT" LETTERING ON GREEN CAP w/ SPDT MOMENTARY SWITCH CONTACTS & BICOLOR LED MOUNTED ON SS SINGLE GANG PLATE	\$80.00
	5215-028L	28 VOLT DC MAX REPLACEMENT LAMP	\$6.00
	<u>(SUFFIX)</u>		<u>(ADD)</u>
	xAT	1-60 SECOND TIMER DPDT RELAY OUTPUT	\$100.00
	xFT	FIXED 30 SECOND TIMER DPDT RELAY OUTPUT	\$100.00

SHOWN BELOW

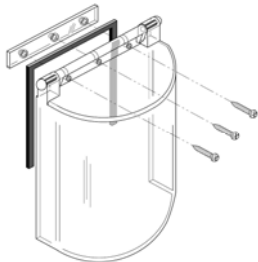



5210/COV

5210/COV	<u>ANTI TAMPER PLEXIGLAS BUTTON COVER</u> PROTECTS PUSH BUTTON FROM BEING ACCIDENTALLY ACTUATED MOUNTS OVER SINGLE GANG SWITCH. 6-1/2"HIGH x 4"WIDE OVERALL	\$65.00
----------	---	---------

ACTUATORS

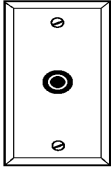
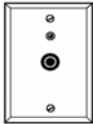

	<u>PART #</u>	<u>DESCRIPTION</u>	<u>LIST PRICE</u>
5220 SERIES DELAYED ACTION PUSH BUTTONS			
<u>5221 PNEUMATIC DELAY PUSH BUTTON</u>			
 <p>5221-P23DA</p> <p>(ORDER AS LINE ITEM)----</p>	5221-P23DA	PNEUMATIC TIME DELAY PUSH BUTTON SWITCH	\$265.00
	<u>(SUFFIX)</u>	<u>5221 TIME DELAY PUSH BUTTON OPTIONS</u>	<u>(ADD)</u>
	xUS3	POLISHED BRASS PLATE	\$40.00
	xUS4	SATIN BRASS PLATE	\$40.00
	xL	ADD 1 LED BLACK BEZEL (BICOLOR RED / GREEN)	\$20.00
		<u>ENGRAVING OPTIONS</u>	
	xE1	S/S PLATE ENGRAVED "PUSH TO EXIT"	\$18.00
	xE2	S/S PLATE ENGRAVED "PANIC"	\$18.00
	xE3	S/S PLATE ENGRAVED "EMERGENCY RELEASE"	\$18.00
	xE4	S/S PLATE ENGRAVED "PUSH TO RELEASE"	\$18.00
xE6	PER PLATE FEE AFTER SET UP	\$24.00	
XE6SETUP	CUSTOM ENGRAVING 1 SET UP FEE PER RUN	\$60.00	
<u>(PREFIX)</u>	<u>5221 NARROW SWITCH PLATE OPTIONS</u>		
N	ADD NARROW 1-3/4" PLATE FOR FRAME MOUNTING	\$6.00	
5230 SERIES SNAP ACTION PUSH BUTTONS			
<u>5231 PUSH BUTTONS 3/8" DIAMETER</u>			
 <p>5231-P15</p>  <p>N5231-P15</p>	5231-P15	1 SPDT MOMENTARY PUSH BUTTON (1-GANG PLATE)	\$58.00
	5231-2P15	2 SPDT MOMENTARY PUSH BUTTON (1-GANG PLATE)	\$82.00
	5231-3P15	3 SPDT MOMENTARY PUSH BUTTON (1-GANG PLATE)	\$112.00
		<u>ENGRAVING OPTIONS SAME AS 5221 ABOVE</u>	
	<u>(SUFFIX)</u>	<u>5231 SWITCH OPTIONS (ADD):</u>	<u>(ADD)</u>
	xL	ADD 1 LED BLACK BEZEL (BICOLOR RED / GREEN)	\$20.00
	<u>(PREFIX)</u>	<u>5231 NARROW SWITCH PLATE OPTIONS</u>	
	N	ADD NARROW 1-3/4" PLATE FOR FRAME MOUNTING	\$6.00
	D	ADD DOUBLE GANG SWITCH PLATE	\$12.00
	5236 SERIES SNAP ACTION MINI BOX		
<u>5236 PUSH BUTTONS ON MINI-BOX CONSOLE</u>			
2-1/2 LONG X 2 WIDE X 1" HIGH			
 <p>5236-P15</p>	5236-P14	1 SPDT MAINTAINED BUTTON MINI-BOX MOUNTED	\$86.00
	5236-2P14	2 SPDT MAINTAINED BUTTONS MINI-BOX MOUNTED	\$110.00
	5236-3P14	3 SPDT MAINTAINED BUTTONS MINI-BOX MOUNTED	\$138.00
	5236-P15	1 SPDT MOMENTARY BUTTON MINI-BOX MOUNTED	\$86.00
	5236-2P15	2 SPDT MOMENTARY BUTTONS MINI-BOX MOUNTED	\$110.00
	5236-3P15	3 SPDT MOMENTARY BUTTONS MINI-BOX MOUNTED	\$138.00
	5236-P24	1 DPDT MAINTAINED BUTTON MINI-BOX MOUNTED	\$116.00
	5236-2P24	2 DPDT MAINTAINED BUTTONS MINI-BOX MOUNTED	\$170.00
	5236-3P24	3 DPDT MAINTAINED BUTTONS MINI-BOX MOUNTED	\$228.00
	5236-P25	1 DPDT MOMENTARY BUTTON MINI-BOX MOUNTED	\$111.00
	5236-2P25	2 DPDT MOMENTARY BUTTONS MINI-BOX MOUNTED	\$160.00
	5236-3P25	3 DPDT MOMENTARY BUTTONS MINI-BOX MOUNTED	\$213.00
	5236-T24	1 DPDT MAINTAINED TOGGLE MINI-BOX MOUNTED	\$116.00
		<u>HEAVY DUTY ALL METAL BUTTONS</u>	
	5236-P24-H	1 DPDT MAINTAINED BUTTON MINI-BOX MOUNTED	\$140.00
	5236-2P24-H	2 DPDT MAINTAINED BUTTONS MINI-BOX MOUNTED	\$190.00
	5236-3P24-H	3 DPDT MAINTAINED BUTTONS MINI-BOX MOUNTED	\$243.00
	5236-P25-H	1 DPDT MOMENTARY BUTTON MINI-BOX MOUNTED	\$140.00
	5236-2P25-H	2 DPDT MOMENTARY BUTTONS MINI-BOX MOUNTED	\$190.00
	5236-3P25-H	3 DPDT MOMENTARY BUTTONS MINI-BOX MOUNTED	\$243.00
<u>(SUFFIX)</u>	<u>SWITCH OPTIONS (ADD TO ABOVE):</u>	<u>(ADD)</u>	
xL	ADD 1 LED (BICOLOR RED / GREEN) 2P-15 ONLY	\$20.00	
xL2	ADD 2 LEDS (BICOLOR RED / GREEN) P-15 ONLY	\$28.00	

ACTUATORS



5240 SERIES

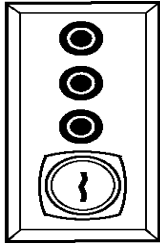

5241-K24x3P15

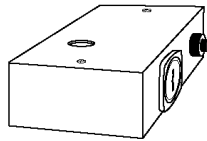

5246-K24xP15

PART #	DESCRIPTION	LIST PRICE
ELECTRICAL KEY SWITCH CONTROLS		
<u>5241 KEY SWITCHES ON SINGLE GANG PLATE</u>		
5241-K12	SP N.O. MOM KEY REMOVABLE ONE POSITION	\$80.00
5241-K24	SPDT-MAINTAIN KEY REMOVABLE TWO POSITIONS	\$70.00
5241-K331	DPDT MAINT. KEY REMOVABLE IN ONE POSITION	\$110.00
5241-K332	DPDT MAINT. KEY REMOVABLE IN TWO POSITIONS	\$110.00
5241-K65-HS	SPDT-HIGH SECURITY KEY REMOVABLE 2 POSITIONS	\$275.00
5246000K	SPARE KEY SPECIFY K24 THRU K332	\$10.00
52400065	SPARE KEY SPECIFY K65-HS	\$40.00
D (Prefix)	DOUBLE GANG SWITCH PLATE	\$20.00
<u>5246 KEY SWITCH ON MINI-BOX CONSOLE</u>		
3-3/4" LONG X 2-1/2" WIDE X 1-1/2" HIGH		
5246-K24	SPDT KEY SWITCH KEY REMOVABLE IN TWO POSITIONS ADD PUSH BUTTONS BELOW AS REQUIRED (3/8" DIA)	\$125.00
5246-2K24	DUAL SPDT KEY SWITCHES KEY REMOVABLE IN TWO POSITIONS ADD MAX 2 PUSH BUTTONS BELOW AS REQUIRED (3/8" DIA)	\$175.00
5246-K331	DPDT KEY SWITCH KEY REMOVABLE IN ONE POSITION ADD PUSH BUTTONS BELOW AS REQUIRED (3/8" DIA)	\$205.00
5246-K332	DPDT KEY SWITCH KEY REMOVABLE IN TWO POSITIONS ADD PUSH BUTTONS BELOW AS REQUIRED (3/8" DIA)	\$205.00
5246-K65-HS	SPDT HIGH SECURITY KEY SWITCH KEY REMOVABLE IN ONE POSITION ADD PUSH BUTTONS BELOW AS REQUIRED (3/8" DIA)	\$290.00
(SUFFIX)	<u>5246 SWITCH OPTIONS (ADD TO ABOVE)</u>	(ADD)
	ANY COMBINATION OF 4 LED'S OR PUSH BUTTONS MAY BE COMBINED w/ 1 KEY SWITCH	
	LEDS	
xL	ADD 1 LED BLACK BEZEL (BICOLOR RED / GREEN)	\$14.00
xL2	ADD 2 LEDS BLACK BEZEL (BICOLOR RED / GREEN)	\$22.00
xL3	ADD 3 LEDS BLACK BEZEL (BICOLOR RED / GREEN)	\$30.00
	SPDT MAINTAINED BUTTONS	
xP14	ADD ONE SPDT MAINTAINED BUTTON	\$25.00
x2P14	ADD TWO SPDT MAINTAINED BUTTONS	\$50.00
x3P14	ADD THREE SPDT MAINTAINED BUTTONS	\$75.00
x4P14	ADD FOUR SPDT MAINTAINED BUTTONS	\$100.00
	SPDT MOMENTARY BUTTONS	
xP15	ADD ONE SPDT MOM PUSH BUTTON	\$25.00
x2P15	ADD TWO SPDT MOM PUSH BUTTONS	\$50.00
x3P15	ADD THREE SPDT MOM PUSH BUTTONS	\$75.00
x4P15	ADD FOUR SPDT MOM PUSH BUTTONS	\$100.00
	DPDT MOMENTARY BUTTONS	
xP25	ADD ONE DPDT MOMENTARY BUTTON	\$50.00
x2P25	ADD TWO DPDT MOMENTARY BUTTONS	\$100.00
x3P25	ADD THREE DPDT MOMENTARY BUTTONS	\$150.00
x4P25	ADD FOUR DPDT MOMENTARY BUTTONS	\$200.00
	DPDT MAINTAINED BUTTONS	
xP24	ADD ONE DPDT MAINTAINED BUTTON	\$55.00
x2P24	ADD TWO DPDT MAINTAINED BUTTONS	\$110.00
x3P24	ADD THREE DPDT MAINTAINED BUTTONS	\$165.00
x4P24	ADD FOUR DPDT MAINTAINED BUTTONS	\$220.00
	HEAVY DUTY ALL METAL BUTTONS	
xP24-H	ADD 1 DPDT MAINTAINED HEAVY DUTY BUTTON	\$80.00
x2P24-H	ADD 2 DPDT MAINTAINED HEAVY DUTY BUTTONS	\$160.00
xP25-H	ADD 1 DPDT MOMENTARY HEAVY DUTY BUTTON	\$80.00
x2P25-H	ADD 2 DPDT MOMENTARY HEAVY DUTY BUTTONS	\$160.00
xT24	ADD 1 DPDT MAINTAINED TOGGLE	\$55.00

ACTUATORS



5276 SERIES

<u>PART #</u>	<u>DESCRIPTION</u>	<u>LIST PRICE</u>
WEATHER PROOF HEAVY DUTY		
<u>1 GANG WR5276 SS BUTTONS</u>		
WR5276-HD28	3/4" ROUND STAINLESS BUTTON WEATHER PROOF IP65 w/ DPST MAINTAIN (1-NO & 1-NC CONTACT) MOUNTED ON SINGLE GANG SS PLATE	\$175.00
WR5276-HD29	3/4" ROUND STAINLESS BUTTON WEATHER PROOF IP65 w/ DPST MOMENTARY (1-NO & 1-NC CONTACT) MOUNTED ON SINGLE GANG SS PLATE	\$175.00
<u>1 GANG ILLUMINATED WR5276 SS BUTTONS</u>		
WR5276-HD28 xLRG	3/4" ROUND STAINLESS BUTTON w/ ILLUMINATED LED RING WEATHER PROOF IP65 w/ DPST MAINTAIN (1-NO & 1-NC CONTACT) 1 GANG SS PLATE	\$185.00
WR5276-HD29 xLRG	3/4" ROUND STAINLESS BUTTON w/ ILLUMINATED LED RING WEATHER PROOF IP65 w/ DPST MOMENTARY (1-NO & 1-NC CONTACT) 1 GANG SS PLATE	\$185.00
<u>NARROW WR5276 SS BUTTONS</u>		
NWR5276-HD28	3/4" ROUND STAINLESS BUTTON WEATHER PROOF IP65 w/ DPST MAINTAIN (1-NO & 1-NC CONTACT) MOUNTED ON NARROW 1-3/4" SS PLATE	\$181.00
NWR5276-HD29	3/4" ROUND STAINLESS BUTTON WEATHER PROOF IP65 w/ DPST MOMENTARY (1-NO & 1-NC CONTACT) MOUNTED ON NARROW 1-3/4" SS PLATE	\$181.00
<u>NARROW ILLUMINATED 5276 SS BUTTONS</u>		
NWR5276-HD28 xLRG	3/4" ROUND STAINLESS BUTTON w/ ILLUMINATED LED RING WEATHER PROOF IP65 w/ DPST MAINTAIN (1-NO & 1-NC CONTACT) MOUNTED ON NARROW 1-3/4" SS PLATE	\$191.00
NWR5276-HD29 xLRG	3/4" ROUND STAINLESS BUTTON w/ ILLUMINATED LED RING WEATHER PROOF IP65 w/ DPST MOMENTARY (1-NO & 1-NC CONTACT) MOUNTED ON NARROW 1-3/4" SS PLATE	\$191.00
<u>(SUFFIX)</u>		<u>(ADD)</u>
xAT	1-60 SECOND TIMER DPDT RELAY OUTPUT	\$100.00
xFT	FIXED 30 SECOND TIMER DPDT RELAY OUTPUT	\$100.00
<u>(PREFIX)</u>		
D	DOUBLE GANG SWITCH PLATE	\$20.00
<u>(SUFFIX)</u>		<u>ENGRAVING OPTIONS</u>
xE1	PLATE ENGRAVED "PUSH TO EXIT"	\$18.00
xE2	PLATE ENGRAVED "PANIC"	\$18.00
xE3	PLATE ENGRAVED "EMERGENCY RELEASE"	\$18.00
xE4	PLATE ENGRAVED "PUSH TO RELEASE"	\$18.00
xE5	PLATE ENGRAVED "EMERGENCY DOOR RELEASE"	\$18.00
xE6	PER PLATE FEE AFTER SET UP	\$24.00
(ORDER AS LINE ITEM)--- XE6SETUP	CUSTOM ENGRAVING 1 SET UP FEE PER RUN	\$60.00
XHCP	HANDICAP LOGO BLUE ENGRAVING	\$40.00

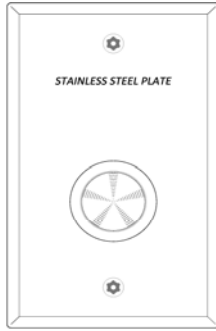

WR5276-HD28

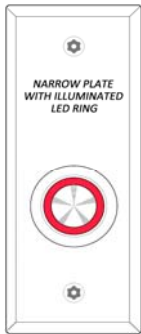

NWR5276-HD28xLRG

ACTUATORS



5276 SERIES

<u>PART #</u>	<u>DESCRIPTION</u>	<u>LIST PRICE</u>
---------------	--------------------	-------------------



5276-MP9/BxE1



N5276-HD28xE2

1" DIAMETER PUSH BUTTONS

5276-G SERIES 1" GUARDED PUSH BUTTONS

5276-GP8/*	ALTERNATE ACTION PUSH BUTTON SWITCH DPST GUARD MOUNTED ON SINGLE GANG PLATE	\$150.00
5276-GP9/*	MOMENTARY ACTION PUSH BUTTON SWITCH DPST GUARD MOUNTED ON SINGLE GANG PLATE	\$90.00
5276-GP23DA/*	PNEUMATIC 2-60 SEC. DELAY (FORM Z) GUARDED SWITCH ON SINGLE GANG BACK PLATE	\$290.00

5276 SERIES HEAVY DUTY PUSH BUTTONS

5276-HD23DA	HEAVY DUTY (VANDAL RESISTANT) 1" STEEL PUSH BUTTON PNEUMATIC 2-60 SEC. DELAY (FORM Z) ON SINGLE GANG STAINLESS STEEL BACK PLATE	\$385.00
5276-HD28	HEAVY DUTY (VANDAL RESISTANT) 1" STEEL PUSH BUTTON ALTERNATE ACTION (DPDT) SWITCH MOUNTED ON STANDARD S/S SINGLE GANG PLATE	\$175.00
5276-HD29	HEAVY DUTY (VANDAL RESISTANT) 1" STEEL PUSH BUTTON MOMENTARY (DPDT) SWITCH MOUNTED ON STANDARD S/S SINGLE GANG PLATE	\$175.00

<u>(SUFFIX)</u>	<u>5276 SERIES OPTIONS ADD TO ABOVE</u>	<u>(ADD)</u>
-----------------	---	--------------

xAT	ADJUSTABLE 1 - 60 SEC. TIMER DPDT OUTPUT	\$100.00
xFT	FIXED 30 SECOND TIMER DPDT RELAY OUTPUT	\$100.00
xL	(FOR HEAVY DUTY xHD SERIES CHROME BEZEL)	\$24.00

<u>(PREFIX)</u>		
N	NARROW 1-3/4" PLATE	\$6.00
D	DOUBLE GANG SWITCH PLATE	\$12.00

<u>(SUFFIX)</u>	<u>AVAILABLE ON 5276-MP & GP SERIES ONLY</u>	
-----------------	--	--

/R	* DESIGNATES RED BUTTON CAP	N/C
/B	* DESIGNATES BLACK BUTTON CAP	N/C
/G	* DESIGNATES GREEN BUTTON CAP (NON STOCK)	N/C

<u>(SUFFIX)</u>	<u>ENGRAVING OPTIONS</u>	
-----------------	--------------------------	--

xE1	PLATE ENGRAVED "PUSH TO EXIT"	\$18.00
xE2	PLATE ENGRAVED "PANIC"	\$18.00
xE3	PLATE ENGRAVED "EMERGENCY RELEASE"	\$18.00
xE4	PLATE ENGRAVED "PUSH TO RELEASE"	\$18.00
xE5	PLATE ENGRAVED "EMERGENCY DOOR RELEASE"	\$18.00
xE6	PER PLATE FEE AFTER SET UP	\$24.00
(ORDER AS LINE ITEM)---- XE6SETUP	CUSTOM ENGRAVING 1 SET UP FEE PER RUN	\$60.00
XHCP	HANDICAP LOGO BLUE ENGRAVING	\$40.00

ACTUATORS



<u>PART #</u>	<u>DESCRIPTION</u>	<u>LIST PRICE</u>
---------------	--------------------	-------------------

5277 SERIES PIEZO ELECTRIC SWITCHES



W5277-PZLXE1

W5277-PZL

5277 SERIES PIEZO ELECTRIC SWITCHES

TIME DELAY (1-60 SECOND) PIEZO SWITCH
1 SET N.O. 1 SET N.C. CONTACTS WITH ILLUMINATED
BI COLOR LED RING MOUNTED ON STANDARD
STAINLESS STEEL 1 GANG PLATE COMPLETELY
SEALED FOR WEATHER RESISTANCE

\$275.00



N5277-PZLXE3

N5277-PZL

TIME DELAY (1-60 SECOND) PIEZO SWITCH
1 SET N.O. 1 SET N.C. CONTACTS WITH ILLUMINATED
BI COLOR LED RING MOUNTED ON NARROW 1-3/4"
STAINLESS STEEL PLATE COMPLETELY SEALED FOR
WEATHER RESISTANCE

\$275.00

(SUFFIX)

5277 STOCK ENGRAVING (ADD)

xE1

ADD "PUSH TO EXIT" IN RED LETTERS (W Series only)

(ADD)

\$20.00

xE3

ADD "EXIT" IN RED LETTERS

\$20.00

5277 CUSTOM ENGRAVING (ADD)

xE6

PER PLATE FEE AFTER SET UP

\$24.00

(ORDER AS LINE ITEM)---- XE6SETUP

CUSTOM ENGRAVING 1 SET UP FEE PER RUN

\$60.00

5278 SERIES TOUCHLESS ELECTRIC SWITCHES

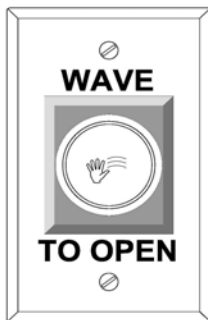

W5278-25XE1W

W5278-25

5278 SERIES TOUCHLESS ELECTRIC SWITCHES

INFRARED PROXIMITY ACTIVATED SWITCH
DOUBLE POLE DOUBLE THROW RELAY CONTACTS
WITH ILLUMINATED BI COLOR LED RING MOUNTED
ON STAINLESS STEEL 1 GANG PLATE (12VDC)

\$106.00

D5278-25

INFRARED PROXIMITY ACTIVATED SWITCH
DOUBLE POLE DOUBLE THROW RELAY CONTACTS
WITH ILLUMINATED BI COLOR LED RING MOUNTED
ON STAINLESS STEEL 2 GANG PLATE (12VDC)

\$118.00

(SUFFIX)

5278 STOCK ENGRAVING (ADD)

xE1W

ADD "WAVE TO OPEN" IN BLACK LETTERS

\$12.00

xE3

ADD "EXIT" IN BLACK LETTERS

\$12.00

5278 CUSTOM ENGRAVING (ADD)

xE6

PER PLATE FEE AFTER SET UP

\$24.00

(ORDER AS LINE ITEM)---- XE6SETUP

CUSTOM ENGRAVING 1 SET UP FEE PER RUN

\$60.00

ACTUATORS



5286 SERIES

PART #	DESCRIPTION	LIST PRICE
--------	-------------	------------

PUSH PLATE SWITCHES

NARROW STYLE PUSH PLATE SWITCHES



N5286-P25xE1

N5286-P24	DPDT MAINTAINED ACTION SWITCH WITH 1-1/2" WIDE PUSH PLATE ON 1-3/4" ALUMINUM BACK PLATE	\$114.00
N5286-P25	DPDT MOMENTARY ACTION SWITCH WITH 1-1/2" WIDE PUSH PLATE ON 1-3/4" ALUMINUM BACK PLATE	\$100.00
N5286-P23DA	PNEUMATIC 2-60 SECOND DELAY (FORM Z) SWITCH WITH 1-1/2" WIDE PUSH PLATE ON 1-3/4" ALUMINUM BACK PLATE	\$332.00
N5286-AT	ADJUSTABLE 2-60 SECOND TIMER DPDT OUTPUT	\$186.00
N5286-FT	FIXED 30 SECOND TIMER DPDT RELAY OUTPUT	\$186.00
N5286-ET	ADJUSTABLE 2-60 SEC. EXIT TIMER DPDT OUTPUT	\$220.00

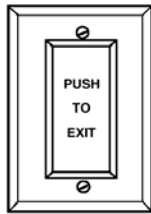

W5286-P25xE1

<u>SINGLE GANG PUSH PLATE SWITCHES</u>		
W5286-P24	DPDT MAINTAINED ACTION SWITCH WITH 1-1/2" WIDE PUSH PLATE ON 3" WIDE ALUMINUM BACK PLATE	\$114.00
W5286-P25	DPDT MOMENTARY ACTION SWITCH WITH 1-1/2" WIDE PUSH PLATE ON 3" WIDE ALUMINUM BACK PLATE	\$100.00
W5286-P23DA	PNEUMATIC 2-60 SEC. DELAY (FORM Z) SWITCH WITH 1-1/2" WIDE PUSH PLATE ON 3" WIDE BACK PLATE	\$332.00
W5286-AT	ADJUSTABLE 2-60 SECOND TIMER DPDT OUTPUT	\$186.00
W5286-FT	FIXED 30 SECOND TIMER DPDT RELAY OUTPUT	\$186.00
W5286-ET	ADJUSTABLE 2-60 SEC. EXIT TIMER DPDT OUTPUT	\$220.00

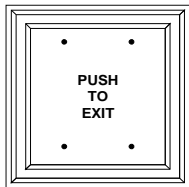

D5286-P25xE1

<u>DOUBLE GANG PUSH PLATE SWITCHES</u>		
D5286-P24	DPDT MAINTAINED ACTION SWITCH WITH 4" WIDE PUSH PLATE ON 4-5/8" WIDE ALUMINUM BACK PLATE	\$138.00
D5286-P25	DPDT MOMENTARY ACTION SWITCH WITH 4" WIDE PUSH PLATE ON 4-5/8" WIDE ALUMINUM BACK PLATE	\$126.00
D5286-P23DA	PNEUMATIC 2 - 60 SEC. DELAY (FORM Z) SWITCH WITH 4" PUSH PLATE ON 4-5/8" WIDE BACK PLATE	\$356.00
D5286-AT	ADJUSTABLE 2-60 SECOND TIMER DPDT OUTPUT	\$210.00
D5286-FT	FIXED 30 SECOND TIMER DPDT RELAY OUTPUT	\$210.00
D5286-ET	ADJUSTABLE 2-60 SEC. EXIT TIMER DPDT OUTPUT	\$245.00
<u>(SUFFIX)</u>		<u>(ADD)</u>
xL	ADD 1 LED BLACK BEZEL (BICOLOR RED / GREEN) RECESSED INTO PUSH PAD (NOT AVAILABLE ON "D" SERIES)	\$28.00

***** PLEASE SEE PAGE 29 FOR ENGRAVING & FINISH OPTIONS*****

ACTUATORS



5286 SERIES

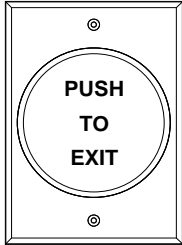

R5286-P25xE1

<u>PART #</u>	<u>DESCRIPTION</u>	<u>LIST PRICE</u>
ROUND PUSH PLATE SWITCHES		
<u>ROUND PUSH PLATE SWITCHES</u>		
R5286-P24	DPDT MAINTAINED ACTION SWITCH WITH 2-1/2" ROUND PALM BUTTON ON 3" WIDE ALUMINUM BACK PLATE	\$120.00
R5286-P25	DPDT MOMENTARY ACTION SWITCH WITH 2-1/2" ROUND PALM BUTTON ON 3" WIDE ALUMINUM BACK PLATE	\$110.00
R5286-P23DA	PNEUMATIC 2-60 SECOND DELAY (FORM Z) SWITCH WITH 2-1/2" ROUND PALM BUTTON ON 3" WIDE ALUMINUM BACK PLATE	\$332.00
R5286-AT	ADJUSTABLE 2-60 SECOND TIMER DPDT OUTPUT	\$196.00
R5286-FT	FIXED 30 SECOND TIMER DPDT RELAY OUTPUT	\$196.00
R5286-ET	ADJUSTABLE 2-60 SEC. EXIT TIMER DPDT OUTPUT	\$245.00
<u>(SUFFIX)</u>		<u>(ADD)</u>
xL	ADD 1 LED BLACK BEZEL (BICOLOR RED / GREEN)	\$14.00

***** PLEASE SEE NEXT PAGE FOR ENGRAVING & FINISH OPTIONS*****

ACTUATORS



5286 SERIES	PART #	DESCRIPTION	LIST PRICE
		CUSTOM FINISHES & ENGRAVING	
		<u>5286 STOCK ENGRAVING (ADD)</u>	
	<u>(SUFFIX)</u>		<u>(ADD)</u>
	xE1	ADD "PUSH TO EXIT" IN BLACK LETTERS	\$18.00
	xE1R	ADD "PUSH TO EXIT" IN RED LETTERS	\$18.00
	xE2	ADD "PANIC" IN RED LETTERS	\$18.00
	xE3	ADD "EXIT" IN RED LETTERS	\$18.00
	xE4	ADD "DOOR RELEASE" IN BLACK LETTERS	\$18.00
	xE5	ADD "EMERGENCY DOOR RELEASE" IN RED LETTERS	\$20.00
	xE6	PER PLATE FEE AFTER SET UP	\$24.00
(ORDER AS LINE ITEM)----	XE6SETUP	CUSTOM ENGRAVING 1 SET UP FEE PER RUN	\$60.00
	<u>(SUFFIX)</u>	<u>5286 STANDARD HANDICAP LOGOS</u>	<u>(ADD)</u>
	xHCP	ADD FOR BLUE LOGO ON CLEAR ALUMINUM ONLY	\$42.00
	xHCP2	ADD FOR BLUE LOGO W/ "PUSH TO OPEN" ON CLEAR ALUMINUM	\$50.00
	xHCP3	ADD FOR WHITE LOGO ON BLUE PLATE W / "PUSH TO OPEN" ENGRAVED (D-SERIES ONLY)	\$90.00
		ENGRAVING ON RED, BLACK & DARK BRONZE PUSH PLATES WILL BE WHITE	
	<u>(SUFFIX)</u>	<u>5286 SERIES FINISH OPTIONS</u>	<u>(ADD)</u>
	xBRE	ADD FOR BAKED RED ENAMEL FINISH (NON-STOCK)	\$32.00
	xDBA	ADD FOR DARK BRONZE ANODIZED (STOCKED) (IF BUTTON IS XBRE OR XDBA TEXT IS WHITE)	\$32.00
	xUS26	ADD FOR POLISHED CHROME -	
	xUS26D	ADD FOR SATIN CHROME -	
	xUS3	ADD FOR POLISHED BRASS -	
	xUS4	ADD FOR SATIN BRASS -	
		ALL PLATED FINISHES - (N,W & R SERIES)	\$190.00
		ALL PLATED FINISHES - (D SERIES)	\$240.00

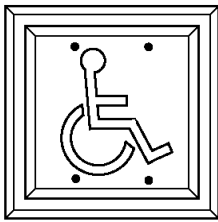

D5286-P25xHCP

ACTUATORS



5287 SERIES

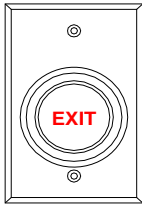

W5287xE3

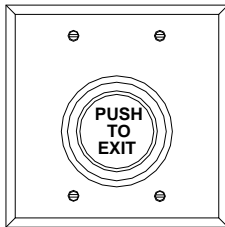

D5287xE1

(ORDER AS LINE ITEM)---- XE6SETUP

<u>PART #</u>	<u>DESCRIPTION</u>	<u>LIST PRICE</u>
HEAVY DUTY PUSH BUTTON SWITCHES		
<u>SINGLE GANG PUSH BUTTON SWITCHES</u>		
W5287-P24	DPDT MAINTAINED ACTION SWITCH WITH 1-1/2" DIAMETER BUTTON ON ALUMINUM BACK PLATE	\$140.00
W5287-P25	DPDT MOMENTARY ACTION SWITCH WITH 1-1/2" DIAMETER BUTTON ON ALUMINUM BACK PLATE	\$138.00
W5287-P23DA	PNEUMATIC 2 - 60 SEC. DELAY (FORM Z) SWITCH WITH 1-1/2" DIAMETER BUTTON ON ALUMINUM BACK PLATE	\$360.00
W5287-AT	ADJUSTABLE 1 - 60 SECOND TIMER DPDT OUTPUT WITH 1-1/2" DIAMETER BUTTON ON ALUMINUM BACK PLATE	\$205.00
W5287-FT	FIXED 30 SECOND TIMER DPDT OUTPUT WITH 1-1/2" DIAMETER BUTTON ON 3" WIDE ALUMINUM BACK PLATE	\$205.00
W5287-ET	ADJUSTABLE 1 - 60 SECOND EXIT TIMER DPDT OUTPUT WITH 1-1/2" DIAMETER BUTTON ON ALUMINUM BACK PLATE	\$230.00
<u>DOUBLE GANG PUSH PLATE SWITCHES</u>		
D5287-	CHANGE "W" TO "D" TO SPECIFY A DOUBLE GANG 4-5/8" WIDE ALUMINUM BACK PLATE WITH 1-1/2" DIAMETER BUTTON	(ADD) \$40.00
<u>(SUFFIX)</u>	<u>5287 STOCK ENGRAVING (ADD):</u>	<u>(ADD)</u>
xE1	ADD "PUSH TO EXIT" IN BLACK LETTERS	\$18.00
xE1R	ADD "PUSH TO EXIT" IN RED LETTERS	\$18.00
xE3	ADD "EXIT" IN RED LETTERS	\$18.00
xE6	PER PLATE FEE AFTER SET UP	\$24.00
	CUSTOM ENGRAVING 1 SET UP FEE PER RUN	\$60.00
<u>5287 STANDARD HANDICAP LOGOS</u>		
xHCP	ADD HANDICAP BLUE LOGO ON CLEAR ALUMINUM	\$40.00
xHCP3	ADD HANDICAP WHITE LOGO ON BLUE ALUMINUM	\$40.00
<u>(SUFFIX)</u>	<u>5287 SERIES FINISH OPTIONS</u>	<u>(ADD)</u>
xDBA	ADD FOR DARK BRONZE ANODIZED	\$32.00
xBRE	ANODIZED RED FINISH (ON BUTTON ONLY) BACK PLATE CLEAR ANODIZED OR PLATED FINISH (IF BUTTON IS XBRE XSBA OR XDBA TEXT IS WHITE)	\$32.00
xUS26	ADD FOR POLISHED CHROME -	
xUS26D	ADD FOR SATIN CHROME -	
xUS3	ADD FOR POLISHED BRASS -	
xUS4	ADD FOR SATIN BRASS -	
	ALL PLATED FINISHES - (W SERIES)	\$190.00
	ALL PLATED FINISHES - (D SERIES)	\$240.00
<u>(SUFFIX)</u>		<u>(ADD)</u>
xL	ADD 1 LED (BICOLOR RED / GREEN) CHROME BEZEL FOR HEAVY DUTY SERIES	\$24.00

ACCESSORIES



6200 SERIES	PART #	DESCRIPTION	LIST PRICE
	DOOR CORD		

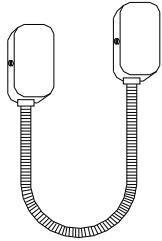

6220		6200 SERIES DOOR CORD 18" ARMORED DOOR CORD WITH SURFACE MOUNT J-BOX 1-5/8" WIDE x 3" LONG x 1-1/8" DEEP (INCLUDES 4 CONDUCTOR 22 AWG CABLE) STANDARD COLOR ALUMINUM	\$50.00
	(SUFFIX)	ARMORED DOOR CORD FINISHES (ADD):	
	xDBA	ADD FOR DARK BRONZE COLORED CORD AND J-BOX ARMORED DOOR CORD	N/C

A DOOR CORD IS TYPICALLY REQUIRED TO TRANSFER POWER TO AN EGRESS BAR

6400 SERIES	EGRESS BARS
--------------------	--------------------



6400 SERIES EGRESS SWITCH BARS

6420-S25		EGRESS BAR FOR 36" DOOR WITH DUAL SPDT SWITCHES STANDARD ALUMINUM FINISH	\$405.00
6495		RIM STYLE MECHANICAL LATCHING FOR 36" DOOR UL LISTED PANIC DEVICE (NO SWITCH)	\$320.00
6495-S25		RIM STYLE MECHANICAL LATCHING FOR 36" DOOR PANIC DEVICE WITH 2 SPDT SWITCHES	\$420.00
	(SUFFIX)	WEATHERPROOF SWITCHES	(ADD)
	xWR	DUAL SEALED WEATHERPROOF SPDT SWITCHES FOR OUTDOOR APPLICATIONS	\$90.00
	(SUFFIX)	EGRESS BAR SPECIAL FINISHES:	(ADD)
	xDBA	ADD FOR DARK BRONZE ANODIZED FINISH	\$16.00
	X48	ADD FOR DOORS OVER 36" UP TO 48" (NON STOCK)	\$40.00

6450 SERIES	LEVER TRIM
--------------------	-------------------



6450 SERIES LEVER TRIM DEVICE

xK		LEVER TRIM WORKS WITH 6495 SERIES RIM PANIC STANDARD 1-1/8" MORTISE CYLINDER & 2 KEYS	\$245.00
xDBA		DARK BRONZE FINISH	\$40.00 N.C.

ACCESSORIES



6500 SERIES

PART # DESCRIPTION LIST PRICE

EMERGENCY PULL STATIONS

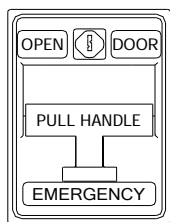

<u>6500 SERIES EMERGENCY PULL STATIONS</u>		
6510/*-S35	PULL STATION W/ TWO SPDT (FORM C) SWITCHES	\$175.00
6510/*-S35xCS	PULL STATION W/ TWO SPDT (FORM C) SWITCHES WITH LOCAL PIEZO 12-24VDC	\$205.00
* SPECIFY COLOR:		
/BL = BLUE ENAMEL FINISH		
/BK = BLACK ENAMEL FINISH		
/YL = YELLOW ENAMEL FINISH		

SURFACE MOUNT COLORED BACK BOXES

4-7/8 H x 3-1/2 W x 2" D

6510/BX-BK	BLACK SURFACE MOUNT BACK BOX	\$65.00
6510/BX-BL	BLUE SURFACE MOUNT BACK BOX	\$65.00
6510/BX-YL	YELLOW SURFACE MOUNT BACK BOX	\$65.00



6510/COV

6510 SERIES ANTI TAMPER COVERS

FLUSH MOUNT STYLE 2-1/2" DEEP ID

6510/COV	4-7/8"W x 5-1/2"H x 2-1/2"D LIFT TO ACCESS PULL	\$140.00
6510/COV/S	SAME AS ABOVE WITH PIEZO ALARM SOUNDER	\$245.00
6510/COV/SR	ANTI-TAMPER COVER W/SOUNDER & SPDT RELAY	\$260.00

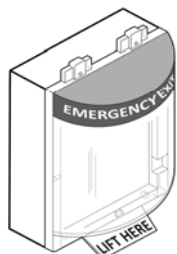

6510/COV-X

SURFACE MOUNT STYLE 3-7/8" DEEP ID
W/ EXTENSION FOR USE WITH 6510 BACK BOX

6510/COV-X	4-7/8"W x 5-1/2"H x 3-7/8"D LIFT TO ACCESS PULL	\$175.00
6510/COV/S-X	SAME AS ABOVE WITH PIEZO ALARM SOUNDER	\$280.00
6510/COV/SR-X	ANTI-TAMPER COVER W/SOUNDER & SPDT RELAY	\$370.00

(ORDER AS LINE ITEM)---	<u>(SUFFIX)</u>
	XE6SETUP
	XE6
	651000K
	6510/BR
	65-6581

<u>ACCESSORIES</u>	<u>(ADD)</u>
CUSTOM LABELING SETUP	\$60.00
PER UNIT FEE AFTER SET UP	\$20.00
SPARE KEY FOR 6510-S35 PULL	\$10.00
BREAK RODS 12 PER PACK	\$24.00
BACK PLATE FOR 6510/COV ,COV/S & COV/SR FOR MOUNTING TO UNEVEN SURFACE	\$38.00

6600 SERIES

MOTION DETECTORS

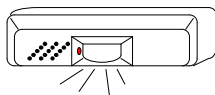

6612	UL LISTED REQUEST-TO-EXIT PIR MOTION DETECTOR (12/24 VDC) w/ ADJUSTABLE (1-120 SECOND) TIME DELAY IN A SLIM LINE 7.1" x 1.65" x 1.65" IVORY COLORED CASE (ONE DPDT FORM C ALARM OUTPUT)	\$240.00
------	---	----------

ANNUNCIATORS



7101 SERIES	PART #	DESCRIPTION	LIST PRICE
		DELAYED EGRESS CONTROLLERS	

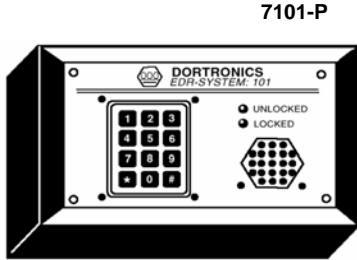

7101-P

EDR SYSTEM-101 CONTROLLER

EDR-101 DELAYED EGRESS CONTROL PANEL
KEYPAD CONSOLE, AUDIBLE ALERT, 3 SECOND NUISANCE / 15 SECOND ALARM DELAY, PROGRAMMABLE CLOCK / DAY SCHEDULER, 3 STATUS OUTPUTS, PROGRAMMABLE ESCORT CODE FOR KEYPAD (OR OPTIONAL KEY SWITCH) INCLUDES 12 VDC 1 AMP POWER SUPPLY, WITH 9 VOLT RECHARGEABLE BATTERY, 3 GANG S/S FLUSH MOUNT PLATE, 3 GANG (IVORY) SURFACE MOUNT BOX, AND 20 FOOT LONG HOOK-UP CABLES

\$1,280.00

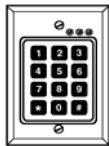

7101-KP

EDR SYSTEM-101 ACCESSORIES:

AUXILIARY KEYPAD - SUPPLIED WITH 15 FOOT CABLE, WEATHER RESISTANT FOR AUTHORIZED ACCESS FROM SECURED SIDE

\$430.00



5141-24xK

DPDT MAINTAINED KEY SWITCH - EDR-101 ALARM SHUNT / BY-PASS SEE PAGE 19 FOR DETAILED DESCRIPTION

\$166.00



5216-MP23xE3

PUSH BUTTON SWITCH - EMERGENCY RELEASE SEE PAGE 20 FOR DETAILED DESCRIPTION

\$148.00



6420-S25

EGRESS BAR w/ TWO SPDT SWITCHES
(ACTIVATES EDR-101 & HAS 1 EXTRA OUTPUT)
SEE PAGE 31 FOR DETAILS

\$405.00

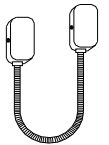

6220

6200 SERIES DOOR CORD
18" ARMORED DOOR CORD WITH SURFACE MOUNT J-BOX (INCLUDES 4 CONDUCTOR 22 AWG CABLE) STANDARD COLOR ALUMINUM

\$50.00

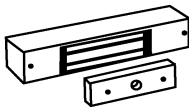

1110xD

SINGLE DOOR 1200 LB LOCK w/ DOOR SWITCH
(FOR USE w/ EDR-101 & 6420-S25 EGRESS BAR RELEASE)

\$460.00

1107xEDR

SINGLE DOOR 600 LB LOCK w/ DPS & ATTEMPTED EGRESS SWITCH (FOR USE w/ EXISTING HDWR.)

\$600.00

1110xEDR

SINGLE DOOR 1200 LB LOCK w/ DPS & ATTEMPTED EGRESS SWITCH (FOR USE w/ EXISTING HDWR.)

\$640.00

NOTE: FOR DOUBLE DOORS USE TWO (2) LOCKS WHICH MAY REQUIRE ADDITIONAL POWER @12V

ANNUNCIATORS



7201 SERIES

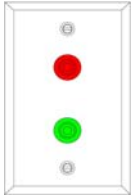

7201xL2-H

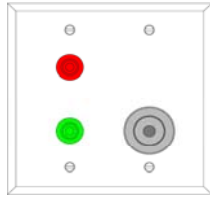

7202xL2-HxCs

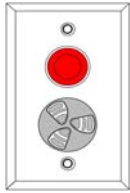

7201xL1R-HWRxCsW

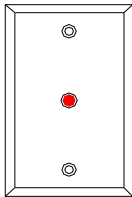

7201xL1

(ORDER AS LINE ITEM)----

PART #	DESCRIPTION	LIST PRICE
HI-INTENSITY LED INDICATORS		
	<u>7201-H HI-INTENSITY LEDS 11/16" DIA.</u>	
7201xL1*-H	1 HIGH INTENSITY LED MOUNTED ON A 1 GANG STAINLESS STEEL PLATE	\$60.00
7201xL1*-HxCs	1 HIGH INTENSITY LED 1 PIEZO MOUNTED ON A 1 GANG STAINLESS STEEL PLATE	\$90.00
7201xL2-H	1 EACH RED/GREEN HIGH INTENSITY LED MOUNTED ON A 1 GANG STAINLESS STEEL PLATE	\$112.00
7202xL2-HxCs	1 EACH RED/GREEN HIGH INTENSITY LED 1 PIEZO MOUNTED ON A 2 GANG STAINLESS STEEL PLATE	\$142.00
	* SPECIFY LED COLOR R=RED G=GREEN	
	<u>7201-HWR WATER PROOF HI-INTENSITY LEDS 1" DIA.</u>	
7201xL1*-HWR	1 WATER PROOF HIGH INTENSITY LED MOUNTED ON A 1 GANG STAINLESS STEEL PLATE	\$66.00
7201xL1*-HWRxCsW	1 WATER PROOF HIGH INTENSITY LED 1 WATER PROOF (12VDC) PIEZO MOUNTED ON A 1 GANG STAINLESS STEEL PLATE	\$122.00
7201xL2-HWR	1 EACH WATER PROOF RED/GREEN HIGH INTENSITY LED MOUNTED ON A 1 GANG STAINLESS STEEL PLATE	\$120.00
7202xL2-HWRxCsW	1 EACH WATER PROOF RED/GREEN HIGH INTENSITY LED 1 WATER PROOF (12VDC)PIEZO MOUNTED ON A 2 GANG STAINLESS STEEL PLATE	\$176.00
STANDARD LED INDICATORS		
	<u>7201 STANDARD LEDS SMALL DIA. 3/16"</u>	
7201xL1	1 BICOLOR LED WITH CHROME BEZEL MOUNTED ON A 1 GANG STAINLESS STEEL PLATE	\$52.00
7201xL2	2 BICOLOR LEDS WITH CHROME BEZEL MOUNTED ON A 1 GANG STAINLESS STEEL PLATE	\$76.00
7201xCs	PIEZO CONTINUOUS SOUNDER ON 1 GANG SS	\$46.00
7201xCsW	WATER PROOF (12VDC) PIEZO SOUNDER ON 1 GANG SS PLATE	\$72.00
PIEZO SOUNDERS CONTINUOUS 12-24VDC		
(SUFFIX)	<u>ADD OPTIONAL PIEZO CONTINUOUS SOUNDERS</u>	<u>(ADD)</u>
xCs	ADD PIEZO SOUNDER	\$30.00
xCsW	ADD WATER PROOF PIEZO SOUNDER	\$60.00
xCsW-A	ADD WATER PROOF PIEZO W/ADJ. VOLUME	\$80.00
(SUFFIX)	<u>ADD OPTIONAL LEDS</u>	<u>(ADD)</u>
xL	ADD FOR EACH BICOLOR LED W/CHROME BEZEL	\$24.00
(SUFFIX)	<u>ADD OPTIONAL SWITCHES</u>	<u>(ADD)</u>
xT24	ADD FOR EACH DPDT-MAINTAINED TOGGLE	\$40.00
xT25	ADD FOR EACH DPDT-MOMENTARY TOGGLE	\$40.00
xP14	ADD FOR EACH SPDT-MAINT.PUSH BUTTON	\$25.00
xP15	ADD FOR EACH SPDT-MOM PUSH BUTTON	\$25.00
xP25	ADD FOR EACH DPDT-MOM PUSH BUTTON	\$45.00
	<u>ADD CUSTOM ENGRAVING</u>	
xE6	PER PLATE FEE AFTER SET UP	\$24.00
(ORDER AS LINE ITEM)---- XE6SETUP	CUSTOM ENGRAVING 1 SET UP FEE PER RUN	\$60.00
(PREFIX)	<u>ADD OPTIONAL MOUNTING PLATES</u>	<u>(ADD)</u>
D	DOUBLE GANG SWITCH PLATE	\$12.00
N	NARROW 1-3/4" PLATE FOR FRAME MOUNTING	\$8.00

ANNUNCIATORS



7200 SERIES

PART # DESCRIPTION LIST PRICE

MULTI-ZONE ANNUNCIATORS

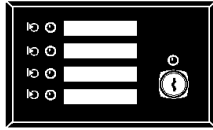

7204

7204

7200 SERIES CUSTOM ANNUNCIATORS

THREE GANG PLATE WITH 4-ZONE OVERLAY ADD FOR LEDS, TOGGLE SWITCHES, PUSH BUTTONS, KEYSWITCH AND SOUNDER - COMPONENTS ALL HAVE FLYING LEADS (NO LOGIC OR TERMINALS INCLUDED)

\$250.00

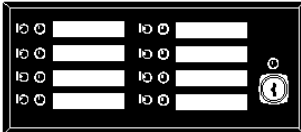

7208

7208

FOUR GANG PLATE WITH 8-ZONE OVERLAY ADD FOR LEDS, TOGGLE SWITCHES, PUSH BUTTONS, KEYSWITCH AND SOUNDER - COMPONENTS ALL HAVE FLYING LEADS (NO LOGIC OR TERMINALS INCLUDED)

\$290.00

8 + ZONE PANELS ADD \$25.00 FOR EACH ZONE OVER 8 ZONES

EA. ZONE \$25.00

NOTE: CUSTOM & RACK MOUNT CONFIGURATIONS AVAILABLE TO SUIT INDIVIDUAL APPLICATIONS

(Call for quote)

7202-ENCL

SLOPED DESK TOP CONSOLE 2 GANG PLATE

\$300.00

7604/8-ENCL

SLOPED DESK TOP CONSOLE 4-8 ZONES
9" X 6" X 2-3/4" ALUMINUM BLACK ENAMEL FINISH

\$400.00

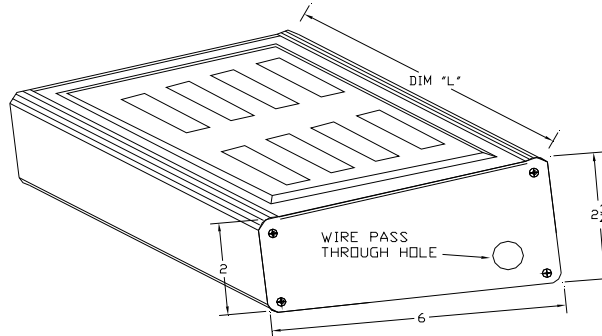

(SUFFIX)

xL
xT24
xT25
xP14
xP15
xP24
xP25
xCS
xK24
xTERM

7200 SERIES ADD ON COMPONENTS

ADD FOR EACH BICOLOR LED W/CHROME BEZEL \$24.00
ADD FOR EACH DPDT-MAINT.TOGGLE SWITCH \$55.00
ADD FOR EACH DPDT-MOM.TOGGLE SWITCH \$55.00
ADD FOR EACH SPDT-MAINT.PUSH BUTTON \$25.00
ADD FOR EACH SPDT-MOM. PUSH BUTTON \$25.00
ADD FOR EACH DPDT-MAINT. PUSH BUTTON \$55.00
ADD FOR EACH DPDT-MOM. PUSH BUTTON \$50.00
ADD PIEZO SOUNDER \$30.00
ADD SPDT MAINTAINED KEY SWITCH \$70.00
10 POSITION DOUBLE ROW TERMINAL 6 1/2" LONG \$30.00

(ADD)

xE6

ADD CUSTOM ENGRAVING

FOR STAINLESS 3&4 GANG PLATES WITHOUT OVERLAY PER PLATE FEE AFTER SET UP \$50.00
ADD PER GANG FEE OVER 4 GANG PLATE \$40.00
CUSTOM ENGRAVING 1 SET UP FEE PER RUN \$120.00

(ORDER AS LINE ITEM)---- XE6SETUP

NOTE: 7200 SERIES ANNUNCIATORS ARE SUPPLIED WITH FLYING LEADS ONLY. FACTORY PRE-WIRED UNITS AVAILABLE UPON REQUEST (Call for quote)

ANNUNCIATORS



7281 SERIES

PART # LOCAL DOOR EXIT ALARMS

LIST PRICE

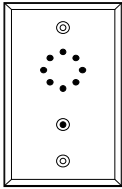

7281-EA

7281-EA

EXIT ALARM

DOOR ALARM WITH ADJUSTABLE (2 TO 60 SECONDS) DELAY, ALARM OUTPUT (DPDT) RELAY, TRI-STATE LED, AND LOCAL ALARM PIEZO (RESET ON DOOR RE-SECURE) ON STANDARD SINGLE GANG PLATE

\$235.00

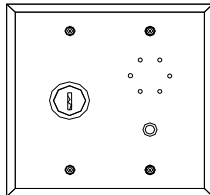

7281-EAxK332

7281-EAxK332

EXIT ALARM WITH KEY SWITCH RESET

DOOR ALARM WITH ADJUSTABLE (2 TO 60 SECONDS) DELAY, ALARM OUTPUT (DPDT) RELAY, TRI-STATE LED, AND LOCAL ALARM PIEZO RESET BY DPDT MAINTAINED ELECTRIC KEYSWITCH PROVIDED. KEY REMOVABLE IN 2 POSITIONS ON STANDARD DOUBLE GANG PLATE

\$295.00

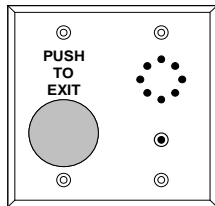

7281-EAxMP23xE1

7281-EAxMP23

EXIT ALARM WITH PUSH BUTTON

DOOR ALARM WITH ADJUSTABLE (2 TO 60 SECONDS) DELAY, ALARM OUTPUT (DPDT) RELAY, TRI-STATE LED, AND LOCAL ALARM PIEZO (RESET ON DOOR RE-SECURE). INCLUDES MOMENTARY REX BUTTON 1-9/16" DIAMETER ON STANDARD DOUBLE GANG PLATE

\$365.00

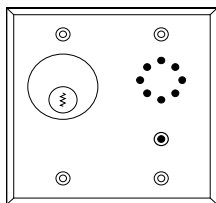

7281-EA-K24xK

7281-EAxK24

EXIT ALARM FOR MORTISE CYLINDER

DOOR ALARM WITH ADJUSTABLE (2 TO 60 SECONDS) DELAY, TRI-STATE LED, ALARM OUTPUT (DPDT) RELAY WITH LOCAL ALARM PIEZO (RE-SET BY MORTISE KEY SWITCH), INCLUDES 2 (DPDT) KEY SWITCH CONTACTS 1 MOMENTARY 1 MAINTAINED FOR ALARM SHUNT OR RESET ON DOUBLE GANG PLATE (CYLINDER NOT INCLUDED ADD "XK" PER OPTIONS BELOW)

\$330.00

(SUFFIX)

xCT

7281 EXIT ALARM OPTIONS

COVER TAMPER SWITCH SPDT

(ADD)

\$59.00

xK

STANDARD 1-1/8" MORTISE CYLINDER & 2 KEYS

\$40.00

xKNR

CYLINDER WITH KEY NON-REMOVABLE IN THE ON POSITION

\$50.00

xW

OFF WHITE BAKED ENAMEL PLATE FINISH

\$20.00

(SUFFIX)

7281-EAxMP23 ENGRAVING OPTIONS

xE1

"PUSH TO EXIT" (RED TEXT)

(ADD)

\$18.00

xE5

"EMERGENCY DOOR RELEASE" (RED TEXT)

\$20.00

ADD CUSTOM ENGRAVING

xE6

PER PLATE FEE AFTER SET UP

\$24.00

(ORDER AS LINE ITEM)---- XE6SETUP

CUSTOM ENGRAVING 1 SET UP FEE PER RUN

\$60.00

ANNUNCIATORS



7286 SERIES

PART # LOCAL DOOR PROP ALARMS

LIST PRICE

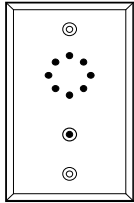

7286-PT5

7286-PT5

LOCAL DOOR PROP ALARM

DOOR PROP ALARM WITH ADJUSTABLE (0-SECONDS TO 90-MINUTES) DOOR OPEN DELAY, ALARM OUTPUT (DPDT) RELAY, TRI-STATE LED, AND LOCAL ALARM PIEZO, ADJUSTABLE LOCAL WARNING TIME DELAY & MIRRORED DOOR SWITCH OUTPUT

\$465.00

7286-PT5-24

DOOR PROP ALARM WITH KEY SWITCH

DOOR PROP ALARM WITH ADJUSTABLE (0-SECONDS TO 90-MINUTES) DOOR OPEN DELAY, TRI-STATE LED, ALARM OUTPUT (DPDT) RELAY WITH LOCAL ALARM PIEZO, ADJUSTABLE LOCAL WARNING TIME DELAY & MIRRORED DOOR SWITCH OUTPUT (RE-SET BY TIMER, DOOR RE-SECURE OR KEY SWITCH), INCLUDES 2 (DPDT) KEY SWITCH CONTACTS 1 MOMENTARY 1 MAINTAINED FOR ALARM SHUNT OR ALARM RESET ON DOUBLE GANG PLATE (CYLINDER NOT INCLUDED ADD "XK" PER OPTIONS BELOW)

\$570.00

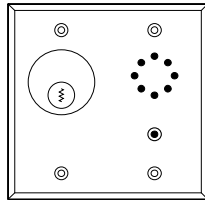

7286-PT5-24xK
SHOWN

7286-PT5xMP23

DOOR PROP ALARM WITH PUSH BUTTON

DOOR PROP ALARM WITH ADJUSTABLE (0-SECONDS TO 90-MINUTES) DOOR OPEN DELAY, TRI-STATE LED, ALARM OUTPUT (DPDT) RELAY WITH LOCAL ALARM PIEZO, ADJUSTABLE LOCAL WARNING TIME DELAY & MIRRORED DOOR SWITCH OUTPUT (AUTOMATIC ALARM RESET BY TIMER OR DOOR RE-SECURE), AND MOMENTARY ACTION PUSH BUTTON SWITCH (1-NO/1-NC) ON DOUBLE GANG PLATE

\$510.00

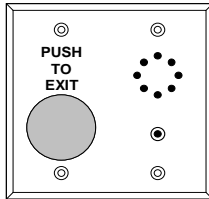

7286-PT5xMP23xE1
SHOWN

(SUFFIX)

xCT
xK
xKNR

xW

(SUFFIX)

xE1
xE5

xE6

(ORDER AS LINE ITEM)---- XE6SETUP

7286 DOOR PROP ALARM OPTIONS

COVER TAMPER SWITCH SPDT
STANDARD 1-1/8" MORTISE CYLINDER & 2 KEYS
CYLINDER WITH KEY NON-REMOVABLE IN THE ON POSITION
OFF WHITE BAKED ENAMEL PLATE FINISH

(ADD)

\$59.00
\$40.00
\$50.00
\$20.00

7286xMP23 ENGRAVING OPTIONS

"PUSH TO EXIT" (RED TEXT)
"EMERGENCY DOOR RELEASE" (RED TEXT)

(ADD)

\$18.00
\$20.00

ADD CUSTOM ENGRAVING

PER PLATE FEE AFTER SET UP
CUSTOM ENGRAVING 1 SET UP FEE PER RUN

\$24.00
\$60.00



ANNUNCIATORS

7600 SERIES **PART #** **DESCRIPTION** **LIST PRICE**
MULTI-ZONE ANNUNCIATOR/CONTROLLERS

7600 ANNUNCIATOR MULTI-GANG CONSOLES

ANNUNCIATOR/CONTROLLER WITH LED INDICATORS & TOGGLE SWITCHES FOR EACH ZONE. SECURITY KEY SWITCH FOR LED TEST, NORMAL CONTROL, RESTRICTED OPERATION, AND SILENCED ALERT SOUNDER MODE. CONFIGURED IN FOUR ZONE INCREMENTS MOUNTED ON MULTI-GANG STAINLESS STEEL SWITCH PLATES OR 19" WIDE RACK MOUNTABLE PLATES WITH BLACK OVERLAY SUITABLE FOR FLUSH MOUNTING.

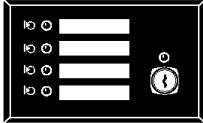

7604-H

7604-H **4 ZONE HARDWIRED ANNUNCIATOR/CONTROLLER ON THREE GANG PLATE (6-1/2" WIDE x 4-1/2" HIGH x 2-1/2" DEEP)** **\$1,050.00**

4 ZONE EXPANSION **ADD (TO #7604 ABOVE) FOR EACH ADDITIONAL 4 ZONE EXPANSION MODULE (EXAMPLES BELOW)** **\$500.00**

#7608-H = \$1,550.00 (EIGHT ZONES TOTAL)
 #7612-H = \$2,050.00 (TWELVE ZONES TOTAL)
 #7616-H = \$2,550.00 (SIXTEEN ZONES TOTAL)
 #7620-H = \$3,050.00 (TWENTY ZONES TOTAL)

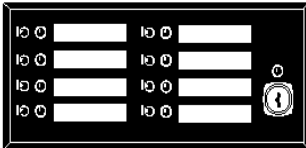

7608-H

OPTIONAL MOMENTARY SWITCHES

MOMENTARY PUSH BUTTONS ARE AVAILABLE. SPECIFY UPON ORDERING. THESE ARE NON STOCK, CHECK FOR AVAILABILITY. **UTILIZING MOMENTARY PUSH BUTTONS DISABLES THE NORMALLY OPEN LOCK OUTPUT CAPABILITY; ONLY THE NORMALLY CLOSED OUTPUT IS ACTIVE**

ADD \$140.00 FOR EVERY 4 ZONES

760006-K **SPARE KEY FOR 7600 ANNUNCIATOR** **\$30.00**

*******MINIMUM OF 10 KEYS PER ORDER*******

ALL 7600'S HAVE 2 ORIGINAL KEYS SUPPLIED
 MULTIPLE UNITS MAY BE SPECIFIED KEYED ALIKE

DESK TOP ANNUNCIATOR ENCLOSURES

7600 SERIES SLOPED FACE ENCLOSURES:

ALUMINUM CONSTRUCTION BLACK BAKED ENAMEL FINISH

7604/8-ENCL **DESKTOP SLOPE FACE ENCLOSURE FOR FOUR OR EIGHT ZONE CONSOLES** **\$400.00**
 9 x 6 x 2-3/4"

7612/16-ENCL **DESKTOP SLOPE FACE ENCLOSURE FOR TWELVE OR SIXTEEN ZONE CONSOLES** **\$470.00**
 15 x 6 x 2-3/4"

7620/24-ENCL **DESKTOP SLOPE FACE ENCLOSURE FOR TWENTY OR TWENTY FOUR ZONE CONSOLES** **\$505.00**
 19 x 6 x 2-3/4"

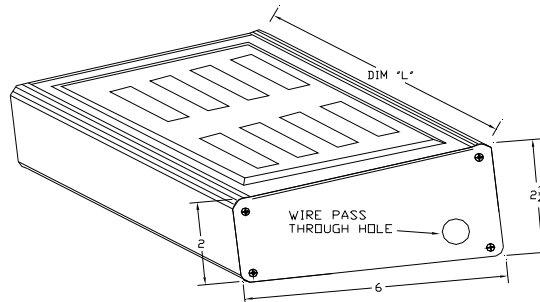

ANNUNCIATORS



7600 SERIES

PART #
ANNUNCIATOR DIMENSIONS

DESCRIPTION

LIST PRICE

7600 SERIES MOUNTING PLATE SIZES:

Model #	Plate Width x Height	Plate Type	
#7604	6-1/2" x 4-1/2"	3-GANG SWITCH PLATE	(4-Zones)
#7608	8-1/4" x 4-1/2"	4-GANG SWITCH PLATE	(8-Zones)
#7612	11-3/4" x 4-1/2"	6-GANG SWITCH PLATE	(12-Zones)
#7616	13-1/2" x 4-1/2"	7-GANG SWITCH PLATE	(16-Zones)
#7620	17-1/2" x 4-1/2"	9-GANG SWITCH PLATE	(20-Zones)

SUFFIX	7604 THRU 7620 OPTIONAL RACK MOUNT PLATE	
xRM	MOUNTED ON RACK MOUNT PLATE '19" x 5-1/4"	ADD \$100.00

NO ADDITIONAL CHARGE FOR 7624 & LARGER RACK MOUNT PLATES

Model #	Plate Width x Height	Plate Type	N/C
#7624	19" x 5-1/4"	RACK MOUNT PLATE	(24-Zones)
#7628 *	19" x 7"	RACK MOUNT PLATE	(28-Zones)
#7632	19" x 7"	RACK MOUNT PLATE	(32-Zones)
#7636	19" x 10-1/2"	RACK MOUNT PLATE	(36-Zones)
#7640	19" x 7"	RACK MOUNT PLATE	(40-Zones)
#7644 *	19" x 10-1/2"	RACK MOUNT PLATE	(44-Zones)
#7648	19" x 9-1/4"	RACK MOUNT PLATE	(48-Zones)
#7652 *	19" x 10-1/2"	RACK MOUNT PLATE	(52-Zones)
#7656 *	19" x 10-1/2"	RACK MOUNT PLATE	(56-Zones)
#7660	19" x 10-1/2"	RACK MOUNT PLATE	(60-Zones)
#7664	19" x 12-1/4"	RACK MOUNT PLATE	(64-Zones)
#7668 *	19" x 18-1/2"	RACK MOUNT PLATE	(68-Zones)
#7672	19" x 18-1/2"	RACK MOUNT PLATE	(72-Zones)
#7676 *	19" x 12-1/4"	RACK MOUNT PLATE	(76-Zones)
#7680	19" x 12-1/4"	RACK MOUNT PLATE	(80-Zones)
#7684 *	19" x 18-1/2"	RACK MOUNT PLATE	(84-Zones)
#7688 *	19" x 18-1/2"	RACK MOUNT PLATE	(88-Zones)
#7692 *	19" x 18-1/2"	RACK MOUNT PLATE	(92-Zones)
#7696	19" x 18-1/2"	RACK MOUNT PLATE	(96-Zones)
#76100	19" x 15-1/4"	RACK MOUNT PLATE	(100-Zones)
#76104 *	19" x 18-1/2"	RACK MOUNT PLATE	(104-Zones)
#76108 *	19" x 18-1/2"	RACK MOUNT PLATE	(108-Zones)
#76112 *	19" x 18-1/2"	RACK MOUNT PLATE	(112-Zones)
#76116 *	19" x 18-1/2"	RACK MOUNT PLATE	(116-Zones)
#76120	19" x 18-1/2"	RACK MOUNT PLATE	(120-Zones)

ELECTRICAL BACK BOXES FOR FLUSH WALL MOUNTING

700353	3 GANG BACK BOX FOR 7604-H	\$46.00
700354	4 GANG BACK BOX FOR 7608-H	\$56.00
700356	6 GANG BACK BOX FOR 7612-H	\$70.00

*Due to the physical layout of these units there may be additional zones which will be plugged on the plate with black plastic inserts to match the black overlay

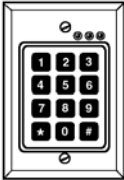
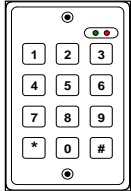
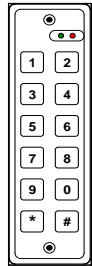

ACCESS CONTROL

8100 SERIES	PART #	DESCRIPTION	LIST PRICE
 8112	8112	8112 SERIES DIGITAL KEY PADS USER PROGRAMMABLE DIGITAL KEY PAD SINGLE DOOR STAND-ALONE ACCESS CONTROL 120 USER CODES PROGRAMMED FROM KEYPAD 1 TO 90 SECONDS ADJUSTABLE TIME DELAY (RECOMMENDED FOR INTERIOR APPLICATIONS)	\$280.00
	8112-WR	WEATHER RESISTANT MEMBRANE KEY PAD SINGLE DOOR STAND-ALONE ACCESS CONTROL 120 USER CODES PROGRAMMED FROM KEYPAD 1 TO 90 SECONDS ADJUSTABLE TIME DELAY	\$415.00
	WR500351	WEATHER RESISTANT SURFACE MOUNT SINGLE GANG BOX FOR USE WITH 8112-WR	\$25.00
 8160	8160	8160 SERIES HEAVY DUTY DIGITAL KEY PADS HEAVY DUTY, ALL METAL, TOUCH SENSITIVE, WEATHERPROOF, KEYPAD SINGLE DOOR STAND ALONE ACCESS CONTROL WITH 200 ACTIVE USER CODES ELECTRONICS PROTECTED BY REMOTELY LOCATED CONTROL PANEL.	
	8160	SINGLE GANG STYLE WATERPROOF/VANDAL RESISTANT KEYPAD FOR SURFACE MOUNTING ON FLAT WALL SURFACES	\$675.00
	8160xNS	NARROW STYLE WATERPROOF/VANDAL RESISTANT KEYPAD FOR SURFACE MOUNTING ON 1-3/4" DOOR FRAMES	\$675.00
 8160xNS	8160xINT	INTEGRATED UNIT WITH ON-BOARD ELECTRONICS 200 USER CODES (NO CONTROL PANEL) SPDT. RELAY OUTPUT N.O. PUSH BUTTON SWITCH INPUT	\$575.00
	8160xNSxINT	NARROW INTEGRATED UNIT WITH ON-BOARD ELECTRONICS 200 USER CODES (NO CONTROL PANEL) SPDT. RELAY OUTPUT N.O. PUSH BUTTON SWITCH INPUT	\$575.00
	8160xWG	WIEGAND OUTPUT UNITS 26 BIT WIEGAND OUTPUT	\$425.00
	WR500351	WEATHER RESISTANT SURFACE MOUNT SINGLE GANG BOX FOR USE WITH 8160 / 8160xINT	\$25.00



MISCELLANEOUS

MAG LOCK

<u>PART #</u>	<u>DESCRIPTION</u>	<u>LIST PRICE</u>
---------------	--------------------	-------------------

REPLACEMENT PARTS		
<u>MAGLOCK REPLACEMENT PARTS</u>		
1000701	LOCK MOUNTING KIT 1000 SERIES	\$12.00
1000702	TJ LOCK MOUNTING KIT 1000 SERIES	\$10.00
1100701	LOCK MOUNT KIT 1106,1107,1110,1150	\$10.00
1100702	TJ-LOCK MOUNT KIT TJ1106,TJ1107,TJ1110,TJ1150	\$11.50
1100721	DOUBLE LOCK MOUNTING KIT 1120, 1152	\$11.50
1100722	DOUBLE TJ-LOCK MOUNTING KIT TJ1120, TJ1152	\$14.00
1100703	ARMATURE MOUNTING KIT 1-3/4" DOOR	\$19.00
1100703.2	ARMATURE MOUNTING KIT 2" DOOR	\$26.00
1100703-SC	ARMATURE MOUNTING KIT FOR XEDR LOCKS	\$18.00
1100704	TJ- ARMATURE MOUNTING KIT	\$14.00
1000051	1000 SERIES ARMATURE	\$75.00
1000054	1000 DPS ARMATURE W/ACTUATING MAGNET	\$82.00
1106051	1106 & 1107 SERIES ARMATURE	\$50.00
1106054	1106 & 1107 DPS ARMATURE W/ACTUATING MAGNET	\$66.00
1115051	1115 SERIES ARMATURE	\$50.00
1115054	1115 DPS ARMATURE W/ACTUATING MAGNET	\$66.00
1110051	1110 SERIES ARMATURE	\$68.00
1110054	1110 DPS ARMATURE W/ACTUATING MAGNET	\$75.00
1160011	DPS ACTUATING MAGNET ONLY	\$12.00
1160015	DPS SWITCH ONLY SPDT W/LEADS	\$28.00
1610051	1150 SERIES ARMATURE	\$80.00
1610054	1150 DPS ARMATURE W/ACTUATING MAGNET	\$85.00
1610155	1155 SERIES ARMATURE	\$64.00
1610154	1155 DPS ARMATURE W/ACTUATING MAGNET	\$70.00
<u>SURFACE MOUNT PLATE FOR ARMATURE</u>		
(INCLUDES REQUIRED MOUNTING HARDWARE)		
1110050	FOR 1000,1110,1150 (2 REQ. FOR 1120/1152/1155)	\$135.00
1115050	FOR 1106 & 1107 (2 REQUIRED FOR 1115 SERIES)	\$70.00

"Z" BRACKETS

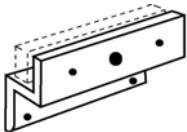

<u>TOP JAMB Z-BRACKETS w/ SEX NUT</u>		
1096-00	Z-BRACKET FOR 1000 "TJ" LOCKS	\$84.00
1196-06	Z-BRACKET FOR 1106 & 1107 "TJ" LOCKS	\$72.00
1196-10	Z-BRACKET FOR 1110 "TJ" LOCKS	\$84.00
1196-15L	Z-BRACKET FOR 1115 "TJ" LOCKS	\$68.00
1196-15R	Z-BRACKET FOR 1115 "TJ" LOCKS	\$68.00
1196-50	Z-BRACKET FOR 1150 "TJ" LOCKS	\$104.00
1196-55L	Z-BRACKET FOR 1155 "TJ" LOCKS	\$80.00
1196-55R	Z-BRACKET FOR 1155 "TJ" LOCKS	\$80.00
1196703	Z-BRACKET MOUNTING KIT	\$30.00
<u>(SUFFIX)</u>		
xDBA	ADD FOR DARK BRONZE ANODIZED Z-BRACKET	\$40.00
xSBA	ADD FOR SATIN BLACK ANODIZED Z- BRACKET	\$40.00
xUS3	ADD FOR POLISHED BRASS Z-BRACKET	\$180.00
xUS26	ADD FOR POLISHED CHROME Z-BRACKET	\$180.00
xUS4	ADD FOR SATIN BRASS Z-BRACKET	\$180.00
xUS26D	ADD FOR SATIN CHROME Z-BRACKET	\$180.00



MISCELLANEOUS

<u>PART #</u>	<u>DESCRIPTION</u>	<u>LIST PRICE</u>
SWITCH REPLACEMENT PARTS		
5140 SERIES PARTS		
5141090	CYLINDER W/ 2 KEYS FOR 5141 SERIES	\$40.00
5141703	CYLINDER MOUNTING KIT FOR 5141 KEY SWITCH	\$15.00
5215 SERIES SWITCHES		
5215015	SPDT MOM ACTION SW. 8" LEADS	\$25.00
5230 SERIES SWITCHES		
5230014L	SPDT MAINTAINED SNAP ACTION SW. 8" LEADS	\$25.00
5230015L	SPDT MOMENTARY SNAP ACTION SW. 8" LEADS	\$25.00
5230024L	DPDT MAINTAINED SNAP ACTION SW. 8" LEADS	\$55.00
5230025L	DPDT MOMENTARY SNAP ACTION SW. 8" LEADS	\$50.00
5140 & 5280 SERIES SWITCHES		
<i>(SPECIFY IF REPLACEMENT SWITCH IS FOR A KEY SWITCH OR A PUSH BUTTON)</i>		
5280024L	DPDT MAINTAIN ACTION SWITCH W/8" LEADS	\$40.00
5280025L	DPDT MOMENTARY ACTION SWITCH W/8" LEADS	\$40.00
5280024T	DPDT MAINTAIN TOGGLE SWITCH W/8" LEADS	\$50.00
TIME DELAY REPLACEMENT PARTS		
5220023L	PNEUMATIC 2-60 SEC. TIME DELAY SWITCH	\$250.00
52800AT	AT ADJUSTABLE 2-60 SEC.TIMER DPDT 12/24 VDC	\$100.00
52800FT	FT FIXED 30 SEC.TIMER DPDT 12/24 VDC	\$100.00
4505001	ET TIMER 2-60 SEC. DPDT 12/24 VDC	\$125.00
ELECTRICAL BOXES & ACCESSORIES		
500351	1-GANG STANDARD ELECTRICAL BOX	\$15.00
500352	2-GANG STANDARD ELECTRICAL BOX	\$20.00
WR500351	1-GANG WEATHER RESISTANT ELECTRICAL BOX	\$25.00
WR500352	2-GANG WEATHER RESISTANT ELECTRICAL BOX	\$30.00
N500351	NARROW 1-3/4" JAMB MOUNT BACK BOX BLACK HIGH IMPACT PLASTIC CONSTRUCTION	\$44.00
SS500351	SS 1 GANG SURFACE BOX FOR 5277 SERIES	\$75.00
SSN500351	SS NARROW SURFACE BOX 1-3/4 FOR"N" 5277	\$60.00
LED REPLACEMENT PARTS		
7020251	BLACK PLASTIC BEZEL (BICOLOR RED / GREEN) W/6" LEADS	\$12.00
7020256	CHROME BEZEL FOR HD AND 7200 SERIES ANNUNCIATORS (BICOLOR RED / GREEN)	\$24.00
7020252-HI	HI INTENSITY RED W/6" LEADS	\$60.00
7020255-HI	HI INTENSITY GREEN W/6" LEADS	\$60.00
7020252-HI-WR	WEATHER PROOF HI INTENSITY RED 6" LEADS	\$66.00
7020255-HI-WR	WEATHER PROOF HI INTENSITY GREEN 6" LEADS	\$66.00
MISC. REPLACEMENT PARTS		
6410015-J	6420 / 6495 SERIES SPDT REPLACEMENT SWITCH (2 REQUIRED PER DEVICE)	\$36.00
6410015-JWR	WEATHER PROOF SWITCH FOR SAME AS ABOVE	\$50.00
1100640	xCT COVER TAMPER REPLACEMENT SWITCH	\$30.00
LA-LABEL DOOR SIGN 15-30	DELAYED EGRESS NFPA 101 SIGNAGE	\$14.00



SALES - POLICIES AND PROCEDURES

Papers Needed to Open an Account:

A credit application is filled out and returned for processing. If customer is approved, they are set up on a Net-30 Day Terms. Note: If customer information received back (bank, trade references, Dunn & Bradstreet) is inconclusive, the sales representative will help decide terms (Net or COD).

Credit cards are also accepted: Visa, Mastercard and American Express.

Dortronics Systems, Inc. will not accept Credit card information via e-mail.

Minimum Order:

There is no minimum order; however, if a customer is going to buy a small quantity, low dollar amount on a one-time basis, the order will be shipped COD or credit card. Customer also has the option to send payment in advance.

Freight Policy:

Freight is prepaid and billed on all invoices which are mailed the day after shipment.

Carriers used are UPS, FED-EX and trucking. Customer may choose to use own account.

Drop ship Info:

To be advised during verbal phone order, or specified on E-mail or faxed purchase orders.

Contact (Sales):

Mike Palermo – Inside Sales Manager

Patty Bryant – Sales/Customer Service

Bryan Sanderford - National Sales Manager

Contact (Technical):

Joe Hanna – Engineer/Applications Specialist

Stuart Arthur – Tech Sales/Applications Specialist

Contact (Credit):

Kelly Hillerud – Accounting; New Customer Accounts

Special Dealer Programs:

Large quantity discount pricing is negotiable and reviewed on a situational basis.

Product Warranties

All electromagnetic locks have a **LIFETIME GUARANTEE** against defects in material and workmanship. Defective units will be replaced or repaired based upon incoming evaluation and inspection.

All other Dortronics components of the Electric Locking System shall be similarly warranted for a period of one year. Expressed warranties are conditionally based on the requirement that the items covered within the guarantee are used and maintained in accordance with the manufacturer's recommendations.

Returns:

A Return Authorization Number must be obtained and accompany all returns within 14 days of issue.

Unused items returned for credit must be complete and packed in original unit box and are subject to a 15% restocking fee. Any shipping, damaged parts or order discrepancies must be reported within 5 days of receipt.



DORTRONICS SYSTEMS, INC.

1668 Sag Harbor Tpke., Sag Harbor, NY 11963 (800) 906-0137 (631) 725-8148 Fax www.dortronics.com

CREDIT APPLICATION

COMPANY NAME: _____ PH: _____
STREET ADDRESS: _____ FX: _____
CITY: _____ STATE: _____ ZIP: _____

PRINCIPALS

TITLE OR POSITION

NAME: _____
NAME: _____
NAME: _____
NAME: _____

BANK: _____ BRANCH: _____
ADDRESS: _____ PH: _____ EXT: _____
CITY: _____ STATE: _____ ZIP: _____
PERSON TO CONTACT: _____ POSITION: _____

AMOUNT OF CREDIT REQUESTED: \$ _____

TRADE REFERENCES

1: _____ 2: _____

PH: _____ FX: _____ PH: _____ FX: _____
ACCOUNT #: _____ ACCOUNT #: _____

3: _____ 4: _____

PH: _____ FX: _____ PH: _____ FX: _____
ACCOUNT #: _____ ACCOUNT #: _____

TERMS & CONDITIONS:

In consideration of credit extended we agree to pay invoices due within 30 days of invoice date.
A 2% interest fee may be applied to past due invoices.

DEFAULT:

In the case of default, all collection charges, Lawyers fees and interest will be borne by the applicant Company.

We understand your terms and conditions as stated above and agree to abide by them in making this application for credit. I also understand that an investigative consumer report may be made.

We hereby authorize the release of any information from the above business references and our bank.

ALL REPLIES WILL BE KEPT CONFIDENTIAL

Signature required below by Company officer or duly authorized representative.

SIGNATURE: _____ TITLE: _____

PRINT NAME: _____ DATE: _____