

TABLE OF CONTENTS

A

ANSI Standards..... 2

B

Bearing at Top..... 12

Bearing Replacement Kit..... 13

C

Cancellation Notification 2

Center Punches 13

Concealed Electric Hinges with Lead Wire.....7-10

Concealed Electric Monitoring (EMN).....7-10

Concealed Electric Through-Wire (ETW).....7-10

Concealed Electric Through-Wire - Removable (RETW)7-10

Concealed Electric Through-Wire and Monitoring (ETM)7-10

Custom Hole Pattern 12

D

Dutch Door Prep..... 13

E

Electrical Modifications7-10

Exposed Electric Contacts (E)7-10

Exposed Electric Switches (EIS)7-10

Extra Long Hinges 12

F

Fasteners..... 14

Field Modifications..... 3

Fire Ratings 4

H

Hinges

Concealed 15, 16, 18-21, 23-25

Full Surface..... 15, 17, 21, 22, 24

Half Surface 15, 16-22, 25

Hospital Tip..... 12

How To Order 2

L

Lead Times 2

Length Specifications..... 3

M

Marking Jigs..... 13

Mortar Box..... 11

P

Painted Cover Channels..... 6

Polished Cover Channels 6

Q

Quick Connect..... 9

Quick Ship..... 2

R

Replacement Moldings 11

S

Shim Stock 14

Shipping Cartons 14

Short Hinges..... 12

Special Anodizing 6

Special Cover Channels..... 5

Special Finished Hinges..... 6

Special Holes 6

Special Lengths 3

Special Products..... 3

Standard Finishes..... 3

Standard Lengths 3

T

Tamper Resistant Hinge 13

Template Hinges..... 3

The Safety Angle..... 13

V

Von Duprin EPT-2..... 7-9

Von Duprin EPT-10 7-9



Roton Continuous Hinges

HOW TO ORDER:

Example: 780-112HDFFUL 119" CLR 1 PK

Stock Number: 048058

Item Number: YS 1121190CLR000001

780

ROTON
ALUMINUM
CONTINUOUS
GEARED
HINGE

112HD

ITEM#

119"

LENGTH

CLR

FINISH

1 PK

STANDARD
SINGLE
PACK

INTRODUCTION

Hager Roton hinges are unique, aluminum geared hinges developed to outperform most other entrance components because the weight of the door is distributed along the full length of the door frame.

Roton continuous hinges have been utilized in hospitals, schools, hotels, offices, airports, stadiums, storefronts, and commercial and industrial buildings in new construction and retrofit applications for over 30 years.

Hager Roton continuous geared hinges are designed for superior performance. Because of this, we offer our lifetime warranty with confidence.

ANSI Standards

- 780 Series Roton continuous geared hinges are approved per ANSI A156.26 Grade 1 for 150 lb. doors
- 780 Series Roton heavy duty hinges are approved per ANSI A156.26 Grade 1 for 300 lb. doors
- 780-111, 780-112, 780-124HD, 780-224, 780-226 standard duty and heavy duty Roton continuous geared hinges are Warnock-Hersey certified in accordance with ANSI A250.13 2003 Standard Severe Windstorm Resistant Components.



Lead Times

Stock orders will typically ship within 5-10 business days and the anticipated ship date will be included with each order acknowledgement.

Made to order products will typically ship within 10 business days depending on seasonal volume and order complexity.

Special orders including industrials, special machining, and large quantities will need to be scheduled. Please contact our customer service for details.

Made to order products requiring special finishes may take longer depending on the quantity and capacity. Please contact our customer service for details.

Lead times are quoted from the time our manufacturing facilities receive the orders placed.

Quick Ship

The items throughout this price book that have prices in **bold and red** are items included in the Hager Quick Ship Program and ship in three days or less. When ordering these products, please visit www.hagerco.com and click on 'Quick Ship' in the footer. You will be prompted to log in with your My Hager account name and password and then you may begin ordering.

Cancellation Notification

Cancellation for made to order items must be completed within 48 hours of order placement.



Standard Lengths

Roton hinges are listed and priced as actual lengths 79" (6'8" opening), 83" (7'0" opening), 85" (7'2" opening), 95" (8'0" opening), and 119" (10'0" opening) for convenience in application to nominal sized doors. Actual length provides for threshold clearance, head clearance and door height allowances for carpeting. Other lengths may be ordered as non-standard items.

Special Lengths

Should a non-standard length be required, please order the next standard length. (For example, if 86" length is required, use 95" list price.)

Length Specifications

If special lengths to match the actual net door heights are required, please indicate this clearly on your order. A special length should be specified from the net door height, not the nominal height of the opening. To order specify: "Actual Length", or "Net Door Height". Use pricing for the next longer standard length from which the special length can be manufactured. For example, hinges 86-3/4" long will be invoiced at the 95" price.

Field Modifications

While Roton hinges can be cut in the field, any product modifications may void all warranties. Should in-the-field modifications be required, cut only from bottom of hinge. Do not cut through bearings or screw holes. When cutting electric hinges it is extremely important to clamp both hinge leaves securely to prevent hinge "chatter" which can damage the hinge's internal wiring. Consult the St. Louis sales office before proceeding.

Template Hinges

Hager has developed templated hole patterns for Roton hinge models in standard lengths. Drawings are available upon request by contacting Hager Customer Service or accessing the Hager website at www.hagerco.com.

Due to normal variances inherent in the manufacturing process, Roton custom length hinges are deemed by Hager to be non-templated.

Standard Finishes

Roton hinges are available in clear anodized satin aluminum (similar to US28) or in dark bronze exterior anodized coating.

Special Products

A special product is any product not listed in the price book in regard to length, finish, standard hole preparation or leaf combinations not illustrated. Orders for special products are encouraged, but any changes or cancellations on special orders may result in charges related to work performed and/or material loss. Under no circumstance will non-stock or make-to-order products be accepted for return unless due to Hager error.



Roton Continuous Hinges

FIRE RATINGS - UNDERWRITERS LABORATORY FIRE RATING FILE #A14627



780 Series Roton continuous geared hinges with stainless steel studs are approved for use on 4'x10' metal or wood swing type doors. 780 Series Roton continuous geared hinges without stainless steel studs are approved for use on 4'x8' single swing metal doors and 4'x10' single swing wood doors used without stainless steel studs limited to 20 minute fire rating without hose stream.

- Hollow metal, tin-clad, sheet-metal and steel covered composite type rated up to and including 3 hours
- Wood composite doors rated up to and including 1-1/2 hours
- Wood core doors rated up to 20 minutes without hose stream, non-studded
- 780 Series Roton Continuous Geared Hinges meet requirements for positive pressure UL10C, UL10B and UBC7-2 Part 1

UL10C Fire Rated Roton	Fully Concealed	Full Surface	Half Surface	NOTES: 1. All Roton hinges will be marked with UL stamp if they are fire-rated. 2. Several hinge models cannot be fire-rated. Check each profile. 3. Models for which studs are required have an extra charge. Four studs are required for UL stud hinges. Add to the hinge list price before applying buying group discount - \$56.80.
20 Minute Fire Rated Wood Core Door x Fire Rated Hollow Metal Frame	UL — FF STANDARD			
20 Minute Fire Rated Metal Door x Fire Rated Hollow Metal Frame	UL — FF STANDARD			
30 Minute Fire Rated Wood Composite Door x Fire Rated Hollow Metal Frame	UL — FF STANDARD			
30 Minute Fire Rated Metal Door x Fire Rated Hollow Metal Frame	UL — FF STANDARD			
45 Minute Fire Rated Wood Composite Door x Fire Rated Hollow Metal Frame	UL — FF STANDARD			
45 Minute Fire Rated Metal Door x Fire Rated Hollow Metal Frame	UL — FF STANDARD			
60 Minute Fire Rated Wood Door x Hollow Metal Frame	UL — FF STANDARD			
60 Minute Fire Rated Metal Door x Hollow Metal Frame	UL — FF STANDARD			
90 Minute Fire Rated Metal Door x Fire Rated Hollow Metal Frame	UL — FF STANDARD			
90 Minute Fire Rated Wood Composite Door x Fire Rated Hollow Metal Frame	UL — STUD REQUIRED * Must Specify			
3 Hour Fire Rated Metal Door x Fire Rated Hollow Metal Frame	UL — STUD REQUIRED * Must Specify			

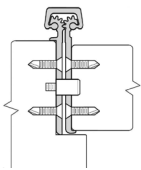

FULLY CONCEALED WITH STUD

Fully Concealed

These models are concealed between the frame and the hinge edge of the door. Models available include: 780-041HD, 780-041LL, 780-110HD, 780-111, 780-111HD, 780-111LL, 780-112, 780-112HD, 780-112LL, 780--124HD, 780-124LL, 780-224, 780-224HD, 780-224LL, 780-226, 780-226HD, 780-226LL, and 780-235HD.

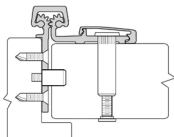

HALF SURFACE WITH STUD

Half Surface

These models have the frame leaf concealed between the frame and the edge of the door. The door leaf is mounted to the door with thru-bolts or screws. Models available include: 780-045HD, 780-046HD, 780-053, 780-053HD, 780-054HD, and 780-211HD.

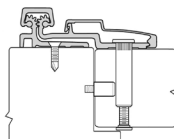

FULL SURFACE WITH STUD

Full Surface

These models have the frame leaf mounted to the face of the frame and the face of the door. The door leaf is mounted to the face of the door with thru-bolts. Models available include: 780-057HD, 780-157, 780-157HD, 780-210, 780-210HD, and 780-257HD.



MODIFICATIONS & ADDITIONS

Special Cover Channels

Special covers for decorative, fluted or rounded effects may be ordered. Availability for hinges with electrical modifications vary. Please consult the St. Louis sales office for confirmation. Add to the hinge list price before applying buying group discount:

Decorative Back Cover Channels*

Clear Anodized

79", 83", 85"	\$25.15
95"	\$31.15
119"	\$40.15

Bronze Anodized

79", 83", 85"	\$50.20
95"	\$56.20
119"	\$64.25

1/2" wide decorative insert

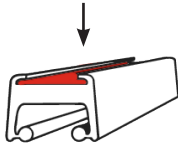

Decorative Back
Decorative insert not available through Hager.

*Not available on electrical prep or painted hinges.

Fluted Back Cover Channels

Clear Anodized

79", 83", 85"	\$25.15
95"	\$31.15
119"	\$40.15

Bronze Anodized

79", 83", 85"	\$50.20
95"	\$56.20
119"	\$64.25

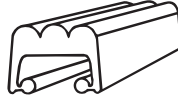

Fluted Back

Round Back Cover Channels

Clear Anodized

79", 83", 85"	\$25.15
95"	\$31.15
119"	\$40.15

Bronze Anodized

79", 83", 85"	\$50.20
95"	\$56.20
119"	\$64.25

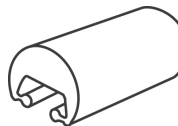

Round Back

Note: Special cover channels available only in clear and dark bronze finish.

Roton Cover Channel Compatibility				
Hinge Model	Flat FBCC	Round RBCC	Fluted FLCC	Decorative DBCC
750-134	•	•	•	•
750-138	•	•	•	•
780-041	•	•		
780-045	•	•		
780-046	•	•		
780-053	•	•		
780-054	•	•		
780-057	•	•		
780-110	•	•	•	•
780-111	•	•	•	•
780-112	•	•	•	•
780-113	•	•	•	•
780-114	•	•		
780-124	•	•	•	•
780-155	•	•		
780-157	•			
780-208	•		•	•
780-210	•	•		
780-211	•	•		
780-213	•	•		
780-224	•	•	•	•
780-226	•	•	•	•
780-235	•	•	•	•
780-257	•			
780-259	•	•		
780-300	•			



Roton Continuous Hinges

MODIFICATIONS & ADDITIONS

ADDITION TO LIST PRICE

Painted Cover Channels

For hinges 79", 83" and 85" in length
For hinges 95" in length
For hinges 119" in length

\$60.30
\$82.25
\$122.40

Roton cover channels are offered in bone white as a standard stock color option. This is only available on the standard Roton cover channel and should be ordered as bone white paint # UC43350.

Polished Cover Channels

	<u>CLEAR</u>	<u>GOLD</u>
For hinges 79" in length	\$60.30	\$82.25
For hinges 83" in length	\$60.30	\$82.25
For hinges 85" in length	\$60.30	\$82.25
For hinges 95" in length	\$82.25	\$102.30
For hinges 119" in length	\$121.35	\$140.40

For hinges 79" in length
For hinges 83" in length
For hinges 85" in length
For hinges 95" in length
For hinges 119" in length

Any hinge may be ordered with a polished clear cover channel (similar to US26) to complement clear anodized hinge leaves or a polished gold cover channel (similar to US3) to complement satin gold hinge leaves.

Special Finished Hinges

Price on Application

Hager Companies can supply unfinished material to selected finishers for special projects that require unusual colors, but will require that final assembly be complete by Hager Companies. Because of special non-removable metal coatings applied to all hinges during assembly, users are cautioned against attempting to refinish any Roton product.

Cannot paint 500 or 1200 series hinges.

Special Anodizing

Add 15% to the DBA hinges for black and gold

Roton hinges are available in various special colors including Black, Gold, and other special anodized finishes with fasteners to match. Example, specify "Black Anodized" or "Gold Anodized." All hinges ordered in special colors should be ordered at the same time to guarantee finish uniformity.

Other anodized colors by quotation only. Supply color chip for best match.

Special Holes

Price on Application

Any hinge may be ordered with special hole locations for unusual frame or door locations. Please provide specification for each leaf.



ELECTRICAL MODIFICATIONS

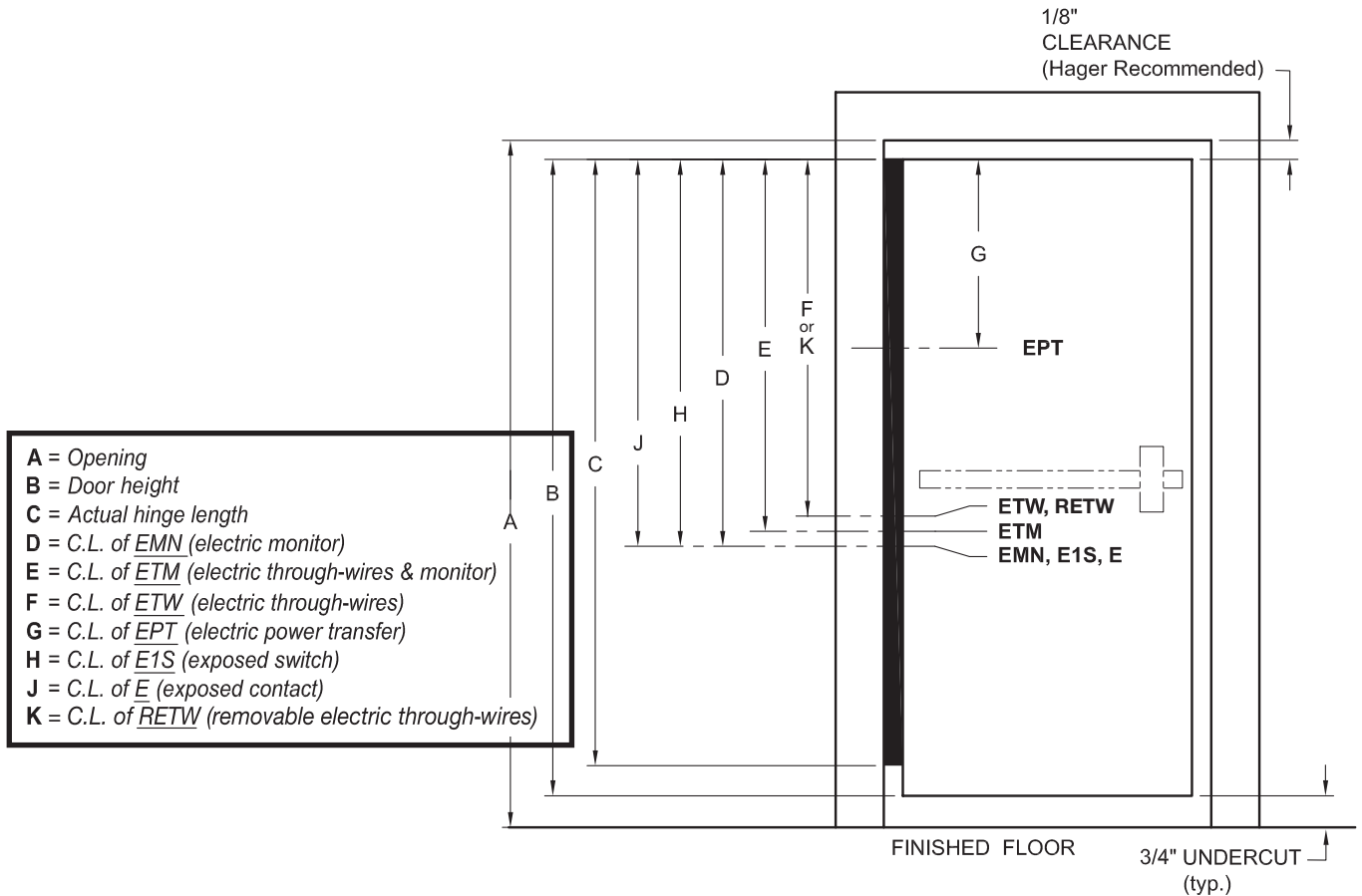

For ease of ordering, Hager Companies has established standard locations for power transfer cutouts. All standard location dimensions are referenced from the top edge of the door to the centerline of the power transfer cutout. Please specify handing.

NOTE: Full surface hinges are not available with preps.

	Opening	Door Height	Actual Hinge Length	EMN	ETM	ETW	EPT	E1S	E	RETW
79 SD	80"	79-1/8"	78-11/16"	42-12"	41-1/4"	40"	24-1/2"	42-1/2"	42-1/2"	-
79 HD	80"	79-1/8"	78-11/16"	42-1/2"	40-5/8"	38-13/16"	24-1/2"	42-1/2"	42-1/2"	41-7/8"
83 SD	84"	83-18"	83"	46-1/2"	44-5/8"	42-3/4"	28-7/16"	46-1/2"	46-1/2"	-
83 HD	84"	83-1/8"	83"	46-1/2"	45-1/4"	44"	28-7/16"	46-1/2"	46-1/2"	44-1/16"
85 SD	86"	85-1/8"	85"	48-1/2"	47-1/4"	46"	30-7/16"	48-1/2"	48-1/2"	-
85 HD	86"	85-1/8"	85"	48-1/2"	46-5/8"	44-3/4"	30-7/16"	48-1/2"	48-1/2"	45-1/16"
95 SD	96"	95-1/8"	95-1/16"	59-3/4"	57-7/8"	56"	40-1/2"	59-3/4"	59-3/4"	-
95 HD	96"	95-1/8"	95-1/16"	59-3/4"	57-7/8"	56"	40-1/2"	59-3/4"	59-3/4"	56-1/2"
119 SD	120"	119-1/8"	119"	83-3/4"	81-7/8"	80"	64-3/8"	83-3/4"	83-3/4"	-
119 HD	120"	119-1/8"	119"	83-3/4"	81-7/8"	80"	64-3/8"	83-3/4"	83-3/4"	80"

SD = Standard Duty HD = Heavy Duty



Roton Continuous Hinges

ELECTRICAL MODIFICATIONS (CONTINUED)

	Von Duprin EPT 2 or EPT 10 Power Transfer Preparation	Exposed Electric Contacts	Exposed Electric Switches	Concealed Electric Through-Wire	Concealed Electric Monitoring	Concealed Electric Through-Wire and Monitoring	Removable Electric Through-Wire
Part Number	EPT	E	E1S	ETW	EMN	ETM	RETW
780-045HD	•						
780-046HD	•						
780-053	•						
780-053HD	•						
780-054HD	•						
780-110HD			•				
780-111	•	•	•	•	•	•	
780-111HD	•	•	•	•	•	•	•
780-111LL	•	•	•	•	•	•	
780-112	•	•	•	•	•	•	
780-112HD	•	•	•	•	•	•	•
780-112LL	•	•	•	•	•	•	
780-124HD	•	•	•	•	•	•	•
780-124LL	•	•	•	•	•	•	
780-224	•	•	•	•	•	•	
780-224HD	•	•	•	•	•	•	•
780-224LL	•	•	•	•	•	•	
780-226HD	•	•	•	•	•	•	•
780-226LL	•	•	•	•	•	•	
780-235HD				•			
1200-600	•			•			
1200-650	•			•			



MODIFICATIONS & ADDITIONS

ADDITION TO LIST PRICE

Quick Connect

\$35.15

Available for ETM, ETW, and RETW options. Top and bottom knockouts for standard conduit fittings.

Concealed Electric Monitoring (EMN)

\$265.75

- Miniature switch is incorporated into the frame leaf.
- Specify handing and the dimension from the top edge of the door to the centerline of the electric monitoring location.
- Special Electric Modifications and EPT locations may require additional charges if screw holes have to be moved.
- Templates regarding location of monitoring switch available upon request.

Concealed Electric Through-Wire and Monitoring (ETM)

- Electric Preparation

ETM-4	\$530.40
ETM-6	\$578.60
ETM-8	\$615.65
ETM-10	\$655.70

- All ETM have 28-Gauge continuous conductors.
- This combines the continuous electric conductors and the miniature switch to provide both power transfer and monitoring.
- Miniature switch is incorporated into the frame leaf.
- Specify handing and the dimension from the top edge of the door to the centerline of each electric modification location.
- Templates regarding location of monitoring switch available upon request.

Concealed Electric Through-Wire (ETW)

- Electric Preparation

ETW-4	\$265.75
ETW-6	\$308.85
ETW-8	\$345.95
ETW-10	\$394.05
ETW-12	\$441.00

- All ETW have 28-Gauge continuous conductors.
- 12" per side required as a suffix.
- Cut out for prep - 1/2" drilled hole.
- Transfers power discreetly from building to door hardware.
- Specify handing and the dimension from the top edge of the the door to the centerline of the electric through-wire location.
- Special electric modifications and EPT locations may require additional charges if screw holes have to be moved.
Contact Hager Customer Service for charges.
- Templates regarding location of through-wires available upon request.

Available on the following Roton Concealed profiles:

- 780-111 • 780-124 • 780-226 • 1200-600
- 780-112 • 780-224 • 780-235 • 1200-650

Hager Power Transfer or Von Duprin EPT-2 or EPT-10 Electric Power Transfer Preparation (EPT)

Concealed Leaf	\$103.35
Half Surface	\$62.25

- Hinge leaf cutout to accommodate power transfer device.
- Specify handing and the dimension from the top edge of the door to the centerline of the power transfer location.
- Special Electric Modifications and EPT locations may require additional charges if screw holes have to be moved.



Roton Continuous Hinges

MODIFICATIONS & ADDITIONS

ADDITION TO LIST PRICE

Lead Wire for Concealed Electric Hinges

Electric Preparation

4-wire hinge

6-wire hinge

8-wire hinge

10-wire hinge

- Standard wire leads are 12" per side
- Additional wire leads are available

Per Foot

\$9.15

\$13.35

\$16.65

\$18.85

Exposed Electric Switches (E1S)

\$92.85

- Miniature push button switch incorporated in hinge frame leaf to monitor position of the door.
- Three 12" wire leads.
- Each monitoring hinge only needs one E1S Switch.
- Specify handing and the dimension from the top edge of the the door to the centerline of the electric switch location.
- Templates regarding location of contact switch available upon request.

Exposed Electric Contacts (E)

\$92.85

- Transfers power to door in closed position.
- Must have at least two (2) contacts to transfer power.
- Specify handing and the dimension from the top edge of the the door to the centerline of the electric contact location.
- Templates regarding location of contacts available upon request.

Removable Electric Through-Wire (RETW) Twelve Wire

\$645.00

Removable 12 Wire Module Only

\$263.00

Component

Finish

7-102-1870

Clear

7-112-1872

Dark Bronze

7-112-1876

Gold

7-112-1881

Black

Removable Electric Through-Wire (RETW) Ten Wire

\$546.65

Removable 10 Wire Module Only

\$212.75

Component

Finish

7-102-1860

Clear

7-112-1870

Dark Bronze

7-112-1875

Gold

7-112-1880

Black



Available on heavy duty concealed profiles:

- 780-111HD • 780-124HD • 780-226HD
- 780-112HD • 780-224HD

- Transfers power discreetly from building to door hardware.
- Removable ETW module can be easily removed for adjustment for service.
- Templates regarding location of monitoring switch available upon request.
- Specify handing and the dimension from the top edge of the door to the centerline of the electric through-wire location.

MODIFICATIONS & ADDITIONS

ADDITION TO LIST PRICE

Mortar Box - 430

\$36.80

- Serves as a mortar shield.
- Overall dimensions: 9" (229 mm) length with tabs, 7" (178 mm) inside, 1-3/4" x 1-3/4" (45 mm x 45 mm) inside dimension.
- Galvanized steel 0.040" (1 mm)

**Replacement Molding
780-052M**

Hinge Lengths

79", 83", 85"

95"

119"

Clear Anodized

\$38.20

\$44.15

\$52.70

Dark Bronze Anodized

\$44.15

\$52.70

\$61.20

Replacement door leaf molding for: 780-053, 780-053HD, 780-054HD, 780-155HD, 780-057HD, 780-157, 780-157HD, 780-257HD, and 780-259HD.

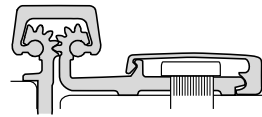

**Replacement Molding
780-210M**

Hinge Lengths

79", 83", 85"

95"

119"

Clear Anodized

\$40.20

\$49.70

\$58.20

Dark Bronze Anodized

\$49.70

\$58.20

\$65.80

Replacement door leaf molding for: 780-210, 780-210HD, 780-211, 780-211HD, 780-213HD, 780-045HD, and 780-046HD.

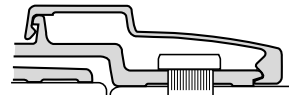

**Replacement Molding
780-247M**

Hinge Lengths

79", 83", 85"

95"

119"

Clear Anodized

\$34.15

\$40.20

\$49.70

Dark Bronze Anodized

\$40.20

\$49.70

\$58.20

Replacement frame leaf molding
780-157, 780-157HD, 780-257HD

Note: Replacement moldings for 780-052M and 780-210M are shipped in stock lengths for trimming in the field and furnished with Allen head set screw and wrench.

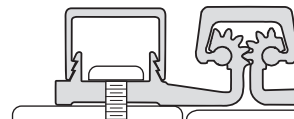

Roton Continuous Hinges

MODIFICATIONS & ADDITIONS

ADDITION TO LIST PRICE

Short Hinges

\$22.10

Hinges shorter than 79" will be invoiced at the 79" price. Where two or more short hinges can be obtained from a standard length, pricing is based on the number of standard lengths utilized plus an assembly charge for each hinge.

Extra Long Hinges

\$96.50

Hinges over 119" are manufactured as two separate lengths with a staggered joint for on-site connection. Hinge segments are taken from standard sizes for best economics in relation to the quantity required. Hanging specifications are required to position the cuts inconspicuously and to finish symmetrical pairs in double door applications.

Custom Hole Pattern

Price on Application

Any hinge may be ordered with special hole locations for unusual frame or door conditions. Please provide specifications for each leaf.

Bearing At Top

\$41.15

This application allows for the bearing to be set at the very top of the cover channel. The cover channel is flush with the top of the geared hinge, preventing any obstructions or debris from being inserted in the top of the channel.

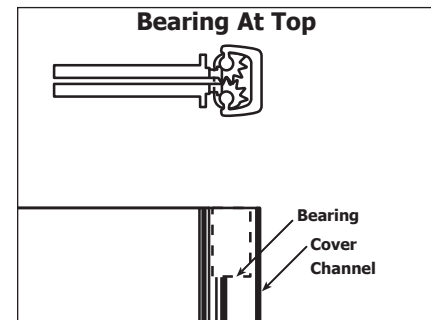

Hospital Tip

\$121.35

Concealed models only can be prepared with a cover channel tapered at 45° angle at the top of the hinge. These are ideal for use in hospitals and correctional facilities to help provide a clean and safe environment.

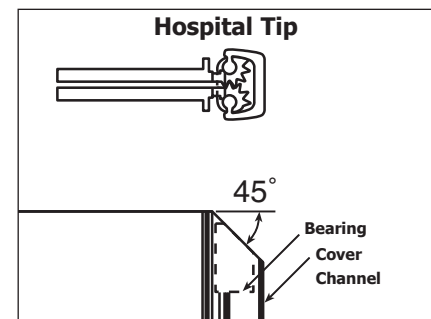

MODIFICATIONS & ADDITIONS

ADDITION TO LIST PRICE

Tamper Resistant Hinge

\$142.40

This application is intended for use in hospital psychiatric areas and places of high security. The hinge is prepared with a hospital tip (concealed models only) and every other bearing is supplied with a set screw to lock against the inside of the cover channel for additional security.

Dutch Door Prep

\$84.30

Furnished as continuous frame leaf, whole door leaf is cut to fit dutch door specified length.

Bearing Replacement Kit

Clear and Dark Bronze

Standard Duty for 780 Series

\$43.20

Heavy Duty for 780 Series

\$82.25

Extra Heavy Duty for 1200 Series

\$163.50

Marking Jigs

\$202.55

Marking jigs are available to locate the centers of the top end frame screws.

These jigs must be ordered at the same time as the hinges to ensure fabrication accuracy.

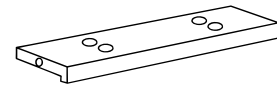

Center Punches

\$9.15

Self-Centering center punches are available for #12 countersunk screws supplied.

To make sure screw heads seat properly, accurate center punching is required.

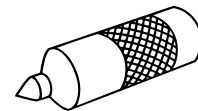

Roton Continuous Hinges

MODIFICATIONS & ADDITIONS

ADDITION TO LIST PRICE

Shim Stock

1/16" x 1-1/2" Wide x 7' Long	\$31.65 each
1/8" x 1-1/2" Wide x 7' Long	\$44.15 each
1/16" x 1-1/2" Wide x 10' Long	\$66.75 each
1/8" x 1-1/2" Wide x 10' Long	\$93.85 each

For clearance between the door and frame which may be excessive, a continuous shim is helpful (applied behind the frame leaf only). Anodized aluminum extrusions are supplied with no holes.

Shipping Carton

\$22.10 each

Extra shipping cartons are available for reshipping hinges in quantities of 2 or less.

Fasteners

All hinges are shipped with appropriate fasteners for metal doors and frames except where noted. **If wood screws are required, please specify on order, and wood screws will be substituted at no extra charge.** Bulk screws are packed separately.

Description	Part Numbers		
	Clear	Dark Bronze	
#12 x 1-1/2" Flat Head Wood Screw	7-080-0050	7-080-0051	\$244.85/box of 500
#12-24 x 11/16" Self-Drilling Flat Head Screw	7-080-0070	7-080-0072	\$218.90/box of 500
#12-24 x 1/2" Spanner Head Machine Screw			\$1.95 each
#12-24 x 11/16" Drill Quick Torx Screw			\$1.95 each
#12-24 x 13/32" Self-Threading Screw (Clear or Bronze)			\$0.80 each
#12-24 x 11/16" Self-Drilling Flat Head Screw (Clear or Bronze)			\$1.10 each
#12-24 x 11/16" Self-Drilling Pan Head Screw (Clear)			\$1.10 each
#12 x 1-1/2" Flat Head Wood Screw (Clear or Bronze)			\$1.10 each
Sexbolts			\$2.90 each

Note: Additional fasteners may be ordered as follows (add to the hinge list price before applying buying group discount).

Roton Continuous Geared Hinges

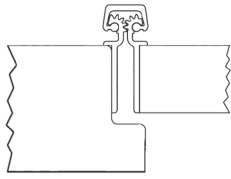

Description		Finish	2016 List	Stock No.	Case Qty.
500-048 Concealed Leaf With Sheet Metal Screws 1-1/6" Nominal Leaf Thickness	24" (610 mm)	Clear	70.25	068560	1
		Dark Bronze	93.65	068046	
	36" (914 mm)	Clear	79.60	068521	1
		Dark Bronze	105.40	067971	
	48" (1219 mm)	Clear	93.65	068520	1
		Dark Bronze	117.10	067970	
	72" (1829 mm)	Clear	117.10	068509	1
		Dark Bronze	140.45	067969	

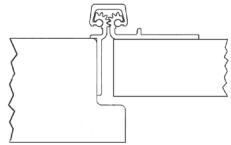

500-200 Half Surface With Sheet Metal Screws 1-1/6" Nominal Leaf Thickness	24" (610 mm)	Clear	70.25	067967	1
		Dark Bronze	93.65	067559	
	36" (914 mm)	Clear	82.00	067964	1
		Dark Bronze	105.40	067431	
	48" (1219 mm)	Clear	93.65	067961	1
		Dark Bronze	117.10	067269	
	72" (1829 mm)	Clear	117.10	067959	1
		Dark Bronze	140.45	067266	

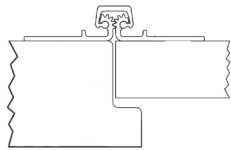

500-220 Full Surface With Sheet Metal Screws 1-1/6" Nominal Leaf Thickness	24" (610 mm)	Clear	70.25	067944	1
		Dark Bronze	93.65	067060	
	36" (914 mm)	Clear	82.00	067940	1
		Dark Bronze	105.40	067009	
	48" (1219 mm)	Clear	93.65	067939	1
		Dark Bronze	117.10	067001	
	72" (1829 mm)	Clear	117.10	067938	1
		Dark Bronze	140.45	067000	

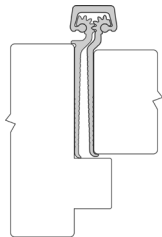

750-134 Concealed Leaf With Half Drill Quick and Half Wood Screws 1-3/4" Interior Wood Door	79" (2007 mm)	Clear	151.50	002378	8
		Dark Bronze	209.85	019142	
	83" (2108 mm)	Clear	151.50	060025	8
		Dark Bronze	209.85	014126	
	85" (2159 mm)	Clear	151.50	036922	8
		Dark Bronze	209.85	074623	
	95" (2413 mm)	Clear	192.60	013743	8
		Dark Bronze	254.90	021691	
	119" (3023 mm)	Clear	298.10	011935	6
		Dark Bronze	381.00	017503	

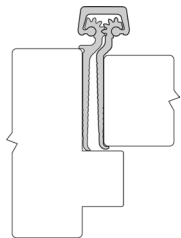

750-138 Concealed Leaf With Half Drill Quick and Half Wood Screws 1-3/8" Interior Wood Door	79" (2007 mm)	Clear	154.10	063094	8
		Dark Bronze	203.25	021087	
	83" (2108 mm)	Clear	154.10	071365	8
		Dark Bronze	203.25	018414	
	85" (2159 mm)	Clear	154.10	026749	8
		Dark Bronze	203.25	084606	
	95" (2413 mm)	Clear	188.55	019624	8
		Dark Bronze	242.30	021998	
	119" (3023 mm)	Clear	290.80	019072	8
		Dark Bronze	364.40	-	

1. Items with the price in **bold and red** are Quick Ship items and ship in three days or less.
Please use stock number when ordering. 2. U/M is each unless otherwise noted.

04/01/2016
www.hagerco.com



Roton Continuous Geared Hinges

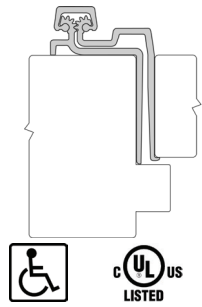

Description		Finish	2016 List	Stock No.	Case Qty.
780-041HD Concealed Leaf Heavy Duty 1-3/4" Door Swing Clear Action	79" (2007 mm)	Clear	362.40	017704	6
		Dark Bronze	476.25	161734	
	83" (2108 mm)	Clear	362.40	014172	6
		Dark Bronze	476.25	023946	
	85" (2159 mm)	Clear	362.40	022882	6
		Dark Bronze	476.25	170751	
	95" (2413 mm)	Clear	444.80	009009	6
		Dark Bronze	585.80	167333	
	119" (3023 mm)	Clear	663.85	077180	2
		Dark Bronze	873.20	157744	

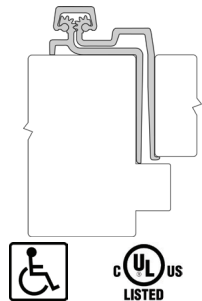

780-041LL Concealed Leaf With Half Drill Quick and Half Wood Screws 1-3/4" Door Lead Lined Heavy Duty Profile Only Swing Clear Action	79" (2007 mm)	Clear	373.20	-	6
		Dark Bronze	488.15	-	
	83" (2108 mm)	Clear	373.20	022711	6
		Dark Bronze	488.15	-	
	85" (2159 mm)	Clear	373.20	-	6
		Dark Bronze	488.15	-	
	95" (2413 mm)	Clear	456.75	170193	6
		Dark Bronze	597.75	-	
	119" (3023 mm)	Clear	674.75	-	2
		Dark Bronze	885.10	-	

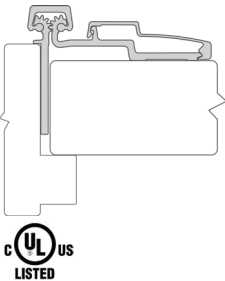

780-045HD Half Surface Heavy Duty	79" (2007 mm)	Clear	425.45	004046	4
		Dark Bronze	568.75	-	
	83" (2108 mm)	Clear	425.45	065575	4
		Dark Bronze	568.75	152230	
	85" (2159 mm)	Clear	425.45	161260	4
		Dark Bronze	568.75	165869	
	95" (2413 mm)	Clear	523.00	104689	4
		Dark Bronze	699.50	168059	
	119" (3023 mm)	Clear	779.15	163204	2
		Dark Bronze	1,040.60	161207	

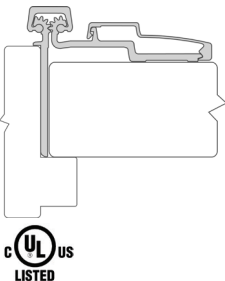

780-046HD Half Surface Heavy Duty	79" (2007 mm)	Clear	457.95	163916	4
		Dark Bronze	600.65	-	
	83" (2108 mm)	Clear	457.95	026032	4
		Dark Bronze	600.65	149561	
	85" (2159 mm)	Clear	457.95	158054	4
		Dark Bronze	600.65	-	
	95" (2413 mm)	Clear	561.50	025211	4
		Dark Bronze	746.65	162657	
	119" (3023 mm)	Clear	838.85	-	2
		Dark Bronze	1,111.55	-	

Roton Continuous Geared Hinges

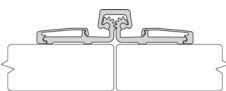
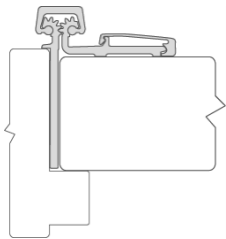
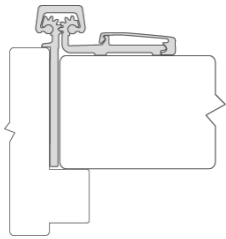
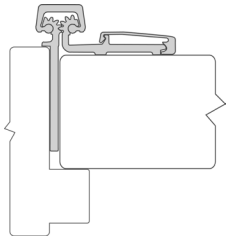

Description	Finish	2016 List	Stock No.	Case Qty.
780-053 Half Surface	79" (2007 mm) Clear	222.55	056995	5
	79" (2007 mm) Dark Bronze	306.00	163993	
	83" (2108 mm) Clear	222.55	001927	5
	83" (2108 mm) Dark Bronze	306.00	014876	
	95" (2413 mm) Clear	275.70	010247	5
	95" (2413 mm) Dark Bronze	373.00	009044	
780-053HD Half Surface Heavy Duty	79" (2007 mm) Clear	282.00	013612	5
	79" (2007 mm) Dark Bronze	350.20	082818	
	83" (2108 mm) Clear	282.00	048054	5
	83" (2108 mm) Dark Bronze	350.20	018175	
	85" (2159 mm) Clear	282.00	050663	5
	85" (2159 mm) Dark Bronze	350.20	132585	
	95" (2413 mm) Clear	346.45	014523	5
	95" (2413 mm) Dark Bronze	419.75	018393	
	119" (3023 mm) Clear	530.30	052397	3
	119" (3023 mm) Dark Bronze	707.95	093628	
780-054HD Half Surface Heavy Duty	79" (2007 mm) Clear	308.00	021269	5
	79" (2007 mm) Dark Bronze	375.05	131605	
	83" (2108 mm) Clear	308.00	013605	5
	83" (2108 mm) Dark Bronze	375.05	027437	
	85" (2159 mm) Clear	308.00	078989	5
	85" (2159 mm) Dark Bronze	375.05	071971	
	95" (2413 mm) Clear	377.05	078992	5
	95" (2413 mm) Dark Bronze	446.00	071970	
	119" (3023 mm) Clear	580.00	026627	3
	119" (3023 mm) Dark Bronze	748.60	159983	
780-057HD Full Surface Heavy Duty Bi-Fold Applications	79" (2007 mm) Clear	329.00	021238	5
	79" (2007 mm) Dark Bronze	460.00	017850	
	83" (2108 mm) Clear	329.00	007856	5
	83" (2108 mm) Dark Bronze	460.00	025973	
	85" (2159 mm) Clear	329.00	025846	5
	85" (2159 mm) Dark Bronze	460.00	174835	
	95" (2413 mm) Clear	414.15	024478	5
	95" (2413 mm) Dark Bronze	569.50	094331	
	119" (3023 mm) Clear	617.30	088469	4
	119" (3023 mm) Dark Bronze	848.20	165568	

1. Items with the price in **bold and red** are Quick Ship items and ship in three days or less.
Please use stock number when ordering. 2. U/M is each unless otherwise noted.



Roton Continuous Geared Hinges

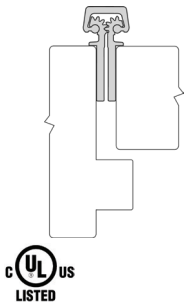

Description		Finish	2016 List	Stock No.	Case Qty.
780-110HD Concealed Leaf Heavy Duty For 1" to 1-3/8" door	79" (2007 mm)	Clear	207.15	009945	8
		Dark Bronze	267.60	127036	
	83" (2108 mm)	Clear	207.15	009549	8
		Dark Bronze	267.60	006241	
	85" (2159 mm)	Clear	207.15	044312	8
		Dark Bronze	267.60	173953	
95" (2413 mm)	Clear	248.90	100893	8	
	Dark Bronze	322.60	161122		
119" (3023 mm)	Clear	394.25	158984	7	
	Dark Bronze	517.70	169966		

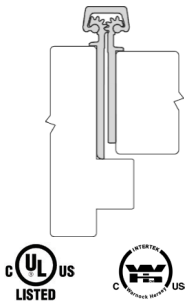

780-111 Concealed Leaf	79" (2007 mm)	Clear	163.40	006836	8
		Dark Bronze	211.10	173663	
	83" (2108 mm)	Clear	163.40	032217	8
		Dark Bronze	211.10	072103	
	95" (2413 mm)	Clear	197.15	105549	8
		Dark Bronze	256.30	158705	

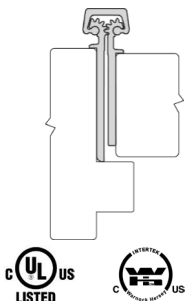

780-111HD Concealed Leaf Heavy Duty	79" (2007 mm)	Clear	203.25	084020	8
		Dark Bronze	262.90	141484	
	83" (2108 mm)	Clear	203.25	017716	8
		Dark Bronze	262.90	022018	
	85" (2159 mm)	Clear	203.25	011544	8
		Dark Bronze	262.90	157970	
95" (2413 mm)	Clear	244.35	004806	8	
	Dark Bronze	316.05	066260		
119" (3023 mm)	Clear	390.45	084943	7	
	Dark Bronze	508.50	159150		

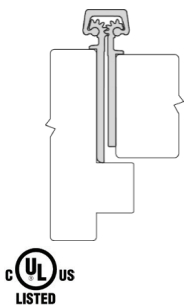

780-111LL Concealed Leaf With Half Drill Quick and Half Wood Screws Lead Lined Heavy Duty Profile Only	79" (2007 mm)	Clear	217.80	128464	8
		Dark Bronze	276.85	-	
	83" (2108 mm)	Clear	217.80	075316	8
		Dark Bronze	276.85	158738	
	85" (2159 mm)	Clear	217.80	-	8
		Dark Bronze	276.85	-	
95" (2413 mm)	Clear	258.90	175965	8	
	Dark Bronze	329.90	163527		
119" (3023 mm)	Clear	400.95	-	7	
	Dark Bronze	523.00	-		

1. Items with the price in **bold and red** are Quick Ship items and ship in three days or less. Please use stock number when ordering. 2. U/M is each unless otherwise noted.

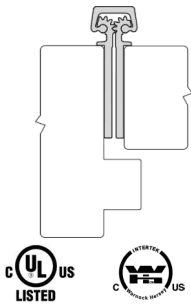

Description		Finish	2016 List	Stock No.	Case Qty.
780-112 Concealed Leaf Single Pack w/ Drill Quick Screws	79" (2007 mm)	Clear	137.55	016302	8
		Dark Bronze	177.70	018354	
	83" (2108 mm)	Clear	137.55	048046	8
		Dark Bronze	177.70	048047	
	95" (2413 mm)	Clear	168.50	048048	7
		Dark Bronze	219.70	019047	

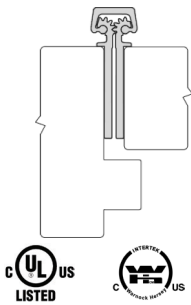

780-112 Concealed Leaf Case Pack w/ Drill Quick Screws Must Order Case Quantity	83" (2108 mm)	Clear	123.80	158844	8
		Dark Bronze	159.95	159092	
780-112HD Concealed Leaf Single Pack w/ Drill Quick Screws	79" (2007 mm)	Clear	170.85	011666	8
		Dark Bronze	220.80	034272	
	83" (2108 mm)	Clear	170.85	048056	8
		Dark Bronze	220.80	048057	
	85" (2159 mm)	Clear	170.85	070633	8
		Dark Bronze	220.80	011667	
	95" (2413 mm)	Clear	205.85	048564	7
		Dark Bronze	271.45	048565	
	119" (3023 mm)	Clear	331.15	048058	7
		Dark Bronze	436.40	159038	

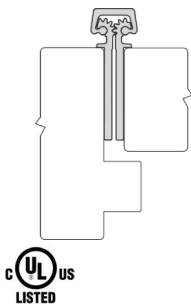

780-112HD Concealed Leaf Case Pack w/ Drill Quick Screws Must Order Case Quantity	83" (2108 mm)	Clear	156.40	154078	8
		Dark Bronze	198.75	167461	
780-112LL Concealed Leaf With Half Drill Quick and Half Wood Screws Lead Lined Heavy Duty Profile Only	79" (2007 mm)	Clear	188.45	050685	8
		Dark Bronze	244.00	-	
	83" (2108 mm)	Clear	188.45	048068	8
		Dark Bronze	244.00	162642	
	85" (2159 mm)	Clear	188.45	023194	8
		Dark Bronze	244.00	-	
	95" (2413 mm)	Clear	227.05	001432	8
		Dark Bronze	291.05	157945	
119" (3023 mm)	Clear	362.15	162221	7	
	Dark Bronze	473.30	-		

1. Items with the price in **bold and red** are Quick Ship items and ship in three days or less.
Please use stock number when ordering. 2. U/M is each unless otherwise noted.



Roton Continuous Geared Hinges

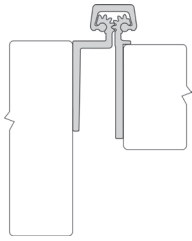

Description		Finish	2016 List	Stock No.	Case Qty.
780-113HD Concealed Leaf Heavy Duty "Safety Hinge" When Used Without Frame Stop	79" (2007 mm)	Clear	342.55	008721	6
		Dark Bronze	460.60	086160	
	83" (2108 mm)	Clear	342.55	063578	6
		Dark Bronze	460.60	014496	
	85" (2159 mm)	Clear	342.55	092239	6
		Dark Bronze	460.60	086847	
	95" (2413 mm)	Clear	561.50	063579	6
		Dark Bronze	630.50	012154	
	119" (3023 mm)	Clear	696.85	063577	4
		Dark Bronze	823.65	-	

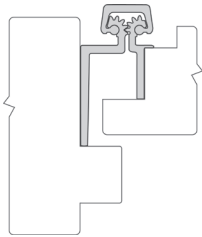

780-114HD Concealed Leaf Heavy Duty Center Hung Applications	79" (2007 mm)	Clear	339.80	098942	5
		Dark Bronze	450.10	049457	
	83" (2108 mm)	Clear	339.80	016568	5
		Dark Bronze	450.10	139316	
	85" (2159 mm)	Clear	339.80	076856	5
		Dark Bronze	450.10	-	
	95" (2413 mm)	Clear	418.15	084403	5
		Dark Bronze	552.20	117204	
	119" (3023 mm)	Clear	622.55	-	3
		Dark Bronze	823.00	-	

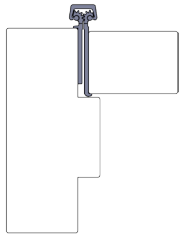

780-124HD Concealed Leaf Heavy Duty profile only Single Pack w/ Drill Quick Screws	79" (2007 mm)	Clear	172.00	161228	8
		Dark Bronze	224.00	169197	
	83" (2108 mm)	Clear	172.00	152428	8
		Dark Bronze	224.00	166643	
	85" (2159 mm)	Clear	172.00	164175	8
		Dark Bronze	224.00	-	
	95" (2413 mm)	Clear	208.00	152433	7
		Dark Bronze	250.00	166645	
	119" (3023 mm)	Clear	338.00	164231	7
		Dark Bronze	443.00	-	

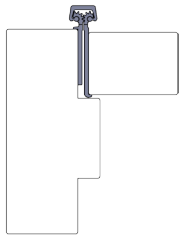

780-124LL Concealed Leaf Heavy Duty profile only With half drill quick and Half Wood Screws Lead Lined	79" (2007 mm)	Clear	194.00	-	8
		Dark Bronze	250.00	-	
	83" (2108 mm)	Clear	194.00	164677	8
		Dark Bronze	250.00	-	
	85" (2159 mm)	Clear	194.00	-	8
		Dark Bronze	250.00	-	
	95" (2413 mm)	Clear	233.00	-	7
		Dark Bronze	294.00	-	
	119" (3023 mm)	Clear	370.00	-	7
		Dark Bronze	480.00	-	



Roton Continuous Geared Hinges

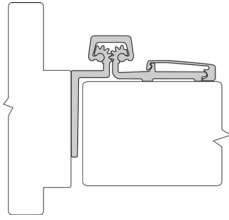

Description	Finish	2016 List	Stock No.	Case Qty.
780-155HD Half Surface Heavy Duty Center Hung and Egress Conversions	79" (2007 mm) Clear	359.80	016603	5
	79" (2007 mm) Dark Bronze	484.50	128736	
	83" (2108 mm) Clear	359.80	068088	5
	83" (2108 mm) Dark Bronze	484.50	068371	
	85" (2159 mm) Clear	359.80	018276	5
	85" (2159 mm) Dark Bronze	484.50	046665	
	95" (2413 mm) Clear	441.45	063096	5
	95" (2413 mm) Dark Bronze	597.30	056566	
	119" (3023 mm) Clear	657.05	078745	2
	119" (3023 mm) Dark Bronze	888.00	062632	

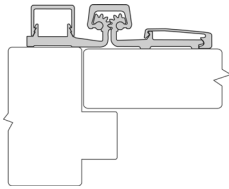

780-157 Full Surface Frame Face Dimension Limitations	79" (2007 mm) Clear	211.60	022092	5
	79" (2007 mm) Dark Bronze	285.80	049196	
	83" (2108 mm) Clear	211.60	048049	5
	83" (2108 mm) Dark Bronze	285.80	063070	
	95" (2413 mm) Clear	258.70	021262	5
	95" (2413 mm) Dark Bronze	349.05	009045	

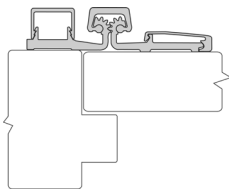

780-157HD Full Surface Heavy Duty Frame Face Dimension Limitations	79" (2007 mm) Clear	262.20	022028	5
	79" (2007 mm) Dark Bronze	319.70	084386	
	83" (2108 mm) Clear	262.20	048059	5
	83" (2108 mm) Dark Bronze	319.70	062422	
	85" (2159 mm) Clear	262.20	019546	5
	85" (2159 mm) Dark Bronze	319.70	035156	
	95" (2413 mm) Clear	314.55	048060	5
	95" (2413 mm) Dark Bronze	384.05	010547	
	119" (3023 mm) Clear	516.25	099644	2
	119" (3023 mm) Dark Bronze	672.05	037141	

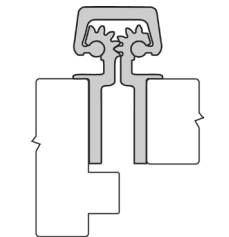

780-208HD Concealed Leaf Heavy Duty Bi-Fold Applications	79" (2007 mm) Clear	247.00	086976	7
	79" (2007 mm) Dark Bronze	316.60	099629	
	83" (2108 mm) Clear	247.00	015254	7
	83" (2108 mm) Dark Bronze	316.60	-	
	85" (2159 mm) Clear	247.00	040232	7
	85" (2159 mm) Dark Bronze	316.60	-	
	95" (2413 mm) Clear	270.80	095067	7
	95" (2413 mm) Dark Bronze	389.00	-	
	119" (3023 mm) Clear	404.20	139585	5
	119" (3023 mm) Dark Bronze	580.00	018910	

1. Items with the price in **bold and red** are Quick Ship items and ship in three days or less.
Please use stock number when ordering. 2. U/M is each unless otherwise noted.



Roton Continuous Geared Hinges

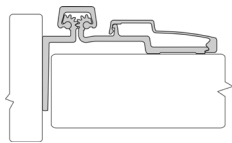
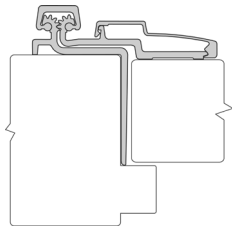
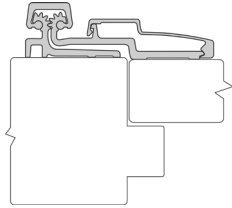
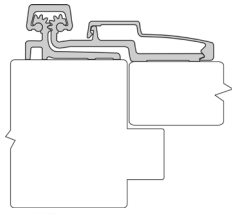

Description		Finish	2016 List	Stock No.	Case Qty.
780-210 Full Surface	79" (2007 mm)	Clear	211.60	010064	6
		Dark Bronze	285.80	073030	
	83" (2108 mm)	Clear	211.60	048050	6
		Dark Bronze	285.80	048051	
	95" (2413 mm)	Clear	253.15	063037	6
		Dark Bronze	344.90	020588	
780-210HD Full Surface Heavy Duty	79" (2007 mm)	Clear	258.20	017046	6
		Dark Bronze	313.90	017037	
	83" (2108 mm)	Clear	258.20	048061	6
		Dark Bronze	313.90	048062	
	85" (2159 mm)	Clear	258.20	024124	6
		Dark Bronze	313.90	071974	
	95" (2413 mm)	Clear	304.75	048063	6
		Dark Bronze	374.95	046722	
	119" (3023 mm)	Clear	504.80	025722	2
		Dark Bronze	565.70	000304	
780-211HD Half Surface Heavy Duty Frame Leaf Wrap-Around Reinforcement for Damaged Frames	79" (2007 mm)	Clear	503.15	116360	4
		Dark Bronze	661.10	-	
	83" (2108 mm)	Clear	503.15	010867	4
		Dark Bronze	661.10	120382	
	85" (2159 mm)	Clear	503.15	162789	4
		Dark Bronze	661.10	160923	
	95" (2413 mm)	Clear	619.25	115949	4
		Dark Bronze	813.65	-	
	119" (3023 mm)	Clear	922.50	158595	2
		Dark Bronze	1,212.45	-	
780-213HD Half Surface Heavy Duty Center Hung Doors	79" (2007 mm)	Clear	476.55	023958	4
		Dark Bronze	629.20	107818	
	83" (2108 mm)	Clear	476.55	007660	4
		Dark Bronze	629.20	056801	
	85" (2159 mm)	Clear	476.55	044343	4
		Dark Bronze	629.20	147623	
	95" (2413 mm)	Clear	584.75	012731	4
		Dark Bronze	773.85	038555	
	119" (3023 mm)	Clear	871.40	010262	2
		Dark Bronze	1,153.35	147624	

1. Items with the price in **bold and red** are Quick Ship items and ship in three days or less. Please use stock number when ordering. 2. U/M is each unless otherwise noted.

Roton Continuous Geared Hinges

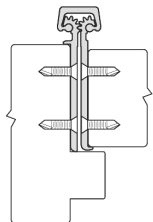
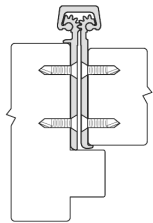
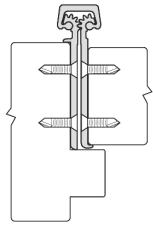

Description	Finish	2016 List	Stock No.	Case Qty.	
780-224 Concealed Leaf 1-3/4" Doors Single Pack w/ Drill Quick Screws	79" (2007 mm)	Clear	139.25	019803	7
	83" (2108 mm)	Dark Bronze	181.70	004347	
		Clear	139.25	048052	7
	95" (2413 mm)	Dark Bronze	181.70	071879	
		Clear	174.90	048053	7
		Dark Bronze	226.00	071878	
<hr/>					
780-224 Concealed Leaf 1-3/4" Doors Case Pack w/ Drill Quick Screws Must Order Case Quantity	83" (2108 mm)	Clear	125.30	160135	7
		Dark Bronze	-	-	
<hr/>					
780-224HD Concealed Leaf 1-3/4" Doors Single Pack w/ Drill Quick Screws	79" (2007 mm)	Clear	173.75	059400	7
	83" (2108 mm)	Dark Bronze	226.00	060889	
		Clear	173.75	048064	7
	85" (2159 mm)	Dark Bronze	226.00	048065	
		Clear	173.75	049526	7
	95" (2413 mm)	Dark Bronze	226.00	063257	
		Clear	210.45	048066	7
	119" (3023 mm)	Dark Bronze	277.20	000725	
		Clear	344.90	048067	5
		Dark Bronze	449.00	159563	
<hr/>					
780-224HD Concealed Leaf 1-3/4" Doors Case Pack w/ Drill Quick Screws Must Order Case Quantity	83" (2108 mm)	Clear	156.40	154078	7
		Dark Bronze	203.50	167461	
<hr/>					
780-224LL Concealed Leaf 1-3/4" Doors Lead Lined With Half Drill Quick and Half Wood Screws Heavy Duty Profile Only	79" (2007 mm)	Clear	198.70	073096	7
	83" (2108 mm)	Dark Bronze	253.60	084063	
		Clear	198.70	013673	7
	85" (2159 mm)	Dark Bronze	253.60	016303	
		Clear	198.70	083466	7
	95" (2413 mm)	Dark Bronze	253.60	-	
		Clear	240.25	113157	7
	119" (3023 mm)	Dark Bronze	295.80	158591	
		Clear	377.90	172408	5
		Dark Bronze	487.15	-	

1. Items with the price in **bold and red** are Quick Ship items and ship in three days or less.
Please use stock number when ordering. 2. U/M is each unless otherwise noted.



Roton Continuous Geared Hinges

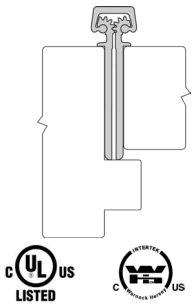

Description		Finish	2016 List	Stock No.	Case Qty.
780-226HD Concealed Leaf Heavy Duty For Doors 2" or Thicker	79" (2007 mm)	Clear	207.85	088199	7
		Dark Bronze	271.50	136659	
Concealed Leaf Heavy Duty For Doors 2" or Thicker	83" (2108 mm)	Clear	207.85	040515	7
		Dark Bronze	271.50	078293	
	85" (2159 mm)	Clear	207.85	027838	7
		Dark Bronze	271.50	158703	
	95" (2413 mm)	Clear	252.95	048626	7
		Dark Bronze	325.30	159236	
	119" (3023 mm)	Clear	406.85	158833	5
		Dark Bronze	528.40	159521	

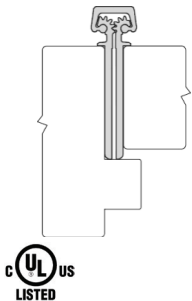

780-226LL Concealed Leaf For Lead Lined Doors 2" or Thicker With Half Drill Quick and Half Wood Screws Heavy Duty Profile Only	79" (2007 mm)	Clear	223.05	009762	7
		Dark Bronze	284.15	158476	
	83" (2108 mm)	Clear	223.05	100252	7
		Dark Bronze	284.15	-	
	85" (2159 mm)	Clear	223.05	-	7
		Dark Bronze	284.15	-	
	95" (2413 mm)	Clear	269.60	158010	7
		Dark Bronze	324.00	165412	
	119" (3023 mm)	Clear	423.50	068684	5
		Dark Bronze	545.55	158475	

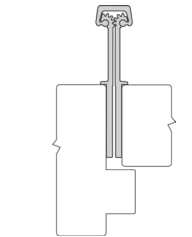

780-235HD Concealed Leaf Heavy Duty Wide Throw	83" (2108 mm)	Clear	478.60	052841	1
		Dark Bronze	626.50	053517	
	95" (2413 mm)	Clear	590.70	052846	1
		Dark Bronze	752.60	053522	

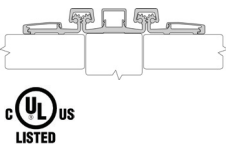

780-257HD Full Surface Heavy Duty Double hinge for hanging two doors from a fixed mullion.	79" (2007 mm)	Clear	500.45	-	2
		Dark Bronze	687.60	-	
	83" (2108 mm)	Clear	500.45	081899	2
		Dark Bronze	687.60	159250	
	85" (2159 mm)	Clear	500.45	112767	2
		Dark Bronze	687.60	158749	
	95" (2413 mm)	Clear	615.90	028146	2
		Dark Bronze	845.50	161153	
	119" (3023 mm)	Clear	918.40	162543	2
		Dark Bronze	1,260.25	-	



Roton Continuous Geared Hinges

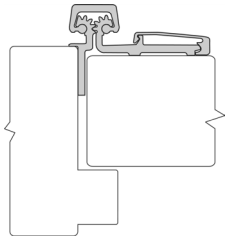

Description		Finish	2016 List	Stock No.	Case Qty.
780-259HD Half Surface Heavy Duty For 3/4" or 1" door	79" (2007 mm)	Clear	309.40	026034	5
		Dark Bronze	430.15	103994	
	83" (2108 mm)	Clear	309.40	026035	5
		Dark Bronze	430.15	147628	
	85" (2159 mm)	Clear	309.40	147629	5
		Dark Bronze	430.15	147630	

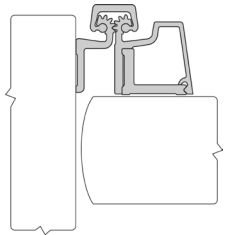

780-300HD Half Surface Heavy Duty Center Hung Applications	79" (2007 mm)	Clear	357.20	010212	4
		Dark Bronze	485.25	019206	
	83" (2108 mm)	Clear	357.20	047819	4
		Dark Bronze	485.25	057968	
	85" (2159 mm)	Clear	357.20	061937	4
		Dark Bronze	485.25	038063	

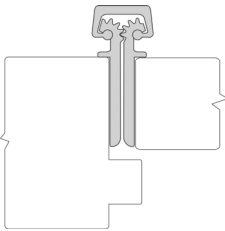

1200-600XHD Concealed Leaf Extra Heavy Duty For doors from 1-3/4" to 2-3/8" thick.	83" (2108 mm)	Clear	996.50	000590	1
		Dark Bronze	1,394.65	028601	
	95" (2413 mm)	Clear	1,129.15	004040	1
		Dark Bronze	1,527.25	065709	
	119" (3023 mm)	Clear	1,261.95	090770	1
		Dark Bronze	1,660.00	107206	

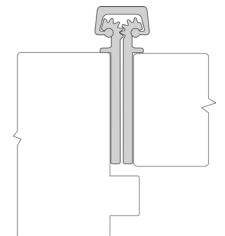

1200-650XHD Concealed Leaf Extra Heavy Duty For doors 2-3/8" thick or thicker.	83" (2108 mm)	Clear	1,328.25	090353	1
		Dark Bronze	1,726.40	135473	
	95" (2413 mm)	Clear	1,461.00	090439	1
		Dark Bronze	1,859.05	108903	
	119" (3023 mm)	Clear	1,593.70	090440	1
		Dark Bronze	1,991.85	044852	

1. Items with the price in **bold and red** are Quick Ship items and ship in three days or less.
Please use stock number when ordering. 2. U/M is each unless otherwise noted.

