

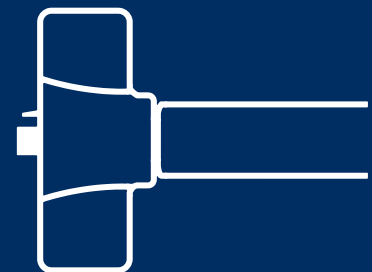

Security Door Controls

The Lock Behind Your System

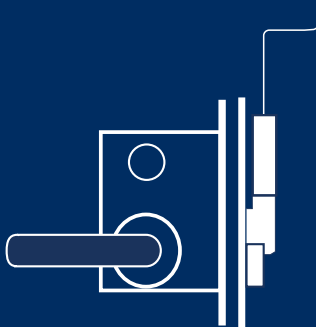
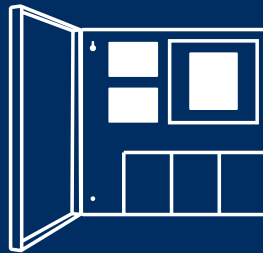
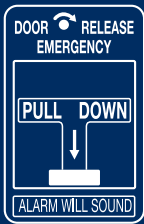

Price List 18.3

PRICES VALID STARTING FEBRUARY 1ST, 2017

Electric & Mechanical Access Control Hardware



MAGNETIC LOCKS

7	1511/12/13, 1571/72/73, 1581/82 EMLock®
8	EMLock® Top Jamb + Glass Door Mounts
9	EMLock® Modular Upgrade Kits EZ Series
9	Reusable Heavy Duty Drill Fixture
10	Universal Header Bracket
10	Aluminum Spacer Bracket
10	Armature Mounting Plate
10	Door Coordinator Lock Mounting Kit
11	Filler Plates
11	Angle Brackets
12	350 Narrow Line EMLock®
13	E6200, E1200, E600 Excel™ Series
13	Top Jamb Mounting Kit for Excel™ Series
13	Retrofit Kit for Discontinued Locknetics 390+ PLUS
13	Glass Door Armature Mounting Kit for Excel™ Series
13	Mounting Brackets and Filler Plates for Excel™ Series
14	1561/62/65/66 Hi/Shear Concealed EMLock®
15	1562SC / 1563SCHDB / 1561S / 1561TJ Hi/Shear Semi-Concealed & Surface Mount EMLock®
16	1575 / 1576 Gate EMLock®
17	E300 Excel™ Micro Cabinet Lock
17	EP17624 Explosion Proof EMLock®
17	1591 Mortise EMLock® for Sliding Doors

DELAYED EGRESS LOCKS

18	1511S / T ExitCheck® Delayed Egress EMLock®
20	1581S ExitCheck® Mini Delayed Egress EMLock®
21	101 ExitCheck® Wall Mount Delayed Egress
22	Local and Remote Controls and Annunciators

ELECTRIC STRIKES

23	15 Series Electric Strike
23	25 Series Electric Strike
23	30 Series Rim Mount Electric Strikes
24	45 Series Electric Strike
25	45F Fire Rated Electric Strike
26	55 Series UniFLEX™ Electric Strike
27	55 ABC UniFLEX™ Multi Application Pack
27	MS Series Latch and Deadbolt Monitoring Strike Kits

ELECTRIFIED LOCKSETS

28	7200 Series ELECTRA MOD™
29	7200 Series Distributor Supplied Lock
30	Z7200 Series ELECTRA PRO™ Heavy Duty Cylindrical Locksets
31	Z7800 SELECTRIC™ PRO Electric Lockset
32	7800 SELECTRIC™ MOD Series Locksets
33	SK-L90 Field Electrification Kit for Schlage L9000
33	SK-88 Field Electrification Kit for Yale 8805
33	SK-82 Field Electrification Kit for Sargent 8206
34	7500 Series HiTower®

EXIT DEVICES

36	S6000 SPECTRA™ Touch Bar Exit Devices - 6100 RIM and 6200 SURFACE VERTICAL
----	---

37	Device Trim
38	S6000 SPECTRA™ Touch Bar Exit Devices - 6300 MORTISE
40	S6000-101 Exit Check® - Delayed Egress All-In-One Device
42	S6000 DE Exit Device - Delayed Egress
43	S6000 A/B Exit Devices - Alarmed Exit
44	S6303FH HiTower Pro® Electrified Mortise Exit Device
45	S6300 Exit Device - Electrified Mortise
46	S6000 G Exit Device - Electric Dogging
47	S6000 E Exit Device - Electric Latch Retraction/Dogging
49	LR100 QUIET DUO™ 700mA Dual Latch Retraction / Dogging Kit
54	IP100 QUIET DUO™ 12V PoE-Capable Latch Retraction / Dogging Kit

BOLT LOCKS

56	FS23MIV / 1091 / 1291 / 1490 / 2490 SPACESAVER® Mortise Bolt Locks
56	1091 / 1190 / 1291 SPACESAVER® Mortise Bolt Locks FOR WOOD FRAMES
57	1091 / 1290 Mechanical Release SPACESAVER®
57	1190 / 2090 Heavy Duty SPACESAVER®
58	110 / 210 / 160 / 260 Conventional Mortise Bolt Locks
58	180 / 280 Surface Mount Bolt Locks
59	PB2090 Paniclok Exit Device Release
59	GL160 / GL260 Gate Locks
60	295 Programmable Cabinet Lock
60	290 Cabinet Lock

ACCESS CONTROL

61	IP Pro™ Series IP-based Access Control
64	918 / 918W EntryCheck™
65	920 / 920P / 920PW EntryCheck™
65	923 / 923P / 923PW Narrow EntryCheck™
66	921P / 924P 2-PIECE EntryCheck™
66	925 / 925P / 925PW Shroud EntryCheck™
67	E75 EntryCheck™ Standalone Electronic Lockset - SDC Lock
68	E76 EntryCheck™ Standalone Electronic Lockset - SDC Mortise Lock
69	E77 EntryCheck™ Standalone Electronic Lockset - SDC Rim Exit Device

EGRESS CONTROL

70	PSB560 SureExit® Sense Bar
71	MSB550 Mechanical Switch Bar
71	MSB550W Weather Resistant Mechanical Switch Bar
72	500 Series Exit Device Switch Kits

KEY & EXIT SWITCHES

73	410 / 420 / 423 Series Exit Switches
74	430 / 440 / 450 / 463 / 474 Series Exit Switches
75	700 / 800 Series Key Switches
76	MD-31 Series Passive Infrared Egress Control
76	10TD Time Delay Relay

ADA COMPLIANT

- 77Auto EntryControl™
- 78 Dual Switch Bollard Post - CBC compliant
- 78 Bollard Post
- 78 400 Series Wireless Transmitter and Receiver
- 79 480 Series Push Plate Switches
- 82 491 / 492 Emergency Door Release
- 82 CB400 / CB700 Series Communicating Bathroom Controls
- 83CBP- Communicating Bathroom Package

POWER TRANSFER DEVICES

- 84 PTH Power Transfer Hinge
- 85 PTM / PT-5 Power Transfer Devices
- 85PT-2 / PT-3 Power Transfer Loops

POWER SUPPLY & DOOR CONTROLERS

- 86 602 / 631 / 632 / 634 / 636 Power Supplies/
 Controllers & Battery Standby
- 87 621 Access Control Power Supplies
- 87 UME Universal Module Enclosure
- 88UR-1 / UR2-4 / UR4-8 Universal Control Modules
- 88 FB-4 / ACM / CR4 / PB Door Control Modules
- 88 PSM / EMC Output Module
- 89 TR12 / TR24 DC Regulated Power Supplies
- 89TP1220 / TP2440 Transformers
- 90Power Supply Capacity Chart

REMOTE CONTROLS

- 92WRC SeriesWireless Transmitter and Receiver
- 92DTMO Mini Consoles
- 93TCC / RCC Modular Control Consoles
- 93 15 Series Desk Switch Compact Box

ANNUNCIATORS

- 94EA Series Door Prop Alarm
- 94 EA100 Exit Annunciators
- 95 400 Series Sirens and Buzzers
- 95400 Series Wall Mount Indicator
- 95 101 Series Annunciators

ACCESSORIES

- 96EH Series Magnetic Door Hold & Release Device
- 98WRC Series Wireless Transmitter and Receiver
- 98 MD-31 Passive Infrared Egress Control
- 9810TD Time Delay Relay
- 9814-2 Timer
- 99 DPS + MC Series Door Position Sensors
- 99 UME Universal Module Enclosure
- 99 Emergency Access Panel

SYSTEM DESIGN SOLUTIONS

- 100Communicationg Bathroom EMLocks®
- 101 ... Communicationg Bathroom Selectric® or Electra®
- 102 ... Communicationg Bathroom HiTower® or Electric Strike
- 1032-Door Interlock ‘A’
- 1042-Door Mantrap ‘B’
- 105 2-Door Interlock ‘C’
- 106 Elevator Lobby System
- 107 Quick Index



Over 200 Access Hardware products available for next business day shipping.

East & West coast warehouses reduced time-in-transit

- SDC - Camarillo, CA
- SDC - Baltimore, MD



Dealers & Installers:
 Contact SDC to find out first hand which products your SDC distributor can expedite.

Some products in this price book are protected by one or more of the following U.S. Patents. Foreign Patents are not shown: 4,021,065; 4,099,752; 4,596,411; 4,609,910; 4,623,178; 4,623,181; 4,634,155; 4,641,867; 4,826,223; 4,986,581; 5,000,497; 5,006,723; 5,033,779; 5,141,271; 5,376,910; 5,429,399; 5,525,880; 5,564,228; 5,876,073; 6,363,363; 6,363,763; 7,540,542; 7,614,669; 7,698,918

LIMITED WARRANTY

Security Door Controls (SDC) warrants that all new products sold by us are free from defects in material and workmanship and fit for the purpose intended by SDC when properly installed in accordance with the appropriate factory instructions and template for a period, from the date of shipment as follows:

Lifetime: EMLock Series electromagnetic locks and Exit Check Series Delayed Egress Electromagnetic Locks, excluding Exit Check delayed egress PC board assemblies, purchased since January 1, 2006 are warranted for the life of the product. Excel Series Electromagnetic Locks and 600 Series power supplies purchased since January 1, 2012 are warranted for the life of the product.

5 Years: All other SDC products, including Exit Check electronic PC Board Assemblies are warranted for 5 years

The extent of our liability for breach of warranty, when such is shown to our satisfaction, shall be limited to a functionally equivalent replacement, or repair of such product, or part thereof at SDC's sole discretion, when returned, delivery prepaid to SDC. We shall not, except to the extent this limitation may be precluded by law, be liable for inconvenience, labor costs, lost profit, damages to other property, injury or any other consequential or punitive damages resulting directly or indirectly from any product defect or breach of this warranty.

This warranty is limited to the original purchaser, is not transferable and shall not apply to changes of Oil Rubbed Bronze (613/US10B) finish, which is a living finish designed to change appearance through daily use, lamps, LED's, maintenance, wear and tear caused by normal use, altered product, abuse or negligence.

THE FOREGOING WARRANTY IS EXCLUSIVE AND IS IN LIEU OF ALL OTHER WARRANTIES OF FITNESS AND MERCHANTABILITY.

SDC APP



Mobile Resource

For Sales Calls, Onsite Installation, Dealers, Specifiers, & Engineers

20 Product Categories

Access Control Equipment
Electric & Mechanical Locking Devices

Video Library

Video Demos for Sales, Installations, Product & System Application

Document Library

PDF Datasheets, 3-Part Specs, Instructions, Templates & Cad

System Library

Cross Brand Compatible Riser & Point-To-Point System Wiring

Social Links

Latest News thru LinkedIn, Facebook, Twitter & YouTube

Print & Share

Print via WiFi or Bluetooth, Share Media Via Text or Email



BASIC COMPONENT CONSIDERATIONS FOR A SINGLE DOOR SYSTEM

- LOCKING DEVICE**
Electromechanical Bolt Lock
Electromagnetic Lock
Electric Strike
Electric Mortise Lock
Electrical Cylindrical Lock
Delayed Egress Lock
- ACCESS CONTROL**
Card Reader
Digital Keypad
Key Switch
- EXIT SWITCH**
Push Switch
Motion Detector
Request to Exit Push Bar®
- REMOTE CONTROL**
Desk Switch
Control/Monitoring Panel
(lock status sensors required)
- POWER SUPPLY AND DOOR CONTROL MODULE(S)**
A 600 series power supply and time delay modules provide delayed re-locking, interface capability with alarm systems and access control components plus system documentation.

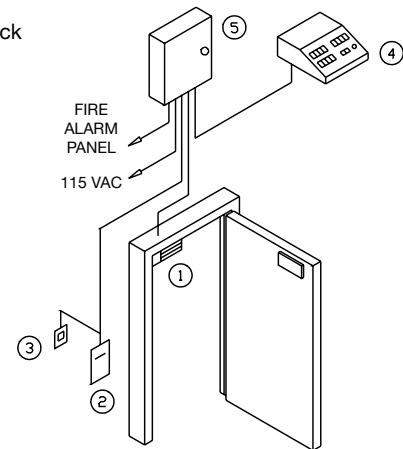

DOOR HANDS

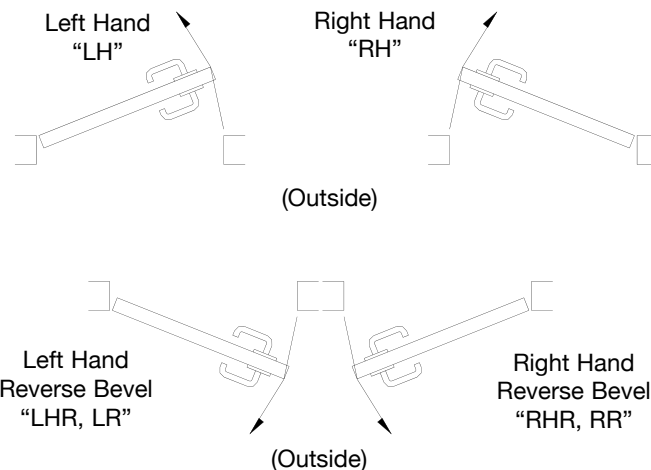

SECURITY DOOR CONTROLS
801 Avenida Acaso • Camarillo, CA 93012
Email: Service@sdcsecurity.com • www.sdcsecurity.com

Price List Effective February 1, 2017

SALES POLICY

TERMS: A minimum purchase of \$3,500.00 annually is required to maintain an open account with Security Door Controls.

RETURNED GOODS: Any defects or errors for which we are responsible will be promptly rectified. Approval for return of merchandise must be requested of us, and when granted the return authorization number must be displayed on all packages returned. Material found suitable for resale without reconditioning will be credited to customer's account less a handling and reprocessing charge of 35% of the net material value. Further charges will be assessed on material requiring rework to return it to saleable condition. Obsolete products will not be accepted for return. Custom products, special finish, options, size or pre-assembly configuration are considered special and are not returnable for credit. Incoming transportation charges are to be prepaid by the Buyer. Credits for material returned will have 2% deducted to cover the cash discount allowance on the original invoice.

ADDITIONAL TERMS: 2% - TEN (10) DAYS. Net thirty (30) days from date of invoice. Interest at 1-1/2% per month will be charged on unpaid balances beyond thirty (30) days. Orders received from 60+ day accounts will not be entered until account is current. It is understood that you may use your normal purchase order or other order forms in placing orders. However any such forms shall be used for convenience only and any terms or provisions which may be contained therein inconsistent with, or in addition to, those contained in our then current Acknowledgment to Customer form or other terms or provisions contained herein shall have no force or effect whatsoever. Custom material or wiring diagrams requires 50% deposit. At SDC's discretion, orders in excess of \$1500 net will be acknowledged by product category and department, and shipped on an "as ready" basis unless customer purchase order specifically states "Do not ship before _____," and "No partial shipments."

PRICES: Prices are subject to change without notice. No prices are guaranteed. All shipments will be made at prices prevailing at time of shipment. Errors or omissions in pricing are subject to correction.

PRICING POLICY: Shipments must be accepted within sixty (60) days after receipt of the order. Contracts extending beyond this period are subject to prices in effect at the time of shipment.

MINIMUM ORDER: Our minimum net invoice charge is \$250.

ACCEPTANCE: We reserve the right to decline an order, in whole or in part, when the price, quantity or assortment of goods is not satisfactory to us.

NOTE: SDC complete sales policy as stated in our price book prevails at all times.

CUSTOM SYSTEM DESIGN

Security, Life-Safety and Access Control. They demand the best, in planning, products and operation. So it's only good sense to work with a complete product package, and to begin with an expertly prepared, custom engineered design package from SDC. Detailed to your needs, one entrance or a complex multi-entrance system.

Every professional in the field knows all too well the usual problems. Wiring specs and wiring diagrams don't match up, components are improperly planned out or missing, projects slow down and costs start escalating.

Security Door Controls is prepared to assist you with a complete System Design Folder which eliminates any problems with component compatibility, system operation or wiring installation.

We provide what your particular job requires in electrical drafts,

CHANGE IN ORDERS: A charge of \$20.00 will be applied to each change on any order after said original order has been previously acknowledged by SDC, plus a cost incurred by manufacturing at point of change.

CANCELLATIONS: A charge of \$40.00 will apply in addition to any cost incurred by us for any cancellation made after our acknowledgment is issued. Custom architectural housings are non-cancelable. Orders for custom architectural housings, custom parts, special and optional plated finishes are non-cancelable.

FREIGHT: All goods are invoiced EXW (EXWorks) SECURITY DOOR CONTROLS. When delivered to the transportation company the shipments become the property of the purchaser, who assumes the risk of loss or damage in transit. All ground shipments will be made by United Parcel Service (UPS).

BACK CHARGES: We are not responsible for, do not authorize, and will not accept any charges for the cost of any labor or material incurred by anyone other than Security Door Controls for any installation, repair, service or replacement unless incurred with our prior written consent and agreement.

PRODUCT CHANGES: SDC reserves the right to modify, change, or discontinue any components as required.

SHORTAGES/ DISCREPANCIES: Claims must be made within ten (10) days after receipt of material. (The original invoice number will be required).

TEMPLATES: It shall be the customer's responsibility to check all templates requested from SDC for suitability for proper door and frame preparation. Direct requests from the door and frame supplier will not release this customer of this responsibility.

ARBITRATION AND GOVERNING LAW: In the event of a dispute or controversy, or differences, which may arise between parties, any claim shall be settled by arbitration. The arbitration shall take place in California under the rules of the American Arbitration Association. The validity, interpretation, and performance of this agreement shall be controlled by and construed under the laws of the state of California, United States of America.

ACCEPTANCE: We reserve the right to decline an order, in whole or in part, when the price, quantity, or assortment of goods is not satisfactory to us.

instructions and data. It offers a great advantage for you, with time saved, a faster, easier, better job in every way.

General instructions. Job name. Supplier. SDC reference number and drawing numbers for easy reference when technical support is needed. System operation: a detailed outline of the complete operation. A full list of components with individual instruction data for each, conduit layout indicating quantity and gauge of wires. Point-to-point wire diagrams of all component connections.

All necessary data is a matter of record. In short, whatever that job requires in equipment, technical understanding or assistance, at the office or in the field, will be detailed in your SDC System Design Folder.

*SDC fees vary according to requirements.

ENGINEERING POLICY

Engineering services are available for special system design and documentation.

All requests must be submitted in writing with all detailed requirements before final quotation. Any alterations or omissions must also be submitted in writing and are subject to additional quotation.

SDC assumes no responsibility for information exchanged by telephone regarding estimates or product suitability for verbally expressed systems. Email requests will speed up the process and eliminate misunderstandings.

A non-cancelable purchase order for engineering is required before any engineering may proceed.



SECURITY DOOR CONTROLS

801 Avenida Acaso • Camarillo, CA 93012

Email: Service@sdcsecurity.com • www.sdcsecurity.com

Price List Effective February 1, 2017

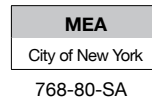
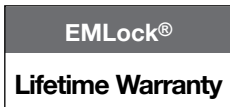

GWXT Auxiliary Locks
CVXJ Burglary Resistant Electrically Operated Door Lock

UL10C Positive Pressure Compliant
UBC Classified in accordance with Uniform Building Code standard 7-2 "Fire Test for Door Assemblies"

1510 Series Grade 1
1650 lb / 748 Kg Holding Force

ELECTRICAL SPECIFICATIONS

Voltage: 12/24VDC Voltage Sensing Input
Single: 350mA @ 24VDC; 670mA @ 12VDC
Double: 700mA @ 24VDC; 1.34A @12VDC

MECHANICAL SPECIFICATIONS

Single: 11" L x 2.75" H x 1.562" D
(279.4 x 69.9 x 39.7 mm)
Double: 22" L x 2.75" H x 1.562" D
(558.8 x 69.9 x 39.7 mm)

1570 Series Grade 1
1200 lb / 544 Kg Holding Force

ELECTRICAL SPECIFICATIONS

3 Watt Power Saver
Voltage: 12/24VDC Voltage Sensing Input
Single: 125mA @ 24VDC; 250mA @ 12VDC
Double: 250mA @ 24VDC; 500mA @ 12VDC

MECHANICAL SPECIFICATIONS

Single: 11" L x 2.75" H x 1.562" D
(279.4 x 69.9 x 39.7 mm)
Double: 22" L x 2.75" H x 1.562" D
(558.8 x 69.9 x 39.7 mm)

1580 Series Grade 1
650 lb / 295 Kg Holding Force

ELECTRICAL SPECIFICATIONS

Voltage: 12/24VDC Voltage Sensing Input
Single: 220mA @ 24VDC; 440mA @ 12VDC
Double: 440mA @ 24VDC; 880mA @ 12VDC

MECHANICAL SPECIFICATIONS

Single: 8.75" L x 2.125" H x 1.25" D
(222.2 x 54 x 31.8 mm)
Double: 17.5" L x 2.125" H x 1.25" D
(444.5 x 54 x 31.8 mm)



1511



1512



1513



1571



1572



1573



1581



1582

EMLOCK® MODELS

Distributor Discount Code **GK** LIST

1650lb / 748 kg Holding Force, Automatic Voltage Sensing Input

1511 Single EmLock®	466.00
1512 Double EmLock®	932.00
1513 Single EmLock®, split armature for pair of doors	523.00

1200lb / 544 kg Holding Force, Automatic Voltage Sensing Input

1571 Single EmLock®	435.00
1572 Double EmLock®	880.00
1573 Single EmLock®, split armature for pair of doors	492.00

650lb / 295 kg Holding Force, Automatic Voltage Sensing Input

1581 Single EmLock®	363.00
1582 Double EmLock®	715.00

SPECIFY FINISH

Add to List

Anodized Finishes (Architectural Housing: Add 20.00 per foot to base)		Single EmLock	Double Emlock
V	628 Aluminum (standard)	N/C	N/C
Y	335 Black	83.00	125.00
Powder Coat Finishes (a coating electrostatically applied to form a hard finish, that is tougher than conventional paint)		Single EmLock	Double Emlock
X	Dark Bronze Powder Coat Painted (313/613 Equal)	83.00	125.00
C	Brass Powder Coat Painted	83.00	125.00
Plated Finishes - Special order, no cancellation, no returns			
P	625 Bright Chrome	197.00	228.00
Q	626 Dull Chrome	197.00	228.00

Architectural Housing add \$30 per foot to above Single Unit Price.



1575U
see page 16



1576
see page 16

Price List Effective February 1, 2017

SDC SECURITY DOOR CONTROLS
801 Avenida Acaso • Camarillo, CA 93012
Email: Service@sdsecurity.com • www.sdsecurity.com



Magnetic Locks

EMLock® Magnetic Locks

SPECIFY OPTIONS

List

See Modular Program price list when ordering separately for field upgrades. Different part numbers and pricing apply.

T	Adjustable timer. Built in field adj. 0-30 sec. relock delay. Specify one for single or double EmLocks® (not available with 1580 series)	67.00
D	Door position sensor. Indicates door open and door closed. Specify two for double EMLocks® (not available with 1513 and 1573) SPDT Dry, 250 mA @ 30VDC.	42.00
B	Magnetic bond sensor. Indicates locked with full holding power and unlocked, low holding power, low voltage, tampering and obstruction between armature and magnetic core. Specify (2) for double EmLocks® (Not available with 1513 and 1573) <ul style="list-style-type: none"> 1510 & 1570 Series: SPDT Dry, 250 mA @ 30VDC. 1580 Series: SPST N.O., Dry, 250 mA @ 30VDC. 	63.00
L	Bi-color status LED indicator. Field selectable Red and Green. (Not installed in lock.) Indicates lock energized when wired to lock input. Indicates de-energized/unlocked or "Enter/Go" when wired to built-in TD Module Indicates energized and de-energized or "Enter/Go" when wired to access control auxiliary output. Indicates door is closed and locked and door is unlocked when wired to Bond Sensor.	17.00
A	Anti-tamper sensor. Indicates access cover removal. SPDT Dry, 1 Amp @ 30VDC	52.00

SPECIFY TOP JAMB MOUNTING KIT

Distributor Discount Code **GK** LIST

Kits for 1200lb and 1650 lb Locks

Kits for 650lb Locks

TJ1	Single	TJ81	Single	125.00
TJ2	Double	TJ82	Double	203.00

Add to List

Anodized Finishes

V 628 Aluminum (std)	N/C	Y Black Anodized	83.00	166.00
-----------------------------	------------	-------------------------	--------------	---------------

Powder Coat Finishes (a coating electrostatically applied to form a hard finish, that is tougher than conventional paint)

X Dark Bronze Powder Coat Painted	C Brass Powder Coat Painted	83.00	166.00
--	------------------------------------	--------------	---------------

Plated Finishes - Special order, no cancellation, no returns

P 625 Bright Chrome	Q 626 Dull Chrome	197.00	228.00
----------------------------	--------------------------	---------------	---------------

Add to List

SPECIFY GLASS DOOR MOUNTING KIT

Distributor Discount Code **GK** List

- Universal glass door kits are compatible with lock models, except 1513 and 1573
- Field adjustable for 1/2", 5/8" and 3/4" all glass Herculite doors

Kits for 1511, 1571, 1581

Kits for 1512, 1572, 1582

HDB1	Single	187.00	HDB2	Double, 2 single kits	373.00
-------------	--------	---------------	-------------	-----------------------	---------------

Add to List

Anodized Finishes

V 628 Aluminum (std)	N/C	Y Black Anodized	83.00	166.00
-----------------------------	------------	-------------------------	--------------	---------------

Powder Coat Finishes (a coating electrostatically applied to form a hard finish, that is tougher than conventional paint)

X Dark Bronze Powder Coat Painted	C Brass Powder Coat Painted	83.00	166.00
--	------------------------------------	--------------	---------------

Plated Finishes - Special order, no cancellation, no returns

P 625 Bright Chrome	Q 626 Dull Chrome	104.00	207.00
----------------------------	--------------------------	---------------	---------------

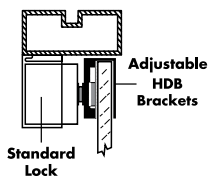
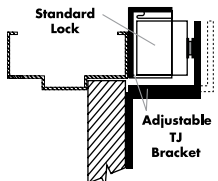

Field Upgrade without Removing from the Frame

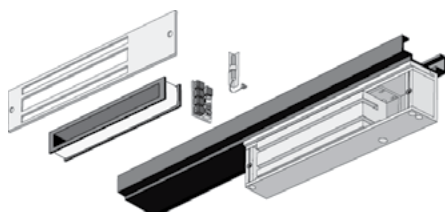

Field Install

- Monitoring outputs
- Timers
- Top jamb "Z" kit
- Glass door kits

Interlocking Quick Mount Assembly

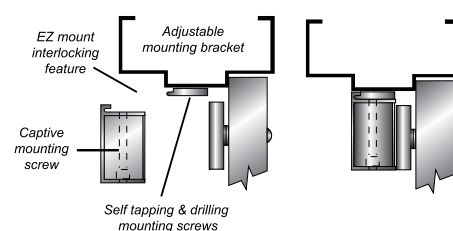

EMLock® Magnetic Locks

SPECIFY ARCHITECTURAL HOUSINGS

GK Add to List

Full Width Housings - Appear as part of the frame to provide a superior architectural appearance.

Vertical Housings - Side jamb mount, provides 2,400 or 3,300 lbs. of holding force.

Compatible with Models: 1511, 1512, 1571, 1572 with or without HDB kits.

Specify housings with your EMLocks®.

Single Door Housing

30	30" Lock housing	414.00
36	36" Lock housing	414.00
40	40" Lock housing	414.00
48	48" Lock housing	414.00
CH	Custom length. Specify exact length	POA

Double Door Housing

60	60" Lock housing	673.00
72	72" Lock housing	673.00
84	84" Lock housing	673.00
96	96" Lock housing	673.00
CH	Custom length. Specify exact length	POA

Vertical Housing EMLock

Distributor Discount Code **GK LIST**

1572VV82	Vertical Housing for 1572 EMLock, 82" length, for 84" opening - INCLUDES 1582 lock	1552.00
1512VV82	Vertical Housing for 1512 EMLock, 82" length, for 84" opening - INCLUDES 1512 lock	1605.00
CV	Custom length. Specify exact length	POA

See page 7 for special finish designation and finish price

Retrofit Kit for Discontinued Locknetics 390+ PLUS

Distributor Discount Code **GK LIST**

Enables replacement of Locknetics 390+ PLUS with SDC's 1511 and 1571 (ordered separately)

1511-390AMP	Retrofit Kit includes lock mounting plate with self-tapping & drilling screws and Armature assembly, utilizes existing 390+ thru-bolt hole.	52.00
--------------------	---	--------------

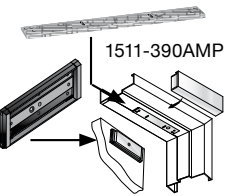

Field Installed Modular Upgrade Kits

Ordered separately for field upgrade without removing the lock from the frame

For complete details contact SDC to request the Modular Upgrade Kit datasheet or download from the SDC website: www.sdcsecurity.com/docLibrary.aspx All available through shipQuick Inventory

EZ-T-10 Adjustable Timer Input Module:	67.00	EZ-A Anti-Tamper Switch Module:	52.00
Specify (1) for single or double EmLocks® (not available with 1580 series)		Indicates cover plate removal.	
EZ-D-10 1510, 1570 Door Position Sensor Module:	42.00	EZ-1510W Holding Force Module:	52.00
Specify (2) for double EmLocks® (not available with 1513 and 1573)		Replace a 1200lb wire core (1570 series) with this 1650lb wire core. Specify (2) for double EmLocks®	
EZ-D-80 1580 Door Position Sensor Module:	42.00	EZ-1570W Energy Saver Module:	52.00
Specify (2) for double EmLocks®		Save on power supply and long term energy costs by replacing 8.4 Watt, 1650lb coil with 3 Watt, 1200lb holding force coil. Specify (2) for double EmLocks®	
EZ-B-10 1510, 1570 Magnetic Bond Sensor Module:	63.00	EZ-B-80 1580 Magnetic Bond Sensor Module (SPST):	63.00
Specify (2) for double EmLocks® (Not available with 1513,1573)		Specify (2) for double EmLocks®	

Reusable Heavy Duty Drill Fixture

Distributor Discount Code **G LIST**

1511-DF	Heavy duty drill fixture for 1571 and 1511	156.00
1581-DF	Heavy duty drill fixture for 1580	156.00
BN-PT	Blind Nut Placement Tool	125.00
BN-50	Blind Nuts, 10/32, 50 Pack	52.00



Price List Effective February 1, 2017

SECURITY DOOR CONTROLS
801 Avenida Acaso • Camarillo, CA 93012
Email: Service@sdsecurity.com • www.sdcsecurity.com



Magnetic Locks

Universal Header Bracket

Distributor Discount Code **GK LIST**

Used in lieu of angle brackets, the Universal Header Bracket provides a faster mounting solution, saving time and labor costs for several EmLock® models. Reduce potential for mis-sized and misaligned mounting holes, broken taps, removal of broken taps. Combined with interlocking E-Z mount assembly, save up to a half day's labor with the installation of 12 locks.

FEATURES

- Solid 1" bar provides higher security and superior aesthetics.
- Multiple pre-drilled and tapped mounting holes to accommodate the use of several different locks on either 4" or 4.5" aluminum frames
- Machined wire chase provides concealed and secure wiring

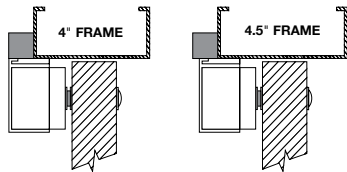

UB11V	Bracket for 1511, 1513, 1571. 1" x 1" x 11"	67.00
UB12V	Bracket for 1512, 1572. 1" x 1" x 22"	133.00

See special finishes 7



Aluminum Spacer Bracket & Concrete Filled Frame Plate - Pre-Drilled & Tapped **GK LIST**

APPLICATION

- Aluminum frames with blade stop - lowers EmLock® below blade stop
- Concrete filled hollow metal frames - provides multiple points for concealed wire entry

FEATURES

- Pre-drilled and tapped specifically for 1510, 1570, 1580 EmLock
- Machined wire chase provides multiple points for concealed wire entry from concrete filled frames.

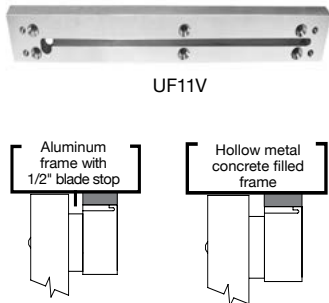

UF11V	Bracket for 1511, 1513, 1571, 1573. 1/2" x 1-1/2" x 11"	94.00
UF12V	Bracket for 1512 and 1572. 1/2" x 1-1/2" x 22"	116.00
UF81V	Bracket for 1581. 1/2" x 1-1/4" x 8-3/4"	75.00
UF82V	Bracket for 1582. 1/2" x 1-1/4" x 17-1/2"	104.00

Armature Mounting Plate

Distributor Discount Code **GK LIST**

The AR Mounting plate provides a solution for mounting the EmLock® armature to the top rail of aluminum, glass, wood and hollow metal doors that do not permit the use of thru bolts. **Dimension:** 8 1/2" x 3"

MODEL

AR11Y	Armature mounting plate (Black) Specify two for models 1512, 1572	63.00
AR11YD	Armature mounting plate (black) with door sensor Specify two for models 1512, 1572	104.00



AR11Y

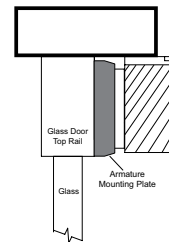
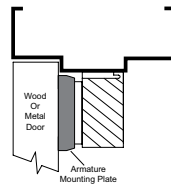
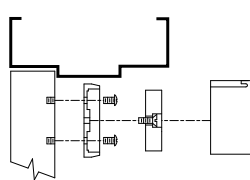

Door Coordinator Lock Mounting Kit

Distributor Discount Code **GK LIST**

DC-1	Door coordinator mounting bracket for single models 1511 and 1571.	125.00
DC-2	Door coordinator mounting bracket for double models 1512 and 1572.	228.00



DC-1



DC-2

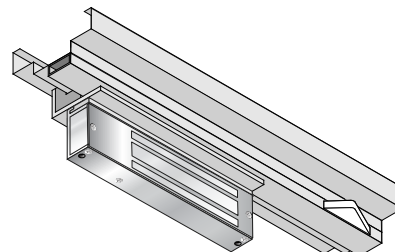
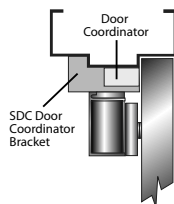

Filler Plates

Distributor Discount Code **GK**

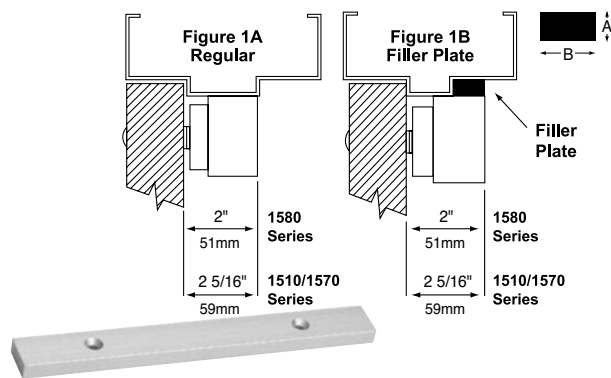

FILLER PLATES: For extension of the stop to provide a proper mounting surface on the underside of the header. See Figure 1B.

FOR 8-3/4" (222mm) SINGLE EMLOCK MODELS

1581, 101V81S, 101V81T

PART #	A x B	LIST
FP01	1/8" x 1-1/4" (3 x 32mm)	32.00
FP02	1/4" x 1-1/4" (6 x 32mm)	34.00
FP03	3/8" x 1-1/4" (10 x 32mm)	36.00
FP04	1/2" x 1-1/4" (13 x 32mm)	38.00
FP05	5/8" x 1-1/4" (16 x 32mm)	38.00

FOR 11" (279mm) SINGLE EMLOCK MODELS

1511 1571 1511S 101V71S
1513 1573 1511T 101V71T

PART #	A x B	LIST
FP11	1/8" x 1-1/4" (3 x 32mm)	35.00
FP12	1/4" x 1-1/4" (6 x 32mm)	36.00
FP13	3/8" x 1-1/4" (10 x 32mm)	36.00
FP14	1/2" x 1-1/4" (13 x 32mm)	40.00
FP15	5/8" x 1-1/4" (16 x 32mm)	42.00

FOR 17-1/2" (445mm) DOUBLE EMLOCK MODEL

1582

PART #	A x B	LIST
FP30	1/8" x 1-1/4" (3 x 32mm)	40.00
FP31	1/4" x 1-1/4" (6 x 32mm)	42.00
FP32	3/8" x 1-1/4" (10 x 32mm)	44.00
FP33	1/2" x 1-1/4" (13 x 32mm)	46.00
FP34	5/8" x 1-1/4" (16 x 32mm)	48.00

FOR 22" (559mm) DOUBLE EMLOCK MODELS

1512 1572

PART #	A x B	LIST
FP21	1/8" x 1-1/4" (3 x 32mm)	40.00
FP22	1/4" x 1-1/4" (6 x 32mm)	42.00
FP23	3/8" x 1-1/4" (10 x 32mm)	44.00
FP24	1/2" x 1-1/4" (13 x 32mm)	46.00
FP25	5/8" x 1-1/4" (16 x 32mm)	48.00

Angle Brackets

Distributor Discount Code **GK**

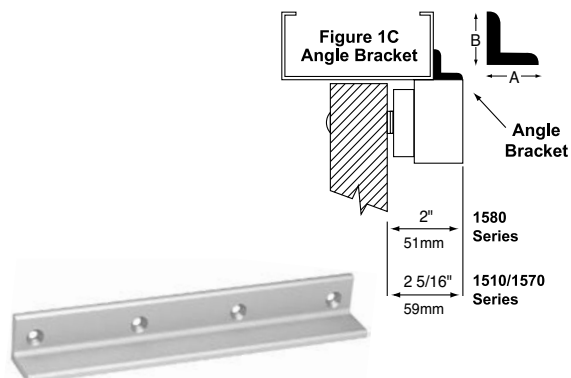

ANGLE BRACKETS: Used as extension on shallow door frames to provide adequate mounting surface. See Figure 1C.

FOR 8-3/4" (222mm) SINGLE EMLOCK MODELS

1581, 101V81S, 101V81T

PART #	A x B	LIST
AB01	1" x 1" (25 x 25mm)	40.00
AB02	1" x 1-1/2" (25 x 38mm)	42.00
AB03	1-1/2" x 1-1/2" (38 x 38mm)	44.00
AB04	2" x 1-1/2" (51 x 38mm)	46.00

FOR 11" (279mm) SINGLE EMLOCK MODELS

1511 1571 1511S 101V71S
1513 1573 1511T 101V71T

PART #	A x B	LIST
AB11	1" x 1" (25 x 25mm)	42.00
AB12	1" x 1-1/2" (25 x 38mm)	44.00
AB13	1-1/2" x 1-1/2" (38 x 38mm)	46.00
AB14	2" x 1-1/2" (51 x 38mm)	48.00

FOR 17-1/2" (445mm) DOUBLE EMLOCK MODEL

1582

PART #	A x B	LIST
AB30	1" x 1" (25 x 25mm)	52.00
AB31	1" x 1-1/2" (25 x 38mm)	56.00
AB32	1-1/2" x 1-1/2" (38 x 38mm)	61.00
AB33	2" x 1-1/2" (51 x 38mm)	65.00

FOR 22" (559mm) DOUBLE EMLOCK MODELS

1512 1572

PART #	A x B	LIST
AB21	1" x 1" (25 x 25mm)	52.00
AB22	1" x 1-1/2" (25 x 38mm)	56.00
AB23	1-1/2" x 1-1/2" (38 x 38mm)	61.00
AB24	2" x 1-1/2" (51 x 38mm)	65.00

SPECIFY FINISH

Add to List

	Single EmLock	Double EmLock
V 628 Aluminum (standard)	N/C	N/C
Y 335 Black Anodized	32.00	63.00
Powder Coat Finishes (a coating electrostatically applied to form a hard finish, that is tougher than conventional paint)		
X Dark Bronze Powder Coat Painted	32.00	63.00
C Brass Powder Coat Painted	32.00	63.00
Plated Finishes - Special order, no cancellation, no returns		
P 625 Bright Chrome	32.00	63.00
Q 626 Dull Chrome	32.00	63.00

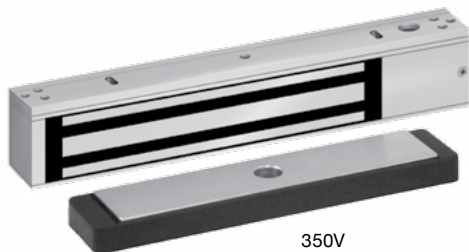

350V

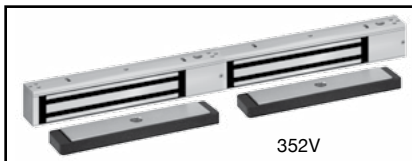

352V

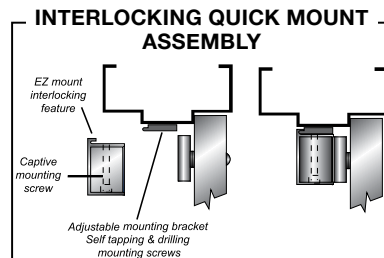

350 SINGLE SPECIFICATIONS

Holding Power	1200 Lbs.
Input Voltage	Dual 12/24 VDC
Current	309mA @ 24VDC / 560mA @ 12VDC
Magnetic Bond Sensor	1-SPDT output 250mA max. @ 12/24VDC
Door Status Sensor	1-SPDT output 250mA max. @ 12/24VDC
LED Indicator	Green-Secure, Red-Unlocked
Dimensions	12-1/2"L x 2-1/8H x 1-11/16W (318 x 54 x 43mm)

352 DOUBLE SPECIFICATIONS

Holding Power	1200 Lbs. per door leaf
Input Voltage	Dual 12/24 VDC
Current	618mA @ 24VDC / 1120mA @ 12VDC
2 Magnetic Bond Sensors	2 SPDT outputs 250mA max. @ 12/24VDC
2 Door Status Sensors	2 SPDT outputs 250mA max. @ 12/24VDC
2 LED Indicators	Green-Secure, Red-Unlocked
Dimensions	25"L x 2-1/8H x 1-11/16W (635 x 54 x 43mm)

Magnetic Locks

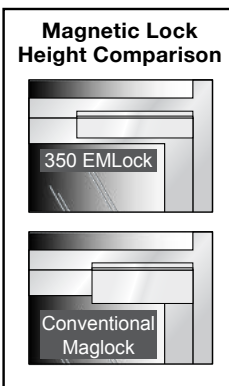

MODEL	DESCRIPTION	LIST
350V	Single Narrow Line Magnetic Lock, 628 Aluminum, specify 2 for pair of doors with mullion, Retrofits Locknetics MagForce 350+ & 350+/DSM/MBS/L1	389.00
352V	Double Narrow Line Magnetic Lock, 628 Aluminum, for pair of doors without mullion, Retrofits Locknetics MagForce 352+ & 352+/DSM/MBS/L2	777.00

Top Jamb Mounting Kit

Distributor Discount Code **GK LIST**

TJ350	Single	135.00
TJ352	Double	239.00

Glass Door Mounting Kit

Distributor Discount Code **GK LIST**

- Field adjustable for 1/2", 5/8" and 3/4" all glass Herculite doors

HDB350 Single	180.00	HDB352 Double, 2 single kits	373.00
----------------------	---------------	-------------------------------------	---------------



SECURITY DOOR CONTROLS
 801 Avenida Acaso • Camarillo, CA 93012
 Email: Service@sdccsecurity.com • www.sdccsecurity.com

Price List Effective February 1, 2017

Excel™ Series Value Engineered Magnetic Locks

The Excel™ product line is designed for system integrators, distributors, installers and building owners presently using low cost import or private label brand access control hardware.



E6200



E1200



E600



E300
see page 17



E1200-390MP

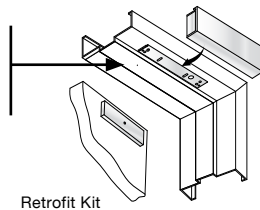

Retrofit Kit

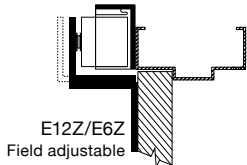

E12Z/E6Z
Field adjustable

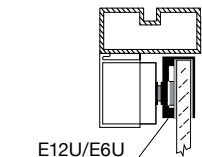

E12U/E6U
Field adjustable
to glass thickness



E6A



E12L

Excel™ Industrial Series

Distributor Discount Code **GK LIST**

- Retrofits popular competitive brands
- Magnetic Bond Sensor and door status standard
- Epoxy sealed electronics, tamper resistant and weatherized for indoor and outdoor use (retrofits M62)
- Stainless steel machine screws and blind nuts
- 10 ft [3.05m] jacketed, stranded conductor cable
- Dual voltage 250/150 mA @ 12/24VDC
- Architectural stainless steel housing, US32D/630

MODEL

E6200 1200 lb / 545 kg with SPDT door status, SPDT magnetic bond sensor **440.00**

Top Jamb Mounting Kit

Distributor Discount Code **GK LIST**

TJ62 Top jamb kit for E6200 **125.00**

Excel™ Architectural Series

Distributor Discount Code **GK LIST**



- Door status, lock status and Bi-color LED
- Interlocking quick mount assembly
- Self drilling and tapping mounting screws and machine screws
- Adjustable mounting bracket
- Wire access chamber with terminal block
- Dual voltage 12/24VDC
- 628 Clear anodized aluminum

MODELS

E1200 1200 lb / 545 kg with door status, locked status and LED **275.00**

E600 600 lb / 272 kg with door status, locked status and LED **228.00**

E300 300 lb / 136 kg with locked status **176.00**

Retrofit Kit for Discontinued Locknetics 390+ PLUS

Distributor Discount Code **GK LIST**

Enables replacement of Locknetics 390+ PLUS with SDC's E1200 (ordered separately)

E1200-390MP Retrofit Kit *Includes lock mounting plate that retrofits existing 390+ mounting holes. Existing 390+ armature may be used.* **37.00**

Top Jamb Mounting Kit for Inswing Doors

Distributor Discount Code **GK LIST**

E12Z Top jamb kit for E1200 **88.00**

E6Z Top jamb kit for E600 **88.00**

Glass Door Armature Mounting Kit

Distributor Discount Code **GK LIST**

E12U Glass door kit for E1200 **125.00**

E6U Glass door kit for E600 **125.00**

Mounting Brackets and Filler Plates

Distributor Discount Code **GK LIST**

Used for the extension of a narrow frame header mounting surface, the bracket provides additional surface area for proper lock mounting

E6A E600 adjustable angle bracket. 9-7/8" L x 1-1/4" H x 2-1/4" D (250 x 32 x 57mm) **26.00**

E12L E1200 angle bracket. 10-1/2" L x 1-1/2" H x 1" D (266 x 38 x 19mm) **26.00**

Field cut for E600

Used where the frame stop does not provide enough mounting surface, the filler bar provides enough additional surface area for proper lock mounting.

E12F01 E1200 stop filler plates. 5/8" H x 3/4" D x 10-1/2" L (16 x 19 x 266mm) **21.00**

Field cut for E600.

E12F02 E1200 stop filler plates. 3/4" H x 3/4" D x 10-1/2" L (19 x 19 x 266mm) **21.00**

Field cut for E600.



E12F01
E12F02

Glass Door Armature Mounting Kit

Distributor Discount Code **GK LIST**

E1200-DF Heavy Duty Drill Fixture for E1200 **156.00**

Price List Effective February 1, 2017

SECURITY DOOR CONTROLS
801 Avenida Acaso • Camarillo, CA 93012
Email: Service@sdsecurity.com • www.sdsecurity.com



Magnetic Locks

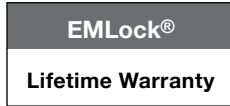

ANSI/BHMA A156.23
Grade 1



3774-0324:100

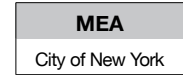

768-80-SA

Price List Effective February 1, 2017

SDC SECURITY DOOR CONTROLS
801 Avenida Acaso • Camarillo, CA 93012
Email: Service@sdsecurity.com • www.sdsecurity.com



1562SC



1562SCHDB



1561S



1561TJ

SEMI-CONCEALED HI/SHEAR EMLOCKS LIST

2,000 Lbs. Holding Force, 8" x 1-1/2" x 1-1/4" Lock

1562SC	1-1/4" depth, with external electronics, for 1-1/4" to 1-3/4" For Hollow metal frames	932.00
1562SCHDB1/2	1-1/4" depth, with external electronics, for 1-1/4" to 1-3/4" frames For 1/2" Herculite full glass doors	1,155.00
1562SCHDB3/4	1-1/4" depth, with external electronics, for 1-1/4" to 1-3/4" frames For 3/4" Herculite full glass doors.	1,115.00

SURFACE MOUNT HI/SHEAR EMLOCKS LIST

2,000 Lbs. Holding Force, 8" x 1-3/4" x 1-3/4" Lock For Hollow metal frames and wood or hollow metal doors

1561S	Surface mount for the push side of the door with integrated electronics	1098.00
1561TJ	Surface top jamb mount for the pull side of the door with integrated electronics	1098.00

STANDARD FINISH Add to List

V 628 Anodized Aluminum	N/C
Y Black Anodized	63.00

Powder Coat Finishes (a coating electrostatically applied to form a hard finish, that is tougher than conventional paint)

X Dark Bronze Powder Coat Painted	83.00
C Brass Powder Coat Painted	63.00

Plated Finishes - Special order, no cancellation, no returns

P 625 Bright Chrome	Q 626 Dull Chrome	197.00
----------------------------	--------------------------	---------------

OPTIONS Add to List

BA	Bond sensor indicates proper armature contact and reduced holding power due to improper armature contact or tampering. SPDT 0.25 Amp maximum)	114.00
DPS	Door position switch indicates door open or closed. SPDT 0.25 Amp maximum.	52.00
L3	External LED status indicator, mounts separately through the frame and may be used to indicate lock is energized or wired to BAS bond sensor for door status.	17.00

Magnetic Locks

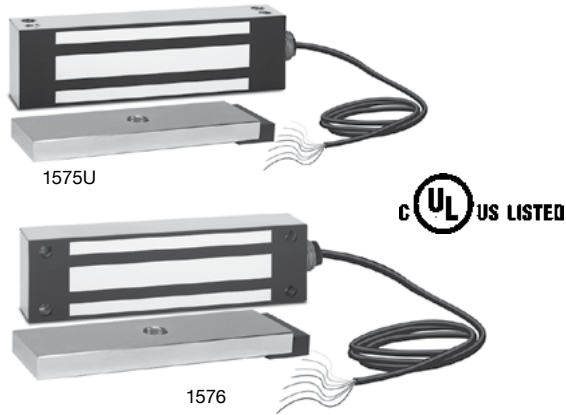

SPECIFICATIONS

Holding Power	1200 Lbs.
Dual Voltage	450 / 225 mA @ 12/24VDC
Sensor	Magnetic Bond Sensor and Door Position Sensor Standard
Cable	3 Ft. cable
Finish	Brushed stainless steel housing
Conduit Fitting	1/2" x 3/4"
Dimensions	8-11/16" L x 2-1/2" H x 1-5/8" D

MODEL	DESCRIPTION	
1575U	Single EMLock® with magnetic bond and door status sensors	451.00
1576U	Single EMLock® face drilled mounting with magnetic bond and door status sensors	451.00



1575-BK



1576-AB



1576-BK



1576-MP



1576-ZB

ACCESSORIES

Add to List

MODEL	DESCRIPTION	
For sliding gate applications		
1576-BK	Mounting Bracket for 1576	83.00
1576-AB	Armature Mounting Bracket for 1576	83.00
For swinging gate or top jamb door application		
1575-BK	Mounting Bracket for 1575	104.00
1576-MP	Lock Mounting Plate for 1576	57.00
1576-ZB	Lock Mounting Bracket for 1576 (Includes 1576-MP)	166.00

1575U FOR SWINGING GATES

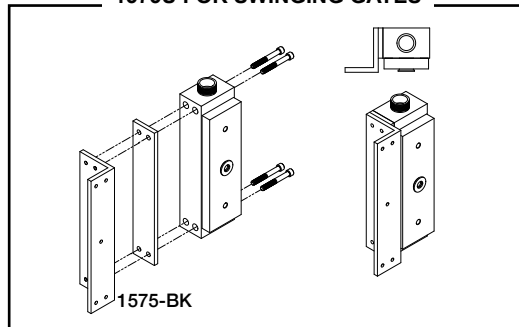

1575U FOR OUTSWING DOORS

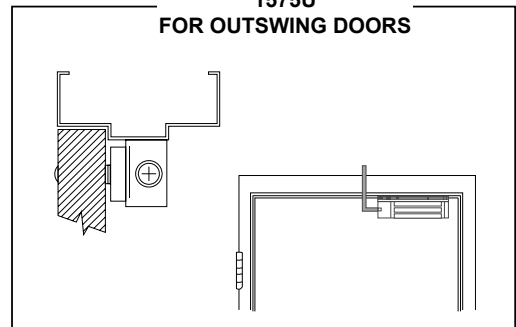

1576U FOR SWINGING GATES

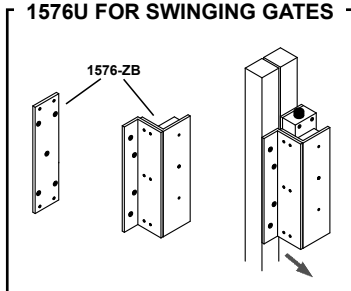

1576U FOR SLIDING GATES

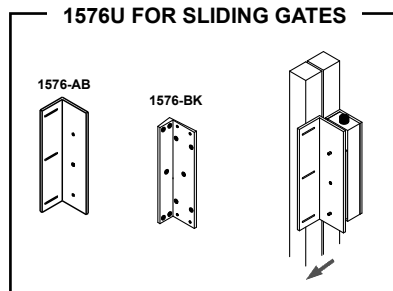

1576U TOP JAMB MOUNT FOR INSWING DOORS

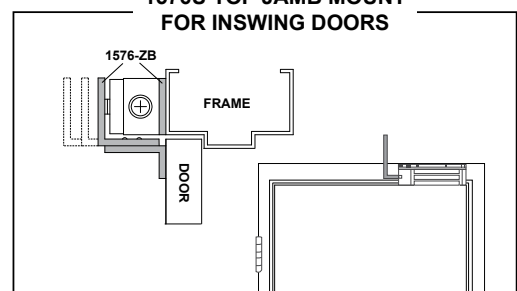

Excel™ E300 Architectural Series Micro Cabinet Lock

Distributor Discount Code **GK LIST**

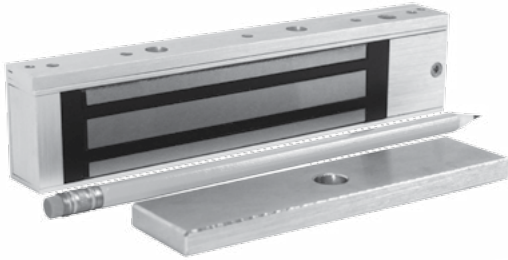

- Lock status
- Interlocking quick mount assembly
- Self drilling and tapping mounting screws and machine screws
- Adjustable mounting bracket
- Wire access chamber with terminal block
- Dual voltage 12/24VDC
- 628 Clear anodized aluminum

MODEL

E300 300 lb / 136 kg with door status, locked status and LED

176.00

EP17624 Explosion Proof EMLock®

Distributor Discount Code **GK**



EP17624

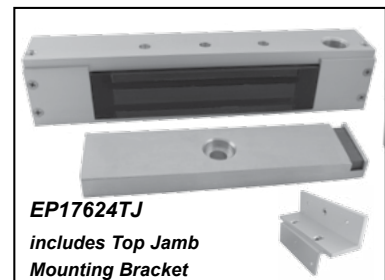

EP17624TJ

includes Top Jamb Mounting Bracket

SPECIFICATIONS

Holding Force 600 lbs
Input Voltage 24 VDC
Current 250mA @ 24VDC

DIMENSIONS

EP17624 lock 10.5"L x 2"H x 1.75"D
EP17624TJ lock 10.5"L x 2.25"H x 1.75"D
Armature 7.125"L x 1.75"H x 0.75"D
Door Status Sensor SPDT contact, 100mA max. @ 30VDC max

MODEL	DESCRIPTION	LIST
EP17624	Single Explosion Proof Magnetic Lock, side conduit location, 628 Aluminum, for use on push-side of door, conduit on side block	2484.00
EP17624TJ	Single Explosion Proof Magnetic Lock, top conduit location, 628 Aluminum, includes Top Jamb mounting bracket, for use on pull-side of door, conduit on top	2588.00

This unit is intended to be used in the following atmospheres: Acetone, Ammonium Hydroxide, ATSM fuel C, Benzene, Methyl-Ethylketone, Diethyl-Ether, 2-Nitropropane, Ethyl-Acetate, Furfural, Normal Hexane, Methyl Alcohol. Operating temperature for the magnetic lock will not exceed 185° F (85° C). Maximum ambient temperature is not to exceed 104° F (40° C). For supply connections, use a suitable wire with a minimum insulation temperature rating of 167° F (75° C). This unit must be connected to a NEC (National Electric Code, NFPA 70) Class 2 Supply Circuit rated for 24 VDC with a minimum current output of 0.5 amperes and output power of 12 watts. A UL Listed SDC 600 Series Power Controller is recommended.

1591 MORTISE EMLock® for Sliding Doors



Distributor Discount Code **GK LIST**



1591

Holding Power 850lbs.
Selectable Voltage: 12VDC @ 700 mA, 24VDC @ 350 mA
Finish: U 630 Stainless Steel
Dimensions: 10"L x 1-7/16"H x 1-1/4"D

MODEL

1591U Single EMLock® for sliding doors **363.00**

ACCESSORIES

Add to List

LAB Surface mount armature angle bracket for 1591 on sliding doors **57.00**

AMP Armature mounting plate for leading edge of door **47.00**

DPS Door position sensor for 1591 EMLock® **57.00**

BR64XL Rectifier for less leads **26.00**

1511S / T

VOICE & DIGITAL Annunciation

The ExitCheck® 1511S series incorporates an **alternating 85 db tone and voice message** with a **digital countdown display** and sign that provides clear and comprehensive instructions for persons without prior knowledge of door operation. This is especially significant for those who are **blind or hearing impaired**.

FIELD SELECTABLE ACTUATION

- Door Movement
- Exit Sense Bar
- Exit Device Switch Kit (See page XX)
- Latch Monitoring Strike (See page XX)

1,650 lbs. Holding Force Standard

830/450 mA @ 12/24VDC (single)

1,200 lbs. Energy Saver Option E

380/225 mA @ 12/24VDC (single)
Control more locks with fewer power supplies
Save on electricity consumption and power supply investment.

1511S

SINGLE MODEL

For use with single doors equipped with Exit Sense Bars, surface vertical rod, concealed vertical rod, mortise and rim mount exit devices, mortise locksets and cylindrical locksets.

ELECTRICAL SPECIFICATIONS

- Voltage:** Auto Voltage Sensing 12/24VDC ± 10%
- Standard 1,650 lbs holding force:** 820/450 mA @ 12/24VDC
- Energy Saver E Option 1,200 lbs. Holding Force:** 400/275 mA @ 12/24VDC

MECHANICAL SPECIFICATIONS

- Single:** 11" L x 2 3/4" H x 2 5/8" D (279 L x 70 H x 67 D mm)
- Armature:** 7 3/8" L x 2 3/8" H x 9/16" D (187 L x 60 H x 14 D mm)
- Sign:** 13" L x 4 1/2" H (330 L x 114 H mm)

1511T

TANDEM MODEL

For use with pairs of doors equipped with Exit Sense Bars, surface mounted vertical rod exit devices and concealed vertical rod exit devices with surface mounted triggers and strikes.

Activating either door unlocks both doors.

ELECTRICAL SPECIFICATIONS

- Voltage:** Auto Voltage Sensing 12/24VDC ± 10%
- Standard 1,650 lbs holding force:** 1500/850 mA @ 12/24VDC
- Energy Saver E Option 1,200 lbs. Holding Force:** 650/400 mA @ 12/24VDC

MECHANICAL SPECIFICATIONS

- Tandem:** Master: 11" L x 2 3/4" H x 2 5/8" D (279 L x 70 H x 67 D)
Slave: 11" L x 2 3/4" H x 2 5/8" D (279 L x 70 H x 67 D mm)
- Armature:** 7 3/8" L x 2 3/8" H x 9/16" D (187 L x 60 H x 14 D mm)
- Sign:** 13" L x 4 1/2" H (330 L x 114 H mm)

CONTROL INPUTS

- Request to Exit:** Normally open, dry
- Fire Alarm Release:** Alarm panel closed dry contact. Opening of contact releases lock.

MONITORING OUTPUTS

- Alarm Output:** SPDT Dry, 1 Amp @ 30VDC
- Lock Secure / Unlocked Output:** SPDT Dry, 1 Amp @ 30VDC
- DPS Door Position Status:** (option) SPDT Dry, 250 mA @ 30VDC
- BAS Magnetic Bond Status:** (option) SPDT Dry, 250 mA @ 30VDC
- ATS Anti-Tamper Sensor:** (option) SPDT Dry, 1 Amp @ 30VDC



1511S



- Voice & Digital Display Standard
- Energy Saver Optional



1511T

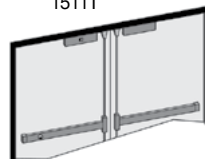

DELAYED EGRESS OPERATION

NA	NFPA 101, IBC and IFC Compliant Field selectable: 15 or 30 second exit delay; 1 or 2 second nuisance delay Field selectable automatic or manual power-up after emergency release	N/C
NC	IBC, IFC, NFPA 101, NFPA 1-UFC, UBC,SBC Compliant Fixed 15 exit delay, 0/1 second nuisance delay Calif. Building Code OSHPD/Manual Power Up	N/C
ND	IBC, IFC, NFPA 101, NFPA 1-UFC, UBC,SBC Compliant Fixed 15 exit delay, 0/1 second nuisance delay	N/C
NH	IBC, IFC, NFPA 101, NFPA 1-UFC, UBC,SBC Compliant Fixed 30 exit delay, 0/1 second nuisance delay	N/C
BC	BOCA National Building Code and Chicago Building Compliant 15 second fixed exit delay, 0 second nuisance delay, auto reset 30 seconds after door closure	N/C
BD	BOCA National Building Code 15 second fixed exit delay, 0/1 second nuisance delay, auto reset 30 seconds after door closure	N/C
BH	BOCA National Building Code 30 second fixed exit delay, 0/1 second nuisance delay, auto reset 30 seconds after door closure	N/C





FWAX Special Locking Arrangements
GWXT Auxiliary Locks



UL10C Positive Pressure Compliant
UBC Classified in accordance with
Uniform Building Code standard 7-2
"Fire Test for Door Assemblies"



ANSI/BHMA A156.24
Grade 1



3774-0324:103



1511S

- Voice & Digital Display Standard
- Field Selectable Voice with Tone or Tone only
- Energy Saver Optional



702R



101-1A



101-4AM



920

Controls & Annunciators
See page 22



101-SP



101-SPSN



EA100

SPECIFY MODEL

LIST

1511S	Single - 1,650 lbs., voice, tone and digital countdown annunciator.	1,211.00
1511T	Tandem - 1,650 lbs., voice, tone and digital countdown annunciator.	2029.00

SPECIFY OPERATION

Specify NA, NC, ND, BC, BD - see codes and description on page 18
If no Code is specified - NA is the SDC STANDARD OPERATIONS MODE for this product

SPECIFY BUILT-IN RESET & CONTROL

K	Built in key switch. Provides 1-30 second timed bypass, sustained bypass and alarm reset (std)	N/C
P	Built in reset push switch. Available with NFPA (NC or ND) only.	N/C
L	Less key or push switch (<i>no price deduction</i>)	N/C

SPECIFY FINISH

Add to List

Anodized Finishes		Single	Tandem
V	628 Aluminum (<i>standard</i>)	N/C	N/C
Y	335 Black Anodized	83.00	125.00

Powder Coat Finishes (<i>a coating electrostatically applied to form a hard finish, that is tougher than conventional paint</i>)		Single	Tandem
X	Dark Bronze Powder Coat Painted	83.00	125.00
C	Brass Powder Coat Painted	83.00	125.00

Plated Finishes - Special order, no cancellation, no returns

P	625 Bright Chrome	197.00
Q	626 Dull Chrome	228.00

OPTIONS

Add to List

E	Energy Saver, 1200 lbs holding force, low power consumption, electrical specs page XX	N/C
D	Door position status. Provides remote monitoring of the door open or closed status and indicates the door has actually been opened for egress after alarm activation. Specify 2 for tandem	42.00
B	Magnetic bond alert sensor. Indicates locked or unlocked, reduced holding power, tampering or foreign material between the electromagnet and armature. Specify 2 for tandem	63.00
A	Anti-tamper switch. Detects attempt to remove the access cover. Specify 2 for tandem	52.00

ADD-ONS

Add to List

VI	Spanish, or English and Spanish, or English and French verbal announcement	104.00
VIC	Custom verbal announcement (10 piece purchase minimum)	POA
RRX	Reset on REX - <i>No Charge when ordered WITH a Delayed Egress lock</i> Allows the REX input to reset after an unauthorized egress alarm. Not available for NC operation. Replacement Chip (if ordered separately from DE lock)	52.00
101-SP	External 15 watt speaker connects directly to 1511S or 1511T for enhanced decibels on site or remote voice message announcement. Speaker driver may be provided by others for extreme decibel requirements.	38.00
101-SPSN	Remote Single Gang Annunciator with speaker and 80db tone. Duplicates ExitCheck alternating voice message and tone.	100.00
EA100	Multi-Mode Exit Annunciator Bar interfaces with Delayed Egress devices for forced entry or unauthorized exit signaling. Highly visible from any angle, due to multi color LED lights with rolling signal. See also page XX	182.00

Price List Effective February 1, 2017

SECURITY DOOR CONTROLS
801 Avenida Acaso • Camarillo, CA 93012
Email: Service@sdsecurity.com • www.sdsecurity.com



Delayed Egress Locks
& Controllers



FWAX Special Locking Arrangements
GWXT Auxiliary Locks

ANSI/BHMA A156.24
Grade 1



3774-0324:103



1581S

SDC PUSH UNTIL ALARM SOUNDS. DOOR CAN BE OPENED IN 15 SECONDS.

1581S Single Mini Delayed Egress Lock 650 lbs. holding force. Current: 320/500 mA @ 24VDC/12VDC **932.00**

Specify 2 for pairs of doors
Remote reset control required. See below.
Lock size 10" L x 2" H x 2.375" D

SPECIFY OPERATION

Specify **ND, NC, NH, BC, BD, BH** - see codes and description on page 18
If no Code is specified - **ND** is the **SDC STANDARD OPERATIONS MODE** for this product

SPECIFY FINISH Add to List

Anodized Finishes

V	628 Clear Anodized Aluminum (standard)	N/C
Y	335 Black Anodized	83.00

Powder Coat Finishes

(a coating electrostatically applied to form a hard finish, that is tougher than conventional paint)

X	Dark Bronze Powder Coat Painted (313/613 Equal)	83.00	C	605 Bright Brass Powder Coat Painted	83.00
D	606 Dull Brass Powder Coat Painted	83.00			

Plated Finishes. Special order, no cancellations or returns

P	625 Bright Chrome	197.00	Q	626 Dull Chrome	197.00
----------	-------------------	---------------	----------	-----------------	---------------

SPECIFY OPTIONS Add to List

D	Door position status	63.00
B	Magnetic bond sensor (Not an output. Low Holding Force. Put unit into alarm.)	104.00

TANDEM CABLE FOR PAIR OF DOORS LIST

Required when using two locks on a pair of doors, cables enable slave operation.

1581S-TC-3	Cable kit for connecting two locks through the frame header	32.00
1581S-TC-10	Cable kit for connecting wiring for two locks in a remote junction box	42.00

SPECIFY RESET AND CONTROL DEVICE LIST

Select Reset Station for NC and ND functions

918	EntryCheck™ digital keypad, 500 user codes Keyless Reset / manual power up / bypass	166.00
728	Key switch, 2 keys, 1 gang Reset / manual power up / sustained bypass	63.00
728L3	Key switch, 2 keys, 1 gang, LED status indicator Reset / manual power up / sustained bypass	87.00
702R	Separate wall mount reset key switch assembly MO SPDT dry contact, 6 Amp @ 30VDC max. Accepts standard 1-1/8" to 1-1/4" (Mortise key cylinder not included)	114.00
101-1AK	Key switch assembly, 2 gang, LED status indicator, less cylinder Reset / manual power up / sustained bypass	332.00
101-4AM	Four station remote annunciator	332.00



SECURITY DOOR CONTROLS
801 Avenida Acaso • Camarillo, CA 93012
Email: Service@sdccsecurity.com • www.sdccsecurity.com

Price List Effective February 1, 2017

Delayed Egress Locks & Controllers



918



728



702R



101-1AK



101-4AM

101 ExitCheck® Wall Mount Delayed Egress - NFPA 101 Locking Arrangements

Distributor Discount Code **GKK**

Proprietary Verbal Exit Instructions with Alarm Tone and 3/4" Digital Countdown Display



STANDARD FEATURES INCLUDE: 12/24VDC voltage sensing input, delay electronics packaged on a 3-gang wall plate for recessed wall mounting or surface wall mounting with optional junction box. Features include: std. 15 or 30 second switchable exit delay (NA), 1 or 2 second nuisance delay. Keypad for violation reset, momentary bypass and on-off; Voice Annunciation and digital countdown display with door open indicator. Status and remote control inputs are standard.

12VDC / 24VDC @ 200 mA Max.

- Doors **WITH** latch assemblies are sensor activated and do not require power transfer or trigger switch in exit device. Where preferred a trigger switch may be added to the exit device for manual activation in lieu of door movement activation.
- Doors **WITHOUT** latches require a non-latching Request-to-Exit Bar PSB560 Sure Exit® or MSB550 Switch Bar (see XX). Also compatible with standard EMLocks (see XX.)



"Security Industry Finest"
ISC Expo



101-DE



101-KDE



101-DE
with DEC-J



101-1AK

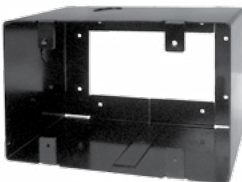



DEC-J



SHD-J
with 101-DE

DELAYED EGRESS CONTROLLER (1 PER OPENING, SINGLE OR PAIRS)

LIST

101-DE	Wall mount controller with keypad control and reset, 200 mA @ 12/24 VDC - NA standard	823.00
101-KDE	Wall mount controller with both key switch and keypad control and reset, 200 mA @ 12/24 VDC order with optional Mortise Cylinder	932.00
	CYL-6KDK 6 pin, 1.125" Mortise Cylinder, Keyed Different	add 32.00
	CYL-6KAQ 6 pin, 1.125" Mortise Cylinder, Keyed Alike	add 32.00

Specify NA, NC, ND, BC, BD - see codes and description on page 18

If no Code is specified - NA is the SDC STANDARD OPERATIONS MODE for this product

MAGNETIC LOCK WITH INTEGRATED ACTIVATION SENSOR

LIST

Specify 2 for pair of doors

1511DEV	Single, 1650 lbs holding force, 670/350 mA @12/24 VDC	523.00
1571DEV	Single, 1200 lbs holding force Energy Saver, 250/125 mA @12/24 VDC	497.00
1581DEV	Single, 650 lbs holding force, 440/220 mA @12/24 VDC Outdoor Locks	414.00
1575DEU	Single outdoor magnetic lock with magnetic bond sensor	497.00
1576DEU	Single face drilled outdoor magnetic lock with magnetic bond sensor	497.00
1576DE-ZB	Inswing mounting bracket for 1576DEU	156.00

MAGNETIC LOCK FINISH

Add to List

V	628 Clear Anodized Aluminum (Standard)	N/C
Y	Black Anodized	Single 83.00

Powder Coat Finishes

(a coating electrostatically applied to form a hard finish, that is tougher than conventional paint)

X	Dark Bronze Powder Coat Painted (313/613 Equal)	Single 83.00
----------	---	---------------------

OPTIONAL MONITORING

Add to List

B	Magnetic bond sensor, indicates locked with full holding force, low holding force, unlocked, tampering and obstructions. (1581DE SPST only)	63.00
D	Door position sensor, indicates door open and door closed. Commonly used to verify egress after alarm and exit delay activation.	42.00
(D) Door position sensor not available with 1581, 1575 and 1576		

OPTIONAL HARDWARE

Add to List

101-1AK	Outdoor reset with LED and Audible annunciator. 2-gang outdoor box required (Interior 101-DE and 1575 or 1576 outdoor magnetic lock required)	332.00
DEC-J	3 Gang Interior surface mount box for 101-DE	94.00
SHD-J	Shroud for surface mount box DEC-J outdoor use	63.00

SHD-J
End View

Mounting Kits & Angle Brackets - See page 11

Price List Effective February 1, 2017

SECURITY DOOR CONTROLS
801 Avenida Acaso • Camarillo, CA 93012
Email: Service@sdsecurity.com • www.sdsecurity.com



Delayed Egress Locks
& Controllers



918 Keyless Reset and Bypass or Momentary Authorized Access 500 User Codes **166.00**
Keypad tamper lockout; Indoor blue backlit, moisture resistant keypad



918 920 Keyless Reset and Bypass or Momentary Authorized Access 500 User Codes **182.00**
Heavy Cast Vandal Resistant Housing

920



702R Separate wall mount reset key switch assembly **114.00**
MO SPDT dry contact, 6 Amp @ 30VDC max.
Accepts standard 1-1/8" to 1-1/4" (Mortise key cylinder not included)



702R 707R Remote reset key switch with dual function for Bypass (authorized egress) and reset **156.00**
(2) MO SPDT dry contact, 6Amp @ 30VDC max
Accepts standard 1-1/8" to 1-1/4" mortise key cylinder. (Mortise key cylinder not included)

707R



708R Remote reset key switch for bypass (on/off) and reset **156.00**
(1) Maintain (1) MO, SPDT dry contact, 6Amp @ 30VDC max
Accepts standard 1-1/8" to 1-1/4" mortise key cylinder. (Mortise key cylinder not included)

708R

order with optional Mortise Cylinder



CYL-6KDQ 6 pin, 1.125" Mortise Cylinder, Keyed Different **add 32.00**
CYL-6KAQ 6 pin, 1.125" Mortise Cylinder, Keyed Alike **add 32.00**



101-1A Remote or local single door annunciator with audible alarm and tricolor LED, 1 Gang **109.00**
Green - Secure Amber - Egress initiated Red - Door unlocked

101-1A



101-4AM Remote four door annunciator with audible alarm mute button. Four tricolor LEDs, 2 Gang **332.00**
Green - Secure Amber - Egress initiated Red - Door unlocked

101-4AM



101-1AK Remote or local single door annunciator with 2 function key switch for on/off, reset, **332.00**
audible alarm and tricolor LED, 2 Gang
Green - Secure Amber - Egress initiated Red - Door unlocked
Accepts standard 1-1/8" to 1-1/4" mortise key cylinder.
(Mortise key cylinder not included)

101-1AK

order with optional Mortise Cylinder



CYL-6KDQ 6 pin, 1.125" Mortise Cylinder, Keyed Different **add 32.00**
CYL-6KAQ 6 pin, 1.125" Mortise Cylinder, Keyed Alike **add 32.00**



101-PAM

101-PAM Remote single door annunciator with 3 push button switches for momentary **332.00**
access. On/off and audible alarm mute button with tricolor LED, 2 Gang
Green - Secure Amber - Egress initiated Red - Door unlocked
Recommended for remote installation only



101-SP

101-SP External 15 watt speaker connects directly to 1511S or 1511T for enhanced decibels **38.00**
onsite or remote voice message annunciation. Speaker driver may be provided by others
for extreme decibel requirements.



101-SPSN

101-SPSN Remote Single Gang Annunciator with speaker and 80db tone. Duplicates ExitCheck alternat- **100.00**
ing voice message and tone.

15 Series Electric Strike

Distributor Discount Code **FK LIST**



- For 5/8" latch or 3/4" latch with 1/8" gap
- Choice of failsafe or failsecure
- 4.875" (124mm) radius corner
- All stainless steel parts
- 630 Satin stainless steel face plate

SPECIFICATIONS

Input 200mA @ 12VDC, 150mA @ 24VDC

Dimensions 1-1/4" W x 4-7/8" H x 1-1/2" D

MODEL

15-4F12U	Failsafe, 12VDC	88.00	15-4S12U	Failsecure, 12VDC	88.00
15-4F24U	Failsafe, 24VDC	88.00	15-4S24U	Failsecure, 24VDC	88.00
RMB	Buzzer 12/24V AC/DC operation	42.00	BR64XL	Rectifier for AC operation	26.00

Not recommended for wood application

25 Series Electric Strike

LIST



The SDC 25 Series electric strike is designed for use with locksets having 5/8" (15mm) throw latchbolt. The compact low profile design with an internally mounted solenoid and factory supplied mounting tabs enable quick and easy installation where jamb space is limited.

- For 1/2" latch or 5/8" latch with 1/8" door gap
- Latch bolt monitor standard
- Failsecure
- Field reversible for failsafe operation
- Compatible with 5/8" latchbolts
- All stainless steel parts
- 630 Stainless steel standard finish

SPECIFICATIONS

Dual Voltage 200/100 mA @ 12/24VDC

Latch Status SPDT, 3 Amp @ 30VDC

Dimensions 1-1/4" W x 4-7/8" H x 1-1/2" D

MODEL

25-4U	4.875" (124mm) Square corner	125.00
RMB	Buzzer 12/24V AC/DC operation	40.00
BR64XL	Rectifier for AC operation	26.00

Not recommended for wood application

30 Series Rim Mount Electric Strikes

Distributor Discount Code **FK**

Stainless steel electric strike for rim mount exit devices. Strike is non-handed, fail secure is standard with fail safe optional. Standard finish is stainless steel 630 (U). Check template to ensure compatibility.



30-4

SPECIFY MODEL		<input type="text"/>	<input type="text"/>	<input type="text"/>	LIST
30-4-12	Stainless steel electric strike designed for rim-type exit devices 12VDC@ 0.51Amp				699.00
30-4-24	Stainless steel electric strike designed for rim-type exit devices 24VDC@ 0.25Amp				699.00
SPECIFY FINISH		<input type="text"/>	<input type="text"/>	<input type="text"/>	Add to List
U	630 Dull Stainless Steel (Standard)		N/C		
OPTIONS		<input type="text"/>	<input type="text"/>	<input type="text"/>	Add to List
FS	Failsafe operation		37.00	BR64XL	Rectifier 26.00
LCBMA-30	Latch & locking cam monitor		223.00		

**Not Compatible with SDC S6000
See S6000 Electric Trim page 36**



45-A

The **SDC 45 Series** electric strike is designed for use with locksets having up to 3/4" latchbolts. The compact low profile design with an internally mounted solenoid and mounting tabs enable quick and easy installation where jamb space is limited. **UL Listing pending**

- For 5/8" latch or 3/4" latch with 1/8" gap
- **Latch bolt monitor standard**
- **Keeper closed and deadlocked standard**
- Field selectable failsecure - failsafe
- Field selectable voltage, 12/24V AC/DC
- 1/4" Horizontal alignment adjustment
- Low profile, 1-3/16" deep
- Plug-in wire connectors
- Mounting tabs
- All stainless steel parts with durable die cast body for corrosion resistance
- Fewer moving parts for maximum life
- 630 stainless steel standard
- ANSI A156.31 compliant

SPECIFICATIONS

Dual Voltage	280/140mA @ 12/24V DC, 170/85mA @ 12/24V AC
Latch Status	SPDT, Dry 3Amp @ 30V (standard)
Keeper Closed/Deadlocked	SPDT, Dry 3Amp @ 30V (standard)
Keeper Open Closed Status	SPDT, Dry 3Amp @ 30V (optional - K option)

SPECIFY MODEL

List

MODEL

45-A	Included: One 4.875" square corner faceplate. <i>Stainless steel finish standard*</i> One 4.875" radius corner faceplate. <i>Aluminum finish standard*</i> One 7.9375" radius corner faceplate. <i>Aluminum finish standard*</i>	187.00
45-4S	4.875" x 1.25" (124x32mm) square corner faceplate. <i>Stainless steel finish standard*</i>	158.00
45-4R	4.875" x 1.25" (124x32mm) radius corner faceplate. <i>Aluminum finish standard*</i>	162.00
45-6R	6.875" x 1.25" (175x32mm) radius corner faceplate. <i>Aluminum finish standard*</i>	166.00
45-7R	7.937" x 1.438" (202x36.5mm) radius corner faceplate. <i>Aluminum finish standard*</i>	171.00

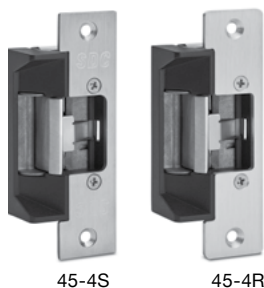

45-4S

45-4R



45-6R

45-7R

SPECIFY FINISH

Add to List

Square Corner Faceplate

U	630 Dull stainless Steel (std)	N/C
H	613 Oil Rubbed Bronze	26.00
D	606 Dull Brass	26.00

Radius Corner Faceplate

V	628 Dull Aluminum (std)	N/C
Y	335 Black Anodized	26.00
45-A	Special Finish	78.00

OPTIONS

Add to List

K	Keeper open/closed status	40.00	RMB	Buzzer 12/24V AC/DC operation	42.00
----------	---------------------------	--------------	------------	-------------------------------	--------------

SPECIFY LIP EXTENSION KIT for 45 Series only

Add to List

LE1	1" Lip Extension Kit	32.00
LE2	2" Lip Extension Kit (Includes two 1" extensions)	63.00
LE3	3" Lip Extension Kit (Includes three 1" extensions)	94.00

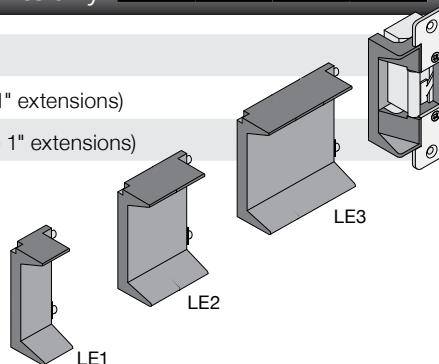

SDC
SECURITY DOOR CONTROLS
 801 Avenida Acaso • Camarillo, CA 93012
 Email: Service@sdsecurity.com • www.sdsecurity.com

Price List Effective February 1, 2017



The **45F fire-rated Grade 1 strike** is specially designed with a durable, stainless steel die cast body. It is engineered with corrosion resistant components with fewer moving parts for maximum life. The standard unit includes monitoring outputs, field-selectable voltage, and field-adjustable operation (fail-secure or fail-safe.) Designed for use with cylindrical and mortise locksets with 9/16" - 3/4" throw latch bolts.

- ANSI/BHMA A156.31, Grade 1
- Centerline Electric Strike
- For 9/16" or 3/4" latch with 1/8" door gap
- **Latch bolt monitor standard**
- **Keeper closed & deadlocked standard**
- Field selectable fail-secure - failsafe
- Field selectable voltage 12/24V AC/DC
- 1/4" Horizontal alignment adjustment
- Static strength 1500lbs.
- Low profile, 1-3/16" deep
- All stainless steel parts with durable die cast body for corrosion resistance
- Plug-in wire connectors
- Mounting tabs
- Non-handed
- Fewer moving parts for maximum life
- 630 stainless steel standard
- UL Listed 1034 Burglary Resistant
- UL 10C, 3 Hr Fire Rated (Fail-Secure only)
- U.S. Patent #7,540,542 B2

SPECIFICATIONS

Dual Voltage	280/140mA @ 12/24V DC, 170/85mA @ 12/24V AC
Latch Status	SPDT, Dry 3Amp @ 30V (standard)
Keeper Closed/Deadlocked	SPDT, Dry 3Amp @ 30V (standard)
Keeper Open Closed Status	SPDT, Dry 3Amp @ 30V (optional - K option)



SPECIFY MODEL List

MODEL		
45F-4SU	<i>Included: One 4.875" square corner faceplate. Stainless steel finish standard*</i>	399.00

For additional Plates contact factory

SPECIFY FINISH Add to List

Square Corner Faceplate		
U	630 Dull stainless Steel (std)	N/C
H	613 Oil Rubbed Bronze	26.00
D	606 Dull Brass	26.00

OPTIONS Add to List

K	Keeper open/closed status	40.00	RMB	Buzzer 12/24V AC/DC operation	42.00
----------	---------------------------	--------------	------------	-------------------------------	--------------

Price List Effective February 1, 2017

SECURITY DOOR CONTROLS
 801 Avenida Acaso • Camarillo, CA 93012
 Email: Service@sdsecurity.com • www.sdsecurity.com



Electric Strikes

UniFLEX™ SPEC 55 Series Electric Strike, Grade 1 Heavy Duty - Factory tested 2500 lbs

STANDARD ANSI 4-7/8" STRIKE PREP - NO CENTERLINE RELOCATION REQUIRED.

5 YEAR LIMITED WARRANTY

One strike with choice of interchangeable faceplates for cylindrical and mortise locksets with or without deadbolts. Designed for new and retrofit hollow metal frame installations. *Frame face modification required.

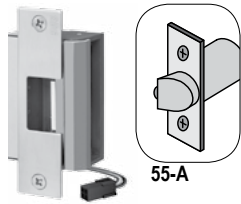

55-A

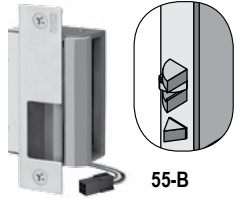

55-B

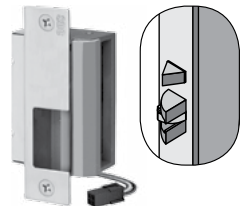

55-D

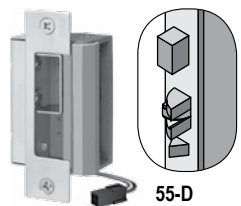

55-D

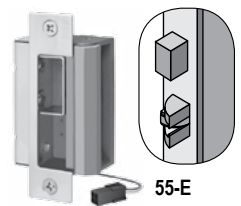

55-E

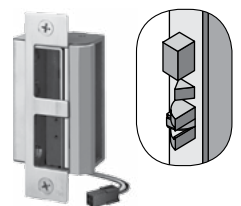

55-E

FEATURES

- Up to 3/4" Latchbolt and 1" Deadbolt
- Field Reversible, Failsafe/Failsecure
- 1/8" Horizontal alignment adjustment
- Dual Voltage 12/24VDC
- Exceeds 1,000,000 cycles
- Factory tested 2500 lbs static strength
- UL tested 1500 lb Static strength
- 70 ft-lb Dynamic strength
- ANSI/BHMA A156.31 Grade 1
- Internal Solenoid, No Heat in Keeper
- All parts stainless steel
- Non-handed



Warrnock Hersey Tested according to:
UL 10C, 3 Hr Fire Rated, 4' x 8' single door
NFPA-252

CAN4-S104 (ULC-S104)
(Fail-Secure only).



UL 1034
Burglary-Resistant

BP10254
40WH

SPECIFY MODEL

List

Lockset compatibility: For locksets not listed below, see UniFLEX™ 55 Series datasheet, page 5, faceplate dimension

Deadbolt Application: 55-D, 55-E and 55-F, door will not close with deadbolt extended

MODEL Application

MODEL	Application	
55-A	Compatible with all cylindrical locksets (Grade1 or equivalent)	435.00
55-B	Mortise locksets and exit mortise devices with or without a deadlatch located below the latchbolt. <i>Accurate, Arrow, Best, Corbin Russwin, Dorma, Falcon, Marks, Sargent, Yale.</i>	456.00
55-C	Mortise locksets and mortise exit devices with or without a deadlatch located above the latchbolt. <i>SDC, Schlage, Baldwin, Hager</i>	456.00
55-D	Mortise locksets with a deadbolt and deadlatch located below the latchbolt. <i>Accurate, Arrow, Best, Corbin Russwin, Dorma, Falcon, Marks, Sargent, Yale.</i>	477.00
55-E	Mortise lockset with deadbolt and no deadlatch feature. <i>Baldwin.</i>	477.00
55-F	Mortise locksets with a deadbolt and a deadlatch located above the latchbolt. <i>SDC, Schlage, Hager.</i>	477.00

SPECIFY FINISH

Add to List

U	G	P	N/C
630 Dull Stainless Steel (std)	612 Dull Bronze	625 Bright Chrome	42.00
D 606 Dull brass	H 613 Oil Rubbed Bronze	Q 626 Dull Chrome	42.00

SPECIFY MONITORING OPTIONS

Add to List

LBM/LCM available with 55-A, 55-B, 55-C; LBM/LCM/DBM available with 55-D, 55-E, 55-F

LBM	Latchbolt Monitor. Signals the door is closed and latched or unlatched and open. Non-handed.	63.00
LBM/LCM	Door Secure Monitor. Signals door is closed latched and the keeper is deadlocked. Also signals the door is unlatched or unlocked. Non-handed.	125.00
DBM-L	Deadbolt Monitor, Left Hand (Available with LCM and LBM. For D, E & F funtions only)	63.00
DBM-R	Deadbolt Monitor, Right Hand (Available with LCM and LBM. For D, E & F funtions only)	63.00

ACCESSORIES

Add to List

RMB	Buzzer, 12/24V. Indicates strike is energized	42.00
BR64XL	Wire Lead Rectifier. Converts AC to DC	26.00
LT	tri-Color LED, red or green or amber. Indicates strike energized per field wiring	32.00

Monitoring Configurations

55-A, 55-B,
55-C:
LBM
LBM/LCM

55-D, 55-E, 55-F:
LBM
LBM/LCM
LBM/LCM/DBM



A



B or C



D or E



F

SDC

SECURITY DOOR CONTROLS

801 Avenida Acaso • Camarillo, CA 93012
Email: Service@sdccsecurity.com • www.sdccsecurity.com

Price List Effective February 1, 2017

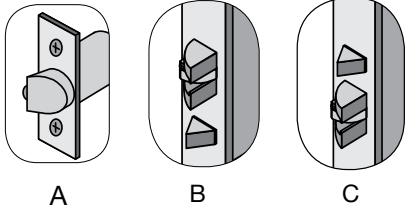

APPLICATION

- Adaptable to all 55-A, 55-B, 55C applications.
- Strike body and 5 faceplates
- For new and retrofit installation
- No relocation of the centerline.
- Non-handed

OPERATION
After releasing the latchbolt, the keeper returns to the locked position.

Finish: 630 Dull Stainless Steel

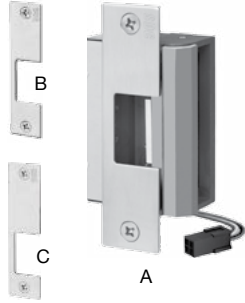

MODEL APPLICATION

55-ABC Universal Strike for cylindrical locks, mortise locks without deadbolts and mortise exit devices including: *SDC, Accurate, Arrow, Baldwin, Best, Corbin Russwin, Dorma, Falcon, Hager, Marks, Sargent, Schlage, Yale.* **477.00**

Lockset compatibility: For locksets not listed, see UniFLEX™ 55 Series datasheet, page 5, faceplate dimension

Price List Effective February 1, 2017

Latch and Deadbolt Monitoring Strike Kits

Distributor Discount Code **DK LIST**

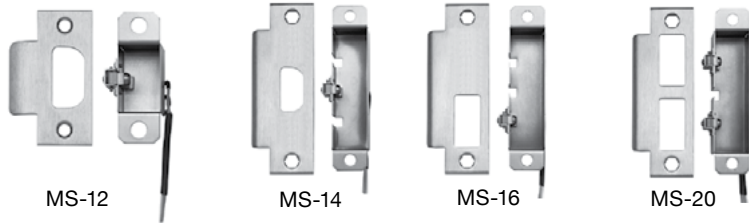

Provides latch and or deadbolt position status. Compatible with deadbolts, cylindrical locks, mortise locks, and mortise locks with latch and deadbolt. Strike plates shown provided by others. 5 Amp @ 30 VAC/DC

Strikeplates NOT INCLUDED

MS-12	Cylindrical latch monitor 2-3/4" SPDT	135.00
MS-12D	Cylindrical latch monitor 2-3/4" DPDT	166.00
MS-14	Cylindrical latch monitor 4-7/8" SPDT	135.00
MS-14D	Cylindrical latch monitor 4-7/8" DPDT	166.00
MS-16	Mortise lock latch monitor SPDT	135.00
MS-16D	Mortise lock latch monitor DPDT	166.00

MS-18	Mortise lock deadbolt monitor SPDT	135.00
MS-18D	Mortise lock deadbolt monitor DPDT	176.00
MS-20*	Mortise lock latch and deadbolt monitor SPDT	166.00
MS-20D*	Mortise lock latch and deadbolt monitor DPDT	223.00

*MS-20 and MS-20D are handed but reversible

SECURITY DOOR CONTROLS
801 Avenida Acaso • Camarillo, CA 93012
Email: Service@sdsecurity.com • www.sdsecurity.com



Electric Strikes

ELECTRA MOD™ Major Brand Locks Electrified by SDC

Distributor Discount Code **LEK**



Schlage



Sargent



Best



Yale



Dorma

SDC's Electra™ Mod Locksets ensure that the door stays latched even when unlocked, maintaining fire door integrity. The Electra™ Mod locksets comply with all national building and fire life safety code requirements for use on fire rated doors, including high-rise stairwell and elevator lobby doors where the use of electric strikes and magnetic locks is prohibited.

FEATURES

- Outside lever normally locked, turning inside lever provides uninhibited egress
- Request-to-exit output optional with all locksets
- Dual Voltage 12 and 24VDC
- Choice of failsafe or failsecure operating mode

SPECIFICATIONS

Voltage	Dual 12/24VDC Input	Backset	2-3/4"
Current	600/300mA @ 12/24VD	Strike	4-7/8" ANSI A115.2
Optional REX Output	SPDT 3 Amps @ 30VDC	Door Thickness	1-5/8" to 2-1/8"
Latchbolt	1/2" throw		

SDC SUPPLIED MECHANICAL LOCKSET LIST

In Stock: Following SDC electrified locksets are in stock at both SDC east and west coast warehouses for shipment by the next business day.

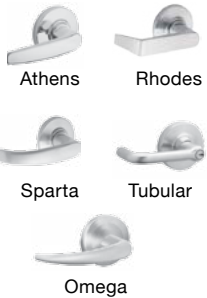

Schlage Failsafe and Failsecure electrified locksets provided by SDC

SDC Failsafe	SDC Failsecure	Trim Type	
ZS7250ATHQ	ZS7252ATHQ	Athens	704.00
ZS7250SPAQ	ZS7252SPAQ	Sparta	704.00
ZS7250RHOQ	ZS7252RHOQ	Rhodes	704.00
ZS7250TLRQ	ZS7252TLRQ	Tubular	704.00
ZS7250OSEQ	ZS7252OSEQ	Omega	704.00

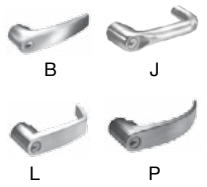

Sargent Failsafe and Failsecure electrified locksets provided by SDC

SDC Failsafe	SDC Failsecure	Trim Type	
ZD7250BQ	ZD7252BQ	B	808.00
ZD7250JQ	ZD7252JQ	J	808.00
ZD7250LQ	ZD7252LQ	L	808.00
ZD7250PQ	ZD7252PQ	P	808.00



Yale Failsafe and Failsecure electrified locksets provided by SDC

SDC Failsafe	SDC Failsecure	Trim Type	
ZP7250AUQ	ZP7252AUQ	Augusta	721.00
ZP7250MOQ	ZP7252MOQ	Monroe	721.00
ZP7250PBQ	ZP7252PBQ	Pacific Beach	721.00



Best Failsafe and Failsecure electrified locksets provided by SDC

SDC Failsafe	SDC Failsecure	Trim Type	
ZT725014Q	ZT725214Q	14	854.00
ZT725015Q	ZT725215Q	15	854.00
ZT725016Q	ZT725216Q	16	854.00
REX Option	Request-to-exit output, SPDT, 3 Amps @ 30VDC		120.00

SECURITY DOOR CONTROLS
 801 Avenida Acaso • Camarillo, CA 93012
 Email: Service@sdccsecurity.com • www.sdccsecurity.com

Price List Effective February 1, 2017

HOW TO ORDER



DISTRIBUTOR SUPPLIED MECHANICAL LOCKSET SDC FACTORY ELECTRIFIED LIST

Distributors to supply SDC with cylindrical lock for modification. SDC returns modified lock to distributor

S	Schlage	ND80PD	P	Yale	5405LN	167.00
T	Best	93K7D	D	Sargent	10G04	167.00
U	Dorma	C880	H	Hager	3480	167.00

	Failsafe	Failsecure	
Schlage	S7250	S7252	167.00
Yale	P7250	P7252	167.00
Best	T7250	T7252	167.00
Sargent	D7250	D7252	167.00
Dorma	U7250	U7252	167.00
Hager	H7250	H7252	167.00
REX Option	Request-to-exit output, SPDT, 3 Amps @ 30VDC		120.00

Price List Effective February 1, 2017

SDC SECURITY DOOR CONTROLS
 801 Avenida Acaso • Camarillo, CA 93012
 Email: Service@sdsecurity.com • www.sdsecurity.com



ELECTRA PRO™ SDC' Z7200 Series Heavy Duty Cylindrical Locksets

Distributor Discount Code **LEK**

Function: 7200 Series Locksets are locked on the outside and unlocked from the exterior by an access control or mechanical key. The inside lever is always operable for uninhibited egress.

Latch Status Output: Standard with all SDC brand Z7200 locksets. SPDT, 3 Amps @ 30VDC

FEATURES

- Choice of failsecure or failsafe mode
- Dual 12/24 VDC
- **Latch Status Output:** Z7200 standard
- 'C' type keyway, BEST IC core optional
- Independent lever power return springs
- Power Regulator Module included

SPECIFICATIONS

Dual Voltage	600/300 mA @ 12/24VDC	Backset	2.75
Certification	Exceeds ANSI A156-2-4000 Grade 1	Strike	4.875 strike ANSI A115.2
Latchbolt	0.5625"	Door Thickness	1-5/8" to 2-1/8"



Electrically Controlled Single Point Locks & Latches, 3 Hr A Label Fire Doors



3773-0324-104



Electra Pro™ Z7250G



Electra Pro™ Z7250E

SPECIFY MODEL LIST

Electra Pro™ Locks

Z7250	SDC Failsafe, with Latch Status Output	Z7252	SDC Failsecure, with Latch Status Output	435.00
--------------	--	--------------	--	---------------

SPECIFY LEVER TRIM LIST

SDC Lever Trim

G	Galaxy	E	Eclipse	N/C
G5	Galaxy, I-Core prep	E5	Eclipse, I-Core prep	26.00

G5 and E5 I-Core prep without I-Core

SPECIFY FINISH Add to List

Q	626 Dull Chrome (standard)	N/C		
C	605 Bright Brass	52.00	H	613 Oil Rubbed Bronze 52.00
D	606 Dull Brass	52.00	P	625 Bright Chrome 52.00



G Galaxy



E Eclipse



G5 Galaxy, I-Core prep



E5 Eclipse, I-Core prep



I-CORE

OPTIONAL CYLINDER and I-CORES Add to List

R	Request-to-exit output, operates on activation of inside lever, SPDT 0.1A @ 30VDC	120.00
----------	---	---------------

OPTIONAL CYLINDER and I-CORES Add to List

SDC Conventional Cylinders (Schlage 'C' Keyway Standard)

6PKA	6 PIN Keyed alike	N/C	6PKD	6 PIN Keyed different (standard)	N/C
-------------	-------------------	------------	-------------	----------------------------------	------------

[IC] Interchangeable Core (Best 'A' Keyway Standard)

IC7P-KA	7 pin I-Core, small format, keyed alike	52.00	IC7P-KD	7 pin I-Core, small format, keyed different	52.00
----------------	---	--------------	----------------	---	--------------

OPTIONAL LATCH AND BACKSET ASSEMBLIES LIST

B1	2-3/4" Backset latchbolt (Standard)	N/C
-----------	-------------------------------------	------------

OPTIONAL STRIKE PLATES

ST1	ANSI 1-1/4" x 4-7/8" (Standard)	N/C	ST2	T-Strike with dust box, 1-1/8" x 2-3/4" MUST BE SPECIFIED	N/C
------------	---------------------------------	------------	------------	---	------------



SECURITY DOOR CONTROLS
 801 Avenida Acaso • Camarillo, CA 93012
 Email: Service@sdsecurity.com • www.sdsecurity.com

Price List Effective February 1, 2017

SELECTRIC™ PRO Z7800 Electric Lockset



Distributor Discount Code **LSK**

SELECTRIC® Pro Locksets incorporate an SDC manufactured Grade 1 Heavy Duty mortise lockset and vandal resistant clutch mechanism. Proprietary to SDC, SELECTRIC® Pro locksets. All operational attributes are field selectable. In addition, SELECTRIC® Pro locksets retrofit many other mechanical lock brands making them fully compatible with new and retrofit applications.

FIELD SELECTABLE ATTRIBUTES

- Selectable mode, failsafe or failsecure
- Selectable function, locked outside only or both sides
- Selectable voltage, 12 or 24VDC
- Selectable handing



Electrically Controlled
Single Point Locks or
Latches
3 Hr A Label Fire
Rated Doors



3773-0324-104

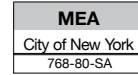

SPECIFY FUNCTION AND MODE

LIST

SDC Supplied Electrified Lock (Mortise cylinder not included). SDC Brand 7800 lockset. Clutch for lever trim vandal resistance. * Less trim - compatible with Schlage trim

		* Less Trim	With SDC Trim
Z7830	Locked both sides, failsafe. Field reversible to failsecure mode.	306.00	735.00
Z7850	Locked outside only, failsafe. Field reversible to failsecure mode.	306.00	735.00
Z7832	Locked both sides, failsecure. Field reversible to failsafe mode.	306.00	735.00
Z7852	Locked outside only, failsecure. Field reversible to failsafe mode.	306.00	735.00
Z7835	Locked outside and/or inside. Outside failsecure, inside failsafe	466.00	849.00

VOLTAGE - Z7835 ONLY

Specify voltage for Z7835 function only. Leave blank for all other functions which are 12/24VDC, field selectable

12 12VDC	24 24VDC	N/C

SPECIFY HAND

L Left hand	LR Left hand reversed	All hands are field reversible	N/C
R Right hand	RR Right hand reversed	without disassembly (exception Z7835)	N/C

SPECIFY FINISH

Add to List

Q 626 Dull Chrome (standard)	N/C		
C 605 Bright Brass	52.00	G 612 Dull Bronze	52.00
D 606 Dull Brass	52.00	H 613 Oil Rubbed Bronze	52.00
F 611 Bright Bronze	52.00	U 630 Dull Stainless Steel	52.00
		S 629 Bright Stainless Steel	52.00
		P 625 Bright Chrome	52.00

SPECIFY LEVER TRIM

Add to List

G Galaxy with rose	N/C	GE Galaxy with escutcheon	104.00
E Eclipse with rose	N/C	EE Eclipse with escutcheon	104.00
N Nova with rose	N/C	NE Nova with escutcheon	104.00
07 Schlage equal with SDC B rose	N/C	07E Schlage equal with SDC escutcheon	104.00

OPTIONS AND ACCESSORIES

Add to List

Optional Outputs

R Request-to-exit. Indicates inside lever operation for access control request-to-exit input, alarm shunt, remote annunciation or CCTV activation, SPDT 5 Amp @ 30VDC	83.00
D Door position status output. Indicates door open and door closed. SPDT 5 Amp @ 30VDC.	83.00
S Latched & locked status output. Indicates door latched and locked and door unlocked. SPDT 5 Amp @ 30VDC	104.00

Optional Cable and Connectors

CC1-5 5ft. Cable and connectors for locks without optional outputs	47.00
CC3-5 5ft. Cable and connectors for locks with optional outputs	63.00

Optional Key Cylinders

1 required for 7850/7852 2 required for 7830/7832 **32.00**

CYL-6KDK 6 pin, 1.125" keyed different, 626 Dull Chrome	32.00
CYL-6KAQ 6 pin, 1.125" keyed alike, 626 Dull Chrome	32.00

Power Transfer Hinge

UL listed, 4.5", five knuckle hinge. Special finish available

PTH-4Q Four wire, dull chrome	156.00
PTH-10Q Ten wire, dull chrome	202.00
PTH-2+4Q 6-wire Electric Hinge 1-pair 16 Amp inrush, 4 Amp continuous;2-pair 1 Amp @ 12/24V	182.00

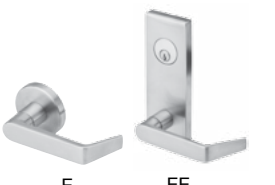
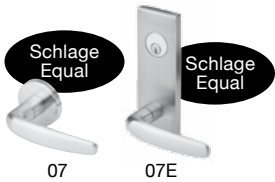

PTH

UL 10B Listed for 3Hr
Fire Rated Doors
See page XX

Price List Effective February 1, 2017

SDC SECURITY DOOR CONTROLS
801 Avenida Acaso • Camarillo, CA 93012
Email: Service@sdsecurity.com • www.sdsecurity.com



Electrified Locksets

SELECTRIC™ MOD 7800 Series Locksets



Distributor Discount Code **LSK**

Send the brand lockset of your choice to SDC for electrification. When factory authorized, distributors may take advantage of SDC's mechanical lock inventory to expedite orders. **SDC stocks Schlage, Corbin Russwin, Yale, Best and Sargent mechanical locks that may be electrified and charged to an order. Meanwhile, distributors may then send replacement mechanical locks to SDC for credit and SDC inventory replenishment.**

FEATURES SCHLAGE S AND ZS ONLY

- Field selectable failsafe/failsecure
- Field selectable voltage, 12/24VDC
- Field selectable function and handing without removing cover

FEATURES ALL OTHER BRANDS

- Field selectable voltage, 12/24VDC
- Field selectable function and handing based on brand capability

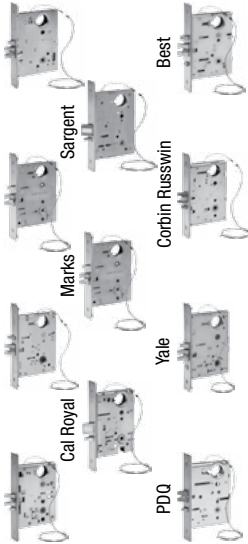

SPECIFY BRAND MODEL LIST

Distributors supply SDC with the mortise lock body and armored front (less trim) for modification. SDC returns the modified lock body. Upon installation, two lever return spring cages (supplied by distributor) are required for proper operation.

A Falcon - LM561/MA581	N Arrow - B12	U Dorma - M9000	166.00
D Sargent - 8204	P Yale - 8805	V Marks - 5EW	166.00
H Hager - 3880	S Schlage - L9080	W Cal Royal - M8080	166.00
I Corbin/Russwin - ML2055	T Best - 35HEW/45H	X PDQ - MR148	166.00

Note: Two locking hubs required for 7830 & 7832

Electrified lock chassis, less trim, provided by SDC factory are special order, no cancellation, no return.

ZS Schlage	ZN Arrow	ZD Sargent	ZT Best	POA
-------------------	-----------------	-------------------	----------------	------------

ZA Falcon	ZP Yale	ZI Corbin Russwin	NOTE: All locks supplied less cylinder
------------------	----------------	--------------------------	---

SPECIFY FUNCTION & ELECTRICAL MODE Add to List

7830 Locked both sides, failsafe	7832 Locked both sides, failsecure	63.00
7850 Locked outside only, failsafe	7852 Locked outside only, failsecure	N/C

Schlage S and ZS only

- Field selectable failsafe / failsecure
- Field selectable function without removing cover

SPECIFY HAND Add to List

L Left hand	LR Left hand reversed	R Right hand	RR Right hand reversed	N/C
--------------------	------------------------------	---------------------	-------------------------------	------------

SPECIFY FINISH Add to List

Q 626 Dull Chrome (standard)	N/C				
C 605 Bright Brass	52.00	G 612 Dull Bronze	52.00	S 629 Bright Steel	52.00
D 606 Dull Brass	52.00	H 613 Oil Rubbed Bronze	52.00	U 630 Dull Stainless Steel	52.00
F 611 Bright Bronze	52.00	P 625 Bright Chrome	52.00		

OPTIONS AND ACCESSORIES Add to List

Optional Outputs

R	Request-To-Exit. Indicates inside lever operation for access control request-to-exit input, alarm shunt, remote annunciation or CCTV activation, SPDT 5 Amp @ 30VDC Available with A, D, I, N, P, S, T, U, V and ZS only.	125.00
D	Door Position Status Output Indicates door open and door closed. SPDT 5 Amp @ 30VDC Available with locks S and ZS only.	83.00
S	Latched & Locked Status Output Indicates door latched and locked or door unlocked. SPDT 5 Amp @ 30VDC Available with locks S and SZ only.	104.00
L	Latchbolt status. Indicates door latched and unlatched status. SPDT 5 Amp @ 30VDC Available with locks A, D, I, N, P, S, T, U, V and ZS only.	104.00

Consult factory for recent updates of option availability with any model

Optional Cable and Connectors

CC1-5	5ft. Cable and connectors for locks <u>without</u> optional outputs	47.00
CC3-5	5ft. Cable and connectors for locks <u>with</u> optional outputs	63.00

Optional Key Cylinders 1 required for 7850/7852 2 required for 7830/7832

CYL-6KDQ	6 pin, 1.125" keyed different, 626 Dull Chrome	32.00
CYL-6KAQ	6 pin, 1.125" keyed alike, 626 Dull Chrome	32.00



Electrically Controlled
Single Point Locks or Latches
3 Hr A Label Fire Rated Doors

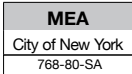

PTH
UL 10B Listed for 3Hr
Fire Rated Doors
See page 80



SECURITY DOOR CONTROLS
801 Avenida Acaso • Camarillo, CA 93012
Email: Service@sdccsecurity.com • www.sdccsecurity.com

Price List Effective February 1, 2017

SK-L90 Field Electrification Kit for Schlage L9000



LIST



SK-L90	Field Electrification Kit for Schlage L9000 Series	125.00
SK-L90-SC	Field Electrification Kit for Schlage L9080 (includes Springcage)	141.00
S7800-REX	Request-To-Exit kit for Schlage L9000 Series	125.00

SK-88 Field Electrification Kit for Yale 8805



LIST

SK-88	Field Electrification Kit for Yale 8805	125.00
LM-88	Field Latch Kit for Yale 8805	104.00

SK-82 Field Electrification Kit for Sargent 8206



LIST

SK-82	Field Electrification Kit for Sargent 8204	125.00
LM-82	Field Latch Kit for Sargent 8204	104.00

Door Core Drill Guide

Distributor
Discount Code

LZK LIST

The SDC 7000-DG Laser Guided Wire Raceway Drill Fixture enables wire raceway preparation through particle filled and solid wood doors. The door core wire raceway permits the installation and wiring of electrified locksets, exit devices and electric hinges. The Laser Guided Wire Raceway Drill Fixture is easy to use without previous experience. The kit allows for drilling from the hinge side without removing the door from the frame.

The **7000-DGK Kit** includes: **Laser Guided Door Core, Raceway Fixture, 1/4" x 6" Pilot Drill Bit, 3/8" x 50" Door Raceway Drill Bit** (Custom designed evacuator drill bit tool sharpened with 1' extra long flutes), **Fiberglass Wire Running Kit** (Flexible acrylic end connection, Brass hook end for pulling, Brass eye end for pushing), **Door Wedge, Kit Carry Case**

7000-DGK	Laser door core drill guide Kit	621.00
7000-DB3/8	3/8" x 50" evacuator drill bit	78.00
7000-PD 1/4 X 6	1/4" x 6" pilot drill bit	25.00

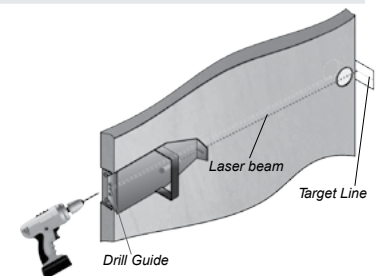

1/4 x 6" Pilot Drill Bit

3/8" x 50" Evacuator Drill Bit - Custom Designed for Door Raceways

Extra Long 1 Ft. Flute

7500 Series HiTower®



Distributor Discount Code **LK**

HiTower® – Electric Frame Actuator Controlled Locksets

The HiTower utilizes SDC's original concept of utilizing an electric frame actuator to control a mechanical lock in the door, eliminating the cost and labor associated with a power transfer hinge and wires through the door.

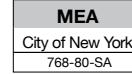

HiTower® Z7500

- SDC brand Grade 1 Heavy Duty lockset
- Field selectable function, Locked outside only or both sides

HiTower® CONVERSIONS

Distributors provide a new mechanical lock brand of choice to the factory for conversion to an electric frame actuator controlled lockset.



Electrically Controlled Single Point Locks or Latches
3 Hr A Label Fire Rated Doors

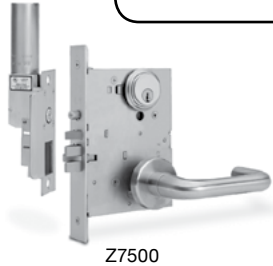

Z7500

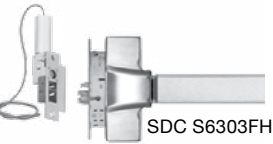

SDC S6303FH



O7550
Yale Conversion

SPECIFY SOURCE OF MORTISE LOCK

HiTower® Pro - SDC supplied mortise lock and electric frame actuator, complete with lever trim (Cylinder not included)

Z SDC lockset

ZR SDC Retrofit lockset, replaces discontinued 5000/6000 series

ZY SDC retrofit lockset replaces SDC modifications of discontinued manufacturer models: Falcon-LM581; Sargent-7704/7705; Corbin-9557L/2257; Russwin- 7059L; Arrow-1600EW; Yale-8705; Almet-5007; Best-35HEW

HiTower® Mod - SDC supplied **Schlage** mortise lock and electric frame actuator, less lever trim

ZS Schlage L9080

HiTower® Mod - Distributors supply SDC with the mortise lock body and armored front (less trim) for modification. SDC returns the modified lock body with an electric actuator. Upon installation, two lever return spring cages (supplied by distributor) are required for proper operation.

A Falcon*

LM-561/MA581

P Yale

8805

D Sargent

8204

R Schlage Retro

L9080 (replaces 5000 series)

H Hager

3880

S Schlage

L9080

I Corbin/Russwin

2057

T Best

35 HEW and 45H

N Arrow

B12

U Dorma

M9000

O Yale

7130F-L5 Exit device

V Marks

5EW

*All Falcon locks must be supplied with 0201000-000 face plate, less hub locking bar

SPECIFY FUNCTION

7530 Locked both sides. Unlocked by access control, remote control and key from either side, failsafe

7550 Locked outside only. Unlocked by access control, remote control, outside key and inside lever, failsafe

7560 Locked both sides. Unlocked by access control, remote control and key from either side, failsecure

7570 Locked outside only. Unlocked by access control, remote control, outside key and inside lever, failsecure

SPECIFY HAND

L Left hand

LR Left hand reversed

R Right hand

RR Right hand reversed



G

GE

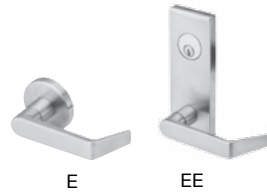

E

EE

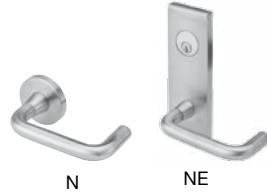

N

NE



07

07E

ACTUATOR VOLTAGE AND FRAME SIZE

see page 33 for pricing

Failsafe actuator for 1-3/4" to 2" face frames

A 115VAC 0.2 Amps

Extra Narrow failsafe actuator for 1-1/4" to 1-1/2" face frames

D 115VAC 0.2 Amps

+Failsecure actuator for 2" face frames

G 115VAC 0.2 Amps

B 24VAC 0.5 Amps

E 24VAC 0.5 Amps

H 24VAC 0.5 Amps

C 24VDC 0.5 Amps

F 24VDC 0.5 Amps

J 24VDC 0.5 Amps

+ Fail Secure Actuator Available with Z or S lockset only. Special strike preparation required for S7560/7570.

SPECIFY FINISH

Q 626 Dull Chrome (standard)

C 605 Bright Brass

52.00

G 612 Dull Bronze

50.00

S 629 Bright Stainless Steel

52.00

D 606 Dull Brass

52.00

H 613 Oil Rubbed Bronze

52.00

U 630 Dull Stainless Steel

52.00

F 611 Bright Bronze

52.00

P 625 Bright Chrome

52.00

SPECIFY LEVER TRIM FOR Z, ZR & ZY

G Galaxy with rose

N/C

GE Galaxy with escutcheon

104.00

E Eclipse with rose

N/C

EE Eclipse with escutcheon

104.00

N Nova with rose

N/C

NE Nova with escutcheon

104.00

07 Schlage style with SDC B rose

N/C

07E Schlage style with SDC escutcheon

104.00

PRICING BY SOURCE AND FUNCTION

Distributor Discount Code LK LIST

HiTower® PRO

Sources Z, ZR, ZY: SDC supplied - SDC lever trim, mortise lock and electric frame actuator. Schlage style lever trim 07 and 12 POA, consult factory for minimum qty.

SOURCE/FUNCTION

Z7530	SDC	Failsafe, locked both sides with rose trim	730.00
Z7550	SDC	Failsafe, locked outside only with rose trim	720.00
Z7560	SDC	Failsecure, locked Both sides with rose trim	885.00
Z7570	SDC	Failsecure, locked outside only with rose trim	875.00
ZY7530	SDC	(Replaces discontinued lock models, see 21 for details) Failsafe, locked both sides with rose trim	730.00
ZY7550	SDC	(Replaces discontinued lock models, see 21 for details) Failsafe, locked outside only with rose trim	699.00
ZR7530	SDC	(Replaces 5000 series) Failsafe, locked both sides with rose trim	834.00
ZR7550	SDC	(Replaces 5000 series) Failsafe, locked outside only with rose trim	823.00
ZR7560	SDC	(Replaces 6000 series) Failsecure, locked both sides with rose trim	885.00
ZR7570	SDC	(Replaces 6000 series) Failsecure, locked outside only with rose trim	875.00

Extra Narrow Failsafe Frame Actuator Add 125.00

(Actuator type D, E, F, only page XX) For 1-1/4" to 1-1/2" frames. Special strike prep required. Not available with ZR or failsecure 7560 and 7570

Rose Trim N/C

Escutcheon trim Add 104.00

HiTower® MOD

Source ZS (see previous page). **Special order, no returns, no cancellation**
SDC supplied - Schlage L mortise lock and electric frame actuator, **less lever trim**

SOURCE/FUNCTION

ZS7530	Schlage	Failsafe, locked both sides	POA
ZS7550	Schlage	Failsafe, locked outside only	POA

HiTower® MOD

Sources A, D, I, N, O, P, S, T (see previous page)
Distributor supplied - Major brand mechanical lock for modification, SDC supplied Electric frame actuator

SOURCE/FUNCTION

A, D, H, I, N, P, S, T, U, V	7530	Failsafe, locked both sides	497.00
A, D, H, I, N, O, P, S, T, U, V	7550	Failsafe, locked outside only	461.00
S7560		Failsecure, locked both sides (5.75" Strike plate)	647.00
S7570		Failsecure, locked outside only (5.75" Strike plate)	637.00

Extra Narrow Failsafe Frame Actuator 125.00

(Actuator type D, E, F only page XX) For 1-1/4" to 1-1/2" frames. Special strike prep required.

Not available with failsecure 7560 and 7570

HiTower® MOD

Source R (see previous page)
Distributor supplied - Schlage L9080 mechanical lock for modification. SDC supplied Electric frame actuator

SOURCE/FUNCTION

R7530	(Replaces 5000 series)	Failsafe, locked both sides	549.00
R7550	(Replaces 5000 series)	Failsafe, locked outside only	518.00

OPTIONS AND ACCESSORIES

Add to List

Lock status and wire harness

L	Latch status switch, SPDT, 5 Amps @ 30VDC	63.00
S	Latch and deadlock status, 3 Amps @ 30VDC	104.00
SC-10	Socket connectors with 10 ft. cable, power wiring only	63.00
SC-10-5	Socket connectors with 10 ft. cable for power and options	80.00

Electrical back boxes for frame actuators with conduit knockouts:
(Recommended for new construction)

7500EB-S	For standard actuator in 1-3/4" or 2" face frame	32.00
7500EB-N	For narrow actuator in 1-1/4" or 1-1/2" face frame	32.00

Optional Key Cylinders

CYL-6KDKQ	6 pin, 1.125" keyed different, 626 Dull Chrome	32.00
CYL-6KAQ	6 pin, 1.125" keyed alike, 626 Dull Chrome	32.00



Special Strikes

SSP	Special retrofit strike plate	125.00
-----	-------------------------------	--------

Specify extended lip strike in writing

POA



Panic & Fire Rated Exit Devices ANSI / BHMA Grade 1

SDC S6000 Spectra™ Series panic and fire rated exit devices are available in rim mount, mortise and surface vertical rod configurations. Spectra Class mechanical exit devices are UL listed and ANSI A156.3 Grade 1 compliant and comply with all national and state building and fire life safety codes.

- ANSI/BHMA A156.3-2001 Grade 1 Compliant
- Meets/Exceeds ADA requirements
- CA Title 19 Compliant
- UBC 97, Standard 7.2

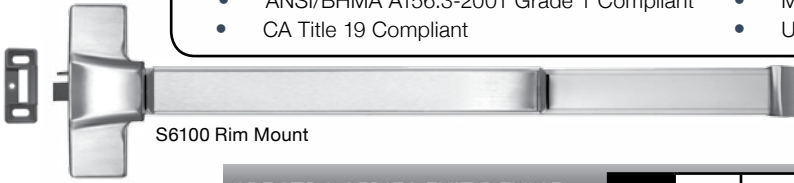

S6100 Rim Mount

SPECTRA SERIES EXIT DEVICE LIST

S61	Rim mount exit device	621.00
S62	Surface vertical	932.00

SPECIFY FUNCTION

01	Exit Only, No Trim	N/C
02	Dummy Pull or Lever (opens when dogged)	N/C
03	Entrance by trim when latch is released by key	N/C
08	Lever with key locks/unlocks lever	N/C
14	Lever trim always active	N/C

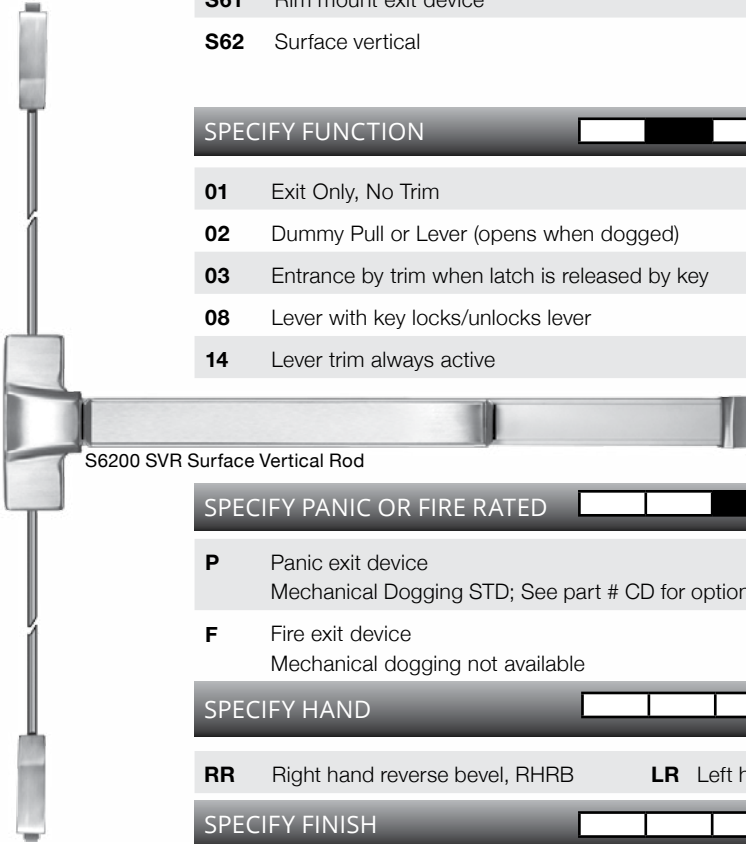

S6200 SVR Surface Vertical Rod

SPECIFY PANIC OR FIRE RATED Add to List

P	Panic exit device Mechanical Dogging STD; See part # CD for optional key cylinder dogging	N/C
F	Fire exit device Mechanical dogging not available	114.00

SPECIFY HAND

RR	Right hand reverse bevel, RHRB	LR	Left hand reverse bevel, LHRB	N/C
-----------	--------------------------------	-----------	-------------------------------	------------

SPECIFY FINISH Add to List

U	630 Dull Stainless Steel	N/C
----------	--------------------------	------------

SPECIFY LENGTH Add to List

36	For 36" Door N/C	42	For 42" Door 21.00	48	For 48" Door 42.00
-----------	-------------------------	-----------	---------------------------	-----------	---------------------------

SPECIFY OPTIONS Add to List

R	Request-To-Exit Output, SPDT	83.00	L	Latch Status Output, SPDT	83.00
----------	------------------------------	--------------	----------	---------------------------	--------------

For 62 Series devices only:

LBR	Less Bottom Rod, for Panic Devices	N/C	LBRF	Less Bottom Rod, for Fire Rated devices	N/C
------------	------------------------------------	------------	-------------	---	------------

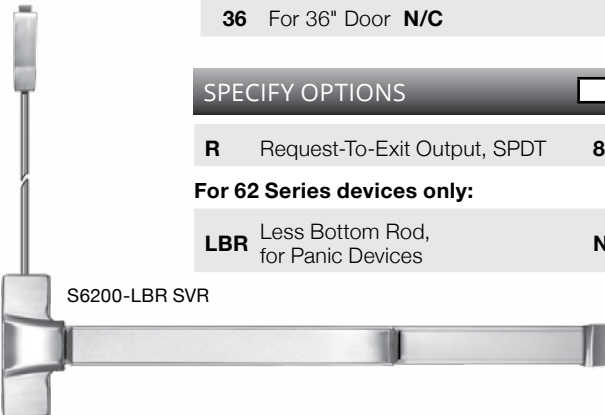

S6200-LBR SVR

Device Trim

Distributor Discount Code **XK**



EK Eclipse

Standard Active and Dummy Trim

SPECIFY TRIM RIM AND VERTICAL ROD



Add to List

Standard Trim

EK Eclipse	GK Galaxy	233.00
SP Saturn		104.00



GK Galaxy

SPECIFY TRIM FUNCTION



Add to List

Dummy Trim	EK02, GK02, SP02	N/C
Key Retracts Latchbolt	EK03, GK03, SP03	N/C
Key Locks/Unlocks Lever	EK08, GK08	N/C
No Cylinder Lever Always Active	EK14, GK14	N/C



SP Saturn

SPECIFY TRIM FINISH



Add to List

U 630 Dull Stainless Steel	N/C
-----------------------------------	------------

OPTIONS



Add to List

CD	Rim cylinder required for 03 functions Keyed dogging (Specify key option cylinder separately) (not available with (F) fire exit device)	1 key cylinder required for CD	Mortise cylinder required for 08 functions and GKE03, EKE03	21.00
-----------	--	--------------------------------	---	--------------

CYL-6KDQ	6 pin, 1.125" mortise cylinder, keyed different, dull chrome, incl. straight and clover cam	32.00
-----------------	---	--------------

CYL-6KAQ	6 pin, 1.125" mortise cylinder, keyed alike, dull chrome, incl. straight and clover cam	32.00
-----------------	---	--------------

RIM-CYL-KA	6-pin Rim Cylinder, Keyed Alike, Specially for 03 Function Specifically For Trim EK03, GK03 and SP03	34.00
-------------------	--	--------------



ELECTRIC TRIM OPTIONS FOR SDC 6000 SERIES

Add to List

FEATURES

- Failsecure, field reversible to failsafe
- 4 ft cable and connectors
- 600/300 mA @ 12/24VDC

EKE03 Eclipse style electric trim less mortise cylinder, Stainless Steel Finish	699.00
--	---------------

GKE03 Galaxy style electric trim less mortise cylinder, Stainless Steel Finish	699.00
---	---------------

Electric Trim Options

LS Locked/unlocked status, SPDT 3 Amp contact	83.00
--	--------------



EKE Eclipse



GKE Galaxy

Optinal Door Strikes

LIST



ST2DF 50.00

Optional for pairs of doors with rim mount device.

Projection: 1-15/16" (49mm)



ST1MP
For 6100P



ST1MF
For 6100F

Projection: 7/8" (22.5mm)

71.00

Optional for mullion application

Removable Mullion

LIST



KR90F 673.00

Standard Key Removable Mullion

For Panic Exit and Fire Exit Rim Mount Devices

Length: 8ft

Material: 2" 11 Gauge Steel Tube

Finish: Primer gray

Price List Effective February 1, 2017

SDC SECURITY DOOR CONTROLS
801 Avenida Acaso • Camarillo, CA 93012
Email: Service@sdsecurity.com • www.sdsecurity.com



Exit Devices

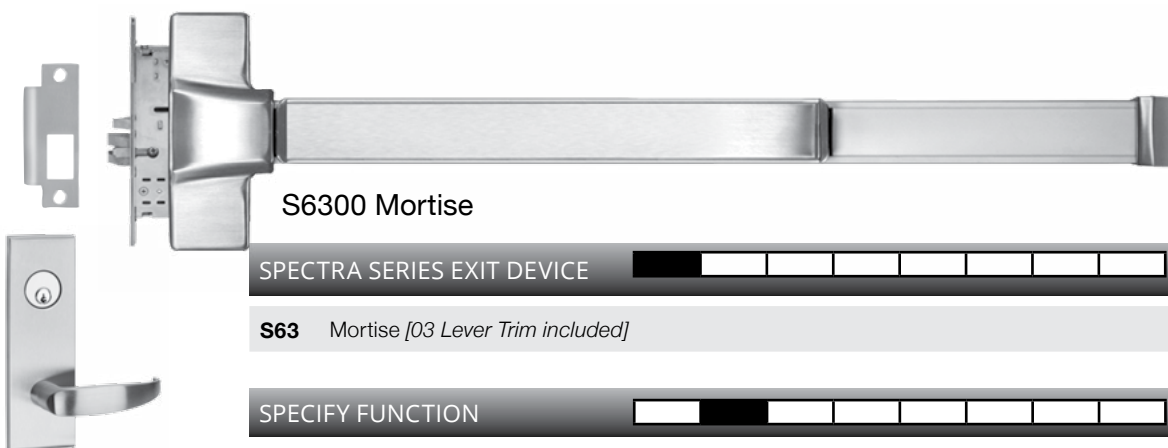

S6300 Mortise

SPECTRA SERIES EXIT DEVICE LIST

S63 Mortise [03 Lever Trim included] **1139.00**

SPECIFY FUNCTION

- 01** Exit Only, No Trim **N/C**
- 02** Dummy Pull or Lever (opens when dogged) **N/C**
- 03** Entrance by trim when latch is released by key **N/C**
- 08** Lever with key locks/unlocks lever **N/C**
- 14** Lever trim always active **N/C**

SPECIFY PANIC OR FIRE RATED Add to List

- P** Panic exit device **N/C**
Mechanical Dogging STD; See part # CD for optional key cylinder dogging
- F** Fire exit device **114.00**
Mechanical dogging not available

SPECIFY HAND

RR Right hand reverse bevel, RHRB **LR** Left hand reverse bevel, LHRB **N/C**

SPECIFY FINISH Add to List

U 630 Dull Stainless Steel **N/C**

SPECIFY LENGTH Add to List

36 For 36" Door **N/C** **42** For 42" Door **21.00** **48** For 48" Door **42.00**

SPECIFY TRIM

EE Eclipse Escutcheon **GE** Galaxy Escutcheon **N/C**

TRIM CYLINDER OPTIONS Add to List

- CD** Keyed dogging (Specify key cylinder separately) (not available with (F) fire exit device) **21.00**
- CYL-6KDQ** 6 pin, 1.125" mortise cylinder, keyed different, dull chrome **32.00**
- CYL-6KAQ** 6 pin, 1.125" mortise cylinder, keyed alike, dull chrome **32.00**

SPECIFY OPTIONS Add to List

R Request-To-Exit Output, SPDT **83.00** **L** Latch Status Output, SPDT **83.00**



SECURITY DOOR CONTROLS

801 Avenida Acaso • Camarillo, CA 93012

Email: Service@sdsecurity.com • www.sdsecurity.com

Price List Effective February 1, 2017

Exit Device - Electrified Mortise

Distributor Discount Code **XK**



Remains latched when unlocked for fire door integrity. Failsafe (F) fire rated device for stairwell doors, power loss or signal from fire command center releases failsafe device immediately. Complies with national building and fire codes

Voltage: 12/24VDC @ 600/300 mA



SPECIFY DEVICE LIST

S63 Mortise [03 Lever Trim included] - specify: **EE/GE** Eclipse Escutcheon/Galaxy Escutcheon **1139.00**

SPECIFY FUNCTION Add to List

01 Exit Only **03** Nightlatch **N/C**

SPECIFY PANIC OR FIRE RATED

P Panic **N/C** **F** Fire **114.00**

SPECIFY HAND (Mortise Only)

RR Right hand reverse bevel, RHRB **LR** Left hand reverse bevel, LHRB **N/C**

SPECIFY FINISH

U 630 Dull Stainless Steel **N/C**

SPECIFY LENGTH

36 For 36" Door **N/C** **42** For 42" Door **21.00** **48** For 48" Door **42.00**

SPECIFY TRIM

EE Eclipse Escutcheon **GE** Galaxy Escutcheon **N/C**



TRIM OPTIONS Add to List

- CYL-6KDKQ** 6 pin, 1.125" mortise cylinder, keyed different, dull chrome **32.00**
- CYL-6KAQ** 6 pin, 1.125" mortise cylinder, keyed alike, dull chrome **32.00**

SPECIFY FAILSAFE OR FAILSECURE

MF Failsafe Electric Mortise Exit Device **207.00**
MS Failsecure Electric Mortise Exit Device **207.00**

SPECIFY OPTIONS LIST

- D** Door Position, MC-4 Door Contact **52.00**
- L** Latch Position Status Output **83.00**
- R** Request-To-Exit Output **83.00**



PTM Series



PTH x 5 Ft Cable

SPECIFY POWER TRANSFER (For the entire line of Power Transfer, see page 84 and page 85) LIST

- PTM-2AL** Two (2) Conductor Power Transfer Device: Two (2) 18 Ga. wires 5 Amp @ 12/24V AC/DV, Aluminum Powder Coat, US28 equivalent **371.00**
- PTH-4Q** Four (4) Conductor Power Transfer Hinge 1 Amp @ 12/24V per pair, 4.5" x 4.5" standard weight, 626 Dull Chrome **156.00**



600 Series Power Supply 602RF (shown)

SPECIFY POWER SUPPLY (For the entire line of Power Supplies, see page 86) LIST

- 602RF** 1 Amp, class 2 output, 12" W x 12" H x 3.75" D box **270.00**
- 631RF** 1.5 Amp, class 2 output, 12" W x 12" H x 3.75" D box **363.00**

Price List Effective February 1, 2017

SECURITY DOOR CONTROLS
 801 Avenida Acaso • Camarillo, CA 93012
 Email: Service@sdsecurity.com • www.sdsecurity.com



Exit Devices

RIM DEVICES STANDARD STRIKES

SURFACE / Standard VERTICAL ROD DEVICES Strike

Rim Strikes List



ST1P
Standard for S6100P
Projection: 13/16" (21mm)



ST1F
Standard for S6100F
Projection: 13/16" (21mm)

Optional Mullion Strike List



Optional for mullion application

ST1MP **ST1MF** **71.00**
For 6100P For 6100F
Projection: 7/8" (22.5mm)

MORTISE STRIKE List



For use on 1-3/4" standard or 2-1/4" thick single door, and 2-1/4" double door with overlapping astragal and coordinator

ST3F **ST3P**
Standard for S6300F Standard for S6300P

Top Strikes List

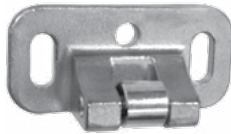

ST2P
Standard top strike for S6200P
Projection: 29/32" (23mm)

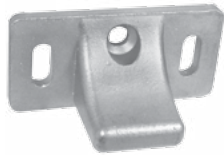

ST2F
Standard top strike for S6200F
Projection: 1-1/8" (29mm)

Bottom (Floor) Strikes List



ST28P
Standard floor strike for S6200P

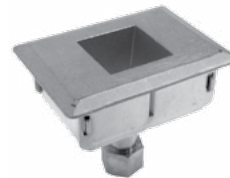

ST28F
Standard floor strike for S6200F
Mortise: 2-1/4" (57mm)

Optional Threshold Strikes List



ST28T **15.00**
Optional floor strike for using threshold openings
Projection: 3/8" (9.5mm)

OPTIONAL DOUBLE DOOR STRIKE List



ST2DF **50.00**
Optional for pairs of doors with rim mount device.
Projection: 1-15/16" (49mm)

REMOVABLE MULLION List



KR90F **673.00**
Standard Key Removable Mullion Less Key Cylinder
For Panic Exit and Fire Exit Rim Mount Devices.
Length: 8ft
Material: 2" 11 Gauge Steel Tube
Finish: Primer gray

OPTIONAL CYLINDER List

RIM-CYL-KA **34.00**
Rim Cylinder, keyed alike
- see page 37 for more info



SDC Factory Installed Kits are UL Listed and Field Retrofit Kits are UL Classified
 For use with 3Hr fire rated and non-fire rated mechanical exit devices.
 Only 700mA inrush / 200mA continuous @ 24VDC provides simultaneous latch retraction,
 dogging with pushpad depression unless specified otherwise.

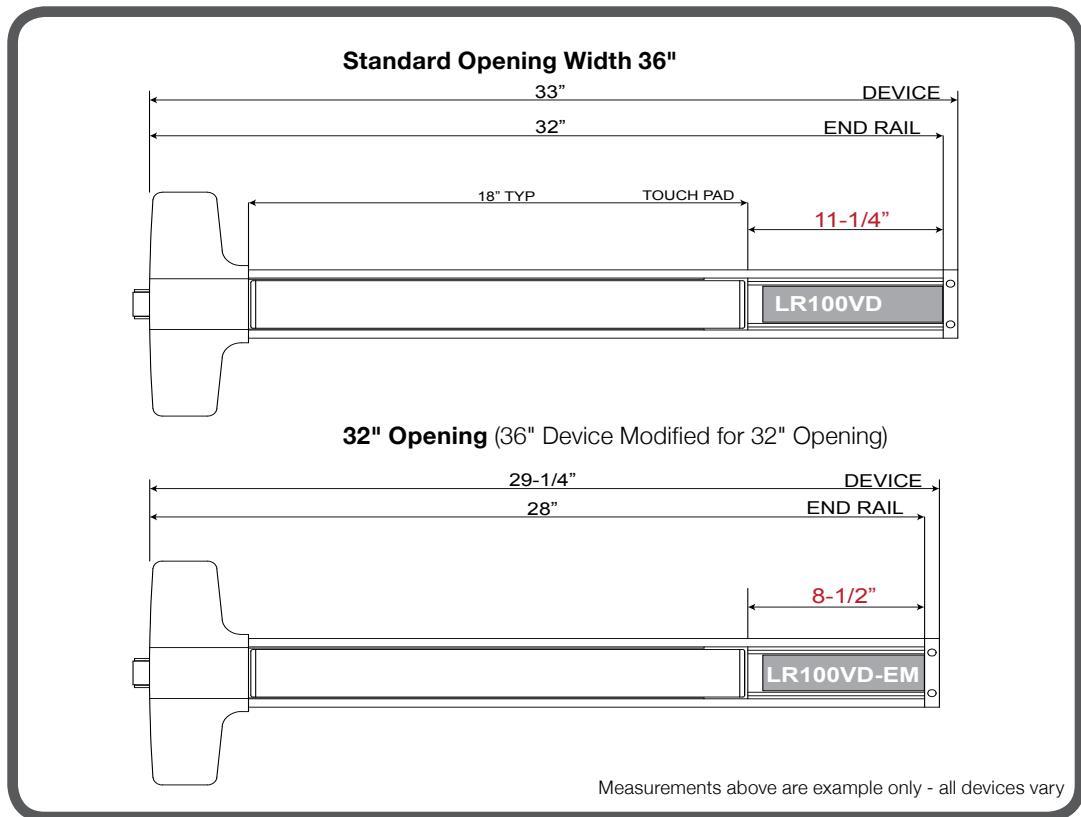
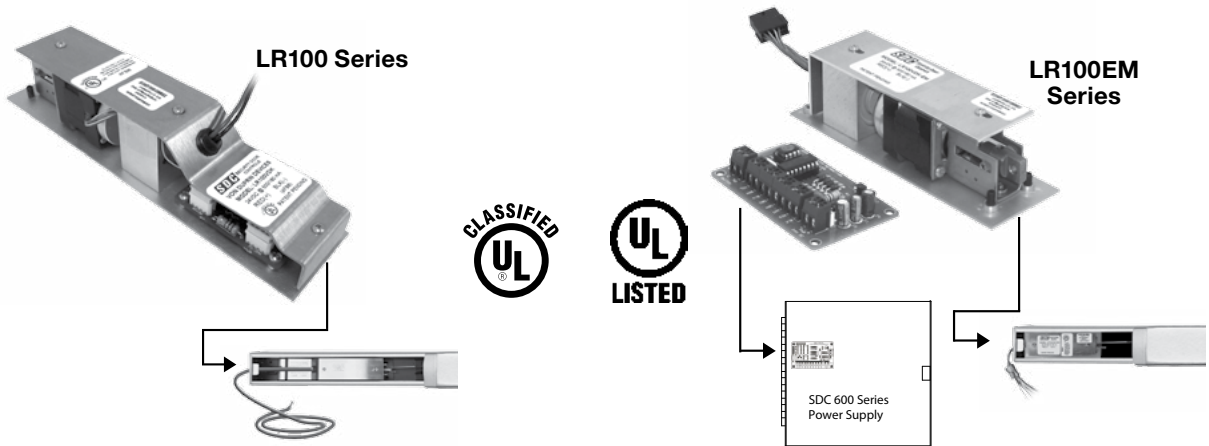
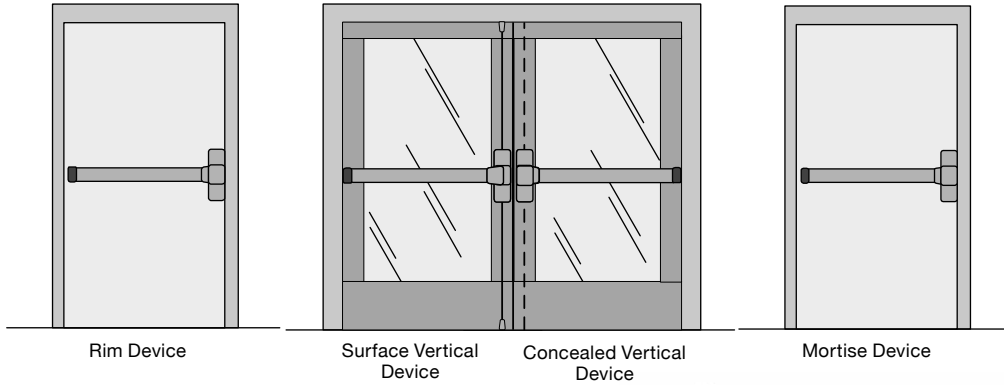

Price List Effective February 1, 2017

SDC SECURITY DOOR CONTROLS
 801 Avenida Acaso • Camarillo, CA 93012
 Email: Service@sdsecurity.com • www.sdsecurity.com



Exit Devices

QUIET DUO™ LR100: Product Compatibility

Adams Rite Exit Device				
Opening for	Field Retrofit Kit	LIST	Factory Installed	LIST
36" - 48"	LR100ARK	625.00	LR100AR	675.00
30"	LR100ARK-EM	675.00	LR100AR-EM	725.00

Models

Rim Mount	8700 ‡ / 8800 / 3700
Surface Vertical Rod	8100 / 8200 / 3100
Concealed Vertical Rod	8500 / 8600 / 3600

Options

LRAR1R	REX Status Kit	104.00
--------	----------------	--------

* Note: Retracts only the latch ‡ use with EM version ONLY

Arrow 1000 Series Exit Devices				
Opening for	Field Retrofit Kit	LIST	Factory Installed	LIST
36" - 48"	LR100AWK	625.00	LR100AW	675.00

Models

Rim Mount	S1250
Surface Vertical Rod	S1150

Opening for	Field Retrofit Kit	LIST	Factory Installed	LIST
36"	LR100AWK-ED910	625.00	LR100AW-ED910	675.00

Models

Rim Mount	ED910
-----------	-------

Cal-Royal Exit Devices				
Opening for	Field Retrofit Kit	LIST	Factory Installed	LIST
36"	LR100CAK	625.00	LR100CA	675.00

Models

Rim Mount	7700 / F7700
Surface Vertical Rod	7760 / F7760

Opening for	Field Retrofit Kit	LIST	Factory Installed	LIST
36"	LR100CAK-9800	625.00	LR100CA-9800	675.00

Models

Rim Mount	GLS9800
Concealed Vertical Rod	GLSCVR9800

Opening for	Field Retrofit Kit	LIST	Factory Installed	LIST
36"	LR100CAK-EM	675.00	LR100CA-EM	725.00

Models

Rim Mount	2200 / F2200 / 9800 / F9800
Surface Vertical Rod	2260 / F2260 / 9860 / F9860

Corbin Russwin ED Series Exit Devices				
Opening for	Field Retrofit Kit	LIST	Factory Installed	LIST
36"	LR100CRK	625.00	LR100CR	675.00
30"	LR100CRK-EM	675.00	LR100CR-EM	725.00
42" - 48"	LR100CRK-42/48	625.00	LR100CR-42/48	675.00

Models

Rim Mount	ED5200 / ED4200
Surface Vertical Rod	ED5400
Concealed Vertical Rod	ED4800 / ED5800

Options

LRCR1L	Latch Status Kit	104.00
LRCR1R	REX Status Kit	104.00

Design Hardware Exit Devices				
Opening for	Field Retrofit Kit	LIST	Factory Installed	LIST
36"	LR100DHK	625.00	LR100DH	675.00

Models

Rim Mount	1000R
Surface Vertical Rod	1000V

Detex Exit Device				
Opening for	Field Retrofit Kit	LIST	Factory Installed	LIST
36"	LR100DXK	625.00	LR100DX	675.00

Models

Rim Mount	10 / 40 Series
Surface Vertical Rod	20 / 50 Series
Concealed Vertical Rod	80 / 81 / 62 / 63 Series

Options

LRDX1R	REX Status Kit	104.00
--------	----------------	--------

Dorma Exit Devices				
Opening for	Field Retrofit Kit	LIST	Factory Installed	LIST
36"	LR100DAK	625.00	LR100DA	675.00

Models

Rim Mount	9300 / F9300
Surface Vertical Rod	9400 / F9400

Falcon 24/25 Series Exit Devices				
Opening for	Field Retrofit Kit	LIST	Factory Installed	LIST
36"	LR100FRK	625.00	LR100FR	675.00

Models

Rim Mount	25-R / F-25-R / 24-R / F-24-R
Surface Vertical Rod	25-V / F-25-V / 24-V / F-24-V
Concealed Vertical Rod	25-C / F-25-C / 24-C / F-24-C

QUIET DUO™ LR100: Product Compatibility

Falcon Dor-O-Matic		Exit Devices		** 1A Inrush
Opening for	Field Retrofit Kit	LIST	Factory Installed	LIST
36"	LR100FAK**	625.00	LR100FA**	675.00
30"	LR100FAK-EM**	675.00	LR100FA-EM**	725.00
Models				
Rim Mount		1790		
Concealed Vertical Rod		1690		
Opening for	Field Retrofit Kit	LIST	Factory Installed	LIST
36"	LR100DMK	625.00	LR100DM	675.00
Models				
Rim Mount		1590		
Concealed Vertical Rod		1490		

First Choice		Exit Devices		** 1A Inrush
Opening for	Field Retrofit Kit	LIST	Factory Installed	LIST
36"	LR100FCK**	625.00	LR100FC**	675.00
30"	LR100FCK-EM**	675.00	LR100FC-EM**	725.00
Models				
Rim Mount		3700		
Concealed Vertical Rod		3600		

Hager		4500 Series Exit Devices		
Opening for	Field Retrofit Kit	LIST	Factory Installed	LIST
36"- 48"	LR100HK	625.00	LR100H	675.00
30"	LR100HK-EM	675.00	LR100H-EM	725.00
Models				
Rim Mount		4501 - Rim		
Surface Vertical Rod		4501 - SVR		
Options				
LRH1L	Latch Status Kit		104.00	
LRH1R	Pushpad/Dogging Status or REX Status Kit		104.00	

Jackson		2000 Series Exit Devices		** 1A Inrush
Opening for	Field Retrofit Kit	LIST	Factory Installed	LIST
36"	LR100JAK**	750.00	LR100JA**	675.00
Models				
Rim Mount		2095		
Concealed Vertical Rod (Top Latch)		2085		
Concealed Vertical Rod (Top Bolt)		2086		

IDC (International Door Closers)		8000 Series Exit Devices		
Opening for	Field Retrofit Kit	LIST	Factory Installed	LIST
36"- 48"	LR100IDCK	625.00	LR100IDC	675.00
30"	LR100IDCK-EM	675.00	LR100IDC-EM	725.00
Models				
Rim Mount		8610 / 8810 / 8510 / 8710		
Surface Vertical Rod		8630 / 8830 / 8530 / 8730		
Mortise		8620 / 8820		
Concealed Vertical Rod		8650 / 8850 / 8550 / 8750		
Options				
LRIDC1L	Latch Status Kit		104.00	
LRIDC1R	Pushpad/Dogging Status or REX Status Kit		104.00	

Marks		Exit Devices		
Opening for	Field Retrofit Kit	LIST	Factory Installed	LIST
36"	LR100MDK	625.00	LR100MD	675.00
Models				
Rim Mount		M9900		
Surface Vertical Rod		M9900VR		

Marshall Best		Exit Devices		
Opening for	Field Retrofit Kit	LIST	Factory Installed	LIST
36"	LR100MBSK	625.00	LR100MBS	675.00
30"	LR100MBSK-EM	675.00	LR100MBS-EM	725.00
Models				
Rim Mount		Q1100/QF1100		
Surface Vertical Rod		Q1200/QF1200		

Pamex		Exit Devices		
Opening for	Field Retrofit Kit	LIST	Factory Installed	LIST
36"- 48"	LR100PAK	625.00	LR100PA	675.00
30"	LR100PAK-EM	675.00	LR100PA-EM	725.00
Models				
Rim Mount		EF9000		
Surface Vertical Rod		EF9000V		
Concealed Vertical Rod		EF9020V		

PDQ		Exit Devices		
Opening for	Field Retrofit Kit	LIST	Factory Installed	LIST
36" - 48"	LR100PDQK	625.00	LR100PDQ	675.00
Models				
Rim Mount		6200R		
Surface Vertical Rod		6200V		

Parts Provided: 628 Finish Only

Price List Effective February 1, 2017

SECURITY DOOR CONTROLS
801 Avenida Acaso • Camarillo, CA 93012
Email: Service@sdsecurity.com • www.sdsecurity.com



Exit Devices

QUIET DUO™ LR100: Product Compatibility

PHI (Precision Hardware)		Exit Devices		
Opening for	Field Retrofit Kit	LIST	Factory Installed	LIST
36"	LR100PDK	625.00	LR100PD	675.00
Models				
Rim Mount		2100 / 2400		
Surface Vertical Rod		2200 LBR		
Concealed Vertical Rod		2800 LBR / 2600		
Rim Mount		5100		
Surface Vertical Rod		5200 LBR		
Options				
LRP1L	Latch Status Kit for PHI Rim 2000 Series			104.00
LRP2L	Latch Status Kit for PHI Vertical Rod 2000 Series			104.00
LRP1R	REX Status or Pushpad/Dogging Status for PHI 2000 Series			104.00

Sargent		Exit Devices		
Opening for	Field Retrofit Kit	LIST	Factory Installed	LIST
36" - 48"	LR100SGK	625.00	LR100SG	675.00
30"	LR100SGK-EM	675.00	LR100SG-EM	725.00
Models				
Rim Mount		8500 / 8800		
Surface Vertical Rod		8700		
Concealed Vertical Rod		8400 / 8600		
Mortise		8300 / 8900		
Options				
LRS2R	Pushpad/Dogging Status or REX Status Kit			104.00

SDC		6000 Series Exit Devices		
Opening for	Field Retrofit Kit	LIST	Factory Installed	LIST
36"-48"	LR100SDCK	625.00	LR100SDC	675.00
30"	LR100SDCK-EM	675.00	LR100SDC-EM	725.00
Models				
Rim Mount		S6100		
Surface Vertical Rod		S6200		
Mortise		S6300		
Concealed Vertical Rod		S6800		
Options				
LRSDC1L	Latch Status Kit			104.00
LRSDC1R	Pushpad/Dogging Status or REX Status Kit			104.00

Stanley K2		QED Series Exit Devices		
Opening for	Field Retrofit Kit	LIST	Factory Installed	LIST
36" - 48"	LR100K2K	625.00	LR100K2	675.00
30"	LR100K2K-EM	675.00	LR100K2-EM	725.00
Models				
Rim Mount		QED111		
Surface Vertical Rod		QED114		
Concealed Vertical Rod		QED124		
Options				
LRK2R	Latch Status and REX Status or Pushpad/Dogging Status Kit			104.00

Tell		Exit Devices		
Opening for	Field Retrofit Kit	LIST	Factory Installed	LIST
36"	LR100TEK	625.00	LR100TE	675.00
Models				
Rim Mount		9500		
Surface Vertical Rod		9400		

TownSteel		ED1100 Series Exit Devices		
Opening for	Field Retrofit Kit	LIST	Factory Installed	LIST
36"	LR100TSK	625.00	LR100TS	675.00
30"	LR100TSK-EM	675.00	LR100TS-EM	725.00
Models				
Rim Mount		ED1100		
Surface Vertical Rod		ED1200		
Concealed Vertical Rod		ED1300		
Options				
LRTS1R	REX Status or Pushpad/Dogging Status Kit			104.00

Opening for	Field Retrofit Kit	LIST	Factory Installed	LIST
36"	LR100TSK-55/56	675.00	LR100TS-55/56	725.00
Models				
Rim Mount		ED5500		
Surface Vertical Rod		ED5600		
Options				
LRTS2R	REX Status or Pushpad/Dogging Status Kit for ED5500			104.00
Options				
Opening for	Field Retrofit Kit	LIST	Factory Installed	LIST
36"	LR100TSK-65/67	675.00	LR100TS-65/67	725.00
Models				
Rim Mount		ED6500		
Concealed Vertical Rod		ED6700		

QUIET DUO™ LR100: Product Compatibility

Von Duprin 98/99 and 33/35 Series Exit Devices				
Opening for	Field Retrofit Kit	LIST	Factory Installed	LIST
36" - 48"	LR100VDK	625.00	LR100VD	675.00
30"	LR100VDK-EM	675.00	LR100VD-EM	725.00
Models				
Rim Mount		98 / 99	33A / 35A	
Surface Vertical Rod		9827 / 9927	3327A / 3527A	
Concealed Vertical Rod		9847 / 9947	3347A / 3547A	
Mortise		9875 / 9975		
Three Point latching		9857 / 9957		
Options				
LRVD1L	Latch Status Kit for Von Duprin 98/99 Series			104.00
LRVD2L	Latch Status Kit for Von Duprin 33/35 Series			104.00
LRVD1R	REX Status or Pushpad/Dogging Status Kit for Von Duprin 98/99 and Von Duprin 33/35 Series			104.00

Von Duprin 22 Series Exit Devices				
Opening for	Field Retrofit Kit	LIST	Factory Installed	LIST
36" - 48"	LR100VDK-22	625.00	LR100VD-22	675.00
30"	LR100VDK-22-EM	675.00	LR100VD-22-EM	725.00
Models				
Rim Mount		22		
Surface Vertical Rod		2227		
Options				
LRVD1L	Latch Status Kit			104.00
LRVD2R	REX Status or Pushpad/Dogging Status Kit			104.00

Yale 7000 Series Exit Devices				
Opening for	Field Retrofit Kit	LIST	Factory Installed	LIST
36"	LR100YDK	625.00	LR100YD	675.00
30"	LR100YDK-EM	675.00	LR100YD-EM	725.00
42" - 48"	LR100YDK-42/48	625.00	LR100YD-42/48-EM	675.00
Models				
Rim Mount		7100 / 7100-2 / 7200		
Surface Vertical Rod		7110 / 7210		
Concealed Vertical Rod		7120 / 7220		
Options				
LR1Y1L	Latch Status Kit			104.00
LR1Y1R	REX Status Kit			104.00

* Note: Retracts only the latch

Note: Please check SDCsecurity.com regularly for new releases in this product line



602RF
see page 39



PTH-4Q
see page 39



PTM
see page 39



400NU-L2
see page 39

ACCESSORIES

		List
602RF	1 Amp Power Supply, UL Listed 294, for 1 or 2 exit devices	270.00
632RF	2 Amp Power Supply, UL Listed 294 for 3 or 4 exit devices	414.00
EMC	2 Station Automatic Door Sequence; Each EMC provides interface and sequencing for two single or one double automatic door.	156.00
PTH-4Q	4-wire Electric Hinge, 1 Amp max. UL 10B	156.00
PTH-4QDPS	4-wire, Electric Hinge 1 Amp max. UL 10B. With concealed Door Status Contact	207.00
PTH-2+4Q	6-wire Electric Hinge 1-pair 16 Amp inrush, 4 Amp continuous; 2-pair 1 Amp @ 12/24V	182.00
PTH-10Q	Ten (10) Conductor Power Transfer Hinge, 1 Amp @ 12/24V per pair	202.00
PT-5	Concealed mortise power transfer device, UL 10B Fire Door Accessory	63.00
PT-3V	Stainless steel door loop with surface wire junction	47.00
PTM-2AL	Two (2) Conductor Power Transfer Device: Two (2) 18 Ga. wires 5 Amp @ 12/24V AC/DC, Aluminum Powder Coat, US28 equivalent	371.00
PTM-2BZ	Two (2) Conductor Power Transfer Device: Two (2) 18 Ga. wires 5 Amp @ 12/24V AC/DC, Dark Brown Powder Coat, US10B equivalent	371.00
PTM-10AL	Ten (10) Conductor Power Transfer Device: Ten (10) 24 Ga. wire 1 Amp @ 12/24V AC/DC, Aluminum Powder Coat, US28 equivalent	371.00
PTM-10BZ	Ten (10) Conductor Power Transfer Device: Ten (10) 24 Ga. wire 1 Amp @ 12/24V AC/DC, Dark Brown Powder Coat, US10B equivalent	371.00
400U-L2	Two LEDs. Specify lens color. Standard Finish, on 1 Gang plate	47.00
400NU-L2	Two LEDs. Specify lens color. Standard Finish, on narrow plate	47.00

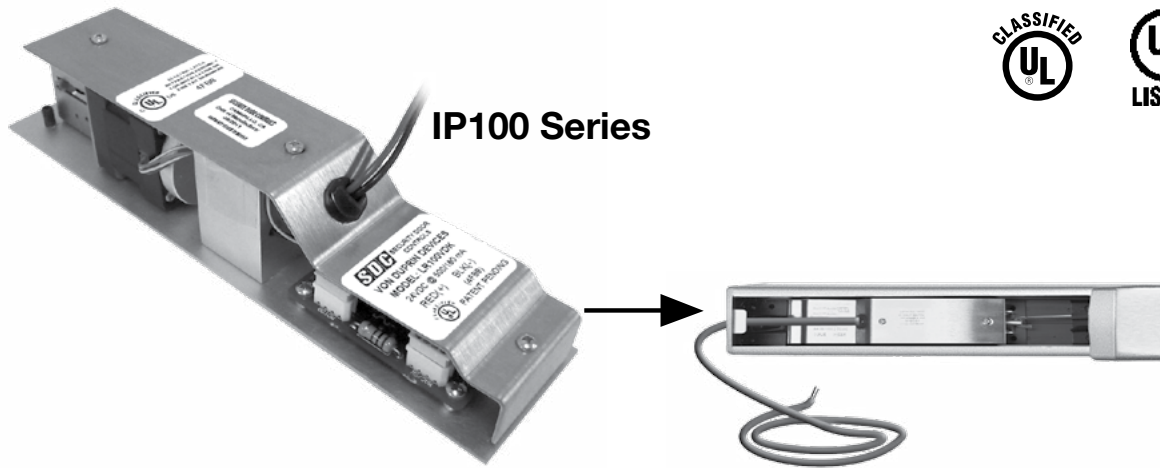

SDCs IP100 Power over Ethernet Capable Electric Latch Retraction Kit enables electric access control and dogging of mechanical exit devices. When energized the motor retracts the exit device latch and pulls the pushpad into the dogged (depressed)* position enabling momentary or sustained push and pull operation of the door. 12VDR @ 700/110 mA
The latch retraction mechanism may be activated by an access control, remote control device or building automation system. The exit device always provides uninhibited egress.

* Except where noted for latch retraction only

Adams Rite		Exit Device		
Opening for	Field Retrofit Kit	LIST	Factory Installed	LIST
36"	IP100ARK	625.00	IP100AR	675.00
Models				
Rim Mount		8700 / 8800 / 3700		

* Note: Retracts only the latch

Falcon		24/25 Series Exit Devices		
Opening for	Field Retrofit Kit	LIST	Factory Installed	LIST
36"	IP100FRK	625.00	IP100FR	675.00
Models				
Rim Mount		25-R / F-25-R / 24-R / F-24-R		

Corbin Russwin		ED Series Exit Devices		
Opening for	Field Retrofit Kit	LIST	Factory Installed	LIST
36"	IP100CRK	625.00	IP100CR	675.00
Models				
Rim Mount		ED5200 / ED4200		
Options				
LRCR1L	Latch Status Kit		104.00	
LRCR1R	REX Status Kit		104.00	

* Note: Retracts only the latch

Hager		4500 Series Exit Devices		
Opening for	Field Retrofit Kit	LIST	Factory Installed	LIST
36" - 48"	IP100HK	625.00	IP100H	675.00
Models				
Rim Mount		4501 - Rim		
Surface Vertical Rod		4501 - SVR		
Options				
LRH1L	Latch Status Kit		104.00	
LRH1R	Pushpad/Dogging Status or REX Status Kit		104.00	

SDC 6000 Series Exit Devices				
Opening for	Field Retrofit Kit	LIST	Factory Installed	LIST
36"-48"	IP100SDCK	625.00	IP100SDC	675.00
Models				
Rim Mount		S6100		
Surface Vertical Rod		S6200		
Options				
LRSDC1L	Latch Status Kit			104.00
LRSDC1R	Pushpad/Dogging Status or REX Status Kit			104.00

Von Duprin 98/99 and 33/35 Series Exit Devices				
Opening for	Field Retrofit Kit	LIST	Factory Installed	LIST
36"	IP100VDK	625.00	IP100VD	675.00
42" - 48"	IP100VDK-42/48	625.00	IP100VD-42/48	675.00
Models				
Rim Mount		98 / 99	33A / 35A	
Surface Vertical Rod		9827 / 9927	3327A / 3527A	
Options				
LRVD1L	Latch Status Kit for Von Duprin 98/99 Series			104.00
LRVD2L	Latch Status Kit for Von Duprin 33/35 Series			104.00
LRVD1R	REX Status or Pushpad/Dogging Status Kit for Von Duprin 98/99 and 33/35 Series			104.00

* Note: Retracts only the latch

Sargent Exit Devices				
Opening for	Field Retrofit Kit	LIST	Factory Installed	LIST
36"- 48"	IP100SGK	625.00	IP100SG	675.00
30"	IP100SGK-EM	675.00	IP100SG-EM	725.00
Models				
Rim Mount		8800		
Surface Vertical Rod		8700		
Options				
LRS1R	REX Status Kit			104.00

* Note: Retracts only the latch

Yale 7000 Series Exit Devices				
Opening for	Field Retrofit Kit	LIST	Factory Installed	LIST
36"	IP100YDK	625.00	IP100YD	675.00
Models				
Rim Mount		7100 / 7102 / 7200		
Options				
LR1L	Latch Status Kit			104.00
LR1R	REX Status Kit			104.00

* Note: Retracts only the latch

Mechanical Release SPACESAVER® Mortise Bolt Locks

Distributor Discount Code **AK LIST**

1091ADMR/1091ADDMR Failsafe: 12/24 VDC @ 0.9/0.45 mA (max)
1291ADMR/1291ADDMR Failsecure: 12/24 VDC @ 0.9/0.45 mA (max)



1091ADMR

1091ADMR	Failsafe, Single Mechanical Release	650.00
1291ADMR	Failsecure, Single Mechanical Release	650.00
1091ADDMR	Failsafe, Double Mechanical Release	850.00
1291ADDMR	Failsecure, Double Mechanical Release	850.00

Mortise Cylinders Not Included, order separately

Standard Finish: **V** 628 Clear Anodized Aluminium

Specialty Lock Applications available by request



1091ADDMR

OPTION Add to List

B	Bolt position sensor, SPDT	57.00
D	Door position sensor, SPDT	57.00

KEY CYLINDER OPTIONS Add to List



CYL-6KDQ	6 pin, 1.125" mortise cylinder, keyed different, dull chrome	32.00
CYL-6KAQ	6 pin, 1.125" mortise cylinder, keyed alike, dull chrome	32.00

Heavy Duty SPACESAVER® Mortise Bolt Locks

Distributor Discount Code **AK LIST**

1190A Failsafe: 0.7Amp @ 24VDC
2090A Failsecure: 2.5 Amp In rush, 0.4 Amp seated @ 24VDC



1190A

1190AU	Failsafe	430.00
2090AU	Failsecure	534.00

Standard Finish: **U** 630 Dull Stainless Steel

Specialty Lock Applications available by request



UL10C Positive Pressure Compliant
UBC Classified in accordance with Uniform Building Code standard 7-2 "Fire Test for Door Assemblies"

OPTION Add to List

B	Bolt position sensor, SPDT	57.00
D	Door position sensor, SPDT	57.00

Price List Effective February 1, 2017

SECURITY DOOR CONTROLS
 801 Avenida Acaso • Camarillo, CA 93012
 Email: Service@sdsecurity.com • www.sdsecurity.com



Electric Bolt Locks

Conventional Mortise Bolt Locks

Distributor Discount Code **AK LIST**

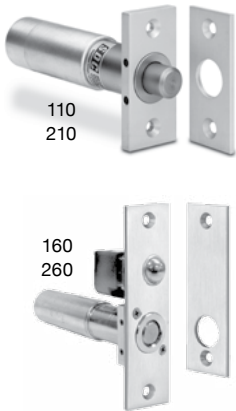

110/160 Dual Voltage Coil: 900/450 mA @ 12/24 VDC
210/260 Dual Voltage Coil: 900/450 mA @ 12/24 VDC
 Mortise strike standard.

5" depth required

110IV	2-3/4" x 1-1/4" Face plate, less auto relock switch, failsafe V 628 Aluminum (standard)	187.00
210HV	2-3/4" x 1-1/4" Face plate, less auto relock switch, failsecure V 628 Aluminum (standard)	187.00
160IV	4-7/8" x 1-1/4" Face plate with auto relock switch, failsafe V 628 Aluminum (standard)	249.00
260HV	4-7/8" x 1-1/4" Face plate with auto relock switch, failsecure V 628 Aluminum (standard)	249.00

SPECIFY ADD-ON Add to List

MC-4	External recessed magnetic (3/4", SPDT, 30VDC, 50mA)	50.00
-------------	--	--------------

Electric Bolt Locks



SECURITY DOOR CONTROLS
 801 Avenida Acaso • Camarillo, CA 93012
 Email: Service@sdccsecurity.com • www.sdccsecurity.com

Surface Mount Bolt Locks

Distributor Discount Code **AK LIST**



Dimensions: 6" L x 2" W x 2" H
180 Dual Voltage Coil: 900/450 mA @ 12/24 VDC
280 Dual Voltage Coil: 900/450 mA @ 12/24 VDC

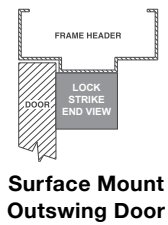

MODEL

180AIV	Surface mount, failsafe, with auto relock, Aluminum standard	270.00
280AHV	Surface mount, failsecure with auto relock, Aluminum standard	270.00

SPECIFY ADD-ON Add to List

D	External recessed magnetic (3/4", SPDT, 30VDC, 50mA) MC-4	50.00
----------	---	--------------

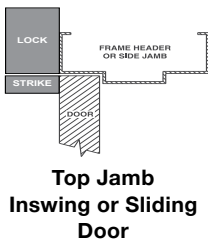

Price List Effective February 1, 2017

Paniclok Exit Device Release

Distributor Discount Code **AK LIST**

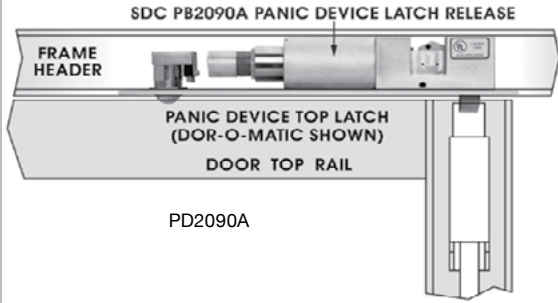

For Dor-O-Matic and Kawneer Exit Device
Voltage: 24VDC, 2.5 A Inrush, .4A seated

MODEL

PD2090ALCU	LH/RHR failsecure	534.00
PD2090ARCU	RH/LHR failsecure	534.00
Standard Finish: U 630 Dull stainless steel		

Price List Effective February 1, 2017

Electric Bolt Locks

Gate Locks

Distributor Discount Code **AK LIST**



GL163A
GL263A

Designed for outdoor installation on swinging or sliding gates, Black Finish. Specify swinging or sliding gate

	12/24VDC 900/450 mA		12/24 VDC 900/450 mA	
GL160AI	Fail-safe	854.00	GL260AH	Fail-secure 854.00
GL163AI	Key switch, fail-safe	916.00	GL263AH	Key switch, fail-secure 916.00
			GL260MRAH	Mechanical key unlock, fail-secure 958.00

Key cylinder not included

SPECIFY HAND - for convenience, field reversible

RH	Right hand	LH	Left hand	N/C
-----------	------------	-----------	-----------	------------

OPTIONS Add to List

D	Gate position sensor SPDT for gate lock (GL series)	83.00
B	Bolt position sensor, SPDT for gate lock	83.00
BR64XL	Rectifier for AC operation	26.00

KEY CYLINDER OPTIONS Add to List

	CYL-6KDQ	6 pin, 1.125" mortise cylinder, keyed different, dull chrome	32.00
	CYL-6KAQ	6 pin, 1.125" mortise cylinder, keyed alike, dull chrome	32.00

REPLACEMENT SOLENOIDS Distributor Discount Code **HK**

Go to <http://sdcsecurity.com/Solenoids> for solenoid replacement information

SECURITY DOOR CONTROLS
 801 Avenida Acaso • Camarillo, CA 93012
 Email: Service@sdcsecurity.com • www.sdcsecurity.com



Programmable Cabinet Lock

Distributor Discount Code **AK LIST**



SDC's 295 Battery Powered Keyless Cabinet Lock provides an easy, economical solution for security and keyless access control for a wide variety of cabinet doors, drawers, storage lockers and more. Quickly and easily add/delete up to 30 individual user PIN codes with programmable keypad. Powered by 2 x AAA batteries, the need for low voltage wiring is eliminated. 2 Programmable Application Modes.

Dimensions: 5.5"H x 1.4"W x 0.85"D - 1.25"D w/Dial (40 x 35.5 x 21.5mm - 32mm w/Dial)

MODEL

295	Programmable cabinet lock	156.00
------------	---------------------------	---------------

Cabinet Lock

Distributor Discount Code **AK LIST**



- For drawers, cabinets or display cases with swinging or sliding doors
- Failsecure (field reversible for failsafe)

Dual Voltage: 12/24VDC @ 250mA/130mA

Dimensions: 3.25" L x 1.125" W x 1.125" D

Finish: Black

MODEL

290	Micro cabinet lock	105.00
290LS	Micro cabinet lock with locked status switch	130.00



SECURITY DOOR CONTROLS
 801 Avenida Acaso • Camarillo, CA 93012
 Email: Service@sdccsecurity.com • www.sdccsecurity.com

Price List Effective February 1, 2017



FEATURES

- Controls one door directly, with multi-door expansion capabilities
- Password protected built-in web server or FREE downloadable 'Grid' software
- Two Ethernet Ports allow for interfacing with additional IP devices like cameras additional door controllers, etc.
- Entry & exit reader capability
- Supports industry standard proximity, smart card, and multi-technology readers (Wiegand output)
- Compliant with PoE+ standard
- 15,000 users (up to 2 credentials per user)
- Internet Explorer, Firefox and Google Chrome browser support
- Batch card enrollment
- 250 User groups/Time Zones/Door Groups
- Audit Trail – Up to 5,000 events may be exported as a .csv file from web server, unlimited events from PC software interface
- Anti-tailgating
- Door Status Monitoring Input
- Request-to-Exit (REX) Input
- Lock Relay Output

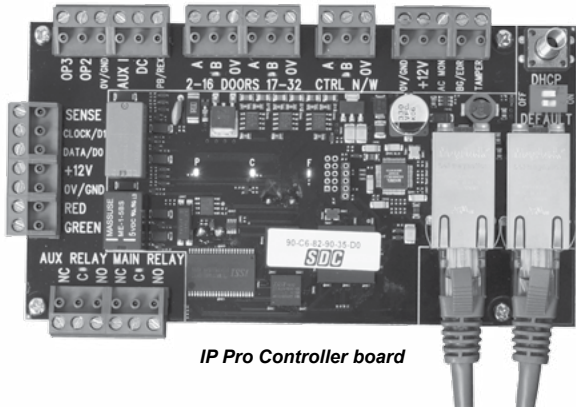

IP Pro Controller board

SPECIFICATIONS

IP Pro Controller/Door Station

Voltage	12 VDC Input
Current Consumption	250mA (max)
Operating Temperature	14°F – 122°F (Indoor use only)
Dimensions	5.375" x 3.5" x 0.875" board only 9.25" x 6.5" x 2.1875" w/ ABS plastic enclosure
Weight	1lb
Relay Output Type	Form C (SPDT) x 2

Relay Contact Rating	Main (Lock) – 5A @ 30VDC Auxiliary – 1A @ 30VDC
Connections	Digital Inputs: 4 dry contact inputs Ethernet: RJ45 RS-485 Terminal Bus Reader Power – 12VDC Reader Data – Wiegand (26bit to 37bit) Reader LED Control – Red & Green Two Solid State outputs (100mA max)

IP Pro Splitter

Input Voltage	44 - 57 VDC
Input Power	30W max
Output Power	24W max
Output Current	2A @ 12V
Relay Output Type	Form C (SPDT) x 2

IP Pro Injector

PoE+ Output Pin Assignment and Polarity	4/5 (+), 7/8 (-)
Output Power Voltage	55VDC
User Port Power	30Watts (Guaranteed)
Input Power	0.8A @ 100-240VAC

Install - Expand - Control

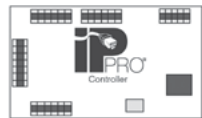

- Embedded software
- Browser Accessible
- 1 to 32 doors

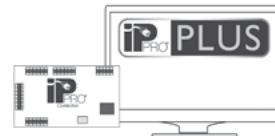

- FREE Access Control Software
- PC Accessible
- 1 to 100 doors

EMBEDDED
software managed
via web browser



or Download FREE
SOFTWARE
for full Grid Access

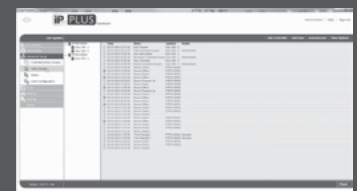

Price List Effective February 1, 2017

SECURITY DOOR CONTROLS
801 Avenida Acaso • Camarillo, CA 93012
Email: Service@sdsecurity.com • www.sdsecurity.com



Access Control

IP Pro™ Components		LIST
IPDCE	IP Pro Controller , board plus enclosure	675.00
IPI-30	IP Pro Injector , 30W PoE+	192.00
IPS-12	IP Pro Splitter , 12VDC PoE+	226.00

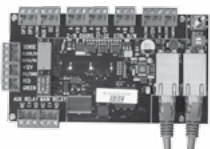

IP Pro Controller board



IP Pro Injector



IP Pro Splitter



IP Pro Controller enclosure

IP Pro™ Door Station		LIST
IPDSE	IP Pro Door Station Expansion , board plus enclosure	575.00

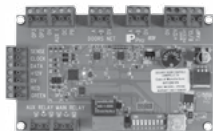

IP Pro Door Station Expansion board

IP Pro™ Starter Kit		LIST
IPPRO-SKE	IP Pro Starter Kit , including Controller board, Splitter, Injector plus Controller enclosure	1116.00
IPPRO-SK	IP Pro Starter Kit , including Controller board, Splitter, Injector	1090.00

Prox Reader		LIST
IPRW	Wiegand Reader - PROX, Surface Mount , HID compatible (125 kHz)	196.00
IPRW300	Wiegand Reader - PROX, Mullion Mount , HID compatible (125 kHz) includes Black and White Cover	196.00
IPRW500	Wiegand Reader - PROX, Single Gang Box or Surface Mount , HID compatible (125 kHz) includes Black and White Cover	225.00



IPRW



IPRW300



IPRW500

CARDS, KEY FOBS and TAGS see page 67

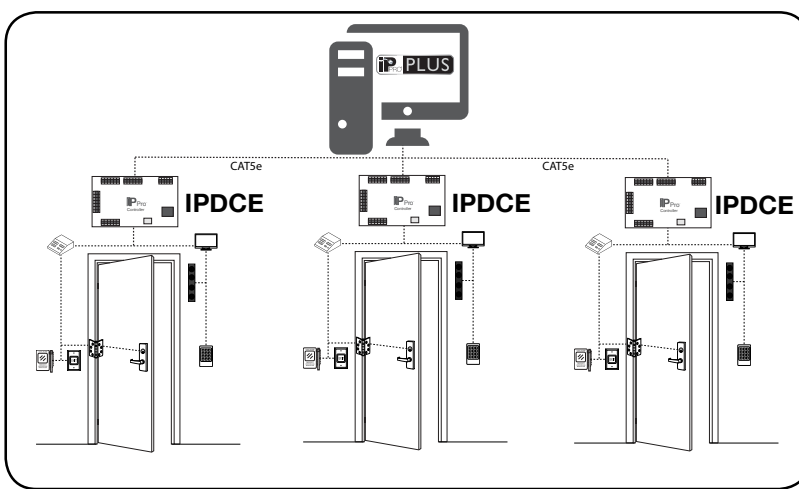
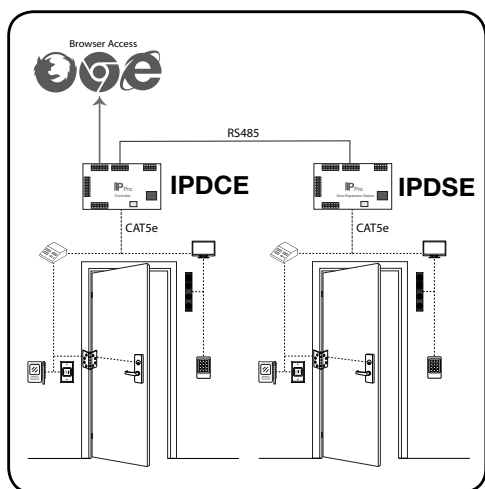

The **IP Pro** Line of IP-based Access Controllers allows expansion from one Standalone door up to a 100-door "Grid." The Choice is yours! **It's like having a local area network for your doors without all the headaches of an enterprise system.**



PLUS features include:

- Intuitive & easy to use software; similar look & feel to the IP Pro™ web browser interface
- Free, single PC software for up to 100 doors
- Configure & manage all your IP Pro™ controllers from a single interface – No enterprise headaches
- Wizard & quick start buttons for common tasks
- Automated management reporting
- E-mail alert notifications
- Utilizes the scalability of Microsoft SQL server
- Save more energy the more doors you add



PLUS Hardware is used by the installer to set up controllers, doors and user profiles

- Enable & edit IPPro controllers
- Enable & edit door settings
- Create event filters
- Enable e-mail notifications

PLUS Manage is used by system administrators to facilitate database changes required on a day-to-day basis, and offers various reporting tools

- Create, view, & edit users
- Add access & holiday schedules
- Generate user & event reports

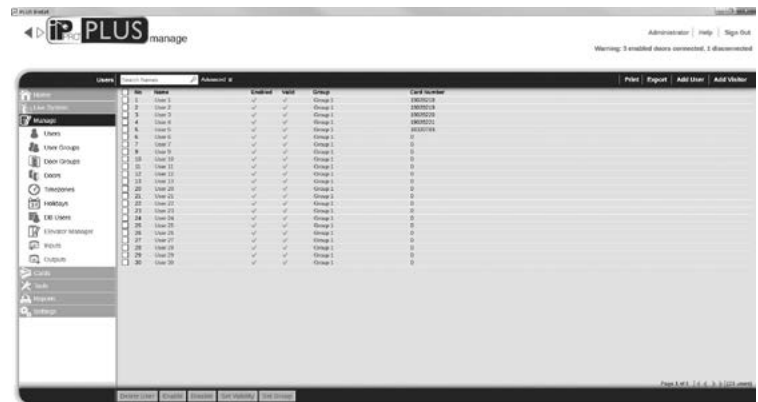

PLUS Server is used by system administrators to perform specialized tasks, such as database backups, firmware updates, importing/exporting users

- Perform manual or schedule automatic backups
- Import/Export Users
- Perform IPPro firmware updates

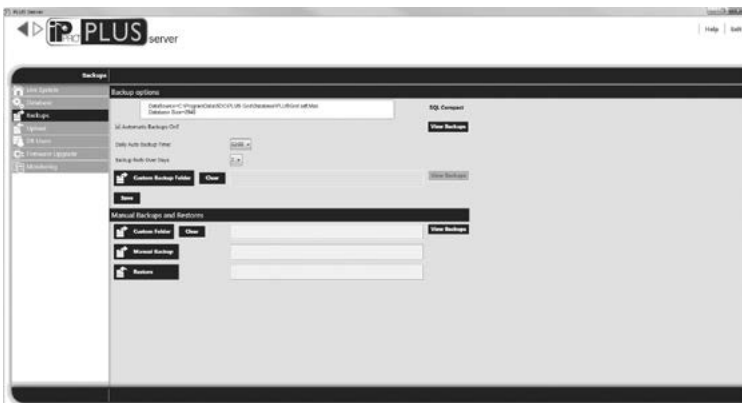

Live System events can be monitored from either module!

Price List Effective February 1, 2017

SECURITY DOOR CONTROLS
801 Avenida Acaso • Camarillo, CA 93012
Email: Service@sdsecurity.com • www.sdsecurity.com



Access Control



918



500 user codes, 1 to 6 digits in length, 4 outputs, 2 relay and 2 solid state outputs timed or latching (on/off). Assign entry PIN's to relays 1 and/or 2. Tactile keys with selectable audible volume for key depression or output activation. LED Status: Access, lockout. Timed anti-passback. Keypad tamper lockout. Request-to-Exit/Enter input. Indoor blue backlit, moisture resistant keypad. Thick S.S. faceplate 3/32" (2mm).

ELECTRICAL SPECIFICATIONS

Voltage	12/24 VAC/DC — 5-16 VDC for Wiegand
Current	30mA typical, 150mA maximum - 60mA max for Wiegand
Outputs (918)	Relay 1 - SPDT 5 Amps @ 30VDC, Relay 2 - SPDT 2 Amps @ 30VDC, Switch to Common Outputs 3 & 4 - 100mA @ 30VDC
Dimensions	3"W x 4-3/4"H x 1-1/2"D (1/4" Wall projection)



918W



- 918** Stand alone digital indoor keypad **166.00**
- 918W** Indoor digital keypad, Wiegand output **166.00**

SPECIFY FINISH Add to List

U	630 Brushed Stainless Steel (standard)	N/C	H	613 Oil Rubbed Bronze	63.00
C	605 Bright Brass	63.00	P	625 Bright Chrome	63.00
D	606 Dull Brass	63.00			

OPTIONS Add to List

- TR12** Plug in power supply (optional) **75.00**
120 VAC primary, Output: 12VDC @ 1Amp, Secondary screw terminals with ground terminal

ACCESSORIES Add to List

- 900-PS** Privacy & Rain Shroud for stand alone digital keypads 918. Ensure protection from rain and security from spying eyes. **100.00**



900-PS with 918 Keypad

Price List Effective February 1, 2017



920



920P



920PW



The **920 Series EntryCheck™** stand-alone digital keypad is designed to control access of a single entry point with up to 500 users. Each user is assigned a personal identification number (PIN). Keypad entry of a valid one to six digit code activates one or both of the output relays which releases an electric door lock. Heavy Cast Vandal Resistant Housing. Heavy Cast Metal Blue Backlit Keys.

ELECTRICAL SPECIFICATIONS

Voltage	12/24 VAC/DC — 5-16 VDC for Wiegand (920PW)
Current	30mA typical, 150mA maximum - 60mA max for Wiegand
Outputs (920/920P)	Relay 1 - SPDT 5 Amps @ 30VDC Relay 2 - SPDT 2 Amps @ 30VDC Switch to Common Outputs 3 & 4 – 100mA @ 30VDC
Operating Temperature	-20°F to + 130°F (-30°C to + 54°C)
Operating Humidity	5% to 95% non-condensing
Housing	3"W x 5-3/4"H x 1-7/16"D

920	Stand alone digital keypad	182.00
920P	Stand alone digital keypad with Prox Reader	404.00
920PW	Digital keypad with Prox Reader, Wiegand output	404.00

CARDS, KEY FOBs and TAGS see page 65

Access Control

SECURITY DOOR CONTROLS
801 Avenida Acaso • Camarillo, CA 93012
Email: Service@sdsecurity.com • www.sdsecurity.com



923



923P



923PW



The **923 Series EntryCheck™** narrow stand-alone digital keypad is designed to control access of a single entry point with up to 500 users. Each user is assigned a personal identification number (PIN). Keypad entry of a valid one to six digit code activates one or both of the output relays which releases an electric door lock. Heavy Cast Vandal Resistant Housing. Heavy Cast Metal Blue Backlit Keys.

ELECTRICAL SPECIFICATIONS

Voltage	12/24 VAC/DC — 5-16 VDC for Wiegand
Current	30mA typical, 150mA maximum - 60mA max for Wiegand
Outputs (923/923P)	Relay 1 - SPDT 5 Amps @ 30VDC Relay 2 - SPDT 2 Amps @ 30VDC Switch to Common Outputs 3 & 4 – 100mA @ 30VDC
Operating Temperature	-20°F to + 130°F (-30°C to + 54°C)
Operating Humidity	5% to 95% non-condensing
Housing	1-3/4"W x 7-5/16"H x 1-3/8"D

923	Stand alone digital keypad, narrow	207.00
923P	Stand alone digital keypad, narrow, with Prox Reader	492.00
923PW	Digital keypad, narrow, with Prox Reader, Wiegand output	492.00

CARDS, KEY FOBs and TAGS see page 65

921P/924P INDOOR/OUTDOOR 2-PIECE EntryCheck™

Distributor Discount Code **JK LIST**



The **921P** and the **924P EntryCheck™** stand-alone digital keypad with Prox Reader and Controller (2-piece configuration) are designed to control access of a single entry point with up to 500 users. Each user is assigned a personal identification number (PIN). Keypad entry of a valid one to six digit code activates one or both of the output relays which releases an electric door lock. Heavy Cast Vandal Resistant Housing. Heavy Cast Metal Blue Backlit Keys.

ELECTRICAL SPECIFICATIONS

Voltage	12/24 VAC/DC
Current	60mA typical, 150mA maximum
Outputs	Relay 1 - SPDT 5 Amps @ 30VDC Relay 2 - SPDT 2 Amps @ 30VDC Switch to Common Outputs 3 & 4 - 100mA @ 30VDC
Operating Temperature	-20°F to + 130°F (-30°C to + 54°C)
Operating Humidity	5% to 95% non-condensing
Housing	921P: 3"W x 5-3/4"H x 1-7/16"D 924P: 1-3/4"W x 7-5/16"H x 1-3/8"D

921P	Stand alone, surface mount digital keypad, with Prox Reader and Controller	596.00
924P	Stand alone, surface mount digital keypad, narrow, with Prox Reader and Controller	621.00

CARDS, KEY FOBS and TAGS see page 65

925/925P/925PW INDOOR/OUTDOOR Shroud EntryCheck™

Distributor Discount Code **JK LIST**



The **925 Series EntryCheck™** elevates the robustness of the indoor/outdoor 920 keypad with a heavy metal privacy and rain shroud. Perfect for post mount applications.

ELECTRICAL SPECIFICATIONS (KEYPAD)

Voltage	12/24 VAC/DC — 5-16 VDC for Wiegand (925PW)
Current	30mA typical, 150mA maximum - 60mA max for Wiegand
Outputs (925/925P)	Relay 1 - SPDT 5 Amps @ 30VDC Relay 2 - SPDT 2 Amps @ 30VDC Switch to Common Outputs 3 & 4 - 100mA @ 30VDC
Operating Temperature	-20°F to + 130°F (-30°C to + 54°C)
Operating Humidity	5% to 95% non-condensing
Shroud Dimension	4-1/16"W x 6-1/8"H x 2-5/8"D

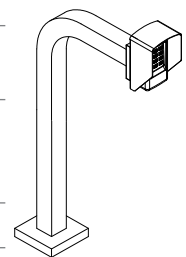

925	Stand alone digital keypad with privacy shroud	281.00
925P	Stand alone digital keypad with Prox Reader and privacy shroud	504.00
925PW	Digital keypad with Prox Reader, Wiegand output, and privacy shroud	504.00

CARDS, KEY FOBS and TAGS see page 67

SDG SECURITY DOOR CONTROLS
 801 Avenida Acaso • Camarillo, CA 93012
 Email: Service@sdcsecurity.com • www.sdcsecurity.com

Price List Effective February 1, 2017

E70 EntryCheck™ Standalone Electronic Lockset Series

Distributor Discount Code **MMK LIST**

Price List Effective February 1, 2017



The **E70 EntryCheck™ Series** is a standalone electronic battery powered solution, providing controlled access for basic and multi-level high security requirements. The E70 series lockset is keypad programmable, and combines multiple access technology with efficient motorized locksets.

KEYPAD FEATURES

- Keypad Programmable
- 3,000 Users, 32 Temporary
- 4 to 6 Digit PIN Codes
- 3 Passage Mode Option
- 32 Access Groups, Schedules
- 32 Holidays
- 4 Authority Levels
- Keypad Tamper Lockout
- Mechanical Key Override
- Battery Powered (4AA)
- Blue Backlit Cast Metal Keys
- Weather & Vandal Resistant



G1 Galaxy



E1 Eclipse



G5 Galaxy, I-Core prep



E5 Eclipse, I-Core prep

E75 EntryCheck™ Standalone Electronic Lockset - SDC Lock

E75 EntryCheck™ LIST

E75 series can be retrofitted to existing prep for cylindrical locks.

E75K	Digital Keypad only, cylindrical lockset	710.00
E75P	Digital Keypad with Prox Reader, cylindrical lockset	910.00
E75PS	Digital Keypad with Prox Reader and Software, cylindrical lockset	1200.00

SPECIFY KEYPAD FINISH Add to List

Q	626 Dull Chrome (standard)	B	Black	N/C
----------	----------------------------	----------	-------	------------

SPECIFY LEVER HANDLE Add to List

G1	Galaxy	E1	Eclipse	N/C
G5	Galaxy, I-Core prep	E5	Eclipse, I-Core prep	25.00
<i>G5 and E5 I-Core prep without I-Core</i>				

SPECIFY LEVER LOCKSET FINISH Add to List

Q	626 Dull Chrome (standard)	N/C		
P	625 Bright Chrome	C	605 Bright Brass	52.00

Cards, Key FOBS and Tags

Distributor Discount Code **MV List**

HID1326-25	Proximity Card, HID compatible, 25 cards	166.00
HID1326-100	Proximity Card, HID compatible, 100 cards	663.00
HID1346-10	Proximity Key Fob, HID compatible, 10 key fobs	135.00
HID1346-100	Proximity Key Fob, HID compatible, 100 key fobs	1325.00
PTAG-10	Proximity Disc Tag, HID compadible, 10 tags	75.00
PTAG-25	Proximity Disc Tag, HID compadible, 25 tags	180.00

Access Control

SECURITY DOOR CONTROLS
 801 Avenida Acaso • Camarillo, CA 93012
 Email: Service@sdsecurity.com • www.sdsecurity.com

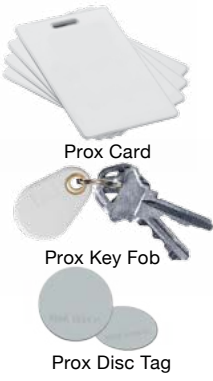

E76 EntryCheck™ Standalone Electronic Lockset-SDC Mortise Lock



E76 EntryCheck™ LIST

E76K	Digital Keypad only, with mortise lock	1000.00
E76P	Digital Keypad with Prox Reader, with mortise lock	1200.00
E76PS	Digital Keypad with Prox Reader and Software, with mortise lock	1490.00

SPECIFY KEYPAD FINISH Add to List

Q	626 Dull Chrome (standard)	B	Black	N/C
----------	----------------------------	----------	-------	------------

SPECIFY LOCK HAND Add to List

L	Left hand	LR	Left hand reversed	All hands are field reversible	N/C
R	Right hand	RR	Right hand reversed	without disassembly	N/C

SPECIFY LOCK LEVER TRIM Add to List

G	Galaxy with rose	N/C	GE	Galaxy with escutcheon	104.00
E	Eclipse with rose	N/C	EE	Eclipse with escutcheon	104.00
N	Nova with rose	N/C	NE	Nova with escutcheon	104.00
07	Schlage equal with SDC B rose	N/C	07E	Schlage equal with SDC escutcheon	104.00

SPECIFY LOCK FINISH Add to List

Q	626 Dull Chrome (standard)	N/C	G	612 Dull Bronze	52.00	S	629 Bright Stainless Steel	52.00
C	605 Bright Brass	52.00	H	613 Oil Rubbed Bronze	52.00	U	630 Dull Stainless Steel	52.00
D	606 Dull Brass	52.00	P	625 Bright Chrome	52.00			

KEY CYLINDER OPTIONS Add to List

	CYL-6KDQ	6 pin, 1.125" mortise cylinder, keyed different, dull chrome	32.00
	CYL-6KAQ	6 pin, 1.125" mortise cylinder, keyed alike, dull chrome	32.00

Cards, Key FOBS and Tags Distributor Discount Code **MV** List

HID1326-25	Proximity Card, HID compatible, 25 cards	166.00
HID1326-100	Proximity Card, HID compatible, 100 cards	663.00
HID1346-10	Proximity Key Fob, HID compatible, 10 key fobs	135.00
HID1346-100	Proximity Key Fob, HID compatible, 100 key fobs	1325.00
PTAG-10	Proximity Disc Tag, HID compadible, 10 tags	75.00
PTAG-25	Proximity Disc Tag, HID compadible, 25 tags	180.00



Prox Card



Prox Key Fob



Prox Disc Tag

Access Control



SECURITY DOOR CONTROLS
801 Avenida Acaso • Camarillo, CA 93012
Email: Service@sdsecurity.com • www.sdsecurity.com

Price List Effective February 1, 2017

E77 EntryCheck™ Standalone Electronic Lockset - SDC Rim Exit Device

Price List Effective February 1, 2017



S6100 Rim Mount



EK Eclipse



GK Galaxy

E77 EntryCheck™

E77K	Digital Keypad only, with SDC S6100 Exit Device	1400.00
E77P	Digital Keypad with Prox Reader, with SDC S6100 Exit Device	1600.00
E77PS	Digital Keypad with Prox Reader and Software, with SDC S6100 Exit Device	1890.00

SPECIFY KEYPAD FINISH

Q	626 Dull Chrome (standard)	B	Black	N/C
----------	----------------------------	----------	-------	------------

SPECIFY ELECTRIC TRIM

EK	Eclipse style electric trim less mortise cylinder, Stainless Steel Finish	N/C
GK	Galaxy style electric trim less mortise cylinder, Stainless Steel Finish	N/C

KEY CYLINDER OPTIONS for Electric Trim

CYL-6KDQ	6 pin, 1.125" mortise cylinder, keyed different, dull chrome	32.00
CYL-6KAQ	6 pin, 1.125" mortise cylinder, keyed alike, dull chrome	32.00

SPECIFY SPECTRA SERIES EXIT DEVICE

M61	Rim mount exit device	N/C
------------	-----------------------	------------

SPECIFY PANIC OR FIRE RATE

P	Panic exit device Mechanical Dogging STD; See part # CD for optional key cylinder dogging	N/C
F	Fire exit device Mechanical dogging not available	110.00

SPECIFY EXIT DEVICE FINISH

U	630 Dull Stainless Steel	N/C
----------	--------------------------	------------

SPECIFY EXIT DEVICE LENGTH

36	For 36" Door	N/C	42	For 42" Door	20.00	48	For 48" Door	40.00
-----------	--------------	------------	-----------	--------------	--------------	-----------	--------------	--------------

Cards, Key FOBS and Tags

Distributor Discount Code **MV List**

HID1326-25	Proximity Card, HID compatible, 25 cards	166.00
HID1326-100	Proximity Card, HID compatible, 100 cards	663.00
HID1346-10	Proximity Key Fob, HID compatible, 10 key fobs	135.00
HID1346-100	Proximity Key Fob, HID compatible, 100 key fobs	1325.00
PTAG-10	Proximity Disc Tag, HID compadible, 10 tags	75.00
PTAG-25	Proximity Disc Tag, HID compadible, 25 tags	180.00



Prox Card



Prox Key Fob



Prox Disc Tag

SECURITY DOOR CONTROLS

801 Avenida Acaso • Camarillo, CA 93012

Email: Service@sdsecurity.com • www.sdsecurity.com



Access Control

PUSH TO EXIT

Field Applied Sign with green letters



Access Control System Units
Burglary Resistant Electronic Locking Mechanism



STANDARD FEATURES

- Actuation:** Pressure Sense Technology; Tri-Failsafe
- Voltage:** 12/24VDC Voltage Sense Input
- Current:** 20 mA at Rest, 115 mA Active
- Lock Output:** SPDT, 3 Amp @ 30VDC
- Alarm Shunt/Status Output:** SPDT, 3 Amp @ 30VDC
- Accessories Include:**
10 ft. cable and connector; PT-2U Armored Power Transfer Loop

Standard length, 36"

MODEL	FINISH	LIST PRICE
PSB560V	628 Aluminum Anodized	363.00
PSB560Y	Black Anodized	363.00
PSB560S	629 Bright Stainless Steel	492.00
PSB560U	630 Brushed Stainless Steel	492.00

Bars for wide doors

42 Bar for 42" Door. May be field cut.	N/C
48 Bar for 48" Door. May be field cut <i>Ex: PSB560V-42</i>	N/C

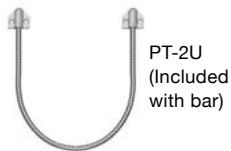

PT-2U
(Included with bar)



PT3

ACCESSORIES

ACCESSORIES	LIST
500GL-KIT One glass door mounting kit with adhesive for eight to ten bars	244.00
500GL-MB One glass door mounting kit without adhesive	135.00
500-SK Shim kit used to raise bar from door. Recommended for wood or hollow metal doors with uneven mounting surface.	25.00

Power Transfer:

PT-3V Stainless steel armored loop with aluminum surface wire junction box	47.00
---	--------------

Standard Installation with standard mounting hardware

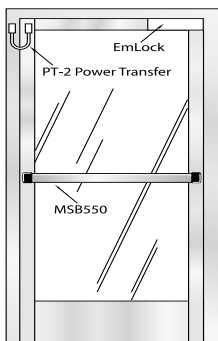

500GL Kit Glass Mount Installation

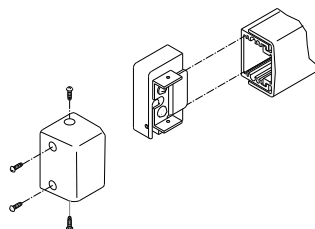

1. Assemble kit

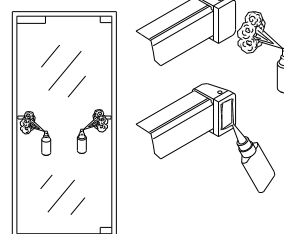

2. Apply Adhesive

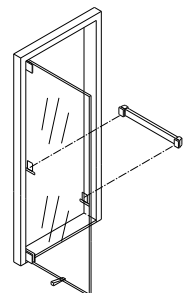

3. Mount

EXIT MECHANICAL SWITCH

Distributor Discount Code **DK**

PUSH TO EXIT

Field Applied Sign with green letters



Listed 4J82

Access Control System Units
Burglary Resistant Electronic
Locking Mechanism



3773-0324:106

STANDARD FEATURES

Actuation: 1/8" total bar movement for mechanical switch actuation

Contact: SPDT, 5 Amp @ 30VDC (2nd switch optional)

Accessories include: PT-2U Power Transfer Loop

Standard length, 36"

MODEL	FINISH	LIST PRICE
MSB550V	628 Aluminum Anodized	225.00
MSB550Y	335 Black Anodized	233.00
MSB550S	629 Bright Stainless Steel	373.00
MSB550U	630 Brushed Stainless Steel	373.00

2 SPDT Contacts **ADD 30.00**

Add "2" for 2nd mechanical switch for dual-failsafe redundant operation; alarm shunt; or monitoring output. *Ex: MSB550-2V*

Bars for wide doors

42 Bar for 42" Door. May be field cut. **N/C**

48 Bar for 48" Door. May be field cut **N/C**

Ex: MSB550V42

EXIT MECHANICAL SWITCH - OUTDOOR WEATHER RESISTANCE

Distributor Discount Code **DK**

PUSH TO EXIT

Field Applied Sign with green letters

STANDARD FEATURES

OUTDOOR, WEATHER RESISTANCE

Water Sealed Switches

Actuation: 1/8" total bar movement for mechanical switch actuation

Contact: SPDT, 5 Amp @ 30VDC (2nd switch included)

Accessories include: PT-3V Power Transfer Loop, 2 SPDT Contacts included

Standard length, 36"

MODEL	FINISH	LIST PRICE
MSB550-2VW	628 Aluminum Anodized	363.00
MSB550-2YW	335 Black Anodized	363.00

Bars for wide doors

42 Bar for 42" Door. May be field cut. **N/C**

48 Bar for 48" Door. May be field cut **N/C**

Ex: MSB550-2VW42

Price List Effective February 1, 2017

SDC SECURITY DOOR CONTROLS

801 Avenida Acaso • Camarillo, CA 93012

Email: Service@sdsecurity.com • www.sdsecurity.com



Egress Controls

Exit Device Switch Kits

Distributor
Discount Code **DK**

APPLICATION

- Activation of delayed egress locks
- Electromagnetic Lock Release
- Request-to-Exit
- Alarm Shunt or Alarm Activation

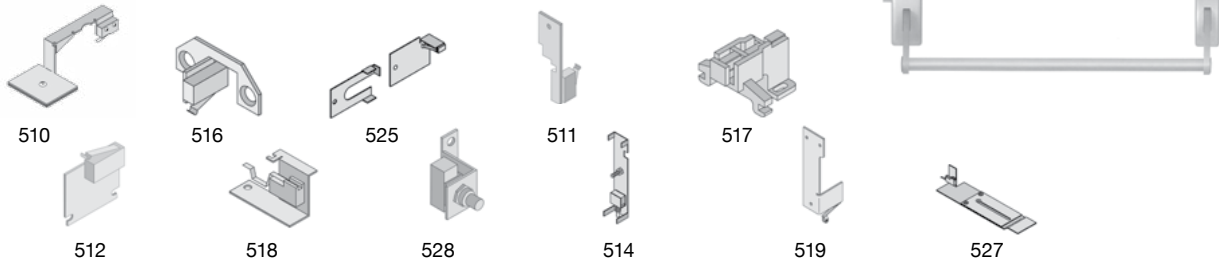

SWITCH KITS

LIST

Switch Kits are field installed in the inactive hinge pad of an exit device to provide instantaneous release of EmLocks for egress. All kits include a SPDT Switch Assembly with wire leads. 5 Amp @ 30VDC.

MODEL	MAKE & MODEL TO BE MODIFIED	PRICE	MODEL	MAKE & MODEL TO BE MODIFIED	PRICE
510	Von Duprin 33, 35, 98, 99	156.00	525	Monarch 18 and 19	156.00
510-2	Von Duprin 33, 35, 98, 99 DPDT	192.00	525-2	Monarch 18 and 19	192.00
511	Von Duprin 55	156.00	526	Corbin ED8200	156.00
512	Von Duprin 88	156.00	527	Sargent 80, Arrow S3800/S1250	156.00
514	Dor-O-Matic 990, 1090, 1990, 2090	156.00	527-2	Sargent 80 DPDT	192.00
515	Sargent 9300, 9400, 9500	156.00	528	Sargent 20/60 and Yale 2100	156.00
516	Sargent 9600, 9700, 9800, 9900	156.00	531	Yale 7000 (Dogging mechanism required) Corbin 4000/5000	156.00
517	Adams Rite 8300, 8400, 8700, 8800	156.00	535	Kawneer Mid Panel Line Dor-O-Matic 1390	156.00
518	Precision Series 1100	156.00	536	Jackson 1295	156.00
518A	Precision Apex Series (2100 - 2800)	156.00	539	Cal Royal 9800 Series	156.00
519	Jackson 1095	156.00	542	Hager 4700	156.00
519-2	Jackson 1095 DPDT	192.00	590	Dor-O-Matic 1690	156.00
520	Corbin 3000	156.00			
521	Corbin 7000	156.00			

NOTE: Consult factory for Exit Device Switch Kits not shown. Modification of any kind to a UL Listed device may void UL Listing.



SECURITY DOOR CONTROLS
801 Avenida Acaso • Camarillo, CA 93012
Email: Service@sdcsecurity.com • www.sdcsecurity.com

Price List Effective February 1, 2017

Exit Switches

Distributor Discount Code **CK**

410 SERIES - 1-3/4" X 1" EXIT SWITCH OPTIONS - SEE PAGE 74 LIST

1 3/4" x 1" Button - Green and Red Illuminated Lens included - Dull Stainless Steel finish



412N
413N
414N

Narrow	Contact	Sign	
412NU	Momentary SPDT	PUSH TO EXIT	73.00
413NU	Integrated electronic timer, adj. 1-60 sec. 12/24VDC, 2A DPDT Contact	PUSH TO EXIT	140.00
413PNU	Integrated pneumatic timer, adj. 1-180 sec. 12/24VDC, SPDT 3 Amp Contact	PUSH TO EXIT	332.00
414NU	Momentary DPDT	PUSH TO EXIT	88.00
415NU	AA (On/Off) DPDT	NONE	109.00

420 SERIES - 2" EXIT SWITCH OPTIONS - SEE PAGE 74 LIST

2" Button, Green and Red Illuminated Lens included - Dull Stainless Steel Finish



422
423
424



422A
423A

1 Gang	Contact	Sign	
422U	Momentary SPDT	PUSH TO EXIT	73.00
422AU	Momentary SPDT 2" Button - Blue illuminated lens only	♿ Symbol	73.00
423U	Integrated electronic timer, adj. 1-60 sec 12/24VDC, 2A DPDT Contact	PUSH TO EXIT	140.00
423PU	Integrated pneumatic timer, adj. 1-180 sec. 12/24VDC, SPDT 3 Amp Contact	PUSH TO EXIT	332.00
423AU	Integrated 1-60 sec Timer 12/24VDC, 2A DPDT Contact 2" Button - Blue illuminated lens only	♿ Symbol	140.00
424U	Momentary DPDT	PUSH TO EXIT	109.00
425U	AA (On/Off) DPDT	NONE	109.00

CODE COMPLIANT MANUAL RELEASE DEVICES LIST

Code Compliant Manual Releasing Devices and Sensors

423M and 413MN exit switches USED TOGETHER WITH the MD31D PIR sensor comply with manual releasing device and sensor device requirements for Access-Controlled Egress Doors per:

IBC International Code 1008.1.3.4 NFPA 101 7.2.1.62 BOCA National Building Code 1017.4.5
IFC International Code 1008.1.3.4 NFPA 1 15.5.3.2 SBCCI Standard Building Code 1012.7

Code Compliant Manual Release Device

Code Compliant Features: Fixed 30 second timer, re-triggerable; Failsafe - lock releases when power to switch is interrupted; Sign - PUSH TO EXIT; CSFM Listed;:

1 3/4"x1" Button, Green Illuminated Lens - Dull Stainless Steel Finish, Specify R for optional red lens



413MN



423M

Narrow	Contact	Sign	
413MNU	Integrated Fixed 30 sec. Timer 12/24VDC, 2 Amp Contact	PUSH TO EXIT	145.00

2" Button, Green Illuminated Lens - Dull Stainless Steel Finish, Specify R for optional red lens

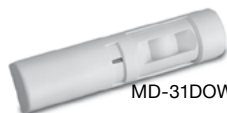

MD-31DOW

1 Gang	Contact	Sign	
423MU	Integrated Fixed 30 sec. Timer 12/24VDC, 2 Amp Contact	PUSH TO EXIT	145.00

Code Compliant Egress Sensor

Code Compliant Features: PIR egress sensor with failsafe mode - lock releases when PIR power to PIR sensor is interrupted. UL listed 294 Access Control System Units

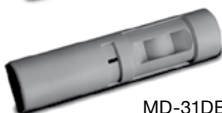

MD-31DB

Model	Color		
MD-31DOW	White	PIR Egress Sensor	V 235.00
MD-31DB	Black	PIR Egress Sensor	V 235.00



Input: 12 or 24 VAC/DC @ 26mA max.

Contact: 2 SPDT Dry, 2 Amp @ 30VDC (38.1 H x 148.8 W x 38.1 D mm)

Operating Temp: -20° F to 120° F (-29° C to 49° C)

Dimensions: 1.5" H x 6.25" W x 1.5" D



BB1D

RETROFIT BACK BOX LIST

BB1D	Single Gang 2.25" w x 3.75" h x 2.75" D	13.00
-------------	---	--------------

Price List Effective February 1, 2017

SECURITY DOOR CONTROLS
801 Avenida Acaso • Camarillo, CA 93012
Email: Service@sdsecurity.com • www.sdsecurity.com



Key & Exit Switches



430

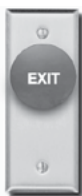

430N

430 SERIES - 1-1/2" MUSHROOM EXIT SWITCH - FOR OPTIONS SEE BELOW LIST

1.5" Mushroom, Green Button Standard, Dull Stainless Steel Finish, Specify R For Optional Red Button

1 Gang	Narrow	2 Gang	Contact	Sign	
431CU	431CNU		AA (On/Off) NC SPST	none	114.00
431OU	431ONU		AA (On/Off) NO SPST	none	114.00
432CU	432CNU		Momentary NC SPST	EXIT	114.00
432OU	432ONU		Momentary NO SPST	EXIT	114.00
432KUR	432KNUR		Latching/ key reset DPST, Red	none	223.00
		433U	Momentary with Timer Module 1-60 sec. 12/24V AC/DC SPDT 2A Contact	EXIT	213.00
434U	434NU		Momentary DPST	EXIT	140.00
435U	435NU		AA (On/Off) DPST	none	140.00



441 - 444



446

440 SERIES - 2-5/8" MUSHROOM EXIT & PANIC SWITCHES - FOR OPTIONS SEE BELOW LIST

2-5/8" Mushroom, Red Button Standard, Dull Stainless Steel Finish, Specify G For Optional Green Button

1 Gang	2 Gang	Contact	Sign	
	441U	AA (On/Off) DPST	None	197.00
	442U	Momentary DPST	EXIT	197.00
	443U	Momentary with Timer Module 1-60 sec. 12/24V AC/DC SPDT 2A Contact	EXIT	285.00
	444U	Momentary 2-DPST	EXIT	218.00
	446U	Momentary DPST	EXIT	130.00

450 SERIES - VANDAL RESISTANT ALUMINUM EXIT SWITCH LIST

Stainless Steel Button - 1/4" Thick Aluminum Plate - Security Screws - Plated Finish Not Available

1 Gang	Narrow	Contact	Sign	
451V	451NV	AA (On/Off) SPDT	None	156.00
452V	452NV	Momentary SPDT	None	156.00
453PV	453PNV	Integrated Pneumatic Timer ADJ. 1-180 sec. SPDT contact	None	440.00



451
452
453



451N
452N
453N



463



463N

463 SERIES - VANDAL RESISTANT STAINLESS STEEL EXIT SWITCH LIST

Piezoelectric Stainless Steel Button - No moving parts - Integrated Time Delay - Red and Green Status Indicators

2mm Stainless Steel - Security Screws - Plated Finish Not Available

1 Gang	Narrow	Contact	Sign	
463U	463NU	Integrated 1-30 Sec Timer 12/24VDC, NO/NC 2A Contact	PUSH TO EXIT	135.00

470 SERIES - SANITARY, NO TOUCH, WAVE-TO-EXIT SWITCH LIST

- IR Sensor, 4" read range, Red, Green illuminated LED status. Control electric locks, strikes and automatic door operators.
 - Entry/exit for sanitary environments including: bathrooms, hospitals, schools, cleanrooms, food processing, labs, or offices.
- Output:** DPDT 3 Amp Dry Contact
Input: 25mA (standby); 55mA (active) @ 12/24VDC
Faceplate: 20ga stainless steel



474



474D

	Contact	Sign	
474U	DPDT	No Touch Exit	78.00
474DU	DPDT	No Touch Exit	135.00

OPTIONS AND FINISHES FOR 410,420, 430, AND 440 SERIES Add to List

Options for 410, 420, 430, 440 Series

L1G	1 Green LED	21.00	LT	Tricolor LED - Red, Green, Amber	32.00
L1R	1 Red LED	21.00	E	Add Exit sign To AA Function Switch Only	11.00
L2	1 Red and 1 Green LED	32.00	B	No Exit sign (None) with Momentary Switch	N/C

Special Finish

450 / 460 / 470 Special finish is not available

Designate special finish suffix from below in lieu of U (stainless steel) in part number.

C	605 Bright Brass	D	606 Dull Brass	42.00
P	625 Bright Chrome	H	613 Oil Rubbed Bronze	42.00



SECURITY DOOR CONTROLS
801 Avenida Acaso • Camarillo, CA 93012
Email: Service@sdgsecurity.com • www.sdgsecurity.com

Price List Effective February 1, 2017

KEY SWITCHES

Distributor Discount Code **CK**

Key Cylinder sold separately: **MO** - Momentary **AA** - Alternate Action (on-off)
 Key switch assemblies compatible with 1" to 1.375" U.S. standard and interchangeable core mortise cylinders (not included).

6 AMP KEY SWITCH ASSEMBLIES

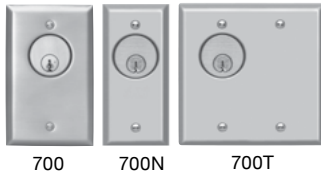

700 700N 700T



700-L2 700T-SN-L2

See Options below

20 Gauge Stainless Steel Faceplate					Contacts
1 Gang	Narrow	List	2 Gang	List	
701	701N	99.00	701T	125.00	AA SPDT
702	702N	99.00	702T	125.00	MO SPDT
704	704N	176.00	704T	197.00	1-60 Timer SPDT
705	705N	114.00	705T	135.00	AA DPDT
706	706N	109.00	706T	130.00	MO DPDT
707	707N	130.00	707T	151.00	2 MO SPDT
708	708N	135.00	708T	156.00	1 MO SPDT & 1 AA SPDT
709	709N	145.00	709T	166.00	2 AA SPDT
710	710N	197.00	710T	223.00	1-60 Timer & AA SPDT
711	711N	151.00	711T	171.00	2 MO DPDT
712	712N	151.00	712T	171.00	1 MO DPDT & 1 AA DPDT
713	713N	151.00	713T	171.00	2 AA DPDT

1/4" Thick Aluminum Plate					Contacts
1 Gang	Narrow	List			
801AL	801ALN	145.00			AA SPDT
802AL	802ALN	145.00			MO SPDT
804AL	804ALN	223.00			1-60 Timer SPDT
805AL	805ALN	166.00			AA DPDT
806AL	806ALN	166.00			MO DPDT
807AL	807ALN	187.00			2 MO SPDT
808AL	808ALN	187.00			1 MO SPDT & 1 AA SPDT
809AL	809ALN	187.00			2 AA SPDT
810AL	810ALN	264.00			1-60 Timer & AA SPDT
811AL	811ALN	213.00			2 MO DPDT
812AL	812ALN	213.00			1 MO DPDT & 1 AA DPDT
813AL	813ALN	213.00			2 AA DPDT

SPECIFY FINISH Add to List

U 630 Dull Stainless Steel (Standard For All Key Switches Except The 800AL)	N/C
AL 628 Anodized Aluminum (Standard For The 800AL Key Switch Only)	N/C
Plated finishes, special order, no cancellation, no return	
C 605 Bright Brass 42.00	H 613 Oil Rubbed Bronze 42.00
D 606 Dull Brass 42.00	P 625 Bright Chrome 42.00

OPTIONS Add to List

10TD Mini timer, adj. 1-60 second 12/24VDC, SPDT 88.00	LT One tricolor LED. Red, green and amber 32.00
CYL-KD 1 1/8" Key cylinder with 2 keys (keyed differently) 32.00	ATS Anti-tamper sensor, SPDT 32.00
L1 One LED. Specify red or green 21.00	RMB Buzzer, 12 or 24VDC, 20mA 42.00
L2 Two LEDs. Red, and green 32.00	SN 85 db siren, 4V-25VDC, 15mA 52.00



10TD

KEY CYLINDER OPTIONS Add to List

CYL-6KDK 6 pin, 1.125" mortise cylinder, keyed different, dull chrome 32.00
CYL-6KAQ 6 pin, 1.125" mortise cylinder, keyed alike, dull chrome 32.00

RETROFIT BACK BOX

BB1D Single Gang 2.25" w x 3.75" h x 2.75" D 13.00



BB1D

Price List Effective February 1, 2017

SECURITY DOOR CONTROLS
 801 Avenida Acaso • Camarillo, CA 93012
 Email: Service@sdsecurity.com • www.sdsecurity.com



Key & Exit Switches

Passive Infrared Egress Control

Distributor Discount Code **V LIST**



MD-31DOW	Motion detector with time delay, white	235.00
MD-31DB	Motion detector with time delay, black	235.00

Time Delay Relay

Distributor Discount Code **CK List**



Time Delay Relays

10TD	Time delay relay module with adjustable 1-60 second relock delay. Input: 12/24V AC/DC Output: SPDT, dry contact Voltage: 2 Amps @ 30 VDC (resistive) Size: 2-1/4"x 1-1/2" x 3/4"	88.00
-------------	--	--------------



SECURITY DOOR CONTROLS
 801 Avenida Acaso • Camarillo, CA 93012
 Email: Service@sdccsecurity.com • www.sdccsecurity.com

Price List Effective February 1, 2017

Auto EntryControl™

Distributor Discount Code **XK**

Auto EntryControl's™ non-pivot drive and combination of belt, gear and pulley requires less torque, requires less power, absorbs more abuse, and is quieter than other automatic door openers while complying with all US and Canadian ADA requirements. On-board diagnostics simplifies troubleshooting for ease of installation and all Auto EntryControl's™ can be easily configured for surface mounted push/pull or overhead concealed applications.

- ADA Compliant
- Complies with ANSI A 156.19
- UL - Certified for use as fire door operators (3 hour rating)
- Self-Tuning, Self-Learning
- Minimum 5 seconds from close to open
- Stays open for 5 seconds
- 130 degree of opening
- Push or Pull (In door, Out swing)
- Activation: Knowing Act
- Optional Safety Device
- Input Power: 1A, 100W
- Non-Handed
- Extremely Quiet Operation



ADA Compliant

Price List Effective February 1, 2017

SINGLE DOOR OPENING

SPECIFY MODEL LIST

Model	Description	
AUTO	Auto EntryControl™ Single Swing Door Operator	2270.00

OPERATION Add to List

Operation	Description	
1	PUSH arm plus standard spindle	N/C
2	PULL arm plus standard spindle	N/C
3	One PUSH arm plus spindle, one PULL arm plus spindle	270.00

DOOR OPENING Add to

Width	Description	
36	for 36" Door Opening	N/C
42	for 42" Door Opening	N/C
48	for 48" Door Opening	N/C

COLOR Add to List

Color	Description	
V	Aluminum	N/C
X	Dark Bronze Powder Coat	POA

DOUBLE DOOR OPENING (SPECIAL ORDER)

SPECIFY MODEL LIST

Model	Description	
AUTO	Auto EntryControl™ Double Swing Door Operator	4599.00

OPERATION Add to List

Operation	Description	
1	Two PUSH arm plus standard spindle	N/C
2	Two PULL arm plus standard spindle	N/C
3	One PULL arm plus spindle, one DOUBLE EGRESS arm plus spindle	401.00

DOOR OPENING Add to List

Width	Description	
72	for 72" Double Door opening	N/C
84	for 84" Double Door opening	N/C
96	for 96" Double Door opening	N/C

COLOR Add to List

Color	Description	
V	Aluminum	N/C
X	Dark Bronze Powder Coat	POA

ACCESSORIES

Distributor Discount Code **V LIST**

AUTO-IR	Door-mounted Presence Sensor and Door Re-Activator - 48 inches, length field-adjustable	340.00
----------------	---	---------------



OPTIONAL ARM EXTENSIONS FOR REVEAL GREATER THAN 8 INCHES

AUTO-AEV	Arm Extension for PUSH arm - Aluminum	100.00
AUTO-AEX	Arm Extension for PUSH arm - Dark Bronze Powder Coat	140.00



OPTIONAL SPINDLES

SP20	20mm Spindle	75.00		SP50	50mm Spindle	75.00
SP35	35mm Spindle	75.00		SP80	80mm Spindle	90.00

SECURITY DOOR CONTROLS
801 Avenida Acaso • Camarillo, CA 93012
Email: Service@sdsecurity.com • www.sdsecurity.com



Dual Switch Bollard Post - CBC compliant

Distributor Discount Code **CK**



NEW

- California CBC Section 11B 404.3 code compliant bollard and switch plates
- Black HDPE mortised removable cap with secure transmitter mount
- Two 4-1/2" Push to Open blue infill push plates, located at 7" and 36" centerline from floor
- 6" square post with 1/8" walls
- Surface mount (42")

SPECIFY MODEL

LIST

Model	Description	
CBC482A4U	42" surface mount, 6" square post, with high and low 4-1/2" SPDT switch plates	667.00
CBC484A4U	42" surface mount, 6" square post, with high and low 4-1/2" DPDT switch plates	717.00

Bollard Post

Distributor Discount Code **CK**



Push Plate and Touch Panel NOT INCLUDED see page 80 for ordering info

- For use with Push Plates, Touch Panel Columns & Exit Switches
- Black HDPE mortised removable cap with secure transmitter mount
- Standard single gang prep located at 36" from finished floor
- 6" square with 1/8" walls
- Surface mount (42") or In-Ground mount (54")

SPECIFY MODEL

LIST

Model	Description	
BPS6	42" surface mount, 6" square post	404.00
BPG6	54" in-ground, 6" square post	404.00

SPECIFY PREP

Add to List

S	1-gang prep	N/C
D	2-gang prep	N/C
P	Touch Panel prep	N/C
A	Narrow Mullion Prep	N/C

SPECIFY FINISH

Add to List

V	628 Aluminum (standard)	X	710 Dark Anodized Aluminum	N/C
----------	-------------------------	----------	----------------------------	------------

400 Series Wireless Transmitter and Receiver

Distributor Discount Code **CK LIST**

For Remote Control Versatility for Touch Panel Column and Push Plate Switches



433MHz Micro Transmitter

- Requires a non-metallic surface box or standard bollard cap (non-metallic). Works with 400RC433
- Pre-Wired for quick installation
- Antenna magnifies signal

Voltage Input: 9V Battery (included)
Trigger Input: Momentary, N.O.Dry Contact
Temperature: -20F — 100F
Dimensions: 1-9/64" x 15/16" x 7/32" (29 x 49 x 6mm)

Model Description

400W1-433	433MHz Micro Transmitter	75.00
------------------	--------------------------	--------------



433MHz 1 Channel Nano Receiver

- Designed to control automatic closing and anti-burglar systems. Works with 400W1-433.

Carrier Frequency: 433.92 MHz
Relay Numbers: 1
Temperature: -4F — 158F
Power Supply: 12/24 VAC/DC
Contacts: C-NO
Dimensions: 1-1/4" x 2" x 3/4" Deep (32 x 51 x 19mm)

Model Description

400RC433	433MHz 1 Channel Receiver	88.00
-----------------	---------------------------	--------------



SECURITY DOOR CONTROLS
 801 Avenida Acaso • Camarillo, CA 93012
 Email: Service@sdgsecurity.com • www.sdgsecurity.com

Price List Effective February 1, 2017

For Handicap Access, Automatic Door Activation & Request-to-Exit Applications

- Door Opener Activation
- Automatic Door Activation
- Access Control Request-to-Exit (RTE)
- Door Sequencer Activation



= can be used with wireless transmitter and receiver

SPECIFICATIONS

Mounting Plate	Heavy Duty 1/8" (3.2mm) mounting plate
Faceplate	Heavy 18 Gauge (1.02mm), 630/US32D Satin Stainless Steel Standard
Legends	Bold debossing or engraving with black, blue or white infill
Contacts	SPDT or DPDT, 15 Amps @ 125/250VAC; UL 1054, CSA Listed
Depth	[Narrow & (1) Gang] SPDT-7/8" deep, DPDT-1-3/8" deep, [4 1/2", & 6" square/ round] SPDT-3/4" deep, DPDT-1-5/32"



1-11/16" Narrow Mullion Push Plate Switch – Recessed, Surface Box or Bollard Mount

SPDT Model	Description	DPDT Model	Description
48201U	Push to Open, black infill	65.00	48401U Push to Open, black infill 90.00
482A1U	Push to Open, blue infill	65.00	484A1U Push to Open, blue infill 90.00
400-1B	Narrow Mullion Surface Box, 1-3/4" x 4-9/16" x 1-3/4" O.D.		19.00



2 3/4" x 4 1/2" Single (1) Gang Push Plate Switch

- Pressing any part of the push plate (2 3/4" x 4 1/2") causes switch actuation
- Recessed, Surface Box or Bollard Mount
- Depth: SPDT - 3/4" deep; DPDT - 1 1/2" deep

SPDT Model	Description	DPDT Model	Description
48202U	Push to Open, black infill	77.00	48402U Push to Open, black infill 102.00
482A2U	Push to Open, blue infill	77.00	484A2U Push to Open, blue infill 102.00
480-2SB	Surface mount box, 2 3/4" x 4 1/2" x 1 5/8" O.D.		29.00



4 1/2" x 4 1/2" Square Push Plate Switches

- Pressing any part of the push plates 4 1/2" x 4 1/2" active area causes switch actuation
- 1 Gang or 2 gang recessed or Surface Box Mount
- Depth: SPDT 5/8" deep; DPDT 1 1/2" deep

SPDT Model	Description	DPDT Model	Description
48204U	Push to Open, black infill	85.00	48404U Push to Open, black infill 110.00
482A4U	Push to Open, blue infill	85.00	484A4U Push to Open, blue infill 110.00
480-4FB	Square Flush Recessed box, 1-gang, 6 3/4" x 6 3/4" x 1 7/8" O.D.		63.00
480-4SBB	Surface mount box, 4-1/2" x 4-1/2" x 1 3/4" O.D. with Battery compartment for wireless		33.00
480-4SB	Surface mount box, 4-1/2" x 4-1/2" x 1 7/8" O.D.		63.00
480-4SE	3-sided stainless shroud for exterior applications, 4-11/16" x 4-7/8" x 12"		38.00



6" x 6" Square Push Plate Switch

- Pressing any part of the push plates 6" x 6" active area causes switch actuation
- 1 Gang or 2 gang recessed or Surface Box Mount
- Depth: SPDT 5/8" deep; DPDT 1 1/2" deep

SPDT Model	Description	DPDT Model	Description
48206U	Push to Open, black infill	90.00	48406U Push to Open, black infill 114.00
482A6U	Push to Open, blue infill	90.00	484A6U Push to Open, blue infill 114.00
480-6SBB	Surface mount box, 2-gang Battery Compartment, 4 1/2" x 4 1/2" x 1 3/4" O.D.		33.00

Price List Effective February 1, 2017

SECURITY DOOR CONTROLS
801 Avenida Acaso • Camarillo, CA 93012
Email: Service@sdsecurity.com • www.sdsecurity.com



480 Series Push Plate Switches - Wireless and Hardwired (continued)

Distributor Discount Code **CK LIST**

ADA Compliant



4 1/2" Round Push Plate Switch					
<ul style="list-style-type: none"> Pressing any part of the push plates 4" 1/2 active area causes switch actuation 1 Gang or 2 gang recessed or Surface Box Mount • Depth: SPDT 5/8" deep; DPDT 1 1/2" deep 					
SPDT Model Description			DPDT Model Description		
48204RU	Push to Open, black infill	85.00	48404RU	Push to Open, black infill	110.00
482A4RU	Push to Open, blue infill	85.00	484A4RU	Push to Open, blue infill	110.00
480-4RSB	Surface box, 5" Dia., 2 1/8" O.D.	56.00	480-4RFB	Black Flush Escutcheon, 5 7/8" overall diameter with trim ring	63.00
480-4RG	4" round gasket	15.00	480-4RRB	Surface Escutcheon, 7 7/8" Dia., 1 9/16" overall height	63.00



6" Round Push Plate Switch					
<ul style="list-style-type: none"> Pressing any part of the push plates 6" active area causes switch actuation 1 Gang or 2 gang recessed or Surface Box Mount • Depth: SPDT 5/8" deep; DPDT 1 1/2" deep 					
SPDT Model Description			DPDT Model Description		
48206RU	Push to Open, black infill	90.00	48406RU	Push to Open, black infill	114.00
482A6RU	Push to Open, blue infill	90.00	484A6RU	Push to Open, blue infill	114.00
480-6RSB	Surface box Round, 6 7/16" Dia., 2 1/8" O.D.	56.00	480-6RFB	Recessed Flush Escutcheon, 7 3/4" overall diameter with trim ring	63.00
480-6RG	6" round gasket	15.00			

480 Series Touch Panel Column - Wireless & Hardwire

Distributor Discount Code **CK**

Applications

- Wireless & Hardwire
- ADA Ingress/R.E.X/Egress Door Opener Activation
- Access Control Request-to-Exit (REX)
- Door Opener Activation
- Automatic Door Activation or Lock Release
- Automatic Door & Exit Device Sequencer Activation



can be used with wireless transmitter and receiver

Features

- Surface wall mount or bollard mount
- Sleek Architectural profile
- No square edges to snag, wide sloping sides deflects impact movement naturally to activate column
- Deflects impact from wheeled carts and conveyances
- Impact & Vandal resistant design, inhibits prying, tampering
- Weather Resistant, no gaps for water or ice penetration
- Choice of SPDT or DPDT, 15 Amps @ 125/250VAC

9" X 6" INGRESS-R.E.X TOUCH PANEL COLUMN

List

Fully Active 22-1/2 Sq. Inch Actuation Area
Recommended Centerline mounting height 34" to 48"

Material: Sturdy 1/8" extrusion with architectural finish
Overall Size: 9" h x 6" w x 1-1/2" d (229 x 152 x 38mm)
Active Area: 9" h x 2-1/2" w (229 x 63.5mm)

SPDT Model	Description			
482AA9	Push to Open			292.00
SPECIFY FINISH				
V	628 Aluminum (standard), blue infill	N/C	X	613 Dark Bronze, white infill 24.00

Add to List

36" X 6" INGRESS-R.E.X TOUCH PANEL COLUMN

List

Fully Active 90 Sq. Inch Actuation Area
Recommended mounting height is 3" from floor

Material: Sturdy 1/8" extrusion with architectural finish
Overall Size: 36" h x 6" w x 1-1/2" d (914 x 152 x 38mm)
Active Area: 36" h x 2-1/2" w (914 x 63.5mm)

SPDT Model	Description		DPDT Model	Description	
482AA36	Push to Open	404.00	484AA36	Push to Open	430.00
SPECIFY FINISH					
V	628 Aluminum (standard), blue infill		X	613 Dark Bronze, white infill	N/C

Add to List



SDG

SECURITY DOOR CONTROLS
801 Avenida Acaso • Camarillo, CA 93012
Email: Service@sdgsecurity.com • www.sdgsecurity.com

Price List Effective February 1, 2017



Wireless 4 1/2" Push Plate Switches

Includes: two Round or Square Push Plate Switches with matching surface mount back box, two wireless transmitters (400W1-433, 9V batteries included), and one wireless nano receiver (400RC433)

SPDT Model Description

482S-KIT	SQUARE 4-1/2 Push Plate Switches (2), ♿ Push to Open, blue infill, Square Surface Mount Back Boxes (2), Wireless Transmitters (2) and Wireless Receiver (1)	520.00
482R-KIT	ROUND 4-1/2 Push Plate Switches (2), ♿ Push to Open, blue infill, Round Surface Mount Back Boxes (2), Wireless Transmitters (2) and Wireless Receiver (1)	474.00

Price List Effective February 1, 2017

SDC SECURITY DOOR CONTROLS
 801 Avenida Acaso • Camarillo, CA 93012
 Email: Service@sdsecurity.com • www.sdsecurity.com



Emergency Door Release

Distributor
Discount Code

V LIST



491



492



CSFM Listed



SDC 490 series emergency door release stations include 2-SPDT contacts for release of all doors on the same circuit and remote annunciation. A built-in local alarm is standard.

491	Blue break glass station, emergency door release, 2-SPDT 10 Amp contacts with built-in local alarm (12/24V), 2 replacement glass included. Single gang box mounted	191.00
491-GL4	Four replacement glass plates for 491	21.00
491-BB	Blue surface mount box for 491	63.00
492	Blue pull station, emergency door release, 2-SPDT 10 Amp contacts with built-in local alarm (12/24V), 2 replacement glass rods included. Single gang box mounted.	156.00
492-GL4	Four replacement glass rods for 492	21.00
492-BB	Blue surface mount box for 492	42.00



SECURITY DOOR CONTROLS
801 Avenida Acaso • Camarillo, CA 93012
Email: Service@sdccsecurity.com • www.sdccsecurity.com

Communicating Bathroom Controls

Distributor
Discount Code

CK LIST



CB401-A
CB402-A



CB401-B
CB402-B

EmLock®

CB401-AU	Communicating bath switch, 630 Stainless Steel finish.	83.00
CB401-B	Emergency access switch, red. 2 Required	83.00
CB701	Emergency key switch, red	156.00

Electrified Lockset, HiTower® , or Strike Application

CB402-A	Communicating bath switch, U 630 Stainless Steel finish.	83.00
CB402-B	Emergency access switch, red. 2 Required	83.00
CB702	Emergency key switch, red	156.00

Reference page 102 for system operation and component requirements

Egress Controls

Price List Effective February 1, 2017



CB400-A



CB400-B

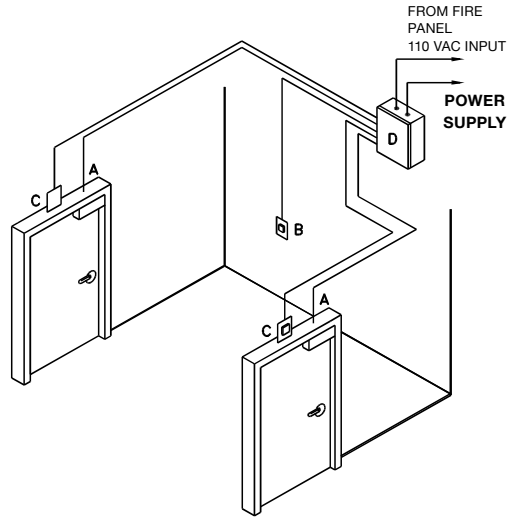

Package Components:

- (2) Electrified Locking Devices (Mortise, Cylindrical or ElectroMagnetic)
- (1) 1.5 Amp Power Supply with Universal Relay Module (631RFXUR1)
- (2) Emergency Access Push Button Switches (CB400-B)
- (1) System Activation Push Button Switch (CB400-A)
- (2) Build-in Latch or Door Position Status Sensors (DPS , L)
- (2) Power Transfer Hinges* *(not required for EMLocks) (PTH)

Every Shared Bathroom Package also includes a Riser Diagram, Components List, Method of Operation and Wiring Diagram to help you determine the materials and installation costs to complete your project bid.

Mortise Lock Option

CBP-ME-78	Communicating bath package with Eclipse style mortise Lock (Z7850LQDE)	2,659.00
CBP-MG-78	Communicating bath package with Galaxy style mortise Lock (Z7850LQDG)	2,659.00

Cylindrical Lock Option

CBP-CE-72	Communicating bath package with Eclipse style cylindrical Lock (Z7250EQ)	1893.00
CBP-CG-72	Communicating bath package with Galaxy style cylindrical Lock (Z7250GQ)	1893.00

EmLock® Option

CBP-EM-81	Communicating bath package with 650lb EMLock locking device (1581VD)	1,521.00
CBP-EM-71	Communicating bath package with 1200lb EMLock locking device (1571VD)	1,665.00
CBP-EM-11	Communicating bath package with 1650lb EMLock locking device (1511VD)	1,727.00

SECURITY DOOR CONTROLS
801 Avenida Acaso • Camarillo, CA 93012
Email: Service@sdsecurity.com • www.sdsecurity.com



Egress Controls



PTH x 5 Ft Cable



F 10B Listed for 3hr Fire Rated Door

FEATURES

- 5' Ft Cable
- UL10B Listed for 3 Hour Fire Rated Doors
- 800,000 cycles. 8 times UL test criteria
- Wire Replacement Warranty

Power Transfer Hinge Application

Installed in the center hinge position of the door, PTH Power Transfer Hinges provide the concealed wires required to transfer power from the frame to electric hardware in the door for control and monitoring capability.

PTH-4Q	Four (4) Conductor Power Transfer Hinge 1 Amp @ 12/24V per pair 4.5" x 4.5" standard weight, 626 Dull Chrome	150.00
PTH-4Q-DPS	Four (4) Conductor Power Transfer Hinge with Door Status Contact 1 Amp @ 12/24V per pair Door Status Contact: 250 mA @ 30VDC 4.5" x 4.5" standard weight, 626 Dull Chrome	207.00
PTH-10Q	Ten (10) Conductor Power Transfer Hinge 1 Amp @ 12/24V per pair 4.5" x 4.5" standard weight, 626 Dull Chrome	202.00
PTH-10Q-DPS	Ten (10) Conductor Power Transfer Hinge with Door Status Contact 1 Amp @ 12/24V per pair Door Status Contact: 250 mA @ 30VDC 4.5" x 4.5" standard weight, 626 Dull Chrome	259.00
FOR ELECTRIC LATCH RETRACTION EXIT DEVICES AND OTHER HIGH INRUSH DEVICES		
PTH-2+4Q	16 Amp Inrush , 6 conductor power transfer hinge 1-pair 16 Amp inrush, 4 Amp continuous; 2-pair 1 Amp @ 12/24V 4.5" x 4.5" standard weight, 626 Dull Chrome	182.00
PTH-2+4QDPS	16 Amp Inrush , 6 conductor power transfer hinge, with door status contact 1-pair 16 Amp inrush, 4 Amp continuous; 2-pair 1 Amp @ 12/24V Concealed Door Position Contact, 250 mA @ 30VDC 4.5" x 4.5" standard weight, 626 Dull Chrome	233.00

Special Order Sizes and Heavy Weight Hinges

POA

SPECIFY FINISH

Dull Chrome finish is standard as specified by suffix Q.

To specify special finish, designate finish suffix below in lieu of Q.

C 605 Bright brass	H 613 Oil rubbed bronze	P 625 Bright Chrome	N/C
---------------------------	--------------------------------	----------------------------	------------



SECURITY DOOR CONTROLS
801 Avenida Acaso • Camarillo, CA 93012
Email: Service@sdccsecurity.com • www.sdccsecurity.com

Price List Effective February 1, 2017

PTM Heavy Duty Series Electric Power Transfer Device

Distributor Discount Code **LZK LIST**



Miscellaneous Fire Door Accessories
UL 10C 3 Hr Fire Rated
Classified per UBC 7-2



PTM-2AL	Two (2) Conductor Power Transfer Device: Two (2) 18 Ga. wires 5 Amp @ 12/24V AC/DV Aluminum Powder Coat, US28 equivalent	371.00
PTM-2BZ	Two (2) Conductor Power Transfer Device: Two (2) 18 Ga. wires 5 Amp @ 12/24V AC/DV Dark Brown Powder Coat, US10B equivalent	371.00
PTM-10AL	Ten (10) Conductor Power Transfer Device: Ten (10) 24 Ga. wire 1 Amp @ 12/24V AC/DC Aluminum Powder Coat, US28 equivalent	371.00
PTM-10BZ	Ten (10) Conductor Power Transfer Device: Ten (10) 24 Ga. wire 1 Amp @ 12/24V AC/DC Dark Brown Powder Coat, US10B equivalent	371.00

Concealed Power Transfer Device



LIST

PT5



Miscellaneous Fire Door Accessory

PT-5	UL Listed Concealed Power Transfer Device, for use with all high and low current applications	63.00
-------------	---	--------------

Also recommended for use with Von Duprin* EL 33 and 99 series and other high inrush devices
*Von Duprin is a registered trademark of Ingersol Rand and Von Duprin. Not intended as endorsement.

Power Transfer Loops

Distributor Discount Code **V LIST**



PT-2U



PT-3V

PT-2U	Armored flex conduit, less wires, 18" long, 1/4" I.D.	20.00
PT-3V	Armored flex conduit, less wires, with wire junction box, 20" long, 1/4" I.D.	47.00
PT-3/8V	Armored flex conduit, less wires, with wire junction box, 20" long, 3/8" I.D.	63.00

Door Core Drill Guide

Distributor Discount Code **LZK LIST**

The SDC 7000-DG Laser Guided Wire Raceway Drill Fixture enables wire raceway preparation through particle filled and solid wood doors. The door core wire raceway permits the installation and wiring of electrified locksets, exit devices and electric hinges. The Laser Guided Wire Raceway Drill Fixture is easy to use without previous experience. The kit allows for drilling from the hinge side without removing the door from the frame.

The **7000-DGK Kit** includes: **Laser Guided Door Core, Raceway Fixture, 1/4" x 6" Pilot Drill Bit, 3/8" x 50" Door Raceway Drill Bit** (Custom designed evacuator drill bit tool sharpened with 1' extra long flutes), **Fiberglass Wire Running Kit** (Flexible acrylic end connection, Brass hook end for pulling, Brass eye end for pushing), **Door Wedge, Kit Carry Case**

7000-DGK	Laser door core drill guide Kit	621.00
7000-DB3/8	3/8" x 50" evacuator drill bit	78.00
7000-PD 1/4 X 6	1/4" x 6" pilot drill bit	25.00



1/4 x 6" Pilot Drill Bit

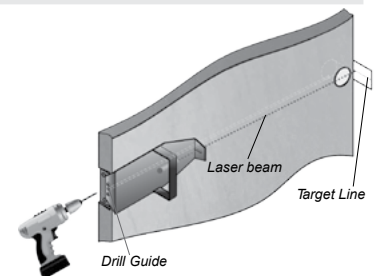
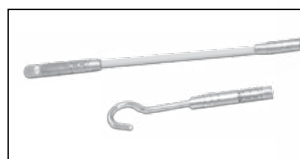

3/8" x 50" Evacuator Drill Bit - Custom Designed for Door Raceways

Extra Long 1 Ft. Flute

602RF(A)(L) and 631RF(A)(L) tested according to UL Standard 1481, listing includes:

Access Control Systems Unit ALVY Burglar Alarm Systems Power Supply APHV
 Releasing Device Accessory SYSW Fire and Burglar Alarm Power Supply URTZ

632RF(A)(L) Access Control Systems Unit ALVY

632RF(A)(L), 634RF and 636RF UL listed as:
 General Purpose QQFU/QQFU7 Power Supply

BATTERIES SOLD SEPARATELY



SECURITY DOOR CONTROLS
 801 Avenida Acaso • Camarillo, CA 93012
 Email: Service@sdgsecurity.com • www.sdgsecurity.com

Price List Effective February 1, 2017

STANDARD FEATURES:

- Modular design
- Filtered and regulated output
- Field selectable 12/24VDC
- Fire/Emergency release input
- Field selectable manual reset input (n/a with 631RF(A))
- Input, output and battery LED status indicators
- Thermal and short circuit protection with auto reset
- Battery charger
- Low battery disconnect

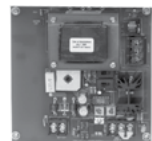

602RFL



631RFL



632RFL



602RF / 631RF



632RF
 with optional power cord
 and 2 - CR4 modules



631RFA
 632RFA



634RF
 636RF



12VR

FIELD SELECTABLE 12VDC OR 24VDC OUTPUTS

LIST

602RFL	1 Amp, class 2 output, less box	218.00
602RF	1 Amp, class 2 output, 12" W x 12" H x 3.75" D box	270.00
602RFA	1 Amp, class 2 output, 16" W x 14" H x 6.5" D box	383.00
631RFL	1.5 Amp, class 2 output, less box	270.00
631RF	1.5 Amp, class 2 output, 12" W x 12" H x 3.75" D box	363.00
631RFA	1.5 Amp, class 2 output, 16" W x 14" H x 6.5" D box	435.00
632RFL	2 Amp, class 2 output, less box	321.00
632RF	2 Amp, class 2 output, 12" W x 12" H x 3.75" D box	414.00
632RFA	2 Amp, class 2 output, 16" W x 14" H x 6.5" D box	477.00
634RF	4 Amp, field select one 4 Amp output, or two 2 Amp class 2 outputs	621.00
636RF	6 Amp, field select one 6 Amp output, or three 2 Amp class 2 outputs	725.00

DUAL 12VDC AND 24VDC OUTPUT CAPABILITY

Add to List

12VR	500mA, 12VDC regulated and filtered output module With the power supply output set at 24VDC for locking devices and components, the addition of the 12VR provides a separate 12VDC 500 mA output for access controls or other 12VDC devices	52.00
-------------	--	--------------

OPTIONS

Add to List

MR	Manual reset switch for Fire/Emergency release <i>(not available on 631RF)</i>	38.00
PS-1	System On-Off push switch inside power supply enclosure	38.00
PS-1A	System On-Off push switch on enclosure cover	38.00
14-2	7 day - skip a day programmable timer. Automatically unlocks and locks all doors or specific doors on programmed days only.	249.00
PC	6 ft. power cord. Recommended for 1 Amp and 1.5 Amp, eliminating the need for AC conduit	38.00
KL	Key lock cover	38.00
220V/230V	230VAC, 50/60Hz	N/C

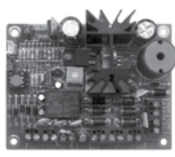

621B

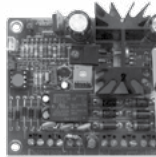

621P



2 Control Relays Standard



621PJ

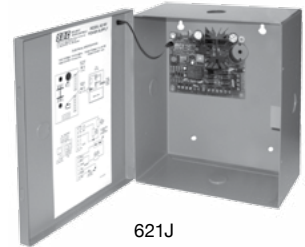

621J



621P-UME

FEATURES

- 12VDC or 24VDC field selectable output
- 1 Amp maximum, filtered and regulated output
 - 1 power limited or lock control relay output
 - 1 power limited unswitched access control output
- Two control inputs
 - 1 lock control trigger input, normally open (NO)
 - 1 supervised emergency release input (latching w/reset or non-latching)
- Short circuit and thermal overload protection
- Battery charger output
- Automatically switched to battery back-up when AC fails
- Board equipped with AC input, DC output and battery status LED indicator
- Enclosure equipped with AC input, DC output and battery status LED indicator

Dimensions

Power Supply Board: 3.95" W x 3" H x 1.625" D
 Enclosure: 7.25" W x 8.375" H x 3.625" D

MODEL	LIST
621PJ Power supply module and cabinet, door mount LED system status indicator UL Listed 24VAC, 40 VA plug-in transformer	202.00
621J Power supply module, cabinet with door mounted LED system status indicator	182.00
621P Power supply module, retrofit mounting hardware includes flush mount standoffs or Velcro. UL Listed 24VAC, 40 VA plug-in transformer	145.00
621B Power supply module only, retrofit mounting hardware includes flush mount standoffs or Velcro	125.00



RB12V4
4 Amp Hour



RB12V7
7 Amp Hour

BATTERIES

RB12V4 12V/4Ah Battery. 621PJ accommodates two.	42.00
RB12V7 12V/7Ah Battery. 621PJ accommodates one.	63.00

UME Universal Module Enclosure

NK



Universal Module Enclosure for single modules
 Universal mounting standoffs will accommodate
 FB-4, UR-1, 12VR, ACM-1, PB-16, PB-8, PSM, 621B, or LR100EM boards.
 Box Dimensions: 5-5/8"H x 7-11/16"W x 3-3/8"D

UME Single module enclosure	32.00
------------------------------------	--------------

Price List Effective February 1, 2017

SDC SECURITY DOOR CONTROLS
 801 Avenida Acaso • Camarillo, CA 93012
 Email: Service@sdsecurity.com • www.sdsecurity.com

Power Supply & Door Controllers



UR-1

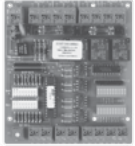

UR2-4

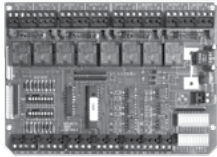

UR4-8



"Security Industry Finest"
ISC Expo



FB-4

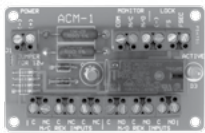

ACM-1



CR4



PB-8



PSM



RB12V4
4 Amp Hour



RB12V7
7 Amp Hour

UNIVERSAL CONTROLLER & MANTRAP MODULES

LIST

- UR-1** Universal Controller for up to 2 doors. 12 Selectable Relay & System Logic Modes. 2 form "A" SPST, N.O. Inputs, 2 form "C" SPST outputs 5 Amps, 12/24 @ 120/175mA. **100.00**
- UR2-4** Universal Controller for 2 doors. Field select TD, LR, TD/LR, mantrap A, B, C interlock. Two fused SPDT outputs, 5 Amp @ 30VDC. Two SPDT outputs, 5 Amp @ 30VDC. Two inputs per station, four auxiliary inputs. **228.00**
- UR4-8** Universal Controller for 4 doors. Field select TD, LR, CR, TD/LR, mantrap A, B interlock. Four fused SPDT outputs, 5 Amp @ 30VDC. Four SPDT outputs, 5 Amp @ 30VDC. Two inputs per station, four auxiliary inputs. **321.00**

DOOR CONTROL MODULES

LIST

Modules may be ordered with or without power supplies. Different function modules may be used in the same power supply or cabinet. Contacts: 2.5 Amps inductive, 5 Amps resistive @ 30VDC unless specified otherwise.

- FB-4** Fused terminal board. 4 individually fused outputs **42.00**
- ACM-1** Access Control Module. One SPDT voltage output, one SPDT status output, eight trigger inputs, (3N/C, 3N/O), LED status indicator. **94.00**
- CR4** Control Board with four relays. Four fused SPDT field selectable wet or dry outputs, four non-fused SPDT outputs, 2 Amps @ 30VDC, four dry contact trigger inputs. **171.00**
- PB-8** Power booster for high inrush electric panic devices and locks. 1 Amp continuous @ 24VDC, 8 Amp surge output. **125.00**
- PB-16** Power booster for high inrush electric panic devices and locks. 1 Amp continuous @ 24VDC, 16 Amp surge output. **156.00**

POWER SUPPLY MONITORING

LIST

- PSM** Power Supply Monitoring Module **228.00**
For remote monitoring of power supply AC input, DC output and battery backup On/Off status. 2 SPDT Relay Outputs, 1 Amp @ 12/24VDC

EXIT DEVICE SEQUENCER

LIST

- EMC** Sequencer Module required for pair of doors and automatic doors. 12/24 VDC For use with SDC 602RF and 632RF Power Supplies. **156.00**

BATTERIES

LIST

- RB12V4** 12V/4Ah Battery. Specify in pairs for 24V. 600RF accommodates four. **42.00**
- RB12V7** 12V/7Ah Battery. Specify in pairs for 24V. 600RFA accommodates six **63.00**

Cabinet Control Module Capacity

	Number of Batteries	ACM-1	CR	CR-4	FB-4	LR	PB	UR	PSM
12x12	0-2	2	4	2	4	4	2	0	1
	3-4	1	2	1	2	2	2	0	1
16x14	0-2	4	8	4	4	8	6	2	1
	3-6	2	6	2	2	4	4	1	1



SECURITY DOOR CONTROLS
801 Avenida Acaso • Camarillo, CA 93012
Email: Service@sdccsecurity.com • www.sdccsecurity.com

Price List Effective February 1, 2017

Power Supply & Door Controllers

DC Regulated Power Supplies



Distributor Discount Code **V LIST**



TR12 1 Amp 12VDC Regulated Plug-In Power Supply

75.00

- Thermal overload protection
- LED Power status indicator
- Secondary connection: Screw terminals
- Primary Input: 120VAC
- UL Listed, Class 2



TR24 1 Amp 24VDC Regulated Plug-In Power Supply

77.00

- Thermal overload protection
- Secondary connection: 6ft wire leads
- Primary Input: 120VAC
- UL Listed, Class 2

Price List Effective February 1, 2017

Transformers



Distributor Discount Code **V LIST**



TP1220 1.6 Amp 12VAC Plug-In Transformer

21.00

- Thermal overload protection
- Secondary connection: Screw terminals
- Thermal overload protection
- Primary Input: 120VAC
- UL Listed, Class 2



TP2440 1.6 Amp 24VAC Plug-In Transformer

38.00

- Thermal overload protection
- Secondary connection: Screw terminals
- Thermal overload protection
- Primary Input: 120VAC
- UL Listed, Class 2



BR64XL Bridge Rectifier, 6" wire leads. Converts AC transformer output to DC

26.00

SDC
SECURITY DOOR CONTROLS
 801 Avenida Acaso • Camarillo, CA 93012
 Email: Service@sdsecurity.com • www.sdsecurity.com

Power Supply & Door Controllers

Power Supply Capacity Chart

EMLOCK ELECTROMAGNETIC LOCKS	VOLTS	AMPS	602RF 621 1 AMP	631RF 631RFA 1.5 AMP	632RF 632RFA 2 AMP	634RF 4 AMP	636RF 6 AMP
1511 SINGLE	12VDC 24VDC	.70A .35A	1 2	2 4	2 5	5 11	8 17
1512 DOUBLE	12VDC 24VDC	1.40A .70A	0 1	1 2	1 2	3 5	4 8
1561, 1562	12VDC 24VDC	.65A .35A	1 2	2 4	3 5	6 11	9 17
1565, 1566	12VDC 24VDC	.80A .40A	1 2	1 3	2 5	5 10	7 15
1571 ENERGY SAVER	12VDC 24VDC	.25A .125A	4 8	6 12	8 16	16 31	24 48
1572 ENERGY SAVER	12VDC 24VDC	.50A .25A	2 4	3 6	4 8	8 16	12 24
1575, 1576	12VDC 24VDC	.45A .225A	2 4	3 6	4 8	8 16	12 24
1581 SINGLE	12VDC 24VDC	.44A .22A	2 4	3 6	4 6	9 18	13 27
1582 DOUBLE	12VDC 24VDC	.88A .44A	1 2	1 3	2 4	4 9	6 13
EXIT CHECK INTEGRATED DELAYED EGRESS EMLOCKS							
1581S	12VDC 24VDC	.50A .32A	2 3	3 4	4 6	8 11	12 18
1511S	12VDC 24VDC	.83A .45A	1 2	1 3	2 4	4 8	6 12
1511T	12VDC 24VDC	1.56A .92A	0 1	0 1	1 2	2 4	3 6
1511S With (E) Energy Saver Option	12VDC 24VDC	.40A .275A	2 3	3 5	5 7	10 14	15 21
1511T With (E) Energy Saver Option	12VDC 24VDC	.65A .40A	1 2	2 3	4 5	6 10	9 15
EXIT CHECK EMLOCK WITH WALL MOUNT CONTROLLER							
101-DE x 1511DE	12VDC 24VDC	.85A .53A	1 1	1 2	2 3	4 7	7 11
ENERGY SAVER 101-DE x 1571DE	12VDC 24VDC	.43A .31A	2 3	3 4	4 6	9 12	13 19
101-DE x 1581DE	12VDC 24VDC	.62A .40A	1 2	2 3	3 5	6 10	9 15



SECURITY DOOR CONTROLS
 801 Avenida Acaso • Camarillo, CA 93012
 Email: Service@sdcsecurity.com • www.sdcsecurity.com

Price List Effective February 1, 2017

Power Supply Capacity Chart (continued)

HITOWER ELECTRIC LOCKS	VOLTS	AMPS	602RF 621 1 AMP	631RF 631RFA 1.5 AMP	632RF 632RFA 2 AMP	634RF 4 AMP	636RF 6 AMP
7200	12VDC 24VDC	.60A .30A	1 2	2 5	3 6	6 13	10 21
7500 FAIL SAFE	24VDC	.50A	2	3	4	8	12
7500 FAIL SECURE	24VDC	.80A	1	1	3	5	7
7800	12VDC 24VDC	.60A .30A	1 2	2 5	3 6	6 13	10 20
SPACESAVER ELECTRIC BOLT LOCKS							
100,1000, FS	12VDC 24VDC	.90A .45A	1 2	1 3	2 4	4 8	6 12
1100	24VDC	.50A	2	3	4	8	12
1200	12VDC 24VDC	.90A .45A	1 2	1 3	2 4	4 8	6 12
2000	24VDC	2.5A InRush .4A Cont.	1 1X-PB	*2 1XPB-8	*4 2XPB-8	*6 3XPB-8	*8 4XPB-8
ELECTRIC STRIKES							
15	12VDC	.20A	4	7	10	20	30
25	12VDC 24VDC	.30A .15A	3 6	5 10	6 13	13 26	20 40
30	12VDC 24VDC	.51A .25A	1 4	2 6	3 8	7 16	11 24
45	12VDC 24VDC	.28A .14A	3 6	5 10	6 13	13 26	20 40
EXIT DEVICES							
E Electric Latch Retraction with 1 EMC Sequencer with 2 EMC Sequencers	24VDC	.7A	1 1	2 2	4 4	8	12
B Exit Alarm	12VDC 24VDC	.100A .100A	10 10				
M Electric Mortise Device	12VDC 24VDC	.6A .3A	1 3	2 5	3 6	6 13	10 20

Price List Effective February 1, 2017

SDC SECURITY DOOR CONTROLS
801 Avenida Acaso • Camarillo, CA 93012
Email: Service@sdsecurity.com • www.sdsecurity.com





SDC's WRC Series 2-Channel wireless transmitter/receiver solution is specifically designed to be used as a receptionist button or remote release for single or dual door access control applications.

433MHZ 2-BUTTON PENDANT TRANSMITTER

LIST



- Operates with 400WRC-R2
- Frequency: 433.92MHz
- Housing: Keychain type
- Voltage: 6VDC

- Battery Replacement: – CR2016 Button Cell 3V Lithium battery (x 2)
- Transmitting distance: 160 feet (no obstructions)
- Activation: Hold “A” or “B” button for 1 sec.

Model	Description	
WRC-2B	433MHz 2-Button Pendant Wireless Transmitter	50.00



433MHZ 2-CHANNEL RECEIVER

LIST

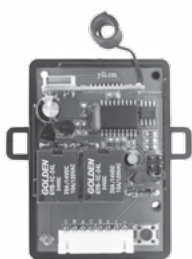

- Size with housing (approx.): 2.5" H x 1.75" W x 1.2" D
- Frequency: 433.92MHz
- Environmental: Indoor
- Operating Temperature: -22°F – 140°F
- Input Voltage: 24VDC
- Current consumption: 9mA @24VDC (standby); 46mA (max)

- Relay Outputs: Two (2) Dry, Form C (SPDT)
- Contact rating: 10A@30VDC (resistive)
- Wiring connections: 12", 8-wire pigtail
- Transmitter coding capacity: 30 (fixed code)
- Transmitter programming using onboard learning button and status LED

Model	Description	
WRC-R2	433MHz 2-Channel Wireless Receiver	81.00



Mini Consoles

Distributor Discount Code

WK LIST

Mini Consoles provide control for one or two doors. Momentary or maintained push button switches with Bi-Color LED indicators.

Dimensions: 4-1/8" W x 3-1/8" H x 6-1/4" L
Contacts: 5 Amp @ 30VDC

Color: Beige
Power: 24VDC @ 0.02 Amp required for each LED



DTMO-1	One momentary switch and one LED	207.00
DTMO-2	Two momentary switches and two LEDs	259.00
DTMOMA-2	One momentary, one maintained switch and two LEDs	311.00
DTMA-2	Two maintained switches and two LEDs	259.00

Modular Control Consoles

Distributor
Discount Code

WK LIST



TCC AL8 AL4E



RCC AL8 AL8 AL4E

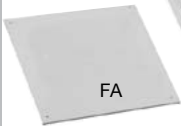

TCC	Slope front desk top console 12 stations maximum when using 2 control panels. Base unit, less panel. Color: black sides and beige top Dimensions: 10-1/4"W x 4-3/4"H x 9-5/8"D	311.00
RCC	Rack mount console. 24 stations maximum when using three control panels. (Maximum is 20 stations with "E" panel) Base unit, less panels. Color: Beige Dimensions: 19"W x 5-1/4"H x 6"D	673.00

Chassis less switches and light panels.

SPECIFY SWITCH AND INDICATOR PANELS Add to List

	Rocker Switch Rating: 3 Amp @ 30VDC	Power Required per LED: 24VDC @ 0.02 Amp	
AL4	Four momentary switches with LEDs		518.00
BL4	Four maintained switches with LEDs		518.00
CL4	Four momentary/off/maintained switches with LEDs		518.00
DL4	Four momentary/off/momentary switches with LEDs		518.00
AL8	Eight momentary switches with LEDs		880.00
BL8	Eight maintained switches with LEDs		880.00
CL8	Eight momentary/off/maintained switches with LEDs		880.00
DL8	Eight momentary/off/momentary switches with LEDs		880.00
AL4E	Four momentary switches with LEDs, alarm, reset push button and key lock		621.00
BL4E	Four maintained switches with LEDs, alarm reset push button and key lock		621.00
CL4E	Four momentary/off/maintained switches with LEDs, alarm, reset push button and key lock		621.00
DL4E	Four momentary/off/momentary switches with LEDs, alarm, reset push button and key lock		621.00
EA	Panel with alarm, reset push button and key lock		259.00
FA	Blank panel		47.00

CABINETS Add to List

CAB7	Black cabinet for one RCC 7"H x 20-1/2"W x 14-1/2"D	596.00
CAB12	Black cabinet for two RCC 12-1/2"H x 20-1/2"W x 14-1/2"D	803.00

Desk Switch Compact Box

Distributor
Discount Code

DK LIST



15-2



15-1	AA, SPDT push switch, 6 Amp @ 30VAC/DC	114.00
15-2	MO, SPDT push switch, 10 Amp @ 30VAC/DC	78.00
15-3	AA, SPDT toggle switch, 6 Amp @ 30VAC/DC	135.00
15-2-3	(1) MO push switch and (1) AA (on/off) toggle SPDT, 6 Amp @ 30VAC/DC	192.00

Price List Effective February 1, 2017

SDC SECURITY DOOR CONTROLS
 801 Avenida Acaso • Camarillo, CA 93012
 Email: Service@sdsecurity.com • www.sdsecurity.com



Remote Controls

DOOR PROP ALARM

Distributor Discount Code **CK List**

Improve security with a cost-effective door prop alarm. All SDC door prop alarms feature audible sirens with adjustable timer settings, two outputs, bypass status indicator light, and vandal-resistant aluminum construction. Available to install in single gang or double gang enclosures, SDC door prop alarms also offer optional Keylock and Mortise Cylinder Reset/Bypass Switches.

- Adjustable Timed Delay
- Exit Alarm on Door Opening
- Automatic or Manual Alarm Reset
- Output Relays
- Integral Tri-color LED Status Indicator
- Optional Key Reset/Bypass Switch
- Compact Universal Mounting
- 85dB Piezo Buzzer Alarm

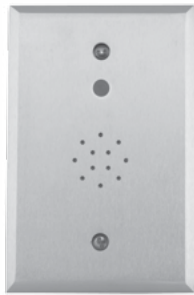

EA-SN

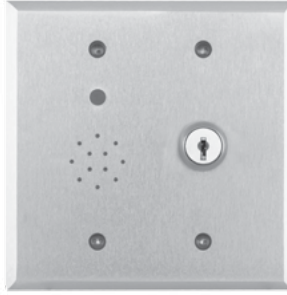

EA-728

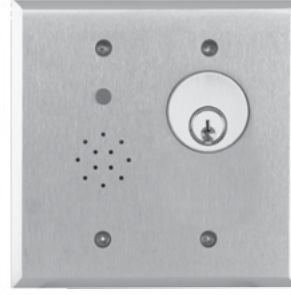

EA-708

Model	Description	
EA-SN	Door Prop Alarm, Single Gang w/ integral Status LED & Audible Alarm	220.00
EA-728V	Double Gang w/ integral Status LED, Audible Alarm & Keylock Switch for Reset/Bypass	280.00
EA-708V	Double Gang w/ integral Status LED, Audible Alarm & Mortise Key Cylinder Switch for Reset/Bypass, Cylinder not included	310.00

KEY CYLINDER OPTIONS for EA-708

Add to List



CYL-6KDQ	6 pin, 1.125" mortise cylinder, keyed different, dull chrome	32.00
CYL-6KAQ	6 pin, 1.125" mortise cylinder, keyed alike, dull chrome	32.00

EA100 Exit Annunciators

LIST

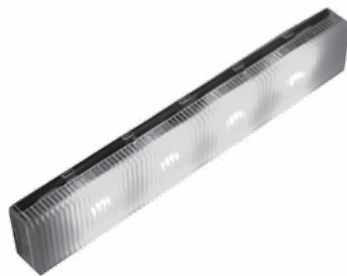

The **SDC Exit Annunciator™** is a highly visible multi-color signal device, that interfaces with Delayed Egress or standard EMLocks, plus many other manufactures electromagnetic locks. and can be used as a wall, ceiling, or frame mount indicator.

FEATURES

- Easy to install
- Suitable for retrofit or new construction
- Multi color LED technology
- Externally selectable color modes of Red, Green, Blue, White, Yellow and Purple
- Externally selectable Solid or Flashing Modes

SPECIFICATIONS

Dimensions 8-5/8" x 1-1/2" x 3/4"

Electrical 12/24 VDC @ 160mA

LED Output Long Life

Includes optional **Illuminating Hood** for greater side-visibility



Brand Compatibility

SDC	Schlage	RCI	Securtron
Rofu	Secolarm	Dynalock	Door King

Stand Alone Multi-Mount

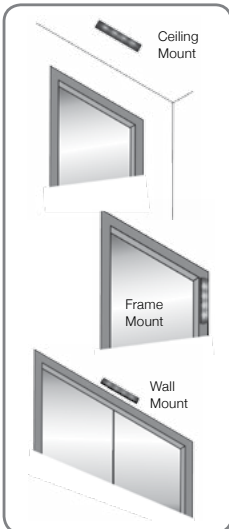

EA100	Highly visible Annunciator Bar with multiple color LED light featuring rolling signals.	182.00
--------------	---	--------

Typical Application

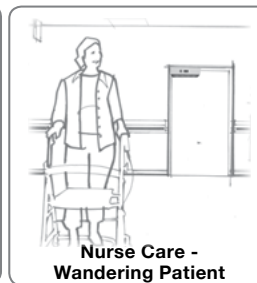

SDC

SECURITY DOOR CONTROLS
801 Avenida Acaso • Camarillo, CA 93012
Email: Service@sdsecurity.com • www.sdsecurity.com

Price List Effective February 1, 2017

Annunciators

Sirens and Buzzers

Distributor Discount Code **CK LIST**



400-SN



400-RMB

Standard Finish 630 Stainless Steel

400U-RMB	Buzzer on 1 gang plate. Specify 12/24VDC, 20mA max	47.00
400NU-RMB	Buzzer on narrow plate. Specify 12/24VDC, 20mA max	47.00
400U-SN	Siren on 1 gang plate, 3 - 28VDC, 18mA max	57.00
400NU-SN	Siren on narrow plate, 3 - 28VDC, 18mA max	57.00

Wall Mount Indicator

Distributor Discount Code **CK LIST**



400U-L2



400NU-L2

Standard Finish 630 Stainless Steel

400U-L2	Two LEDs. Specify lens color. Standard Finish, on 1 gang plate	47.00
400NU-L2	Two LEDs. Specify lens color. Standard Finish, on narrow plate	47.00
400U-L3	Three LEDs. Specify lens color. Standard Finish	57.00
400U-LT1	One tricolor LED. Red, Green and Amber. Standard Finish	47.00
400U-LT2	Two tricolor LED. Red, Green and Amber. Standard Finish	57.00

101 Series Annunciators

LIST



101-1A

101-1A	Remote or local single door annunciator with audible alarm and tricolor LED, 1 Gang Green - Secure Amber - Egress initiated Red - Door unlocked	109.00
---------------	--	---------------



101-4AM

101-4AM	Remote four door annunciator with audible alarm mute button. Four tricolor LEDs, 2 Gang Green - Secure Amber - Egress initiated Red - Door unlocked	332.00
----------------	--	---------------



101-1AK

101-1AK	Remote or local single door annunciator with 2 function key switch for on/off, reset, audible alarm and tricolor LED, 2 Gang Green - Secure Amber - Egress initiated Red - Door unlocked Accepts standard 1-1/8" to 1-1/4" mortise key cylinder. <i>(Mortise key cylinder not included)</i>	332.00
----------------	--	---------------

KEY CYLINDER OPTIONS for 101-1AK

Add to List



CYL-6KDQ	6 pin, 1.125" mortise cylinder, keyed different, dull chrome	32.00
CYL-6KAQ	6 pin, 1.125" mortise cylinder, keyed alike, dull chrome	32.00



101-PAM

101-PAM	Remote single door annunciator with 3 push button switches for momentary access. On/off and audible alarm mute button with tricolor LED, 2 Gang Green - Secure Amber - Egress initiated Red - Door unlocked Recommended for remote installation only	332.00
----------------	--	---------------



101-SP

101-SP	External 15 watt speaker connects directly to 1511S or 1511T for enhanced decibels onsite or remote voice message annunciation. Speaker driver may be provided by others for extreme decibel requirements.	38.00
---------------	--	--------------



101-SPSN

101-SPSN	Remote Single Gang Annunciator with speaker and 80db tone. Duplicates ExitCheck alternating voice message and tone.	100.00
-----------------	---	---------------

EH Series Magnetic Door Holder & Releasing Device

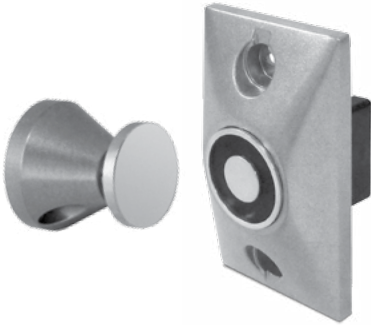
 Distributor
Discount Code **V**

SDC EH Series Magnetic Door Holders, are designed to hold doors open and release the door by remote switch or fire life safety command center activation. Primary application includes holding and releasing of fire rated doors that are required to provide a barrier for fire and smoke in an emergency or the convenience of door closure by remote control.



SPECIFICATIONS

Materials	Zinc alloy	Total Projection	Flush mount: 2-11/32" (60mm) Semi-Flush mount: 3-1/16" (78mm) Surface mount: 4-5/8" (117mm) Floor mount (single door): 5" (127mm) Floor mount (double door): 9-5/8" (244mm)
Voltage	Standard dual voltage AC or DC inputs of 12&24V, 24&120V, 24&220V models	Fasteners	Hardware package, mounting bracket
Holding Force	Typical holding force of 25-40 pounds; field selectable high holding force		
Mount	Single or double floor, surface, flush, and recessed mount		

Performance Data

Model	Voltage	DC/mA	AC/mA	Terminals	LB.	KG.
1224	12V	40	38	C&L	30	13.6
	24V	40	36	C&H	30	13.6
24120	24V	20	19	C&L	40	18.1
	120V	—	20	C&H	35	15.8
24220	24V	20	19	C&L	40	18.1
	220V	—	15	C&H	25	11.3

HIGH HOLDING FORCE / SPECIAL APPLICATIONS

Model	Voltage	DC/mA	AC/mA	Terminals	LB.	KG.
1224	24V	85	81	C&L	75	34.0
24120	120V	—	100	C&L	110	49.8

To obtain performance values in high holding force table above apply high listed voltage to low voltage terminals (C & L). NOTE: This configuration can only be applied to models 1224 & 24120.



SPECIFY MODEL

Model	Description	Price
EH10	Flush Mount	135.00
EH20	Semi-Flush Mount	104.00
EH30	Surface Mount	151.00
EH40	Floor Mount, Single	195.00
EH42	Floor Mount, Double	244.00

SPECIFY VOLTAGE

Voltage	Description	Price
1224	12/24VAC/DC	N/C
24120	24VAC/DC/120VAC	N/C
24220	24VAC/DC/220VAC	N/C

SPECIFY FINISH

Finish	Description	Price
A	Chrome Powder Coat	N/C
P	625 Chrome Plated	P.O.A.
C	605 Brass Plated	21.00

Example: EH20 24120A

SECURITY DOOR CONTROLS
801 Avenida Acaso • Camarillo, CA 93012
Email: Service@sdccsecurity.com • www.sdccsecurity.com

Price List Effective February 1, 2017

EH Series Magnetic Door Holder & Releasing Device Accessories

Distributor Discount Code **V**

Accessories

Price List Effective February 1, 2017

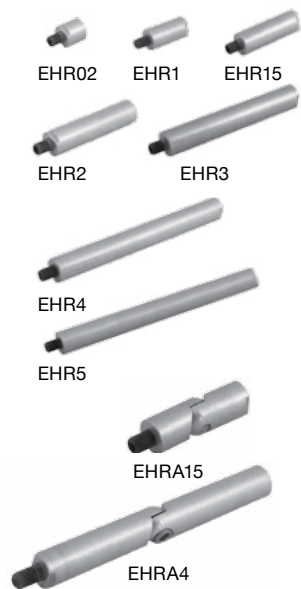

EXTENSION RODS

LIST

Refer to Figure A to determine correct rod length for each individual openings installation and adjustability requirements

Model	Description	
EHR02	1/2" Extension Rod	21.00
EHR1	1" Extension Rod	21.00
EHR15	1-1/2" Extension Rod	25.00
EHR2	2" Extension Rod	32.00
EHR3	3" Extension Rod	32.00
EHR4	4" Extension Rod	42.00
EHR5	5" Extension Rod	52.00

ADJUSTABLE EXTENTION ROD

LIST

Model	Description	
EHRA15	1-1/2" Adjustable Extension Rod	25.00
EHRA4	4" Adjustable Extension Rod	42.00

SPECIFY FINISH

Add to List

Finish	Description	
A	Chrome Powder Coat	N/C
P	625 Chrome Plated	P.O.A.
C	605 Brass Plated	13.00

OPTIONS & ACCESSORIES

LIST

Model	Description	
EHBB	Surface Back Box 2-25/32" x 4-7/8" x 1-1/2" (71mm x 124mm x 38mm) Supplied with EH30, EH40, EH42	42.00
EHCP	Catch Disk Only Replacement for the catch plate assembly	32.00
EHSBA	Catch Plate Assembly	52.00
EHDF	Drilling Fixture Attach to door for quick and accurate hole location	207.00
EHW	Extension Wrenches Used to tighten extension rods to catch plate assembly	6.00

SPECIFY FINISH FOR SURFACE BACK BOX EHBB

Add to List

Finish	Description	
A	Chrome Powder Coat	N/C
P	625 Chrome Plated	P.O.A.
C	605 Brass Plated	38.00

How To Determine Extension Rod & Adjustable Rod Length

Extensions Rod Application: Refer to Fig. A for Aligned Catch Plate and Door Holder
Adjustable Rod Application: Refer to Fig. B for Misaligned Catch Plate and Door Holder

1. Hold door open at desired position.
2. Measure distance between door and wall.
3. Subtract below dimension indicated for door holder style

Flush Mount: Subtract 3" (76mm) from measured distance to determine minimum rod length.
Recessed Mount: Subtract 2-3/8" (60mm) from measured distance to determine minimum rod length.
Surface Mount: Subtract 4-5/8" (76mm) from measured distance to determine minimum rod length.

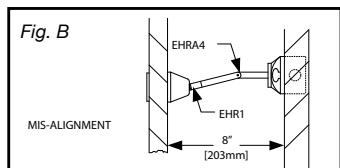
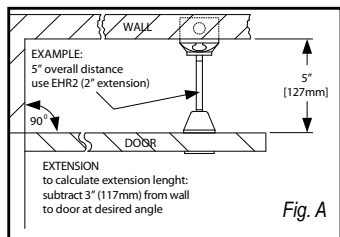
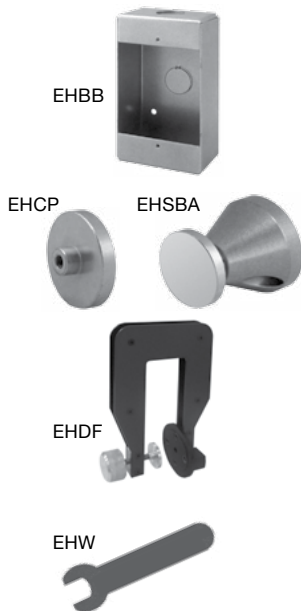
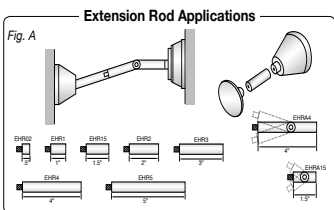

WRC SERIES 2-Channel Wireless Transmitter and Receiver



CK LIST



SDC's WRC Series 2-Channel wireless transmitter/receiver solution is specifically designed to be used as a receptionist button or remote release for single or dual door access control applications.



433MHZ 2-BUTTON PENDANT TRANSMITTER LIST

- **Operates with 400WRC-R2**
- **Frequency:** 433.92MHz
- **Housing:** Keychain type
- **Voltage:** 6VDC
- **Battery Replacement:** – CR2016 Button Cell 3V Lithium battery (x 2)
- **Transmitting distance:** 160 feet (no obstructions)
- **Activation:** Hold "A" or "B" button for 1 sec.

Model	Description	
WRC-2B	433MHz 2-Button Pendant Wireless Transmitter	50.00

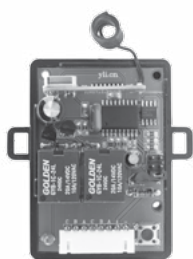

433MHZ 2-CHANNEL RECEIVER LIST

- **Size with housing** (approx.): 2.5" H x 1.75" W x 1.2" D
- **Frequency:** 433.92MHz
- **Environmental:** Indoor
- **Operating Temperature:** -22°F – 140°F
- **Input Voltage:** 24VDC
- **Current consumption:** 9mA @24VDC (standby); 46mA (max)
- **Relay Outputs:** Two (2) Dry, Form C (SPDT)
- **Contact rating:** 10A@30VDC (resistive)
- **Wiring connections:** 12", 8-wire pigtail
- **Transmitter coding capacity:** 30 (fixed code)
- **Transmitter programming using onboard learning button and status LED**

Model	Description	
WRC-R2	433MHz 2-Channel Wireless Receiver	81.00



Passive Infrared Egress Control

Distributor Discount Code **V LIST**



MD-31DOW	Motion detector with time delay, white	235.00
MD-31DB	Motion detector with time delay , black	235.00

Time Delay Relay

Distributor Discount Code **CK List**



Time Delay Relays

10TD	Time delay relay module with adjustable 1-60 second relock delay.	88.00
	Input: 12/24V AC/DC	Output: SPDT, dry contact
	Voltage: 2 Amps @ 30 VDC (resistive)	Size: 2-1/4"x 1-1/2" x 3/4"

Timer

Distributor Discount Code **CK LIST**



14-2	7 day programmable timer with memory battery back-up capability	249.00
	Output: 1 SPDT, dry contact	
	Voltage: 16 Amps @ 30 VAC/DC	
	Specify 12V AC/DC or 24 AC/DC	



SECURITY DOOR CONTROLS
 801 Avenida Acaso • Camarillo, CA 93012
 Email: Service@sdccsecurity.com • www.sdccsecurity.com

Price List Effective February 1, 2017

Door Position Sensors

Distributor Discount Code **V LIST**



DPS-11
DPS-11-2

MC-4



MC-4M

DPS-11	Adjustable ball type SPDT 5 Amp	47.00
DPS-11-2	Adjustable ball type 2 SPDT 5 Amp	68.00
MC-4	Recessed magnetic (3/4", SPDT, 30VDC, 50mA)	50.00
MC-4PAK	Recessed magnetic (3/4", SPDT, 30VDC, 50mA) - 10 pack	311.00
MC-4M	Recessed magnetic mounted on 1-1/4" x 4-7/8" plate	88.00
MC-7	Biased high security recessed magnetic (1", SPDT, 30VDC, 50mA)	68.00

Price List Effective February 1, 2017

Accessories

UME Universal Module Enclosure

NK



Universal Module Enclosure for single modules
 Universal mounting standoffs will accommodate
 FB-4, UR-1, 12VR, ACM-1, PB-16, PB-8, PSM, 621B, or LR100EM boards.
 Box Dimensions: 5-5/8"H x 7-11/16"W x 3-3/8"D

UME	Single module enclosure	32.00
------------	-------------------------	--------------

SECURITY DOOR CONTROLS
 801 Avenida Acaso • Camarillo, CA 93012
 Email: Service@sdsecurity.com • www.sdsecurity.com

Emergency Access Panel

Distributor Discount Code **CK LIST**



APB1000A	Emergency access panel for lobby door system. Mushroom button with key reset and siren	363.00
-----------------	---	---------------



Communicating Bathroom EMLocks®

APPLICATION

Single hospital bathroom shared by two patient rooms.

SYSTEM OPERATION

Both doors must be closed to lock.

Activating CB401A (B) locks both doors.

Activating CB401A (B) again unlocks both doors.

When doors are locked, activating either CB401B (C) emergency release will unlock both doors.

Both doors will unlock automatically via signal from fire panel.

SYSTEM COMPONENTS

- (A) Fail Safe locks with door position switch.
Example: 1511-DPS
- (B) CB401A System activation push switch.
- (C) CB401B Emergency release push switch to be mounted above each door. CB701B key switch optional.
- (D) 631RFxUR1 Power Supply with Fire Panel Tie-In.

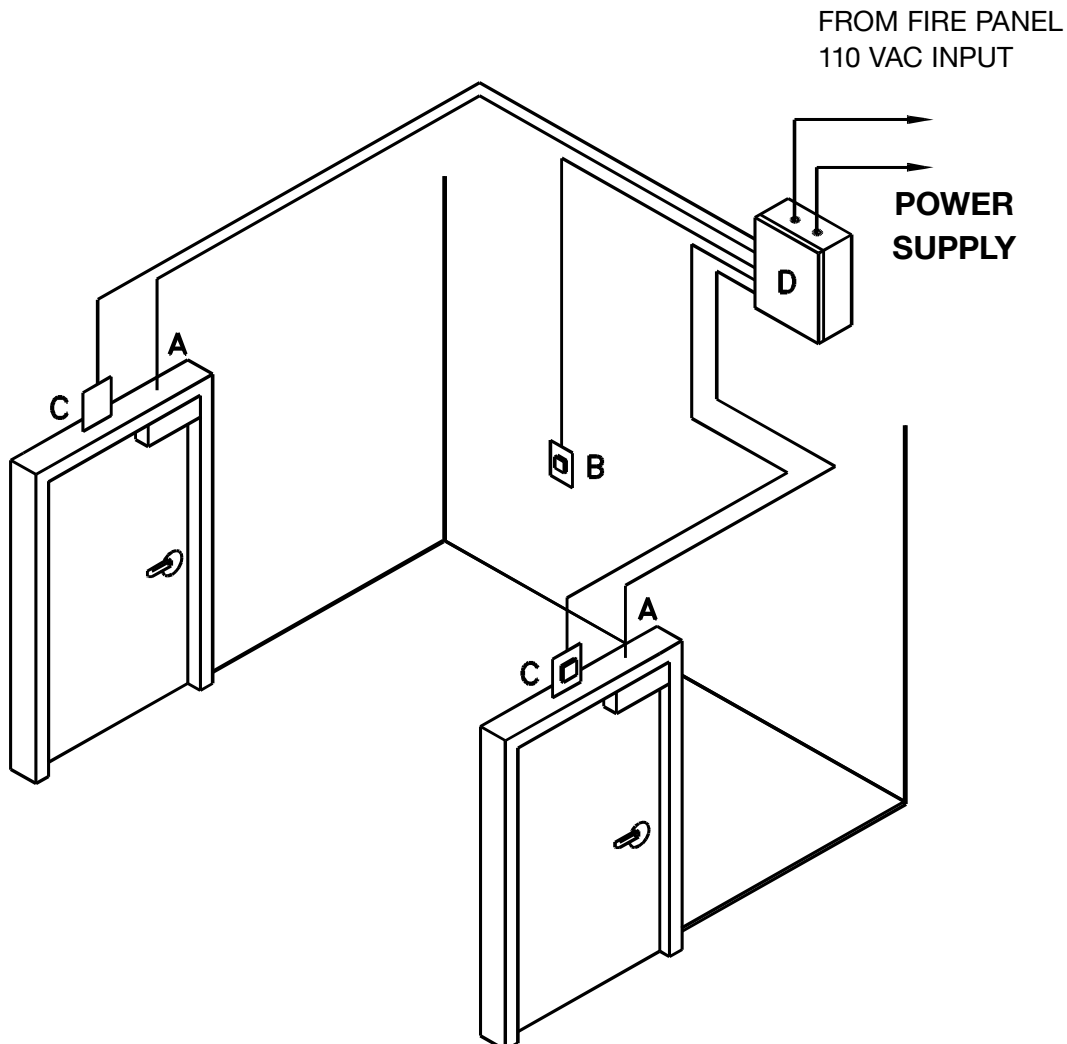

COMMUNICATING BATHROOM for Selectric® or Electra® Locks

APPLICATION

Single hospital bathroom shared by two patient rooms.

SYSTEM OPERATION

Both doors must be closed to lock.

Activating CB402A (B) locks both doors.

When doors are locked, turning either inside door lever unlocks both doors.

When doors are locked, activating either CB402B (C) emergency release will unlock both doors.

Both doors will unlock automatically via signal from fire panel.



CB401-A
CB402-A



CB401-B
CB402-B

SYSTEM COMPONENTS

- (A) Fail Safe locks with door position switch or REX. Examples: 7850-RD or 7250
- (B) CB402A System activation push switch.
- (C) CB402B Emergency release push switch to be mounted above each door. CB702B key switch optional.
- (D) PTH-4-DPS
- (E) 631RFxUR1 Power Supply with Fire Panel Tie-In.

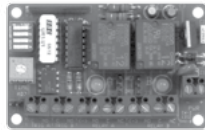

UR1

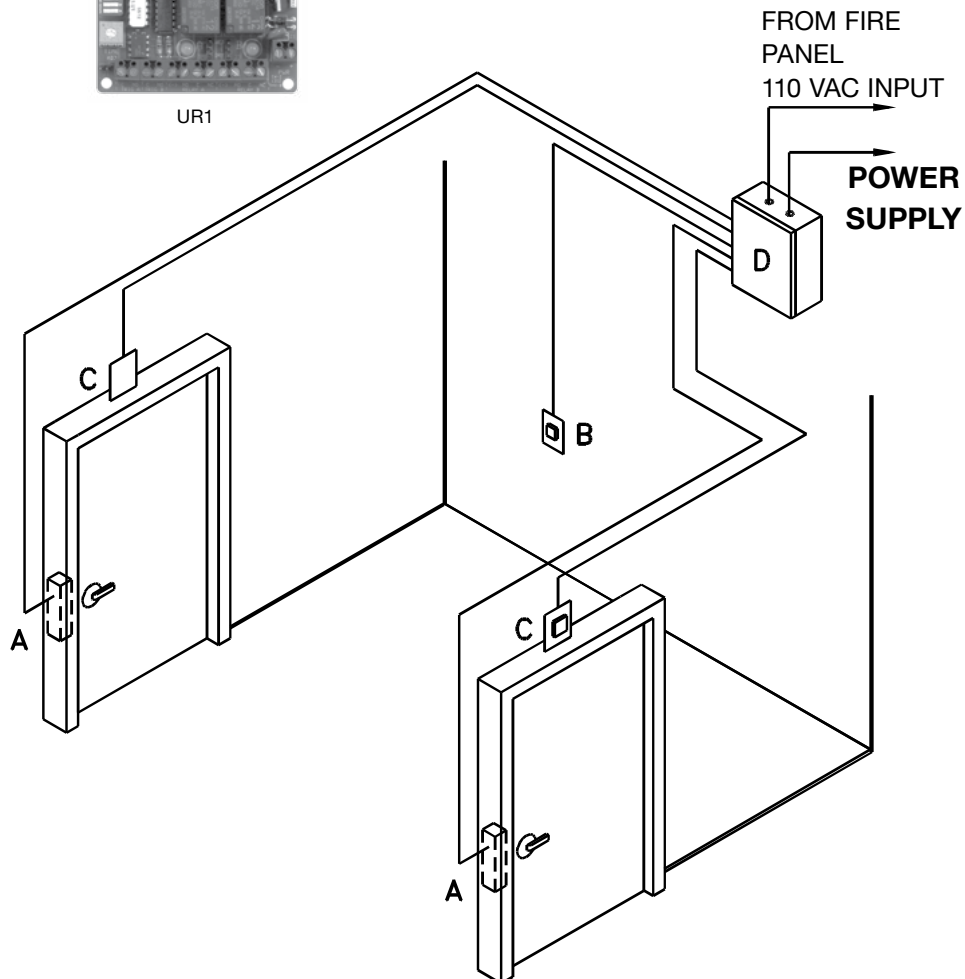

COMMUNICATING BATHROOM for HiTower® Locks or Electric Strikes

APPLICATION

Single hospital bathroom shared by two patient rooms.

SYSTEM OPERATION

Both doors must be closed to lock.

Activating CB402A (B) locks both doors.

When doors are locked, turning either inside door lever unlocks both doors.

When doors are locked, activating either CB402B (C) emergency release will unlock both doors.

Both doors will unlock automatically via signal from fire panel.



CB401-A
CB402-A



CB401-B
CB402-B

SYSTEM COMPONENTS

- (A) Fail Safe locks with latch bolt monitoring.
Examples: 7550-L or 45-4SU
- (B) CB402A System activation push switch.
- (C) CB402B Emergency release push switch to be mounted above each door. CB702B key switch optional.
- (D) 631RFxUR1 Power Supply with Fire Panel Tie-In.

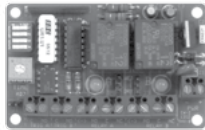

UR1

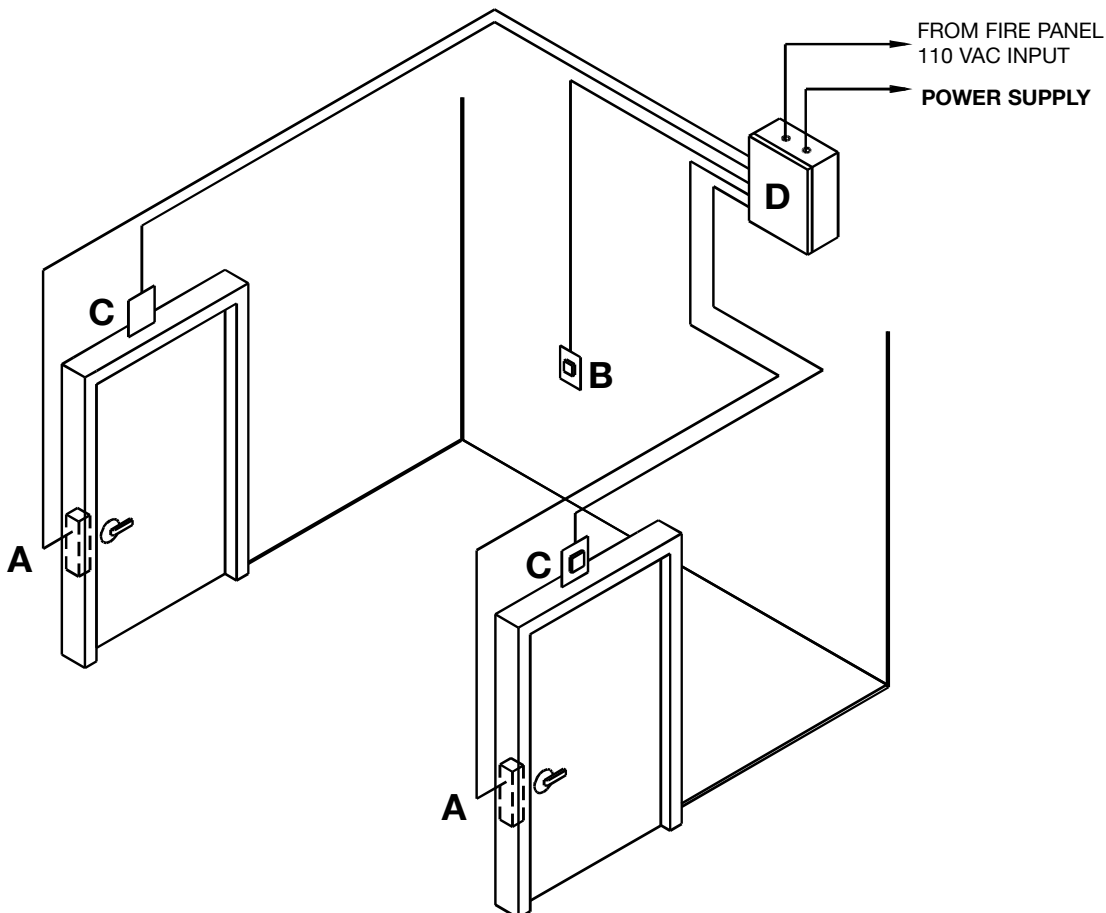

APPLICATIONS

Darkrooms, laboratories, clean rooms, x-ray or other treatment rooms, light and air trap rooms and more.

OPERATION

All doors remain closed and unlocked. Opening either door causes the second door to lock until the opened door returns to the closed position. A key switch is provided for system activation and deactivation.

SYSTEM COMPONENTS SHOWN

- (A) 631RFA-UR2-4 Power Supply
- (B) 1511-DPS EmLock
- (C) 701 System On-Off Key Switch

ALTERNATE "B" COMPONENTS

Refer to literature for lock specifications.

EmLocks	Electric Strikes	HiTower	Bolt Locks
1581-DPS	◆55-A-LBM	7530-L	FS23M-D
1565-DPS	◆55-B-LBM	7830-DS	1190A-D
1511-DPS-TJ	◆55-C-LBM	◆ 7560-L	1091A-D

◆ Indicates Fail Secure

NOTES: Consult factory for 3 and 4 door interlocks. Operation and configurations shown may be altered for specific job application needs. Consult factory for more information. Component changes may require system design/schematic changes. Consult factory.

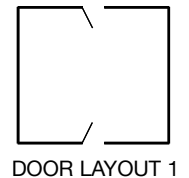
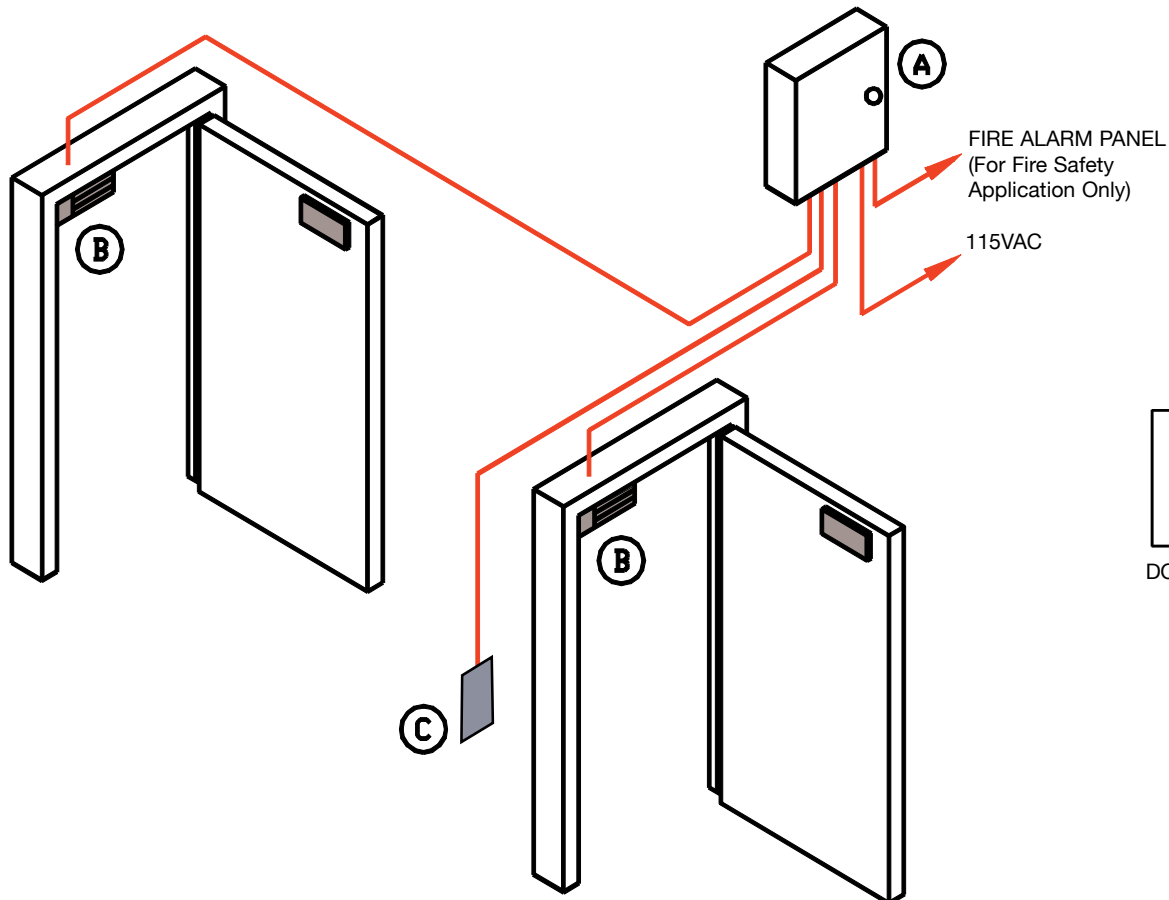

Price List Effective February 1, 2017

SDC SECURITY DOOR CONTROLS
 801 Avenida Acaso • Camarillo, CA 93012
 Email: Service@sdsecurity.com • www.sdsecurity.com



Communicating Bathrooms, Mantraps & Interlocks

2 DOOR MANTRAP "B"

3 and 4 Door Mantrap Available

APPLICATIONS

Laboratories, clean rooms, money counting rooms, restricted dark rooms, computer rooms and more.

OPERATION

Both doors are normally closed and locked. Unlocking either door causes the other to be incapable of being unlocked. A key switch (D) is provided for system activation and deactivation. Doors are accessed by Digital Keypad (C).

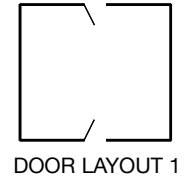
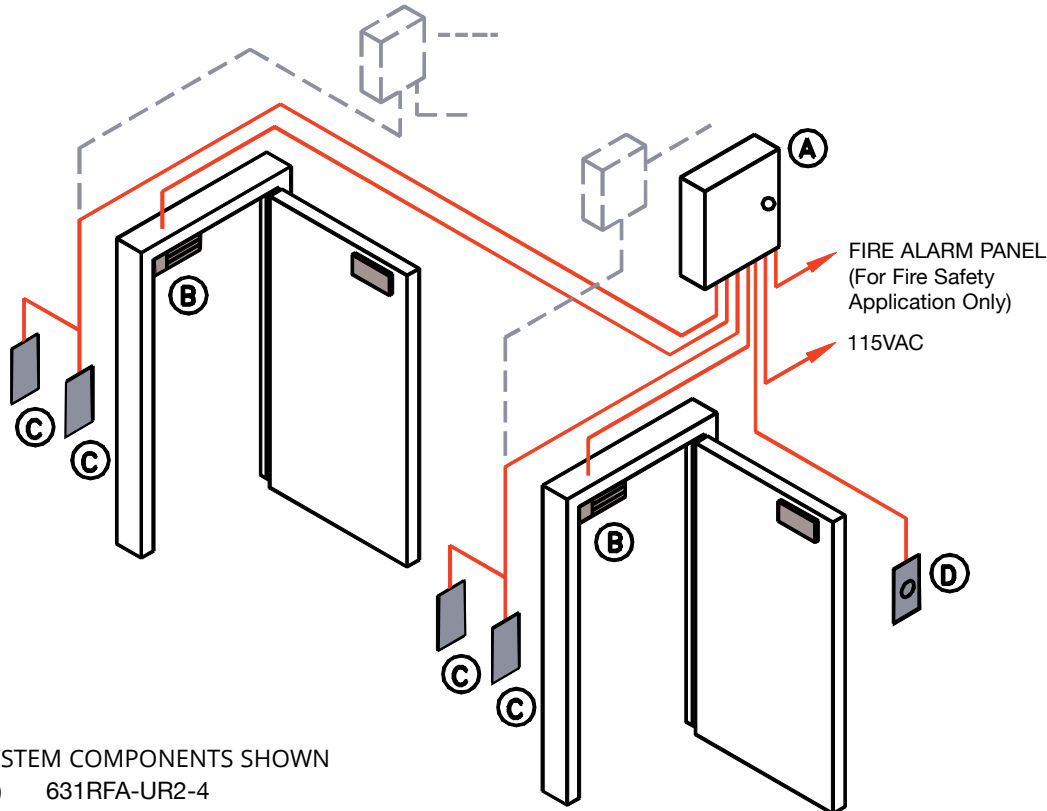

SYSTEM COMPONENTS SHOWN

- (A) 631RFA-UR2-4
- (B) 1511-DPS-BAS or 1511-BAS
- (C) 918 Digital Entry Momentary Access
- (D) 701 Key Switch ON-OFF

ALTERNATE "B" COMPONENTS/LOCKING DEVICE

Refer to literature for lock specifications.

EmLocks	Electric Strikes	HiTower	Bolt Locks
1565-DPS-BA	◆ 55-A-LCM-LBM	7530-S	FS23M-BD
1511-DPS-BAS-TJI	◆ 55-B-LCM-LBM	◆ 7560-S	1190A-BD
		7830-DS	

◆ Indicates Fail Secure

ALTERNATE "C" COMPONENTS/ACCESS CONTROL - Refer to literature for switch specifications.

Key Switch	Desk Switch	Keypad	Card & Keypad Reader
702	15-2	918	920P
702N		920	923P
802			
802N			

ALTERNATE "D" COMPONENTS/ON-OFF SWITCH - Refer to literature for switch specifications.

Desk Switch	Push Switch
15-1 ON-OFF	425 ON-OFF

NOTES: Consult factory for 3 and 4 door mantraps. Operation and configurations shown may be altered for specific job application needs. Consult factory for more information. Component changes may require system design/schematic changes. Consult factory. Consult factory for Control and Monitoring Panel applications.

2 DOOR INTERLOCK "C"

3 and 4 Door Mantrap Available

APPLICATIONS

Laboratories, clean rooms, money counting rooms, restricted dark rooms, computer rooms and more.

OPERATION

Door 1 is locked, Door 2 remains unlocked. When Door 1 is unlocked, Door 2 locks. When Door 2 is opened, Door 1 cannot be unlocked. A key switch (D) is provided for system activation and deactivation. Door 1 is accessed by Digital Keypad.

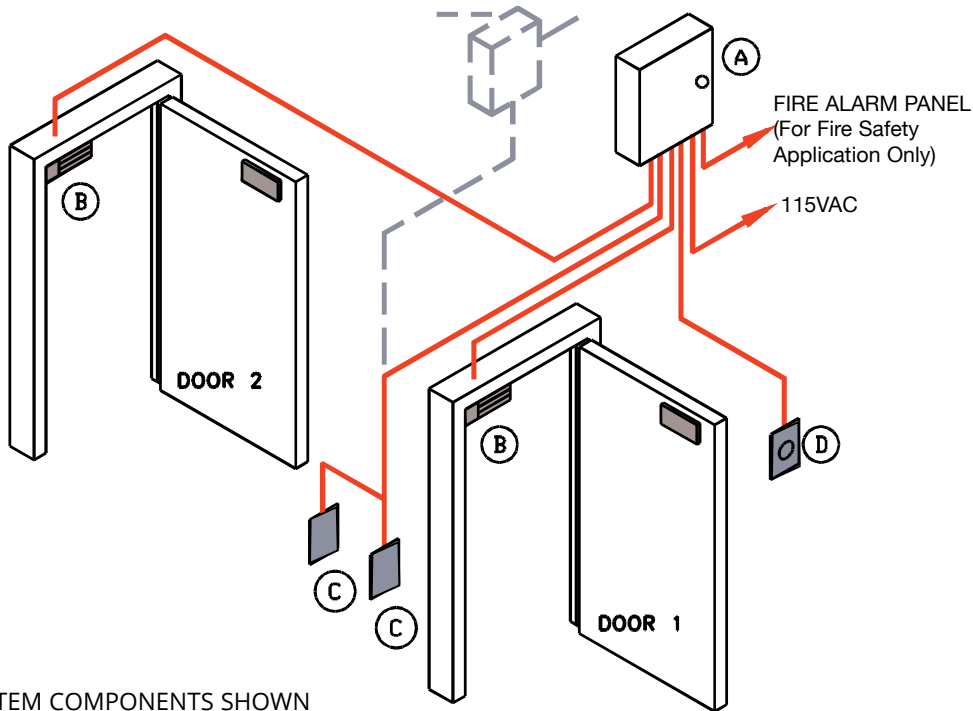

SYSTEM COMPONENTS SHOWN

- (A) 631RFA-UR2-4 Power Supply
- (B) 1511-DPS-BAS EmLock
- (C) 918 Digital Entry Momentary Access
- (D) 701 Key Switch ON-OFF

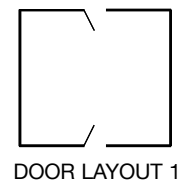

ALTERNATE "B" COMPONENTS/LOCKING DEVICE

Refer to literature for lock specifications.

EmLocks	Electric Strikes	HiTower	Bolt Locks
1565-DPS-BA	◆ 55-A-LCM-LBM	7530-S	FS23M-BD
1511-DPS-BAS-TJI	◆ 55-B-LCM-LBM	7830-DS	1190A-BD
	◆ 7560-S		

◆ Indicates Fail Secure

ALTERNATE "C" COMPONENTS/ACCESS CONTROL - Refer to literature for switch specifications.

Key Switch	Desk Switch	Keypad	Card & Keypad Reader
702	15-2	918	920P
702N		920	923P
802			
802N			

ALTERNATE "D" COMPONENTS/ON-OFF SWITCH - Refer to literature for switch specifications.

Desk Switch	Push Switch
15-1 ON-OFF	425 ON-OFF

NOTES: Consult factory for 3 and 4 door interlocks. Operation and configurations shown may be altered for specific job application needs. Consult factory for more information. Component changes may require system design/schematic changes. Consult factory. Consult factory for Control and Monitoring Panel applications.

ELEVATOR LOBBY DOOR SYSTEM

OPERATION

Many high-rise building tenants that occupy a complete floor may have a problem when it comes to securing their elevator lobby doors. These doors lead through office space to the emergency exit stairwell doors. People must have free access to the stairwell at all times. This leaves some companies vulnerable to transient traffic, theft and loss of proprietary information. SDC manufactures a lobby door security system which meets both fire life safety and security needs.

The elevator lobby doors are normally closed and locked by SDC Model Z7850 Fail-Safe lockset. The intercom system provides two-way communication to the security desk. When a call is placed from the elevator lobby, the security desk personnel can momentarily release the SDCZ7850 lockset by using the SDC Desk Console (Model DTMO-1). If there is no response from the security desk personnel, the person in the elevator lobby can depress the red exit palm push button switch on the Alarm Panel Sign (SDC Model APB-1000). When the red exit switch is activated, the SDC Model Z7850 lock will immediately release and an alarm will sound in the elevator lobby and the security desk console.

An authorized person can reset the lockset, turn off the alarm and return the system to the normal secured operation by using the built-in Key Reset on the red exit palm push button switch. Personnel may always obtain access to the offices by use of an access control system. Egress from the office to the lobby is accomplished by rotating the inside lever.

A SDC Series 600 Power Supply will provide 24VDC power to the locks, Security Desk Console and alarm. The emergency control relay within the power supply will turn off the system power when activated by a building fire alarm device. The SDC Model Z7850 lockset will release immediately when power is removed.

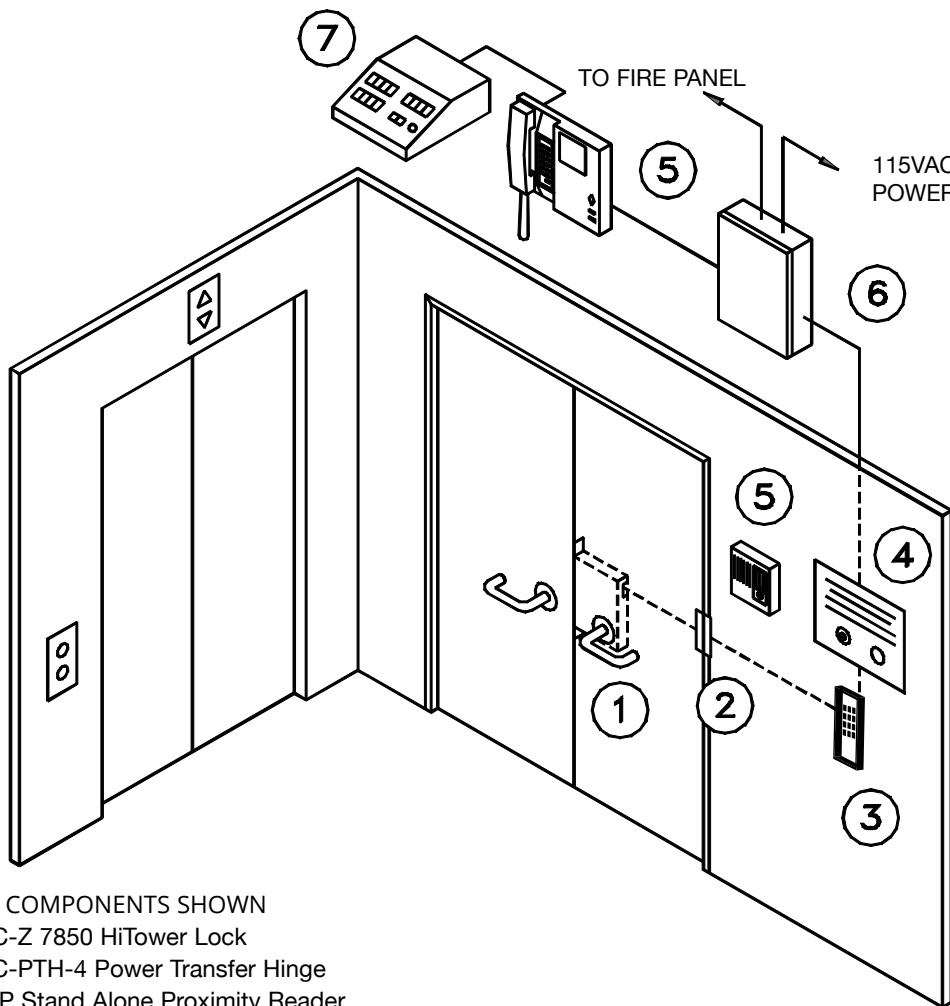

SYSTEM COMPONENTS SHOWN

- (1) SDC-Z 7850 HiTower Lock
- (2) SDC-PTH-4 Power Transfer Hinge
- (3) 920P Stand Alone Proximity Reader
- (4) SDC-APB 1000 Sign with Release Push Switch and Alarm
- (5) Intercom/CCTV by others
- (6) SDC-631RF Power Supply
- (7) SDC-DTMO-1, RCC or TCC Door Control Console and Annunciator

NOTE: All system field wiring is to be installed in accordance with all local building codes and the approval of the local authority having jurisdiction. All wiring is to be done by a licensed Access Control or Fire and Life Safety specialist.

Item Code	Page	Item Code	Page	Item Code	Page	Item Code	Page
110	58	1576U	16	AB Angle Brackets	11	LR100	49
210	58	1581 / 1582	7	ACM-1	88	MC-4	95
260	58	1581-DF	21	AL4 / AL8	93	MC-7	95
280	58	1581DE	21	APB1000A	99	MD-31	76
295	60	1581S	20	AR11Y	10	MS-12 / MS-14 / MS-16 / MS-20	27
918	64	1583V	7	BBID	73	MSB550	71
921	66	1591U	17	BL4 / BL8	93	PB-16 / PB-8	88
923	65	180A	58	BPS6S / BPG6S	78	PD2090A	59
924	66	2090A	57	BR64	89	PSB560	70
1511	7	2490A	56	CB401-AU / CB401-B	82	PT-2U	85
1561	14	25-4U	23	CB701	82	PT-3V	85
1562	14	290 / 290LS	60	CC1-5 / CC3-5	31	PT-5	85
1571	7	30-4	23	CL4 / CL8	93	PTH	84
101-1A	22	350V / 352V	12	CR4	88	PTM	85
101-1AK / 101-4AM	22	400U-L2	95	DBM	26	RB12V4 / RB12V7	88
101-DE / 101-KDE	21	400U-RMB / 400U-SN	95	DC-1	10	RCC	93
101-PAM	22	412 / 413 / 422 / 423 / 424 / 425	73	DL4 / DL8	93	S6100 / S6200 / S6300	36
1091A	56	413MN / 423M	73	DPS-11	99	S6100-101	40
10TD	76	431 / 432 / 433 / 434 / 435	74	DTMA / DTMO	92	S6303FH	44
1190A	57	441 / 442 / 443 / 444 / 446	74	E1200 / E600 / E6200	13	SC-10	44
1291A	56	45-4 / 45-6 / 45-7	24	E300	17	SK-82 / SK-88	33
12VR	86	451 / 452 / 453P	74	E75 / E76 / E77	67	SK-L90	33
14-2	98	45A	24	EA100	94	TCC	93
1490A	56	463 / 474	74	EH10 / EH20 / EH30 / EH40 / EH42	96	TJ1 / TJ2	8
15-1	93	491 / 492	82	EKE03	35	TJ81 / TJ82	8
15-2 / 15-3	93	510 thru 590	72	EMC	88	TP1220 / TP2440	89
15-4	23	55 A thru F	26	EP17624 / EP17624TJ	17	TR-12 / TR-24	89
1511-DF	9	55-ABC	27	EZ-A / EZ-B / EZ-D / EZ-T	9	UB11 / UB12	10
1511DE	21	602RF	86	EZ-B	9	UF11 / UF12	10
1511S	19	621P	87	EZ-D	9	UF81 / UF82	10
1511T	19	631RF / 632RF / 634RF / 636RF	86	EZ-T	9	UR-1 / UR2-4 / UR4-8	88
1512 / 1513	7	7000-DB1/4	33	FB-4	88	Z7250 / Z7252	30
1561S / 1561TJ	15	7000-DB3/8	33	FP Filler Plates/ AB Angle Brackets	11	Z7550	35
1562SC / 1562SCHDB	15	7000-DGK	33	FS23M	56	ZA7850	31
1565 / 1566	14	701 thru 713	75	GKE03	35	ZD7250	28
1571DE	7	702R / 708R	22	GL160A / GL260A	4	ZR7550	35
1572 / 1573	7	7250 / 7252 D, H, P, S, T	30	HID1326-25	65	ZS7250	28
1575DEU	21	7500EB	35	IP100	54	ZT7550	35
1575U	16	7550 A thru V	35	IPPRO	63	ZT7850	31
1576-MP	16	7850 / 7852 A thru X	31	IPRW	62	ZY7550	35
1576-ZB	16	801AL thru 813AL	75				
1576AB / 1576-BK	16	920/921	65				
1576DEU	21						

Price List 18

Electric & Mechanical Access Control Hardware

INNOVATION

SDC has been awarded scores of patents for:

- Electrified Cylindrical Locksets
- Electrified Mortise Locksets
- Actuator Controlled Locksets
- Electromagnetic Locks
- Magnetic Shear Locks
- Delayed Egress Locks
- Request-to-Exit Bars

LEADERSHIP

SDC has earned twelve SIA New Product Achievement and Security Industry Finest Awards since 1997. In addition, SDC has received numerous SIA New Product Showcase certificates of recognition for Commitment to Innovation and Excellence in New Product Development.



shipQUICK

Over 100 SDC products are available for shipment the next business day from the SDC warehouse nearest you. Visit us at www.SDCsecurity.com and download your copy of the shipQUICK inventory so you know first hand which products SDC can expedite for you.



QUALITY

SDC practices quality management based on continued improvement of daily operations, product quality and customer satisfaction.



PROJECTS

- NASA Kennedy Space Center, FL
- King Khalid International Airport, Saudi Arabia
- J. Paul Getty Museum, Los Angeles
- Chek Lap KOK Airport, Hong Kong
- Bank of America, U.S.A.
- Kuala Lumpur International Airport, Malaysia
- Smithsonian Institute, Washington D.C.
- California State Capital, East End Project
- Duke Energy Nuclear Plants, N. & S. Carolina
- Dallas/Forth Worth International Airport, Texas
- Museum of Modern Art, New York
- Exxon, U.S.A.
- Chase Manhattan Bank, U.S.A
- JFK International Airport; NY

Free!
SDC APP Available for iPad, iPhone & Android
SDCSecurity.com/FreeApp



Security Door Controls

the lock behind the system

www.sdcsecurity.com

Tel: (805) 494 0622

service@sdsecurity.com

(800) 413 8783

801 Avenida Acaso, Camarillo, CA 93012
P.O. Box 3670, Camarillo, CA 93011-3670

© Copyright 2017, Security Door Controls rev. 08.18.17