

Power Supplies

DORMA PS

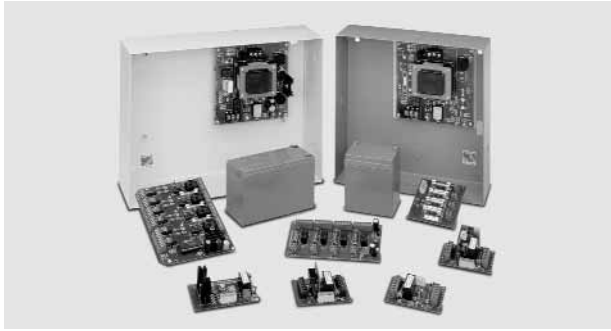

The PS Series power supplies offer field selectable output voltage and are available with door control modules and battery back-up to fit your application needs.

The PS Series power supplies are high performance with heavy-duty circuitry for inductive loads and multidoor applications. The modular design is built around several different application control modules to meet your specific needs for virtually any electric lock system. Documentation is provided to ensure a well organized installation for individual or multidoor systems that may include locking devices, access controls, station controls, and consoles for remote control, announcement and fire/life safety system interface.

Technical Details:

- Heavy Duty Electrical Components for inductive load applications.
- Built-in power supply on/off control relay may be used for connection to a fire/life safety emergency release system for immediate release of fail safe locks. Can also be used for remote lock control with up to 1000 ft of 22 gauge wire (not available with PS-545).
- Eight different control modules meet a variety of applications, including the control of multiple doors.
- Control modules may be ordered separately and added to an existing system.
- Stock only the PS Series for 12 VDC or 24 VDC applications.

Regulated and Filtered 12 VDC or 24 VDC Output Voltage and Built-In Battery Charger (502RF, 531RF, 531RFA, 534RF, and 536RF) - These models have regulated and filtered output voltage up to the rated output load current. The output filtering stabilizes the DC output voltage and reduces AC line noise. The built-in battery charger circuitry eliminates the need for additional boards and provides the required voltage to charge the batteries. The main voltage output terminal is maintained at 12 VDC or 24 VDC to supply the proper voltage to all components and locking devices.

Main System On/Off or Fire Panel Relay - The power supply output voltage can be controlled by the main system on/off control relay which accepts a closed dry contact. Opening the control contact turns off the power supply output voltage and immediately releases all fail safe locks. For the PS Series power supplies, this input may be connected to the fire/life safety emergency release system or to other access controls. This input may also be used for remote on/off lock control by devices such as a key switch, a push switch or a card access control system.

Modular Design - Individually fused door control modules are available for a variety of applications. Time delays, latching relays and multiple station circuit breaker modules are available for custom configuration in the field or at the factory.

Status Indicator -

The System Status Tricolor LED: Monitors the power supply output and provides the following status information.

- Amber - AC and DC voltages are OK.
- Green - No DC output. Check output circuit breaker.
- Red - No AC input, powered by batteries.

AC Line Power LED: Monitors the input AC voltage.

- Off - No AC line input voltage.
- Yellow - AC line input voltage is present.

Battery Charger Status LED: Monitors the battery charger (models 502RF, 531RF, 531RFA, 534RF and 536RF).

- Off - Battery is fully charged.
- Red - Charger is on and charging batteries.

Low Battery Disconnect - Batteries are automatically disconnected from the secondary output circuit when the voltage decreases below 70%. This ensures batteries are capable of recharging.

Class 2 Outputs - Where permitted by code, conduit is not required when using Class 2 outputs.

Emergency Release Input - The Fire/Life Safety emergency release input is standard on DORMA power supplies (not available with 545).

Certification:

The DORMA PS Series power supplies are listed by U.L. under their continuing reinspection programs. Tests conducted according to UL 1481 criteria.

All power supplies are C.U.L. Pending.

- URTZ - Fire and Burglar Alarm Power Supply Unit
- ALVY - Access Control Systems Units
- APHV - Burglar Alarm System Power Supply
- SYSW - Releasing Device Accessory

Model 545 (1.5 Amp Power Supply)

Plug-in 120 VAC voltage transformer with fused secondary screw terminals with ground allows the power supply to be powered directly from a 120 VAC receptacle. Power supply is U.L. listed Class 2.

Electrical Specifications:

Input: 120 VAC to 24 VDC plug-in transformer

Output: Unregulated 24 VDC, four individually fused outputs, 1.5 Amp @ 24 VDC

Cabinet Specifications:

8" W x 7" H x 3-1/2" D, steel, 18 ga



Model 502RF (1 Amp Power Supply)

Electrical Specifications:

Input: 115 VAC, 600 mA, 50/60 Hz (230 VAC optional)

Output: 12/24 VDC, 1 Amp

Battery Charger: 12 VDC, 500 mA

Cabinet Specifications:

11.25" W x 11.25" H x 3.5" D, steel, 18 ga

Input and Output Protection:

The AC input voltage is circuit breaker protected. The secondary output provides a self resetting circuit protection.

Options:

PC - 6 ft power cord

KL - Key lock cover

MR - Manual reset fire alarm release

PS-1 - System on-off push switch mounted inside cabinet

PS-1A - System on-off push switch mounted on outside cover

230VAC - 230 VAC input (not UL Listed)

500JP - Junction box with hinged cover (for door control modules) 16" H x 14" W x 6.5" D

501JP - Junction box with hinged cover (for door control modules). 11.25" H x 11.25" W x 3.5" D

Modular Boards:

See page 10 and 11 for modular board specifications.

ACM-1	CR4
FB-4	LR
CR	TD

Battery Charging Output:

A separate PTC protected charging output provides 13.5 VDC to 27 VDC to fully charge the batteries. The secondary output is always precisely maintained at 12 or 24 VDC to protect locking devices and components from over voltage while the batteries are charging. The specified secondary output current is also



maintained while batteries are charging. Derating of the secondary output current is not required when charging batteries.

Battery Back-Up Selection:

RB12V4 - 4.5 Amp hour battery

The 502RF power supply is equipped with a battery charger and may accommodate up to four RB12V4 batteries that provide continuous operation of access controls and locking hardware during a power failure. A signal from the fire/life safety system will override battery backup.

Back-up Time for 12 V and 24 V Using 4.5 Ah Batteries:

Load (Amp)	Time	
	*4.5 Ah	**9 Ah
0.25	17 hours	33 hours
0.50	8	15
0.75	4.5	9
1.00	3	6

*12 V (1 battery), 24 V (2 batteries)

**12 V (2 batteries), 24 V (4 batteries)

Model 531RF (1.5 Amp Power Supply)

Electrical Specifications:

Input: 115 VAC @ 800 mA, 50/60 Hz, Fused
(220/230 VAC 50/60 Hz optional, not UL Listed)

Selectable Secondary Output: 12 VDC or 24 VDC @ 1.5 Amp, poly fuse protected, Class 2

Battery Charger Output: 250mA @ 13.5 or 26.6 VDC

Cabinet Specifications:

531RF: 11.25" W x 11.25" H x 3.5" D, steel, 20 ga

531RFA: 16" W x 14" H x 6.5" D, steel, 16 ga

Input and Output Protection:

The AC input voltage is circuit breaker protected. The secondary output provides a self resetting circuit protection.

250 mA Battery Charger Output:

A separate PTC protected, battery charger output provides 13.5 VDC or 26.6 VDC.

Isolated Charging Circuit:

While the charging output is 13.5 VDC or 26.6 VDC, the secondary output is unaffected and precisely maintained at the selected 12 or 24 VDC. This ensures system components are powered by their specified voltage. The secondary output current is maintained at the full 1.5 Amp capacity and is not derated when charging batteries.

DIP Switch Select System Operation

Specification of the UR Universal Access Hardware Controller UR-2A or UR-4A provides six standard DIP switch selectable system and mantrap variations for multiple door systems.

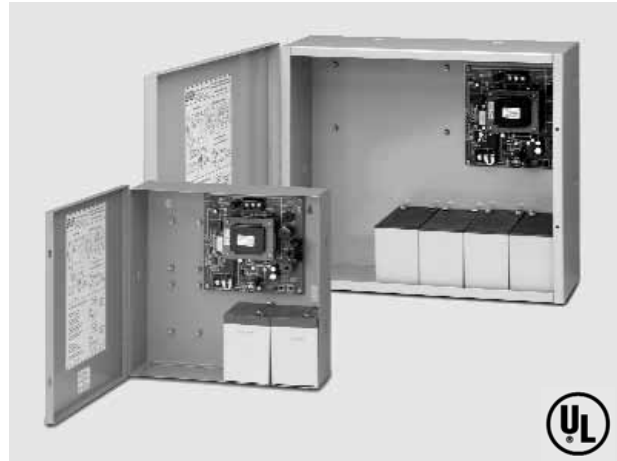

Options:

PC - 6 foot Power Cord

KL - Key locked cover

PS-1 - On-Off Push switch inside cabinet. 531RFA only

PS-1A - On-Off push switch on cover

230V - 220/230 VAC, 50/60 Hz input (not UL Listed)

500JP - Junction box with hinged cover (for door control modules) 16" H x 14" W x 6.5" D

501JP - Junction box with hinged cover (for door control modules). 11.25" H x 11.25" W x 3.5" D

500JSB - Battery junction box. Accommodates up to (10) RB12V7 batteries

500JS12 - 12 V battery charger/transformer in junction box. Accommodates up to (12) RB12V7 batteries. 16" H x 14" W x 6.5" D

500JS24 - 24 V battery charger/transformer in junction box. Accommodates up to (12) RB12V7 batteries. 16" H x 14" W x 6.5" D

Door Control Modules:

See page 10 and 11 for control module specifications and table below for door control module capacities.

FB-4

UR-2A

UR-4A

ACM-1

CR

CR4

LR

TD

} PS531RFA only

Control Module Capacity

Power Supply	ACM-1	CR	CR-4	FB-4	LR	TD	UR
531 RF	N/A	2	1	2	2	2	N/A
531 RFA	4	6	2	2	6	6	1

Standby Power:

Power supplies equipped with batteries provide continuous operation of access controls, locking devices and peripheral components during a power failure.

See tables below to determine battery requirements for standby power.

See Figures 1 and 2 on page 12 for battery back-up wiring.

Batteries:

RB12V4 - 12 VDC, 4 Amp Hour Battery, 531RF capacity, 4 maximum

RB12V7 - 12 VDC, 7 Amp Hour Battery, 531RFA capacity, 6 maximum

12 VDC Standby Power					24 VDC Standby Power											
4.5 Ah Batteries					4.5 Ah Batteries											
Amp Hours	1	2	3	4	2	4										
	4.5Ah	9Ah	13.5Ah	18Ah	4.5Ah	9Ah										
Load/Amps	Power Back-up Time in Hours				Load/Amps	Power Back-up Time in Hours										
.25	17	33	49	65	.25	17 33										
.50	8	15	23	31	.50	8 15										
1.0	3	6	9	12	1.0	3 6										
1.5	2	4	7	10	1.5	2 4										
7 Ah Batteries					7 Ah Batteries											
Amp Hours	1	2	3	4	5	6	7	8	9	10	2	4	6	8	10	
	7Ah	14Ah	21Ah	28Ah	35Ah	42Ah	49Ah	56Ah	63Ah	70Ah	7Ah	14Ah	21Ah	28Ah	35Ah	
Load/Amps	Power Back-up Time in Hours										Power Back-up Time in Hours					
1.0	5.7	14	20	30	33	41	48	55	62	69	1.0	5.6	14	20	30	33
1.5	3.6	8	13	18	23	29	33	37	39	42	1.5	3.6	8	13	18	23

Model 531RF/531RFA Circuit Board

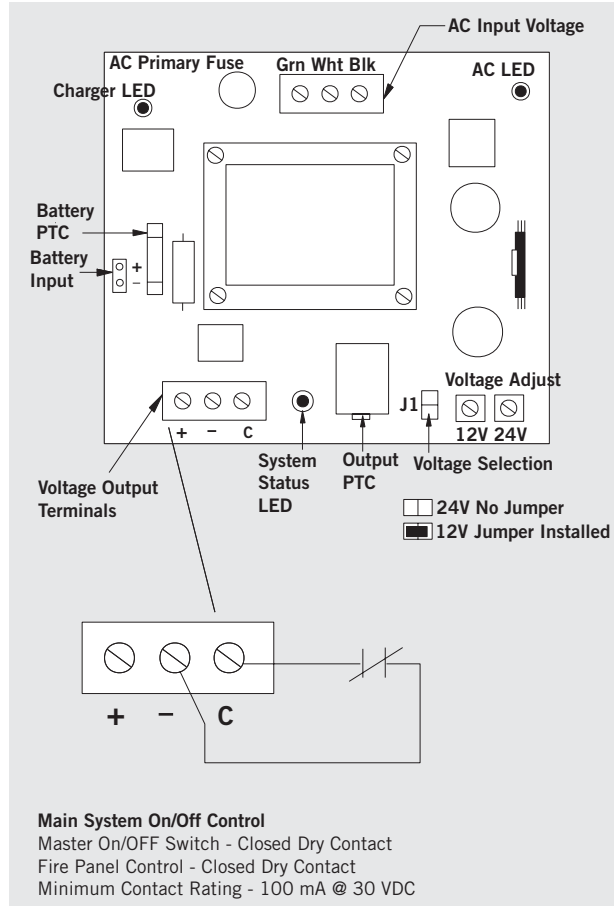

531RF x PC x 2 RB12V4



531RFA x UR4A x 4 RB12V7

Model 534RF (4 Amp Power Supply)

Electrical Specifications

Input: 1 Amp @115 VAC 50/60 Hz
(230 VAC 50/60 Hz optional, not UL listed)

Selectable Secondary Output: One, 4 Amp @ 12 VDC or 24 VDC,
or Two, Class 2, 2 Amp @12 VDC or 24 VDC

Battery Charger Output: 500 mA @ 13.5 or 26.6 VDC

Battery Charger Protection:

Auto resetting Poly Fuse

Cabinet Specifications:

16" W x 14" H x 6.5", steel, 16 ga

Input and Output Protection:

The AC input voltage is circuit breaker protected. The secondary output provides a self resetting circuit protection.

Isolated Charging Circuit:

While the charging output is 13.5 VDC or 26.6 VDC, the secondary output is unaffected and maintained at the selected 12 or 24 VDC. This ensures system components are powered by their specified voltage. The secondary output current is maintained at the full 4 Amp capacity and is not derated when charging batteries.

Class 2 Outputs:

The 534RF Power Supply may be configured to use one 4 Amp output or two 2 Amp, Class 2 outputs. Where permitted by code, conduit is not required for low voltage wiring when using Class 2 outputs. The total current draw from all outputs must not exceed 4 Amps.

DIP Switch Select System Operation:

Specification of the UR Series Universal Access Hardware Controller UR-2A or UR-4A provides for six standard DIP switch selectable system and mantrap variations for multiple door systems.



Options:

MR - Manual Reset for Fire Release.

KL - Key locked cover.

PS-1 - On-Off Push switch inside cabinet.

PS-1A - On-Off push switch on cover.

230V - 220/230VAC, 50/60 Hz input. (not UL Listed)

500JP - Junction box with hinged cover (for door control modules) 16" H x 14" W x 6.5" D.

501JP - Junction box with hinged cover (for door control modules). 11.25" H x 11.25" W x 3.5" D

500JSB - Battery junction box. Accommodates up to (10) RB12V7 batteries.

500JS12 - 12V battery charger/transformer in junction box. Accommodates up to (12) RB12V7 batteries. 16" H x 14" W x 6.5" D.

500JS24 - 24V battery charger/transformer in junction box. Accommodates up to (12) RB12V7 batteries. 16" H x 14" W x 6.5" D.

Door Control Modules

See page 10 and 11 for control module specifications and table below for door control module capacities.

UR-2A

UR-4A

ACM-1

LR

TD

CR

CR4

Control Module Capacity

Qty Batteries	ACM-1	CR	CR-4	LR	TD	UR
0-2	4	8	4	8	8	2
4-6	2	6	2	6	6	1

Standby Power:

Power supplies equipped with batteries provide continuous operation of access controls, locking devices and peripheral components during a power failure. The 534RF power supply is capable of accommodating up to six 7 Amp Hour batteries.

Battery:

RB12V7 - 12 VDC, 7 Amp Hour Battery, 534RF capacity, 6 maximum

See tables below to determine battery requirements for standby power.

See Figures 1 and 2 on page 12 for battery back-up wiring.

12 VDC Standby Power											24 VDC Standby Power					
7 Ah Batteries											7 Ah Batteries					
Amp Hours	1	2	3	4	5	6	7	8	9	10	Amp Hours	2	4	6	8	10
	7Ah	14Ah	21Ah	28Ah	35Ah	42Ah	49Ah	56Ah	63Ah	70Ah		7Ah	14Ah	21Ah	28Ah	35Ah
Load/Amps	Power Back-up Time in Hours										Load/Amps	Power Back-up Time in Hours				
1.0	5.7	14	20	30	33	41	48	55	62	69	1.0	5.6	14	20	30	33
1.5	3.6	8	13	18	23	29	33	37	39	44	1.5	3.6	8	13	18	23
2	2.5	6	8.5	13	17	20	24	28	30	35	2	2.5	6	8.5	13	17
2.5	1.9	4.6	7	10	13	16	19	22	26	29	2.5	1.9	4.6	7	10	13
3	1.6	3.8	5.5	8	10	12.6	15	17.5	21	23	3	1.6	3.8	5.5	8	10
3.5	1.3	3.2	4.6	6.7	8.5	10.5	14.5	14	17.5	19.5	3.5	1.3	3.2	4.6	6.7	8.5
4	1	2.6	4	5.6	7.3	9	10.5	12.5	14.5	16.5	4	1	2.6	4	5.6	7.3

Model 534RF Circuit Board

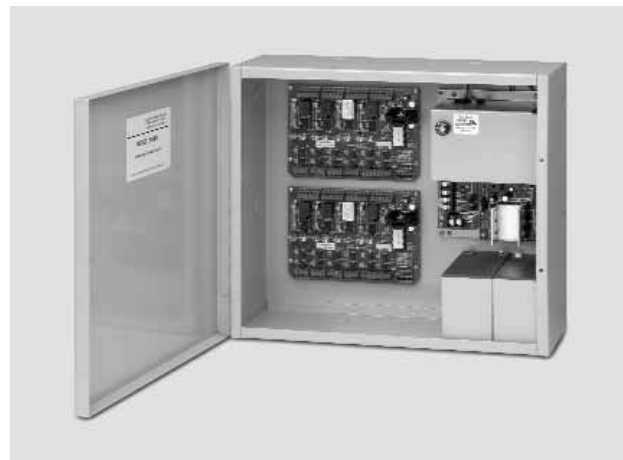
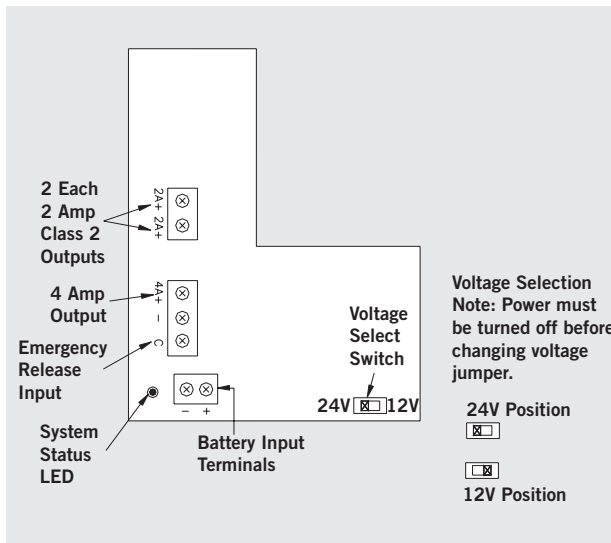

534RF x 2 UR4A x 2 RB12V7

Model 536RF (6 Amp Power Supply)

Electrical Specifications:

Input: 1.75 Amp @115 VAC 50/60 Hz
(230 VAC 50/60Hz optional, not UL Listed)

Selectable Secondary Output: One, 6 Amp @ 12 VDC or 24 VDC or Three, Class 2, 2 Amp @12 VDC or 24 VDC

Battery Charger Output: 500 mA @ 13.5 or 26.6 VDC

Battery Charger Protection:

Auto resetting Poly Fuse

Cabinet Specifications:

16" W x 14" H x 6.5" D, steel, 16 ga

Input and Output Protection:

The AC input voltage is circuit breaker protected. The secondary output provides a self resetting circuit protection.

500 mA Battery Charger Output:

A separate circuit breaker protected, built-in battery charger output provides 13.5 VDC or 26.6 VDC. Up to six 12 VDC, 7 Amp Hour batteries may be housed in the 536RF cabinet to provide up to 42 Amp Hour @ 12 VDC or 21 Amp Hour back-up capacity @ 24 VDC.

Isolated Charging Circuit:

While the charging output is 13.5 VDC or 26.6 VDC, the secondary output is unaffected and maintained at the selected 12 or 24 VDC. This ensures system components are powered by their specified voltage. The secondary output current is maintained at the full 6 Amp capacity and is not de-rated when charging batteries.

Class 2 Outputs:

The 536RF Power Supply may be configured to use one 6 Amp output or three 2 Amp, Class 2 outputs. Where permitted by code, conduit is not required for low voltage wiring when using Class 2 outputs. The total current draw from all outputs must not exceed 6 Amps.

DIP Switch Select System Operation:

Specification of the UR Series Access Hardware Controller UR-2A or UR-4A provides for six standard DIP switch selectable system and mantrap variations for multiple door systems.



Options:

- MR** - Manual Reset for Fire Release
- KL** - Key locked cover
- PS-1** - On-Off Push switch in cabinet
- PS-1A** - On-Off Push switch on cover
- 230V** - 220/230 VAC, 50/60 HZ input. (not UL Listed)
- 500JP** - Junction box with hinged cover (for door control modules), 16" H x 14" W x 6.5" D
- 501JP** - Junction box with hinged cover (for door control modules), 11.25" H x 11.25" W x 3.5" D
- 500JSB** - Battery junction box. Accommodates up to (10) RB12V7 batteries
- 500JS12** - 12 V battery charger/transformer in junction box accommodates up to (12) RB12V7 batteries, 16" H x 14" W x 6.5" D
- 500JS24** - 24 V battery charger/transformer in junction box accommodates up to (12) RB12V7 batteries, 16" H x 14" W x 6.5" D

Modular Boards:

See pages 10 and 11 for modular board specifications and table below for door control module capacities.

- UR-2A**
- UR-4A**
- ACM-1**
- LR**
- TD**
- CR**
- CR4**

Control Module Capacity						
Qty Batteries	ACM-1	CR	CR-4	LR	TD	UR
0-2	4	8	4	8	8	2
4-6	2	6	2	6	6	1

Standby Power

Power supplies equipped with batteries provide continuous operation of access controls, locking devices and peripheral components during a power failure. The 536RF power supply is capable of accommodating up to six 7 Amp Hour batteries.

See tables below to determine battery requirements for stand-by power.

See Figures 1 and 2 on page 12 for battery back-up wiring.

Battery

RB12V7 - 12 VDC, 7 Amp Hour Battery, 536RF capacity, 6 maximum

12 VDC Standby Power											24 VDC Standby Power					
7 Ah Batteries											7 Ah Batteries					
Amp Hours	7Ah	14Ah	21Ah	28Ah	35Ah	42Ah	49Ah	56Ah	63Ah	70Ah	Amp Hours	7Ah	14Ah	21Ah	28Ah	35Ah
Load/Amps	Power Back-up Time in Hours										Load/Amps	Power Back-up Time in Hours				
1.0	5.7	14	20	30	33	41	48	55	62	69	1.0	5.6	14	20	30	33
1.5	3.6	8	13	18	23	29	33	37	39	44	1.5	3.6	8	13	18	23
2	2.5	6	8.5	13	17	20	24	28	30	35	2	2.5	6	8.5	13	17
2.5	1.9	4.6	7	10	13	16	19	22	26	29	2.5	1.9	4.6	7	10	13
3	1.6	3.8	5.5	8	10	12.6	15	17.5	21	23	3	1.6	3.8	5.5	8	10
3.5	1.3	3.2	4.6	6.7	8.5	10.5	14.5	14	17.5	19.5	3.5	1.3	3.2	4.6	6.7	8.5
4	1	2.6	4	5.6	7.3	9	10.5	12.5	14.5	16.5	4	1	2.6	4	5.6	7.3
5	.7	2.2	3.2	4.2	5.5	6.8	7.0	9.4	11.5	13	5	.7	2.2	3.2	4.2	5.5
6	.6	1.8	2.5	3.5	4.5	5.6	6.0	7.7	9.3	10.7	6	.6	1.8	2.5	3.5	4.5

Model 536RF Circuit Board

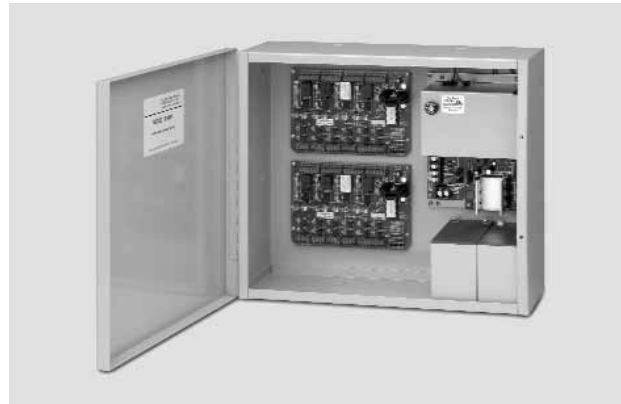
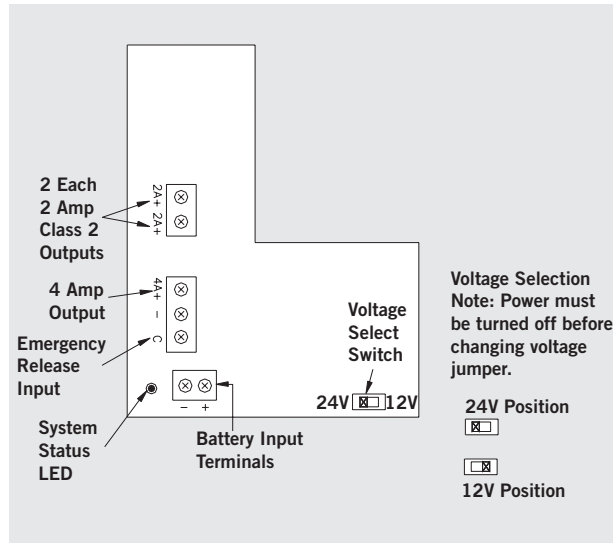

536RF x 2 UR4A x 2 RB12V7

Access Hardware Controller

UR-2A Two Station Controller

UR-4A Four Station Controller

The UR series is a microprocessor based controller that provides six different, field selectable application modes for one to four stations. The controller installs in 531RFA, 534RF and 536RF power supplies. Or, individual access hardware controllers may be mounted in remote junction boxes and powered by a single power supply.

Interface and Centralized Wiring:

The Access Hardware Controller provides complete system interface capability and centralized wiring of all components, including; access controls, electric locks, peripheral equipment and monitoring contacts.

Reduced Components and Engineering:

Applications that require several individual relays may be costly and complicated, requiring additional engineering time to produce the proper system logic. The UR eliminates the need for multiple or different relays. All system logic is reduced to one controller.

Selectable Output Modes:

- Conventional Relay
- Latching Relay (pulse on, pulse off)
Latch individual station or all stations
- Time Delay Relay 1-35 seconds
- Dual, Latching & Time Delay Relay*
- Mantrap -All doors normally locked
- Interlock - All doors normally unlocked

*Primary input triggers the Time Delay.
Auxiliary input triggers latch function.

The relay mode may be different per individual station. When mantrap or interlock mode is selected, all outputs operate the same.

Documentation:

Several access control and mantrap system wire diagrams are provided for common applications.

UR-2A Specifications

Input Voltage:

12 or 24 VDC ±10%

Input Current:

280 mA, at rest
350 mA, operating

Trigger Inputs:

N.O. Dry
Optically isolated

Outputs:

2 fused SPDT dry, 5 Amp @ 30 VDC
2 non-fused, SPDT dry, 1 Amp @ 30 VDC

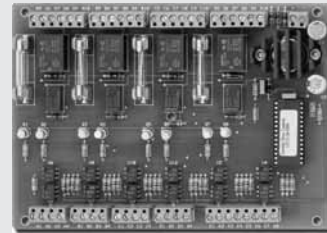

UR4A

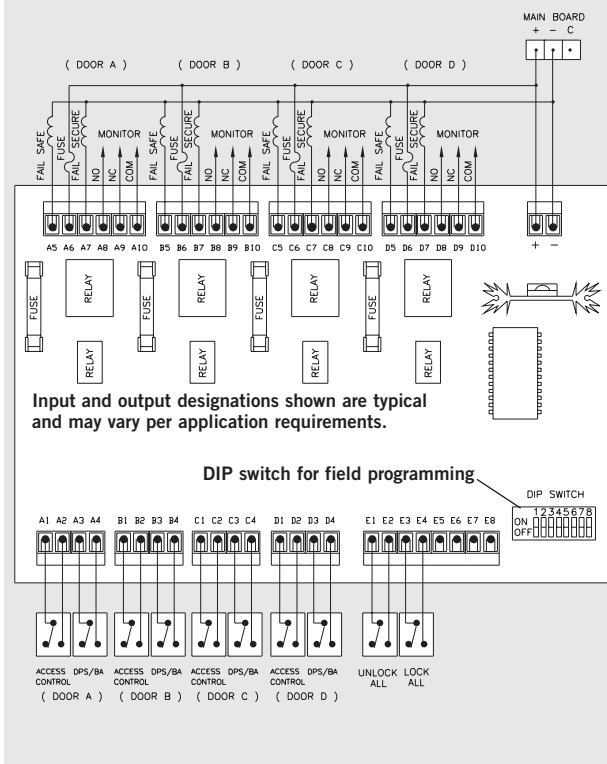

UR-4A Specifications

Input Voltage:

12 or 24 VDC ±10%

Input Current:

350 mA, at rest
430 mA, operating

Trigger Inputs:

N.O. Dry
Optically isolated

Outputs:

4 fused SPDT dry, 5 Amp @ 30 VDC
4 non-fused, SPDT dry, 1 Amp @ 30 VDC

Dimensions:

7" W x 5" H x 2" D (17.8 x 127 x 50.8 mm)

Door Control Modules

Door control relay modules ensure compatibility of access hardware components and simplify system installation and troubleshooting. Different modules may be specified for one power supply.

LR - Latching Relay Module

The optional LR module accepts a momentary switch closure to set or reset the latching voltage output. A momentary switch closure will latch the output voltage either **on** or **off** until it is reset by a momentary switch closing across the reset input pins. The LR module can be used to lock or unlock a door for an extended period of time. The output current cannot exceed the power supply rating.

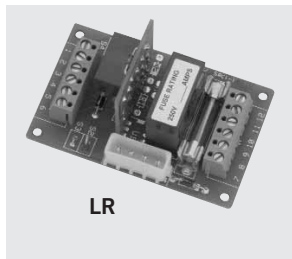

Input Voltage: Specify 12 or 24 VDC
Input Current: 35 mA
Trigger input: Two position, Center off, N.O., Dry, Momentary pulse to latch on and off
Voltage Output: Fused SPDT, 5 Amp @ 30 VDC
Dimensions: 3.25" W x 2" H

CR - Control Relay Module

The optional CR module accepts an input voltage trigger. Applying an Input voltage trigger or closing a switch across the dry trigger input will release the output for the amount of time that the trigger input is held closed. The CR module can be used to indicate status or implement multiple door interlocks. The output current cannot exceed the power supply rating.

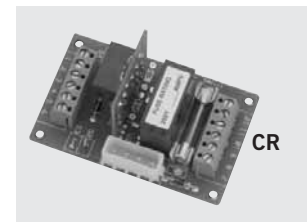

Input Voltage: Specify 12 or 24 VDC
Input Current: 35 mA
Dry Trigger Input: One N.O. Dry
Wet Trigger Input: Normally Off, Trigger Voltage must be the same as the relay and supply voltage, AC or DC
Relay Output: Non-fused SPDT Dry, 5 Amp @ 30 VDC

Voltage Output: Fused SPDT, 5 Amp @ 30 VDC
Dimensions: 3.25" W x 2" H

FB-4 - Fused Terminal Board

The optional FB-4 provides four (4) individually fused outputs for modular system protection. The fuse rating for each output is determined by the load current of each output. The total current of all outputs cannot exceed the power supply rating.

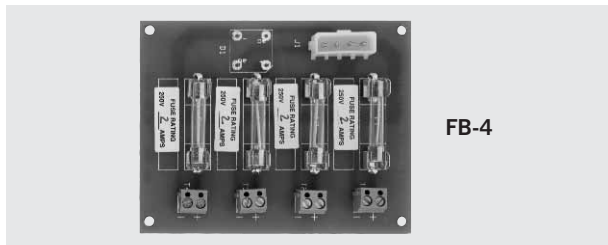

CR4 - Four Station Control Relay Module

The optional CR4 module provides control of four (4) stations. Closing a switch across the dry trigger input for station A, B, C, or D will release the output for the amount of time that the trigger input is held closed. Can be used to indicate status or implement multiple door interlocks. The total current of all outputs cannot exceed the power supply rating.

Input Voltage: 12 or 24 VDC
Input Current: 120 mA
Trigger Inputs: Four N.O. Dry
Fused Relay Outputs: Four, Fused SPDT Dry, 2 Amp @ 30 VDC
Non-fused Relay Outputs: Four, Non-fused, SPDT, Dry, 2 Amp @ 30 VDC

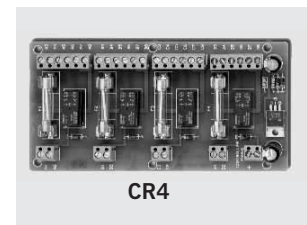

Dimensions: 6" W x 3.25"

TD - Time Delay Relay Module

When triggered, the optional TD module will unlock a door for a field adjustable time of 1 to 120 seconds. A reset trigger from a door position switch can be used to terminate the time delay and relock the door.

Input Voltage: 12 or 24 VDC
Input Current: 35 mA
Dry Trigger Inputs: One - N.O. Dry, One - N.C. Dry
Wet Trigger Input: Normally Off, Trigger voltage must be the same as the lock and supply voltage.

Anti-Tailgate/Reset Input: N.O. Dry, When the door opens the magnetic contact closes, resetting the timer. The door locks when closed.

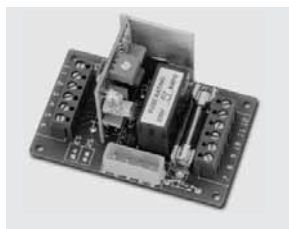

Voltage Output: Fused SPDT, 5 Amp @ 30VDC
Relay Output: Non-fused SPDT Dry, 5 Amp @ 30 VDC
Dimensions: 3.25" W x 2" H

ACM-1 - Access Control Interface Module

The optional ACM-1 module provides eight trigger inputs and can be used to indicate status or implement multiple door interlocks. The voltage output cannot exceed the power supply rating.

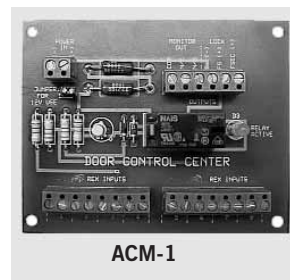

Input Voltage: 12 or 24VDC
Input Current: 45 mA
Eight Trigger Inputs: Four - N.C. and Four - N.O. Dry
Voltage Output: SPDT, 5 Amp @ 30 VDC
Relay Output: SPDT Dry, 5 Amp @ 30 VDC
Dimensions: 4.25" W x 3.75" H

How to Order:

Specify model, options, modules and batteries.

Example: 534RF x KL x 2 CR-4 x 6 RB12V7
534RF x PS-1 x 4 UR-4A x 6 RB12V7

Figure 1

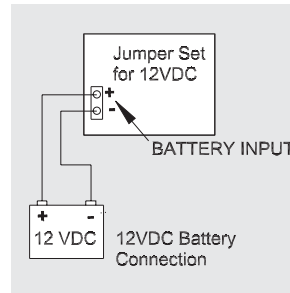
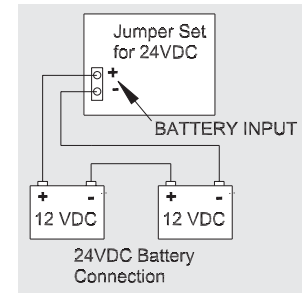
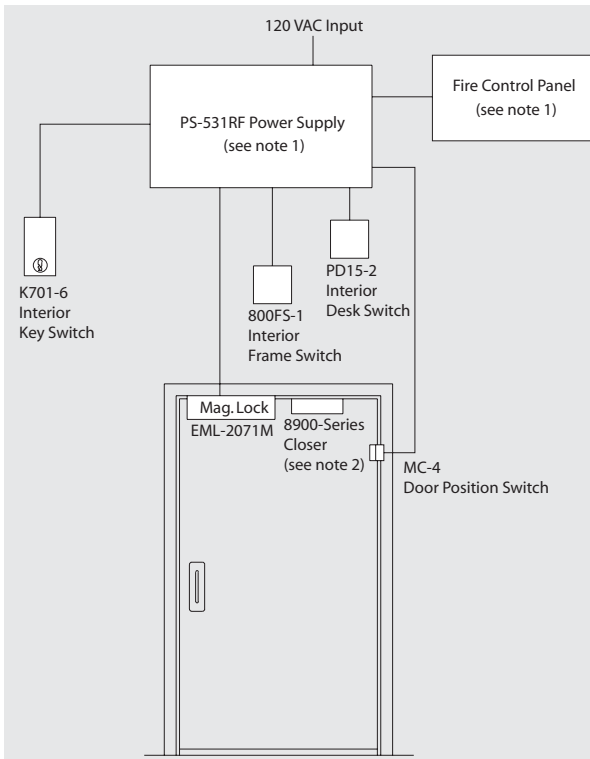

Figure 2



Wire Gauge Chart (AWG)		Distance in feet for 2 conductors from power source to the locking device.																				
AMPS	25	50	75	100	150	200	250	300	400	500	25	50	75	100	150	200	250	300	400	500	1000	
.025	18	18	18	18	18	18	16	16	14	14	18	18	18	18	18	18	18	18	18	18	16	16
0.50	18	18	18	18	16	14	14				18	18	18	18	18	18	18	16	16	16	14	
0.75	18	18	18	16	14	14					18	18	18	18	18	16	16	14	14			
1.00	18	18	16	14	14						18	18	18	18	16	16	14	14				
1.50	18	18	16	14							18	18	18	16	16	14						
2.00	18	16	14				Minimum Wire Gauge for 12V AC/DC					18	18	16	16	14		Minimum Wire Gauge for 24V AC/DC				
2.50	18	16					for 12V AC/DC					18	18	16	14			for 24V AC/DC				
3.00	16	14										18	16	14	14							
3.50	16											18	16	14								



Operation:

Normal Daytime Operation: The day/night keyswitch is in the day position, which disables power to the EML-2071M magnetic lock. Egress/entrance is by the push/pull trim.

Secure Nighttime Operation: The day/night keyswitch is in the night position, which enables power to the EML-2071M magnetic lock. Entrance is by the exterior pull trim, when the mag lock is disabled by the interior desk switch. Egress is by the interior push trim, when the mag lock is disabled by the interior desk switch or the interior frame switch. The TD time relay module provides an adjustable (1-120 seconds) mag lock relock time. The door position switch (DPS) resets the time relay module after the door opens, allowing the door to re-lock when closed.

Note 1: During a fire alarm condition, the normally closed contacts connected to the PS-531RF power supply output control input will open and remove the power supply 24 VDC output, disabling the EML-2071M mag lock.

Note 2: Door is closed automatically by the 8900 Series surface mounted door closer.

Parts List:

- 1 EA - EML-2071M Single Magnetic Lock (DORMA)
- 1 EA - PS -531RF Power Supply (DORMA)
- 1 EA - TD Time Delay Module (DORMA)
- 1 EA - MC-4 Door Position Switch (DORMA)
- 1 EA - 800 FS-1 Frame Switch (DORMA)
- 1 EA - PD15-2 Desk Switch (DORMA)
- 1 EA - K701-6 Key Switch (DORMA)
- 1 EA - 8900 Surface Door Closer (DORMA)

DORMA Group North America
www.dorma-usa.com

DORMA Architectural Hardware
DORMA Drive, Drawer AC
Reamstown, PA 17567-0411
Telephone: (800) 523-8483
Facsimile: (800) 274-9724
E-mail: archdw@dorma-usa.com

DORMA Canada
1680 Courtney Park Drive, Unit 13
Mississauga, Ontario L5T 1R4
Telephone: (800) 387-4938
Facsimile: (905) 670-5850
E-mail: sales@dormacanada.com

DORMA Mexico, S. de R.L. de C.V.
Astrónomos 28
Col. Escandón
11800, México, D.F.
Mexico
Telephone: (52+55) 5272-6937
Facsimile: (52+55) 5272-6948
E-mail: dormaoper@prodigy.net.mx