

# FALCON

## *24 Series and 25 Series*

Touch Bar Exit Device



# TABLE OF CONTENTS

Introducing the 24 Series and 25 Series	4	24 Series Accessories	26
25 Series Rim Devices	6	24 Series Strikes	27
25 Series Vertical Rod Devices	8	24 Series Trims	28
25 Series Mortise Devices	10	24 Series Finishes	29
25 Series Concealed Vertical Rod Devices	12	24 Series Types and Functions	30
25 Series Accessories	14	24 Series Door Application	32
25 Series Strikes	15	Electric Dogging	33
25 Series Trims	16	Electric Latch Retraction	34
25 Series Finishes	17	Delayed Egress	36
25 Series Types and Functions	18	Electric Lock/Unlock Trim	38
25 Series Door Application	19	Exit Alarm	39
24 Series Rim Devices	20	Device Monitoring	40
24 Series Vertical Rod Devices	22	Electrical Options Matrix	41
24 Series Concealed Vertical Rod Devices	24	How to Order	42



## THE FALCON DIFFERENCE

SAFETY, SECURITY AND UNCOMPROMISING VALUE

**At Falcon, we know that every product you sell not only has to meet local building codes, but also your expectations for performance, style and quality. We take your expectations seriously, and that's why we build our door hardware to deliver durability, convenience and unmatched value. After all, we've built our reputation on the same standards that you have – providing quality door hardware at a reasonable price delivered on time. It's the way we do business and it's what makes Falcon a powerful choice no matter what your project.**



## INTRODUCING THE FALCON 24 SERIES AND 25 SERIES

**The perfectly simple, tougher than nails, costs less than you think, fits anywhere exit device.**



Offices, banks, assisted living facilities, retail stores and other commercial buildings have constant traffic, so door hardware must be able to take continual use and abuse. The new Falcon 24 Series and 25 Series exit devices fill the bill with some of the toughest, most reliable performance in the business. A host of features makes this a smart solution, like a choice of an A or B label fire rating, electrified and panic options, and a full complement of trims. Sleek, streamlined styling and a choice of wide (25 Series) and narrow stile (24 Series) device applications means a smart solution for your building design, as well as its use. And since they're backed by one of the best names in the business, you can be sure you're getting the utmost value, reliability and durability.

- Offices
- Retail
- Restaurants
- Schools
- Churches
- Assisted living
- Hospitality
- New construction/remodel

## Engineered tough.

### FEATURES

Streamlined design includes flush-end cap for clean lines and a more attractive installation.

Stainless steel pushpad cover for a scratch-resistant surface.

Clean design with no exposed screws or rivets on the back of the device.

Patent-pending deadlocking technology ensures reliable security.

One trim input design for maximum versatility.

Extruded aluminum construction delivers greater strength and impact resistance.

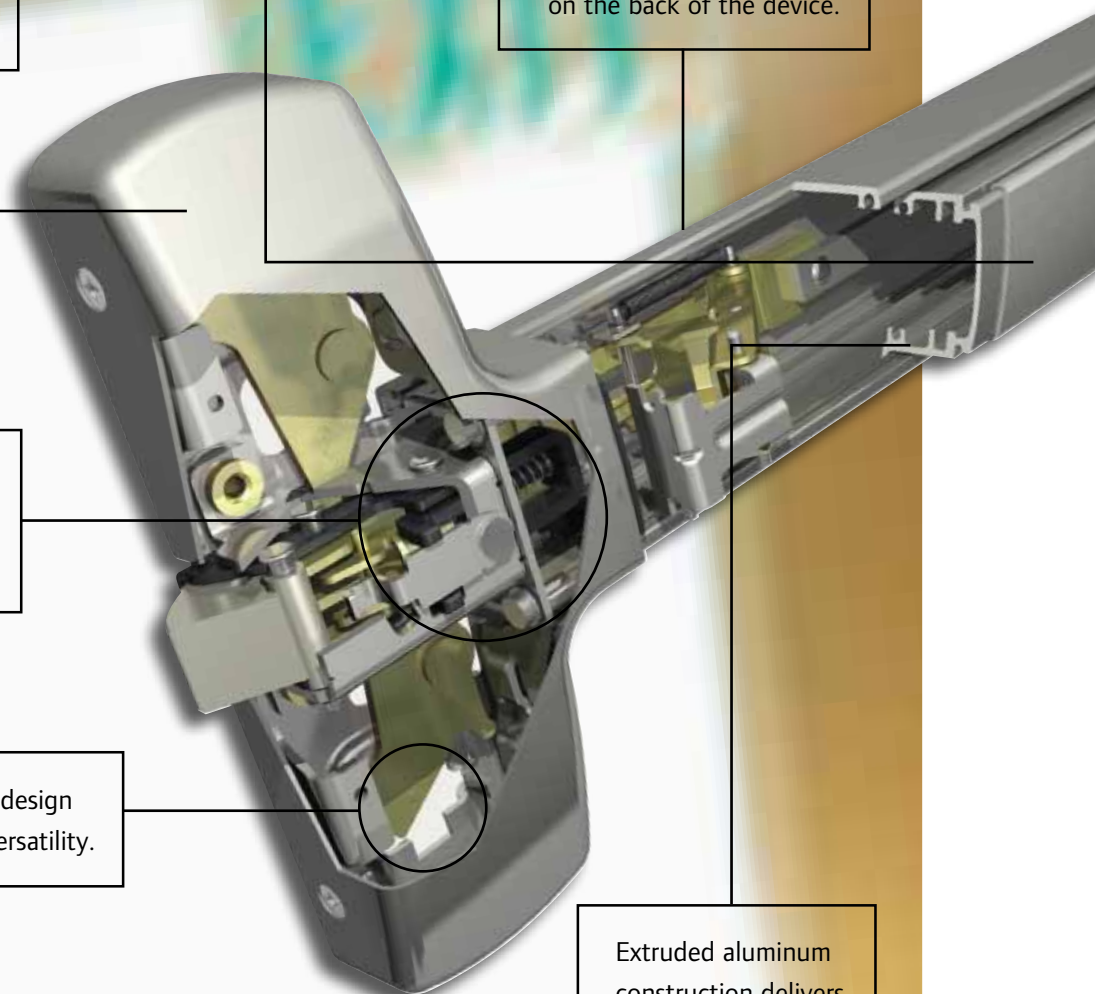

# 25-R SERIES RIM DEVICE

## Panic Exit Hardware

The Falcon 25-R Series rim device meets the demanding requirements of high traffic installations with a single-point, rim type latch and a streamlined touch bar design. This device can also be electrified for maximum ease of use and accessibility.



299 Strike



2789 Dogging Key



Cylinder Dogging

### SINGLE DOOR APPLICATION

DEVICE	Door Size	Door Strike	Min Stile (in)	Min Door Opening Width
25-R	3'	299	4"	2' 7½"
		264	3⅞"	2' 7⅝"
		1439	3¼"	2' 6½"
		1606	3⅝"	2' 7"
25-R	4'	299	4"	3' 1½"
		264	3⅞"	3' 1⅝"
		1439	3¼"	3' ½"
		1606	3⅝"	3' 1"

### DOUBLE DOOR APPLICATION

DEVICE	Door Size	Strike x Mullion	Min Stile (in)	Min Door Opening Width
25-R	3'	299 x 2923	4⅞"	2' 7⅝"
		299 x 4023	4⅞"	2' 7⅞"
		264 x 2923	4"	2' 7½"
		264 x 4023	4¼"	2' 7¾"
		1439 x 2923	3⅞"	2' 7¾"
		1439 x 4023	4⅞"	2' 7⅞"
		1606 x 2923	4¼"	2' 7¼"
		1606 x 4023	4½"	2' 7½"
25-R	4'	299 x 2923	4⅞"	3' 1⅝"
		299 x 4023	4⅞"	3' 1⅞"
		264 x 2923	4"	3' 1½"
		264 x 4023	4¼"	3' 1¾"
		1439 x 2923	3⅞"	3' 1⅝"
		1439 x 4023	4⅞"	3' 1⅞"
		1606 x 2923	4¼"	3' 1¼"
		1606 x 4023	4½"	3' 1½"
25-V x 25-R	3'	1609	2⅝"	2' 7¾"
25-V x 25-R	4'	1609	2⅝"	3' 1¾"

## Specifications

<b>Hand:</b>	Non-handed.
<b>Finishes:</b>	US3 (605); US4 (606); US10 (612); US26 (625); US26D (626); US32 (629); US32D (630); US28 (628), 313AN. (See page 17 for finishes.)
<b>Strikes:</b>	299 strike standard. See page 15 for additional info.
<b>Latchbolt:</b>	Stainless steel, ¾" throw.
<b>Deadlocking Latchbolt:</b>	Standard.
<b>Dogging Feature:</b>	1/2 turn hex dogging standard. No threaded parts to wear out.
<b>Cylinder Dogging:</b>	Specify "CD" prefix. Uses 1-1/8" long mortise cylinder with standard cam.
<b>Stock Sizes:</b>	See chart to left. Cut to size in the field.
<b>Doors:</b>	1-¾" thick, wood or metal. Specify thickness if other than 1-¾".
<b>Projection:</b>	2¾" maximum, 2" dogged.
<b>Mounting Height:</b>	40¼" from CL to finished floor.
<b>Electric Function:</b>	Can be interfaced with building security systems. Latch retraction, FSA/FSE trim, security monitoring, electric dogging, delayed egress and exit alarm available (EL and ED fail-secure only). Subject to code requirements, state and local. (See pages 33-41 for details).
<b>Fasteners:</b>	All mounting screws are concealed, sheet metal screws and machine screws standard.
<b>Sex Bolts:</b>	Recommended when device is used with hollow core wood, composite or light gauge hollow metal doors. For EO device, specify 8 - 425 (#10-24) SNB. For devices with trim, specify 2 - 425 (#10-24) SNB.
<b>ANSI:</b>	Certified ANSI A156.3-2001 Grade 1 standards.
<b>Center Case &amp; Working Parts:</b>	Center case is heavy wrought and sintered metal parts.
<b>Shim Kit:</b>	For glass lite applications; ¼" thick, specify SK25-RM.
<b>579 Strike Retrofit Kit:</b>	Consult factory.

# F-25-R SERIES RIM DEVICE

## Fire Exit Hardware

The Falcon F-25-R Series rim device combines sleek styling and durability with the protection of a fire-rated device. The F-25-R also features a single-point, rim type latch and can be electrified.



299F Strike



### SINGLE DOOR APPLICATION

DEVICE	Door Size	Door Strike	Min Stile (in)	Min Door Opening Width
F-25-R	3'	299-F	4"	2' 7 $\frac{1}{2}$ "
F-25-R	4'	299-F	4"	3' 1 $\frac{1}{2}$ "

### DOUBLE DOOR APPLICATION

DEVICE	Door Size	Strike x Mullion	Min Stile (in)	Min Door Opening Width
F-25-R	3'	299-F x F-4023	4 $\frac{3}{8}$ "	2' 7 $\frac{1}{8}$ "
		499-F x F-4023	4 $\frac{1}{2}$ "	2' 7 $\frac{1}{8}$ "
F-25-R	4'	299-F x F-4023	4 $\frac{3}{8}$ "	3' 1 $\frac{1}{8}$ "
		499-F x F-4023	4 $\frac{1}{2}$ "	3' 1 $\frac{1}{8}$ "

## Specifications

<b>Hand:</b>	Non-handed.
<b>UL:</b>	"A" label (3 hr.); 4'0" x 8'0"; 8'0" x 8'0" with F-4023 mullion. "B" label (1 $\frac{1}{2}$ hr.); 8'0" x 8'0"; with KRF4023.
<b>Finishes:</b>	US3 (605); US4 (606); US10 (612); US26 (625); US26D (626); US32 (629); US32D (630); US28 (628), 313AN. (See page 17 for finishes.)
<b>Strikes:</b>	299F strike standard 499F with mullion optional
<b>Latchbolt:</b>	Stainless steel, $\frac{3}{4}$ " throw.
<b>Deadlocking Latchbolt:</b>	Standard.
<b>Stock Sizes:</b>	See chart to left. Cut to size in the field.
<b>Doors:</b>	1 $\frac{3}{4}$ " thick, wood or metal. Specify thickness if other than 1 $\frac{3}{4}$ ".
<b>Projection:</b>	2 $\frac{3}{4}$ " maximum.
<b>Mounting Height:</b>	40 $\frac{1}{4}$ " from CL to finished floor.
<b>Electric Function:</b>	Can be interfaced with building security systems. Latch retraction, FSA/FSE trim, security monitoring, electric dogging, delayed egress and exit alarm available (EL and ED fail- secure only). Subject to code requirements, state and local. (See pages 33-41 for details).
<b>Fasteners:</b>	All mounting screws are concealed, sheet metal screws and machine screws standard.
<b>Sex Bolts:</b>	Required for use in EO applications when used with wood, composite or non-reinforced hollow metal doors. For EO device, specify 8 - 425 (#10-24) SNB. For devices with trim, specify 2 - 425 (#10-24) SNB.
<b>ANSI:</b>	Certified ANSI A156.3-2001 Grade 1 standards.
<b>Center Case &amp; Working Parts:</b>	Center case is heavy wrought and sintered metal parts.
<b>Shim Kit:</b>	For glass lite applications; $\frac{1}{4}$ " thick, specify SK25-RM.

# 25-V SERIES VERTICAL ROD DEVICE

## Panic Exit Hardware

High-traffic applications demand the added strength and protection that comes with a vertical rod device. The Falcon F-25-V Series delivers with a surface-applied design that includes standard top latch and deadlocking. The sleek touch bar design ensures an attractive installation.



## Specifications

<b>Hand:</b>	Field reversible.
<b>Finishes:</b>	US3 (605); US4 (606); US10 (612); US26 (625); US26D (626); US32 (629); US32D (630); US28 (628), 313AN. (See page 17 for finishes.)
<b>Strikes:</b>	3788 top strike is surface applied. 2130 bottom strike is mortised into floor.
<b>Angle Bracket:</b>	Use 4215 angle bracket in flush transom installations. Allows use of standard 3788 strike.
<b>Latchbolt:</b>	Top stainless steel 3/4" throw. Bottom bolt, 1/2" throw.
<b>Deadlocking Latchbolt:</b>	Standard in top latch.
<b>Latch Retention Hold:</b>	Standard with top latch.
<b>Dogging Feature:</b>	1/2 turn hex dogging standard. No threaded parts to wear out.
<b>Cylinder Dogging:</b>	Specify "CD" prefix. Uses 1 1/8" long mortise cylinder with standard cam.
<b>Stock Sizes:</b>	See chart below.
<b>Doors:</b>	1 3/4" thick wood or metal. Specify if other than 1 3/4" thick.
<b>Projection:</b>	2 3/4" maximum, 2" dogged.
<b>Stile:</b>	See chart below.
<b>Electric Function:</b>	Can be interfaced with building security systems. Latch retraction, FSA/FSE trim, security monitoring, electric dogging, delayed egress and exit alarm available (EL and ED fail-secure only). Subject to code requirements, state and local. (See pages 33-41 for details).
<b>Fasteners:</b>	All mounting screws are concealed, sheet metal screws standard, machine screws available, specify AMS.
<b>Sex Bolts:</b>	Recommended when device is used with hollow core wood, composite or light gauge hollow metal doors. For EO device, specify 12 - 425 (#10-24) SNB. For devices with trim, specify 8 - 425 (#10-24) SNB.
<b>ANSI:</b>	Certified ANSI A156.3-2001 Grade 1 standards.
<b>25-V:</b>	Latch Retention (LR) top latch and bottom square bolt. 3788 strike top, 2130 flush strike bottom.
<b>Vertical Rods:</b>	Furnished to length based on a 40 1/4" horizontal CL from finished floor and a 7'0" door standard. Variations from these standards must be specified when ordering.
<b>25-V-LBR:</b>	Less bottom rod vertical device.
<b>Shim Kit:</b>	For glass lite applications; 1/4" thick, specify SK25-V.

DEVICE	Door Size	Door Strike	Min Stile (in)	Min Door Opening Width
25-V	3'	all	3 1/2"	2' 6 3/8"
25-V	4'	all	3 1/2"	3' 3/8"
25-V x 25-R	3'	1609	4 1/4"	2' 7 3/4"
25-V x 25-R	4'	1609	4 1/4"	3' 1 3/4"



# F-25-V SERIES VERTICAL ROD DEVICE

## Fire Exit Hardware

When your application requires strength and durability, plus fire rated performance, the F-25-V Series is the total package. This surface-applied vertical rod device includes a sleek touch bar design with top latch and deadlocking standard.



## Specifications

<b>Hand:</b>	Field reversible.
<b>UL:</b>	"A" Label (3 Hr) - 8' x 10'; 90 min. same egress - 8' x 10' Wood Door: 20 min. 8' x 10'; 90 min. 8' x 9'. Consult door manufacturer for maximum rating.
<b>Finishes:</b>	US3 (605); US4 (606); US10 (612); US10B (613); US26 (625); US26D (626); US32 (629); US32D (630); US28 (628), 313AN. (See page 17 for finishes.)
<b>Strikes:</b>	3788 top strike is surface applied. 2130 bottom strike is mortised into floor.
<b>Latchbolt:</b>	Top stainless steel, 3/4" throw. Bottom bolt, 1/2" throw.
<b>Deadlocking Latchbolt:</b>	Standard in top latch.
<b>Latch Retention Hold:</b>	Standard with top latch.
<b>Stock Sizes:</b>	See chart below.
<b>Doors:</b>	1 3/4" thick, wood or metal. Specify thickness if other than 1 3/4".
<b>Projection:</b>	2 3/4" maximum.
<b>Stile:</b>	See chart below.
<b>Electric Function:</b>	Can be interfaced with building security systems. Latch retraction, FSA/FSE trim, security monitoring, electric dogging, delayed egress and exit alarm available (EL and ED fail-secure only). Subject to code requirements, state and local. (See pages 33-41 for details).
<b>Fasteners:</b>	All mounting screws are concealed. All machine screws (AMS) standard.
<b>Sex Bolts:</b>	Required when used with wood, composite or non-reinforced hollow metal doors. For EO device, specify 12 - 425 (#10-24) SNB. For devices with trim, specify 8 - 425 (#10-24) SNB.
<b>ANSI:</b>	Certified ANSI A156.3-2001 Grade 1 standards.
<b>F-25-V:</b>	Latch Retention (LR) top latch and bottom square bolt. 3788 strike top, 2130 flush strike bottom.
<b>F-25-V-LBR:</b>	Less bottom rod vertical device. "A" Label (3 Hr) - 8' x 8'; 90 min. same egress - 8' x 8'. Wood Door: 20 minute minimum - 8' x 8' openings. Consult door manufacturer for maximum rating.
<b>Vertical Rods:</b>	Furnished to length based on a 40 1/4" horizontal CL from finished floor and a 7'0" door standard. Variations from these standards must be specified when ordering.
<b>Shim Kit:</b>	For glass lite applications; 1/4" thick, specify SK25-V.

DEVICE	Door Size	Door Strike	Min Stile (in)	Min Door Opening Width
F-25-V	3'	all	3 1/2"	2' 6 3/8"
F-25-V	4'	all	3 1/2"	3' 3/8"

# 25-M SERIES MORTISE DEVICE

## Panic Exit Hardware

The Falcon 25-M Series is the only device that pairs a tough, reliable exit device with our strongest mortise lock. The result is maximum safety and security in a single-point, mortise latch type device that also has an attractive touch bar design.



1279  
Standard Strike



2789  
Dogging Key



Mortise  
Lock



Cylinder Dogging

DEVICE	Door Size	Door Strike	Min Stile (in)	Min Door Opening Width
25-M	3'	all	4½"	2' 7⅝"
25-M	4'	all	4½"	3' 1⅜"

## Specifications

<b>Hand:</b>	Field reversible.
<b>Finishes:</b>	US3 (605); US4 (606); US10 (612); US26 (625); US26D (626); US32 (629); US32D (630); US28 (628), 313AN. (See page 17 for finishes.)
<b>Strikes:</b>	1279 standard, F1280 and 1281 optional.
<b>Latchbolt:</b>	Stainless steel, ¾" throw.
<b>Deadlocking Latchbolt:</b>	Standard.
<b>Dogging Feature:</b>	½ turn hex dogging standard. No threaded parts to wear out.
<b>Cylinder Dogging:</b>	Specify "CD" prefix. Uses 1¼" mortise cylinder with standard cam.
<b>Mounting Height:</b>	40¼" from CL to finished floor. For mortise lock prep per ANSI A115.1-1990.
<b>Electric Function:</b>	Can be interfaced with building security systems. Latch retraction, FSA/FSE trim, security monitoring, electric dogging, delayed egress and exit alarm available (EL and ED fail-secure only). Subject to code requirements, state and local. (See pages 33-41 for details).
<b>Stile:</b>	4½" minimum.
<b>Projection:</b>	2¾" maximum, 2" dogged.
<b>Stock Sizes:</b>	See chart.
<b>Doors:</b>	1¾" thick, wood or metal. Specify thickness if other than 1¾".
<b>Fasteners:</b>	All mounting screws are concealed, sheet metal screws and machine screws standard.
<b>Sex Bolts:</b>	Recommended when device is used with hollow core wood, composite or light gauge hollow metal doors. For EO device, specify 6 - 425 (#10-24) SNB. For devices with trim, specify 2 - 425 (#10-24) SNB.
<b>ANSI:</b>	Certified ANSI A156.3-2001 Grade 1 standards.
<b>Mortise Lock:</b>	Heavy wrought lock case with investment cast or sintered steel parts. Lock face is forged brass—fits standard cutout. Locks are designed to fit standard ANSI A115.1 preparation for 1¾" doors. Deadlocked when auxiliary bolt is depressed ⅝".
<b>Shim Kit:</b>	For glass lite applications; ¼" thick, specify SK25-RM.

# F-25-M SERIES MORTISE DEVICE

## 🔥 Fire Exit Hardware

The Falcon F-25-M Series delivers the safety of a fire-rated exit device with a choice of ratings. The F-25-M can be paired with a Falcon mortise lock, assuring a tough and secure lock for any opening requiring a high level of safety and security.



DEVICE	Door Size	Door Strike	Min Stile (in)	Min Door Opening Width
F-25-M	3'	all	4½"	2' 7⅝"
F-25-M	4'	all	4½"	3' 1⅜"

Specifications	
<b>Hand:</b>	Field reversible.
<b>UL:</b>	"A" label (3 hr.); 4'0" x 10'0" single doors; 8'0" x 10'0" pair of doors (F-25-M x F-25-V or F-25-C). "B" label (1-1/2 hr) with F1280 open back strike.
<b>Finishes:</b>	US3 (605); US4 (606); US10 (612); US26 (625); US26D (626); US32 (629); US32D (630); US28 (628), 313AN. (See page 17 for finishes.)
<b>Strikes:</b>	1279 standard. F1280 optional, B label (1½ hr.).
<b>Latchbolt:</b>	Stainless steel, ⅜" throw.
<b>Deadlocking Latchbolt:</b>	Standard.
<b>Stock Sizes:</b>	See chart.
<b>Doors:</b>	1¾" thick, wood or metal. Specify thickness if other than 1¾".
<b>Projection:</b>	2¾" maximum.
<b>Stile:</b>	4½" minimum.
<b>Mounting Height:</b>	40 ¼" from CL to finished floor. For mortise lock prep per ANSI A115.1-1990.
<b>Electric Function:</b>	Can be interfaced with building security systems. Latch retraction, FSA/FSE trim, security monitoring, electric dogging, delayed egress and exit alarm available (EL and ED fail-secure only). Subject to code requirements, state and local. (See pages 33-41 for details).
<b>Fasteners:</b>	All mounting screws are concealed. All machine screws (AMS) standard.
<b>Sex Bolts:</b>	Required when used with wood, composite or non-reinforced hollow metal doors. For EO device specify 6 - 425 (#10-24) SNB. For devices with trim, specify 2 - 425 (#10-24) SNB.
<b>ANSI:</b>	Certified ANSI A156.3-2001 Grade 1 standards.
<b>Mortise Lock:</b>	Heavy wrought lock case with investment cast or sintered steel parts. Lock face is forged brass—fits standard cutout. Locks are designed to fit standard ANSI A115.1 preparation for 1¾" doors. Deadlocked when auxiliary bolt is depressed ⅜".
<b>Shim Kit:</b>	For glass lite applications; ¼" thick, specify SK25-RM.

# 25-C SERIES CONCEALED VERTICAL ROD DEVICE

## Panic Exit Hardware

Concealed vertical rods add strength to the door, while maintaining an attractive appearance. The Falcon 25-C Series concealed vertical rod device offers great value, clean styling and the security benefits of two-point latching. Falcon's patented center slide mechanism allows easy rod adjustment in the field.

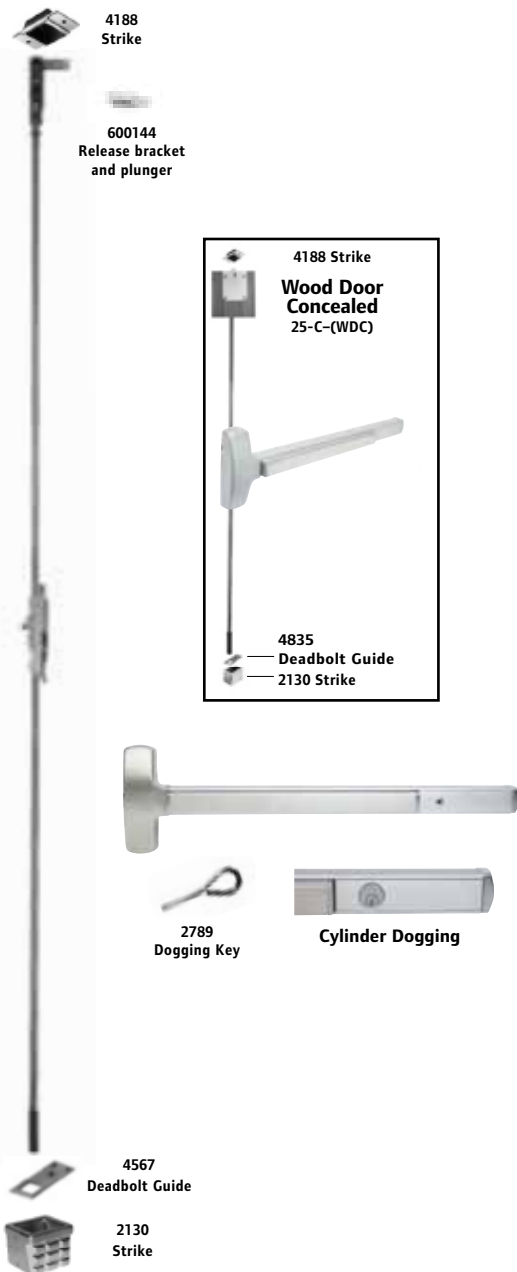

## Specifications

<b>Hand:</b>	Field reversible.
<b>Finishes:</b>	US3 (605); US4 (606); US10 (612); US26 (625); US26D (626); US32 (629); US32D (630); US28 (628), 313AN. (See page 17 for finishes.)
<b>Strikes:</b>	4188 mortised top, 2130 bottom standard, 4155 and 2126A bottom optional
<b>Latchbolt:</b>	Top stainless steel $\frac{3}{4}$ " throw. Bottom bolt $\frac{1}{2}$ " throw.
<b>Deadlocking Latchbolt:</b>	Standard in top latch.
<b>Latch Retention Hold:</b>	Standard in top latch.
<b>Dogging Feature:</b>	$\frac{1}{2}$ turn hex dogging standard. No threaded parts to wear out.
<b>Cylinder Dogging:</b>	Specify "CD" prefix. Uses $1\frac{1}{2}$ " long mortise cylinder dogging with standard cam.
<b>Stock Sizes:</b>	See chart.
<b>Doors:</b>	$1\frac{3}{4}$ " thick metal or wood. Specify if other than $1\frac{3}{4}$ " thick.
<b>Projection:</b>	$2\frac{3}{4}$ " maximum, 2" dogged.
<b>Stile:</b>	$3\frac{1}{2}$ " minimum. ( $6\frac{1}{2}$ " minimum on wood doors.)
<b>Electric Function:</b>	Can be interfaced with building security systems. Latch retraction, FSA/FSE trim, security monitoring, electric dogging, delayed egress and exit alarm available (EL and ED fail- secure only). Subject to code requirements, state and local. (See pages 33-41 for details.)
<b>Fasteners:</b>	All mounting screws are concealed, sheet metal screws standard, machine screws available, specify AMS.
<b>Sex Bolts:</b>	Recommended when device is used with hollow core wood, composite or light gauge hollow metal doors. For EO device, specify 6 - 425 (#10-24) SNB. For devices with trim, specify 2 - 425 (#10-24) SNB.
<b>ANSI:</b>	Certified ANSI A156.3-2001 Grade 1 standards.
<b>WDC:</b>	Reinforcement plates supplied standard.
<b>25-C-LBR, 25-C-WDC-LBR:</b>	Less bottom rod concealed vertical device.
<b>Vertical Rods:</b>	Furnished to length based on $40\frac{1}{4}$ " horizontal CL to finished floor and a 7'0" door. Variations from these standards must be specified when ordering.
<b>Patented Centerslide:</b>	For ease of adjustment.
<b>Shim Kit:</b>	Consult factory.

DEVICE	Door Size	Door Strike	Min Stile (in)	Min Door Opening Width
25-C	3'	all	$3\frac{1}{2}$ "	$2' 6\frac{3}{8}$ "
25-C	4'	all	$3\frac{1}{2}$ "	$3' \frac{3}{8}$ "

# F-25-C SERIES CONCEALED VERTICAL ROD DEVICE

## Fire Exit Hardware

The Falcon F-25-C Series device lets you combine the safety of a fire-rated device with the clean aesthetics that come with a concealed vertical rod installation. In-field adjustment is simple thanks to our patented center slide mechanism. Two-point latching ensures optimal security at the door.

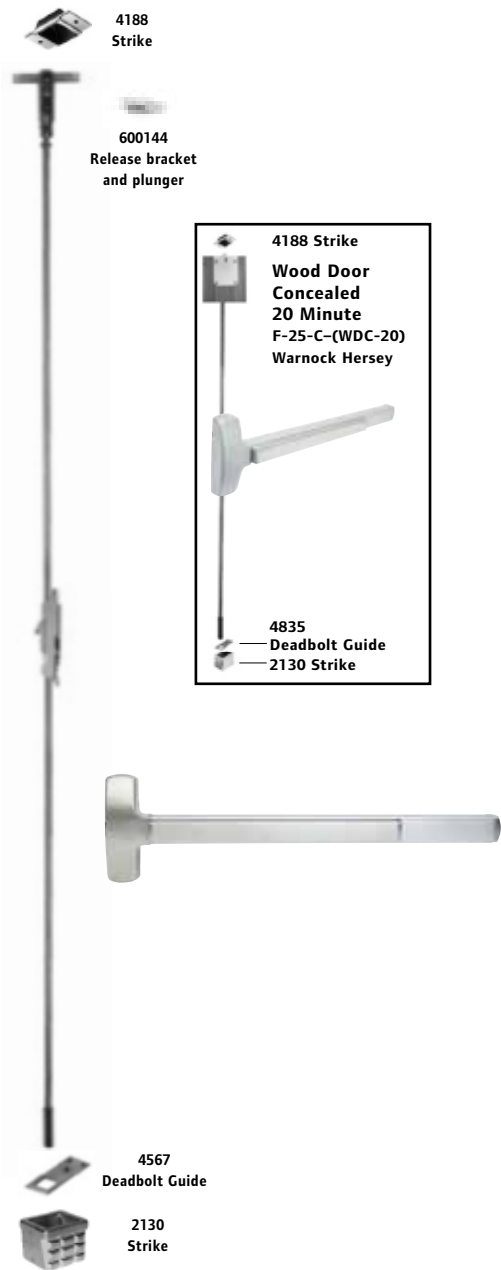

## Specifications

<b>Hand:</b>	Field reversible.
<b>UL:</b>	"A" Label (3 Hr) - 8' x 10'; 90 min. same egress - 8' x 10'. Wood Door: 20 min. 8' x 9'; 90 min. 8' x 8'. Consult door manufacturer for maximum rating. Edge channel may be required.
<b>Finishes:</b>	US3 (605); US4 (606); US10 (612); US26 (625); US26D (626); US32 (629); US32D (630); US28 (628), 313AN. (See page 17 for finishes.)
<b>Strikes:</b>	4188 mortised top; 2130 flush strike bottom.
<b>Latchbolt:</b>	Top stainless steel, 3/4" throw. Bottom bolt 1/2" throw.
<b>Deadlocking Latchbolt:</b>	Standard in top latch.
<b>Latch Retention Hold:</b>	Standard in top latch.
<b>Stock Sizes:</b>	See chart.
<b>Doors:</b>	1 3/4" thick metal or wood. Specify if other than 1 3/4" thick.
<b>Projection:</b>	2 3/4" maximum.
<b>Stile:</b>	3 1/2" minimum. (6 1/2" minimum on wood doors.)
<b>Electric Function:</b>	Can be interfaced with building security systems. Latch retraction, FSA/FSE trim, security monitoring, electric dogging, delayed egress and exit alarm available (EL and ED fail- secure only). Subject to code requirements, state and local. (See pages 33-41 for details.)
<b>Fasteners:</b>	All mounting screws are concealed. All machine screws (AMS) standard.
<b>Sex Bolts:</b>	Required when used with wood, composite or non-reinforced hollow metal doors. For EO device specify 6 - 425 (#10-24) SNB. For devices with trim, specify 2 - 425 (#10-24) SNB.
<b>ANSI:</b>	Certified ANSI A156.3-2001 Grade 1 standards.
<b>WDC-20:</b>	Reinforcement plates supplied standard for 20-min. doors only.
<b>F-25-C-LBR:</b>	Less bottom rod concealed vertical device. "A" Label (3 Hr) - 8' x 8'; 90 min. same egress - 8' x 8'.
<b>F-25-C-WDC-LBR:</b>	Less bottom rod concealed vertical device. Wood Door: 20 minute minimum - 8' x 8' openings. Consult door manufacturer for maximum rating. Edge channel may be required.
<b>Vertical Rods:</b>	Furnished to length based on 40 1/4" horizontal CL to finished floor and a 7'-0" door. Variations from these standards must be specified when ordering.
<b>Patented Centerslide:</b>	For ease of adjustment.
<b>Shim Kit:</b>	Consult factory.

DEVICE	Door Size	Door Strike	Min Stile (in)	Min Door Opening Width
F-25-C	3'	all	3 1/2"	2' 6 3/8"
F-25-C	4'	all	3 1/2"	3' 3/8"

# 25 SERIES ACCESSORIES AND OPTIONS



F-4023 Shown

## Removable Mullion

- The 2923, F4023, 4023, KRF-4023 and KR-4023 steel mullions are for use with the 25-R devices on double door openings. Advantage: Increased security and tighter closure. Minimizes door warpage and sag. Regulates the flow of in-and-out traffic.
- Falcon removable mullions are easily removed and reinstalled for full width access.
- Rim devices are used on both leaves, attaining a perfectly symmetrical opening.
- The mullion assembly consists of a mullion, top and bottom mounting brackets and a screw pack.
- The F4023 and KRF-4023 fire-rated mullions also include four stabilizer blocks as required for labeled installations.
- Strikes are not furnished with the mullion. Please see page 15 for strike information.
- Mullions may be cut on the job for doors under stock lengths.
- KR Mullions require 1 1/4" mortise cylinder with standard A cam.

### Mullion Features

- Mullion fittings – ductile iron.
- F4023, 4023, KRF-4023 and KR-4023– 2" x 3" x height.
- 2923 mullion – 1 1/2" x 2 1/2" x height.
- Prime coat only.
- 7' or 8' door opening standard, other door opening as specified.

### (F)25-R DOUBLE DOOR APPLICATION

Strike	Installed With	Min. Stile	B*
299	2923 mullion	4 1/8"	3"
299	4023 mullion	4 3/8"	3 1/4"
299-F	F-4023 mullion	4 3/8"	3 1/4"
499-F	F-4023 mullion	4 1/2"	3 5/16"
264	2923 mullion	4"	2 7/8"
264	4023 mullion	4 1/4"	3 1/8"
1439	2923 mullion	3 7/8"	2 3/4"
1439	4023 mullion	4 1/8"	3"
1606	2923 mullion	4 1/4"	2 5/8"
1606	4023 mullion	4 1/2"	2 7/8"
1609	Surface 25-V	4"	2 3/8"

\*Backset to vertical center line on the device.

## Cylinders

- Cylinder supplied only when specified.
- Cylinders keyed different unless specified keyed alike.

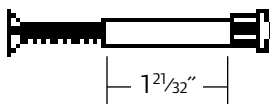

## Sex Bolts

- 325 (1/4"-20 Thread)
- 425 (#10-24 Thread)

## Dummy Touch Bars

- Active and Inactive models only. Active model offered with AE or AE/KOR. Consult factory for details.
- To order, specify 250DT X finish, or 250DT X finish X active touch bar.

### CYLINDER REFERENCE

Device	Trim	Standard Key Cylinder	IC Key Cylinder
25 Series Device	Cylinder Dogging	985 - 1 1/8" Mortise Cylinder	C987 - 1 3/8" Mortise Cylinder (Blocking Ring plus Security collar must equal 1/4" Thick)
25 Series Device Rim & Surface Vertical	Cylinder Only (NL-OP)	951- Rim Cylinder	C953 - Rim Cylinder
25 Series Device Mortise	Cylinder Only (NL-OP)	*986 - 1 1/4" Mortise Cylinder	**C987 - 1 3/8" Mortise Cylinder
25 Series Trims	L, K, TP, NL	986 - 1 1/4" Mortise Cylinder	C987 - 1 3/8" Mortise Cylinder





\* Cylinder must be spaced off of the door a minimum of 1/4" via a recessed blocking ring

\*\* Cylinder must be spaced off of the door a minimum of 3/8" via a recessed blocking ring





# 25 SERIES STRIKES AND ACCESSORIES

## Strikes



### For Rim Devices

 <p><b>299</b> Projection - <math>\frac{13}{16}</math>" Panic device only.</p>	 <p><b>1439 Blade Stop</b> Projection - <math>\frac{1}{2}</math>" Panic device only.</p>	 <p><b>1606</b> Projection - <math>\frac{3}{8}</math>" Panic device only.</p>	 <p><b>1609</b> Requires coordinator. Panic device only.</p>
 <p><b>264</b> Projection - <math>\frac{9}{16}</math>" Panic device only.</p>	 <p><b>299F</b> Projection - <math>\frac{13}{16}</math>"</p>	 <p><b>499F</b> Projection - <math>\frac{15}{16}</math>"</p>	



### For Surface and Concealed Vertical Rod Devices

<p><b>3788</b> Furnished top of (F)25-V.</p> 	<p><b>4188</b> Top strike for (F)25-C.</p> 	
<p><b>2130</b> (F)25-V and (F)25-C standard bottom strike for grouting into concrete or masonry floors.</p> 	<p><b>2126A</b> Optional bottom strike. Panic device only.</p> 	<p><b>4155</b> Optional strike. Panic device only.</p> 

### For Mortise Lock Devices

<p><b>1279</b> Closed strike used on single doors and on fire exit hardware doors with coordinator.</p> 	<p><b>F1280</b> Open back strike used on pairs of <math>1\frac{3}{4}</math>" doors without astragal or coordinator. Can be used on stock hollow metal doors. F1280 B label (<math>1\frac{1}{2}</math> hr.) stainless steel strike available.</p> 	<p><b>1281</b> Open back strike for <math>1\frac{3}{4}</math>" doors. <math>8" \times 1\frac{1}{4}"</math> face allow use in mortise lock cutout of stock hollow metal door.</p> 
---	--	--

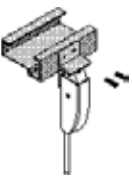
## Accessories

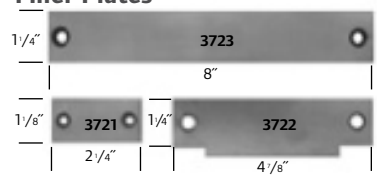
<p><b>4215</b> Angle bracket for flush transom applications. Does not require elimination of latch retention feature. Accepts 3788 strike for 25-V device.</p> 	<p><b>Surface Vertical Extension Rods</b></p> <p>Extension rods are available in 12", 24" and 36" lengths in all finishes. Both ends tapped and all-thread included as connector.</p> 	<p><b>Concealed Extension Rods</b></p> <p>Extension rods are available in 12", 24" and 36". Both ends have pressed-in, threaded inserts.</p> 
<p><b>Filler Plates</b></p>  <p><b>3721/3722/3723</b> Steel Filler Plates 3721 Cylindrical Lock Front Filler 3722 Strike Filler - set no. SC for 161 cutout 3723 Mortise Lock Front Filler 3722 Strike Filler - set no. SM for 86 cutout</p>		

# 25 SERIES TRIM DESIGNS

Functionality built into the trim, facilitating easy door preps, easy field retrofit and easy ordering.

## Lever Trims (510L)



**510L**  
**510L-NL**

**510L-DT**  
**510L-BE**

**Lever Designs**

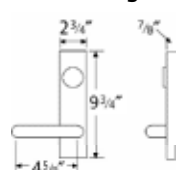

Projection: 2 1/4", Dane  
2 1/8", Sutro  
3/8", Quantum



**Dane**  
Projection: 2 1/4"



**Quantum**  
Projection: 3 1/2"



**Sutro**  
Projection: 3 13/16"

*Lever: 4 5/8" escutcheon: 2 3/4" x 9 3/4" (specify handing) brass and stainless finishes. Protected by easily replaceable shear pin.*

*Lever is reversible, supplied RHR if not specified. For keyed functions, see page 14 for cylinder requirements.*

## Vandal-Resistant Lever Trims (511L)



Provides resistance to rotation, making damage of trim due to attack from the outside less likely. Designed to operate normally after vandalism attempts without the need for maintenance personnel intervention.

- Heavy duty, vandal-resistant, ANSI A156.3 Grade 1 security trim
- Lever deflects up to 22 ft-lb for a minimum of 10,000 vandal-resistant cycles
- Vandal resistance is present in both lever rotation directions
- After lever is fully deflected, lever stops rotating and a shear pin breaks at 70 ft-lb to prevent damage to unit

- Available on 25 rim, vertical, mortise, and concealed devices
- Retrofits all existing 25 trim without additional door prep
- LK monitor switch is available
- Works with all electric lock and unlock functions
- Available in all finishes and designs including Dane, Quantum and Sutro

## Pull Trims (512TP)



**512TP**    **512NL**    **512DT**    **512TP-BE**

**Delta (717)**



**717DT**

Escutcheon: 2 1/4" x 16"  
Grip: 6 1/4" C-C  
Projection: 2 1/4"  
Brass and Stainless Steel

For keyed functions, see page 14 for cylinder requirements.

## Knob Trims (513K)



**513K-DT**    **513K**  
**513K-BE**    **513K-NL**

Round Ball Knob  
Escutcheon: 2 1/4" x 9 1/4"  
Projection: 3 3/8"  
Brass and Stainless Steel

For keyed functions, see page 14 for cylinder requirements.

## Cylinder Only (NL-OP)



Key retracts latch bolt. Cylinder sold separately (see page 14).



# 25 SERIES TRIM CHART & FINISH CHART

	FUNCTION				
	Lock/Unlock	NL	DT	BE	FSA/FSE
Lever (510)	510L	510L-NL	510L-DT	510L-BE	510L-FSA 510L-FSE
Vandal-Resistant Lever (511)	511L	-	-	-	511L-FSA 511L-FSE
Pull Trims (512)	512TP	512-NL	512DT	512TP-BE	512TP-FSA 512TP-FSE
Knob (513)	513K	513K-NL	513K-DT	513K-BE	513K-FSA 513K-FSE
Delta (717)	-	-	717DT	-	

























## 25 Series Finishes

Color	US Number	BHMA Number
Brass, Bright	US3	605
Brass, Satin	US4	606
Bronze, Satin	US10	612
Chromium, Bright	US26	625
Chromium, Satin	US26D	626
Anodized Aluminum	US28	628
Stainless Steel, Bright	US32	629
Stainless Steel, Satin	US32D	630
Anodized Duranodic	313AN	710

# 25 SERIES TYPES AND FUNCTIONS

## 25 Series

This page shows all 25 Series device and trim functions.

	Rim Device ANSI Type 1	Vertical Rod Device ANSI Type 2	Mortise Lock Device ANSI Type 3	Concealed Vertical Rod Device ANSI Type 8
Functions (ANSI)	(F)-25-R	(F)-25-V	(F)-25-M	(F)-25-C
<b>EO (01)</b> Exit only, no trim.	 <b>25-R-EO</b>	 <b>25-V-EO</b>	 <b>25-M-EO</b>	 <b>25-C-EO</b>
<b>DT (02)</b> Entrance by trim when actuating bar is locked down. <b>Note:</b> See original catalog.	 <b>25-R-DT</b>	 <b>25-V-DT</b>	 <b>25-M-DT</b>	 <b>25-C-DT</b>
<b>NL (03)</b> Entrance by trim when latchbolt is retracted by key. Key removable only when locked.	 <b>25-R-NL</b>	 <b>25-V-NL</b>	 <b>25-M-NL</b>	 <b>25-C-NL</b>
<b>TP (05)</b> Entrance by thumbpiece. Key locks or unlocks thumbpiece.	 <b>25-R-TP</b>	 <b>25-V-TP</b>	 <b>25-M-TP</b>	 <b>25-C-TP</b>
<b>L or K (08)</b> Entrance by knob or lever. Key locks or unlocks knob.	 <b>25-R-L/K</b>	 <b>25-V-L/K</b>	 <b>25-M-L/K</b>	 <b>25-C-L/K</b>
<b>L(NL) or K(NL) (09)</b> Entrance by knob or lever only when released by key. Key removable only when locked.	 <b>25-R-L/K(NL)</b>	 <b>25-V-L/K(NL)</b>	 <b>25-M-L/K(NL)</b>	 <b>25-C-L/K(NL)</b>

# 25 SERIES DOOR APPLICATION

## Label Doors

Models F-25-R, F-25-M, F-25-C and F-25-V are labeled for use as  Fire Exit Hardware. UL and Warnock Hersey listed.

## Door Thickness

All devices and components supplied for 1 $\frac{3}{4}$ " doors standard. Specify door thickness if other than 1 $\frac{3}{4}$ ".

### Door Application Chart

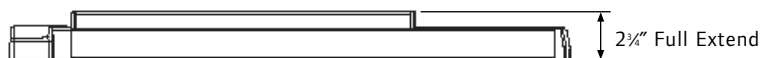
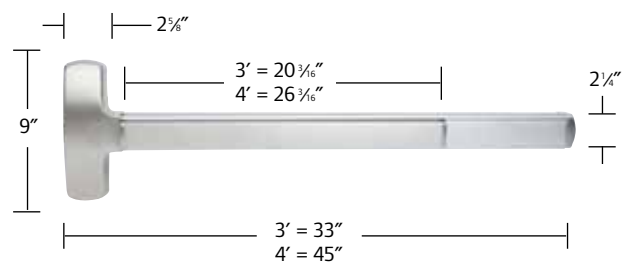
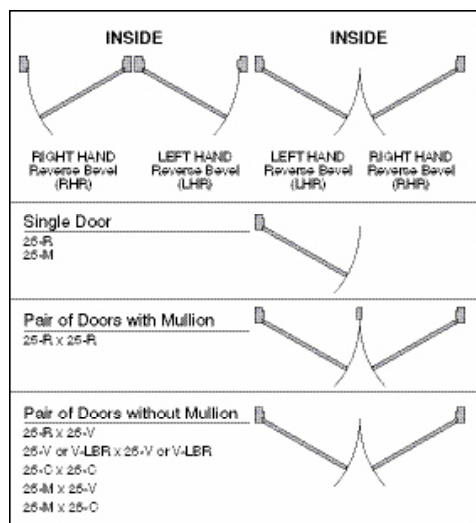

Product information and specifications contained in this catalog are subject to change without notice. Please consult the factory.

# 24-R SERIES RIM DEVICE

## Panic Exit Hardware

The Falcon 24-R Series narrow stile rim device allows for application versatility in high-traffic installations. Standard features include a single-point, rim type latch and a streamlined touch bar design. This device can also be electrified for maximum ease of use and accessibility.



299 Strike



2789 Dogging Key



Cylinder Dogging

### SINGLE DOOR APPLICATION

DEVICE	Door Size	Door Strike	Min Stile (in)	Min Door Opening Width
24-R	3'	299	3½"	2' 7½"
		264	3¾"	2' 7¼"
		1439	2¼"	2' 6½"
		1606	2¾"	2' 7½"
24-R	4'	299	3½"	3' 1¾"
		264	3¾"	2' 7¼"
		1439	2¼"	3' ½"
		1606	2¾"	3' 1¾"

### DOUBLE DOOR APPLICATION

DEVICE	Door Size	Strike x Mullion	Min Stile (in)	Min Door Opening Width
24-R	3'	299 x 2923	3½"	2' 7½"
		299 x 4023	4"	2' 7¼"
		264 x 2923	3¾"	2' 7½"
		264 x 4023	3½"	2' 7¼"
		1439 x 2923	3½"	2' 7½"
		1439 x 4023	3¾"	2' 7½"
		1606 x 2923	3½"	2' 7¼"
		1606 x 4023	3¾"	2' 7½"
		4396 x 4423	2½"	2' 6½"
24-R	4'	299 x 2923	3½"	3' 1½"
		299 x 4023	4"	3' 1¾"
		264 x 2923	3¾"	3' 1¾"
		264 x 4023	3½"	3' 1¾"
		1439 x 2923	3½"	3' 1½"
		1439 x 4023	3¾"	3' 1¾"
		1606 x 2923	3½"	3' 1¾"
		1606 x 4023	3¾"	3' 1½"
		4396 x 4423	2½"	3' ½"

## Specifications

**Hand:** Non-handed.

**Functions:** 24-EO (Exit Only) has all functions built in. Order trim with the device, or add it later. See Trim Selection Chart on page 29.

**Finishes:** US3 (605); US4 (606); US10 (612); US26 (625); US26D (626); US32 (629); US32D (630); US28 (628), 313AN. (See page 29 for finishes.)

**Strikes:** 299 strike standard. See page 27 for optional strikes.

**Latchbolt:** Stainless steel, ¾" throw.

**Deadlocking Latchbolt:** Optional. Specify "DL" prefix.

**Dogging Feature:** ½ turn hex dogging standard. No threaded parts to wear out.

**Cylinder Dogging:** Specify "CD" prefix. Uses 1½" long mortise cylinder with standard cam.

**Stock Sizes:** See chart to left.

**Doors:** 1¾" thick, wood or metal. Specify thickness if other than 1¾".

**Projection:** 2¾" maximum, 2" dogged.

**Mounting Height:** 40" from CL to finished floor.

**Electric Function:** Can be interfaced with building security systems. Latch retraction, security monitoring, electric dogging, delayed egress and exit alarm available (EL and ED fail-secure only). Subject to code requirements, state and local. (See pages 33-41 for details.)

**Fasteners:** All mounting screws are concealed.

**Sex Bolts:** Recommended when device is used with hollow core wood, composite or light gauge hollow metal doors. For EO device, specify 4 - 425 (#10-24) SNB and 2 - 325 (¼-20) SNB. For devices with trim, specify 4 - 425 (#10-24) SNB.

**ANSI:** Certified ANSI A156.3-2001 Grade 1 standards.

**Center Case & Working Parts:** Wrought steel with heavy wrought and sintered metal parts.

**Shim Kit:** For glass lite applications; ¼" thick, specify SK24-R.

# F-24-R SERIES RIM DEVICE

## Fire Exit Hardware

The Falcon F-24-R Series rim device combines sleek styling and durability with the protection of a fire-rated device. A narrow stile design allows for installation versatility. The F-24-R also features a single-point, rim type latch and can be electrified.



299F Strike



### SINGLE DOOR APPLICATION

DEVICE	Door Size	Door Strike	Min Stile (in)	Min Door Opening Width
F-24-R	3'	299-F	3½"	2' 7¾"
F-24-R	4'	299-F	3½"	3' 1¾"

### DOUBLE DOOR APPLICATION

DEVICE	Door Size	Strike x Mullion	Min Stile (in)	Min Door Opening Width
F-24-R	3'	299-F x 4023	4"	2' 7¾"
F-24-R	4'	299-F x 4023	4"	1' 1¾"

## Specifications

**Hand:** Non-handed.

**UL:** "B" label (1½ hr.); 4'0" x 8'0".

**Functions:** F-24-REO (Exit Only) has all functions built in. Order trim with the device, or add it later. (See Trim Selection Chart on page 29.)

**Finishes:** US3 (605); US4 (606); US10 (612); US26 (625); US26D (626); US32 (629); US32D (630); US28 (628), 313AN. (See page 29 for finishes.)

**Strikes:** 299 F strike standard.  
499 F with mullion.

**Latchbolt:** Stainless steel, ¾" throw.

**Deadlocking Latchbolt:** Standard.

**Stock Sizes:** See chart to left.

**Doors:** 1¾" thick, wood or metal. Specify thickness if other than 1¾". (SNB must be specified on wood or composite doors.)

**Projection:** 2¾" maximum.

**Mounting Height:** 40" from CL to finished floor.

**Electric Function:** Can be interfaced with building security systems. Latch retraction, security monitoring, electric dogging, delayed egress and exit alarm available (EL and ED fail-secure only). Subject to code requirements, state and local. (See pages 33-41 for details.)

**Fasteners:** All mounting screws are concealed. Furnished with all machine screws.

**Sex Bolts:** Required when used with wood, composite or non-reinforced hollow metal doors. For EO device, specify 4 - 425 (#10-24) SNB and 2 - 325 (1/4-20) SNB. For devices with trim, specify 4 - 425 (#10-24) SNB.

**ANSI:** Certified ANSI A156.3-2001 Grade 1 standards.

**Center Case & Working Parts:** Investment-cast ferrous alloy with heavy wrought and sintered metal parts.

**Shim Kit:** For glass lite applications; ¼ thick, specify SK24-R.

# 24-V SERIES VERTICAL ROD DEVICE

## Panic Exit Hardware

High-traffic applications demand the added strength and protection that comes with a vertical rod device. The Falcon 24-V Series delivers with a surface-applied design that includes standard top latch and deadlocking. The narrow stile and sleek touch bar design ensure an attractive installation.



## Specifications

<b>Hand:</b>	Field reversible.
<b>Functions:</b>	24-V-EO (Exit Only) has all functions built in. Order trim with the device, or add it later. See Trim Selection Chart on page 29.
<b>Finishes:</b>	US3 (605); US4 (606); US10 (612); US26 (625); US26D (626); US32 (629); US32D (630); US28 (628), 313AN. (See page 29 for finishes.)
<b>Strikes:</b>	3788 top strike is surface applied, 2130 bottom strike is mortised into floor.
<b>Angle Bracket:</b>	Use 4215 angle bracket in flush transom installations. Allows use of standard 3788 strike.
<b>Latchbolt:</b>	Top stainless steel, top latch $\frac{3}{4}$ " throw. bottom bolt $\frac{1}{2}$ " throw.
<b>Deadlocking Latchbolt:</b>	Standard with top latch.
<b>Latch Retention Hold:</b>	Standard with top latch. On top latch.
<b>Dogging Feature:</b>	$\frac{1}{2}$ turn hex dogging standard. No threaded part to wear out.
<b>Cylinder Dogging:</b>	Specify "CD" prefix. Uses $1\frac{1}{8}$ " long mortise cylinder with standard cam.
<b>Stock Sizes:</b>	See chart below.
<b>Doors:</b>	$1\frac{3}{4}$ " thick, wood or metal. Specify if other than $1\frac{3}{4}$ " thick.
<b>Projection:</b>	$2\frac{3}{4}$ " maximum, 2" dogged.
<b>Stile:</b>	$1\frac{3}{4}$ " minimum when used in pairs.
<b>Electric Function:</b>	Can be interfaced with building security systems. Latch retraction, security monitoring, electric dogging, delayed egress and exit alarm available (EL and ED fail-secure only). Subject to code requirements, state and local. (See pages 33-41 for details.)
<b>Fasteners:</b>	All mounting screws are concealed, sheet metal screws standard, machine screws available, specify AMS.
<b>Sex Bolts:</b>	Recommended when device is used with hollow core wood, composite or light gauge hollow metal doors. For EO device, specify 8 - 425 (#10-24) SNB and 2 - 325 ( $\frac{1}{4}$ -20) SNB. For devices with trim, specify 8 - 425 (#10-24) SNB.
<b>ANSI:</b>	Certified ANSI A156.3-2001 Grade 1 standards.
<b>24-V:</b>	Latch Retention (LR) top latch and bottom square bolt. 3788 strike top, 2130 flush strike bottom.
<b>24-V-LBR:</b>	Less bottom rod vertical device.
<b>Vertical Rods:</b>	Furnished to length based on a 40" horizontal CL from finished floor and a 7'0" door standard. Variations from these standards must be specified when ordering.
<b>Shim Kit:</b>	For glass lite applications; $\frac{1}{4}$ " thick, specify SK24-V.

DEVICE	Door Size	Door Strike	Min Stile (in)	Min Door Opening Width
24-V	3'	all	$2\frac{1}{8}$ "	2' $6\frac{5}{8}$ "
24-V	4'	all	$2\frac{1}{8}$ "	3' $\frac{3}{8}$ "

# F-24-V SERIES VERTICAL ROD DEVICE

## Fire Exit Hardware

When your application requires strength and durability, plus fire-rated performance, the F-24-V Series is the total package. This surface-applied vertical rod device includes a sleek touch bar design with top latch and deadlocking standard, as well as a narrow stile that fits where you need it to.



## Specifications

**Hand:** Field reversible.

**UL:** "A" Label (3 Hr) - 8' x 10'; 90 min. same egress - 8' x 10'. Wood Door: 20 min. 8' x 10'; 90 min. 8' x 9'. Consult door manufacturer for maximum rating.

**Functions:** F-24-V-EO (Exit Only) has all functions built in. Order trim with the device, or add it later. See Trim Selection Chart on page 29.

**Finishes:** US3 (605); US4 (606); US10 (612); US26 (625); US26D (626); US32 (629); US32D (630); US28 (628), 313AN. (See page 29 for finishes.)

**Strikes:** 3788 top strikes are surface applied, 2130 bottom strike is mortised into floor.

**Latchbolt:** Stainless steel, top latch  $\frac{3}{4}$ " throw. bottom bolt  $\frac{1}{2}$ " throw.

**Latch Retention Hold:** Standard with top latch.

**Deadlocking Latchbolt:** Standard with top latch.

**Stock Sizes:** See chart to left.

**Doors:**  $\frac{1}{4}$ " thick, wood or metal. Specify if other than  $\frac{1}{4}$ " thick.

**Projection:**  $\frac{2}{4}$ " maximum.

**Stile:**  $\frac{2}{6}$ " minimum when used in pairs.

**Electric Function:** Can be interfaced with building security systems. Latch retraction, security monitoring, electric dogging, delayed egress and exit alarm available (EL and ED fail-secure only). Subject to code requirements, state and local. (See pages 33-41 for details.)

**Fasteners:** All mounting screws are concealed. All machine (AMS) standard.

**Sex Bolts:** Recommended when device is used with hollow core wood, composite or light gauge hollow metal doors. For EO device, specify 8 - 425 (#10-24) SNB and 2 - 325 ( $\frac{1}{4}$ -20) SNB. For devices with trim, specify 8 - 425 (#10-24) SNB.

**ANSI:** Certified ANSI A156.3-2001 Grade 1 standards.

**F-24-V:** Latch retention (LR) top latch and bottom square bolt. 3788 strike-top, 2130 flush strike bottom.

**F-24-V-LBR:** Less bottom rod vertical device. "A" Label (3 Hr) - 8' x 8'; 90 min. same egress - 8' x 8'. Wood Door: 20 minute minimum - 8' x 8' openings. Consult door manufacturer for maximum rating.

**Vertical Rods:** Furnished to length based on a 40" horizontal CL from finished floor and a 7'0" door standard. Variations from these standards must be specified when ordering.

**Shim Kit:** For glass lite application;  $\frac{1}{4}$ " thick, specify SK24-V.

DEVICE	Door Size	Door Strike	Min Stile (in)	Min Door Opening Width
F-24-V	3'	all	$2\frac{1}{8}$ "	2' $6\frac{3}{8}$ "
F-24-V	4'	all	$2\frac{1}{8}$ "	3' $\frac{3}{8}$ "

# 24-C SERIES CONCEALED VERTICAL ROD DEVICE

## Panic Exit Hardware

Concealed vertical rods add strength to the door, while maintaining an attractive appearance. The Falcon 24-C Series concealed vertical rod device offers great value, clean styling, a versatile narrow stile design and the security benefits of two-point latching. Falcon's patented center slide mechanism allows easy rod adjustment in the field.

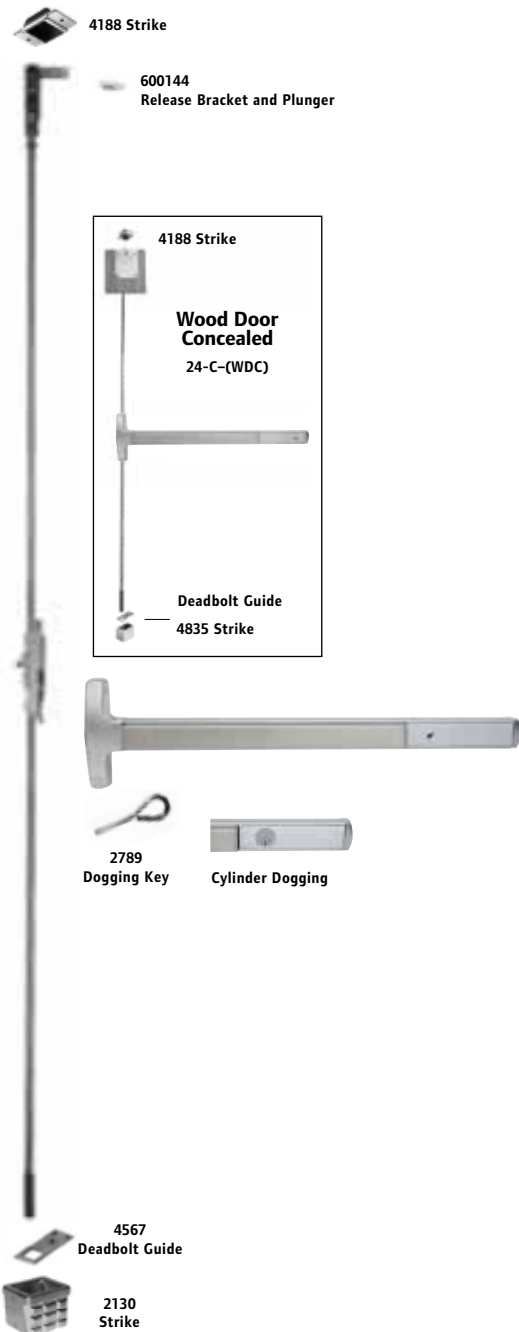

## Specifications

<b>Hand:</b>	Field reversible or specify handing.
<b>Functions:</b>	See Trim Selection Chart on page 29. Delta trim only.
<b>Finishes:</b>	US3 (605); US4 (606); US10 (612); US26 (625); US26D (626); US32 (629); US32D (630); US28 (628), 313AN. (See page 29 for finishes.)
<b>Strikes:</b>	4188 mortised top and 2130 flush strike bottom, optional bottom 2126A and 4155.
<b>Latchbolt:</b>	Top stainless steel 3/4" throw. Bottom bolt 1/2" throw.
<b>Deadlocking Latchbolt:</b>	Standard on top latch.
<b>Latch Retention Hold:</b>	Standard in top latch.
<b>Dogging Feature:</b>	1/2 turn hex dogging standard. No threaded parts to wear out.
<b>Cylinder Dogging:</b>	Specify "CD" prefix. Uses 1 1/8" long mortise cylinder dogging with standard cam.
<b>Stock Sizes:</b>	See chart below.
<b>Doors:</b>	1 1/4" thick metal or wood. Specify if other than 1 1/4" thick.
<b>Projection:</b>	2 3/4" maximum, 2" dogged.
<b>Stile:</b>	2 1/4" minimum when used in pairs. (6" minimum on wood doors.)
<b>Electric Function:</b>	Can be interfaced with building security systems. Latch retraction, security monitoring, electric dogging, delayed egress and exit alarm available (EL and ED fail-secure only). Subject to code requirements, state and local. (See pages 33-41 for details.)
<b>Fasteners:</b>	All mounting screws are concealed, sheet metal screws standard, machine screws available, specify AMS.
<b>Sex Bolts:</b>	Recommended when device is used with hollow core wood, composite or light gauge hollow metal doors. For EO device, specify 2 - 425 (#10-24) SNB and 2 - 325 (1/4-20) SNB. For devices with trim, specify 2 - 425 (#10-24) SNB.
<b>ANSI:</b>	Certified ANSI A156.3-2001 Grade 1 standards.
<b>WDC:</b>	Reinforcement plates supplied standard.
<b>24-C-LBR, 24-C-WDC-LBR:</b>	Less bottom rod concealed vertical device.
<b>Vertical Rods:</b>	Furnished to length based on 40" horizontal CL to finished floor and a 7'0" door. Variations from these standards must be specified when ordering.
<b>Patented Centerslide:</b>	For ease of adjustment.
<b>Shim Kit:</b>	Consult factory.

DEVICE	Door Size	Door Strike	Min Stile (in)	Min Door Opening Width
24-C	3'	all	2 1/4"	2' 6 1/2"
24-C	4'	all	2 1/4"	3' 1/2"



# F-24-C SERIES CONCEALED VERTICAL ROD DEVICE

## Fire Exit Hardware

The Falcon F-24-C Series device lets you combine the safety of a fire-rated device with the clean aesthetics that come with a narrow stile and concealed vertical rod installation. In-field adjustment is simple thanks to our patented center slide mechanism. Two-point latching ensures optimal security at the door.

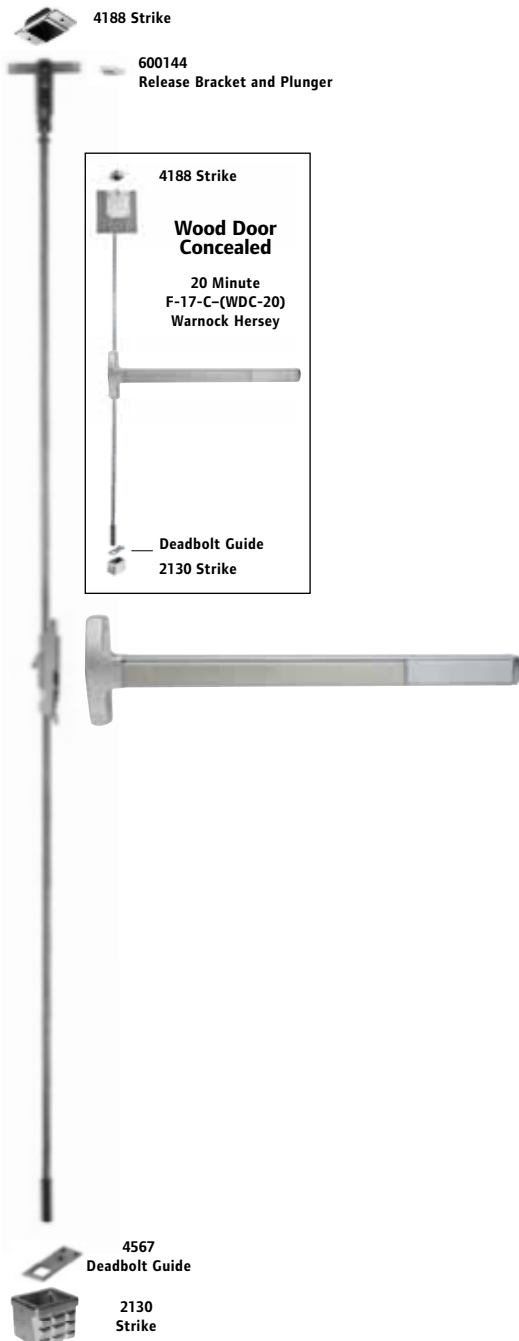

## Specifications

**Hand:** Field reversible or specify handing.

**UL:** "A" Label (3 Hr) - 8' x 10'; 90 min. same egress - 8' x 10'.  
Wood Door: 20 min. 8' x 9'; 90 min. 8' x 8'. Consult door manufacturer for maximum rating. Edge channel may be required.

**Functions:** See Trim Selection Chart on page 29. Delta trim only.

**Finishes:** US3 (605); US4 (606); US10 (612); US26 (625); US26D (626); US32 (629); US32D (630); US28 (628), 313AN. (See page 29 for finishes.)

**Strikes:** 4188 mortised top, 2130 flush strike bottom.

**Latchbolt:** Top stainless steel, 3/4" throw. Bottom bolt 1/2" throw.

**Deadlocking Latchbolt:** Standard on top latch.

**Latch Retention Hold:** Standard in top latch.

**Stock Sizes:** See chart below.

**Doors:** 1 3/4" thick metal. Specify if other than 1 3/4" thick.

**Projection:** 2 3/4" maximum.

**Stile:** 2 1/4" minimum when used in pairs. (6" minimum on wood doors.)

**Electric Function:** Can be interfaced with building security systems. Latch retraction, security monitoring, electric dogging, delayed egress and exit alarm available (EL and ED fail-secure only). Subject to code requirements, state and local. (See pages 33-41 for details.)

**Fasteners:** All mounting screws are concealed. All machine screws standard.

**Sex Bolts:** Required when used with wood, composite or non-reinforced hollow metal doors. For EO device specify 2 - 425 (#10-24) SNB and 2 - 325 (1/4-20) SNB. For devices with trim, specify 2 - 425 (#10-24) SNB.

**ANSI:** Certified ANSI A156.3-2001 Grade 1 standards.

**WDC-20:** Reinforcement plates supplied standard for 20 min. doors only.

**F-24-C-LBR:** Less bottom rod concealed vertical device. "A" Label (3 Hr) - 8' x 8'; 90 min. same egress - 8' x 8'.

**F-24-C-WDC-LBR:** Less bottom rod concealed vertical device.  
Wood Door: 20 minute minimum - 8' x 8' openings. Consult door manufacturer for maximum rating. Edge channel may be required.

**Vertical Rods:** Furnished to length based on 40" horizontal CL to finished floor and a 7'0" door. Variations from these standards must be specified when ordering.

**Patented Centerslide:** For ease of adjustment.

**Shim Kit:** Consult factory.

DEVICE	Door Size	Door Strike	Min Stile (in)	Min Door Opening Width
F-24-C	3'	all	2 1/4"	2' 6 1/2"
F-24-C	4'	all	2 1/4"	3' 1/2"

# 24 SERIES ACCESSORIES AND OPTIONS



4023 Shown

## Removable Mullion

- The 2923, 4023, KR4023 and 4423 steel mullions are for use with the 24-R devices on double door openings. Advantage: Increased security and tighter closure. Minimizes door warpage and sag. Regulates the flow of in-and-out traffic.
- Removable mullions are easily removed and reinstalled for full width access.
- Rim devices are used on both leaves, attaining a perfectly symmetrical opening.
- The mullion assembly consists of a mullion, top and bottom mounting brackets and a screw pack. Soffit adapters are available for use with either the 2923, 4423 or the 4023 mullion.
- Strikes are not furnished with the mullion (except 4423). Please see page 27 for strike information.
- Mullions may be cut on the job for doors under stock lengths.

### (F)24-R DOUBLE DOOR APPLICATION

Strike	Installed With	Min. Stile	B*
299	2923 mullion	3 1/2"	2 3/16"
299	4023 mullion	4"	2 7/16"
299-F	F-4023 mullion	4"	2 7/16"
264	2923 mullion	3 3/8"	2 1/16"
264	4023 mullion	3 5/8"	2 5/16"
1439	2923 mullion	3 7/16"	1 7/8"
1439	4023 mullion	3 11/16"	2 1/8"
1606	2923 mullion	3 5/8"	1 7/8"
1606	4023 mullion	3 11/16"	2 1/8"
4396	4423 mullion	2 1/8"	1 1/8"

\*Backset to vertical center line on the device.

## Mullion Features

- Mullion fittings – ductile iron.
- 4023 – 2" x 3" x height.
- KR4023 cylinder removable mullion – 2" x 3" x height and uses 1 1/4" mortise cylinder not furnished.
- 2923 mullion – 1 1/2" x 2 1/2" x height.
- 4423 mullion – T shape (1" on latch edge) supplied with 4396 adjustable strike.
- Prime coat only.
- 7' or 8' door opening standard, other door opening as specified.

## Cylinders

### Control Trim

- Cylinder supplied only when specified.
- Cylinders available keyed alike and keyed different.

### CYLINDER REFERENCE

Device	Trim	Standard Key Cylinder	IC Key Cylinder
24 Series Device	Cylinder Dogging	985 - 1 1/8" Mortise Cylinder	C987 - 1 3/8" Mortise Cylinder (Blocking Ring plus Security collar must equal 1/4" Thick)
24 Series Trims	L, K, TP, TL	986 - 1 1/4" Mortise Cylinder	C987 - 1 3/8" Mortise Cylinder (Blocking Ring plus Security collar must equal 1/8" Minimum Thick)
24 Series Trims	NL - Rim & Surface Vertical (718C, 718NL, 710NL)	951 - Rim Cylinder	C953 - Rim Cylinder
24 Series Trims	NL - Concealed	985 - 1 1/8" Mortise Cylinder x 1/8" Blocking Ring (with supplied cam)	C987 - 1 3/8" Mortise Cylinder (Blocking Ring plus Security collar must equal 3/8" Thick)

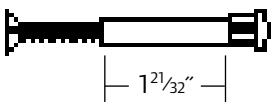

## Sex Bolts

- 325 (1/4"-20 Thread)
- 425 (#10-24 Thread)

# 24 SERIES ACCESSORIES AND STRIKES

## Strikes



### For Rim Devices

 <p><b>299</b> Panic device only.</p>	 <p><b>1439</b> Panic device only.</p>	 <p><b>1606</b> Panic device only.</p>	 <p><b>264</b> Panic device only.</p>	 <p><b>299F</b></p>
--	---	---	--	--

### For Surface and Concealed Vertical Rod Devices

<p><b>3788</b> Furnished top of (F)24-V.</p> 	<p><b>4188</b> Top strike for (F)24-C.</p> 	
<p><b>2130</b> (F)24-V and (F)24-C standard bottom strike for grouting into concrete or masonry floors.</p> 	<p><b>2126A</b> Optional bottom strike. Panic device only.</p> 	<p><b>4155</b> Optional strike. Panic device only.</p> 

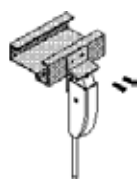
## Accessories

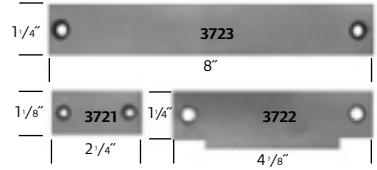
 <p><b>4215</b> Angle bracket for flush transom applications. Does not require elimination of latch retention feature. Accepts 3788 strike for 24-V device.</p>	<p><b>Surface Vertical Extension Rods</b></p> <p>Extension rods are available in 12", 24" and 36" lengths in all finishes. Both ends tapped and all-thread included as connector.</p> 	<p><b>Concealed Extension Rods</b></p> <p>Extension rods are available in 12", 24" and 36". Both ends have pressed-in, threaded inserts.</p> 
<p><b>Filler Plates</b></p>  <p><b>3721/3722/3723</b> Steel Filler Plates 3721 Cylindrical Lock Front Filler 3722 Strike Filler - set no. SC for 161 cutout 3723 Mortise Lock Front Filler 3722 Strike Filler - set no. SM for 86 cutout</p>		

# 24 SERIES TRIM DESIGNS

## Lever Trims (712L)

	<b>Lever Designs</b>				
<b>712L</b> <b>712L/NL</b>	<b>712L/DT</b> <b>712L/BE</b>	Projection: 2 1/4", Dane 2 1/8", Sutro 3 1/8", Quantum	<b>Dane</b> Projection: 2 1/4"	<b>Quantum</b> Projection: 3 1/8"	<b>Sutro</b> Projection: 2 13/16"
<i>Dane, Quantum and Sutro levers return to within 1/2" of door.</i>					

## Pull Trims (710)

<b>710TP</b>	<b>710DT</b>	<b>710NL</b>

## Knob Trim (711K)

<b>711K</b> <b>711-NL</b>	<b>711K-DT</b> <b>K-BE</b>

## Athena (715)

<b>715DT</b>
Grip overall: 9" Width: 1 1/2" Pull: 6 1/2" C x C Projection: 2 1/2"

## Delta Trims

1 1/2" mortise cylinder				1" cylinder		
<b>719TL</b>	<b>719TLP</b>	<b>718TP</b>	<b>718DT</b>	<b>718C</b>	<b>718NL</b>	<b>717DT</b>

Specify Handing  
 All Delta pulls: 6 1/2" C x C  
 All Delta pulls: 2" projection  
 TLP, NL, TP & DT: 13" overall length  
 TL: 7 1/4" L x 1 1/4" W x 1 1/2" projection

Brass, Stainless and/or Plated finishes.

For cylinder information see page 14. When locking function is not required, specify trim by (BE) blank escutcheon.

# 24 SERIES TRIM CHART & FINISH CHART

	FUNCTION					
	Lock/Unlock	NL	DT	BE	TLP	C
Lever <sup>1</sup> (712)	712L	712L-NL	712L-DT	712L-BE		
Pull Trim (710)	710TP	710NL	710DT	710TP-BE		
Knob (711)	711K	711K-NL	711K-DT	711K-BE		
Delta (717)	-	-	717DT	-		
Delta (718)	718TP	718NL	718DT	718TP-BE		718C
Delta (719)	719TL*	-			719TLP**	
Athena (715)	-	-	715DT			

\* For surface and concealed vertical rod devices only.













\*\* For concealed vertical rod device only.

<sup>1</sup> Specify hand.

## 24 Series Finishes

Color	US Number	BHMA Number
Brass, Bright	US3	605
Brass, Satin	US4	606
Bronze, Satin	US10	612
Chromium, Bright	US26	625
Chromium, Satin	US26D	626
Anodized Aluminum	US28	628
Stainless Steel, Bright	US32	629
Stainless Steel, Satin	US32D	630
Anodized Duranodic	313AN	710

# 24 SERIES TYPES AND FUNCTIONS

	Rim Devices ANSI Type 4	Vertical Rod Devices ANSI Type 5	Concealed Vertical Rod Devices ANSI Type 6
Functions (ANSI)	(F)-24-R	(F)-24-V	(F)-24-C
<b>EO (01)</b> Exit only, no trim.	 <b>24-R-EO</b>	 <b>24-V-EO</b>	 <b>24-C-EO</b>
<b>DT (02)</b> Entrance by trim when actuating bar is locked down. <b>NOTE:</b> Fire exit devices cannot be dogged down. Some codes permit electric dogging with fail secure circuitry.	 <b>24-R-DT</b>	 <b>24-V-DT</b>	 <b>24-C-DT</b>
<b>NL (03)</b> Entrance by trim when latchbolt is retracted by key. Key removable only when locked.	 <b>24-R-NL</b>	 <b>24-V-NL</b>	 <b>24-C-NL</b>
<b>TP (05)</b> Entrance by thumbpiece. Key locks or unlocks thumbpiece.	 <b>24-R-TP</b>	 <b>24-V-TP</b>	 <b>24-C-TP</b>

# 24 SERIES TYPES AND FUNCTIONS

	Rim Devices ANSI Type 4	Vertical Rod Devices ANSI Type 5	Concealed Vertical Rod Devices ANSI Type 6
Functions (ANSI)	(F)-24-R	(F)-24-V	(F)-24-C
<b>TP (NL) (06)</b> Entrance by thumbpiece only when released by key. Key removable only when locked.	 <b>24-R-TP (NL)</b>	 <b>24-V-TP (NL)</b>	 <b>24-C-TP (NL)</b>
<b>L or K (08)</b> Entrance by knob or lever. Key locks or unlocks knob.	 <b>24-R-L or K</b>	 <b>24-V-L or K</b>	 <b>24-C-L or K</b>
<b>L (NL) or K (NL) (09)</b> Entrance by knob or lever only when released by key. Key removable only when locked.	 <b>24-R-L or K(NL)</b>	 <b>24-V-L or K(NL)</b>	 <b>24-C-L or K(NL)</b>
<b>TLP or TL (11)</b> Entrance by control turnpiece. Key locks or unlocks control.		 <b>24-V-TL</b>	 <b>24-C-TLP or TL</b>
<b>TLP (NL) or TL (NL) (12)</b> Entrance by control turnpiece only when released by turning key. Key removable only when locked.		 <b>24-V-TL(NL)</b>	 <b>24-C-TLP or TL(NL)</b>

# 24 SERIES DOOR APPLICATION

## Label Doors

Falcon models F-24-R, F-24-C and F-24-V are labeled for use as  fire exit hardware. UL and Warnock Hersey listed.

## Door Thickness

All devices and components supplied for 1 $\frac{3}{4}$ " – 3'0" x 7'0" doors standard. Specify door thickness if other than 1 $\frac{3}{4}$ ".

Door Application Chart

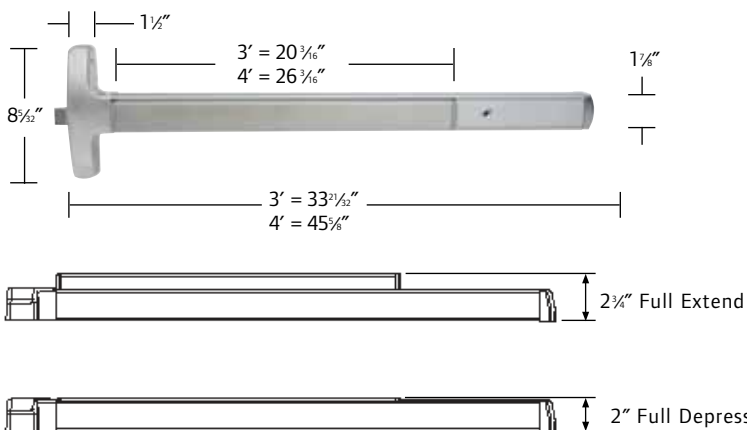
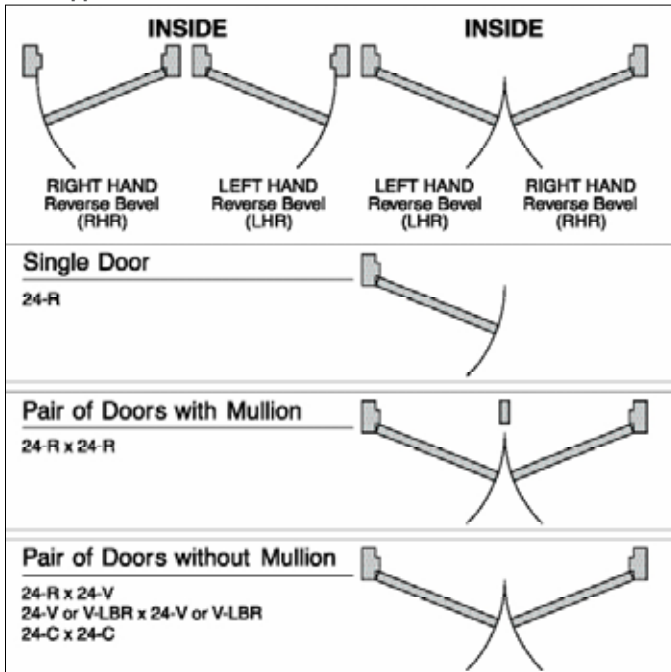

Product information and specifications contained in this catalog are subject to change without notice. Please consult the factory.



# ELECTRIC DOGGING

## Electric Dogging Feature (ED) - for all 24 Series and 25 Series devices.

Our patented Electric Dogging (ED) provides quiet, interruption-free operation. This feature can be used on any touch bar (24 or 25) series to hold latches retracted for push-pull operation and can be added to existing devices. Electric dogging is ideal for a variety of applications such as churches, auditoriums, theaters, courtrooms, and anywhere that needs dogging with an electronic control for quiet or uninterrupted operation.



ED Retrofit Kit

### Minimum door width required for standard devices

DEVICE	Door Size	Door Strike	Min Stile (in)	Min Door Opening Width
ED-25-R	3'	299	4"	2' 7 $\frac{1}{2}$ "
		264	3 $\frac{7}{8}$ "	2' 7 $\frac{1}{8}$ "
		1439	3 $\frac{1}{4}$ "	2' 6 $\frac{1}{2}$ "
		1606	3 $\frac{5}{8}$ "	2' 7"
ED-25-R	4'	299	4"	3' 1 $\frac{1}{2}$ "
		264	3 $\frac{7}{8}$ "	3' 1 $\frac{3}{8}$ "
		1439	3 $\frac{3}{4}$ "	3' 1 $\frac{1}{2}$ "
		1606	3 $\frac{5}{8}$ "	3' 1"
ED-24-R	3'	299	3 $\frac{1}{2}$ "	2' 7 $\frac{3}{8}$ "
		264	3 $\frac{5}{8}$ "	2' 7 $\frac{1}{4}$ "
		1439	2 $\frac{1}{4}$ "	2' 6 $\frac{1}{2}$ "
		1606	2 $\frac{3}{4}$ "	2' 7 $\frac{1}{8}$ "
ED-24-R	4'	299	3 $\frac{1}{2}$ "	3' 1 $\frac{3}{8}$ "
		264	3 $\frac{5}{8}$ "	3' 1 $\frac{1}{4}$ "
		1439	2 $\frac{3}{4}$ "	3' 1 $\frac{1}{2}$ "
		1606	2 $\frac{3}{4}$ "	3' 1 $\frac{1}{8}$ "
ED-25-V	3'	all	3 $\frac{1}{2}$ "	2' 6 $\frac{3}{8}$ "
ED-25-V	4'	all	3 $\frac{1}{2}$ "	3' 3 $\frac{1}{8}$ "
ED-24-V	3'	all	2 $\frac{1}{8}$ "	2' 6 $\frac{1}{8}$ "
ED-24-V	4'	all	2 $\frac{1}{8}$ "	3' 3 $\frac{3}{8}$ "
ED-25-C	3'	all	3 $\frac{1}{2}$ "	2' 6 $\frac{3}{8}$ "
ED-25-C	4'	all	3 $\frac{1}{2}$ "	3' 3 $\frac{3}{8}$ "
ED-24-C	3'	all	2 $\frac{1}{4}$ "	2' 6 $\frac{1}{2}$ "
ED-24-C	4'	all	2 $\frac{1}{4}$ "	3' 1 $\frac{1}{2}$ "
ED-25-M	3'	all	4 $\frac{1}{2}$ "	2' 7 $\frac{3}{8}$ "
ED-25-M	4'	all	4 $\frac{1}{2}$ "	3' 1 $\frac{3}{8}$ "

### Specifications

- Power transfer or electric hinge recommended, 2-wire, minimum rating 1/2 Amp.
- Recommended power supply PS861 (minimum output 24 VDC/1 Amp).

### UL Listed

- Panic and fire-rated exit devices.
- Retrofit available.

### Applications

- Quiet operation at dogged position.
- Theater, library, courtroom, auditorium, church.
- Retrofit available.
- Includes:
  - Electric Dogging unit (shown above)
  - Channel cover
  - Mounting screw
  - Slide plate post assembly
  - Installation instructions
- Cannot be used with EA, HWEA, KOR or EL.
- ED feature used with fire-rated devices must be tied into fire alarm panel.

# ELECTRIC LATCH RETRACTION

## Electric Latch Retraction (EL) - for all 24 Series and 25 Series devices.

The Electric Latch Retraction (EL) feature provides control of latch retraction by guard or security system, allowing free entrance from outside or trim side of door. The EL system can be activated to hold the latch open momentarily or for extended periods of time, and can be interfaced with automatic doors, card readers, automatic fire alarm systems, etc. The EL application requires the use of the PS873-2 power supply.



### EL Device Wire Selection Size/Type

Run Length	EL Device w/EPT or Door Loop
0-100 ft.	14 gauge standard wire
101-200 ft.	12 gauge standard wire

Run Length	EL Device w/Electric Hinge/Pivot
0-75 ft.	14 gauge standard wire
76-150 ft.	12 gauge standard wire

Wire Selection	Switch Wire Size
1200 ft. max.	18 gauge

### Specifications

Specifications	
Solenoid	
Continuous Duty	24VDC
Current Inrush (300 milliseconds)	16 amperes
Current Holding	0.3 ampere

- Solenoid rated for continuous-duty operation with PS873-2 (required power supply).
- Power transfer hinge or electric power transfer required.
- Electric Latch Retraction can be used in conjunction with FSA/FSE (Fail Safe/Fail Secure),
- Security Monitoring (DM, LM, AE, LK) features; EL feature is available on all 24 and 25 Series standard device specifications.

### Required Power Supply - PS873-2

The series PS873 power supply is designed to operate a wide variety of electrical products. EL panics require 871-2 PCB minimum. The regulated output power is 24VDC @ ampere. Standard input 120VAC @ 1.0 ampere or 240VAC @ 0.5 ampere available. This power supply is capable of handling the in rush requirements of the device.

Enclosure is 10" high x 12<sup>1</sup>/<sub>2</sub>" wide x 5" deep (254mm x 323mm x 127mm), gray with a hinged cover and constructed of heavy 19-gauge steel. Five 1/2" x 3/4" (13mm x 19mm) knockout holes are provided for conduit connection. Terminal block will accept up to 12-gauge wire.

#### Standard Options:

PS873B	with battery
PS873FA	with fire alarm

### Optional Circuit Cards

#### Factory or Field Installed Circuit Cards: 871-2, Two Zone

controller provides two inputs and two outputs. Will operate one or two EL exit devices. Use suffix "-2" for factory installed, example PS873-2.

**873-AO, Auto Operator** function coordinates the electric latch retraction of one or two locks or devices, and signals an auto-operator to open a door. Signaling the auto operator can be performed in two methods: by receiving a signal from a monitoring switch that the lock is unlatched, or upon expiration of a time delay triggered by a "AE" type input switch. Use suffix "-AO" for factory installed, example "AE" PS873-AO.

**873-4TD, Four Zone** controller with **Time Delay** provides four inputs and four outputs with the time delay. Time delay is field selectable from 0 to 75 seconds, in intervals of 5 seconds. Use suffix "-4TD" for factory installed, example PS873-4TD.

#### How to Order

To order EL feature add "EL" prefix to device designation. (Example: EL-25-R-EO)

#### Note:

Closing normally open dry contact to the PS873-2 power supply will retract latch(es). Opening normally open switch returns latch(es) to locked position.

# APPLICATION AND WIRING

## Electric Latch Retraction (EL)

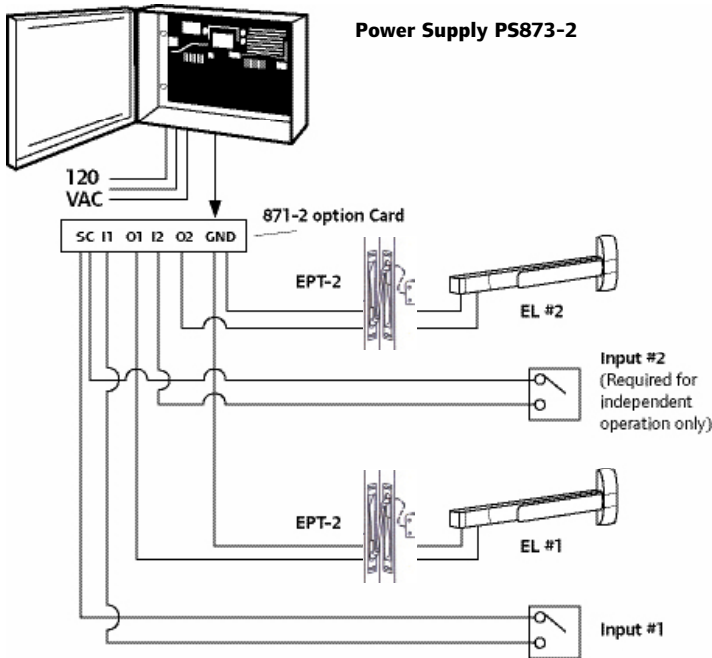

DEVICE	Door Size	Door Strike	Min Stile (in)	Min Door Opening Width
EL-25-R	3'	299	4"	2' 7½"
		264	3¾"	2' 7¾"
		1439	3¼"	2' 6½"
		1606	3⅝"	2' 7"
EL-25-R	4'	299	4"	3' 1½"
		264	3¾"	3' 1¾"
		1439	3¼"	3' ½"
		1606	3⅝"	3' 1"
EL-24-R	3'	299	3½"	2' 7¾"
		264	3¾"	2' 7¼"
		1439	2¼"	2' 6½"
		1606	2¾"	2' 7⅝"
EL-24-R	4'	299	3½"	3' 1¾"
		264	3¾"	3' 1¼"
		1439	2¼"	3' ½"
		1606	2¾"	3' 1⅝"
EL-25-V	3'	all	3½"	2' 6¾"
EL-25-V	4'	all	3½"	3' ¾"
EL-24-V	3'	all	2¼"	2' 6¾"
EL-24-V	4'	all	2¼"	3' ¾"
EL-25-C	3'	all	3½"	2' 6¾"
EL-25-C	4'	all	3½"	3' ¾"
EL-24-C	3'	all	2¼"	2' 6½"
EL-24-C	4'	all	2¼"	3' ½"
EL-25-M	3'	all	4½"	2' 7¾"
EL-25-M	4'	all	4½"	3' 1¾"

# DELAYED EGRESS SYSTEM COMPONENTS

## Delayed Egress - for all 24 Series and 25 Series

The delayed egress system provides control for limited egress and high security areas which require accident hazard or fire exit hardware.

### Delayed Egress Function

When the Delayed Egress System is armed, the mag lock(s) will remain secure against attempted override pressure and severe impacts. Ingress requires an operational trim, along with access control input (i.e. card reader, key switch, keypad). The system is required to be tied into local fire alarm system.



A complete delayed egress system requires the following components:

**DE5101** is used in delayed exit application and is ideal for controlled areas.

- Key Switch Operator
  - Arm, disarm, reset and bypass the delayed egress system by the mortise cylinder on the dialogue box. (1-1/4" mortise cylinder sold separately.)
- LED status indicator
  - Red LED indicates arm. Disarm and alarm status.
- Alarm Horn
  - Depression of the Falcon 24 or 25 AE device touchpad initiates a local alarm of 100 db when armed.

### Falcon 25 Series device with AE switch

#### Power Supply

- **PS861** - The series PS861 power supply is designed for electric locking or monitoring on single or double door applications. The output power is field selectable for either 24 VDC@1 ampere or 12 VDC@2 ampere. Standard input 120 VAC@0.6 ampere and 240 VAC@3.0 ampere available. The terminal block will accept up to 14 gauge stranded wire.

The gray enclosure is 10" x 10" x 4" (254mm x 254mm x 102mm), has a hinged cover, and is constructed of heavy 19 gauge steel. Six 1/2" (13mm) knockout holes are provided for conduit connection.

Options include keylock cover or battery backup. The pair of batteries, which are sealed lead acid battery packs, will provide back-up power for three hours at full load or seven hours at half load. Batteries will automatically recharge when failed power is restored.

Models:

- PS861 Standard supply
- PS861K Standard supply with keylock cover
- PS861B Battery backup
- PS861FA Fire Alarm
- PS861BK Battery backup and with keylock cover
- PS861BKFA Battery backup and keylock cover with FA board (24VDC only)

- **PS873** - (See page 34 for more information)

### Power Transfer Hinge or Electric Power Transfer

#### Magnetic Locks

- Schlage electronics 320+, 350+ or 390+ maintains UL Listing.

### How to Order:

All components above are sold separately. To order, specify each component to complete a delayed egress system for your application.

# APPLICATION AND WIRING

## Popular Delayed Egress Diagram

DEVICE	Door Size	Door Strike	Min Stile (in)	Min Door Opening Width
25-R	3'	299	4"	2' 7½"
		264	3⅝"	2' 7⅝"
		1439	3¼"	2' 6½"
		1606	3⅝"	2' 7"
25-R	4'	299	4"	3' 1½"
		264	3⅝"	3' 1⅝"
		1439	3¼"	3' ½"
		1606	3⅝"	3' 1"
24-R	3'	299	3½"	2' 7⅝"
		264	3⅝"	2' 7¼"
		1439	2¼"	2' 6½"
		1606	2¼"	2' 7½"
24-R	4'	299	3½"	3' 1⅝"
		264	3⅝"	3' 1¼"
		1439	2¼"	3' ½"
		1606	2¼"	3' 1⅝"
25-C	3'	all	3½"	2' 6⅝"
25-C	4'	all	3½"	3' ⅜"
24-C	3'	all	2¼"	2' 6½"
24-C	4'	all	2¼"	3' ½"
25-M	3'	all	4½"	2' 7⅝"
25-M	4'	all	4½"	3' 1⅝"

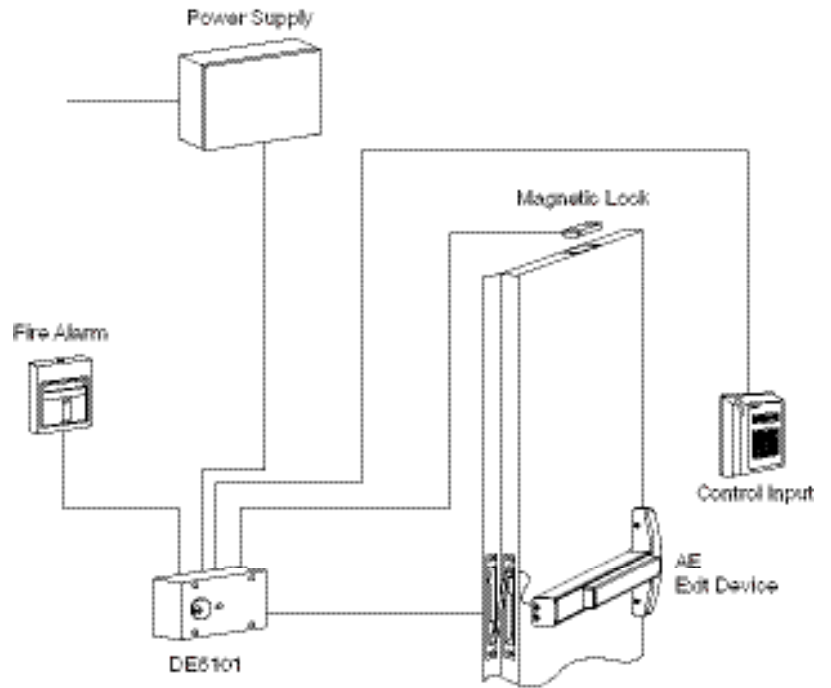

# ELECTRIC LOCK/UNLOCK TRIM

## Electric Lock/Unlock Trim (FSA/FSE) - for 25 Series.

The electric lock/unlock (FSA/FSE) feature allows the controlling of trim while still maintaining free egress at all times. The lock/unlock command can be controlled by a security system, fire alarm system, key switch, card reader, push button or touchpad.

**FSA** (Fail Safe—unlocks when power is interrupted) can be used in areas requiring doors to be unlocked due to fire, power failure or emergency situations. (Examples: stairwells, hospitals, fire exits, etc.)

**FSE** (Fail Secure—locks when power is interrupted) can be used in areas requiring doors to be locked for security reasons and only unlocked when energized by authorized personnel. (Examples: banks, inner-office, etc.) With either feature, authorized personnel can gain access utilizing key by overriding or bypassing electric locking function.



### Wire Chart

LENGTH OF WIRE RUN (FT.)	24VDC 0.4 AMPS
0-500	18 AWG
501-700	16 AWG



### Specifications

- Solenoid rated for continuous duty at 24V DC 0.4 Amps.
- UL Listed devices.
- Device channel is used as conduit on 25 Series devices.
- Power transfer (EPT-2) hinge 2-wire minimum rated 1/2 Amp.

### How to Order

To order FSA/FSE feature add FSA or FSE prefix to device designation. (Example: FSA 25-R-L)

### Note:

1. FSA/FSE can be used on all devices.
2. The FSA/FSE feature can be used in conjunction with EL (Electric Latch Retraction), EA (Exit Alarm), HWEA (Hard Wire Exit Alarm), Security Monitoring (DM, LM, AE, LK), and ED (Electric Dogging).

### Minimum Power Supply- PS861

- PS861 is a power supply unit for FSA/FSE features requiring 115V/60HZ/6 Amp service and control wiring to device.
- PS861 will operate up to 2 devices either simultaneously with one switch, or independently with two switches. 24V DC 1 Amp output from PS861.

### Note:

PS861 comes in a 10" x 10" x 4" NEMA rated box.

# EXIT ALARM

## Exit Alarm (EA) - for all 24 Series and 25 Series devices.

The Exit Alarm/Hardwire (EA/HWEA) feature provides a battery powered exit alarm to allow for a simple and effective means of monitoring the use of exits while still maintaining means of egress (for code requirements). When the touchbar is depressed the alarm will sound continuously, indicating that the exit has been engaged. The exit alarm can only be reset by way of a standard 1½ mortise cylinder with standard "A" (5/16" wide x 3/4" long) cam. The design of the unit will allow the single 9V battery to last for at least six months (on standby mode).

### Minimum door width required for standard devices

DEVICE	Door Size	Door Strike	Min Stile (in)	Min Door Opening Width
EA-25-R HWEA-25-R	3'	299	4"	2' 7½"
		264	3¾"	2' 7¾"
		1439	3¼"	2' 6½"
		1606	3¾"	2' 7"
EA-25-R HWEA-25-R	4'	299	4"	3' 1½"
		264	3¾"	3' 1¾"
		1439	3¾"	3' ½"
		1606	3¾"	3' 1"
EA-24-R HWEA-24-R	3'	299	3½"	2' 7¾"
		264	3¾"	2' 7¼"
		1439	2¼"	2' 6½"
		1606	2¾"	2' 7½"
EA-24-R HWEA-24-R	4'	299	3½"	3' 1¾"
		264	3¾"	3' 1¼"
		1439	2¾"	3' ½"
		1606	2¾"	3' 1½"
EA-25-V/ HWEA-25-V	3'	all	3½"	2' 6¾"
EA-25-V/ HWEA-25-V	4'	all	3½"	3' ¾"
EA-24-V/ HWEA-24-V	3'	all	2½"	2' 6¾"
EA-24-V/ HWEA-24-V	4'	all	2½"	3' ¾"
EA-25-C/ HWEA-25-C	3'	all	3½"	2' 6¾"
EA-25-C/ HWEA-25-C	4'	all	3½"	3' ¾"
EA-24-C/ HWEA-24-C	3'	all	2¼"	2' 6½"
EA-24-C/ HWEA-24-C	4'	all	2¼"	3' ½"
EA-25-M/ HWEA-25-M	3'	all	4½"	2' 7¾"
EA-25-M/ HWEA-25-M	4'	all	4½"	3' 1¾"

## Exit Alarm (EA/HWEA)

### Device with Exit Alarm (EA/HWEA)

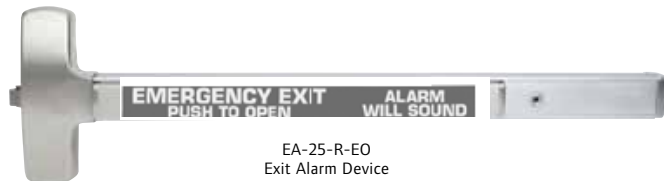

EA-25-R-EO  
Exit Alarm Device



EA/HWEA Sticker



HWEAK  
Hard Wire Exit Alarm Kit



EAK  
Exit Alarm Kit

### Specifications

- All solid state circuitry.
  - Powered by one 9V alkaline battery (supplied).
  - LED indicator showing armed status of alarm.
  - 10 second delay (during arming) permitting egress.
  - Outside key entry without activating alarm (will not work when set up as DM option to activate EA).
  - Works with rim, mortise, concealed, surface vertical rod.
  - EAK retrofit kit available for your existing devices.
  - Alarm sounds continuously at 90 db level for approximately 10 minutes prior to automatic reset. Low decibel beeping will continue at intervals until manual reset (HWEA only).
  - Low battery power indication.
  - UL listed.
- \* For applications on surface vertical rod devices, specify DM (Device Monitor).  
\*\* Not recommended as a retrofit kit for your existing surface vertical.

The EA feature can be used in conjunction with FSA/FSE (Fail Safe/Fail Secure) and Security Monitoring (DM, LM, AE) features.

### How to Order

To order EA feature add "EA" prefix to device designation. (Example: EA-25-R-EO)

To order EAK (Exit Alarm Kit) feature order "EAK" plus device length (3' or 4'), type of device (24 or 25 Series) and the finish of your existing device.

(Example: EAK-4', 24 Series, US 10 or EAK-4', 25 Series, US32D) (For retrofit application)

### Note:

Both EA (Exit Alarm) and EAK (Retrofit Kit) supplied with self-adhesive warning label.

### Hard Wire Option - HWEA (Hard Wired Exit Alarm)

The HWEA feature allows for the exit alarm to be hooked up to 24V DC service instead of the use of a 9V battery.

- Power transfer hinge-2 wire minimum rated 1/2 Amp.
- To order add "HWEA" in place of "EA" as above.  
(Example: HWEA-25-R-EO)

### Minimum Power Supply (For HWEA)

Specify PS861 for use as a 24V power supply.

### Notes:

PS861 comes in a 10" x10" x 4" NEMA rated box.

## Device Monitoring - for most 24 Series and all 25 Series devices\*.

All of the monitoring features available from Falcon provide total flexibility and will interface with any security system. All monitoring switches are dry contact type and are contained within the device, allowing for tamper-resistant operation. Security monitoring features allow monitoring of devices, latches, authorized egress and locking levers. A key override option is available. All of the security monitoring features can be used in any combination with any other Falcon feature. Consult factory for special applications.

### DM, LM, AE, LK Monitoring

- The DM (Device Monitor) feature monitors full latch projection. If the latchbolt is retracted by use of device, or someone tampers with the latchbolt, the switch is activated sending a signal to controlling areas. In devices with the deadlock feature, the deadlatch status is monitored.
- The LM (Latch Monitor) feature monitors full latchbolt retraction. When the latchbolt is fully retracted a signal is sent indicating door (or device) opened status.
- The AE (Authorized Egress) feature monitors the depression of the touch bar or crossbar. Activation of the switch indicates use of a door or that the door is in the dogged condition. This feature is especially useful when used to activate or shunt magnetic locking systems.
- The LK (Locking Monitor) feature monitors the position of the locking mechanism of the trim, indicating locked status. When used with the DM feature, a complete security indication of outside and inside lock status is achieved.
- \*LM/DM not available on F-24-R.

### How to Order

To order any individual or combination of monitor feature(s) add the respective prefix(s) to device designation.  
(Example: EL-AE-DM-25-V-L-DANE)

### Key Override Option (KOR)

The KOR feature allows authorized personnel to override monitoring features on a door by use of a keyed 1<sup>1</sup>/<sub>8</sub>" mortise cylinder with <sup>5</sup>/<sub>16</sub>" wide x <sup>3</sup>/<sub>4</sub>" long standard cam (mortise cylinder not supplied).

Activating KOR feature allows any feature to be disabled for daytime use or when desired by key holder. This is a maintained contact switch. KOR is especially useful for turning on or off magnetic locking systems and electric dogging control (at the door).

This feature is not available with EA/HWEA feature, cylinder/standard dogging.

To order KOR feature add KOR prefix to device designation.  
(Example: KOR-DM-24-R-TP)

**Note:** Use of these features may require a power transfer hinge (supplied by others) or additional wires in the power transfer hinge needed for application when combined with other electrified features.



# ELECTRICAL OPTIONS SUMMARY

✓	= works with
X	= doesn't work

## Electrical Options Matrix - 25 Series

Option	Electric Dogging	Electric Latch Retraction (EL)	Delayed Egress	Electric Lock/Unlock Trim (FSA/FSE)	Device Monitor (DM)	Latch Monitor (LM)	Authorized Egress (AE)	Lock Monitoring (LK)	Key Override (KOR)	Exit Alarm/Hard Wire (EA/HWEA)
Electric Dogging (ED)		X	✓	✓	✓	✓	✓	✓	X	X
Electric Latch Retraction (EL)	X		✓	✓	✓	✓	✓	✓	X	X
Delayed Egress	✓	✓		✓	✓	✓	✓	✓	✓	✓
Electric Lock/Unlock Trim (FSA/FSE)	✓	✓	✓		✓	✓	✓	✓	✓	✓
Device monitor (DM)	✓	✓	✓	✓		✓	✓	✓	✓	✓
Latch monitor (LM)	✓	✓	✓	✓	✓		✓	✓	✓	✓
Authorized Egress (AE)	✓	✓	✓	✓	✓	✓		✓	✓	✓
Lock Monitoring (LK)	✓	✓	✓	✓	✓	✓	✓		✓	✓
Key Override (KOR)	X	X	✓	✓	✓	✓	✓	✓		X
Exit Alarm/Hard Wire (EA/HWEA)	X	X	✓	✓	✓	✓	✓	✓	X	

## Electrical Options Matrix - 24 Series

Option	Electric Dogging	Electric Latch Retraction (EL)	Delayed Egress	Device Monitor (DM)	Latch Monitor (LM)	Authorized Egress (AE)	Key Override (KOR)	Exit Alarm/Hard Wire (EA/HWEA)
Electric Dogging (ED)		X	✓	✓	✓	✓	X	X
Electric Latch Retraction (EL)	X		✓	✓	✓	✓	X	X
Delayed Egress	✓	✓		✓	✓	✓	✓	✓
Device monitor (DM)*	✓	✓	✓		✓	✓	✓	✓
Latch monitor (LM)*	✓	✓	✓	✓		✓	✓	✓
Authorized Egress (AE)	✓	✓	✓	✓	✓		✓	✓
Key Override (KOR)	X	X	✓	✓	✓	✓		X
Exit Alarm/Hard Wire (EA/HWEA)	X	X	✓	✓	✓	✓	X	

\*Not available on F-24-R

# HOW TO ORDER 25 SERIES

## How to Order Sequence Example

**EL F 25 V L-DANE US3 3' LHR LBR SNB WD**

### Prefixes

<b>CD</b>	Cylinder Dogging
<b>AE</b>	Touchbar Request to Exit
<b>DM</b>	Latchbolt and Device Monitor Switch
<b>EA</b>	Exit Alarm
<b>HWEA</b>	Hard Wired Exit Alarm
<b>KOR</b>	Key Bypass Switch
<b>LK</b>	Locking Trim Monitor Switch
<b>LM</b>	Latchbolt Status Switch
<b>ED</b>	Electric Dogging
<b>EL</b>	Electric Latch Retraction
<b>FSA</b>	Electric Lock or Unlock Trim-Fail Safe
<b>FSE</b>	Electric Lock or Unlock Trim-Fail Secure

### Rating

<b>F</b>	Fire Exit Hardware
<b>Blank</b>	Panic Exit Hardware

### Device Series

<b>25</b>	Touch Bar Device, Wide Stile
-----------	------------------------------

### Device Type

<b>R</b>	Rim	<b>C-WDC</b>	Concealed Vertical rod Wood Door (20 or 90 Min)
<b>V</b>	Surface Vertical Rod	<b>M</b>	Mortise
<b>C</b>	Concealed Vertical rod		

### Trim Function *(see Trim pages for all functions)*

<b>EO</b>	Exit Only	<b>K</b>	Knob
<b>DT</b>	Dummy Trim	<b>L</b>	Lever (Dane Standard)
<b>NL</b>	Night Latch	<b>511-L</b>	VR Trim
<b>NL-OP</b>	Night Latch Optional Pull		
<b>TP</b>	Thumbpiece		

### Finish

<b>US3</b>	<b>US10</b>	<b>US26</b>	<b>US32</b>	<b>US28</b>
<b>US4</b>	<b>US26D</b>	<b>US32D</b>	<b>313AN</b>	

### Door Width

<b>3'</b>	Standard Default
<b>4'</b>	

### Door Thickness

<b>1¾"</b>	Standard
<b>2¼"</b>	Optional

### Handing

<b>RHR</b>	Right Hand Reverse
<b>LHR</b>	Left Hand Reverse

### Less Bottom Rod

<b>LBR</b>	Less Bottom Rod
------------	-----------------

### Accessories

<b>CYL</b>	Cylinder	<b>SNB</b>	Sex Bolts
<b>SK</b>	Shim Kit	<b>AMS</b>	All Machine Screws (for vertical and concealed only)

### Other Miscellaneous Door Information

<b>HMD</b>	Hollow Metal Door	<b>SCDC</b>	Steel Channel Door Construction	–	Door Label (20 min, 45 min, 90 min, 180 min)
<b>HMF</b>	Hollow Metal Frame	–	Specify other Door or Frame	–	Stile Width
<b>WD</b>	Wood Door	–	Material information	–	Frame Stop Height
<b>WDF</b>	Wood Frame	–	Door Height	<b>SGL</b>	Single Door
<b>ALD</b>	Aluminum Door	–	Door Thickness	<b>PR</b>	Pair of Doors Swinging Same Direction
<b>ALF</b>	Aluminum Frame	–	Door Undercut		

# HOW TO ORDER 24 SERIES

## How to Order Sequence Example

**EL F 24 V L-DANE US3 3' LHR LBR SNB WD**

### Prefixes

<b>CD</b>	Cylinder Dogging
<b>AE</b>	Touchbar Request to Exit
<b>DM</b>	Latchbolt and Device Monitor Switch
<b>EA</b>	Exit Alarm
<b>HWEA</b>	Exit Alarm-Hard Wired
<b>KOR</b>	Key Bypass Switch
<b>LM</b>	Latchbolt Status Switch
<b>ED</b>	Electric Dogging
<b>EL</b>	Electric Latch Retraction

### Rating

<b>F</b>	Fire Exit Hardware
<b>Blank</b>	Panic Exit Hardware

### Device Series

<b>24</b>	Touch Bar Device, Narrow Stile
-----------	--------------------------------

### Device Type

<b>R</b>	Rim	<b>C</b>	Concealed Vertical rod
<b>V</b>	Surface Vertical Rod	<b>C-WDC</b>	Concealed Vertical rod Wood Door (20 or 90 Min)

### Trim Function *(see Trim pages for all functions)*

<b>EO</b>	Exit Only	<b>K</b>	Knob
<b>DT</b>	Dummy Trim	<b>L</b>	Lever (Dane Standard)
<b>NL</b>	Night Latch	<b>TL</b>	Thumb Lever
<b>C</b>	Cylinder Trim Less Pull		
<b>TP</b>	Thumbpiece		

### Latch Option

<b>DL</b>	Dead Locking
-----------	--------------

### Finish

<b>US3</b>	<b>US10</b>	<b>US26</b>	<b>US32</b>	<b>313AN</b>
<b>US4</b>	<b>US26D</b>	<b>US32D</b>	<b>US28</b>	

### Door Width

<b>3'</b>	Standard Default
<b>4'</b>	

### Door Thickness

<b>1¾"</b>	Standard
<b>2¼"</b>	Optional

### Handing

<b>RHR</b>	Right Hand Reverse
<b>LHR</b>	Left Hand Reverse

### Less Bottom Rod

<b>LBR</b>	Less Bottom Rod
------------	-----------------

### Accessories

<b>CYL</b>	Cylinder	<b>SNB</b>	Sex Bolts
<b>SK</b>	Shim Kit	<b>AMS</b>	All Machine Screws (for vertical and concealed only)

### Other Miscellaneous Door Information

<b>HMD</b>	Hollow Metal Door	<b>SCDC</b>	Steel Channel Door Construction	-	Door Label (20 min, 45 min, 90 min, 180 min)
<b>HMF</b>	Hollow Metal Frame	-	Specify other Door or Frame	-	Stile Width
<b>WD</b>	Wood Door	-	Material information	-	Frame Stop Height
<b>WDF</b>	Wood Frame	-	Door Height	<b>SGL</b>	Single Door
<b>ALD</b>	Aluminum Door	-	Door Thickness	<b>PR</b>	Pair of Doors Swinging Same Direction
<b>ALF</b>	Aluminum Frame	-	Door Undercut		

Information in this catalog is subject to change without notice.