

# 2810 SERIES

**OPERATOR MOUNTS  
SINGLE DOOR, OVERHEAD CONCEALED  
\*CENTER PIVOT  
OFFSET PIVOT/BUTT HINGE**

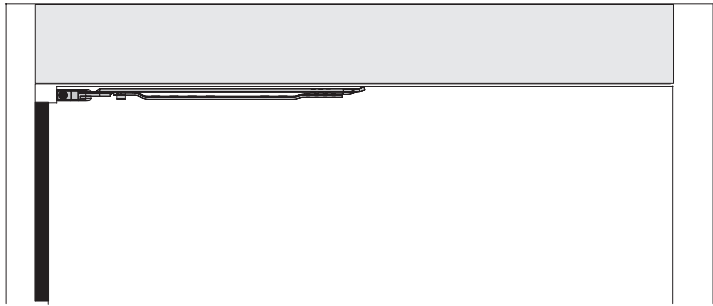

\*CENTER PIVOT arm shown

The 2810 SENIOR SWING by LCN is an ADA door operator that is a two-in-one swing door operator. SENIOR SWING operator when activated, opens doors automatically for wheelchair access, yet allows for manual operation for regular pedestrian traffic.

- Push 'N Go permits non-switch activation.
- Power Boost provides additional latching force.
- Electromechanical unit with microprocessor control.
- Meets International Building Code requirements and ANSI A156.19.
- UL approved for fire doors.

*2810 Series is fully compliant with UL 325 & UL 1998 and meets the provisions of ANSI A156.19. The 2810 Series is UL listed for fire-rated applications. The 2810 Series also meets the provisions of the Americans with Disabilities Act.*

- 2810 Series operator is shipped with motor gearbox, control box, arm, bottom pivot, header, and mounting hardware. Actuators available separately, see pages 122-137.
- Single door, overhead concealed.
- Meets ADA, requirements (power mode only).
- Handed product.
- 36" header length is standard, specify length 33" to 49" max.
- Double door header available up to 98", specify length 49" to 98" max. Consult factory regarding this option.
- Fixed (Positive) or breakaway stop available with center pivot arm.
- Adjustable hold open time of 1 to 32 seconds.

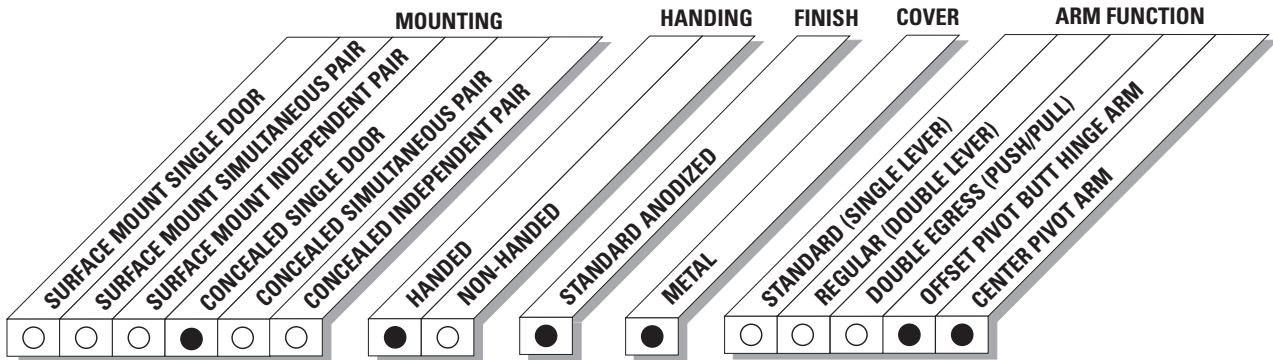

● AVAILABLE  
○ NOT AVAILABLE

# 2810 SERIES

## CONCEALED SINGLE DOOR (CENTER PIVOT, EMERGENCY BREAKAWAY, PULL) MOUNTING

Minimum header length 33" with applied stop by others and 36" with LCN fixed or breakaway stop.

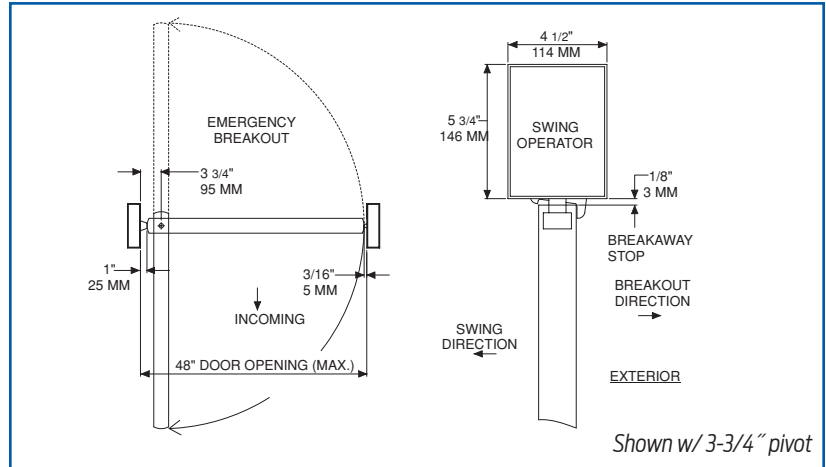

## CONCEALED SINGLE DOOR (CENTER PIVOT, FIXED STOP, PUSH) MOUNTING

Minimum header length 33" with applied stop by others and 36" with LCN fixed or breakaway stop.

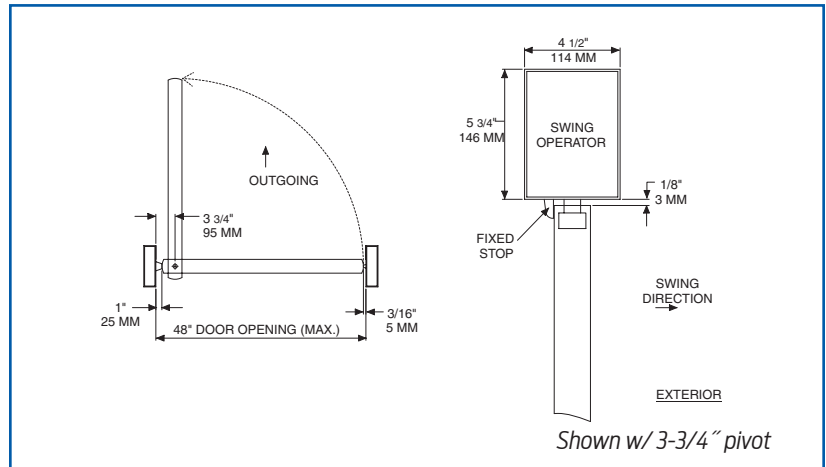

## MAXIMUM OPENING

Template allows 90 degree power opening and 90 degree manual opening.

- **Head Frame** minimum 36" (L) x 5-3/4" (H) x 4-1/2" (W) (914 mm x 146 mm x 114 mm).
- **Top Rail** minimum 2" (51 mm).
- **Opening & Closing Time** are variable by adjustments to the electronic control box. Maximum hold open time adjustable up to approximately 32 seconds.
- **Door Stop** required for each door panel.
- **System Diagram** see "AUTOMATIC OPERATORS" section pages 53 for typical system wiring and page 56 for electrical data.

Contact LCN Product Support for installation assistance.

# 2810 SERIES

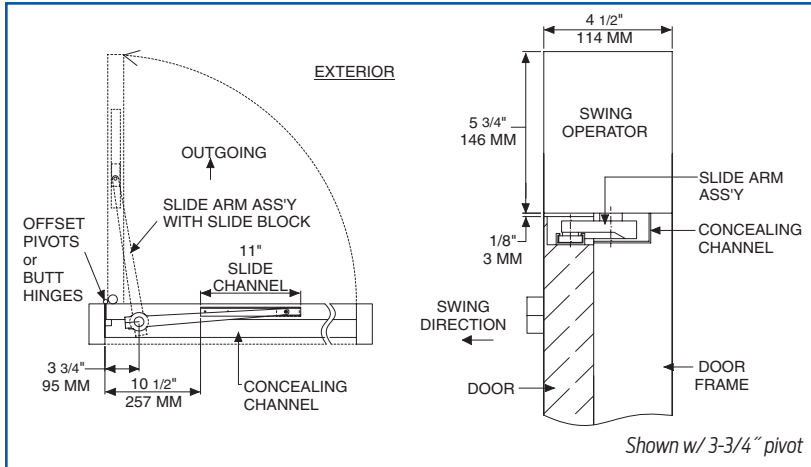

## CONCEALED SINGLE DOOR (OFFSET PIVOT OR BUTT HINGE, SLIDE ARM, PUSH) MOUNTING

Minimum header length 33".  
Installations require bottom pivot and two intermediate pivots.

- **Head Frame** minimum 33" (L) x 5-3/4" (H) x 4-1/2" (W) (838 mm x 146 mm x 114 mm).
- **Top Rail** minimum 2" (51 mm).
- **Opening & Closing Time** are variable by adjustments to the electronic control box. Maximum hold open time adjustable up to approximately 32 seconds.
- **Door Stop** required for each door panel.
- **System Diagram** see "AUTOMATIC OPERATORS" section pages 53 for typical system wiring and page 56 for electrical data.

## MAXIMUM OPENING

Template allows 90 degree power opening and 90 degree manual opening.

Contact LCN Product Support for installation assistance.

# 2810 SERIES

## MOTOR GEARBOX

### MOTOR GEARBOX – SENIOR SWING, 2810-3454

Driving mechanism for operator. Provides maximum 15 lbs opening force. Handed.

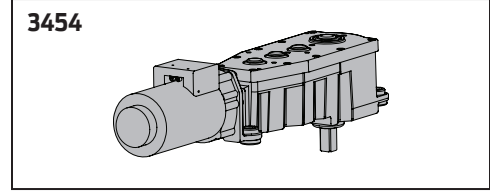

## MOUNTING BRACKET

### MOUNTING BRACKET – 3-3/4", 2810-375

Motor gearbox mounting bracket for 3-3/4" offset pivot, butt hinge or center pivot with finger guard installations. Front bracket.

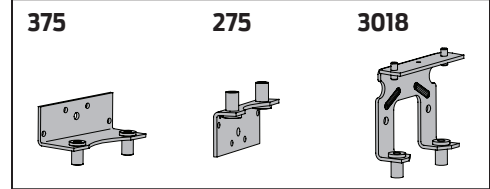

### MOUNTING BRACKET – 2-3/4", 2810-275

Motor gearbox mounting bracket for 2-3/4" center pivot installations. Front bracket.

## REAR MOUNT BRACKET, 2810-3018

Motor gearbox mounting bracket. Rear bracket.

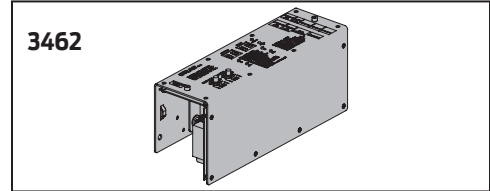

## CONTROL BOXES

### CONTROL BOX - SENIOR SWING, 2810-3462

Electronic controlling device for Senior Swing.

## HEADERS

### HEADER, 2810-3572HL

Standard, mounting header. Single door, single operator. Specify length 33" to 49" maximum.

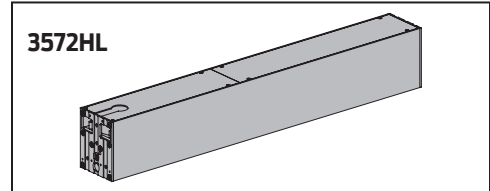

### HEADER, 2810-3572DD

Standard, mounting header. Double door, single operator. Specify length 49" to 98" maximum.

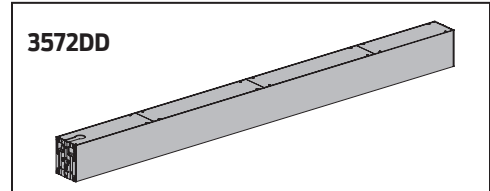

## END CAPS

### HEADER END CAPS, 2810-334

End cap with openings for wiring.

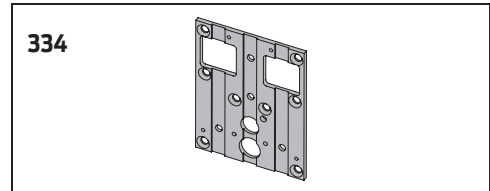

## ARMS

### CENTER PIVOT ARM, 2810-3077CP

(CENTER PIVOT INSTALLATIONS ONLY)

Used with overhead concealed operators and center pivoted doors.

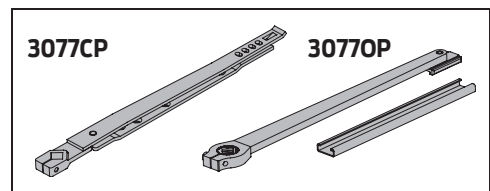

### OFFSET PIVOT ARM, 2810-3077OP

(OFFSET PIVOT OR BUTT HUNG INSTALLATIONS ONLY)

Used with overhead concealed operators.

### OFFSET PIVOT ARM ASSEMBLY COMPLETE 2810-3077 OPCM

Offset arm with track and concealing channel. (Includes 3072 concealing channel, 168 slide channel and 3077OP offset pivot arm).

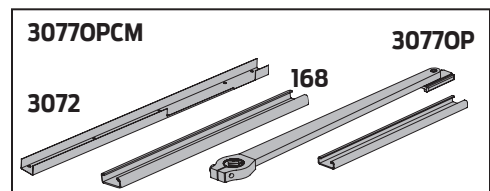

# 2810 SERIES

## CHANNELS

### CONCEALING CHANNEL, 2810-3072

Used to conceal arm in overhead concealed applications. For offset pivot installations only. If ordering separately specify length and hand.

### SLIDE CHANNEL, 2810-168

(OFFSET PIVOT or BUTT HINGE INSTALLATIONS ONLY)  
Mounts in top rail of door. Allows arm to slide.

## INSTALLATION ACCESSORIES

### DOOR STOP BREAKAWAY, 2810-384B

Allows in-swinging door to swing out in case of emergency. Disables operator in breakaway mode. For center pivoted installations only.

### DOOR STOP FIXED, 2810-384F

Prevents out-swinging door from swinging in. For center pivoted installations only.

### FILLER PLATE BLANK, 2810-12

Completes length of header box.

### SPINDLE PLATE – 2-3/4", 2810-11A

Hides bottom of motor gearbox. Completes header box. Cutout allows for motor gearbox shaft. For 2-3/4" center pivot installations.

### SPINDLE PLATE – 3-3/4", 2810-11B

Hides bottom of motor gearbox. Completes header box. Cutout allows for motor gearbox shaft. For 3-3/4" offset pivot, butt hinge or center pivot with finger guard installations.

## PIVOTS

### BOTTOM PIVOT ASSEMBLY, 2810-3107

Includes pivot body, pivot post and bottom pivot plate. For overhead concealed, center pivoted installations. Includes; 2810-107, 2810-110 and 2810-117.

### PIVOT BODY, 2810-107

Bottom pivot body for center pivoted installations.

### PIVOT POST, 2810-110

Connects pivot body to bottom pivot plate for center pivoted installations.

### BOTTOM PIVOT PLATE, 2810-117

Applied to floor for center pivoted installations.

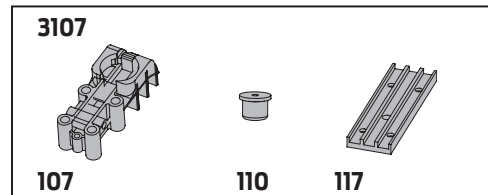
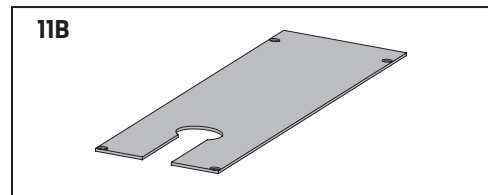
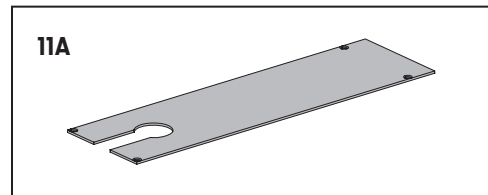
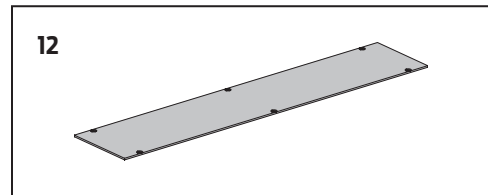
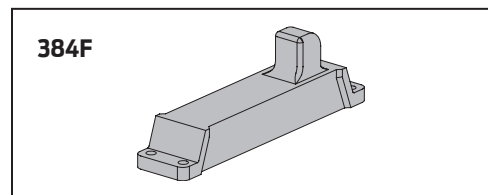
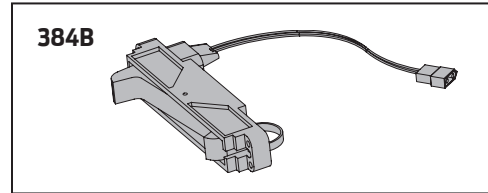
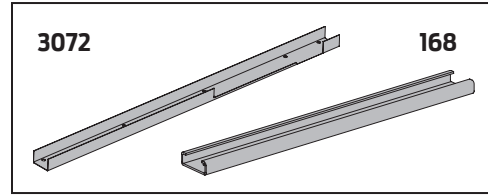

# 2810 SERIES

## TABLE OF SIZES

### DOOR WIDTH

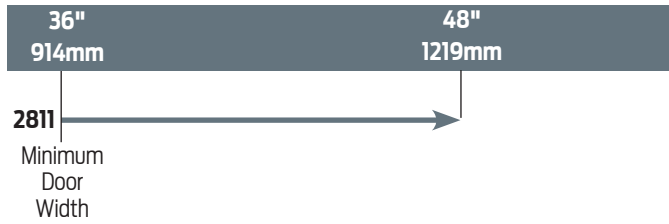

→ Indicates recommended range of door width for operator.

*NOTE: For all Senior Swing Series.  
Single Door - Width per leaf 36" minimum, 48" maximum.*

## HOW-TO-ORDER 2810 SERIES OPERATORS

### 1. SELECT INSTALLATION TYPE

2811

### 2. SPECIFY ARM

- 3-3/4" (Offset pivoted) Arm (3077OP)
- 2-3/4" (Center pivoted) Arm (3077CP)
- 3-3/4" (Center pivoted) Arm (3077CP)

### 3. SPECIFY HAND

- RH
- LH

### 4. SPECIFY HEADER/LENGTH

- HL\_ (Specify length 33" to 49" offset pivot)
- HL\_ (Specify length 36" to 49" center pivot)
- DD\_ (Specify length 49" to 98")

### 5. SPECIFY FINISH

- Standard Anodized Finish \_\_\_\_\_  
Aluminum or Dark Bronze.

#### Operator will be shipped with:

- MOTOR GEARBOX,
  - CONTROL BOX,
  - HEADER (at specified Length, 36" standard),
  - WOOD and MACHINE SCREW PACK
- Unless options listed below are selected.*

## OPERATOR OPTIONS

### STOPS\*

- Positive Mechanical Stop (POS)
  - Panic Breakaway Stop (BKY)
- \*Available with Center Pivoted installations only.*