

# 2850 SERIES

**OPERATOR MOUNTS  
SIMULTANEOUS PAIR, OVERHEAD CONCEALED  
\*CENTER PIVOT  
OFFSET PIVOT/BUTT HINGE**

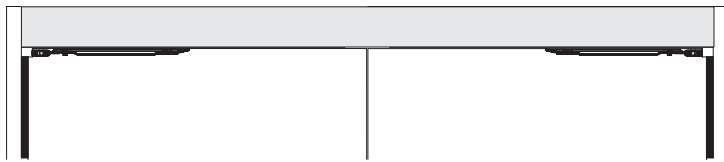

\*CENTER PIVOT arm shown

The 2850 SENIOR SWING by LCN is an ADA door operator that is a two-in-one swing door operator. SENIOR SWING operator when activated, opens doors automatically for wheelchair access, yet allows for manual operation for regular pedestrian traffic.

- Push 'N Go permits non-switch activation.
- Power Boost provides additional latching force.
- Electromechanical unit with microprocessor control.
- Digital keypad for easy setup.
- Meets International Building Code requirements and ANSI A156.19.
- UL approved for fire doors.

- 2850 Series operator is shipped with motor gearboxes, control box, arms, bottom pivot, header, and mounting hardware. Actuators available separately, see pages 122-137.
- Simultaneous pair, overhead concealed.
- Meets ADA, requirements (power mode only).
- Handed for double egress applications only.
- 72" header length is standard. Specify other length 52" to 98" max. Consult factory regarding this option.
- Optional fixed (POS) or breakaway stop (BKY) available (center pivot arm). Header lengths 70" to 98" max with either (POS) or (BKY) option.
- Adjustable hold time period of 1 to 32 seconds.

*2850 Series is fully compliant with UL 325 & UL 1998 and meets the provisions of ANSI A156.19. The 2850 Series is UL listed for fire-rated applications. The 2850 Series also meets the provisions of the Americans with Disabilities Act.*

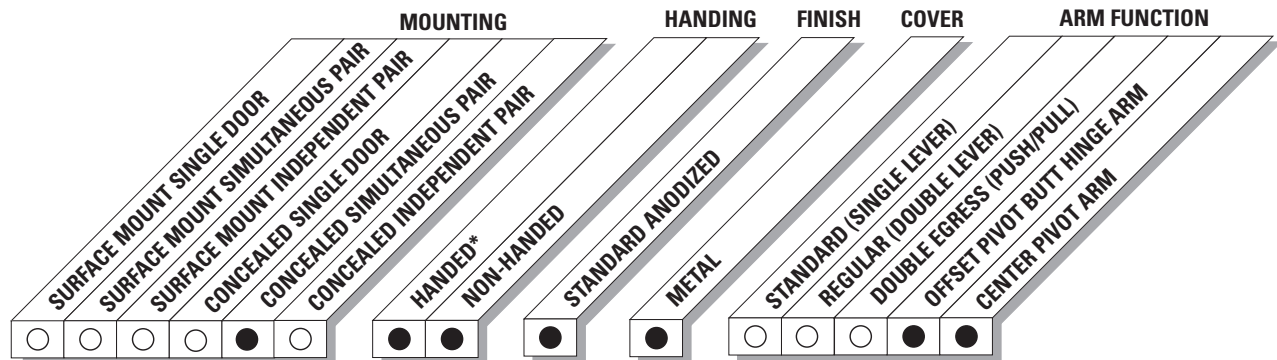

● AVAILABLE  
○ NOT AVAILABLE

\*For double egress only.

# 2850 SERIES

## CONCEALED SIMULTANEOUS PAIR (CENTER PIVOT, EMERGENCY BREAKAWAY, PULL) MOUNTING

Minimum header length 52" with applied stop by others and 70" with LCN fixed or breakaway stop.

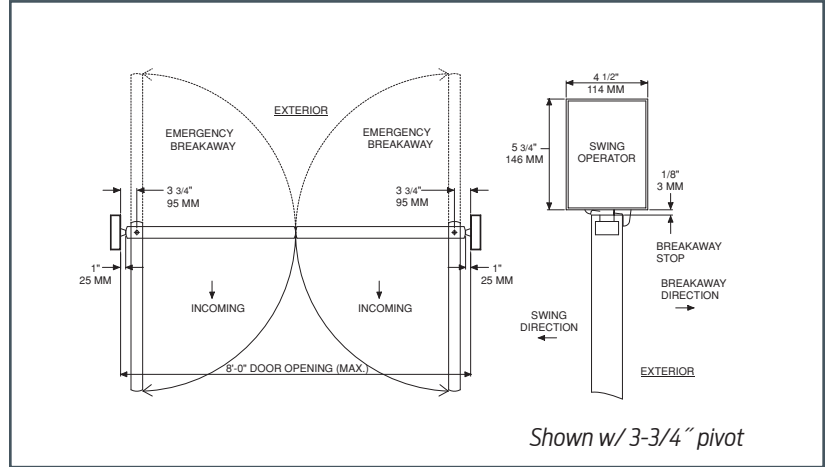

## CONCEALED SIMULTANEOUS PAIR (CENTER PIVOT, FIXED STOP, PUSH) MOUNTING

Minimum header length 52" with applied stop by others and 70" with LCN fixed or breakaway stop.

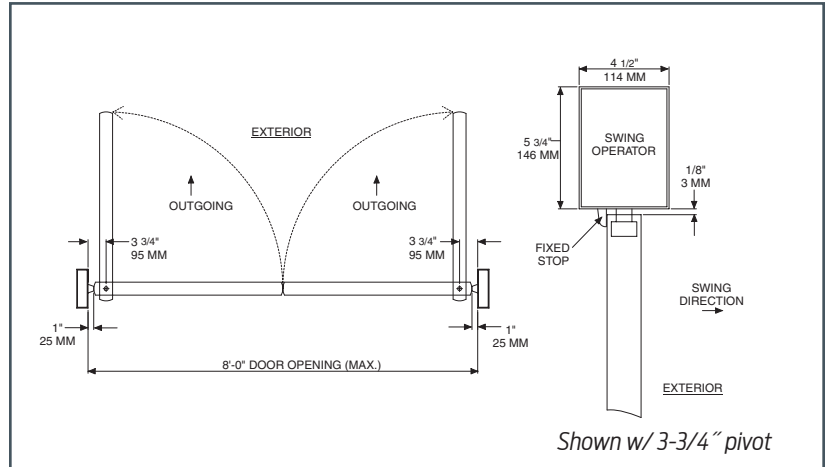

## MAXIMUM OPENING

Template allows 90 degree power opening and 90 degree manual opening.

- **Head Frame** minimum 52" (L) x 5-3/4" (H) x 4-1/2" (W) (1524 mm x 146 mm x 114 mm).
- **Top Rail** minimum 2" (51 mm).
- **Opening & Closing Time** are variable by adjustments to the electronic control box. Maximum hold open time adjustable up to approximately 32 seconds.
- **Door Stop** required for each door panel.
- **System Diagram** see "AUTOMATIC OPERATORS" section pages 53 for typical system wiring and page 56 for electrical data.

Contact LCN Product Support for installation assistance.

# 2850 SERIES

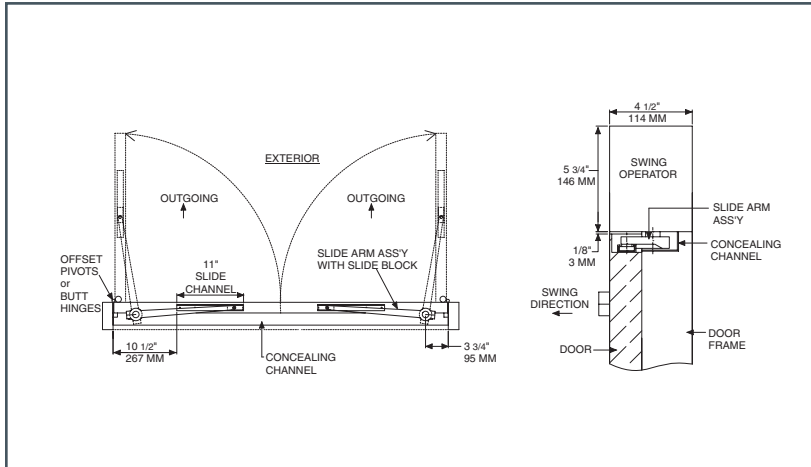

## CONCEALED SIMULTANEOUS PAIR (OFFSET PIVOT/BUTT HINGE, PUSH) MOUNTING

Offset pivot installations require a bottom pivot and two intermediate pivots.

## MAXIMUM OPENING

Template allows 90 degree power opening and 90 degree manual opening.

- **Head Frame** minimum 52" (L) x 5-3/4" (H) x 4-1/2" (W) (1524 mm x 146 mm x 114 mm).
- **Top Rail** minimum 2" (51 mm).
- **Opening & Closing Time** are variable by adjustments to the electronic control box. Maximum hold open time adjustable up to approximately 32 seconds.
- **Door Stop** required for each door panel.
- **System Diagram** see "AUTOMATIC OPERATORS" section pages 53 for typical system wiring and page 56 for electrical data.

Contact LCN Product Support for installation assistance.

# 2850 SERIES

## MOTOR GEARBOX

### MOTOR GEARBOX – SENIOR SWING, 2850-3454

Driving mechanism for operator. Provides maximum of 15 lbs opening force. Handed.

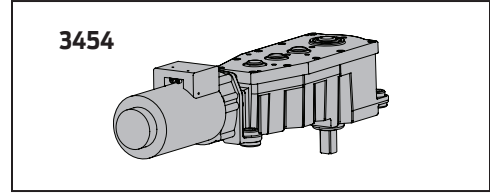

## MOUNTING BRACKET

### MOUNTING BRACKET – 3-3/4", 2850-375

Motor gearbox mounting bracket for 3-3/4" offset pivot, butt hinge or center pivot with finger guard installations. Front bracket.

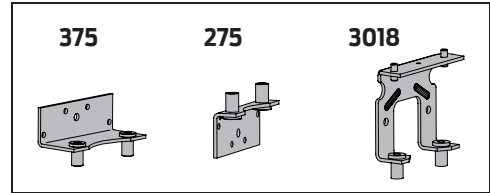

### MOUNTING BRACKET – 2-3/4", 2850-275

Motor gearbox mounting bracket for 2-3/4" center pivot installations. Front bracket.

### REAR MOUNT BRACKET, 2850-3018

Motor gearbox mounting bracket. Rear bracket.

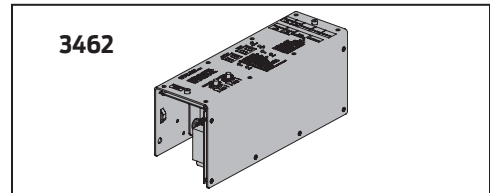

## CONTROL BOXES

### CONTROL BOX – SENIOR SWING, 2850-3462

Electronic controlling device for Senior Swing.

### COMPANION CABLE, 2850-982

Cable that allows one control box to run two motor gearboxes. For use with Senior Swing.

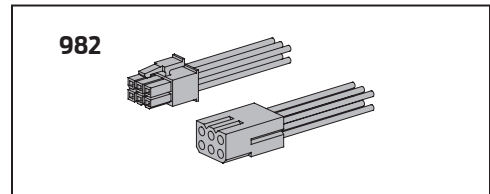

## HEADERS

### HEADER, 2850-3572HL

Standard, mounting header. Pair door, two operators. Specify length 52" to 98" maximum.

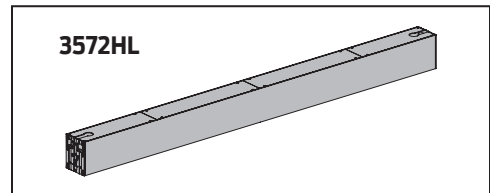

## END CAPS

### HEADER END CAPS, 2850-334

End cap with openings for wiring.

## ARMS

### CENTER PIVOT ARM, 2850-3077CP

(CENTER PIVOT INSTALLATIONS ONLY)

Used with overhead concealed operators and center pivoted doors.

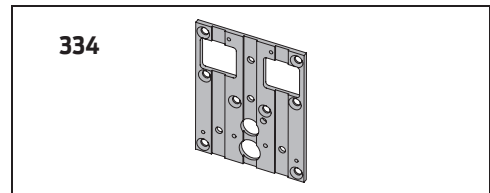

### OFFSET PIVOT ARM, 2850-3077OP

(OFFSET PIVOT OR BUTT HUNG INSTALLATIONS ONLY)

Handed arm. Used with overhead concealed operators.

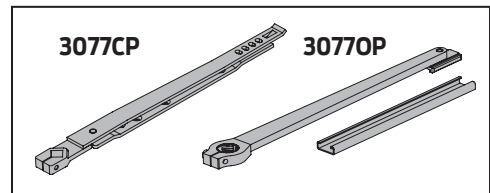

### OFFSET PIVOT ARM ASSEMBLY COMPLETE, 2850-3077OPCM

Offset arm with track and concealing channel. Includes 3072 Concealing Channel, 168 Slide Channel and 3077OP offset pivot arm.

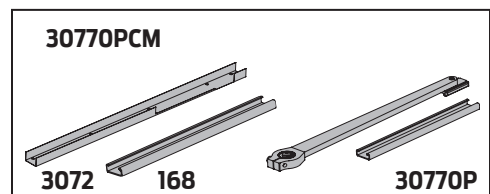

# 2850 SERIES

## CHANNELS

### CONCEALING CHANNEL, 2850-3072

Used to conceal arm in overhead concealed applications. For offset pivot and butt hinges installations only. If ordering separately specify length and hand.

### SLIDE CHANNEL, 2850-168

(OFFSET PIVOT or BUTT HINGE INSTALLATIONS ONLY)

Mounts in top rail of door. Allows arm to slide.

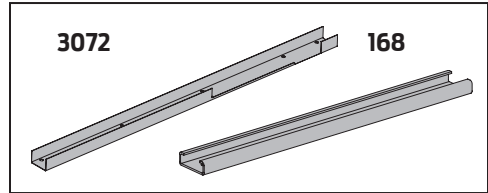

## INSTALLATION ACCESSORIES

### DOOR STOP BREAKAWAY, 2850-384B

Allows in-swinging door to swing out in case of emergency. For center pivoted installations only.

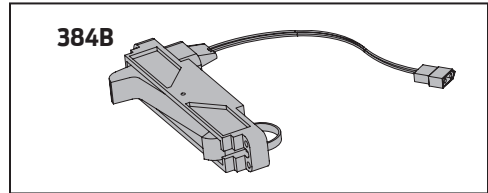

### DOOR STOP FIXED, 2850-384F

Prevents out-swinging door from swinging in. For center pivoted installations only.

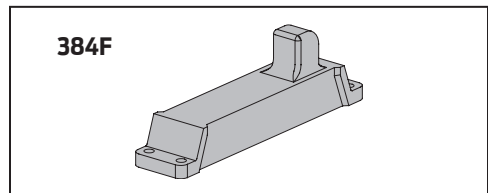

### FILLER PLATE BLANK, 2850-12

Completes length of header box.

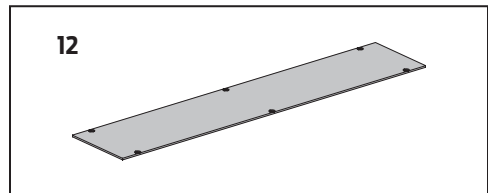

### SPINDLE PLATE – 2-3/4", 2850-11A

Hides bottom of motor gearbox. Completes header box. Cutout allows for motor gearbox shaft. For 2-3/4" center pivot hinge installations.

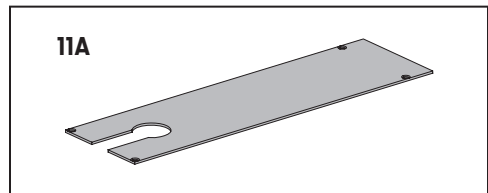

### SPINDLE PLATE – 3-3/4", 2850-11B

Hides bottom of motor gearbox. Completes header box. Cutout allows for motor gearbox shaft. For 3-3/4" offset pivot, butt hinge or center pivot with finger guard installations.

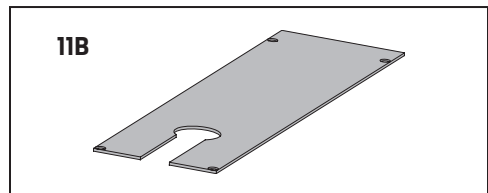

## PIVOTS

### BOTTOM PIVOT ASSEMBLY, 2850-3107

Includes pivot body, pivot post and bottom pivot plate. For overhead concealed, center pivoted installations. Includes; 2850-107, 2850-110 and 2850-117.

### PIVOT BODY, 2850-107

Bottom pivot body for center pivoted installations.

### PIVOT POST, 2850-110

Connects pivot body to bottom pivot plate for center pivoted installations.

### BOTTOM PIVOT PLATE, 2850-117

Applied to floor for center pivoted installations.

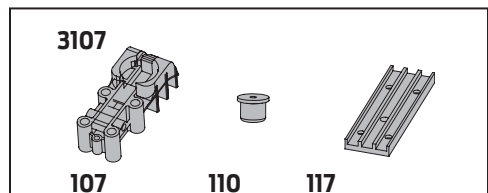

# 2850 SERIES

## TABLE OF SIZES

### COMBINED DOOR WIDTH

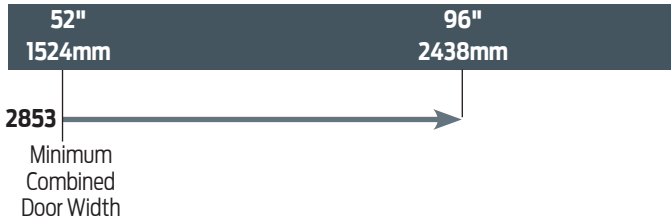

→ Indicates recommended range of door width for operator.

NOTE: For all Senior Swing Series.

Simultaneous Pair – Width per leaf 26" minimum to 48" maximum.

## HOW-TO-ORDER 2850 SERIES OPERATORS

### 1. SELECT INSTALLATION TYPE

- 2853

### 2. SPECIFY ARMS

- 3-3/4" (Offset pivoted) Arm (3077OP)  
 2-3/4" (Center pivoted) Arm (3077CP)  
 3-3/4" (Center pivoted) Arm (3077CP)

### 3. SPECIFY HAND (if double egress)

- RH  
 LH

### 4. SPECIFY HEADER/LENGTHS

- HL\_ (Specify length 52" to 98")

### 5. SPECIFY FINISH

- Standard Anodized Finish \_\_\_\_\_  
 Aluminum or Dark Bronze.

### Operator will be shipped with:

- STANDARD MOTOR GEARBOX (1 LH & 1 RH),
- STANDARD CONTROL BOX,
- COMPANION CABLE,
- HEADER (at specified length - 72" standard),
- 2-3/4" PIVOT POINT,
- WOOD and MACHINE SCREW PACK

*Unless options listed below are selected.*

## OPERATOR OPTIONS

### STOPS\*

- Pair Positive Mechanical Stop (POS)  
 Pair Panic Breakaway Stop (BKY)  
 \*Available with Center Pivoted installations only.