

QL Series Cylindrical Lever Locks



Features:

Door Preparation – Requires standard 2-1/8" (53.97mm) bore through door.

Backset – 2-3/4" (69.85mm)

Door Thickness – Fits 1-3/8" (34.93mm) to 1-3/4" (44.45mm) doors standard.

Latch – Stainless Steel 1/2" (12.7mm) throw, UL Listed, guarded latchbolt on all locking functions

Latch Front – 1-1/8" x 2-1/4" for 2-3/4" (69.85mm) backset.

Exposed Trim – QL Levers are pressure cast zinc measuring 4-3/4" (120.65mm) in length. QL Roses are wrought brass 3-11/32" (84.8mm) diameter. Total projection from face of door is 2-17/32" (64.5mm).

Finishes:

	BHMA	U.S. Equiv.	Arrow Equiv.	Finish
1	605	US3	03	Bright Brass
3	613	US10B	10B	Dark Oxide Bronze, Oil Rubbed
5	626	US26D	26D	Satin Chromium Plated

Design:

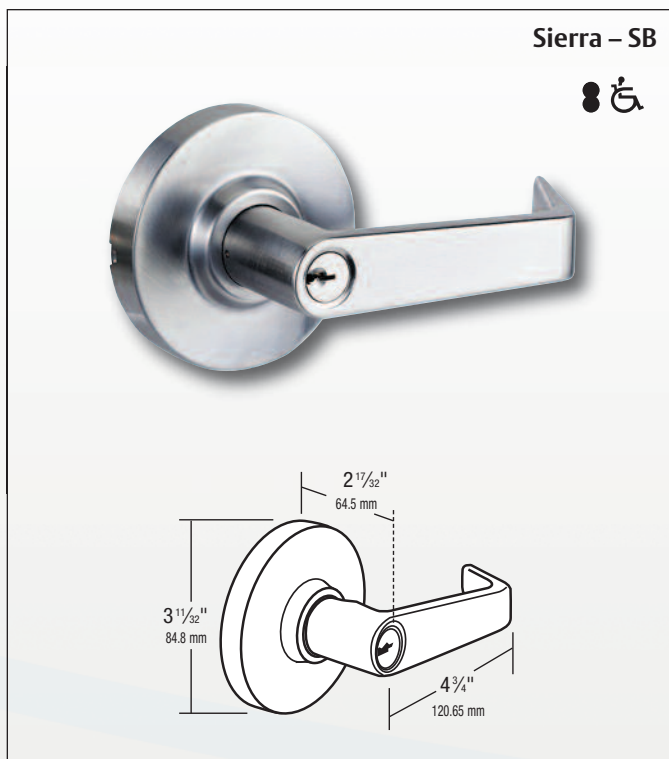

Professional Replacement Products

The QL Series is a robust Grade 1 lockset featuring a Freewheeling Lever for abuse resistance, two screw lockset install for quick installation and a 10 Year Mechanical Warranty. The perfect solution for replacing or upgrading locksets in commercial applications.

Freewheeling Lever

Warranty – Ten Year Warranty

Handing – Non-handed

Packaging – 6 per case

Strike – 4-7/8" ANSI (123.83mm)

Cylinder – Solid brass 6 pin, Arrow AR and Schlage CS Keyway, keyed different

Keys – 2 brass keys





Certification & Compliance:

- Arrow QL Series Cylindrical Lever Locks are BHMA Grade 1 Certified, ANSI/BHMA A156.2, Series 4000
- All Arrow QL Series Locks are U.L. and c.U.L. list for use on 3 hour, A label or lesser doors
- Meets American with Disabilities Act Requirements

QL Series Cylindrical Lever Locks

Professional Replacement Products

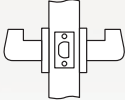
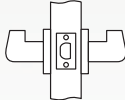
Functions:

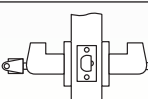
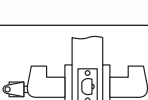
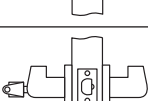
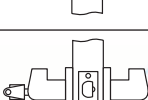
ARROW STANDARD	FUNCTION		DESCRIPTION
QL01	Passage		Latchbolt operated by lever either side.
QL72	Privacy		Latchbolt operated by lever either side except when inside turnbutton locks outside. Unlocked by rotating button or by using tool outside.
QL08	1/2 Dummy Trim		Rigid trim for one side of door only. Used as pull or to match active trim.
QL81	Entrance		Latchbolt operated by lever either side except when outside lever is locked by turn-button inside. When outside lever is locked, latchbolt operated by key outside or turning inside lever. Inside button must be manually released.
QL82	Storeroom		Outside lever always locked. Latchbolt operated by key in outside lever, or by turning inside lever.
QL87	Classroom		Latchbolt operated by lever either side except when key outside locks outside lever. Inside lever always free. Key outside locks/unlocks outside lever only.
QL97	Intruder Classroom		Deadlocking latch bolt operated by lever from either side. Key either inside or outside locks or unlocks outside lever. Inside lever always operates latchbolt.

Latches & Strikes:

Spring Latches 2-3/4" Backset

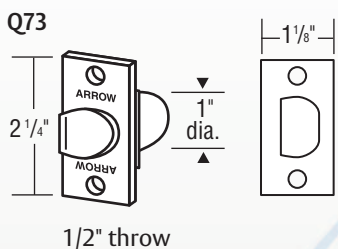

Dead Latches 2-3/4" Backset

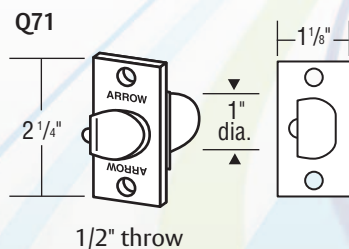

Strikes Standard with QL Series

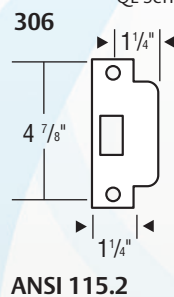

Installation:

161 prep for retrofit and secure installation.

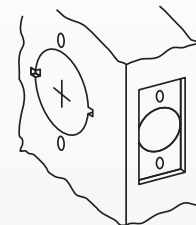

Order Example:

Example: To order a QL Series entry function lockset with a Sierra design lever, satin stainless steel finish, with an Q71 strike, and 2-3/4" deadlocking latch, keyed different:

Specify:

Standard:	QL	81	SB	26D	306	Q71	KD	XXX
	Series	Function	Design	Finish	Strike	Latch	Keying	Options (if required)

QL Series Cylindrical Lever Locks

Professional Replacement Products

Features

Certification	BHMA 156.2, Series 4000, Grade 1, UL Listed
Freewheeling Lever Action	Standard
Door Thickness	Fits 1-3/8" to 1-3/4", factory set for 1-3/4"
Strike	ANSI 1-1/4" x 4-7/8"
Latch	2-3/4" backset, 1-1/8" front
Cylinder	Standard: 6-pin, solid brass, 2 brass keys; IC prep available
Handing	Non-handed
Case Quantity	6 per case
Average Case Weight	27 lbs.
Warranty	10 years

Available Finishes	Arrow Code	BHMA Code	U.S. Code
Bright Brass	03	605	US3
Dark Oxide Satin Bronze, Oil Rubbed	10BP	614	US10BL
Satin Chromium Plated	26D	626	US26D

How to Order

Function & Trim	QL81-SB
Finish	QL81-SB-26D
Strike	QL81-SB-26D-306
Latch	QL81-SB-26D-306-Q71
Keying	QL81-SB-26D-306-Q71-KD-AR

Function	Description	03, 10B, 26D
QL01-SB	Passage	\$185.00
QL72-SB	Privacy	\$215.00
QL81-SB	Entrance/Office	\$240.00
QL82-SB	Storeroom	\$240.00
QL87-SB	Classroom	\$240.00
QL97-SB	Classroom Intruder	\$300.00

Latch Options	Spring Latch	Dead Latch	Price Add
2-3/4" backset x 1-1/8" front	R23	R21	Standard

Keying & Cylinder Options	Specify	Price Add
Keyed different, AR keyway	KD-AR	Standard
Keyed different, CS keyway	KD-CS	No add
Lock prepared to accept a 6- or 7-pin SFIC cylinder (not included)	IC	No add

Parts	Part No.	Price
Cylinder with tailpiece	700HD	\$23.34
Strike	306	\$23.98
Latch - 2-3/4" backset	Q73 ¹ or Q71 ²	\$19.12
Screw pack	QL-201	\$1.70
Alternate latch – 2-3/8" backset x 1" front (sold only as a separate part)	Q72 ¹ or Q70 ²	\$19.12
Alternate latch – 3-3/8" backset (sold only as a separate part)	Q83 ¹ or Q81 ²	\$24.38
Alternate latch – 5" backset (sold only as a separate part)	Q93 ¹ or Q91 ²	\$28.42

¹Used only with non-keyed functions

²Used only with keyed functions

ASSA ABLOY

Telephone: 800.839.3157 • Facsimile: 800.421.6615 • Web: www.arrowlock.com

 Arrow Order#
 (Acknowledgement#):

(Office use only)

 Arrow Acct#: _____
 P.O.#: _____
 Date: _____
 Customer: _____
 Address: _____

 City/State/Zip: _____

 Ship To: _____
 Address: _____

 City/State: _____

 Zip: _____

- For immediate order processing, use the Arrow Online Order Entry Site at:

← <https://extranet.assaabloydss.com/extranet/logindss.htm>

- Please provide complete order information to prevent processing delays
- For e-mail orders, please send to orders@medeco.com
- For fax orders, please send to 1-800-421-6615

Stock Number	QTY
XMLX01-SB-03-306-R23	
XMLX01-SB-10BP-306-R23	
XMLX01-SB-26D-306-R23	
XMLX08-SB-03	
XMLX08-SB-10BP	
XMLX08-SB-26D	
XMLX72-SB-03-306-R23	
XMLX72-SB-10BP-306-R23	
XMLX72-SB-26D-306-R23	
XMLX81-SB-03-306-R21-IC	
XMLX81-SB-03-306-R21-ARKD	
XMLX81-SB-03-306-R21-CSKD	
XMLX81-SB-10BP-306-R21-IC	
XMLX81SB10BP-306-R21-ARKD	
XMLX81SB10BP-306-R21-CSKD	
XMLX81-SB-26D-306-R21-IC	
XMLX81-SB26D-306-R21-ARKD	
XMLX81-SB26D-306-R21-CSKD	
XMLX82-SB-03-306-R21-IC	
XMLX82-SB-03-306-R21-ARKD	
XMLX82-SB-03-306-R21-CSKD	
XMLX82-SB-10BP-306-R21-IC	
XMLX82SB10BP-306-R21-ARKD	
XMLX82SB10BP-306-R21-CSKD	
XMLX82-SB-26D-306-R21-IC	
XMLX82-SB26D-306-R21-ARKD	
XMLX82-SB26D-306-R21-CSKD	
XMLX87-SB-03-306-R21-IC	
XMLX87-SB-03-306-R21-ARKD	
XMLX87-SB-03-306-R21-CSKD	
XMLX87-SB-10BP-306-R21-IC	
XMLX87SB10BP-306-R21-ARKD	
XMLX87SB10BP-306-R21-CSKD	
XMLX87-SB-26D-306-R21-IC	
XMLX87-SB26D-306-R21-ARKD	
XMLX87-SB26D-306-R21-CSKD	
ARX-R20.03 RLX GUARDED 2-3/8" BS	
ARX-R20.10BP RLX GUARDED 2-3/8" BS	
ARX-R20.32D RLX GUARDED 2-3/8" BS	
ARX-R21.03 RLX GUARDED 2-3/4" BS	
ARX-R21.10BP RLX GUARDED 2-3/4" BS	
ARX-R21.32D RLX GUARDED 2-3/4" BS	
ARX-R22.03 RLX UNGUARDED 2-3/8" BS	
ARX-R22.10BP RLX UNGUARDED 2-3/8" BS	
ARX-R22.32D RLX UNGUARDED 2-3/8" BS	
ARX-R23.03 RLX UNGUARDED 2-3/4" BS	
ARX-R23.10BP RLX UNGUARDED 2-3/4" BS	
ARX-R23.32D RLX UNGUARDED 2-3/4" BS	

Stock Number	QTY
XQL01-SB-10BP-306-Q73	
XQL01-SB-26D-306-Q73	
XQL01-SB-10BP-306-Q73	
XQL72-SB-26D-306-Q73	
XQL81-SB10BP-306-Q71-ARKD	
XQL81-SB10BP-306-Q71-CSKD	
XQL81-SB-10BP-306-Q71-IC	
XQL81-SB-26D-306-Q71-ARKD	
XQL81-SB-26D-306-Q71-CSKD	
XQL81-SB-26D-306-Q71-IC	
XQL82-SB10BP-306-Q71-ARKD	
XQL82-SB10BP-306-Q71-CSKD	
XQL82-SB-10BP-306-Q71-IC	
XQL82-SB-26D-306-Q71-ARKD	
XQL82-SB-26D-306-Q71-CSKD	
XQL82-SB-26D-306-Q71-IC	
XQL87-SB10BP-306-Q71-ARKD	
XQL87-SB10BP-306-Q71-CSKD	
XQL87-SB-10BP-306-Q71-IC	
XQL87-SB-26D-306-Q71-ARKD	
XQL87-SB-26D-306-Q71-CSKD	
XQL87-SB-26D-306-Q71-IC	
XQL97-SB10BP-306-Q71-ARKD	
XQL97-SB10BP-306-Q71-CSKD	
XQL97-SB-10BP-306-Q71-IC	
XQL97-SB-26D-306-Q71-ARKD	
XQL97-SB-26D-306-Q71-CSKD	
XQL97-SB-26D-306-Q71-IC	
X-Q71.10BP QL GUARDED 2-3/4" BS	
X-Q71.32D QL GUARDED 2-3/4" BS	
X-Q73.10BP QL UNGUARDED 2-3/4" BS	
X-Q73.32D QL UNGUARDED 2-3/4" BS	
X-QL-201.03 QL / ML SCREW PACK	
X-QL-201.10BP QL / ML SCREW PACK	
X-QL-201.26D QL / ML SCREW PACK	
X-RLX-44-201.FIN IC TAILPIECE PK RLX/MLX/QL/HK	

Why Use Online Order Entry?

- 24/7 Availability
- Eliminates Question Orders
- Instant Processing of Your Order
- Importable CSV File for Your System

