

BODYGUARD

OVERHEAD PRESENCE DETECTION FOR PEDESTRIAN SWINGING AND FOLDING DOORS

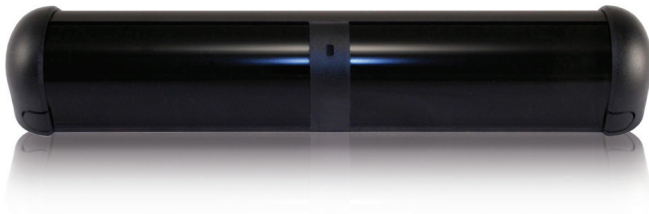

PRIMARY APPLICATIONS

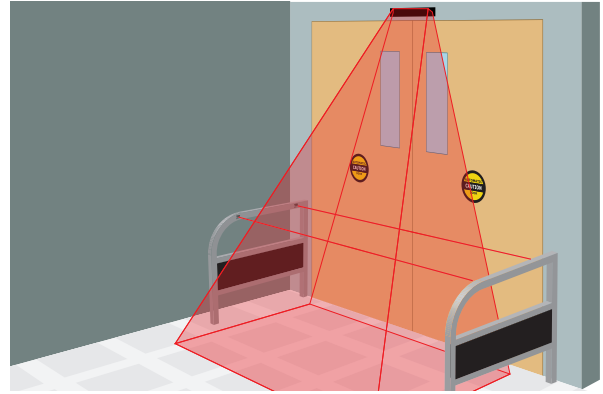

DESCRIPTION

BEA's Bodyguard is an overhead presence detection sensor that utilizes active infrared technology to create an accurate safety zone within the swing path of a door.

Additionally, the Bodyguard provides threshold protection during the "door open" state. The Bodyguard is designed to protect pedestrians and other objects from being struck by the opening of a swinging or bi-folding door.

The Bodyguard is easy to install and adjustments can be made simply, using a BEA remote control.

FEATURES & BENEFITS

- Versatile sensor can be used on single swing, simultaneous pair, dual egress and folding doors
- Adjustable tilt angle from 0° to 10° degrees
- Individual patterns for both open and closed door states
- Provides threshold protection in the door open state
- Easy installation with push button or remote control setup
- Available in nine pattern widths and six pattern depths



BEA, Inc.
RIDC Park West
100 Enterprise Drive
Pittsburgh, PA 15275-1213

Customer Service: 800.523.2462
Technical Support: 800.407.4545
www.BEAinc.com

APPLICATIONS

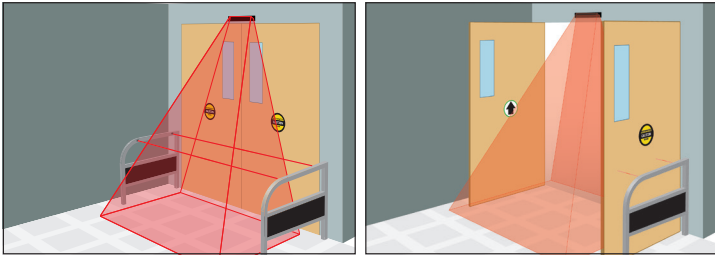

TECHNICAL SPECIFICATIONS

Technology	Active Infrared
Installation Height - Variable	Variable 108 in max (9 ft) recommended 78 in to 96 in (6.5 ft to 8 ft)
Mounting Angles Bodyguard Only With Bodymount	+5°, +10° (factory default setting: +5°) 0°, +5°, +10°
Supply Voltage	24 V AC / DC +/- 10%
Frequency	50-60 Hz
Output	Max. voltage at contacts: 60V DC / 125V AC Max. current at contacts: 1 A (Resistor) Max. power supply: 30 W (DC), 120V (AC)
Relay Hold Time	0.5 to 9 s
Operating Temperature	-22°F to +140°F
Immunity	Immune to electrical and radio frequency interference
Cable	72 in - six conductor cable
Weight	1lb. 11 oz.
Dimensions	11.8 in x 1.9 in x 1.9 in
Material	Aluminum & ABS plastic
Housing	Black anodized aluminum

DIMENSIONAL DRAWINGS

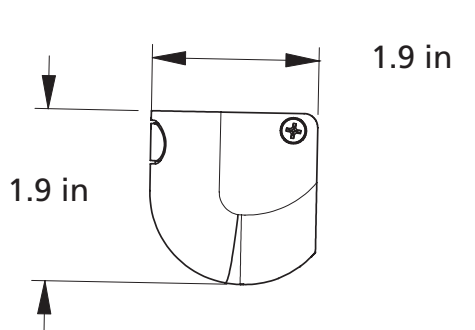
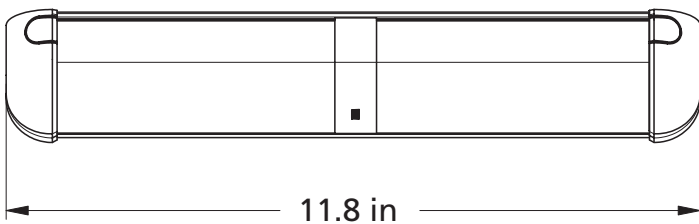

PRODUCT SERIES



10BODYGUARDIII
HEADER MOUNTED
SAFETY SENSOR

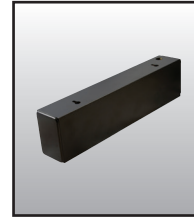

10BODYMNT
SPACER FOR
BODYGUARD



10BQD
QUICK DISCONNECT
FOR BODYGUARD
CABLE

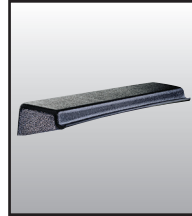

10URC
UNIVERSAL
RAIN COVER



10REMOTE
BEA UNIVERSAL
REMOTE CONTROL

www.BEAinc.com

© 2015 BEA, Inc. All rights reserved.

BODYGUARD

OVERHEAD PRESENCE DETECTION FOR PEDESTRIAN SWINGING AND FOLDING DOORS

79.0055.03

20151007

BEA, Inc.
RIDC Park West
100 Enterprise Drive
Pittsburgh, PA 15275-1213

Customer Service: 800.523.2462
Technical Support: 800.407.4545



BEA
A HALMA COMPANY