

Architectural Door Accessories

ASSA ABLOY

The global leader in
door opening solutions

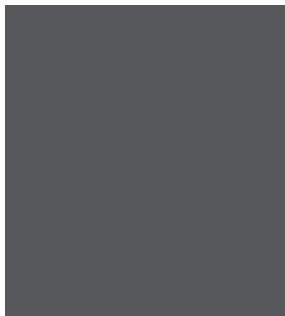
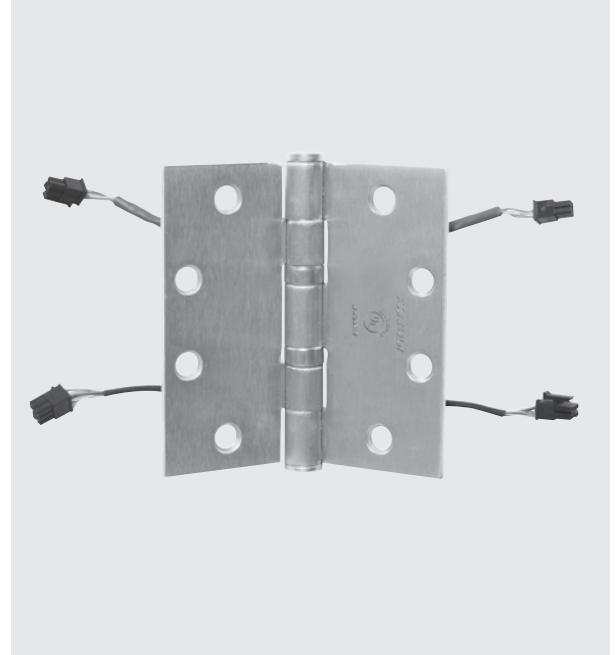

McKinney Products Net Price Book

Prices Effective September 1, 2017

Table of Contents

General Information	GEN-1–GEN-8
Finishes	GEN-3–GEN-4
Options	GEN-5–GEN-6
Index	GEN-7
Buying Program Codes	GEN-8
Full Mortise Hinges	FM-1–FM-21
MacPro® Hinges	FM-20, FM-21
Electric Hinges	EH-1–EH-13
MacPro® Electric Hinges	EH-7
Full Mortise Anchor Hinge Sets	AH-1–AH-4
Half Mortise Hinges	HM-1–HM-3
Half Surface Hinges and Back Plates	HS-1–HS-2
Full Surface Hinges	FS-1
Spring Hinges & Pivots	SH-1–SH-4
MacPro® Hinges	SH-2
Rescue Hardware	RH-1
Specialty Hinges & Residential	SP-1
StormPro® Hinges	SP-1
Designer Hardware - Deco Tips	DH-1–DH-4
Aluminum Continuous Geared Hinges	CG-1–CG-5
Steel & Stainless Pin and Barrel Continuous Hinges	CH-1–CH-9
Power Transfer Locator Templates	CH-10
3-Day QuickShip Program.....	QS-1–QS-5
Stocking Programs (Ventura, CA & Mason City, IA)	QS-5
Berlin, CT Stocking Program.....	QS-6–QS-9
Screw Packs	SPK-1–SPK-2

ASSA ABLOY

The global leader in
door opening solutions

800-346-7707 | www.mckinneyhinge.com
Check the web site for the up-to-date catalog

McKinney is a brand associated with Corbin Russwin, Inc., an ASSA ABLOY Group company. Copyright © 2012-2017, Corbin Russwin, Inc. All rights reserved. Reproduction in whole or in part without the express written permission of Corbin Russwin, Inc. is prohibited.

ACCEPTANCE

We reserve the right to decline an order, in whole or in part, when the type or quantity of goods or credit worthiness of the Purchaser is not satisfactory to us in our sole and absolute discretion.

Purchase Orders, Competitive Price Quotation ("CPQ") requests, Acknowledgements or the like issued by the Purchaser that have contrary standard terms and conditions are not binding unless such terms and conditions are approved in a separate written agreement by authorized representatives. In the event of an acceptance of Purchaser's Purchase Order the Purchaser agrees that such acceptance is solely conditioned on Purchaser's acceptance of the terms and conditions set forth in this instrument, regardless of the terms and conditions specified in Purchaser's Purchase Order. The terms and conditions in Purchaser's Purchase Order which conflict with the terms and conditions of this instrument shall be disregarded and are hereby rejected, and this instrument shall constitute the entire agreement between McKinney and the Purchaser.

In the event that McKinney does not enforce or require strict performance of any term or condition hereof, or any other document, instrument or other agreement relating to goods sold, such lack of enforcement or requirement of strict performance will not waive, affect or diminish any right to enforce or require strict performance of such term or condition in the future.

PRICES

All prices are subject to change without notice and are not guaranteed. All shipments will be made at prices in effect at the time of shipment.

Possession of this price list does not constitute an agreement to sell.

We reserve the right to correct clerical, stenographic and other obvious errors at any time.

TAXES

If under any law now or hereafter passed the seller is required to pay a tax on sales, or on an excise tax, the amount of these taxes will be added to the invoice value.

QUOTATIONS

Complete shipment of the order must be accepted by Purchaser within normal lead times.

The QUOTE number must be referenced on the order.

Any invoiced order that has the incorrect discount applied to it and did not have a QUOTE copy attached to the order or the QUOTE number written on the order will have a service fee of \$100.00 net DEDUCTED from any sales credit issued for the difference in discount.

The QUOTE is null and void if the Purchase Order does not include **ALL** product lines listed on the QUOTE or if the quantities for an item covered by the QUOTE deviate by **10%** or more.

DELIVERY

Seller shall not be liable for any delay in delivery, or failure to deliver, due to any cause beyond the Seller's control, including but not limited to fires, floods, strikes, or other labor disputes, accidents to machinery, acts of sabotage, riots, precedence or priorities granted at the request or for the benefit, directly or indirectly, of the federal or any provincial government or any subdivision or agency thereof, delay in transportation or lack of transportation facilities, restrictions imposed by the federal, provincial or other governmental legislation or rules or regulations thereof.

CREDIT

Acceptance of orders and deliveries thereof shall at all times be subject to our approval of credit.

PAYMENT TERMS

Orders based on quotations for specific jobs will be invoiced at prices in effect on the date such orders are accepted. Other orders will be invoiced at prices in effect on the date of shipment.

Errors and omissions are subject to correction on acknowledgement which in all circumstances supercedes all pricing shown herein.

Accounts are net cash 20 days or with 2% discount for cash if paid on or before the 10th of the month following the date of invoice.

A charge of \$50.00 will be made for itemization. A charge of \$25.00 will be made when changes are requested on itemized jobs already processed.

No invoice will be rendered for less than \$50.00 net.

On non-standard items a 5% over or under run constitutes a complete order.

TERMS OF 2% 10TH PROX.,
NET 20TH WILL BE ALLOWED.

It is understood that a finance charge may be imposed which is the lesser or one and one-half percent (1½) per month of the highest rate allowed by law on any amount which becomes past due and delinquent. Additionally the Customer shall be responsible for all collection costs, court costs and reasonable attorney's fees (where allowed by law) in connection with the recovery of any delinquent amount.

NOTE: PRICES PER EACH NET PRODUCT WEIGHT INFORMATION

Weights indicated throughout this price list are approximate for brass, bronze or stainless steel base material. Aluminum base materials weigh approximately 1/3 the listed weights.

WARRANTY

McKinney products are not designed for or intended for aftermarket modification. The warranty on McKinney products becomes void if the product is modified in any way, regardless of whether the modification causes or contributes to any alleged defect. Warranty voiding modifications include, but are not limited to, third-party electrification of non-electric products and/or the installation of non-approved or non-McKinney components.

If a McKinney product is modified it no longer meets industry certification and quality control standards applicable to the original product and is no longer a genuine McKinney product. A modified product may not be sold as a McKinney product and no McKinney trademarks or certification marks based on the original McKinney product, such as (but not limited to) U.L. or ANSI/BHMA marks, may appear anywhere on the modified product or on any packaging, literature or instructions sold with the modified product.

ASSA ABLOY

The global leader in
door opening solutions **GEN-1**

All original McKinney packaging and literature carries McKinney trademarks and must be destroyed if the original McKinney product is modified. Portions of the product that carry a McKinney trademark or certification mark must be discarded and/or replaced by the party making the modification. U.L. and other certification testing and markings are also the responsibility of the party making the modification. The use of McKinney trademarks on modified products constitutes trademark infringement.

SHIPMENTS

Once in the hands of the Transportation Company, the Purchaser assumes the risk of loss or damage in transit.

All goods are F.O.B. shipping point via the most economical routing, with carrier chosen by us. Full freight prepaid on shipments within Continental United States having a net value of \$1,000 or more. For shipments to Alaska and Hawaii on net orders of \$1,350.00 or more, freight will be pre-paid the most economical way. All shipments that exceed 108-inches in packaged length must be shipped LTL.

The acknowledged ship date is based upon inventory availability. We will notify you if there is a longer lead time or a back order. We will not be responsible for paying expedited shipping expenses relating to delays or buyer back charges associated with these delays.

Shipments by Air, Parcel Post, Bus or Express are F.O.B. factory with no freight allowance. There will be a \$25.00 surcharge on all bus or parcel post shipments. Handling charges on UPS, Air Freight or common carrier shipments may apply.

A charge of \$15.00 will be made for notifying customers 24 hours in advance of a truck delivery.

There will be a \$25.00 charge for furnishing proof of delivery. This charge will be cancelled if delivery was not made.

Orders marked WOG will be held for 10 days after being produced and then shipped unless specifically marked for shipment with another P.O.

If You have chosen to participate in our WOG program, a signed agreement must be on file. Orders will be held for a maximum of thirty (30) days. After such time, if pre-paid freight minimums have not been met, orders will be shipped the most economical way at the customer's cost. All orders for WOG customers will be held with other goods unless specified on each Purchase Order.

CANCELLATIONS

We are unable to accept cancellations or changes on non-stock and special ordered (s/o) items once processing begins. A charge will be assessed based on manufacturing expense incurred.

RETURNED GOODS

No credit will be issued for returned goods unless such return is authorized. If such authorization is given by us, there will be a minimum handling charge of 45% or \$50.00 which ever is greater, for stock items shipped within a 90 day period from the date of the request.

CLAIMS

Inspect before you sign. If there is a shortage or damage, **accept shipment only after freight agent makes a damage or shortage notation on your freight bill, bill of lading, or delivery receipt.** If damage or loss is evident, notify your freight agent and request inspection within 10 days of receipt of goods. Shipments are packed in approved containers. Claims must be made within 30 days of shipment and are subject to approval. Claims made after 30 days will

not be honored. Our responsibility for damage, visible or concealed, ceases upon delivery to the transportation company.

5 KNUCKLE BEARINGS

While TA/T4A part numbers are listed in this price book, TB/T4B are still available and in many cases will be the same book price as TA / T4A.

ORDERS

Orders may be emailed to orders.mckinney@assaabloy.com or faxed to 877-888-2772

ASSA ABLOY

GEN-2 The global leader in
door opening solutions

800-346-7707 | www.mckinneyhinge.com
Check the web site for the up-to-date catalog

McKinney is a brand associated with Corbin Russwin, Inc., an ASSA ABLOY Group company. Copyright © 2012-2017, Corbin Russwin, Inc. All rights reserved. Reproduction in whole or in part without the express written permission of Corbin Russwin, Inc. is prohibited.

McKinney and B.H.M.A. Finish Symbols

BHMA Code

Base Material Ferrous (Steel)	Non-Ferrous (Brass or Stainless)	McKinney FINISH
600		P
632	605	3
633	606	4
638	609	5
636	610	7
637	611	9
639	612	10
641	614	10A
640	613	10B
643	616	11
645	618	14
646	619	15
647	620	15A
649	623	20
650	624	20A
651	625	26
652	626	26D
	629	32
	630	32D

800-346-7707 | www.mckinneyhinge.com

Check the web site for the up-to-date catalog

McKinney is a brand associated with Corbin Russwin, Inc., an ASSA ABLOY Group company. Copyright © 2012-2017, Corbin Russwin, Inc. All rights reserved. Reproduction in whole or in part without the express written permission of Corbin Russwin, Inc. is prohibited.

ASSA ABLOY

The global leader in
door opening solutions

GEN-3

McKinney and Government Finish Symbols

U.S. Finish	Description	McKinney	Price
U.S.P.	Prime Powder Coat for Painting	P	Listed
U.S. 3	Bright Brass	3	Listed
U.S. 4	Dull Brass	4	Listed
U.S. 5	Dull Brass, Oxidized	5*	30% over 10B
U.S. 7	Brass, Nickel Oxidized, Bright Relieved	7*	30% over 10B
U.S. 9	Bright Bronze	9	30% over 10B
U.S. 10	Dull Bronze	10	Listed
U.S. 10A	Antique Bronze, Oiled and Lacquered	10A	Listed
U.S. 10B	Antique Bronze, Oiled	10B	Listed
U.S. 11	Dull Bronze, Oxidized	11*	30% over 10B
U.S. 14	Bright Nickel Plated	14	Same as 26
U.S. 15	Dull Nickel Plated	15	Same as 26D
U.S. 15A	Nickel Oxidized Relieved	15A*	P.O.A.
U.S. 20	Statuary Bronze, Light	20*	30% over 10B
U.S. 20A	Statuary Bronze, Dark	20A*	30% over 10B
U.S. 26	Bright Chromium	26	Listed
U.S. 26D	Dull Chromium	26D	Listed
U.S. 32	Polished Stainless Steel	32	Listed
U.S. 32D	Dull Stainless Steel	32D	Listed

* Check with the factory for availability and pricing on these finishes

McKinney Powder Coat Finishes – Not available on MacPro® or Double Acting Spring Hinges

MicroShield® Agion Antimicrobial	32DBIO	Add \$12.35 to price of 32D
Aluminum	AP	Listed
Bright Brass w/ Clear Powder Coat	3-C	30% over 10B
Dull Brass w/ Clear Powder Coat	4-C	30% over 10B
Dark Bronze Powder Coat	D-3	Same as AP
Black Powder Coat	D-4	Same as AP
Dark Oxidized Satin Bronze	10-BE	15% Less than 10B
Black Suede Powder Coat	BSP	30% over D-4

CPC or 10B over Stainless add 10% to 32D price. Every effort is made to furnish finishes which do comply with the Standard, however we cannot guarantee that our finish will match other manufacturers finish. Where a special finish or a matched finish is required, a sample must be submitted with the order.

* P.O.A. – Price on Application – Consult the factory for pricing and availability on these custom finishes.

722 or EB 30% over 10B for clear coats

ASSA ABLOY

GEN-4 The global leader in
door opening solutions

800-346-7707 | www.mckinneyhinge.com
Check the web site for the up-to-date catalog

McKinney is a brand associated with Corbin Russwin, Inc., an ASSA ABLOY Group company. Copyright © 2012-2017, Corbin Russwin, Inc. All rights reserved. Reproduction in whole or in part without the express written permission of Corbin Russwin, Inc. is prohibited.

Options/Additions Where Not Listed

No Logo	
Hinges supplied less ASSA ABLOY logo (not available on LISTED Hinges) - New lead times will apply and factory may need to adjust lead times after lead times of order is originally acknowledged.	Add 30% to price
Blank Hinges (No Screw Holes)	
Blank hinges regularly furnished without swaging (flat back) unless otherwise specified.	Add 30% to price
Bulk Package, Suffix BP	
Consult factory for availability	No additional charge
Special Swaging	
Special Swaging	Add 30% to price

Add \$17.35 to electrical option add for all Swing Clear Hinges

CC Option- Concealed Circuit		
Brass, Steel or Stainless Steel Base	Add	
4 wires - suffix CC4	\$236.30	
6 wires - suffix CC6	\$249.25	
8 wires - suffix CC8	\$274.25	
10 wires - suffix CC10	\$311.05	
12 wires - suffix CC12	\$348.10	
Extra Long Leads (over 12") for CC4	\$4.95 per foot	
Extra Long Leads (over 12") for CC6	\$7.15 per foot	
Extra Long Leads (over 12") for CC8	\$9.30 per foot	
Extra Long Leads (over 12") for CC10	\$12.00 per foot	
Extra Long Leads (over 12") for CC12	\$14.25 per foot	
CC Option- Concealed Circuit with 2 18-Gauge Wires		
Brass, Steel or Stainless Steel Base	Add	4' Lead Add
2 wires - suffix CC2-18	\$236.30	\$20.25
4 wires - suffix CC4-18	\$236.30	\$22.30
6 wires - suffix CC6-18	\$274.25	\$24.95
8 wires - suffix CC8-18	\$299.20	\$26.50
10 wires - suffix CC10-18	\$311.05	\$28.70
* Hinges are provided with two 18-gauge wires, additional wires will remain standard 28-gauge		
MG 16 Mortar Guard (Part #63333)	\$20.35 each	

QC Option- Electrolynx® Quick Connect Concealed Circuit	
Brass, Steel or Stainless Steel Base	Add
2 wires - suffix Qc2	\$224.30
4 wires - suffix QC4	\$261.80
6 wires - suffix QC6	\$274.30
8 wires - suffix QC8	\$299.20
10 wires - suffix QC10	\$336.60
12 wires - suffix QC12	\$373.80
Extra 6" Pigtail for QC Butt Hinge	Add
09717 QC2 Pigtail	\$5.25
09716 QC4 Pigtail	\$7.50
09715 QC8 Pigtail	\$9.75

Options/Additions Where Not Listed

PoE Option - Power over Ethernet	
Available on 4½" and 5" height hinges only	Add
Brass or Steel Base	\$593.00
MM Option - Magnetic Monitoring	
Add	
Magnetic Monitoring - suffix MM	\$208.00
Extra Heavy Magnetic Monitoring - suffix EHM	\$229.00
MM Magnet Assembly Only	\$35.35
EHM Magnet Assembly Only	\$36.45
MM Magnet Assembly & Switch	\$61.90
EHM Magnet Assembly & Switch	\$67.95
Non Removable Door Suffix NRD	
Moderne Hinge only (2 Knuckle) One NRD provided per set of 3 hinges	Add \$8.90 per door
Non Removable Pins	
Set screw in barrel suffix (NRP NRP SET SCS ONLY \$.50 EA NO DISC)	Add \$5.40 each
Raised Barrel Full Mortise Hinges Bearing Hinges Only	
Raised barrel prefix RB 4½" x 4½" Standard and Heavy Weight. 5" x 4½" Heavy Weight Only. Hinges are NRP and reversible for handing	Add \$28.77 each
Round Corner Prefix RC	
¼" round corner full mortise only	Add \$3.78 each
⅝" round corner full mortise 4½" or larger	Add \$3.78 each
Round corner hinges (RC) will be furnished in ¼" radius unless otherwise specified	
Replacement steel pins standard weight	Add \$1.25 each
Replacement steel pins heavy weight	Add \$1.75 each
Beveled Hinges (where doors are beveled on hinge side specify as follows)	
For 2 knuckle and 3 knuckle hinges use 5000 series. Example TA793 or TA792 will become TA5793 or TA5792 For 2 knuckle and 5 knuckle hinges use a 4000 series. Example TA2714 or T4A3386 will become a TA4714 or T4A4386 TA2731 will become a TA4731, A TA3350 becomes a TA4350	If a part # is not shown in price book for Beveled Edge Hinge, add 10% to the price of Square Edge Hinge
Safety Stud Featured Suffix SSF	
Add \$16.15 each	
Prison Safety Feature Suffix PSF (available HTA386 (32D) only)	
Add \$19.16 each	
Slip in Hinges Suffix SIH Type I (Handed), SIH Type II Regular weight bearing hinge only (Indicate hand when ordering)	
Add \$32.75 each	
Special Screws (½" x 12-24 machine" - 1¼" x 12 wood) Consult factory for price and minimum requirements on additional sizes	
Steel Spanner Head	\$1.20 each
Brass Spanner Head	\$1.65 each
Stainless Steel Spanner Head	\$3.05 each
Spanner bit holder tool	\$45.50 each
Spanner bit (for use in holder)	\$30.95 each
TORX Pin head security screws - Suffix TXS, machine screws provided. Wood screws by request only	
Steel Torx	\$1.90 each net add per hinge or \$.47 each
Stainless Torx	\$2.88 each net add per hinge or \$.74 each
TORX bit*	\$31.65 each
TORX bit holder tool*	\$45.45 each
*#20 - ½" x 12-24 & 1¼" x 12 wood screw	
*#25 - ½" x 1¼"-20 machine screw, 1½" x 12 wood screw	
TIPS -- Hospital Tips Prefix H	
Regular weight plain bearing, oil impregnated or ball	Add \$17.60 each
Heavy weight oil impregnated or ball	Add \$17.60 each
Solid Brass Ball Tips suffix x BT up to 6" in height	Add \$17.60 each
Solid Brass Steeple Tips suffix x ST up to 6" in height	Add \$17.60 each
Deco Tips for two and three knuckle hinges, where not listed, suffix RT, FT, GT, LT	Add \$17.60 each
Architectural Hardware Finish Presentation Folder FS86 73002	
\$78.25 net	
Perforated cardboard shims Part # 75818	\$.10 each

ASSA ABLOY

GEN-6 The global leader in door opening solutions

800-346-7707 | www.mckinneyhinge.com
Check the web site for the up-to-date catalog

McKinney is a brand associated with Corbin Russwin, Inc., an ASSA ABLOY Group company. Copyright © 2012-2017, Corbin Russwin, Inc. All rights reserved. Reproduction in whole or in part without the express written permission of Corbin Russwin, Inc. is prohibited.

Index

451	SH-2	MCK-HG315	CH-6	TA5793	AH-4
452	SH-2	MCK-HG322	CH-6	TA5794	AH-4
453	SH-2	MCK-HG323	CH-6	TA2314BT	FM-7
1001	SH-2	MCK-HG326	CH-6	TA2314ST	FM-7
1400	SP-2	MCK-HG3505	CH-9	TCA2314	FM-6
1414	SP-2	MCK-HM304	CH-7	TCA2714	FM-9 – FM-10
1458	SP-2	MCK-HS303	CH-7	TCA3386	FM-16
1502, 1502R	SH-1	MCK-HS3703	CH-9	TCA3786	FM-19
1522	SH-1	MG-16	GEN-4	T4A3381	FS-1
1552	SH-1	MK10379	SH-2	T4A3382	HS-1
3001	SH-3	MP79	FM-20	T4A3384	HM-3
4007-MRB	SH-4	MPB79	FM-21	T4A3386	FM-16
4007RB	SH-4	MPS60	SH-2	T4A3395	FM-17
8007	SH-4	MPB68	FM-21	T4A3781	FS-1
9001	SH-2	MPB91	FM-21	T4A3782	HS-2
19001	SH-3	MPB99	FM-21	T4A3784	HM-3
BP-10	HS-2	MPS679	SH-2	T4A3786	FM-18 – FM-19
BP-11	HS-2	PH-4	SP-1	T4A3795	FM-20
BP-12	HS-2	SP3786	SP-1	T4A3796	HS-1
CSS-9	RH-1	SP3386	SP-1	T4A3789	HM-3
DLS-8	RH-1	SQ3331	DH-5	T4A4795	FM-20
DS-6	RH-1	T2314	FM-5	T4B3386	FM-15
Deco Hinges	DH-1 – DH-5	T2714	FM-7 – FM-8	T6A3786	FM-19
78000 Series	DH-1 – DH-5	T2895	SP-2	T6B3386	FM-15
EP-5J	RH-1	TA314	FM-1		
H8007	SH-4	TA386	FM-2		
HS1001	SH-3	TA391	AH-1		
HTA386	FM-2	TA392	AH-1		
HTA714	FM-4	TA393	AH-1		
HTA786	FM-4	TA394	AH-1		
HTA2714	FM-10	TA714	FM-3		
HTB386	FM-2	TA786	FM-4		
HTB786	FM-5	TA791	AH-2		
J3001	SH-3	TA792	AH-3		
K-MCK-12HD	CG-4	TA793	AH-3		
MCK-12HD	CG-3	TA794	AH-3		
MCK-14HD	CG-3	TA795	FM-4		
MCK-22HD	CG-3	TA2314	FM-5 – FM-6		
MCK-25HD	CG-3	TA2372	HS-1		
MCK-28HD	CG-3	TA2395	FM-7		
MCK-54HD	CG-4	TA2398	FM-7		
MCK-58HD	CG-4	TA2714	FM-8 – FM-9		
MCK-WTHD	CG-3	TA2731	FM-10 – FM-12		
MCK-FM300	CH-6	TA2771	FS-1		
MCK-FM327	CH-7	TA2772	HS-2		
MCK-FM3500	CH-8	TA2774	HM-2		
MCK-FS301	CH-7	TA2798	FM-12 – FM-13		
MCK-FS302	CH-8	TA2895	FM-13		
MCK-FS309	CH-8	TA3331	FM-14		
MCK-FS321	CH-8	TA3350	FM-14		
MCK-FS3501	CH-8	TA3374	HM-2		
MCK-FS3502	CH-9	TA3383	DH-5		
MCK-FM3700	CH-9	TA3750	FM-17		
MCK-FS3701	CH-9	TA4395	FM-5		
MCK-FS3702	CH-9	TA4895	FM-13		
MCK-HG305	CH-6	TA5392	AH-2		
MCK-HG306	CH-7	TA5393	AH-2		
MCK-HG310	CH-8	TA5394	AH-3		
MCK-HG311	CH-7	TA5792	AH-3		

800-346-7707 | www.mckinneyhinge.com

Check the web site for the up-to-date catalog

McKinney is a brand associated with Corbin Russwin, Inc., an ASSA ABLOY Group company. Copyright © 2012-2017, Corbin Russwin, Inc. All rights reserved. Reproduction in whole or in part without the express written permission of Corbin Russwin, Inc. is prohibited.

ASSA ABLOYThe global leader in
door opening solutions

GEN-7

McKinney Buy Program Codes

Type	Code	Description
5 Knuckle Hinges	50	For all hinges 4½" and higher
5 Knuckle Hinges	50F	For all hinges 4"
5 Knuckle Hinges	50E	For all hinges 3½"
Discounts for TB / T4B the same as TA / T4A		
T2314, TA2314, TCA2314, T2714, TA2714, TCA2714, TA2798, TA2895, TA3313, T4A3386, TCA3386, T4A3395, TA3713, T4A3786, TCA3786, T4A3795,, T4A4795, TA4895, T2774, TA2774, TCA2774, TA3374, TCA3374, T4A3384, TCA3384, T4A3784, TCA3784, TCA3789, TA2372, TCA3382, T4A3782, T4A3796, T2772, TA2772, TCA2772, T4A3382, BP10, BP11, BP12, TA2771, TCA2771, T4A3381, TCA3381, T4A3781, TCA3781, SP3386, SP3786		
MacPro Hinges	57	
MP79, MPB79, MPB91, MPB68, MPB99, MPS60, MPB679		
3 Knuckle Hinges	30	For all hinges 4½" and higher
3 Knuckle Hinges	30F	For all hinges 4"
3 Knuckle Hinges	30E	For all hinges 3½"
TA314, TA386, TA714, TA786, TA795, TA391, TA392, TA393, TA394,, TA35392, TA5393, TA5394, TA791, TA792, TA793, TA794, TA5792, TA5793, TA5794		
Electric Hinges		
5 Knuckle	59	Do not add NRP as these hinges have a knurled hollow pin and are 'nonremovable' by design.
3 Knuckle	39	
2 Knuckle	29	
Aluminum Continuous Gear	89	
Stainless Continuous	83	
Do not add NRP as these hinges come NRP as a standard. All Swing Clear (hinges ending in 89, 91, 95, 96, for instance TA791, TA2895, T4A3796) Anchor Hinge Sets (for instance TA391, TA382, TA5392, TA792 etc) ½ Mortise Hinges ending in 74 or 84 (for example TA2374 or T4A3384) ½ Surface Hinges ending in 72 or 82 (for example TA2372 or T4A3382)		
Electric Hinges & Wire Harness Products	79	
QC-C300 thru QC-C1500, QC-C300P thru QC-C1500P, QCR001, QC-R002, QC-R003, QC-RF2, QC-RF4, QCR-F8, QC-RM2, QC-RM4, QC-RM8, QC-FT2024, QC-FT2630, QC-MT2024, QC-MT2630, QC-DCC, TSBC-CXL, TSB-C, EPT, EPTL, EL-EPT, EL-EPTL, Po-EC206P thru PoE-C1500P		
2 Knuckle Hinges	20	For all hinges 4½" and higher
2 Knuckle Hinges	20F	For all hinges 4"
2 Knuckle Hinges	20E	For all hinges 3½"
TA2731, TA3331, TA3350, TA3750, SQ3331, TA3383		
Spring Hinges		
1502, 1522, 1532, 1500	71	For 4½"
1502, 1500	71F	For 4"
Double Acting or Pivots		
1001, 451, 452, 453, 9001, 19001, HS1001, 3001, J3001, 4007RB, 4007MRB, 8007, H8007		
Parts for Spring Hinges	73	
Rescue Hardware & Center Hung Pivot & PH4		
CSS-9, DS-6, DLS-8, EP-5J, PH-4		
Residential Grade Hinges		
1400, 1414, 1458	14	
Aluminum Continuous Hinges		
12HD, K-12HD, 14HD, 22HD, 25HD, 28HD, 54HD, 58HD	80	
Stainless Continuous Hinges		
FM300, HG305, HG315, HG322, HG323, HG326, FM327, HM304, HG306, HG311, FS301, HS303, FS302, FS309, FS321, HG310, FM3500, FS3501, FS33502, HG3505	83	
Steel Continuous Hinges		
FM3700, FS3701, FS3702, HS3703,	87	
Miscellaneous	0 Discount unless noted on Buy Program	



Standard Weight Three Knuckle Non-Ferrous Bearings

TA314
Price Code 30

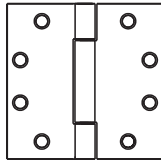

Size	Part Number	Finish	Price Each	Box Qty.	Case Qty.	Case Wgt.
3 1/2" x 3 1/2" 88.90 mm x 88.90 mm	69313	P	73.46	3	48	33
	69314	AP	78.50			
	69322	3	78.50			
	69315	4	78.50			
	69316	10	78.50			
	69325	10A	78.50			
	69317	10B	90.05			
	69320	26	78.50			
	69312	26D	78.50			
	69323	32D	73.46			
	4" x 4" 101.60 mm x 101.60 mm	69328	P			
69329		AP	89.39			
73709		3	89.39			
69330		4	89.39			
69331		10	89.39			
69340		10A	89.39			
69332		10B	102.54			
73714		26	89.39			
69327		26D	89.39			
69338		32D	79.65			
4 1/2" x 4" 114.30 mm x 101.60 mm		69343	P	85.32	3	48
	69344	AP	95.74			
	69352	3	95.74			
	69345	4	95.74			
	69346	10	95.74			
	69341	10A	95.74			
	69347	10B	107.67			
	69350	26	95.74			
	69342	26D	85.71			
	69354	32	95.74			
	69353	32D	41.38			
4 1/2" x 4" 114.30 mm x 101.60 mm	56402	32D-NRP	46.38	3	48	53
4 1/2" x 4 1/2" 114.30 mm x 114.30 mm	69358	P	73.40	3	48	57
	69359	AP	85.32			
	69367	3	85.32			
	69360	4	85.32			
	69361	10	85.32			
	69355	10A	85.32			
	69362	10B	87.36			
	69365	26	85.32			
	69357	26D	85.32			
	69369	32	77.56			
	69368	32D	41.38			
4 1/2" x 4 1/2" 114.30 mm x 114.30 mm NRP	69370	10-NRP	90.72	3	48	57
	69371	26D-NRP	90.72			
	69356	32D-NRP	46.38			

Size	Part Number	Finish	Price Each	Box Qty.	Case Qty.	Case Wgt.
5" x 4" 127 mm x 101.60 mm	73882	P	131.12	3	24	33
	73883	AP	138.03			
	73884	3	138.03			
	73885	4	138.03			
	73886	10	138.03			
	73887	10A	138.03			
	73888	10B	158.33			
	73889	26	138.03			
	73880	26D	138.03			
	73890	32	138.03			
	73881	32D	106.24			
5" x 4 1/2" 127 mm x 114.30 mm	69373	P	114.20	3	24	36
	69374	AP	131.12			
	69382	3	131.12			
	69375	4	131.12			
	69376	10	131.12			
	69385	10A	131.12			
	69377	10B	150.41			
	69380	26	131.12			
	69372	26D	131.12			
	69383	32D	55.74			
	69384	32	119.25			
5" x 5" 127 mm x 127 mm	69388	P	114.20	3	24	36
	69389	AP	119.24			
	69397	3	119.24			
	69390	4	119.24			
	69391	10	119.24			
	69386	10A	119.24			
	69392	10B	136.77			
	69395	26	119.24			
	69387	26D	119.24			
	69399	32	131.12			
	69398	32D	114.20			

Std. Wgt. 3 Knuckle Hospital Tip Non-Ferrous Bearings

TA314
Price Code 30

Part Number	Finish	Price Each	Box Qty.	Case Qty.	Case Wgt.
4 1/2" x 4" 114.30 mm x 101.60 mm					
69489	32D	59.34	3	48	53
4 1/2" x 4 1/2" 114.30 mm x 114.30 mm					
69363	32D	58.18	3	48	57

Heavy Weight Three Knuckle

TA386
Price Code 30

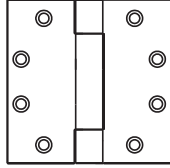

Size	Part Number	Finish	Price Each	Box Qty.	Case Qty.	Case Wgt.
4 1/2" x 4" 114.30 mm x 101.60 mm	69396	32D-NRP	74.11	3	24	37
	69411	32D	72.00			
4 1/2" x 4 1/2" 114.30 mm x 114.30 mm	69403	P	112.96	3	24	36
	69404	AP	131.12			
	69412	3	131.12			
	69405	4	131.12			
	69406	10	131.12			
	69416	10A	131.12			
	69407	10B	129.00			
	69410	26	131.12			
	69402	26D	131.12			
	69414	32	131.12			
4 1/2" x 4 1/2" 114.30 mm x 114.30 mm	69400	26D-NRP	136.52	3	24	36
	69415	32D-NRP	74.11			
5" x 4 1/2" 127 mm x 114.30 mm	69418	P	196.52	3	24	41
	69419	AP	218.55			
	69427	3	218.55			
	69420	4	218.55			
	69421	10	218.55			
	69431	10A	218.55			
	69422	10B	250.68			
	69425	26	218.55			
	69417	26D	218.55			
	69429	32	218.55			
5" x 4 1/2" 127 mm x 114.30 mm (NRP)	69428	32D	86.80	3	24	41
	69430	26D-NRP	223.55			
	74956	32D-NRP	82.86			

Size	Part Number	Finish	Price Each	Box Qty.	Case Qty.	Case Wgt.
5" x 5" 127 mm x 127 mm	69433	P	196.52	3	24	45
	69434	AP	218.55			
	69442	3	218.55			
	69435	4	218.55			
	69436	10	218.55			
	69445	10A	218.55			
	69437	10B	250.68			
	69440	26	218.55			
	69432	26D	218.55			
	69444	32	218.55			
6" x 6" 152.4 mm x 152.4 mm	69443	32D	196.52	3	18	74
	69448	P	342.11			
	69449	AP	342.11			
	69457	3	342.11			
	69450	4	342.11			
	69451	10	335.40			
	69460	10A	335.40			
	69452	10B	384.73			
	69455	26	342.11			
	69447	26D	342.11			
69459	32	342.11				
69458	32D	330.78				

Size	Part Number	Finish	Price Each	Box Qty.	Case Qty.	Case Wgt.
TA386 Price Code 30						
4 1/2" x 6" 114.30 mm x 152.40 mm	-	32D	145.60	3	24	60

Hospital Tip Heavy Weight Three Knuckle Non-Ferrous Bearings

Stainless Steel Institutional Hinges

HTA386 Price Code 30

4 1/2" x 4 1/2" 114.30 mm x 114.30 mm	81306	32D	86.16	3	24	37
--	-------	-----	-------	---	----	----

HTA386 x PSF Price Code 30

Packed with 1/2" x 12-24 Torx Pin Head Security Machine Screw	81535	32D	103.69	3	24	40
--	-------	-----	--------	---	----	----

HTB386 MSP Set Price Code 30

Option A includes three hinges with hospital tips. Top and bottom hinges supplied with PSF and SSF, middle hinge is not.

73962

\$325.84 set

Option B - QC8 includes three hinges with hospital tips. Top and bottom hinges supplied with PSF and SSF, middle hinge is provided with QC and no PSF of SSF.

Price Code 39

\$675.84 QC8

\$790.84 QC12

ASSA ABLOY

FM-2 The global leader in door opening solutions

800-346-7707 | www.mckinneyhinge.com

Check the web site for the up-to-date catalog

McKinney is a brand associated with Corbin Russwin, Inc., an ASSA ABLOY Group company. Copyright © 2012-2017, Corbin Russwin, Inc. All rights reserved. Reproduction in whole or in part without the express written permission of Corbin Russwin, Inc. is prohibited.

Steel Standard Weight Three Knuckle Bearing

TA714
Price Code 30

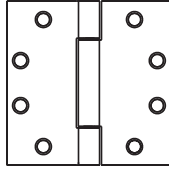

Size	Part Number	Finish	Price Each	Box Qty.	Case Qty.	Case Wgt.				
3 1/2" x 3 1/2" 88.90 mm x 88.90 mm	69178	P	18.77	3	48	31				
	69179	AP	28.51							
	69187	3	28.51							
	69180	4	28.51							
	69181	10	28.51							
	69190	10A	28.51							
	69182	10B	32.70							
	69188	15	12.43							
	69185	26	28.51							
	69177	26D	12.43							
	4" x 4" 101.60 mm x 101.60 mm	69193	P				19.89	3	48	42
		69194	AP				29.21			
69202		3	29.21							
69195		4	29.21							
69196		10	29.21							
69191		10A	29.21							
69197		10B	33.50							
69200		26	29.21							
69192		26D	15.99							

Size	Part Number	Finish	Price Each	Box Qty.	Case Qty.	Case Wgt.				
4 1/2" x 4" 114.30 mm x 101.60 mm	69208	P	23.58	3	48	51				
	69209	AP	31.98							
	69217	3	25.91							
	69210	4	28.50							
	69211	10	25.91							
	69176	10A	25.91							
	69212	10B	29.72							
	56403	15	23.12							
	69215	26	25.91							
	69207	26D	15.68							
	69206	D3	31.98							
	69221	D4	25.62							
	4 1/2" x 4" 114.30 mm x 101.60 mm	74201	26D-NRP				20.68	3	48	51
		69223	P				12.67	3	48	55
	4 1/2" x 4 1/2" 114.30 mm x 114.30 mm	69224	AP				25.62			
69232		3	18.40							
69225		4	18.40							
69226		10	18.40							
69236		10A	18.40							
69227		10B	21.11							
69228		15	14.93							
69230		26	18.40							
69222		26D	14.93							
69250		D3	28.18							
74284		D4	28.18							
4 1/2" x 4 1/2" 114.30 mm x 114.30 mm (NRP)		69235	P-NRP	18.07	3	48	55			
		74283	26D-NRP	19.93						
		69251	3-NRP	23.80						
	74200	10-NRP	23.80							
	74282	10B-NRP	26.26							

Hospital Tip HTA714 Price Code 30

Size	Part Number	Finish	Price Each	Box Qty.	Case Qty.	Case Wgt.
4 1/2" x 4 1/2" 114.30 mm x 114.30 mm	69233	26D	34.92	3	48	55

Steel Standard Weight Three Knuckle Bearing

TA714
Price Code 30

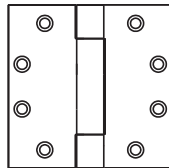

Size	Part Number	Finish	Price Each	Box Qty.	Case Qty.	Case Wgt.				
5" x 4 1/2" 127 mm x 114.30 mm	69238	P	38.76	3	24	32				
	69239	AP	49.87							
	69247	3	40.41							
	69240	4	49.87							
	69241	10	49.87							
	69311	10A	49.87							
	69242	10B	57.22							
	69245	26	32.55							
	69237	26D	23.98							
	5" x 5" 127 mm x 127 mm	69253	P				52.61	3	24	34
		69254	AP				62.71			
		69262	3				62.71			
69255		4	62.71							
69256		10	62.71							
69326		10A	62.71							
69257		10B	71.93							
69260		26	55.89							
69252		26D	45.46							

Steel Standard Weight Three Knuckle Bearing Wide Throw

TA714
Price Code 30

Size	Part Number	Finish	Price Each	Box Qty.	Case Qty.	Case Wgt.
4 1/2" x 6" 114.30 mm x 152.4 mm	74356	P	112.13	3	24	39
	74357	AP	112.13			
	74358	3	112.13			
	74359	4	112.13			
	74360	10	112.13			
	74371	10B	128.61			
	74372	26	112.13			
	74373	26D	100.80			
	74374	D3	112.13			
	74375	D4	112.13			
	5" x 4" 127 mm x 101.60 mm	69625	26D			

800-346-7707 | www.mckinneyhinge.com
Check the web site for the up-to-date catalog

McKinney is a brand associated with Corbin Russwin, Inc., an ASSA ABLOY Group company. Copyright © 2012-2017, Corbin Russwin, Inc. All rights reserved. Reproduction in whole or in part without the express written permission of Corbin Russwin, Inc. is prohibited.

ASSA ABLOY

The global leader in
door opening solutions

Steel Heavy Weight Three Knuckle Bearing

TA786
Price Code 30

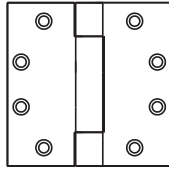

Size	Part Number	Finish	Price Each	Box Qty.	Case Qty.	Case Wgt.				
4 1/2" x 4" 114.30 mm x 101.60 mm	56400	26D	44.52	3	24	37				
	56401	26D-NRP	49.52							
	56404	15	44.52							
4 1/2" x 4 1/2" 114.30 mm x 114.30 mm	69268	P	51.17	3	24	37				
	69269	AP	75.43							
	69277	3	75.43							
	69270	4	75.43							
	69271	10	39.80							
	75282	10A	75.43							
	69272	10B	78.37							
	69276	15	34.01							
	69275	26	39.80							
	69267	26D	34.01							
4 1/2" x 4 1/2"-NRP 114.30 mm x 114.30 mm	69280	P-NRP	56.57	3	24	37				
	69281	10B-NRP	83.77							
	75240	26D-NRP	39.01							
5" x 4 1/2" 127 mm x 114.30 mm	69283	P	60.20	3	24	39				
	69284	AP	84.77							
	69292	3	84.77							
	69285	4	84.77							
	69286	10	84.77							
	75283	10A	84.77							
	69287	10B	90.55							
	69290	26	84.77							
	69282	26D	38.65							
	69298	P	70.25							
5" x 5" 127 mm x 127 mm	69299	AP	104.71	3	24	42				
	69307	3	104.71							
	69300	4	104.71							
	69301	10	104.71							
	75284	10A	104.71							
	69302	10B	120.11							
	69305	26	104.71							
	69297	26D	38.65							
	6" x 6"* 152.40 mm x 152.40 mm	75311	P				196.45	3	18	62
		75312	AP				196.45			
75316		3	196.45							
75317		4	196.45							
75319		10	196.45							
75327		10A	196.45							
75320		10B	225.35							
75323		26	196.45							
75324		26D	185.12							

* For 6" x 4 1/2" or 6" x 5" use price of 6" x 6"

Steel Heavy Weight Three Knuckle Hospital Tip

HTA786
Price Code 30

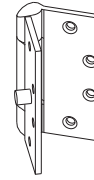

Size	Part Number	Finish	Price Each	Box Qty.	Case Qty.	Case Wgt.
4 1/2" x 4 1/2" 114.30 mm x 114.30 mm	75242	P	68.82	3	24	35
	75232	26D	51.83			
	75244	26D x PSF	70.82			
5" x 4 1/2" 127 mm x 114.30 mm	75233	26D	56.56	3	24	35

Hinges are packed with 1/2" x 12-24 Torx Pin Head Machine Screws.

Steel Swing Clear Heavy Weight 3 Knuckle Bearing – Reversible

TA795
Price Code 30

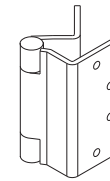

Size	Part Number	Finish	Price Each	Box Qty.	Case Qty.	Case Wgt.
4 1/2" 114.30 mm	75468	P	199.95	3	24	57
	75469	AP	199.95			
	75470	3	199.95			
	75471	4	181.77			
	75472	10	199.95			
	75473	10A	199.95			
	75474	10B	229.35			
	75475	26	199.95			
	75476	26D	129.96			
	5" 127 mm	75368	P			
75369		AP	199.95			
75373		3	199.95			
75374		4	199.95			
75376		10	199.95			
75384		10A	199.95			
75377		10B	229.35			
75380		26	199.95			
75381		26D	126.53			

For swing clear heavy weight three knuckle bearing, beveled edge application order TA5795. (Hinges are reversible and non-handed.)

Hospital Tip Bearings

HTA795
Price Code 30

Part Number	Finish	Price Each	Box Qty.	Case Qty.	Case Wgt.
4 1/2" 114.30 mm					
75464	26D	146.76	3	24	57
5" 127 mm					
75382	26D	140.85	3	24	57

ASSA ABLOY

The global leader in door opening solutions

Non-Ferrous Standard Weight 5 Knuckle

T2314
Price Code 50

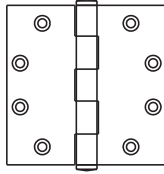

Size	Part Number	Finish	Price Each	Box Qty.	Case Qty.	Case Wgt.
3 1/2" x 3 1/2" 88.90 mm x 88.90 mm	58822	P	43.43	2	48	35
	59597	3	43.43			
	58823	4	43.43			
	59596	10	43.43			
	58839	10A	43.43			
	58836	10B	49.82			
	58826	26	43.43			
	59595	26D	43.43			
	58844	32	43.43			
	58845	32D	27.57			
4" x 4" 101.60 mm x 101.60 mm	59645	P	38.21	3	48	44
	59651	3	45.34			
	59647	4	45.34			
	59653	10	45.34			
	59665	10A	45.34			
	59646	10B	42.99			
	59655	26	45.34			
	59657	26D	45.34			
	59662	32	45.34			
	59661	32D	31.58			
4 1/2" x 4" 114.30 mm x 101.60 mm	59736	P	43.88	3	48	47
	58919	3	48.81			
	58920	4	48.81			
	59730	10	48.81			
	59740	10A	48.81			
	59733	10B	55.99			
	58924	26	48.81			
	59732	26D	48.81			

Size	Part Number	Finish	Price Each	Box Qty.	Case Qty.	Case Wgt.
4 1/2" x 4 1/2" 114.30 mm x 114.30 mm	59785	P	40.91	3	48	52
	59791	3	45.85			
	59787	4	45.85			
	59789	9	45.85			
	59793	10	45.85			
	59803	10A	45.85			
	58972	10B	43.47			
	59795	26	45.85			
	59797	26D	45.85			
	58963	32	41.68			
58964	32D	33.81				
4 1/2" x 4 1/2"-NRP 114.30 mm x 114.30 mm	59804	10B-NRP	48.52	3	48	52
	59784	26D-NRP	51.25			
	58965	32D-NRP	38.81			
5" x 4 1/2" 127 mm x 114.30 mm	58989	P	75.64	3	24	33
	58990	3	80.58			
	58991	4	80.58			
	59880	10	80.58			
	58998	10A	80.58			
	59879	10B	92.42			
	58995	26	80.58			
	59882	26D	80.58			
	59006	32	80.58			
	59007	32D	75.64			
5" x 5" 127 mm x 127 mm	59948	P	78.51	3	24	35
	59941	3	83.45			
	59944	4	83.45			
	59943	10	83.45			
	59947	10A	83.45			
	59946	10B	95.71			
	59945	26	83.45			
	59940	26D	83.45			
	59191	32	83.45			
	59192	32D	71.37			

Non-Ferrous Standard Weight 5 Knuckle Bearing

TA2314
Price Code 50

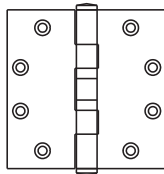

Size	Part Number	Finish	Price Each	Box Qty.	Case Qty.	Case Wgt.
3 1/2" x 3 1/2" 88.90 mm x 88.90 mm	61020	P	45.56	3	48	33
	61021	3	52.97			
	61022	4	52.97			
	61014	10	52.97			
	61016	10A	52.97			
	61015	10B	55.22			
	59611	26	52.97			
	59630	26D	52.97			
	61019	32	52.97			
	61026	32D	45.56			

Size	Part Number	Finish	Price Each	Box Qty.	Case Qty.	Case Wgt.
4" x 4" 101.60 mm x 101.60 mm	59675	P	46.46	3	48	46
	59681	3	54.20			
	59677	4	54.20			
	59683	10	54.20			
	59682	10A	54.20			
	59680	10B	51.37			
	59685	26	54.20			
	59687	26D	54.20			
	59676	32	54.20			
	59678	32D	38.40			
4 1/2" x 4" 114.30 mm x 101.60 mm	59750	P	50.07	3	48	53
	59754	3	59.43			
	59759	4	59.43			
	59745	10	59.43			
	59753	10A	59.43			
	59746	10B	56.35			
	59757	26	59.43			
	59747	26D	54.03			
	59751	32	59.43			
	59752	32D	41.38			

Continued on next page

800-346-7707 | www.mckinneyhinge.com
Check the web site for the up-to-date catalog

Mckinney is a brand associated with Corbin Russwin, Inc., an ASSA ABLOY Group company. Copyright © 2012-2017, Corbin Russwin, Inc. All rights reserved. Reproduction in whole or in part without the express written permission of Corbin Russwin, Inc. is prohibited.

ASSA ABLOY

The global leader in
door opening solutions

FM-5

Non-Ferrous Standard Weight 5 Knuckle Bearing

Continued...

TA2314
Price Code 50

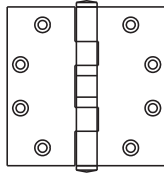

Size	Part Number	Finish	Price Each	Box Qty.	Case Qty.	Case Wgt.
4 1/2" x 4"-NRP 114.30 mm x 101.60 mm	59755	26D-NRP	54.12	3	48	53
	59756	32D-NRP	46.38			
	59741	10B-NRP	66.60			
4 1/2" x 4 1/2" 114.30 mm x 114.30 mm	59820	P	50.07	3	48	57
	59826	3	48.52			
	59822	4	48.52			
	59824	9	58.71			
	59828	10	49.90			
	59829	10A	58.71			
	59838C	CPC (SS)	45.52			
	59839	10B	61.20			
	59839S	10B (SS)	45.52			
	59839E	10BE (SS)	45.52			
4 1/2" x 4 1/2" 114.30 mm x 114.30 mm	59830	26	58.71	3	48	57
	59832	26D	45.46			
	59823	32	48.52			
	59838	32D	41.38			
	59821	P-NRP	55.47			
	59844	3-NRP	53.77			
	59835	10-NRP	58.87			
5" x 4" 127 mm x 101.60 mm	76001	10B-NRP	66.35	3	48	57
	59837	26D-NRP	50.96			
	59840	32D-NRP	46.38			
	59989	P	80.86			
	59991	3	85.80			
	59992	4	85.80			
5" x 4" 127 mm x 101.60 mm	59993	10	85.80	3	24	33
	59994	10A	85.80			
	59995	10B	98.42			

Continued on next column...

Size	Part Number	Finish	Price Each	Box Qty.	Case Qty.	Case Wgt.				
5" x 4" 127 mm x 101.60 mm	59996	26	85.80	3	24	33				
	59997	26D	85.80							
	59998	32	85.80							
	59999	32D	80.86							
5" x 4 1/2" 127 mm x 114.30 mm	60013	P	61.31	3	24	36				
	60014	3	68.11							
	60015	4	68.11							
	59900	10	65.01							
	59907	10A	68.11							
	59906	10B	64.57							
	60019	26	68.11							
	59902	26D	65.01							
	59901	32	65.01							
	59904	32D	50.67							
5" x 4 1/2"-NRP 127 mm x 114.30 mm	59905	26D-NRP	67.32	3	24	36				
	59910	32D-NRP	56.07							
	59911	10B-NRP	69.97							
5" x 5" 127 mm x 127 mm	59965	P	90.27	3	24	38				
	59971	3	95.21							
	59967	4	95.21							
	59973	10	95.21							
	59972	10A	95.21							
	59966	10B	90.25							
	59975	26	95.21							
	59977	26D	95.21							
	59983	32	95.21							
	59984	32D	82.06							
	6" x 6" 152.40 mm x 152.40 mm	61172	P				146.84	3	18	43
		61173	3				146.84			
		61174	4				146.84			
61167		10	146.84							
61171		10A	146.84							
61168		10B	168.42							
61178		26	146.84							
61179		26D	135.73							
61181		32D	131.25							
6" x 6" 152.40 mm x 152.40 mm		61181	32D	131.25	3	18	45			

Non-Ferrous Standard Weight 5 Knuckle Concealed Bearing

TCA2314
Price Code 50

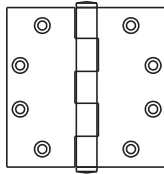

Size	Part Number	Finish	Price Each	Box Qty.	Case Qty.	Case Wgt.
4 1/2" x 4 1/2" 114.30 mm x 114.30 mm	68970	P	65.38	3	48	57
	68978	3	84.59			
	68972	4	84.59			
	68973	10	84.59			
	68969	10A	84.59			
	68974	10B	97.03			
	68981	26	84.59			
	68976	26D	84.59			
	68982	32	84.59			
	68983	32D	65.38			

Size	Part Number	Finish	Price Each	Box Qty.	Case Qty.	Case Wgt.
5" x 5" 127 mm x 127 mm	68990	P	98.14	3	24	38
	68998	3	103.08			
	68992	4	103.08			
	68993	10	103.08			
	68989	10A	103.08			
	68994	10B	118.24			
	69001	26	103.08			
	68996	26D	103.08			
	69002	32	103.08			
	69003	32D	98.14			

ASSA ABLOY

The global leader in
door opening solutions

Non-Ferrous Standard Weight 5 Knuckle Concealed Bearing

Non-Ferrous Standard Weight Five Knuckle Ball Tip

TA2314BT
Price Code 50

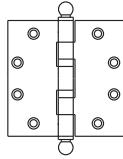

Size	Part Number	Finish	Price Each	Box Qty.	Case Qty.	Case Wgt.
4 1/2" x 4 1/2" 114.30 mm x 114.30 mm	59818	3	66.17	3	48	59

Non-Ferrous Standard Weight Five Knuckle Steeple Tip

TA2314ST
Price Code 50

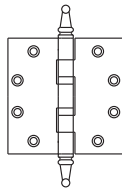

Size	Part Number	Finish	Price Each	Box Qty.	Case Qty.	Case Wgt.
4 1/2" x 4 1/2" 114.30 mm x 114.30 mm	59816	3	66.17	3	48	59

Steel Standard Weight 5 Knuckle

T2714
Price Code 50

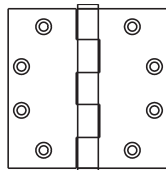

Size	Part Number	Finish	Price Each	Box Qty.	Case Qty.	Case Wgt.
3 1/2" x 3 1/2" 88.90 mm x 88.90 mm	55315	P	2.93	2	48	31
	55335	AP	9.03			
	55317	3	7.46			
	55337	4	7.46			
	55321	10	7.46			
	55330	10A	9.03			
	55333	10B	8.55			
	55430	RC-10B	12.15			
	5533E	10BE	7.27			
	55314	15	6.08			
	55327	26	7.46			
	55319	26D	6.08			
	55438	RC-26D	9.68			
	55380	D4	7.46			
	55443	RC-D4	11.81			
	3 1/2" x 3 1/2" 88.90 mm x 88.90 mm (RHP)	55397 Reverse Hole Pattern	26D			

Non-Ferrous Swing Clear Standard Weight

TA2395
Price Code 50

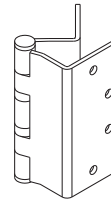

Size	Part Number	Finish	Price Each	Box Qty.	Case Qty.	Case Wgt.
4 1/2" 114.30 mm	56985	32D	394.80	3	24	40
5" 127 mm	73585	32D	127.29			
	TA4395 73584	32D	127.29			

Hinges are NRP and Reversible.

Non-Ferrous Standard Weight Five Knuckle Wide Throw

TA2398
Price Code 50

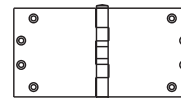

Size	Part Number	Finish	Price Each	Box Qty.	Case Qty.	Case Wgt.
4 1/2" x 6" 114.30 mm x 152.40 mm	62624	32D	209.59	3	24	42
	62620	26D	220.70			
4 1/2" x 8" 114.30 mm x 203.20 mm	-	32D	206.66	3	24	45
5" x 8" 127 mm x 203.20 mm	-	32D	216.75	3	24	50

Size	Part Number	Finish	Price Each	Box Qty.	Case Qty.	Case Wgt.				
4" x 4" 101.60 mm x 101.60 mm	55485	P	4.08	3	48	41				
	55505	AP	9.27							
	55491	3	7.66							
	55487	4	7.66							
	55493	10	9.27							
	55511	10A	9.27							
	55496	10B	8.79							
	55497	15	6.51							
	55499	26	7.66							
	55501	26D	6.51							
	4 1/2" x 4" 114.30 mm x 101.60 mm	55635	P				5.65	3	48	50
		55641	AP				14.41			
		55646	3				13.10			
		55648	4				11.91			
55637		10	11.91							
55638		10A	14.41							
55644		10B	14.08							
55656		15	8.52							
55655		26	11.91							
55639		26D	8.52							
4 1/2" x 4" 114.30 mm x 101.60 mm (NRP)	55652	D3	14.41	3	48	50				
	55653	D4	14.41							
	55645	P-NRP	11.05							
	55657	26D-NRP	13.92							

Continued on next page

800-346-7707 | www.mckinneyhinge.com
Check the web site for the up-to-date catalog

McKinney is a brand associated with Corbin Russwin, Inc., an ASSA ABLOY Group company. Copyright © 2012-2017, Corbin Russwin, Inc. All rights reserved. Reproduction in whole or in part without the express written permission of Corbin Russwin, Inc. is prohibited.

ASSA ABLOY

The global leader in door opening solutions

Steel Standard Weight 5 Knuckle

Continued...

T2714
Price Code 50

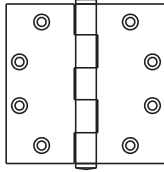

Size	Part Number	Finish	Price Each	Box Qty.	Case Qty.	Case Wgt.
4 1/2" x 4 1/2" 114.30 mm x 114.30 mm	55745	P	5.65	3	48	54
	55759	AP	12.39			
	55771	3	10.24			
	55767	4	10.24			
	55769	9	12.39			
	55774	10	10.24			
	55762	10A	10.24			
	55742	10B	11.75			
	55742E	10BE	8.70			
	55751	15	8.11			
	55753	26	10.24			
	55755	26D	8.11			
	55782	D3	11.26			
	55783	D4	11.26			
4 1/2" x 4 1/2" 114.30 mm x 114.30 mm (NRP)	55747	P-NRP	10.65	3	48	54
	55754	AP-NRP	17.79			
	55750	3-NRP	15.64			
	55768	4-NRP	15.64			
	55792	10-NRP	15.64			
	55752	10B-NRP	17.15			
	55766	26-NRP	15.64			
	55778	26D-NRP	13.11			

Size	Part Number	Finish	Price Each	Box Qty.	Case Qty.	Case Wgt.				
5" x 4 1/2" 127 mm x 114.30 mm	55968	P	20.23	3	24	31				
	55974	AP	33.56							
	55988	3	33.56							
	70044	4	33.56							
	55970	10	33.56							
	55971	10A	33.56							
	70046	10B	38.50							
	55984	15	18.76							
	70049	26	33.56							
	55972	26D	18.76							
	55973	D3	33.56							
	55982	D4	33.56							
	5" x 5" 127 mm x 127 mm	56080	P				30.70	3	24	34
		56090	AP				41.54			
56082		3	41.54							
70057		4	41.54							
56086		10	41.54							
70064		10A	41.54							
70059		10B	47.65							
70062		26	41.54							
56084		26D	34.89							
70065		D3	41.54							
70066		D4	41.54							

Steel Standard Weight 5 Knuckle Bearing

TA2714
Price Code 50

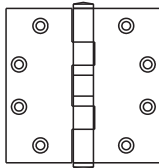

Size	Part Number	Finish	Price Each	Box Qty.	Case Qty.	Case Wgt.
3 1/2" x 3 1/2" 88.90 mm x 88.90 mm	55385	P	10.24	3	48	31
	55399	AP	18.95			
	55391	3	15.66			
	55387	4	18.95			
	55395	10	15.66			
	55401	10A	18.95			
	55389	10B	17.96			
	55402	26	18.95			
	55393	26D	12.43			
	55392	15	12.43			
	4" x 4" 101.60 mm x 101.60 mm	55555	P			
55575		AP	20.19			
55561		3	16.68			
55557		4	20.19			
55563		10	16.68			
55554		10A	20.19			
55577		10B	19.13			
55569		26	16.68			
55571		26D	14.25			
55567		15	14.25			

Size	Part Number	Finish	Price Each	Box Qty.	Case Qty.	Case Wgt.
4 1/2" x 4" 114.30 mm x 101.60 mm	55675	P	12.67	3	48	51
	55677	AP	22.26			
	55683	3	18.40			
	55674	4	18.40			
	55681	10	18.40			
	55673	10A	18.40			
	55691	10B	21.11			
	55691E	10BE	17.20			
	55616	15	15.68			
	55688	26	18.40			
	55679	26D	15.68			
	55587	D3	22.08			
	55588	D4	22.08			
	4 1/2" x 4" 114.30 mm x 101.60 mm (NRP)	55797	RC-26D*			
55693		P-NRP	18.07			
55690		26D-NRP	20.68			
55682		10A-NRP	23.80			
55689		10B-NRP	24.53			
55798		RC-26DNRP*	24.43			
55802		D4-NRP	28.99			

*Round Corner.

Continued on next page

ASSA ABLOY

FM-8 The global leader in door opening solutions

800-346-7707 | www.mckinneyhinge.com

Check the web site for the up-to-date catalog

McKinney is a brand associated with Corbin Russwin, Inc., an ASSA ABLOY Group company. Copyright © 2012-2017, Corbin Russwin, Inc. All rights reserved. Reproduction in whole or in part without the express written permission of Corbin Russwin, Inc. is prohibited.

Steel Standard Weight 5 Knuckle Bearing

Continued...

TA2714
Price Code 50

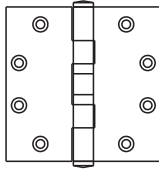

Size	Part Number	Finish	Price Each	Box Qty.	Case Qty.	Case Wgt.
4 1/2" x 4 1/2" 114.30 mm x 114.30 mm	55820	P	12.67	3	48	55
	55866	AP	18.40			
	55846	3	18.40			
	55842	4	18.40			
	55844	9	18.40			
	55848	10	18.40			
	55847	10A	18.40			
	55862	10B	21.11			
	55862E	10BE	15.64			
	55854	15	14.93			
	55856	26	18.40			
	55858	26D	14.93			
	55809	D3	18.40			
	55810	D4	18.40			
	4 1/2" x 4 1/2" 114.30 mm x 114.30 mm (NRP)	55822	P-NRP			
55868		AP-NRP	23.80			
55853		3-NRP	23.80			
55834		4-NRP	23.80			
55816		9-NRP	23.80			
55850		10-NRP	23.80			
55851		10A-NRP	23.55			
55875		10B-NRP	26.11			
55875E		10BE-NRP	20.79			
55870		26-NRP	23.40			
55860		26D-NRP	19.93			
55814		D3-NRP	23.80			
5" x 4" 127 mm x 101.60 mm	55963	P	31.21	3	24	29
	55995	AP	39.67			
	55996	3	39.67			
	55997	4	39.67			
	55964	10	39.67			
	55966	26	39.67			
	55962	26D	27.83			

Size	Part Number	Finish	Price Each	Box Qty.	Case Qty.	Case Wgt.
5" x 4 1/2" 127 mm x 114.30 mm	56010	P	21.17	3	24	32
	56024	AP	39.39			
	56011	3	35.81			
	56013	4	39.39			
	56014	10	32.55			
	56036	10A	39.39			
	56026	10B	37.33			
	56018	26	32.55			
	56020	26D	23.98			
	5" x 4 1/2" 127 mm x 114.30 mm (NRP)	56012	P-NRP			
56030		26D-NRP	29.38			
5" x 5" 127 mm x 127 mm	56120	P	37.87	3	24	34
	56122	P-NRP	43.27			
	56153	AP	45.75			
	56139	3	41.59			
	56135	4	41.59			
	56141	10	45.75			
	56148	10A	45.75			
	56155	10B	47.70			
	56147	26	41.59			
	56149	26D	37.51			
6" x 6" 152.4 mm x 152.4 mm	56232	P	103.66	3	18	55
	56249	AP	103.66			
	56239	3	103.66			
	56240	4	103.66			
	56243	10	103.66			
	56252	10A	103.66			
	56244	10B	118.91			
	56247	26	103.66			
	56248	26D	92.55			

Steel Standard Weight 5 Knuckle Concealed Bearing

TCA2714
Price Code 50

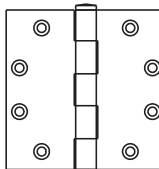

Size	Part Number	Finish	Price Each	Box Qty.	Case Qty.	Case Wgt.
4 1/2" x 4" 114.30 mm x 101.60 mm	67200	P	25.85	3	48	51
	67201	AP	37.68			
	67208	3	37.68			
	67202	4	37.68			
	67203	10	37.68			
	67216	10A	37.68			
	67204	10B	43.22			
	67210	15	24.99			
	67211	26	37.68			
	67206	26D	24.99			
	67213	D3	37.68			
	67214	D4	37.68			

Size	Part Number	Finish	Price Each	Box Qty.	Case Qty.	Case Wgt.
4 1/2" x 4 1/2" 114.30 mm x 114.30 mm	67220	P	21.51	3	48	55
	67221	AP	29.15			
	67228	3	29.15			
	67222	4	29.15			
	67223	10	26.50			
	67235	10A	29.15			
	67224	10B	30.40			
	67230	15	20.01			
	67231	26	29.15			
	67226	26D	20.01			
	67233	D3	29.15			
	67234	D4	29.15			

Continued on next page

800-346-7707 | www.mckinneyhinge.com

Check the web site for the up-to-date catalog

McKinney is a brand associated with Corbin Russwin, Inc., an ASSA ABLOY Group company. Copyright © 2012-2017, Corbin Russwin, Inc. All rights reserved. Reproduction in whole or in part without the express written permission of Corbin Russwin, Inc. is prohibited.

ASSA ABLOY

The global leader in
door opening solutions

Steel Standard Weight 5 Knuckle Concealed Bearing

Continued...

TCA2714
Price Code 50

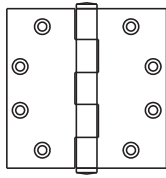

Size	Part Number	Finish	Price Each	Box Qty.	Case Qty.	Case Wgt.
5" x 4 1/2" 127 mm x 114.30 mm	67240	P	45.38	3	24	32
	67241	AP	57.26			
	67248	3	57.26			
	67242	4	57.26			
	67243	10	57.26			
	67255	10A	57.26			
	67244	10B	65.68			
	67245	15	40.61			
	67251	26	57.26			
	67246	26D	40.61			
	67253	D3	57.26			
	67254	D4	57.26			

Size	Part Number	Finish	Price Each	Box Qty.	Case Qty.	Case Wgt.
5" x 5" 127 mm x 127 mm	67260	P	44.14	3	24	32
	67261	AP	57.26			
	67268	3	57.26			
	67262	4	57.26			
	67263	10	57.26			
	67275	10A	57.26			
	67264	10B	65.68			
	67265	15	49.14			
	67271	26	57.26			
	67266	26D	49.14			
	67273	D3	57.26			
	67274	D4	57.26			

Steel Standard Weight 5 Knuckle Hospital Tip Bearing

HTA2714
Price Code 50

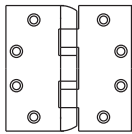

Part Number	Finish	Price Each	Box Qty.	Case Qty.	Case Wgt.
4 1/2" x 4" 114.30 mm x 101.60 mm					
55819	26D	32.48	3	48	55
4 1/2" x 4 1/2" 114.30 mm x 114.30 mm					
55821	P	30.32	3	48	55
55859	26D	31.73			
5" x 4 1/2" 127 mm x 114.30 mm					
56021	15	23.98	3	48	32

Steel Standard Weight 5 Knuckle Bearing Safety Stud

HTA2714
Price Code 50

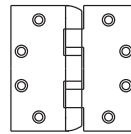

Part Number	Finish	Price Each	Box Qty.	Case Qty.	Case Wgt.
4 1/2" x 4" 114.30 mm x 101.60 mm					
NRP					
55861	26D NRP	35.43	3	48	55

Steel Standard Weight 2 Knuckle Bearing

TA2731
Price Code 20

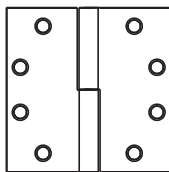

Size	Part Number	Finish	Price Each	Box Qty.	Case Qty.	Case Wgt.
3 1/2" x 3 1/2" 88.90 mm x 88.90 mm						
R.H.	65450	P	16.75	3	48	31
L.H.	65451	P	16.75			
R.H.	65463	AP	19.20			
L.H.	65464	AP	19.20			
R.H.	65477	3	19.20			
L.H.	65478	3	19.20			
R.H.	65452	4	19.20			
L.H.	65453	4	19.20			
R.H.	65454	10	19.20			

Size	Part Number	Finish	Price Each	Box Qty.	Case Qty.	Case Wgt.
3 1/2" x 3 1/2" 88.90 mm x 88.90 mm						
L.H.	65455	10	19.20	3	48	31
R.H.	65467	10A	19.20			
L.H.	65468	10A	19.20			
R.H.	65475	10B	23.74			
L.H.	65476	10B	23.74			
R.H.	65483	26	19.20			
L.H.	65484	26	19.20			
R.H.	65458	26D	16.75			
L.H.	65459	26D	16.75			
R.H.	65487	D3	19.20			
L.H.	65488	D3	19.20			
R.H.	65489	D4	19.20			
L.H.	65490	D4	19.20			

ASSA ABLOY

FM-10 The global leader in door opening solutions

Continued on next page

800-346-7707 | www.mckinneyhinge.com
Check the web site for the up-to-date catalog

Steel Standard Weight 2 Knuckle Bearing

Continued...

TA2731
Price Code 20

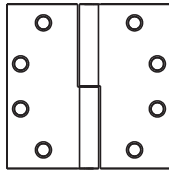

Size	Part Number	Finish	Price Each	Box Qty.	Case Qty.	Case Wgt.
4" x 4" 101.60 mm x 101.60 mm						
R.H.	65513	P	28.53	3	48	39
L.H.	65514	P	28.53			
R.H.	65519	AP	41.78			
L.H.	65520	AP	41.78			
R.H.	65539	3	41.78			
L.H.	65546	3	41.78			
R.H.	65515	4	41.78			
L.H.	65516	4	41.78			
R.H.	65525	10	41.78			
L.H.	65526	10	41.78			
R.H.	65544	10A	41.78			
L.H.	65545	10A	41.78			
R.H.	65543	10B	47.93			
L.H.	65542	10B	47.93			
R.H.	65541	26	41.78			
L.H.	65540	26	41.78			
R.H.	65531	26D	35.56			
L.H.	65532	26D	35.56			
R.H.	65535	D3	41.78			
L.H.	65536	D3	41.78			
R.H.	65537	D4	41.78			
L.H.	65538	D4	41.78			

Size	Part Number	Finish	Price Each	Box Qty.	Case Qty.	Case Wgt.
4 1/2" x 4" 114.30 mm x 101.60 mm						
R.H.	65561	P	24.45	3	48	46
L.H.	65562	P	24.45			
R.H.	65567	AP	34.13			
L.H.	65568	AP	34.13			
R.H.	65591	3	34.13			
L.H.	65590	3	34.13			
R.H.	65563	4	34.13			
L.H.	65564	4	34.13			
R.H.	65573	10	34.13			
L.H.	65574	10	34.13			
R.H.	65559	10A	34.13			
L.H.	65560	10A	34.13			
R.H.	65599	10B	39.15			
L.H.	65598	10B	39.15			
R.H.	65594	26	34.13			
L.H.	65595	26	34.13			
R.H.	65579	26D	27.36			
L.H.	65580	26D	27.36			
R.H.	65585	D3	34.13			
L.H.	65586	D3	34.13			
R.H.	65587	D4	34.13			
L.H.	65588	D4	34.13			

Size	Part Number	Finish	Price Each	Box Qty.	Case Qty.	Case Wgt.
4 1/2" x 4 1/2" 114.30 mm x 114.30 mm						
R.H.	65605	P	24.37	3	48	49
L.H.	65606	P	24.37			
R.H.	65611	AP	36.14			
L.H.	65612	AP	36.14			
R.H.	65632	15	24.41			
L.H.	65631	15	24.41			
R.H.	65607	4	36.14			
L.H.	65608	4	36.14			
R.H.	65617	10	36.14			
L.H.	65618	10	36.14			
R.H.	65640	10A	36.14			
L.H.	65641	10A	36.14			
R.H.	65636	10B	41.46			
L.H.	65635	10B	41.46			
R.H.	65634	26	32.85			
L.H.	65637	26	32.85			
R.H.	65623	26D	24.41			
L.H.	65624	26D	24.41			
R.H.	65627	D3	36.14			
L.H.	65628	D3	36.14			
R.H.	65629	D4	36.14			
L.H.	65630	D4	36.14			

Size	Part Number	Finish	Price Each	Box Qty.	Case Qty.	Case Wgt.
5" x 4" 127 mm x 101.60 mm						
R.H.	65653	P	50.57	3	24	26
L.H.	65654	P	50.57			
R.H.	65659	AP	71.54			
L.H.	65660	AP	71.54			
R.H.	65649	3	71.54			
L.H.	65650	3	71.54			
R.H.	65651	4	71.54			
L.H.	65652	4	71.54			
R.H.	65665	10	71.54			
L.H.	65666	10	71.54			
R.H.	65675	10A	71.54			
L.H.	65676	10A	71.54			
R.H.	65677	10B	82.06			
L.H.	65678	10B	82.06			
R.H.	65667	26	71.54			
L.H.	65668	26	71.54			
R.H.	65671	26D	60.60			
L.H.	65672	26D	60.60			
R.H.	65679	D3	71.54			
L.H.	65680	D3	71.54			
R.H.	65681	D4	71.54			
L.H.	65682	D4	71.54			

Continued on next page

Steel Standard Weight 2 Knuckle Bearing

Continued...

TA2731
Price Code 20

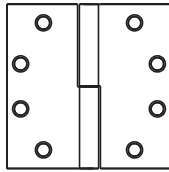

Size	Part Number	Finish	Price Each	Box Qty.	Case Qty.	Case Wgt.
5" x 4 1/2" 127 mm x 114.30 mm						
R.H.	65701	P	55.14	3	24	29
L.H.	65702	P	55.14			
R.H.	65707	AP	66.32			
L.H.	65708	AP	66.32			
R.H.	65703	3	66.32			
L.H.	65704	3	66.32			
R.H.	65705	4	66.32			
L.H.	65706	4	66.32			
R.H.	65713	10	66.32			
L.H.	65714	10	66.32			
R.H.	65733	10A	66.32			
L.H.	65734	10A	66.32			
R.H.	65725	10B	76.08			
L.H.	65726	10B	76.08			
R.H.	65721	26	66.32			
L.H.	65722	26	66.32			
R.H.	65719	26D	60.60			
L.H.	65720	26D	60.60			
R.H.	65729	D3	66.32			
L.H.	65730	D3	66.32			
R.H.	65731	D4	66.32			
L.H.	65732	D4	66.32			

Size	Part Number	Finish	Price Each	Box Qty.	Case Qty.	Case Wgt.
5" x 5" 127 mm x 127 mm						
R.H.	65749	P	67.69	3	24	32
L.H.	65750	P	67.69			
R.H.	65755	AP	76.12			
L.H.	65756	AP	76.12			
R.H.	65743	3	76.12			
L.H.	65744	3	76.12			
R.H.	65745	4	76.12			
L.H.	65746	4	76.12			
R.H.	65761	10	76.12			
L.H.	65762	10	76.12			
R.H.	65771	10A	76.12			
L.H.	65772	10A	76.12			
R.H.	65769	10B	87.32			
L.H.	65770	10B	87.32			
R.H.	65759	26	76.12			
L.H.	65760	26	76.12			
R.H.	65767	26D	71.54			
L.H.	65768	26D	71.54			
R.H.	65773	D3	76.12			
L.H.	65774	D3	76.12			
R.H.	65775	D4	76.12			
L.H.	65776	D4	76.12			

Steel Standard Weight Wide Throw 5 Knuckle Bearing

TA2798
Price Code 50

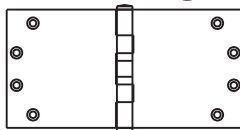

Size	Part Number	Finish	Price Each	Box Qty.	Case Qty.	Case Wgt.
3 1/2" x 5" 88.90 mm x 127 mm						
	65294	P	41.28	3	24	24
	65305	AP	51.80			
	65295	3	51.80			
	65296	4	51.80			
	65299	10	51.80			
	65309	10A	51.80			
	65300	10B	59.41			
	65303	26	51.80			
	65304	26D	46.86			
	3 1/2" x 6" 88.90 mm x 152.4 mm					
	65323	P	43.76	3	24	30
	65334	AP	54.27			
	65324	3	54.27			
	65325	4	54.27			
	65328	10	54.27			
	65337	10A	54.27			
	65329	10B	62.24			
	65332	26	54.27			
65333	26D	49.34				

Size	Part Number	Finish	Price Each	Box Qty.	Case Qty.	Case Wgt.
4" x 6" 101.60 mm x 152.4 mm						
	65346	P	58.19	3	24	34
	65357	AP	70.18			
	65347	3	70.18			
	65348	4	70.18			
	65351	10	70.18			
	65360	10A	70.18			
	65352	10B	80.50			
	65355	26	70.18			
	65356	26D	64.32			
	4" x 7" 101.60 mm x 177.8 mm					
	65378	P	58.19	3	24	36
	65389	AP	70.18			
	65379	3	70.18			
	65380	4	70.18			
	65383	10	70.18			
	65392	10A	70.18			
	65384	10B	80.50			
	65387	26	70.18			
	65388	26D	64.32			
	4 1/2" x 6" 114.30 mm x 152.4 mm					
	59046	P	106.84	3	24	39
	65404	AP	106.84			
	65393	3	106.84			
	65394	4	106.84			
	59054	10	106.84			
	65405	10A	106.84			
	65397	10B	122.56			
	65400	26	106.84			
	59052	26D	87.03			

Continued on next page

ASSA ABLOY

FM-12 The global leader in door opening solutions

800-346-7707 | www.mckinneyhinge.com
Check the web site for the up-to-date catalog

McKinney is a brand associated with Corbin Russwin, Inc., an ASSA ABLOY Group company. Copyright © 2012-2017, Corbin Russwin, Inc. All rights reserved. Reproduction in whole or in part without the express written permission of Corbin Russwin, Inc. is prohibited.

Steel Standard Weight Wide Throw 5 Knuckle Bearing

Continued...

TA2798
Price Code 50

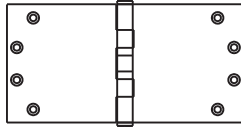

Size	Part Number	Finish	Price Each	Box Qty.	Case Qty.	Case Wgt.
4 1/2" x 7" 101.60 mm x 177.8 mm	59100	P	106.84	3	24	42
	59109	AP	106.84			
	59098	3	106.84			
	59099	4	106.84			
	59103	10	106.84			
	59106	10A	106.84			
	59104	10B	122.56			
	62541	26	106.84			
	62542	26D	95.73			
	62548	P	106.84			
4 1/2" x 8" 114.30 mm x 203.2 mm	62559	AP	106.84	3	24	48
	62549	3	106.84			
	62550	4	106.84			
	62553	10	106.84			
	62562	10A	106.84			
	62554	10B	122.56			
	62557	26	106.84			
	62558	26D	95.73			

Size	Part Number	Finish	Price Each	Box Qty.	Case Qty.	Case Wgt.				
5" x 7" 127 mm x 177.8 mm	59157	P	127.09	3	24	51				
	62583	AP	127.09							
	62573	3	127.09							
	62574	4	127.09							
	62577	10	127.09							
	62586	10A	127.09							
	62578	10B	145.79							
	62581	26	127.09							
	62582	26D	116.00							
	5" x 8" 127 mm x 203.2 mm	62604	P				127.09	3	24	58
		62615	AP				127.09			
		62605	3				127.09			
		62606	4				127.09			
		62609	10				127.09			
62618		10A	127.09							
62610		10B	145.79							
62613		26	127.09							
62614		26D	116.00							

Steel Standard Weight Swing Clear 5 Knuckle Bearing

TA2895
Price Code 50

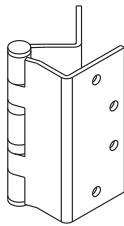

Size	Part Number	Finish	Price Each	Box Qty.	Case Qty.	Case Wgt.
4 1/2" 114.30 mm	57000	P	143.79	3	24	38
	57001	AP	143.79			
	57008	3	143.79			
	57002	4	130.72			
	57003	10	143.79			
	56999	10A	143.79			
	57004	10B	149.95			
	57011	26	118.84			
	57006	26D	67.19			
	57030	26D	73.59			
5" 127 mm	57030	26D	73.59	3	24	40

Steel Standard Weight Swing Clear 5 Knuckle Bearing For Beveled Edge Doors

TA4895
Price Code 50

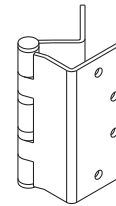

Size	Part Number	Finish	Price Each	Box Qty.	Case Qty.	Case Wgt.
4 1/2" 114.30 mm	57040	P	No.Ma	3	24	38
	57048	AP	143.79			
	57044	3	143.79			
	57042	4	143.79			
	57043	10	143.79			
	57047	10A	143.79			
	57046	10B	164.95			
	57045	26	118.84			
	57041	26D	67.19			
	5" 127 mm	57049	26D			

Hinges are NRP, reversible and non-handed.

Custom Hinges to fit REDIFRAME

Price Code 50

Part No.	Description	Price Each
MK57006SP	SPL 4 1/2 TA2895 26D REDIFRAME	67.85
MK57041SP	SPL 4 1/2 TA4895 26D REDIFRAME	67.85

800-346-7707 | www.mckinneyhinge.com

Check the web site for the up-to-date catalog

McKinney is a brand associated with Corbin Russwin, Inc., an ASSA ABLOY Group company. Copyright © 2012-2017, Corbin Russwin, Inc. All rights reserved. Reproduction in whole or in part without the express written permission of Corbin Russwin, Inc. is prohibited.

ASSA ABLOY

The global leader in door opening solutions

Non-Ferrous Standard Weight 2 Knuckle Bearing

TA3331

Price Code 20

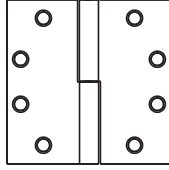

Size	Part Number	Finish	Price Each	Box Qty.	Case Qty.	Case Wgt.
3 1/2" x 3 1/2" 88.90 mm x 88.90 mm						
R.H.	66205	32D	77.89	3	48	33
L.H.	66206	32D	77.89			
4" x 4" 101.60 mm x 101.60 mm						
R.H.	70270	32D	85.21	3	48	46
L.H.	70271	32D	85.21			
4 1/2" x 4" 114.30 mm x 101.60 mm						
R.H.	66297	32D	103.18	3	48	53
L.H.	66298	32D	103.18			
4 1/2" x 4 1/2" 114.30 mm x 114.30 mm						
R.H.	66335	32D	91.69	3	48	57
L.H.	66336	32D	91.69			

Size	Part Number	Finish	Price Each	Box Qty.	Case Qty.	Case Wgt.
5" x 4" 127 mm x 101.60 mm						
R.H.	66383	32D	126.18	3	24	33
L.H.	66384	32D	126.18			
5" x 4 1/2" 127 mm x 114.30 mm						
R.H.	66425	32D	126.18	3	24	36
L.H.	66426	32D	126.18			
5" x 5" 127 mm x 127 mm						
R.H.	66467	32D	147.68	3	24	38
L.H.	66468	32D	147.68			

Non-Ferrous Heavy Weight 2 Knuckle Bearing

TA3350

Price Code 20

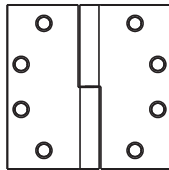

Size	Part Number	Finish	Price Each	Box Qty.	Case Qty.	Case Wgt.
4 1/2" x 4 1/2" 114.30 mm x 114.30 mm						
R.H.	66639	32D	136.06	3	24	37
L.H.	66640	32D	136.06			
5" x 4 1/2" 127 mm x 114.30 mm						
R.H.	66669	32D	180.41	3	24	41
L.H.	66670	32D	180.41			

Size	Part Number	Finish	Price Each	Box Qty.	Case Qty.	Case Wgt.
5" x 5" 127 mm x 127 mm						
R.H.	66695	32D	194.56	3	24	45
L.H.	66696	32D	194.56			

ASSA ABLOY

The global leader in
door opening solutions

Non-Ferrous Heavy Weight 5 Knuckle Bearing

T4A3386
Price Code 50

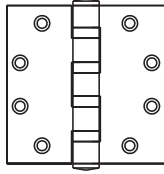

Size	Part Number	Finish	Price Each	Box Qty.	Case Qty.	Case Wgt.
4 1/2" x 4"	61779	32D	80.16	3	24	37
114.30 mm x 101.60 mm						
4 1/2" x 4" (NRP)	61772	32D-NRP	85.16	3	24	37
114.30 mm x 101.60 mm						
<i>Hospital Tip</i>	61773	32D-HT	97.76	3	24	37
4 1/2" x 4 1/2"	61801	P	83.62	3	24	37
114.30 mm x 114.30 mm	61794	3	73.19			
	61790	4	73.19			
	61796	10	80.51			
	61793	10A	88.56			
	61795	10B	83.95			
	61802	26	88.56			
	61804	26D	73.19			
	61791	32	73.19			
	61787	32D	69.11			
	61795E	10BE (SS)	147.37			
	61795S	10B (SS)	76.02			
	61820	32D-HT	85.91			
<i>Hospital Tip</i>	61813	10-NRP	78.19			
4 1/2" x 4 1/2"	61815	10B-NRP	88.95			
114.30 mm x 114.30 mm	61812	26D-NRP	78.59			
(NRP)	61814	32D-NRP	74.11			
5" x 4 1/2"	61879	P	94.15	3	24	43
127 mm x 114.30 mm	70912	3	139.88			
	70913	4	139.88			
	61862	10	127.16			
	61874	10A	139.88			
	61873	10B	132.45			
	61870	26	139.88			
	61866	26D	80.51			
	61903	32	80.51			
	61868	32D	77.36			
<i>Hospital Tip</i>	61868H	32D-HT	94.96			

Size	Part Number	Finish	Price Each	Box Qty.	Case Qty.	Case Wgt.			
5" x 4 1/2"	61863	10-NRP	132.56	3	24	43			
127 mm x 114.30 mm	61861	10B-NRP	137.60						
(NRP)	61869	26D-NRP	85.91						
	61871	32D-NRP	82.51						
5" x 5"	61938	P	145.70	3	24	47			
127 mm x 127 mm	61933	3	153.88						
	61929	4	153.88						
	61935	10	153.88						
	61924	10A	153.88						
	61930	10B	176.52						
	61941	26	153.88						
	61943	26D	153.88						
	61926	32	153.88						
	61928	32D	132.45						
6" x 5"	68832	P	258.13				3	18	43
152.4 mm x 127 mm	68833	3	258.13						
	68834	4	258.13						
	68827	10	258.13						
	68841	10A	258.13						
	68828	10B	296.10						
	68838	26	258.13						
	68839	26D	258.13						
	68823	32	247.03						
	68824	32D	224.40						
6" x 5"	68822	32D-NRP	209.15	3	18	43			
152.4 mm x 127 mm									
(NRP)									

Non-Ferrous Heavy Weight 5 Knuckle Bearing

T4B3386
Price Code 50

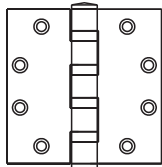

Size	Part Number	Finish	Price Each	Box Qty.	Case Qty.	Case Wgt.
6" x 6"	64612	P	258.13	3	18	74
152.4 mm x 152.4 mm	64613	3	258.13			
	64614	4	258.13			
	64602	10	258.13			
	64620	10A	258.13			
	64607	10B	296.10			
	64617	26	258.13			
	64618	26D	258.13			
	64603	32	258.13			
	64604	32D	247.03			

T6B3386
Price Code 50

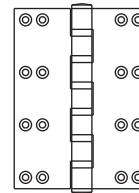

Size	Part Number	Finish	Price Each	Box Qty.	Case Qty.	Case Wgt.
8" x 8"	69060	32D	403.54	3	12	66
203.2 mm x 203.2 mm	69061	32	414.47			

800-346-7707 | www.mckinneyhinge.com
Check the web site for the up-to-date catalog

McKinney is a brand associated with Corbin Russwin, Inc., an ASSA ABLOY Group company. Copyright © 2012-2017, Corbin Russwin, Inc. All rights reserved. Reproduction in whole or in part without the express written permission of Corbin Russwin, Inc. is prohibited.

ASSA ABLOY

The global leader in door opening solutions **FM-15**

Non-Ferrous Heavy Weight 5 Knuckle Bearing

TCA3386
Price Code 50

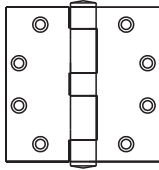

Size	Part Number	Finish	Price Each	Box Qty.	Case Qty.	Case Wgt.
4 1/2" x 4 1/2" 114.30 mm x 114.30 mm	68136	P	121.51	3	24	37
	68138	3	126.45			
	68134	4	126.45			
	68139	10	126.45			
	68140	10A	126.45			
	68141	10B	145.05			
	68142	26	126.45			
	68132	26D	126.45			
	68143	32	126.45			
	68133	32D	121.51			
5" x 4 1/2" 127 mm x 114.30 mm	68156	P	153.86	3	24	43
	68158	3	160.22			
	68154	4	160.22			
	68159	10	160.22			
	68160	10A	160.22			
	68161	10B	183.78			
	68162	26	160.22			
	68152	26D	160.22			
	68163	32	160.22			
	68153	32D	139.87			
5" x 5" 127 mm x 127 mm	68171	P	153.86	3	24	47
	68173	3	160.22			
	68169	4	160.22			
	68174	10	160.22			
	68175	10A	160.22			
	68176	10B	183.78			
	68177	26	160.22			
	68167	26D	160.22			
	68178	32	160.22			
	68168	32D	153.86			
Wide throw not available in TCA Series						

Non-Ferrous Heavy Weight 5 Knuckle Bearing

T4A3386
Price Code 50

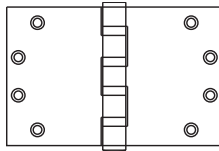

Size	Part Number	Finish	Price Each	Box Qty.	Case Qty.	Case Wgt.
4 1/2" x 5" 114.30 mm x 127 mm	70971	P	313.29	3	24	60
	70973	3	313.29			
	70974	4	313.29			
	70975	10	313.29			
	70976	10A	313.29			
	70977	10B	359.36			
	70978	26	313.29			
	70970	26D	313.29			
	70979	32	313.29			
	70990	32D	302.18			

Continued on next column

Continued...

Size	Part Number	Finish	Price Each	Box Qty.	Case Qty.	Case Wgt.				
4 1/2" x 6" 114.30 mm x 152.4 mm	71052	P	319.09	3	24	60				
	71054	3	319.09							
	71055	4	319.09							
	71056	10	319.09							
	71057	10A	319.09							
	71058	10B	366.01							
	71059	26	319.09							
	71050	26D	319.09							
	71060	32	319.09							
	71051	32D	307.98							
	4 1/2" x 7" 101.60 mm x 177.8 mm	71000	P				329.45	3	24	60
		71001	3				329.45			
71002		4	329.45							
71010		10	329.45							
71017		10A	329.45							
71011		10B	377.89							
71006		26	329.45							
71007		26D	329.45							
71015		32	329.45							
71016		32D	318.34							
4 1/2" x 8" 114.30 mm x 203.2 mm		71087	P	347.56	3	24	60			
		71089	3	347.56						
	71090	4	347.56							
	71091	10	347.56							
	71092	10A	347.56							
	71093	10B	398.67							
	71094	26	347.56							
	71085	26D	347.56							
	71095	32	347.56							
	71086	32D	336.46							
	5" x 6" 127 mm x 152.4 mm	70896	P	347.56				3	24	70
		70898	3	347.56						
70899		4	347.56							
71065		10	347.56							
71066		10A	347.56							
71067		10B	398.67							
71068		26	347.56							
70892		26D	347.56							
71069		32	347.56							
70893		32D	336.46							
5" x 7" 127 mm x 177.8 mm		70902	P	357.39	3	24	70			
		70904	3	357.39						
	70905	4	357.39							
	70906	10	357.39							
	70907	10A	357.39							
	70908	10B	409.95							
	70909	26	357.39							
	70900	26D	357.39							
	70910	32	357.39							
	70901	32D	346.28							
	5" x 8" 127 mm x 203.2 mm	70952	P	366.63				3	24	70
		70954	3	366.63						
70955		4	366.63							
70956		10	366.63							
70957		10A	366.63							
70958		10B	420.55							
70959		26	366.63							
70950		26D	366.63							
70949		32	366.63							
70951		32D	355.52							

ASSA ABLOY

The global leader in door opening solutions

Heavy Weight Stainless Steel Swing Clear

T4A3395

Price Code 50

Hinges are NRP

Size	Part Number	Finish	Price Each	Box Qty.	Case Qty.	Case Wgt.
4 1/2" 114.30 mm	55195	32D	140.51	3	24	59
5" 127 mm	55196	32D	152.26	3	24	59

Steel Heavy Weight 2 Knuckle Bearing

TA3750

Price Code 20

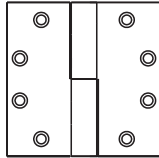

Size	Part Number	Finish	Price Each	Box Qty.	Case Qty.	Case Wgt.
------	-------------	--------	------------	----------	-----------	-----------

4 1/2" x 4 1/2"
114.30 mm x 114.30 mm

R.H.	66523	P	75.34	3	24	37
L.H.	66524	P	75.34			
R.H.	66528	AP	107.12			
L.H.	66527	AP	107.12			
R.H.	66513	3	107.12			
L.H.	66514	3	107.12			
R.H.	66515	4	107.12			
L.H.	66516	4	107.12			
R.H.	66505	10	107.12			
L.H.	66506	10	107.12			
R.H.	66533	10A	107.12			
L.H.	66534	10A	107.12			
R.H.	66532	10B	122.87			
L.H.	66531	10B	122.87			
R.H.	66511	26	107.12			
L.H.	66512	26	107.12			
R.H.	66517	26D	83.16			
L.H.	66518	26D	83.16			

5" x 4 1/2"
127 mm x 114.30 mm

R.H.	66565	P	97.24	3	24	39
L.H.	66566	P	97.24			
R.H.	66569	AP	130.50			
L.H.	66570	AP	130.50			
R.H.	66561	3	130.50			
L.H.	66562	3	130.50			
R.H.	66563	4	130.50			
L.H.	66564	4	130.50			
R.H.	66547	10	130.50			
L.H.	66548	10	130.50			
R.H.	66571	10A	130.50			
L.H.	66572	10A	130.50			
R.H.	66581	10B	149.70			
L.H.	66582	10B	149.70			
R.H.	66553	26	130.50			
L.H.	66554	26	130.50			
R.H.	66559	26D	99.53			
L.H.	66560	26D	99.53			

Size	Part Number	Finish	Price Each	Box Qty.	Case Qty.	Case Wgt.
------	-------------	--------	------------	----------	-----------	-----------

5" x 5"
127 mm x 127 mm

R.H.	66607	P	96.50	3	24	42
L.H.	66608	P	96.50			
R.H.	66623	AP	130.50			
L.H.	66624	AP	130.50			
R.H.	66603	3	130.50			
L.H.	66604	3	130.50			
R.H.	66605	4	130.50			
L.H.	66606	4	130.50			
R.H.	66589	10	130.50			
L.H.	66590	10	130.50			
R.H.	66615	10A	130.50			
L.H.	66616	10A	130.50			
R.H.	66625	10B	149.70			
L.H.	66626	10B	149.70			
R.H.	66595	26	130.50			
L.H.	66596	26	130.50			
R.H.	66601	26D	99.53			
L.H.	66602	26D	99.53			

Steel Heavy Weight 5 Knuckle Bearing

T4A3786
Price Code 50

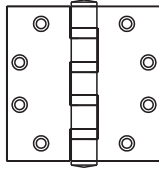

Size	Part Number	Finish	Price Each	Box Qty.	Case Qty.	Case Wgt.				
4 1/2" x 4" 114.30 mm x 101.60 mm	58331	26D	34.15	3	24	35				
	58334	10B	61.05							
4 1/2" x 4" 114.30 mm x 101.60 mm (NRP)	58337	26D-NRP	39.15	3	24	35				
	58375	P	31.34	3	24	35				
4 1/2" x 4 1/2" 114.30 mm x 114.30 mm	58382	AP	43.78							
	58343	3	39.80							
	58344	4	39.80							
	58345	9	48.16							
	58379	10	39.80							
	58367	10A	39.80							
	58346	10B	45.65							
	58346E	10BE	37.21							
	58373	15	34.01							
	58377	26	39.80							
	58384	26D	34.01							
	4 1/2" x 4 1/2" 114.30 mm x 114.30 mm (NRP)	58387	P-NRP				36.34	3	24	35
		58386	10-NRP				45.20			
		58388	26D-NRP	39.01						
5" x 4 1/2" 127 mm x 114.30 mm	58440	P	37.07	3	24	41				
	58447	AP	56.06							
	58444	3	50.96							
	58446	4	50.96							
	58445	10	50.96							
	58453	10A	50.96							
	58464	10B	58.45							
	58464E	10BE	49.68							
	72815	15	38.65							
	58467	26	50.96							
	58443	26D	38.65							

Size	Part Number	Finish	Price Each	Box Qty.	Case Qty.	Case Wgt.
5" x 4 1/2" 127 mm x 114.30 mm (NRP)	58442	P-NRP	42.22	3	24	41
	58449	26D-NRP	43.20			
5" x 5" 127 mm x 127 mm	58520	P	44.86	3	24	55
	58526	AP	71.54			
	58530	3	71.54			
	58527	4	71.54			
	58524	10	59.13			
	58519	10A	71.54			
	58532	10B	67.82			
	58533	15	38.65			
	58538	26	71.54			
	58522	26D	38.65			
6" x 5" 152.4 mm x 127 mm	72783	P	148.68	3	18	42
	72784	AP	148.68			
	72788	3	148.68			
	72789	4	148.68			
	72791	10	148.68			
	72799	10A	148.68			
	72792	10B	170.53			
	72795	26	148.68			
	72796	26D	137.57			
	6" x 6" 152.4 mm x 152.4 mm	58585	P			
58580		AP	148.68			
58596		3	148.68			
58597		4	148.68			
58588		10	148.68			
58594		10A	148.68			
58601		10B	170.53			
58583		26	148.68			
58586		26D	137.57			

Steel Heavy Weight Wide Throw 5 Knuckle Bearing

T4A3786
Price Code 50

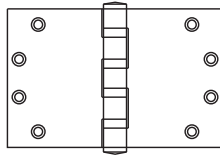

Size	Part Number	Finish	Price Each	Box Qty.	Case Qty.	Case Wgt.
4 1/2" x 5" 114.30 mm x 127 mm	72701	P	159.73	3	24	55
	72702	AP	159.73			
	72703	3	159.73			
	72704	4	159.73			
	72705	10	159.73			
	72706	10A	159.73			
	72707	10B	183.22			
	72708	26	159.73			
	72700	26D	148.62			

Size	Part Number	Finish	Price Each	Box Qty.	Case Qty.	Case Wgt.
4 1/2" x 6" 114.30 mm x 152.4 mm	72729	P	159.73	3	24	55
	72730	AP	159.73			
	72731	3	159.73			
	72732	4	159.73			
	72733	10	159.73			
	72734	10A	159.73			
	72735	10B	183.22			
	72736	26	159.73			
	72728	26D	148.62			
	4 1/2" x 7" 114.30 mm x 177.8 mm	72755	P			
72756		AP	159.73			
72757		3	159.73			
72758		4	159.73			
72759		10	159.73			
72760		10A	159.73			
72761		10B	183.22			
72762		26	159.73			
72754		26D	148.62			

Continued on next page

ASSA ABLOY

FM-18 The global leader in door opening solutions

800-346-7707 | www.mckinneyhinge.com
Check the web site for the up-to-date catalog

McKinney is a brand associated with Corbin Russwin, Inc., an ASSA ABLOY Group company. Copyright © 2012-2017, Corbin Russwin, Inc. All rights reserved. Reproduction in whole or in part without the express written permission of Corbin Russwin, Inc. is prohibited.

Steel Heavy Weight Wide Throw 5 Knuckle Bearing

Continued...

T4A3786
Price Code 50

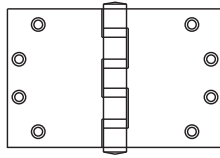

Size	Part Number	Finish	Price Each	Box Qty.	Case Qty.	Case Wgt.
4 1/2" x 8" 101.60 mm x 203.2 mm	72801	P	159.73	3	24	55
	72802	AP	159.73			
	72803	3	159.73			
	72804	4	159.73			
	72805	10	159.73			
	72806	10A	159.73			
	72807	10B	183.22			
	72808	26	159.73			
	72800	26D	148.62			
	72851	P	163.17			
5" x 6" 127 mm x 152.4 mm	72852	AP	163.17	3	24	64
	72859	3	163.17			
	72853	4	163.17			
	72854	10	163.17			
	72863	10A	163.17			
	72855	10B	187.18			
	72862	26	163.17			
	72857	26D	152.06			

Size	Part Number	Finish	Price Each	Box Qty.	Case Qty.	Case Wgt.
5" x 7" 127 mm x 177.8 mm	72901	P	163.17	3	24	64
	72902	AP	163.17			
	72909	3	163.17			
	72903	4	163.17			
	72904	10	163.17			
	72913	10A	163.17			
	72905	10B	187.18			
	72912	26	163.17			
	72907	26D	152.06			
	72951	P	163.17			
5" x 8" 127 mm x 203.2 mm	72952	AP	163.17	3	24	64
	72959	3	163.17			
	72953	4	163.17			
	72954	10	163.17			
	72963	10A	163.17			
	72955	10B	187.18			
	72962	26	163.17			
	72957	26D	152.06			

Steel Heavy Weight 5 Knuckle Concealed Bearing

TCA3786
Price Code 50

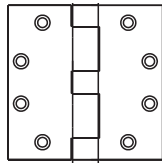

Size	Part Number	Finish	Price Each	Box Qty.	Case Qty.	Case Wgt.
4 1/2" x 4 1/2" 114.30 mm x 114.30 mm	67320	P	64.17	3	24	35
	67321	AP	81.36			
	67328	3	81.36			
	67322	4	81.36			
	67323	10	81.36			
	67333	10A	73.96			
	67324	10B	93.32			
	67331	26	81.36			
	67326	26D	57.56			
	67340	P	74.28			
5" x 4 1/2" 127 mm x 114.30 mm	67341	AP	104.27	3	24	41
	67348	3	104.27			
	67342	4	104.27			
	67343	10	104.27			
	67353	10A	104.27			
	67344	10B	119.59			
	67351	26	104.27			
	67346	26D	65.27			
5" x 5" 127 mm x 127 mm	67360	P	74.28	3	24	43
	67361	AP	104.39			
	67368	3	104.39			
	67362	4	No.Ma			
	67363	10	104.39			
	67359	10A	104.39			
	67364	10B	119.75			
	67371	26	104.39			
67366	26D	78.98				

Steel Heavy Weight 6-Bearing

T6A3786
Price Code 50

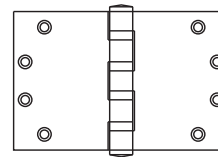

Size	Part Number	Finish	Price Each	Box Qty.	Case Qty.	Case Wgt.
8" x 6" 203.2 mm x 152.4 mm	58629	P	271.57	3	12	49
	58630	AP	271.57			
	58634	3	271.57			
	58635	4	271.57			
	58637	10	271.57			
	58645	10A	271.57			
	58638	10B	311.52			
	58641	26	271.57			
	58642	26D	260.47			

800-346-7707 | www.mckinneyhinge.com

Check the web site for the up-to-date catalog

McKinney is a brand associated with Corbin Russwin, Inc., an ASSA ABLOY Group company. Copyright © 2012-2017, Corbin Russwin, Inc. All rights reserved. Reproduction in whole or in part without the express written permission of Corbin Russwin, Inc. is prohibited.

ASSA ABLOY

The global leader in door opening solutions

Steel Heavy Weight Swing Clear 5 Knuckle Bearing

T4A3795
Price Code 50

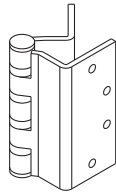

Size	Part Number	Finish	Price Each	Box Qty.	Case Qty.	Case Wgt.
4 1/2" 114.30 mm	73456	P	162.62	3	24	47
	73459	AP	163.39			
	73460	3	163.39			
	73461	4	135.04			
	73462	10	163.39			
	73465	10A	163.39			
	73466	10B	187.43			
	73467	26	163.39			
	73463	26D	80.81			
	5" 127 mm	73469	P			
73470		AP	168.33			
73474		3	139.12			
73475		4	168.33			
73477		10	168.33			
73485		10A	168.33			
73478		10B	193.09			
73481		26	153.03			
73482		26D	80.81			

Steel Swing Clear Heavy Weight Beveled Edge Bearing

T4A4795
Price Code 50

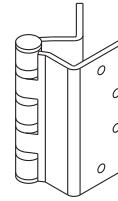

Size	Part Number	Finish	Price Each	Box Qty.	Case Qty.	Case Wgt.
4 1/2" 114.30 mm	73442	P	163.39	3	24	57
	73443	AP	163.39			
	73444	3	163.39			
	73445	4	163.39			
	73446	10	148.54			
	73447	10A	163.39			
	73448	10B	187.43			
	73449	26	148.54			
	73451	26D	80.81			
	5" 127 mm	73591	P			
73593		AP	168.33			
73594		3	168.33			
73595		4	168.33			
73596		10	168.33			
73597		10A	168.33			
73598		10B	193.09			
73599		26	168.33			
73590		26D	80.81			

Hinges are NRP, reversible and non-handed.

MacPro® Hinges Steel Standard Weight 5 Knuckle

MP79
Price Code 57

Size	Part Number	Finish	Price Each	Box Qty.	Case Qty.	Case Wgt.
4 1/2" x 4" 114.30 mm x 101.60 mm	76334	P	1.44	3	48	50
	76310	3	2.71			
	76314	4	1.89			
	76322	10B	2.71			
	76387	15	2.11			
	76326	26	2.71			
	76330	26D	2.11			
	4 1/2" x 4" 114.30 mm x 101.60 mm	76335	P NRP			
76311		3 NRP	3.17			
76315		4 NRP	2.35			
76323		10B NRP	3.17			
76327		26 NRP	3.17			
76331		26D NRP	2.58			

Size	Part Number	Finish	Price Each	Box Qty.	Case Qty.	Case Wgt.				
4 1/2" x 4 1/2" 114.30 mm x 114.30 mm	76368	P	1.41	3	48	54				
	76344	3	2.69							
	76348	4	1.69							
	76356	10B	3.40							
	76364E	10BE	2.63							
	76384	15	2.11							
	76360	26	2.69							
	76364	26D	2.11							
	4 1/2" x 4 1/2" 114.30 mm x 114.30 mm	76369	P NRP				1.86	3	48	54
		76345	3 NRP				3.47			
76349		4 NRP	2.35							
76357		10B NRP	3.98							
76357E		10BE NRP	3.38							
76361		26 NRP	3.47							
76365		26D NRP	2.58							

These hinges are not subject to any other discounts

ASSA ABLOY

FM-20 The global leader in door opening solutions

800-346-7707 | www.mckinneyhinge.com
Check the web site for the up-to-date catalog

McKinney is a brand associated with Corbin Russwin, Inc., an ASSA ABLOY Group company. Copyright © 2012-2017, Corbin Russwin, Inc. All rights reserved. Reproduction in whole or in part without the express written permission of Corbin Russwin, Inc. is prohibited.

MacPro® Steel Standard Weight Five Knuckle Bearing

MPB79

Price Code 57

Size	Part Number	Finish	Price Each	Box Qty.	Case Qty.	Case Wgt.
4 1/2" x 4" 114.30 mm x 101.60 mm	76366	P	2.58	3	48	51
	76342	3	3.85			
	76346	4	3.47			
	76354	10B	3.85			
	76386	15	3.15			
	76358	26	3.85			
	76362	26D	3.47			
4 1/2" x 4" 114.30 mm x 101.60 mm (NRP)	76367	P NRP	3.34	3	48	51
	76343	3 NRP	4.36			
	76347	4 NRP	3.98			
	76355	10B NRP	4.36			
	76359	26 NRP	4.36			
	76363	26D NRP	3.98			

Size	Part Number	Finish	Price Each	Box Qty.	Case Qty.	Case Wgt.
4 1/2" x 4 1/2" 114.30 mm x 114.30 mm	76336	P	2.58	3	48	55
	76312	3	3.98			
	76316	4	3.15			
	76320	10	5.06			
	76324	10B	4.15			
	76324E	10BE	3.08			
	76383	15	3.15			
	76328	26	3.62			
	76332	26D	3.15			
	4 1/2" x 4 1/2" 114.30 mm x 114.30 mm (NRP)	76337	P NRP			
76313		3 NRP	4.49			
76317		4 NRP	3.93			
76325		10B NRP	4.68			
76325E		10BE NRP	3.47			
76329		26 NRP	4.08			
76333		26D NRP	3.62			
76321		10 NRP	5.52			
76396		15 NRP	20.80			

MacPro® Steel Heavy Weight Five Knuckle Bearing

MPB68

Price Code 57

Size	Part Number	Finish	Price Each	Box Qty.	Case Qty.	Case Wgt.
4 1/2" x 4 1/2" 114.30 mm x 114.30 mm	76374	26D	7.78	3	24	35
	76375	26D NRP	8.24			
	76395	15	7.78			
5" x 4 1/2" 127 mm x 114.30 mm	76390	26D	8.89	3	24	39
	76391	26D NRP	10.93			
	76397	15	8.89			

MacPro® Non-Ferrous Heavy Weight Five Knuckle Bearing

MPB99

Price Code 57

Size	Part Number	Finish	Price Each	Box Qty.	Case Qty.	Case Wgt.
4 1/2" x 4 1/2" 114.30 mm x 114.30 mm	76376	32D	16.44	3	24	37
	76377	32D NRP	16.91			
5" x 4 1/2" 127 mm x 114.30 mm	76392	32D	17.90	3	24	41
	76393	32D NRP	19.06			

MacPro® Non-Ferrous Standard Weight Five Knuckle Bearing

MPB91

Price Code 57

Size	Part Number	Finish	Price Each	Box Qty.	Case Qty.	Case Wgt.
4 1/2" x 4 1/2" 114.30 mm x 114.30 mm	76340	32D	9.74	3	48	33
	76341	32D NRP	10.21			

These hinges are not subject to any other discounts

Electric Hinges CC-4

Size	Part Number	Finish	Price Each	Box Qty.
------	-------------	--------	------------	----------

TA2314 - CC4 Price Code 59

4 1/2" x 4" 114.30 mm x 101.60 mm	71218	3	290.33	1
	71219	4	290.33	
	71220	10B	292.65	
	71221	26	290.33	
	71222	26D	285.42	
4 1/2" x 4 1/2" 114.30 mm x 114.30 mm	71179	32D	277.68	1
	71223	3	284.82	
	59817	4	284.82	
	71139	10B	288.45	
	71224	26	289.67	
	71142	26D	281.74	
	56183	32D	277.86	

TA2714 - CC4 Price Code 59

4 1/2" x 4" 114.30 mm x 101.60 mm	55664	P	273.87	1
	71225	AP	256.54	
	71226	3	254.70	
	71227	4	254.70	
	71257	10	254.70	
	71228	10A	254.70	
	55668	10B	257.41	
	55666	26	254.70	
	55669	26D	173.24	
	71230	D3	256.54	
	71231	D4	256.54	
4 1/2" x 4 1/2" 114.30 mm x 114.30 mm	55888	P	248.97	1
	71250	AP	256.54	
	71128	3	254.70	
	55902	4	254.70	
	71110	10	254.70	
	71252	10A	254.70	
	55886	10B	260.41	
	55887	26	254.70	
	55885	26D	145.27	
	71254	D3	256.54	
	71255	D4	254.70	

T4A3386 - CC4 Price Code 59

4 1/2" x 4 1/2" 114.30 mm x 114.30 mm	71260	3	309.49	1
	71261	4	309.49	
	71262	10B	320.25	
	71263	26	316.81	
	71106	26D	309.49	
	71167	32D	305.41	
5" x 4 1/2" 127 mm x 114.30 mm	71265	26D	309.49	1
	71210	32D	309.49	

T4A3786 - CC4 Price Code 59

4 1/2" x 4 1/2" 114.30 mm x 114.30 mm	71378	P	267.64	1
	71269	AP	280.08	
	71270	3	276.10	
	71271	4	276.10	
	71272	10	276.10	
	71273	10A	276.10	
	71274	10B	281.95	
	71275	26	276.10	
	71118	26D	163.15	
	71277	D3	280.08	
	71278	D4	280.08	

Size	Part Number	Finish	Price Each	Box Qty.
------	-------------	--------	------------	----------

T4A3786 - CC4 Price Code 59

5" x 4 1/2" 127 mm x 114.30 mm	71280	P	273.37	1
	71136	26D	173.87	

Swing Clear Hinges

TA2895, TA4895, T4A3795, T4A4795

Price Code 59

4 1/2" 114.30 mm	TA2895	73650	26D	319.99	1
	TA4895	73657	26D	319.99	
	T4A3795	73664	26D	333.51	
	T4A4795	73671	26D	333.61	

T4A3795, T4A4795 Price Code 59

5" 127 mm	T4A3795	73678	26D	333.61	1
	T4A4795	73685	26D	333.61	

Electric Hinges CC-6

TA2314 - CC6 Price Code 59

4 1/2" x 4" 114.30 mm x 101.60 mm	71285	3	303.28	1
	71286	4	303.28	
	71287	10B	305.60	
	71288	26	303.28	
	71289	26D	298.37	
4 1/2" x 4 1/2" 114.30 mm x 114.30 mm	71163	32D	290.63	1
	71292	3	297.77	
	71293	4	297.77	
	71294	10B	301.40	
	71295	26	302.62	
	71296	26D	294.71	
	71159	32D	290.63	

TA2714 - CC6 Price Code 59

4 1/2" x 4" 114.30 mm x 101.60 mm	71300	P	261.92	1
	71301	AP	269.49	
	71302	3	267.65	
	71303	4	267.65	
	71304	10	267.65	
	71305	10A	267.65	
	71306	10B	270.46	
	71307	26	267.65	
	71308	26D	264.93	
	71310	D3	269.49	
	71311	D4	269.49	
4 1/2" x 4 1/2" 114.30 mm x 114.30 mm	71205	P	261.92	1
	71314	AP	269.49	
	71200	3	267.65	
	71201	4	267.65	
	71202	10	267.65	
	71313	10A	267.65	
	71203	10B	273.36	
	71204	26	267.65	
	71120	26D	159.86	
	71316	D3	269.49	
	71317	D4	269.49	

ASSA ABLOY

The global leader in
door opening solutions

Electric Hinges CC-6

Size	Part Number	Finish	Price Each	Box Qty.
------	-------------	--------	------------	----------

T4A3386 - CC6 Price Code 59

4 1/2" x 4 1/2" 114.30 mm x 114.30 mm	71320	3	322.44	1
	71321	4	322.44	
	71322	10B	333.20	
	71323	26	329.76	
	71174	26D	322.44	
	71208	32D	318.36	
5" x 4 1/2" 127 mm x 114.30 mm	71326	26D	322.44	1
	71211	32D	322.44	

T4A3786 - CC6 Price Code 59

4 1/2" x 4 1/2" 114.30 mm x 114.30 mm	71330	P	280.59	1		
	71331	AP	293.03			
	71332	3	293.03			
	71333	4	289.05			
	71334	10	289.05			
	71335	10A	289.05			
	71336	10B	294.90			
	71337	26	289.05			
	71173	26D	283.26			
	71339	D3	293.03			
	71340	D4	293.03			
	5" x 4 1/2" 127 mm x 114.30 mm	71342	P		286.32	1
		71343	26D		287.90	

Swing Clear Hinges

TA2895, TA4895, T4A3795, T4A4795

Price Code 59

4 1/2" 114.30 mm	TA2895	73651	26D	332.94	1
	TA4895	73658	26D	332.94	
	T4A3795	73665	26D	346.56	
	T4A4795	73672	26D	346.56	

T4A3795, T4A4795 Price Code 59

5" 127 mm	T4A3795	73679	26D	346.56	1
	T4A4795	73686	26D	346.56	

Electric Hinges CC-8

TA2314 - CC8 Price Code 59

4 1/2" x 4" 114.30 mm x 101.60 mm	71450	3	328.28	1
	71451	4	328.28	
	71452	10B	330.60	
	71453	26	328.28	
	71454	26D	323.37	
	71165	32D	315.63	
4 1/2" x 4 1/2" 114.30 mm x 114.30 mm	71456	3	322.77	1
	71457	4	322.77	
	71458	10B	326.40	
	71459	26	327.62	
	56184	26D	319.71	
	71161	32D	315.63	

Electric Hinges CC-8

Size	Part Number	Finish	Price Each	Box Qty.
------	-------------	--------	------------	----------

TA2714 - CC8 Price Code 59

4 1/2" x 4" 114.30 mm x 101.60 mm	71461	P	286.92	1		
	71462	AP	294.49			
	71463	3	292.65			
	71464	4	292.65			
	71465	10	292.65			
	71466	10A	292.65			
	71467	10B	295.36			
	71468	26	292.65			
	71469	26D	171.83			
	71471	D3	294.49			
	71472	D4	294.49			
	4 1/2" x 4 1/2" 114.30 mm x 114.30 mm	55906	P		286.92	1
		71474	AP		294.49	
71475		3	292.65			
71476		4	292.65			
71477		10	292.35			
71478		10A	292.65			
71479		10B	312.16			
71480		26	292.65			
55904		26D	171.83			
71482		D3	294.49			
71483		D4	292.65			

T4A3386 - CC8 Price Code 59

4 1/2" x 4 1/2" 114.30 mm x 114.30 mm	71485	3	347.44	1
	71486	4	347.44	
	71487	10B	358.20	
	71488	26	354.76	
	71168	26D	347.44	
5" x 4 1/2" 127 mm x 114.30 mm	71169	32D	343.36	1
	71490	26D	347.44	
	71212	32D	347.44	

T4A3786 - CC8 Price Code 59

4 1/2" x 4 1/2" 114.30 mm x 114.30 mm	71492	P	305.59	1		
	71493	AP	318.03			
	71494	3	314.05			
	71495	4	314.05			
	71496	10	314.05			
	71497	10A	314.05			
	71498	10B	319.90			
	71499	26	314.05			
	71166	26D	190.59			
	71506	D3	318.03			
	71507	D4	318.03			
	5" x 4 1/2" 127 mm x 114.30 mm	71508	26D		209.40	1

Swing Clear Hinges

TA2895, TA4895, T4A3795, T4A4795

Price Code 59

4 1/2" 114.30 mm	TA2895	73652	26D	357.94	1
	TA4895	73659	26D	357.94	
	T4A3795	73666	26D	371.56	
	T4A4795	73673	26D	371.56	

T4A3795, T4A4795 Price Code 59

5" 127 mm	T4A3795	73680	26D	371.56	1
	T4A4795	73687	26D	371.56	

Electric Hinges QC-2

Size	Part Number	Finish	Price Each	Box Qty.
------	-------------	--------	------------	----------

TA2314 - QC2 Price Code 59

4 1/2" x 4" 114.30 mm x 101.60 mm	73100	3	278.33	1
	73101	4	278.33	
	73102	10B	280.65	
	73103	26	278.33	
	73104	26D	273.42	
	73105	32D	265.68	
4 1/2" x 4 1/2" 114.30 mm x 114.30 mm	73106	3	272.82	1
	73107	4	272.82	
	73108	10B	276.45	
	73109	26	272.82	
	73110	26D	269.76	
	73111	32D	265.68	

TA2714 - QC2 Price Code 59

4 1/2" x 4" 114.30 mm x 101.60 mm	73112	P	236.97	1		
	73113	AP	244.54			
	73114	3	242.70			
	73115	4	242.70			
	73116	10	242.70			
	73117	10A	242.70			
	73118	10B	245.51			
	73119	26	242.70			
	73120	26D	239.98			
	73122	D3	244.54			
	73123	D4	244.54			
	4 1/2" x 4 1/2" 114.30 mm x 114.30 mm	73124	P		236.97	1
		73125	AP		244.54	
		73126	3		242.70	
73127		4	242.70			
73128		10	242.70			
73129		10A	242.70			
73130		10B	248.41			
73131		26	242.70			
73132		26D	239.23			
73134		D3	244.54			
73135		D4	244.54			

T4A3386 - QC2 Price Code 59

4 1/2" x 4 1/2" 114.30 mm x 114.30 mm	73136	3	297.49	1
	73137	4	297.49	
	73138	10B	308.25	
	73139	26	304.81	
	73140	26D	297.49	
	73141	32D	293.41	
5" x 4 1/2" 127 mm x 114.30 mm	73142	26D	297.49	1
	73143	32D	297.49	

T4A3786 - QC2 Price Code 59

4 1/2" x 4 1/2" 114.30 mm x 114.30 mm	73144	P	255.64	1
	73145	AP	268.08	
	73146	3	264.10	
	73147	4	264.10	
	73148	10	264.10	
	73149	10A	264.10	
	73150	10B	269.95	
	73151	26	264.10	
	73152	26D	258.31	
	73154	D3	268.08	
	73155	D4	268.08	

Electric Hinges QC-2

Size	Part Number	Finish	Price Each	Box Qty.
------	-------------	--------	------------	----------

T4A3786 - QC2 Price Code 59

5" x 4 1/2" 127 mm x 114.30 mm	73156	P	261.37	1
	73157	26D	262.95	

Swing Clear Hinges

TA2895, TA4895, T4A3795, T4A4795

Price Code 59

4 1/2" 114.30 mm	TA2895	73653	26D	307.99	1
	TA4895	73660	26D	307.99	
	T4A3795	73667	26D	321.61	
	T4A4795	73674	26D	321.61	

T4A3795, T4A4795 Price Code 59

5" 127 mm	T4A3795	73681	26D	321.61	1
	T4A4795	73688	26D	321.61	

Electric Hinges QC-4

TA2314 - QC4 Price Code 59

4 1/2" x 4" 114.30 mm x 101.60 mm	73160	3	315.83	1
	73161	4	315.83	
	73162	10B	318.15	
	73163	26	315.83	
	73164	26D	310.92	
	73165	32D	303.18	
4 1/2" x 4 1/2" 114.30 mm x 114.30 mm	73166	3	310.32	1
	73167	4	310.32	
	73168	10B	313.95	
	73169	26	315.17	
	73170	26D	307.26	
	73171	32D	303.18	

TA2714 - QC4 Price Code 59

4 1/2" x 4" 114.30 mm x 101.60 mm	73172	P	274.47	1		
	73173	AP	282.04			
	73174	3	280.20			
	73175	4	280.20			
	73176	10	280.20			
	73177	10A	280.20			
	73178	10B	282.91			
	73179	26	280.20			
	73180	26D	277.48			
	73182	D3	282.04			
	73183	D4	282.04			
	4 1/2" x 4 1/2" 114.30 mm x 114.30 mm	73184	P		274.47	1
		73185	AP		282.04	
		73186	3		280.20	
73187		4	280.20			
73188		10	280.20			
73189		10A	280.20			
73190		10B	285.91			
73191		26	280.20			
73192		26D	183.84			
73194		D3	282.04			
73195	D4	282.04				

ASSA ABLOY

EH-3

The global leader in door opening solutions

McKinney is a brand associated with Corbin Russwin, Inc., an ASSA ABLOY Group company. Copyright © 2012-2017, Corbin Russwin, Inc. All rights reserved. Reproduction in whole or in part without the express written permission of Corbin Russwin, Inc. is prohibited.

800-346-7707 | www.mckinneyhinge.com
Check the web site for the up-to-date catalog

Electric Hinges QC-4

Size	Part Number	Finish	Price Each	Box Qty.
------	-------------	--------	------------	----------

T4A3386 - QC4 Price Code 59

Size	Part Number	Finish	Price Each	Box Qty.
4 1/2" x 4 1/2" 114.30 mm x 114.30 mm	73200	3	334.99	1
	73201	4	334.99	
	73202	10B	345.75	
	73203	26	342.31	
	73204	26D	334.99	
5" x 4 1/2" 127 mm x 114.30 mm	73205	32D	330.91	1
	73206	26D	334.99	
	73207	32D	334.99	

T4A3786 - QC4 Price Code 59

Size	Part Number	Finish	Price Each	Box Qty.		
4 1/2" x 4 1/2" 114.30 mm x 114.30 mm	73208	P	293.14	1		
	73209	AP	305.58			
	73210	3	301.60			
	73211	4	301.60			
	73212	10	301.60			
	73213	10A	301.60			
	73214	10B	307.45			
	73215	26	301.60			
	73216	26D	232.62			
	73218	D3	305.58			
	73219	D4	305.58			
	5" x 4 1/2" 127 mm x 114.30 mm	73220	P		298.87	1
		73221	26D		261.31	

Swing Clear Hinges

TA2895, TA4895, T4A3795, T4A4795

Price Code 59

Size	Part Number	Finish	Price Each	Box Qty.	
4 1/2" 114.30 mm	TA2895	73654	26D	345.49	1
	TA4895	73661	26D	345.49	
	T4A3795	73668	26D	359.11	
	T4A4795	73675	26D	359.11	

T4A3795, T4A4795 Price Code 59

Size	Part Number	Finish	Price Each	Box Qty.	
5" 127 mm	T4A3795	73682	26D	359.11	1
	T4A4795	73689	26D	359.11	

Electric Hinges QC-6

TA2314 - QC6 Price Code 59

Size	Part Number	Finish	Price Each	Box Qty.
4 1/2" x 4" 114.30 mm x 101.60 mm	73222	3	328.33	1
	73223	4	328.33	
	73224	10B	330.65	
	73225	26	330.65	
	73226	26D	323.42	
	73227	32D	315.68	
4 1/2" x 4 1/2" 114.30 mm x 114.30 mm	73228	3	322.82	1
	73229	4	322.82	
	73230	10B	326.45	
	73231	26	327.67	
	73232	26D	319.76	
	73233	32D	315.68	

Electric Hinges QC-6

Size	Part Number	Finish	Price Each	Box Qty.
------	-------------	--------	------------	----------

TA2714 - QC6 Price Code 59

Size	Part Number	Finish	Price Each	Box Qty.		
4 1/2" x 4" 114.30 mm x 101.60 mm	73234	P	286.97	1		
	73235	AP	294.54			
	73236	3	292.70			
	73237	4	292.70			
	73238	10	292.70			
	73239	10A	292.70			
	73240	10B	295.41			
	73241	26	292.70			
	73242	26D	289.98			
	73244	D3	294.54			
	73245	D4	294.54			
	4 1/2" x 4 1/2" 114.30 mm x 114.30 mm	73246	P		286.97	1
		73247	AP		294.54	
73248		3	292.70			
73249		4	292.70			
73250		10	292.70			
73251		10A	292.70			
73252		10B	298.41			
73253		26	292.70			
73254		26D	198.55			
73256		D3	294.54			
73257		D4	294.54			

T4A3386 - QC6 Price Code 59

Size	Part Number	Finish	Price Each	Box Qty.
4 1/2" x 4 1/2" 114.30 mm x 114.30 mm	73258	3	347.49	1
	73259	4	347.49	
	73260	10B	358.25	
	73261	26	354.81	
	73262	26D	347.49	
5" x 4 1/2" 127 mm x 114.30 mm	73263	32D	343.41	1
	73264	26D	347.49	
	73265	32D	347.49	

T4A3786 - QC6 Price Code 59

Size	Part Number	Finish	Price Each	Box Qty.		
4 1/2" x 4 1/2" 114.30 mm x 114.30 mm	73266	P	305.64	1		
	73267	AP	318.08			
	73268	3	314.10			
	73269	4	314.10			
	73270	10	314.10			
	73271	10A	314.10			
	73272	10B	319.95			
	73273	26	314.10			
	73274	26D	218.56			
	73276	D3	318.08			
	73277	D4	318.08			
	5" x 4 1/2" 127 mm x 114.30 mm	73278	P		311.37	1
		73279	26D		294.34	

Swing Clear Hinges

TA2895, TA4895, T4A3795, T4A4795

Price Code 59

Size	Part Number	Finish	Price Each	Box Qty.	
4 1/2" 114.30 mm	TA2895	73655	26D	357.99	1
	TA4895	73662	26D	357.99	
	T4A3795	73669	26D	371.61	
	T4A4795	73676	26D	371.61	

Electric Hinges QC-6

Size	Part Number	Finish	Price Each	Box Qty.
------	-------------	--------	------------	----------

Swing Clear Hinges

T4A3795, T4A4795 Price Code 59

5" 127 mm	T4A3795	73683	26D	371.61	1
	T4A4795	73690	26D	371.61	

Electric Hinges QC-8

TA2314 - QC8 Price Code 59

4 1/2" x 4" 114.30 mm x 101.60 mm	73280	3	353.23	1
	73281	4	353.23	
	73282	10B	355.55	
	73283	26	353.23	
	73284	26D	348.32	
	73285	32D	340.58	
4 1/2" x 4 1/2" 114.30 mm x 114.30 mm	73286	3	347.72	1
	73287	4	347.72	
	73288	10B	351.35	
	73289	26	352.57	
	73290	26D	344.66	
	73291	32D	340.58	

TA2714 - QC8 Price Code 59

4 1/2" x 4" 114.30 mm x 101.60 mm	73292	P	311.87	1	
	73293	AP	319.44		
	73294	3	317.60		
	73295	4	317.60		
	73296	10	317.60		
	73297	10A	317.60		
	73298	10B	320.31		
	73299	26	317.60		
	73300	26D	314.88		
	73302	D3	319.44		
	73303	D4	319.44		
4 1/2" x 4 1/2" 114.30 mm x 114.30 mm	73304	P	311.87		1
	73305	AP	319.44		
	73306	3	317.60		
	73307	4	317.60		
	73308	10	317.60		
	73309	10A	317.60		
	73310	10B	323.31		
	73311	26	317.60		
	73312	26D	212.17		
	73314	D3	319.44		
	73315	D4	319.44		

T4A3386 - QC8 Price Code 59

4 1/2" x 4 1/2" 114.30 mm x 114.30 mm	73316	3	372.39	1
	73317	4	372.39	
	73318	10B	383.15	
	73319	26	379.71	
	73320	26D	372.39	
	73321	32D	368.31	
5" x 4 1/2" 127 mm x 114.30 mm	73322	26D	372.39	1
	73323	32D	372.39	

Electric Hinges QC-8

Size	Part Number	Finish	Price Each	Box Qty.
------	-------------	--------	------------	----------

T4A3786 - QC8 Price Code 59

4 1/2" x 4 1/2" 114.30 mm x 114.30 mm	73324	P	330.54	1	
	73325	AP	342.98		
	73326	3	339.00		
	73327	4	339.00		
	73328	10	339.00		
	73329	10A	339.00		
	73330	10B	344.85		
	73331	26	339.00		
	73332	26D	215.15		
	73334	D3	342.98		
	73335	D4	342.98		
5" x 4 1/2" 127 mm x 114.30 mm	73336	26D	313.75		1
	73337	P	336.27		

Swing Clear Hinges

TA2895, TA4895, T4A3795, T4A4795

Price Code 59

4 1/2" 114.30 mm	TA2895	73656	26D	382.89	1
	TA4895	73663	26D	382.89	
	T4A3795	73670	26D	396.51	
	T4A4795	73677	26D	396.51	

T4A3795, T4A4795 Price Code 59

5" 127 mm	T4A3795	73684	26D	396.51	1
	T4A4795	73691	26D	396.51	

Electric Hinges QC-10

TA2314 - QC10 Price Code 59

4 1/2" x 4" 114.30 mm x 101.60 mm	73900	3	390.63	1
	73901	4	390.63	
	73902	10B	392.95	
	73903	26	390.63	
	73904	26D	385.72	
	73905	32D	377.98	
4 1/2" x 4 1/2" 114.30 mm x 114.30 mm	73906	3	385.12	1
	73907	4	385.12	
	73908	10B	388.75	
	73909	26	389.97	
	73910	26D	382.06	
	73911	32D	377.98	

TA2714 - QC10 Price Code 59

4 1/2" x 4" 114.30 mm x 101.60 mm	73912	P	349.27	1
	73913	AP	356.84	
	73914	3	355.00	
	73915	4	355.00	
	73916	10	355.00	
	73917	10A	355.00	
	73918	10B	357.71	
	73919	26	355.00	
	73920	26D	352.28	
	73922	D3	356.84	
	73923	D4	356.84	

ASSA ABLOY

EH-5 The global leader in door opening solutions

800-346-7707 | www.mckinneyhinge.com

Check the web site for the up-to-date catalog

McKinney is a brand associated with Corbin Russwin, Inc., an ASSA ABLOY Group company. Copyright © 2012-2017, Corbin Russwin, Inc. All rights reserved. Reproduction in whole or in part without the express written permission of Corbin Russwin, Inc. is prohibited.

Electric Hinges QC-10

Size	Part Number	Finish	Price Each	Box Qty.
------	-------------	--------	------------	----------

TA2714 - QC10 Price Code 59

4 1/2" x 4 1/2" 114.30 mm x 114.30 mm	73924	P	349.27	1
	73925	AP	356.84	
	73926	3	355.00	
	73927	4	355.00	
	73928	10	355.00	
	73929	10A	355.00	
	73930	10B	360.71	
	73931	26	355.00	
	73932	26D	351.53	
	73934	D3	356.84	
73935	D4	355.00		

T4A3386 - QC10 Price Code 59

4 1/2" x 4 1/2" 114.30 mm x 114.30 mm	73936	3	409.79	1
	73937	4	409.79	
	73938	10B	420.55	
	73939	26	417.11	
	73940	26D	409.79	
	73941	32D	405.71	
5" x 4 1/2" 127 mm x 114.30 mm	73942	26D	No.Ma	1
	73943	32D	415.18	

T4A3786 - QC10 Price Code 59

4 1/2" x 4 1/2" 114.30 mm x 114.30 mm	73944	P	422.32	1		
	73945	AP	422.32			
	73946	3	425.95			
	73947	4	427.17			
	73948	10	419.26			
	73949	10A	415.18			
	73950	10B	386.47			
	73951	26	394.04			
	73952	26D	392.20			
	73954	D3	392.20			
	73955	D4	392.20			
	5" x 4 1/2" 127 mm x 114.30 mm	73956	P		394.91	1
		73957	26D		392.20	

Electric Hinges QC-12

TA2314 - QC12 Price Code 59

4 1/2" x 4" 114.30 mm x 101.60 mm	73338	3	427.83	1		
	73339	4	427.83			
	73340	10B	430.15			
	73341	26	427.83			
	73342	26D	422.92			
	73343	32D	415.18			
	4 1/2" x 4 1/2" 114.30 mm x 114.30 mm	73344	3		422.32	1
		73345	4		422.32	
73346		10B	425.95			
73347		26	427.17			
73348		26D	419.26			
73349		32D	415.18			

Electric Hinges QC-12

Size	Part Number	Finish	Price Each	Box Qty.
------	-------------	--------	------------	----------

TA2714 - QC12 Price Code 59

4 1/2" x 4" 114.30 mm x 101.60 mm	73350	P	386.47	1
	73351	AP	394.04	
	73352	3	392.20	
	73353	4	392.20	
	73354	10	392.20	
	73355	10A	392.20	
	73356	10B	394.91	
	73357	26	392.20	
	73358	26D	347.21	
	73360	D3	394.04	
4 1/2" x 4 1/2" 114.30 mm x 114.30 mm	73361	D4	394.04	1
	73362	P	386.47	
	73363	AP	394.04	
	73364	3	392.20	
	73365	4	392.20	
	73366	10	392.20	
	73367	10A	392.20	
	73368	10B	397.91	
	73369	26	392.20	
	73370	26D	242.12	
	73372	D3	394.04	
73373	D4	394.04		

T4A3386 - QC12 Price Code 59

4 1/2" x 4 1/2" 114.30 mm x 114.30 mm	73374	3	446.99	1
	73375	4	446.99	
	73376	10B	457.75	
	73377	26	454.31	
	73378	26D	446.99	
	73379	32D	442.91	
5" x 4 1/2" 127 mm x 114.30 mm	73380	26D	446.99	1
	73381	32D	446.99	

T4A3786 - QC12 Price Code 59

4 1/2" x 4 1/2" 114.30 mm x 114.30 mm	73382	P	405.14	1		
	73383	AP	417.58			
	73384	3	413.60			
	73385	4	413.60			
	73386	10	413.60			
	73387	10A	413.60			
	73388	10B	419.45			
	73389	26	413.60			
	73390	26D	407.81			
	73392	D3	417.58			
	73393	D4	417.58			
	5" x 4 1/2" 127 mm x 114.30 mm	73395	P		410.87	1
		73394	26D		412.45	

MacPro® Electric Hinges - Concealed Circuit (CC)

Price Code 57

Product	Size	Part Number	Finish	Price Each	Box Qty.
MPB79-CC4	4 1/2" x 4"	76400	26D	46.81	1
MPB79-CC8	114.30 mm x 101.60 mm	76402	26D	58.19	1
MPB79-CC4	4 1/2" x 4 1/2"	76405	26D	46.81	1
MPB79-CC8	114.30 mm x 114.30 mm	76407	26D	58.19	1
MPB68-CC4	4 1/2" x 4 1/2"	76410	26D	55.84	1
MPB68-CC8	114.30 mm x 114.30 mm	76412	26D	57.29	1

MacPro® Electric Hinges - ElectroLynx® Quick Connect (QC)

Price Code 57

Product	Size	Part Number	Finish	Price Each	Box Qty.
MPB79-QC4	4 1/2" x 4"	76401	26D	54.49	1
MPB79-QC8	114.30 mm x 101.60 mm	76403	26D	72.71	1
MPB79-QC12		76404	26D	73.84	1
MPB79-QC4	4 1/2" x 4 1/2"	76406	26D	54.49	1
MPB79-QC8	114.30 mm x 114.30 mm	76408	26D	72.71	1
MPB79-QC12		76409	26D	73.84	1
MPB68-QC4	4 1/2" x 4 1/2"	76411	26D	72.02	1
MPB68-QC8	114.30 mm x 114.30 mm	76413	26D	73.02	1
MPB68-QC12		76414	26D	115.70	1

As part of their promise to provide innovative, fast and effective high security solutions to their customers, certain ASSA ABLOY Group brands offer ElectroLynx®, a universal quick-connect system that simplifies the electrification of the door opening.

ElectroLynx® is a registered trademark of ASSA ABLOY Inc.

ASSA ABLOY

The global leader in
door opening solutions

800-346-7707 | www.mckinneyhinge.com
Check the web site for the up-to-date catalog

McKinney is a brand associated with Corbin Russwin, Inc., an ASSA ABLOY Group company. Copyright © 2012-2017, Corbin Russwin, Inc. All rights reserved. Reproduction in whole or in part without the express written permission of Corbin Russwin, Inc. is prohibited.

Transfer Device Solutions

McKinney ElectroLynx® Harnesses & Components For Metal Doors

CORBIN RUSSWIN, SARGENT, and YALE Price Code 79

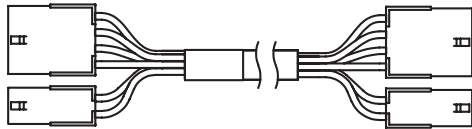

If metal door, order a retrofit cable with Molex connectors on both ends.
 If the metal door is polystyrene filled or steel stiffened, the cable may need to be routed up and over the door.

PART #	McKinney Catalog #	Description:	Net Price	Max Hinge required (Not included)
3", 6" & 12" Harness				
Between hinge and the end of an exit device				
93981	QC-C003	QC12 - 3" Wire Harness; 8 & 4 Pin Connector w/12 wires (For Exit Device Rail Jumper to Hinge)	9.79	QC12
93982	QC-C006	QC12 - 6" Wire Harness; 8 & 4 Pin Connector w/12 wires (For Exit Device Rail Jumper to Hinge)	10.25	QC12
93983	QC-C012	QC12 - 12" Wire Harness; 8 & 4 Pin Connector w/12 wires (For Exit Device Rail Jumper to Hinge)	13.53	QC12
2', 3' & 4' Harness				
Between hinge and through the door to the lockset or exit device trim				
93984	QC-C200	QC12 - 26" Wire Harness; 8 & 4 Pin Connector w/12 Wires	15.20	QC12
93985	QC-C206	QC12 - 32" Wire Harness; 8 & 4 Pin Connector w/12 Wires	16.41	QC12
93986	QC-C300	QC12 - 38" Wire Harness; 8 & 4 Pin Connector w/12 wires	16.81	QC12
93987	QC-C306	QC12 - 44" Wire Harness; 8 & 4 Pin Connector w/12 wires	17.00	QC12
93988	QC-C400	QC12 - 50" Wire Harness; 8 & 4 Pin Connector w/12 wires	17.29	QC12
15' Harness				
From the hinge location, up the jamb to the above the ceiling, or up and around a full lite or half lite metal door.				
93989	QC-C1500	QC12 - 15' 2" Wire Harness; 8 & 4 Pin Connector w/12 Wires	37.88	QC12
Custom Size*		QC12 - Custom sizes available. Consult factory. Harness; 8 & 4 Pin Connector w/12 Wires	POA	QC12

* QC-C or QC-CP x 96" \$30.75, QC-C or QC-CP x 72" \$22.98, QC-C or QC-CP x 60" 19.15.
 \$288.75 for QC-C or QC-CP x 150 ft. \$131.25 for QC-C or QC-CP x 50 ft.

Transfer Device Solutions

McKINNEY ElectroLynx® Harnesses & Components
For Wood Doors

CORBIN RUSSWIN, SARGENT, and YALE

Price Code 79

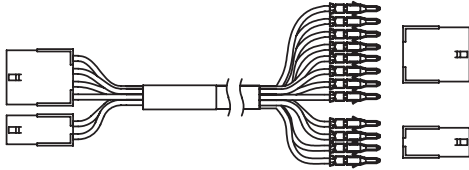

If wood door, order a retrofit cable with the Molex connector on one end,
and pins crimped on the other end.

PART #	McKinney CATALOG #	Description:	Net Price	Max Hinge required (Not included)
3", 6" & 12" Harness				
Between hinge and the end of an exit device				
93990	QC-C003P	QC12 - 3" Wire Harness; 8 & 4 Pin Connector w/12 wires (For Exit Device Rail Jumper to Hinge, Insert pre-pinned ends into plastic Molex connector)	12.51	QC12
93991	QC-C006P	QC12 - 6" Wire Harness; 8 & 4 Pin Connector w/12 wires (For Exit Device Rail Jumper to Hinge, Insert pre-pinned ends into plastic Molex connector)	12.97	QC12
93992	QC-C012P	QC12 - 12" Wire Harness; 8 & 4 Pin Connector w/12 wires (For Exit Device Rail Jumper to Hinge, Insert pre-pinned ends into plastic Molex connector)	16.25	QC12
2', 3' & 4' Harness				
Between hinge and through the door to the lockset or exit device trim.				
93993	QC-C200P	QC12 - 26" Wire Harness; 8 & 4 Pin Connector w/12 wires (Insert pre-pinned ends into plastic Molex connector)	17.91	QC12
93994	QC-C206P	QC12 - 32" Wire Harness; 8 & 4 Pin Connector w/12 wires (Insert pre-pinned ends into plastic Molex connector)	19.12	QC12
93995	QC-C300P	QC12 - 38" Wire Harness; 8 & 4 Pin Connector w/12 wires (Insert pre-pinned ends into plastic Molex connector)	19.53	QC12
93996	QC-C306P	QC12 - 44" Wire Harness; 8 & 4 Pin Connector w/12 wires (Insert pre-pinned ends into plastic Molex connector)	19.71	QC12
93997	QC-C400P	QC12 - 50" Wire Harness; 8 & 4 Pin Connector w/12 wires (Insert pre-pinned ends into plastic Molex connector)	20.01	QC12
15' Harness				
From the hinge location, up the jamb to the above the ceiling, or up and around a full lite or half lite metal door.				
93998	QC-C1500P	QC12 - 15' 2" Wire Harness; 8 & 4 Pin Connector w/12 Wires (Termination in Field)	40.61	QC12
93970	QC-C2500P	QC12 - 25' Wire Harness, 8 & 4 Pin Connector w/12 Wires	47.31	QC12
93971	QC-C3000P	QC12 - 30' Wire Harness; 8 & 4 Pin Connector w/12 Wires	56.77	QC12
Custom Size*		Custom sizes available. Consult the factory	POA	QC12

*QC-CP 10 FT \$28.30, QC-CP 20 FT \$56.60, QC-CP 50 FT 82.58, QC-CP 70 FT \$115.66, QC-CP 75 FT \$123.90.
\$288.75 for QC-C or QC-CP x 150 ft. \$131.25 for QC-C or QC-CP x 50 ft.

ASSA ABLOY

The global leader in
door opening solutions



800-346-7707 | www.mckinneyhinge.com
Check the web site for the up-to-date catalog

McKinney is a brand associated with Corbin Russwin, Inc., an ASSA ABLOY Group company. Copyright © 2012-2017, Corbin Russwin, Inc. All rights reserved. Reproduction in whole or in part without the express written permission of Corbin Russwin, Inc. is prohibited.

Transfer Device Solutions

McKinney ElectroLynx® Harnesses & Components

CORBIN RUSSWIN, SARGENT, and YALE Price Code 79

PART #	McKinney CATALOG #	Description:	Kit Application:	Net Price
Miscellaneous Kits				
94034	QC-R001	Molex/Repair/Service Kit	Includes 2, 4, 8 Molex receptacles and plugs (Qty. 10 ea) and the corresponding terminals (100 of each type), extraction tool and pinning assembly guide. Customer must purchase Molex crimper separately.	107.02
Miscellaneous Kits				
94035	QC-R002	Extraction Tool 	Quantity 1 Each, Sold one each	22.17
94036	QC-R003	Molex Hand Crimp Tool 	Molex tool used to attach terminals to wire (stripped) ends	461.69

PART #	McKinney CATALOG #	Description:	Kit Application:	Net Price
Receptacles and Terminals				
94037	QC-RF2	Female Receptacle 2 CKT	Quantity 1 Bag of 100	26.04
94026	QC-RF4	Female Receptacle 4 CKT	Quantity 1 Bag of 100	31.87
94027	QC-RF8	Female Receptacle 8 CKT	Quantity 1 Bag of 100	42.11
94028	QC-RM2	Male Plug 2 CKT	Quantity 1 Bag of 100	27.70
93978	QC-RM4	Male Plug 4 CKT	Quantity 1 Bag of 100	32.69
93979	QC-RM8	Male Plug 8 CKT	Quantity 1 Bag of 100	43.08
94029	QC-FT2024	Female Terminal AWG 20-24	Quantity 1 Bag of 100	10.80
94030	QC-FT2630	Female Terminal AWG 26-30	Quantity 1 Bag of 100	10.80
93980	QC-MT2024	Male Terminal AWG 20-24	Quantity 1 Bag of 100	9.40
94031	QC-MT2630	Male Terminal AWG 26-30	Quantity 1 Bag of 100	10.80
94033	QC-DCC	Pinning Assembly Guide	Quantity 1 Bag of 10	23.48
94016	POE-MT2024	Male Terminal AWG 20-24	Quantity 1 Bag of 100	32.99
94017	POE-RM6	Male Plug 6 CKT	Quantity, 1 Bag of 100	27.30
94018	POE-RF6	Female Receptacle 6 CKT	Quantity, 1 Bag of 100	27.30
94019	POE-MT2630	Male Terminal AWG 26-30	Quantity, 1 Bag of 100	14.45
94020	POE-FT2630	Female Terminal AWG 26-30	Quantity, 1 Bag of 100	14.45

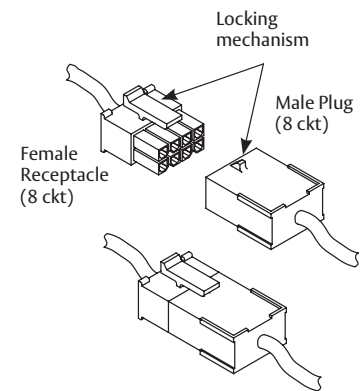

Door Cord and EPT				
94002	MCK-TSB-C	Door Cord Gray/Black Caps 18"	Quantity 1 Each, Sold 1 Each	18.71
94003	MCK-TSB-CXL	Door Cord Gray/Black Caps 36"	Quantity 1 Each, Sold 1 Each	25.63
94004	MCK-EPT	Electrical Power Transfer	Quantity 1 Each, Sold 1 Each	43.63
94005	MCK-EPTL	Electrical Power Transfer, Long	Quantity 1 Each, Sold 1 Each	57.49
94006	MCK-EL-EPT	ElectroLynx EPT -12 wire	Quantity 1 Each, Sold 1 Each	69.26
94007	MCK-EL-EPTL	ElectroLynx EPTL Long -12 wire	Quantity 1 Each, Sold 1 Each	83.11



As part of their promise to provide innovative, fast and effective high security solutions to their customers, ASSA ABLOY Group brands offer ElectroLynx®, a universal quick-connect system that simplifies the electrification of the door opening.

ElectroLynx® is a registered trademark of ASSA ABLOY Inc.

800-346-7707 | www.mckinneyhinge.com
 Check the web site for the up-to-date catalog

McKinney is a brand associated with Corbin Russwin, Inc., an ASSA ABLOY Group company. Copyright © 2012-2017, Corbin Russwin, Inc. All rights reserved. Reproduction in whole or in part without the express written permission of Corbin Russwin, Inc. is prohibited.

ASSA ABLOY

The global leader in door opening solutions

Transfer Device Solutions

McKinney ElectroLynx® Power over Ethernet (PoE) Hinge & Harnesses

Price Code 79

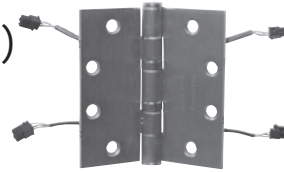

PoE Hinges are
Price Code 59

U.S. Patent No.
7,824,200

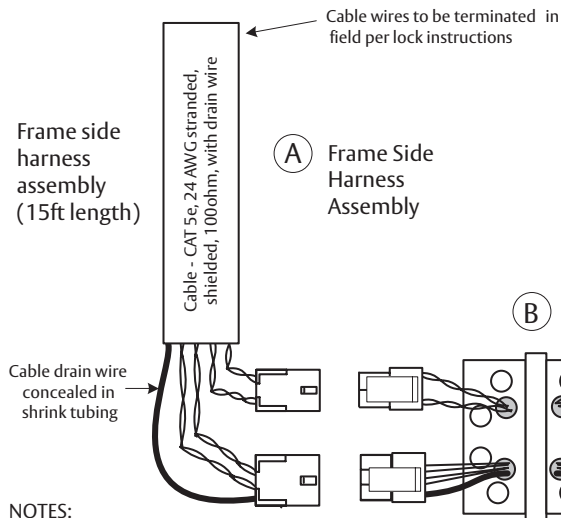

(A) Frame Side Harness Assembly

PART #	McKinney CATALOG #	Description:	Net Price
73695	4.5 x 4.5 TA2714 26D PoE	Standard Weight 5 Knuckle	607.93
73696	4.5 x 4.5 T4A3786 26D PoE	Heavy Weight 5 Knuckle	627.01

Consult the factory for additional items with PoE option.

(B) PoE Data Hinge

PoE Door Harness Assembly

(C)

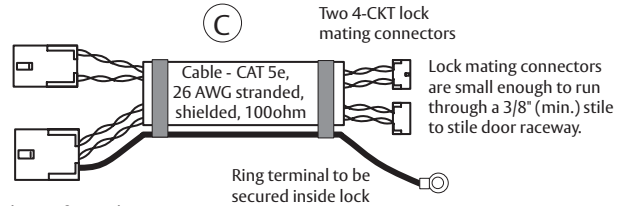

NOTES:

The PoE door & frame harnesses can accommodate a variety of new (with raceway) and retrofit applications. Connectors are small enough to run through a 3/8" (min.) stile-to-stile door raceway. Connects to intelligent Power over Ethernet electromechanical hardware from SARGENT and CORBIN RUSSWIN.

PART #	McKinney CATALOG #	Harness Length	Application	Description:	Net Price	Max Hinge Req'd (not included)
Door Harnesses			Between Hinge & PoE Lock			
94022	PoE-C206P	30"	20" to 25" door width (doors with 3 butt hinges with PoE hinge in center stile-to-stile raceway to lock prep).	PoE, Cat 5e, 26AWG, Shielded, Screened, 100ohm, Door Harness Assembly	27.80	PoE
94038	PoE-C300P	36"	26" to 31" door width (doors with 3 butt hinges with PoE hinge in center stile-to-stile raceway to lock prep).	PoE, Cat 5e, 26AWG, Shielded, Screened, 100ohm, Door Harness Assembly	28.49	PoE
94039	PoE-C306P	42"	32" to 36" door width (doors with 3 butt hinges with PoE hinge in center stile-to-stile raceway to lock prep).	PoE, Cat 5e, 26AWG, Shielded, Screened, 100ohm, Door Harness Assembly	29.03	PoE
94040	PoE-C400P	48"	37" to 42" door width (doors with 3 butt hinges with PoE hinge in center stile-to-stile raceway to lock prep).	PoE, Cat 5e, 26AWG, Shielded, Screened, 100ohm, Door Harness Assembly	29.79	PoE
94041	PoE-C406P	54"	43" to 48" door width (doors with 3 butt hinges with PoE hinge in center stile-to-stile raceway to lock prep).	PoE, Cat 5e, 26AWG, Shielded, Screened, 100ohm, Door Harness Assembly	30.61	PoE
94042	PoE-C500P	60"	Door Harness Assembly	PoE, CAT 5e, 26AWG, Shielded, Stranded, 100ohm, Door Frame Harness Assembly	38.87	PoE
94021	PoE-C700P	84"	Door Harness Assembly	PoE, CAT 5e, 26AWG, Shielded, Stranded, 100ohm, Door Frame Harness Assembly	42.15	PoE
94043	PoE-C1300P	156"	Door Harness Assembly	PoE, CAT 5e, 26AWG, Shielded, Stranded, 100ohm, Door Frame Harness Assembly	46.46	PoE
EPT Harness						
94023	PoE-CEPT30	360"	EPT Harness Assembly	PoE, CAT 5e, 26AWG, Shielded, Stranded, 100ohm, Door Frame Harness Assembly	69.62	PoE
EPT Harness Frame Harness			Between hinge and PoE Network Cable & Switch			
94044	PoE-C1500P	180"	From the hinge location, up the jamb to the wall/ceiling.	PoE, Cat 5e, 26AWG, Shielded, Screened, 100ohm, Door Harness Assembly	32.56	PoE
Custom Size			Custom sizes available. Consult factory.		POA	PoE

The door harness connectors are small enough to run through a 3/8" (minimum) stile-to-stile door raceway.

*See the McKinney Catalog for additional finishes and hinge types.

Note: One hinge, door harness and frame harness are required for each PoE opening.

Custom cables less than 20 FT \$65.00.

ASSA ABLOY

The global leader in
door opening solutions

800-346-7707 | www.mckinneyhinge.com

Check the web site for the up-to-date catalog

McKinney is a brand associated with Corbin Russwin, Inc., an ASSA ABLOY Group company. Copyright © 2012-2017, Corbin Russwin, Inc. All rights reserved. Reproduction in whole or in part without the express written permission of Corbin Russwin, Inc. is prohibited.

Transfer Device Solutions

McKinney ElectroLynx® Power over Ethernet (PoE) Harnesses with Loose RJ-45 Connectors

Price Code 79

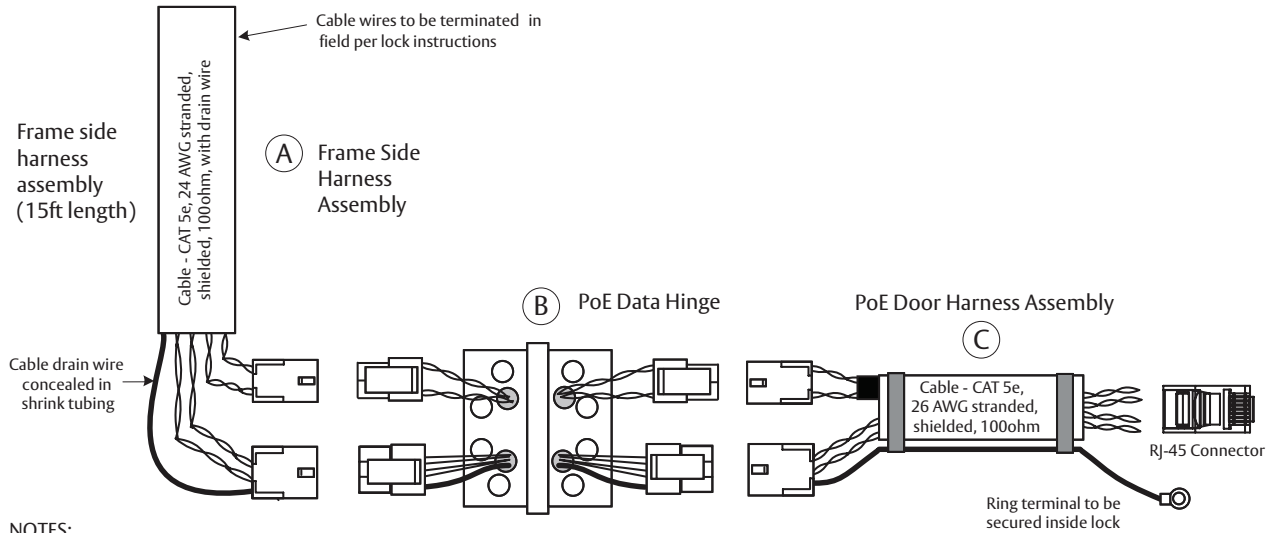

NOTES:

The PoE door & frame harnesses can accommodate a variety of new (with raceway) and retrofit applications. Connects to next generation Power over Ethernet electromechanical hardware from SARGENT and CORBIN RUSSWIN including: Corbin Russwin IN220, Corbin Russwin Access 700 PIP1, SARGENT IN220, SARGENT Passport 1000 P1.

PART #	McKinney CATALOG #	Harness Length	Application	Description:	Net Price	Max Hinge Req'd (not included)
Door Harnesses			Between Hinge & PoE Lock			
94202	PoE-C206RJ	30"	20" to 25" door width (doors with 3 butt hinges with PoE hinge in center stile-to-stile raceway to lock prep).	PoE, Cat 5e, 26AWG, Shielded, Screened, 100ohm, Door Harness Assembly	27.80	PoE
94203	PoE-C300RJ	36"	26" to 31" door width (doors with 3 butt hinges with PoE hinge in center stile-to-stile raceway to lock prep).	PoE, Cat 5e, 26AWG, Shielded, Screened, 100ohm, Door Harness Assembly	28.49	PoE
94204	PoE-C306RJ	42"	32" to 36" door width (doors with 3 butt hinges with PoE hinge in center stile-to-stile raceway to lock prep).	PoE, Cat 5e, 26AWG, Shielded, Screened, 100ohm, Door Harness Assembly	29.03	PoE
94205	PoE-C400RJ	48"	37" to 42" door width (doors with 3 butt hinges with PoE hinge in center stile-to-stile raceway to lock prep).	PoE, Cat 5e, 26AWG, Shielded, Screened, 100ohm, Door Harness Assembly	29.79	PoE
94206	PoE-C406RJ	54"	43" to 48" door width (doors with 3 butt hinges with PoE hinge in center stile-to-stile raceway to lock prep).	PoE, Cat 5e, 26AWG, Shielded, Screened, 100ohm, Door Harness Assembly	30.61	PoE
94207	PoE-C500RJ	60"	Door Harness Assembly	PoE, CAT 5e, 26AWG, Shielded, Stranded, 100ohm, Door Frame Harness Assembly	38.87	PoE
94201	PoE-C700RJ	84"	Door Harness Assembly	PoE, CAT 5e, 26AWG, Shielded, Stranded, 100ohm, Door Frame Harness Assembly	42.15	PoE
94208	PoE-C1300RJ	156"	Door Harness Assembly	PoE, CAT 5e, 26AWG, Shielded, Stranded, 100ohm, Door Frame Harness Assembly	46.46	PoE
EPT Harness						
94200	PoE-CEPT30RJ	360"	EPT Harness Assembly	PoE, CAT 5e, 26AWG, Shielded, Stranded, 100ohm, Door Frame Harness Assembly	69.62	PoE
Custom Size			Custom sizes available. Consult factory.		POA	PoE

Note: One hinge, door harness and frame harness are required for each PoE opening.

800-346-7707 | www.mckinneyhinge.com

Check the web site for the up-to-date catalog

McKinney is a brand associated with Corbin Russwin, Inc., an ASSA ABLOY Group company. Copyright © 2012-2017, Corbin Russwin, Inc. All rights reserved. Reproduction in whole or in part without the express written permission of Corbin Russwin, Inc. is prohibited.

ASSA ABLOY

The global leader in door opening solutions

Transfer Device Solutions

McKinney ElectroLynx® Power over Ethernet (PoE) Harnesses with RJ-45 Connectors Attached

Price Code 79

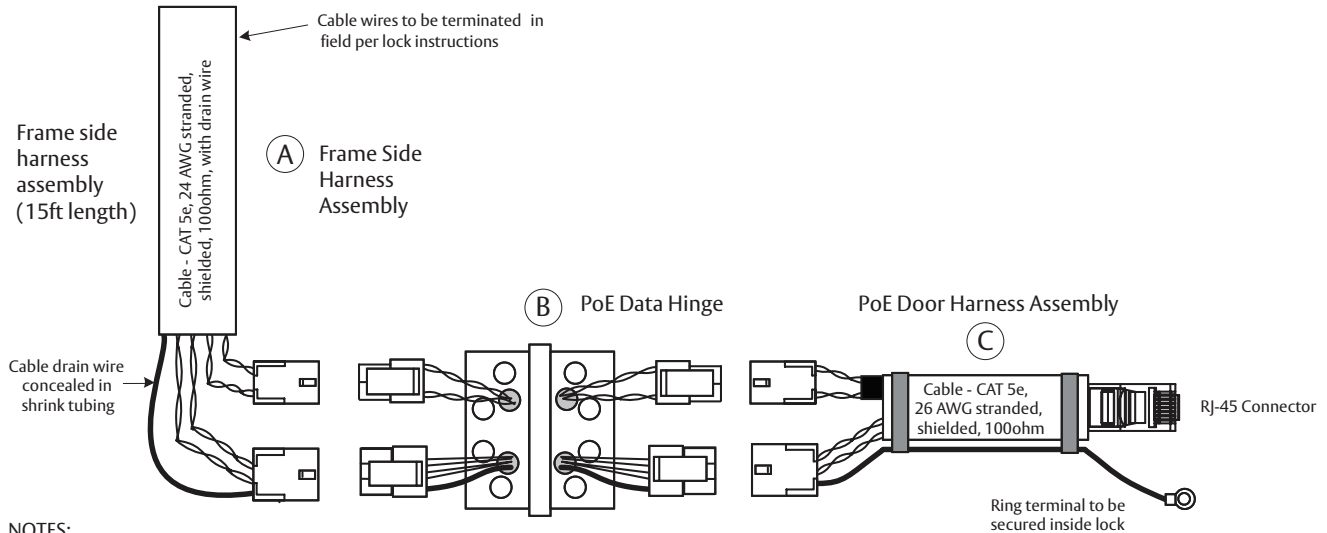

NOTES:

The PoE door & frame harnesses can accommodate a variety of new (with raceway) and retrofit applications. Connects to next generation Power over Ethernet electromechanical hardware from SARGENT and CORBIN RUSSWIN including: Corbin Russwin IN220, Corbin Russwin Access 700 PIP1, SARGENT IN220, SARGENT Passport 1000 P1.

PART #	McKinney CATALOG #	Harness Length	Application	Description:	Net Price	Max Hinge Req'd (not included)
Door Harnesses			Between Hinge & PoE Lock			
94210	PoE-C206PRJ	30"	20" to 25" door width (doors with 3 butt hinges with PoE hinge in center stile-to-stile raceway to lock prep).	PoE, Cat 5e, 26AWG, Shielded, Screened, 100ohm, Door Harness Assembly	27.80	PoE
94211	PoE-C300PRJ	36"	26" to 31" door width (doors with 3 butt hinges with PoE hinge in center stile-to-stile raceway to lock prep).	PoE, Cat 5e, 26AWG, Shielded, Screened, 100ohm, Door Harness Assembly	28.49	PoE
94212	PoE-C306PRJ	42"	32" to 36" door width (doors with 3 butt hinges with PoE hinge in center stile-to-stile raceway to lock prep).	PoE, Cat 5e, 26AWG, Shielded, Screened, 100ohm, Door Harness Assembly	29.03	PoE
94213	PoE-C400PRJ	48"	37" to 42" door width (doors with 3 butt hinges with PoE hinge in center stile-to-stile raceway to lock prep).	PoE, Cat 5e, 26AWG, Shielded, Screened, 100ohm, Door Harness Assembly	29.79	PoE
94214	PoE-C406PRJ	54"	43" to 48" door width (doors with 3 butt hinges with PoE hinge in center stile-to-stile raceway to lock prep).	PoE, Cat 5e, 26AWG, Shielded, Screened, 100ohm, Door Harness Assembly	30.61	PoE
94215	PoE-C500PRJ	60"	Door Harness Assembly	PoE, CAT 5e, 26AWG, Shielded, Stranded, 100ohm, Door Frame Harness Assembly	38.87	PoE
94216	PoE-C700PRJ	84"	Door Harness Assembly	PoE, CAT 5e, 26AWG, Shielded, Stranded, 100ohm, Door Frame Harness Assembly	42.15	PoE
94217	PoE-C1300PRJ	156"	Door Harness Assembly	PoE, CAT 5e, 26AWG, Shielded, Stranded, 100ohm, Door Frame Harness Assembly	46.46	PoE
Custom Size			Custom sizes available. Consult factory.		POA	PoE

Note: One hinge, door harness and frame harness are required for each PoE opening.
 Custom cables less than 60" are priced at the 60" price. For custom cables greater than 60", add \$.62 per inch to the 60" price.



The global leader in door opening solutions

Non-Ferrous Bearing

TA391

Price Code 30

5" x 4 1/2"
127 mm x 114.30 mm

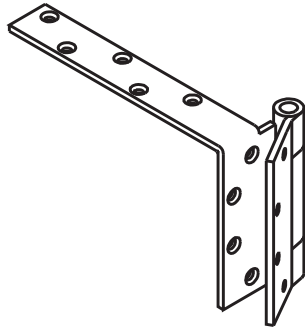

Anchor plate for jamb and door header only. Permits use of holders, closers concealed in top of jamb.

Hand	Part Number	Finish	Price Each	Case Qty.	Box Qty.	Case Wgt.
R.H.	76168	P	648.90 SET	4 SETS	1 SET	28
L.H.	76169	P	648.90 SET			
R.H.	76184	26D	648.90 SET			
L.H.	76185	26D	648.90 SET			
R.H.	76188	32D	636.31 SET			
L.H.	76189	32D	636.31 SET			

Set consists of top anchor, intermediate and bottom hinge for square edge door application. Anchor Hinge Sets are not available in brite finishes.

TA392

Price Code 30

5" x 4 1/2"
127 mm x 114.30 mm

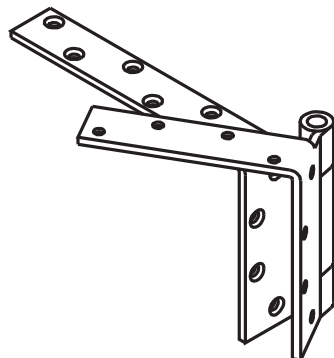

Anchor plate for jamb and door header permits use of surface applied holders and closers.

Hand	Part Number	Finish	Price Each	Case Qty.	Box Qty.	Case Wgt.
R.H.	75502	P	540.78 SET	4 SETS	1 SET	28
L.H.	75503	P	540.78 SET			
R.H.	75496	26D	457.24 SET			
L.H.	75497	26D	457.24 SET			
R.H.	75500	32D	407.56 SET			
L.H.	75501	32D	407.56 SET			

Set consists of top anchor, intermediate and bottom hinge for square edge door application. Anchor Hinge Sets are not available in brite finishes.

Non-Ferrous Bearing

TA393

Price Code 30

5" x 4 1/2"
127 mm x 114.30 mm

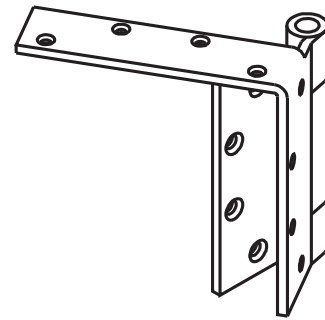

Anchor plate for jamb header only, permits the use of holders and closers concealed in the top of the door.

Hand	Part Number	Finish	Price Each	Case Qty.	Box Qty.	Case Wgt.
R.H.	75565	P	599.65 SET	4 SETS	1 SET	28
L.H.	75566	P	599.65 SET			
R.H.	75512	26D	516.75 SET			
L.H.	75513	26D	516.75 SET			
R.H.	75581	32D	485.86 SET			
L.H.	75582	32D	485.86 SET			

Set consists of top anchor, intermediate and bottom hinge for square edge door application. Anchor Hinge Sets are not available in brite finishes.

Non-Ferrous Bearing Hinges 4" Door Leg

TA394

Price Code 30

5" x 4 1/2"
127 mm x 114.30 mm

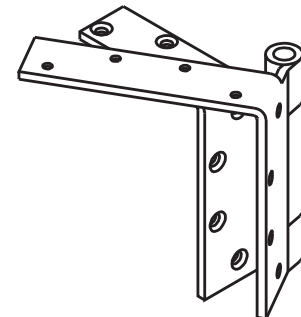

Anchor plate for both jamb and door header. Permits use of both holders, closers.

Hand	Part Number	Finish	Price Each	Case Qty.	Box Qty.	Case Wgt.
R.H.	75435	P	615.86 SET	4 SETS	1 SET	28
L.H.	75436	P	615.86 SET			
R.H.	75451	26D	517.03 SET			
L.H.	75452	26D	517.03 SET			
R.H.	75455	32D	581.48 SET			
L.H.	75456	32D	581.48 SET			

Set consists of top anchor, intermediate and bottom hinge for square edge door application. Anchor Hinge Sets are not available in brite finishes.

Heavy Weight Beveled Edge Non-Ferrous Bearing

TA5392

Price Code 30

5" x 4 1/2"
127 mm x 114.30 mm

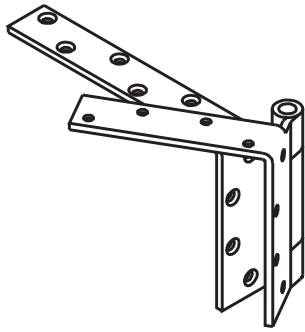

Anchor plate for both jamb and door header permits use of surface applied holders and closers.

Hand	Part Number	Finish	Price Each	Case Qty.	Box Qty.	Case Wgt.
R.H.	75605	P	540.78 SET	4 SETS	1 SET	28
L.H.	75606	P	540.78 SET			
R.H.	75546	26D	457.24 SET			
L.H.	75547	26D	457.24 SET			
R.H.	75544	32D	407.56 SET			
L.H.	75545	32D	407.56 SET			

Set consists of top anchor, intermediate and bottom hinge for beveled (1/4" in 2") edge doors on hinge side application. Anchor Hinge Sets are not available in brite finishes.

TA5393

Price Code 30

5" x 4 1/2"
127 mm x 114.30 mm

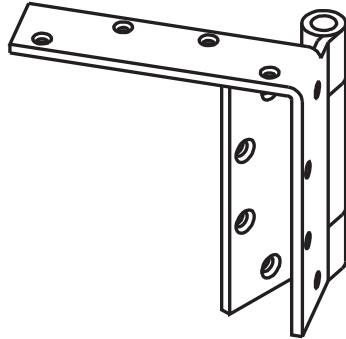

Anchor plate for jamb header only, permits the use of holders and closers concealed in the top of the door.

Hand	Part Number	Finish	Price Each	Case Qty.	Box Qty.	Case Wgt.
R.H.	75550	P	599.65 SET	4 SETS	1 SET	28
L.H.	75551	P	599.65 SET			
R.H.	75695	26D	516.75 SET			
L.H.	75696	26D	516.75 SET			
R.H.	75657	32D	599.65 SET			
L.H.	75658	32D	599.65 SET			

Set consists of top anchor, intermediate and bottom hinge for beveled (1/4" in 2") edge doors on hinge side application. Anchor Hinge Sets are not available in brite finishes.

Non-Ferrous Bearing Hinges For Beveled Edge Doors 4" Door Leg

TA5394

Price Code 30

5" x 4 1/2"
127 mm x 114.30 mm

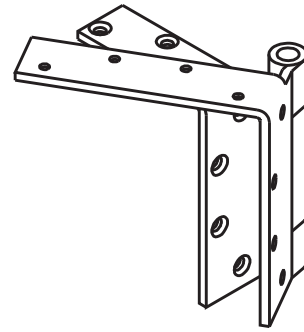

Anchor plate for both jamb and door header permits use of surface applied holders and closers.

Hand	Part Number	Finish	Price Each	Case Qty.	Box Qty.	Case Wgt.
R.H.	75700	P	615.86 SET	4 SETS	1 SET	28
L.H.	75701	P	615.86 SET			
R.H.	75735	26D	517.03 SET			
L.H.	75736	26D	517.03 SET			
R.H.	75739	32D	581.48 SET			
L.H.	75740	32D	581.48 SET			

Set consists of top anchor, intermediate and bottom hinge for beveled (1/4" in 2") edge doors on hinge side application. Anchor Hinge Sets are not available in brite finishes.

Steel Anchor Hinge Bearing

TA791

Price Code 30

5" x 4 1/2"
127 mm x 114.30 mm

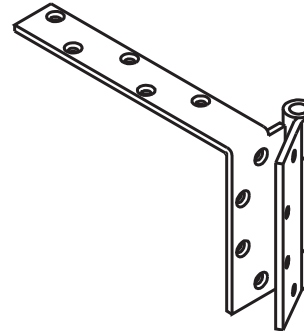

Anchor plate for door header only. Permits use of holders, closers concealed in top of jamb.

Hand	Part Number	Finish	Price Each	Case Qty.	Box Qty.	Case Wgt.
R.H.	76150	P	403.40 SET	4 SETS	1 SET	28
L.H.	76151	P	403.40 SET			
R.H.	76166	26D	365.64 SET			
L.H.	76167	26D	365.64 SET			

Set consists of top anchor, intermediate and bottom hinge for square edge door application. Anchor Hinge Sets are not available in brite finishes.

ASSA ABLOY

AH-2 The global leader in door opening solutions

800-346-7707 | www.mckinneyhinge.com
Check the web site for the up-to-date catalog

McKinney is a brand associated with Corbin Russwin, Inc., an ASSA ABLOY Group company. Copyright © 2012-2017, Corbin Russwin, Inc. All rights reserved. Reproduction in whole or in part without the express written permission of Corbin Russwin, Inc. is prohibited.

Steel Anchor Hinge Bearing

TA792

Price Code 30

5" x 4 1/2"
127 mm x 114.30 mm

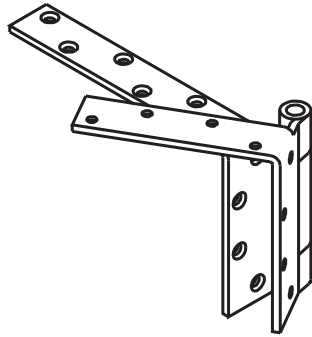

Anchor plate for jamb and door header permits use of surface applied holders and closers.

Hand	Part Number	Finish	Price Each	Case Qty.	Box Qty.	Case Wgt.
R.H.	75490	P	403.40 SET	4 SETS	1 SET	28
L.H.	75491	P	403.40 SET			
R.H.	75492	26D	234.18 SET			
L.H.	75493	26D	234.18 SET			

Set consists of top anchor, intermediate and bottom hinge for square edge door application. Anchor Hinge Sets are not available in brite finishes.

TA793

Price Code 30

5" x 4 1/2"
127 mm x 114.30 mm

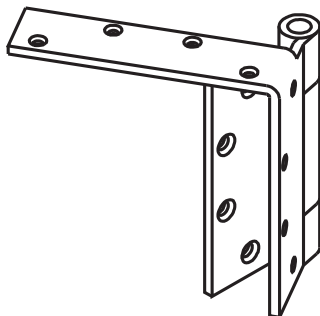

Anchor plate for jamb header only, permits the use of holders and closers concealed in top of the door.

Hand	Part Number	Finish	Price Each	Case Qty.	Box Qty.	Case Wgt.
R.H.	75585	P	470.06 SET	4 SETS	1 SET	28
L.H.	75586	P	470.06 SET			
R.H.	75601	26D	365.64 SET			
L.H.	75602	26D	365.64 SET			

Set consists of top anchor, intermediate and bottom hinge for square edge door application. Anchor Hinge Sets are not available in brite finishes.

Steel Anchor Hinge 4" Door Leg

TA794

Price Code 30

5" x 4 1/2"
127 mm x 114.30 mm

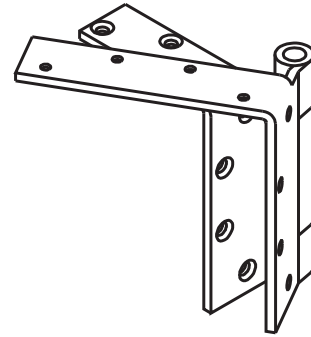

Anchor plate for both jamb and door header permits use of surface applied holders and closers.

Hand	Part Number	Finish	Price Each	Case Qty.	Box Qty.	Case Wgt.
R.H.	75820	P	484.50	4 SETS	1 SET	28
L.H.	75821	P	484.50			
R.H.	75836	26D	381.11			
L.H.	75837	26D	381.11			

Set consists of top anchor, intermediate and bottom hinge for square edge door application. Anchor Hinge Sets are not available in brite finishes.

Steel Heavy Weight Beveled Edge Bearing

TA5792

Price Code 30

5" x 4 1/2"
127 mm x 114.30 mm

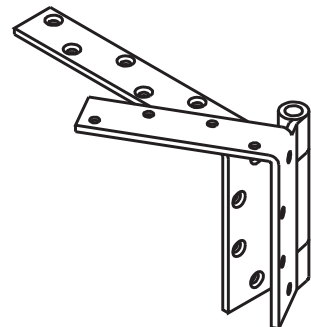

Anchor plate for jamb and door header permits use of surface applied holders and closers.

Hand	Part Number	Finish	Price Each	Case Qty.	Box Qty.	Case Wgt.
R.H.	75530	P	403.40 SET	4 SETS	1 SET	28
L.H.	75531	P	403.40 SET			
R.H.	75532	26D	234.18 SET			
L.H.	75533	26D	234.18 SET			

Set consists of top anchor, intermediate and bottom hinge for beveled (1/8" in 2") edge doors on hinge side application. Anchor Hinge Sets are not available in brite finishes.

Steel Heavy Weight Beveled Edge Bearing

TA5793

Price Code 30

5" x 4 1/2"
127 mm x 114.30 mm

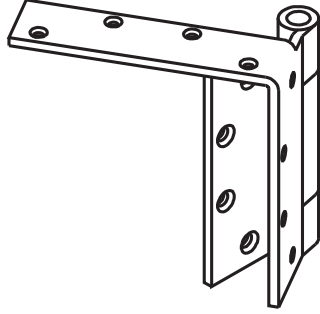

Anchor plate for jamb header only, permits the use of holders and closers concealed in top of the door.

Hand	Part Number	Finish	Price Each	Case Qty.	Box Qty.	Case Wgt.
R.H.	75627	P	470.06 SET	4 SETS	1 SET	28
L.H.	75628	P	470.06 SET			
R.H.	75554	26D	365.64 SET			
L.H.	75555	26D	365.64 SET			

Set consists of top anchor, intermediate and bottom hinge for beveled (1/8" in 2") edge doors on hinge side application. Anchor Hinge Sets are not available in brite finishes.

Steel Bearing Hinges For Beveled Edge Doors 4" Door Leg

TA5794

Price Code 30

5" x 4 1/2"
127 mm x 114.30 mm

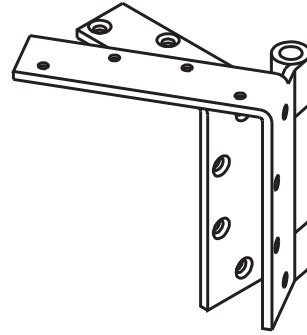

Anchor plate for both jamb and door header permits use of surface applied holders and closers.

Hand	Part Number	Finish	Price Each	Case Qty.	Box Qty.	Case Wgt.
R.H.	75868	P	484.50	4 SETS	1 SET	28
L.H.	75869	P	484.50			
R.H.	75884	26D	381.11			
L.H.	75885	26D	381.11			

Set consists of top anchor, intermediate and bottom hinge for beveled (1/8" in 2") edge doors on hinge side application. Anchor Hinge Sets are not available in brite finishes.

ASSA ABLOY

AH-4 The global leader in door opening solutions

800-346-7707 | www.mckinneyhinge.com
Check the web site for the up-to-date catalog

McKinney is a brand associated with Corbin Russwin, Inc., an ASSA ABLOY Group company. Copyright © 2012-2017, Corbin Russwin, Inc. All rights reserved. Reproduction in whole or in part without the express written permission of Corbin Russwin, Inc. is prohibited.

Steel Five Knuckle Standard Weight

TA2774

Price Code 50

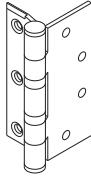

Size	Part Number	Finish	Price Each	Case Qty.	Box Qty.	Case Wgt.
4 1/2" 114.30 mm	57880	P	31.48	24	3	23
	57885	AP	79.77			
	57881	3	79.77			
	57888	4	79.77			
	57883	10	79.77			
	64989	10A	79.77			
	64983	10B	91.51			
	64986	26	79.77			
	57884	26D	37.94			
	5" 127 mm	57955	P			
57959		AP	105.88			
57963		3	105.88			
57956		4	105.88			
57960		10	105.88			
65007		10A	105.88			
65008		10B	110.40			
65011		26	105.88			
57958		26D	105.88			

Standard Weight Five Knuckle Non-Ferrous Bearing

TA3374

Price Code 50

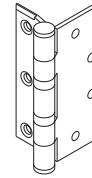

Size	Part Number	Finish	Price Each	Case Qty.	Box Qty.	Case Wgt.				
4 1/2" 114.30 mm	61406	P	173.62	24	3	28				
	61412	AP	173.62							
	61423	3	173.62							
	61424	4	173.62							
	61413	10	173.62							
	61405	10A	173.62							
	61417	10B	199.17							
	61411	26	173.62							
	61410	26D	173.62							
	61414	32	173.62							
	61415	32D	173.62							
	5" 127 mm	61461	P				243.43	24	3	32
		61441	AP				243.43			
		61462	3				243.43			
		61463	4				243.43			
61440		10	243.43							
61438		10A	243.43							
61446		10B	279.24							
61467		26	243.43							
61468		26D	243.43							
61444		32	243.43							
61445	32D	243.43								

Heavy Weight Non-Ferrous Bearing

T4A3384
Price Code 50

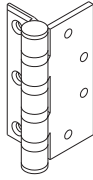

Size	Part Number	Finish	Price Each	Case Qty.	Box Qty.	Case Wgt.
4 1/2" 114.30 mm	70775	P	232.91	24	3	40
	70782	AP	232.91			
	70776	3	232.91			
	70777	4	232.91			
	61641	10	232.91			
	70783	10A	232.91			
	61643	10B	267.17			
	70781	26	232.91			
	61640	26D	232.91			
	70770	32	232.91			
5" 127 mm	70771	32D	232.91	24	3	40
	70800	P	274.68			
	70807	AP	274.68			
	70801	3	274.68			
	70802	4	274.68			
	61661	10	274.68			
	70808	10A	274.68			
	61665	10B	315.08			
	70806	26	274.68			
	61660	26D	274.68			
6" 152.4 mm for 1 3/4" 44.4 mm door	61663	32D	274.68	18	3	63
	70829	P	298.16			
	70837	AP	298.16			
	70830	3	298.16			
	70831	4	298.16			
	70841	10	298.16			
	70824	10A	298.16			
	70825	10B	342.01			
	70835	26	298.16			
	70836	26D	298.16			

Steel Heavy Weight Bearings

T4A3784
Price Code 50

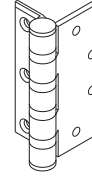

Size	Part Number	Finish	Price Each	Case Qty.	Box Qty.	Case Wgt.
4 1/2" 114.30 mm	58220	P	151.94	24	3	31
	72478	AP	151.94			
	72482	3	151.94			
	58222	4	151.94			
	72484	10	151.94			
	72491	10A	151.94			
	72485	10B	174.28			
	72488	26	151.94			
	58223	26D	151.94			
	58240	P	172.58			
5" 127 mm	58241	AP	172.58	24	3	36
	72512	3	172.58			
	72513	4	172.58			
	72515	10	172.58			
	72520	10A	172.58			
	72516	10B	197.96			
	72519	26	172.58			
	58242	26D	156.89			
	58270	P	213.97			
	72560	AP	213.97			
6" 152.4 mm for 1 3/4" 44.4 mm door	58273	3	213.97	12	3	32
	72542	4	213.97			
	58284	10	213.97			
	72541	10A	213.97			
	72544	10B	245.43			
	72547	26	213.97			
	58283	26D	213.97			

Steel Swing Clear Heavy Weight Bearing

T4A3789
Price Code 30

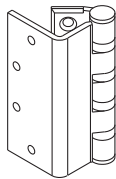

Size	Part Number	Finish	Price Each	Case Qty.	Box Qty.	Case Wgt.
5" 127 mm	73021	P	197.48	24	3	47
	73022	AP	197.48			
	73026	3	197.48			
	73027	4	197.48			
	73029	10	197.48			
	73037	10A	197.48			
	73030	10B	226.52			
	73033	26	197.48			
	73034	26D	197.48			

ASSA ABLOY

HM-2 The global leader in door opening solutions

800-346-7707 | www.mckinneyhinge.com
Check the web site for the up-to-date catalog

McKinney is a brand associated with Corbin Russwin, Inc., an ASSA ABLOY Group company. Copyright © 2012-2017, Corbin Russwin, Inc. All rights reserved. Reproduction in whole or in part without the express written permission of Corbin Russwin, Inc. is prohibited.

Standard Weight Non-Ferrous Bearing

TA2372
Price Code 50

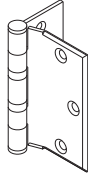

Size	Part Number	Finish	Price Each	Case Qty.	Box Qty.	Case Wgt.
4 1/2" 114.30 mm	57685	AP	173.40	24	3	30
	57686	P	173.40			
	57687	3	173.40			
	57688	4	173.40			
	57689	10	173.40			
	57690	10B	198.91			
	57691	26	173.40			
	57692	26D	173.40			
	57694	D-3	173.40			
	57695	D-4	173.40			
5" 127 mm	57696	32D	173.40	24	3	38
	57697	32D	180.77			

Refer to page HS-3 for Back Plates.

Steel Standard Weight

TA2772
Price Code 50

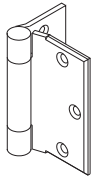

Size	Part Number	Finish	Price Each	Case Qty.	Box Qty.	Case Wgt.
4 1/2" 114.30 mm	57710	P	29.71	24	3	30
	57719	AP	79.50			
	57714	3	79.50			
	57712	4	79.50			
	57715	10	79.50			
	57708	10A	79.50			
	57721	10B	91.19			
	57716	26	79.50			
	57717	26D	35.82			
	5" 127 mm	57830	P			
57834		AP	115.81			
64920		3	115.81			
64921		4	115.81			
57835		10	115.81			
57829		10A	115.81			
57839		10B	132.84			
64926		26	115.81			
	57833	26D	47.66			

Refer to page HS-3 for Back Plates.

Heavy Weight Non-Ferrous Bearing

T4A3382
Price Code 50

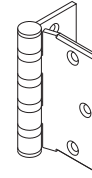

Size	Part Number	Finish	Price Each	Case Qty.	Box Qty.	Case Wgt.				
4 1/2" 114.30 mm	70560	P	210.44	24	3	50				
	61565	AP	210.44							
	70561	3	210.44							
	70562	4	210.44							
	61568	10	210.44							
	61561	10A	210.44							
	61569	10B	241.40							
	70566	26	210.44							
	70567	26D	210.44							
	61562	32	210.44							
	61563	32D	173.92							
	5" 127 mm	61589	P				287.46	24	3	57
		61597	AP				287.46			
		61590	3				287.46			
61591		4	287.46							
61584		10	287.46							
61580		10A	287.46							
61585		10B	329.73							
61579		26	287.46							
61596		26D	287.46							
61581		32	287.46							
6" 152.4 mm	61582	32D	287.46	18	3	66				
	70602	P	405.91							
	70610	AP	405.91							
	70603	3	405.91							
	70604	4	405.91							
	61604	10	405.91							
	70611	10A	405.91							
	61605	10B	465.60							
	70608	26	405.91							
	70609	26D	405.91							

Refer to page HS-3 for Back Plates.

Heavy Weight Steel Bearing

T4A3796
Price Code 50

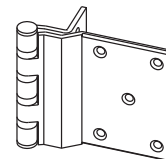

Size	Part Number	Finish	Price Each	Case Qty.	Box Qty.	Case Wgt.
5" 127 mm	73509	P	182.44	12		35
	73510	AP	182.44			
	73514	3	182.44			
	73515	4	182.44			
	73517	10	182.44			
	73525	10A	182.44			
	73518	10B	209.25			
	73521	26	182.44			
	73522	26D	89.70			

Steel Heavy Weight Bearing

T4A3782
Price Code 50

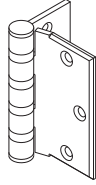

Size	Part Number	Finish	Price Each	Case Qty.	Box Qty.	Case Wgt.
4 1/2" 114.30 mm	58105	P	99.58	24	3	38
	58102	AP	166.10			
	58110	3	166.10			
	58111	4	166.10			
	58106	10	166.10			
	58120	10A	166.10			
	58108	10B	190.53			
	58118	26	166.10			
	58107	26D	82.30			
	5" 127 mm	58145	P			
58147		AP	189.01			
72280		3	189.01			
72281		4	189.01			
58146		10	189.01			
58149		10A	189.01			
72283		10B	216.82			
72286		26	189.01			
72287		26D	107.84			
6" 152.4 mm for 1 3/4" 44.4 mm door		58180	P	232.46	12	3
	58179	AP	232.46			
	72297	3	232.46			
	72298	4	232.46			
	72300	10	232.46			
	58183	10A	232.46			
	72301	10B	266.65			
	72304	26	232.46			
	58181	26D	138.97			
	6" 152.4 mm for 2 1/4" 51.05 mm door	72339	26D	138.97		

Refer to page HS-3 for Back Plates.

Steel Back Plates

BP-10

BP-11

Price Code 50

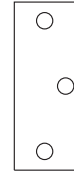

Size	Product	Part Number	Finish	Price Each	Case Qty.	Box Qty.	Case Wgt.
4 1/2" 114.30 mm	BP-10 (TA2772) (T4A3782)	63241	P	11.33	AS ORDERED		
		63242	10	11.33			
		63243	10B	12.79			
		63240	26D	6.20			
		63248	P	11.98			
5" 127 mm	BP-10	63249	10	11.98	AS ORDERED		
		63247	26D	9.25			
		63256	P	11.98			
5" 127 mm	BP-11 (T4A3797)	63257	10	11.98	AS ORDERED		
		63255	26D	11.98			

ASSA ABLOY

HS-2 The global leader in door opening solutions

800-346-7707 | www.mckinneyhinge.com
Check the web site for the up-to-date catalog

McKinney is a brand associated with Corbin Russwin, Inc., an ASSA ABLOY Group company. Copyright © 2012-2017, Corbin Russwin, Inc. All rights reserved. Reproduction in whole or in part without the express written permission of Corbin Russwin, Inc. is prohibited.

Heavy Weight 5 Knuckle Non-Ferrous Bearing

T4A3381
Price Code 50

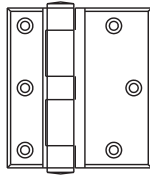

Size	Part Number	Finish	Price Each	Case Qty.	Box Qty.	Case Wgt.				
4 1/2" 114.30 mm	61515	P	198.90	24	3	46				
	61518	AP	198.90							
	61511	3	198.90							
	61517	4	198.90							
	61510	10	198.90							
	61506	10A	198.90							
	61516	10B	228.16							
	68501	26	198.90							
	68502	26D	198.90							
	61507	32	198.90							
	61508	32D	198.90							
	5" 127 mm	63250	P				272.46	24	3	62
		63251	AP				272.46			
		63252	3				272.46			
61528		4	272.46							
61520		10	272.46							
63253		10A	272.46							
61519		10B	312.52							
63254		26	272.46							
61521		26D	272.46							
61522		32	272.46							
6" 152.40 mm	61523	32D	272.46	18	3	67				
	63283	P	296.09							
	63291	AP	296.09							
	63284	3	296.09							
	63285	4	296.09							
	63278	10	296.09							
	63292	10A	296.09							
	63279	10B	339.63							
	63289	26	296.09							
	63290	26D	296.09							

Steel Standard Weight 5 Knuckle Bearing

TA2771
Price Code 50

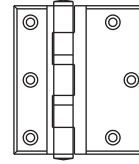

Size	Part Number	Finish	Price Each	Case Qty.	Box Qty.	Case Wgt.				
4 1/2" 114.30 mm	57525	P	68.98	24	3	27				
	57529	AP	68.98							
	57518	3	68.98							
	57519	4	68.98							
	57528	10	68.98							
	57534	10A	68.98							
	57530	10B	71.93							
	57524	26	68.98							
	57533	26D	57.01							
	5" 127 mm	57575	P				106.26	24	3	35
		57572	AP				106.26			
		57578	3				106.26			
		57579	4				106.26			
57576		10	106.26							
57584		10A	106.26							
57582		10B	121.89							
57573		26	106.26							
57577		26D	106.26							

Steel Heavy Weight Bearing

T4A3781
Price Code 50

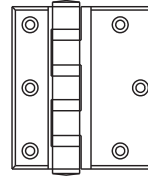

Size	Part Number	Finish	Price Each	Case Qty.	Box Qty.	Case Wgt.
4 1/2" 114.30 mm	58065	P	151.94	24	3	37
	58062	AP	151.94			
	72188	3	151.94			
	72189	4	151.94			
	72191	10	151.94			
	72198	10A	151.94			
	72192	10B	174.28			
	72195	26	151.94			
	58066	26D	151.94			
	5" 127 mm	58075	P			
72217		AP	172.58			
72221		3	172.58			
58076		4	172.58			
72223		10	172.58			
72231		10A	172.58			
72224		10B	197.96			
72227		26	172.58			
72228		26D	172.58			
6" 152.40 mm		58090	P	213.87	18	3
	58092	AP	213.87			
	72251	3	213.87			
	72252	4	213.87			
	72254	10	213.87			
	72262	10A	213.87			
	72255	10B	245.31			
	72258	26	213.87			
	72259	26D	213.87			

ASSA ABLOY

The global leader in door opening solutions

Steel Standard Weight Full Mortise Single Acting

1502
Price Code 71

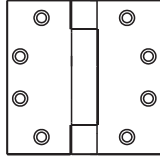

Size	Part Number	Finish	Price Each	Case Qty.	Box Qty.	Case Wgt.
4" x 4" 101.60 mm x 101.60 mm	155913	P	16.92	48	3	40
	155902	AP	23.29			
	155908	3	23.29			
	155903	4	23.29			
	155904	10	23.29			
	155928	10A	23.29			
	155905	10B	22.06			
	155911	26	21.17			
	155907	26D	14.34			
	155916	RC-26D	18.01			
	155901	D3	23.29			
	155929	D4	23.29			
	156002	P	27.02			
	156003	AP	34.75			
4 1/2" x 4" 114.30 mm x 101.60 mm	156010	3	31.59	48	3	54
	156004	4	34.75			
	156005	10	34.75			
	156031	10A	34.75			
	156006	10B	39.85			
	156009	26	31.58			
	156008	26D	22.33			
	156001	D3	34.75			
	156032	D4	34.75			
	156007	15	22.33			
	156011	9	34.75			
	156012	14	34.75			

Size	Part Number	Finish	Price Each	Case Qty.	Box Qty.	Case Wgt.
4 1/2" x 4 1/2" 114.30 mm x 114.30 mm	156017	P	15.89	48	3	54
	156018	AP	31.22			
	156025	3	25.80			
	156019	4	25.80			
	156020	10	25.80			
	156030	10A	28.38			
	156021	10B	29.58			
	156021E	10BE	24.11			
	156024	26	25.80			
	156023	26D	21.63			
	156016	D3	31.22			
	156015	D4	28.38			
	156022	15	21.63			
	156026	9	31.22			
156027	14	31.22				

Reverse Spring 1502R Price Code 71

Size	Part Number	Finish	Price Each	Case Qty.	Box Qty.	Case Wgt.
4 1/2" x 4 1/2" 114.30 mm x 114.30 mm	156034	P	30.89	48	3	54
	156035	26D	36.63			

For other finishes of 1502 R add \$15.75 to the 1502 price.

1502 x TRS Option \$3.50.

NOTE: Consult the Factory for information on our 1502 with new Security Feature.

1522
Price Code 71

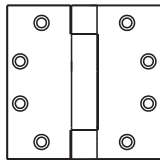

Size	Part No.	Fin.	Price Per Set	Set Qty.	Box Qty.	Case Wgt.
4 1/2" x 4" 114.30 mm x 101.60 mm	155981	P	81.05 SET	16 SETS	1 SET	54
	155982	AP	104.25 SET			
	155989	3	104.25 SET			
	155983	4	104.25 SET			
	155984	10	104.25 SET			
	155993	10A	104.25 SET			
	155985	10B	98.82 SET			
	156045E	10BE	81.86 SET			
	155988	26	104.25 SET			
	155987	26D	73.68 SET			
	155980	D3	104.25 SET			
	155994	D4	104.25 SET			
	155986	15	81.05 SET			
	155990	9	104.25 SET			
	155991	14	104.25 SET			

Size	Part No.	Fin.	Price Per Set	Set Qty.	Box Qty.	Case Wgt.
4 1/2" x 4 1/2" 114.30 mm x 114.30 mm	156041	P	52.44 SET	16 SETS	1 SET	54
	156042	AP	92.37 SET			
	156049	3	92.37 SET			
	156043	4	92.37 SET			
	156044	10	92.37 SET			
	156038	10A	92.37 SET			
	156045	10B	96.31 SET			
	156048	26	92.37 SET			
	156047	26D	63.85 SET			
	156040	D3	92.37 SET			
	156039	D4	92.37 SET			
	156046	15	63.85 SET			
	156050	9	92.37 SET			
	156051	14	92.37 SET			

Stainless Steel Standard Weight 1552 Price Code 71

Size	Part Number	Finish	Price Each	Case Qty.	Box Qty.	Case Wgt.
4 1/2" x 4" 114.30 mm x 101.60 mm	156056	32D	67.24 EA.	48	3	54
4 1/2" x 4 1/2" 114.30 mm x 114.30 mm	156080	32D	54.10 EA.	48	3	56

Allen Wrench set for 1502 / 1522 / 1552 Spring Hinges MK08808B @ \$2.25 per set

ASSA ABLOY

SH-1 The global leader in door opening solutions

MacPro® Spring Hinges

MPS60

Price Code 57



Size	Part Number	Finish	Price Each	Case Qty.	Box Qty.	Case Wgt.
4 1/2" x 4"	76388	15	6.63	48	3	54
114.30 mm x 101.60 mm						
4 1/2" x 4 1/2"	76380	P	6.27	48	3	54
	76385	15	6.63			
	76378	26D	6.63			
114.30 mm x 114.30 mm						

MPS679

Price Code 57



Set includes 2 Spring Hinges and 1 Bearing Hinge.

Size	Part No.	Fin.	Price Per Set	Set Qty.	Box Qty.	Case Wgt.
4 1/2" x 4 1/2"	76379	26D	16.41	16 SETS	1 SET	30
114.30 mm x 114.30 mm						

MK10379

Price Code 57

Cross pin for MPS60 0.25 ea.
Wrench is 0.50 ea.

Steel Door Spring Adjustable Tension

Price Code 72



Size	Part Number	Fin.	Price Each	Case Qty.	Box Qty.	Case Wgt.
9" 228.6 mm	451 155371	D4	10.63 EA.	50	-	53
11" 279.4 mm	452 155381	D4	12.83 EA.	25	-	34
13" 330.2 mm	453 155401	D4	14.81 EA.	25	-	38

Steel Full Mortise Double Acting Simplex Butt

1001

Price Code 72

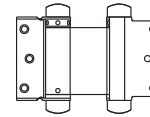

Size	Part Number	Finish	Price Each	Case Qty.	Box Qty.	Case Wgt.
3"	155582	P	31.69	40	2	50
	155581	1D	31.69			
	155585	2C	39.42			
	155587	3	44.43			
	155583	4	39.42			
	155584	10	39.42			
	155590	26	56.90			
	155588	26D	50.32			
	155633	P	33.38			
	155632	1D	33.38			
4"	155636	2C	41.93	24	2	45
	155638	3	46.79			
	155634	4	41.93			
	155635	10	41.93			
	155642	10A	60.43			
	155641	26	60.43			
	155639	26D	53.51			
	155673	P	46.46			
	155677	AP	50.78			
	155672	1D	46.46			
5"	155676	2C	57.70	16	2	53
	155678	3	64.63			
	155674	4	57.70			
	155675	10	57.70			
	155680	26	83.37			
	155681	26D	73.93			
	155712	P	50.78			
	155711	1D	51.00			
	155715	2C	64.05			
	155717	3	71.55			
6"	155713	4	64.05	12	2	56
	155714	10	64.05			
	155721	10A	92.01			
	155719	26	92.01			
	155720	26D	81.32			
	155751	P	56.90			
	155758	1D	56.90			
	155752	2C	71.00			
	155762	3	76.20			
	155756	4	71.00			
6" x 4 1/2"	155755	10	71.00	12	2	55
	155760	10A	102.11			
	155761	26	102.11			
	155754	26D	90.41			

Steel Full Mortise Double Acting Simplex Butt Non-Template

9001

Price Code 72

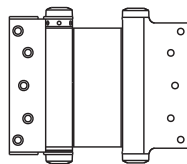

See page SH-4 for replacement parts.

Size	Part Number	Finish	Price Each	Case Qty.	Box Qty.	Case Wgt.
8"	158265	P	94.85	2	-	17
	158267	AP	104.71			
	158264	1D	94.85			
	158266	2C	116.73			
	158273	3	133.50			
	158274	4	116.73			
	158275	10	116.73			
	158277	10A	171.83			
	158272	26	171.83			
	158262	26D	150.92			

ASSA ABLUY

800-346-7707 | www.mckinneyhinge.com

Check the web site for the up-to-date catalog

McKinney is a brand associated with Corbin Russwin, Inc., an ASSA ABLUY Group company. Copyright © 2012-2017, Corbin Russwin, Inc. All rights reserved. Reproduction in whole or in part without the express written permission of Corbin Russwin, Inc. is prohibited.

The global leader in door opening solutions

Steel Full Mortise Double Acting Simplex Clamp Flange Butt

19001
Price Code 72

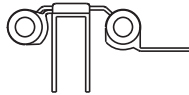

Size	Part Number	Finish	Price Each	Case Qty.	Box Qty.	Case Wgt.
8" 203.2 mm	159331	P	137.29	2	-	23
	159341	AP	148.87			
	159317	1D	137.29			
	159333	2C	170.85			
	159337	3	193.68			
	159335	4	170.85			
	159336	10	170.85			
	159338	10A	245.98			
	159340	26	245.98			
	159322	26D	220.45			

See page SH-4 for replacement parts.

HS1001
Price Code 72

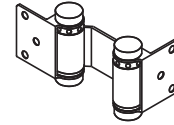

Size	Part Number	Finish	Price Each	Case Qty.	Box Qty.	Case Wgt.				
3" 76.20 mm	155787	P	31.69	20	2	26				
	155795	AP	34.98							
	155786	1D	31.69							
	155788	2C	39.42							
	155792	3	44.53							
	155790	4	39.42							
	155791	10	39.42							
	155796	10A	56.90							
	155797	26	56.90							
	155794	26D	50.32							
	4" 101.60 mm	155824	P				33.38	20	2	37
		155833	AP				33.96			
		155823	1D				33.38			
		155825	2C				41.93			
155828		3	46.79							
155832		4	41.93							
155830		10	41.93							
155834		10A	60.43							
155835		26	60.43							
155831		26D	53.51							

See page SH-4 for replacement parts.

Ajax Double Acting Horizontal Pivot Hinge

3001
Price Code 72

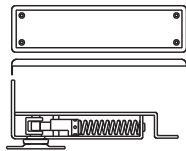

Size	Part Number	Finish	Price Each	Case Qty.	Box Qty.	Case Wgt.
	157076	P	64.39	8	1SET	29
	157080	1D	64.39			
	157081	2C	70.76			
	157079	3	87.70			
	157077	4	78.92			
	157078	10	70.76			
	157085	10A	103.47			
	157086	26	103.47			
	157084	26D	93.02			

3001 / J3001 SERIES each net
 TOP PIVOT & SOCKET 9.70
 JAMB ATTACHING PLATE* 16.50
 SIDE PLATE* 23.50
 BACK PLATE* 13.50

*Specify finish when ordering.

Ajax Double Acting Horizontal Pivot Hinge With Jamb Attaching Plate

J3001
Price Code 72

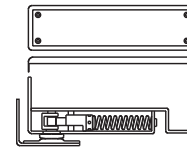

For concrete or tile floor installation

Size	Part Number	Finish	Price Each	Case Qty.	Box Qty.	Case Wgt.
	157116	P	69.63	10	1SET	33
	157124	1D	69.63			
	157119	2C	77.35			
	157120	3	93.92			
	157117	4	86.87			
	157118	10	77.35			
	157121	10A	113.94			
	157123	26	113.94			
	157122	26D	100.75			

ASSA ABLOY

SH-3 The global leader in door opening solutions

800-346-7707 | www.mckinneyhinge.com

Check the web site for the up-to-date catalog

McKinney is a brand associated with Corbin Russwin, Inc., an ASSA ABLOY Group company. Copyright © 2012-2017, Corbin Russwin, Inc. All rights reserved. Reproduction in whole or in part without the express written permission of Corbin Russwin, Inc. is prohibited.

Ajax Double Acting Horizontal Pivot Hinge

4007RB
Price Code 72

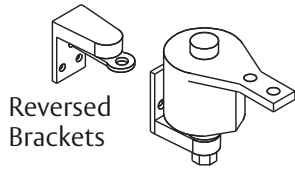

Reversed
Brackets

Size	Part Number	Finish	Price Each	Case Qty.	Box Qty.	Case Wgt.
	157371	P	128.01	10	1 SET	35
	157376	1D	128.01			
	157373	2C	173.08			
	157378	3	211.37			
	157377	4	173.08			
	157374	10	173.08			
	157375	10A	268.84			
	157379	26	268.84			
	157372	26D	241.34			

4007-MRB
Price Code 72

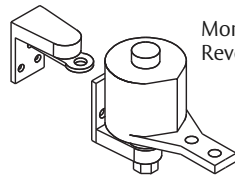

Mortised Box and
Reversed Brackets

Size	Part Number	Finish	Price Each	Case Qty.	Box Qty.	Case Wgt.
	157403	P	128.01	10	1 SET	35
	157412	1D	128.01			
	157405	2C	173.08			
	157407	3	211.37			
	157408	4	173.08			
	157404	10	173.08			
	157409	10A	268.84			
	157411	26	268.84			
	157406	26D	241.23			

4007RB/4007-MRB Series Replacement Parts
 TENSION PIN 1.85
 SPRING 16.59
 NYLON BUSHINGS 1.20
 TENSION RODS 1.65

8007
Price Code 72



Size	Part Number	Finish	Price Each	Case Qty.	Box Qty.	Case Wgt.
	158112	P	33.74	20	1 SET	25
	158116	1D	33.74			
	158114	2C	42.36			
	158115	3	48.05			
	158111	4	42.36			
	158113	10	42.36			
	158119	10A	60.65			
	158109	26	60.65			
	158118	26D	56.24			

H8007
Price Code 72

Size	Part Number	Finish	Price Each	Case Qty.	Box Qty.	Case Wgt.
	158152	P	39.42	20	1 SET	25
	158157	1D	39.42			
	158154	2C	49.64			
	158155	3	58.16			
	158156	4	54.83			
	158153	10	54.83			
	158158	10A	73.48			
	158160	26	73.48			
	158151	26D	68.71			

No replacement parts are available.

*Specify part number, size and finish when ordering.

REPLACEMENT PARTS FOR DOUBLE ACTING SPRING HINGES AND PIVOTS

McKINNEY Description	Finish	Needed	1001	1001	1001	1001	1001	9001	19001
	Required	Per Hinge	3"	4"	5"	6"	6x4 1/2"	8"	8"
T53 - Spring		2	11.83	11.83	11.83	11.83	19.64	23.77	39.32
T56 Tension Pin		2	2.04	2.04	2.04	2.09	2.09	2.09	2.24
TS550 Solid Metal Cap	X	4	11.12	11.12	11.12	16.73	16.73	21.57	21.57
TS510 Loose Knob	X	2	3.52	3.52	3.52	4.44	4.44	5.46	5.46
TS520 Fast Knob		2	3.52	3.26	3.16	4.44	4.44	5.46	5.41
TS525 Pawlnut	X	4	x	x	x	x	4.16	x	x
TS530 Tension Lever		1	2.04	2.04	2.04	2.09	2.09	2.09	2.30
TS540 Plug	X		x	x	x	5.41	5.41	x	x

Top Pivot and Socket

EP-5J
Price Code 11

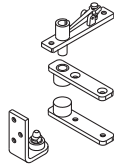

EP-5J Top Pivot and Socket 58.40
EP-5J Bottom Bracket and Bottom Door Socket 59.50
Screws for EP-5J 1.50 ea

Size	Part Number	Finish	Price Per Set	Case Qty.	Box Qty.	Case Wgt.
	63336	P	136.57	20	1	38
	63338	10	136.57			
	63346	26D	87.21			

For Cylindrical or Bored Locks

CSS-9
Price Code 11

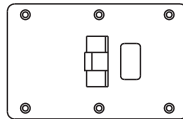

May not work with mortise locks. Consult the factory for mortise lock application. Not for use with deadbolt

Box and Plunger Assembly for DS-6 or CSS-9 60.35
Box only 8.25.
Springs only 1.35

Size	Part Number	Finish	Price Each	Case Qty.	Box Qty.	Case Wgt.
5 3/4" 146 mm	Center Hung	63309	10	154.59	As Ordered	
		63330	26D	102.28		
	Offset Hung	63310	10	154.59		
		63332	26D	102.28		
5 7/8" 149.225 mm	Center Hung	63314	10	154.59		
		63313	26D	102.28		
	Offset Hung	63294	10	154.59		
		63293	26D	102.28		
6 3/4" 171.40 mm	Center Hung	63331	26D	121.95		
	Offset Hung	63312	10	177.76		
	63329	26D	127.75			
Custom Sizes	63350		193.60			

Emergency Door Stop

DS-6
Price Code 11



Consult the factory for availability of custom sizes Custom Engineering and Set Up charges may apply

Size	Part Number	Finish	Price Per Set	Case Qty.	Box Qty.	Case Wgt.
	63337	10	146.09	20		12
	63345	26D	74.12			

Double Lipped Strike

DLS-8
Price Code 11

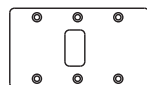

May not work with mortise locks. Consult the factory for mortise lock application. Not for use with deadbolt.

Consult the factory for availability of custom sizes Custom Engineering and Set Up charges may apply.

Size	Part Number	Finish	Price Each	Case Qty.	Box Qty.	Case Wgt.		
5 3/4" 146 mm	Center Hung	63260	10	73.51	As Ordered			
		63315	26D	56.16				
	Offset Hung	63317	10	73.51				
		63319	26D	56.16				
6 3/4" 171.40 mm	Center Hung	63263	10	81.00				
		63316	26D	62.91				
	Offset Hung	63318	10	81.00				
		63320	26D	65.90				
5 7/8" 149.225 mm	Center Hung	63342	26D	71.40				
7 3/4" 196.85 mm	Center Hung	63340	26D	71.40				
8 1/4" 209.55 mm	Center Hung	63341	26D	71.40				
Custom Size	63351		82.28					

MK22708 8-32X1/2 TORX SC FOR CSS-9 /DLS8 \$.80 each

ASSA ABLOY

RH-1 The global leader in door opening solutions

800-346-7707 | www.mckinneyhinge.com
Check the web site for the up-to-date catalog

McKinney is a brand associated with Corbin Russwin, Inc., an ASSA ABLOY Group company. Copyright © 2012-2017, Corbin Russwin, Inc. All rights reserved. Reproduction in whole or in part without the express written permission of Corbin Russwin, Inc. is prohibited.

Raised Barrel

Price Code 50

Size	Part Number	Finish	Price Each	Case Qty.	Box Qty.	Case Wgt.
4 1/2" x 4 1/2" 114.30 mm x 114.30 mm	55957 RBTA2714	26D	42.33	3	48	55
	58436 RBT4A3786	26D	61.41	3	24	35

Pocket Hinge

PH-4

Price Code 11
For Narrow Stile

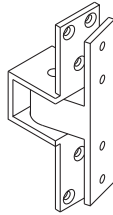

Size	Part Number	Finish	Price Each	Case Qty.	Box Qty.	Case Wgt.
	63531	P	328.91			AS ORDERED
	63533	3	328.91			
	63535	10	328.91			
	63537	10B	377.29			
	63538	26	328.91			
	63539	26D	162.53			

StormPro® Tornado Resistant Hinges

SP3386

Price Code 50

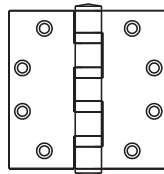

Size	Part Number	Finish	Price Each	Case Qty.	Box Qty.	Case Wgt.
4 1/2" x 4 1/2" 114.30 mm x 114.30 mm	73972	32D	120.59	3	24	37
	73982	32D	122.17	3	24	43

SP3786

Price Code 50

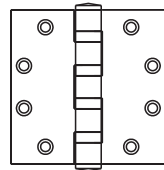

Size	Part Number	Finish	Price Each	Case Qty.	Box Qty.	Case Wgt.
4 1/2" x 4 1/2" 114.30 mm x 114.30 mm	73970	P	54.85	3	24	35
	73971	26D	59.49	3	24	35
5" x 4 1/2" 127 mm x 114.30 mm	73980	P	63.17	3	24	41
	73981	26D	66.45	3	24	41

All StormPro® products should be ordered as a complete integrated unit including the frame and door along with other StormPro® hardware. StormPro® hinges are a required component of the certified StormPro® system

Interim Hinges

Price Code 50



Door or Frame Leaf	Part Number	Finish	Opposite Leaf Trimmed To:
5"	57470	TA2714	4 1/2"
5"	57480	T4A3786	4 1/2"
5"	57475	T4A3386	4 1/2"

For finishes not listed, use \$2.00 over 26D price

All interim hinges are supplied with NRP set screw and no-hole plugs which allow them to be reversible. Leaves are trimmed the same dimension from the top and bottom of that leaf - otherwise a complete special must be manufactured, check for existence of available special part numbers which may have previously been manufactured

Specialty Hinges & Residential

1400 Price Code 14

Staggered Hole Pattern
on 4" x 4" Size

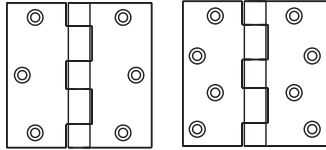

Size	Part Number	Finish	Price Each	Case Qty.	Box Qty.	Case Wgt.
3 1/2" x 3 1/2" 88.90 mm x 88.90 mm	56695	3	3.07	50	2	26
	56689	4	2.63			
	56683	10B*	3.07			
	56692	26	3.07			
	56288	26D	2.26			
4" x 4" 101.60 mm x 101.60 mm	56737	10B*	3.18	50	2	26
	56748	26D	2.49			

1414 Price Code 14

1/4" Radius

Staggered Hole Pattern
on 4" x 4" Size

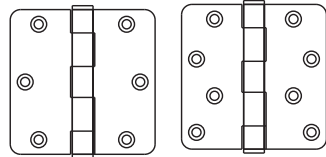

Size	Part Number	Finish	Price Each	Case Qty.	Box Qty.	Case Wgt.
3 1/2" x 3 1/2" 88.90 mm x 88.90 mm	56722	3	3.18	50	2	26
	56815	4	2.74			
	56716	10B*	2.89			
	56719	26	3.18			
	56821	26D	2.26			
4" x 4" 101.60 mm x 101.60 mm	56775	3	3.18	50	2	52
	56768	4	2.85			
	56769	10B*	3.18			
	56772	26	3.18			
	56773	26D	2.85			

1458 Price Code 14

5/8" Radius

Staggered Hole Pattern
on 4" x 4" Size

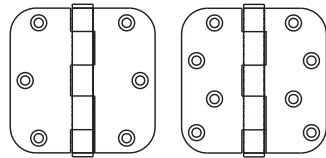

Size	Part Number	Finish	Price Each	Case Qty.	Box Qty.	Case Wgt.
3 1/2" x 3 1/2" 88.90 mm x 88.90 mm	56870	3	3.18	50	2	26
	56865	4	2.74			
	56861	10B*	3.18			
	56867	26	3.18			
	56868	26D	2.26			
4" x 4" 101.60 mm x 101.60 mm	56915	10B*	3.18	50	2	52
	56922	26D	2.85			

*Residential grade 10B Finish.

Residential Hinges available only in finishes shown above. Contract Grade Hinge Discount does not apply to Residential Grade Hinges. NOTE: Unlisted finishes for residential hinges P.O.A. Consult the Factory on minimum requirements.

Residential Grade Swing Clear Hinges

T2895

Price Code 50

Size	Part Number	Finish	Price Each	Case Qty.	Box Qty.	Case Wgt.
3 1/2" 88.90 mm	57060	1/4RC NL US4	73.25	24	3	19
	57061	5/8RC NL US4	73.25			
	57062	1/4RC NL US15	73.25			
	57063	5/8RC NL US15	73.25			
	57064	1/4RC NL 10BE	73.25			
	57065	5/8RC NL 10BE	73.25			

T2895

Price Code 50

Size	Part Number	Finish	Price Each	Case Qty.	Box Qty.	Case Wgt.
4" 101.60 mm	57066	1/4RC NL US4	75.70	24	3	36
	57067	1/4RC NL US15	75.70			
	57068	1/4RC NL U10BE	75.70			

0 Swage Hinges

RCTA2314

Price Code 50

Size	Part Number	Finish	Price Each	Case Qty.	Box Qty.	Case Wgt.
4 1/2" x 4" 114.30 mm x 101.60 mm	59505	32D-NRP	57.33	48	3	53
	59506	D3-NRP	69.06			
	59507	D4-NRP	75.98			

ASSA ABLOY

The global leader in
door opening solutions

2-Knuckle Architectural Hinges Price Code 20

*GT and LT tips not available in D4 and 10BE finishes. For options not offered in price book, contact factory. 2-Knuckle Hinges are handed RH or LH

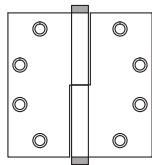

FT

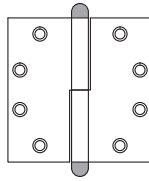

RT

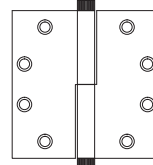

GT*

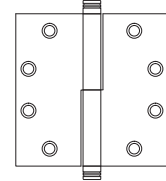

LT*

Part Number	
LH	RH
78010	78011

Tip Prefix	Hinge Type
FT GT LT RT	TA2731

Hinge Size
4 1/2" x 4" 114.30 mm x 101.60 mm

Hinge	Hinge Finish	Tips	Book Price
D4	x	US14	43.25
D4	x	US15	43.25
D4	x	US26	43.25
D4	x	US26D	43.25
D4	x	D4	43.25
10BE	x	10BE	38.90
US14	x	D4	51.95
US15	x	D4	45.70
US26	x	D4	51.95
US26D	x	D4	45.70
US14	x	US14	51.95
US14	x	US15	51.95
US15	x	US14	45.70
US15	x	US15	45.70
US26	x	US26D	51.95
US26D	x	US26	45.70
US26	x	US26	51.95
US26D	x	US26D	45.40

Part Number	
LH	RH
78014	78015

Tip Prefix	Hinge Type
FT GT LT RT	TA2731

Hinge Size
5" x 5" 127 mm x 127 mm

Hinge	Hinge Finish	Tips	Book Price
D4	x	US14	60.15
D4	x	US15	60.15
D4	x	US26	60.15
D4	x	US26D	60.15
D4	x	D4	60.15
10BE	x	10BE	55.20
US14	x	D4	73.00
US15	x	D4	64.90
US26	x	D4	73.00
US26D	x	D4	64.90
US14	x	US14	73.00
US14	x	US15	73.00
US15	x	US14	64.90
US15	x	US15	64.90
US26	x	US26D	73.00
US26D	x	US26	64.90
US26	x	US26	73.00
US26D	x	US26D	64.90

Part Number	
LH	RH
78012	78013

Tip Prefix	Hinge Type
FT GT LT RT	TA2731

Hinge Size
4 1/2" x 4 1/2" 114.30 mm x 114.30 mm

Hinge	Hinge Finish	Tips	Book Price
D4	x	US14	43.25
D4	x	US15	43.25
D4	x	US26	43.25
D4	x	US26D	43.25
D4	x	D4	43.25
10BE	x	10BE	38.90
US14	x	D4	51.95
US15	x	D4	45.70
US26	x	D4	51.95
US26D	x	D4	45.70
US14	x	US14	51.95
US14	x	US15	51.95
US15	x	US14	45.70
US15	x	US15	45.70
US26	x	US26D	51.95
US26D	x	US26	45.70
US26	x	US26	51.95
US26D	x	US26D	45.40

3-Knuckle Architectural Hinges Price Code 30

*GT and LT tips not available in D4 and 10BE finishes. For options not offered in price book, contact factory.

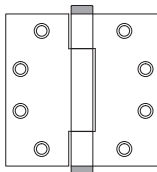

FT

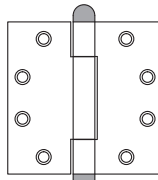

RT

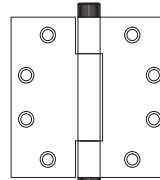

GT*

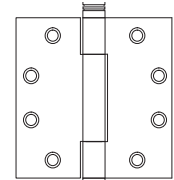

LT*

Part Number		Hinge Finish		Tips	Book Price
78020		Hinge			
		D4	x	US14	27.25
		D4	x	US15	27.25
		D4	x	US26	27.25
		D4	x	US26D	27.25
		D4	x	D4	27.25
		10BE	x	10BE	27.25
		US14	x	D4	30.40
		US15	x	D4	24.50
		US26	x	D4	30.40
US26D	x	D4	24.50		
US14	x	US14	30.40		
US14	x	US15	24.50		
US15	x	US14	24.50		
US15	x	US15	24.50		
US26	x	US26D	30.40		
US26D	x	US26	24.50		
US26	x	US26	30.40		
US26D	x	US26D	24.50		

Tip Prefix	Hinge Type
FT GT LT RT	TA714

Hinge Size
4" x 4" 101.60 mm x 101.60 mm

Part Number		Hinge Finish		Tips	Book Price
78021		Hinge			
		D4	x	US14	27.65
		D4	x	US15	27.65
		D4	x	US26	27.65
		D4	x	US26D	27.65
		D4	x	D4	27.65
		10BE	x	10BE	27.65
		US14	x	D4	28.55
		US15	x	D4	25.90
		US26	x	D4	28.55
US26D	x	D4	25.90		
US14	x	US14	28.55		
US14	x	US15	25.90		
US15	x	US14	25.90		
US15	x	US15	25.90		
US26	x	US26D	28.55		
US26D	x	US26	25.90		
US26	x	US26	28.55		
US26D	x	US26D	25.90		

Tip Prefix	Hinge Type
FT GT LT RT	TA714

Hinge Size
4 1/2" x 4" 114.30 mm x 101.60 mm

Part Number		Hinge Finish		Tips	Book Price
78022		Hinge			
		D4	x	US14	27.65
		D4	x	US15	27.65
		D4	x	US26	27.65
		D4	x	US26D	27.65
		D4	x	D4	27.65
		10BE	x	10BE	27.65
		US14	x	D4	28.55
		US15	x	D4	25.90
		US26	x	D4	28.55
US26D	x	D4	25.90		
US14	x	US14	28.55		
US14	x	US15	25.90		
US15	x	US14	25.90		
US15	x	US15	25.90		
US26	x	US26D	28.55		
US26D	x	US26	25.90		
US26	x	US26	28.55		
US26D	x	US26D	25.90		

Tip Prefix	Hinge Type
FT GT LT RT	TA714

Hinge Size
4 1/2" x 4 1/2" 114.30 mm x 114.30 mm

Part Number		Hinge Finish		Tips	Book Price
78023		Hinge			
		D4	x	US14	38.90
		D4	x	US15	38.90
		D4	x	US26	38.90
		D4	x	US26D	38.90
		D4	x	D4	38.90
		10BE	x	10BE	38.90
		US14	x	D4	43.95
		US15	x	D4	40.95
		US26	x	D4	43.95
US26D	x	D4	40.95		
US14	x	US14	43.95		
US14	x	US15	40.95		
US15	x	US14	40.95		
US15	x	US15	40.95		
US26	x	US26D	43.95		
US26D	x	US26	40.95		
US26	x	US26	43.95		
US26D	x	US26D	40.95		

Tip Prefix	Hinge Type
FT GT LT RT	TA714

Hinge Size
5" x 5" 127 mm x 127 mm

Part Number		Hinge Finish		Tips	Book Price
Order by Description		Hinge			
		D4	x	US14	52.30
		D4	x	US15	52.30
		D4	x	US26	52.30
		D4	x	US26D	52.30
		D4	x	D4	52.30
		10BE	x	10BE	52.30
		US3	x	US3	46.25
		US14	x	D4	52.30
		US15	x	D4	46.25
US26	x	D4	52.30		
US26D	x	D4	46.25		
US14	x	US15	52.30		
US15	x	US14	46.25		
US14	x	US14	52.30		
US15	x	US15	46.25		
US26	x	US26D	52.30		
US26D	x	US26	46.25		
US26	x	US26	52.30		
US26D	x	US26D	46.25		

Tip Prefix	Hinge Type
FT	TA786

Hinge Size
4 1/2" x 4 1/2" 114.30 mm x 114.30 mm

Part Number		Hinge Finish		Tips	Book Price
Order by Description		Hinge			
		D4	x	US14	64.00
		D4	x	US15	64.00
		D4	x	US26	64.00
		D4	x	US26D	64.00
		D4	x	D4	64.00
		10BE	x	10BE	64.00
		US14	x	D4	64.00
		US15	x	D4	61.00
		US26	x	D4	64.00
US26D	x	D4	61.00		
US14	x	US15	64.00		
US15	x	US14	61.00		
US14	x	US14	64.00		
US15	x	US15	61.00		
US26	x	US26D	64.00		
US26D	x	US26	61.00		
US26	x	US26	64.00		
US26D	x	US26D	61.00		

Tip Prefix	Hinge Type
FT	TA786

Hinge Size
5" x 5" 127 mm x 127 mm

ASSA ABLOY

DH-2 The global leader in door opening solutions

800-346-7707 | www.mckinneyhinge.com
Check the web site for the up-to-date catalog

McKinney is a brand associated with Corbin Russwin, Inc., an ASSA ABLOY Group company. Copyright © 2012-2017, Corbin Russwin, Inc. All rights reserved. Reproduction in whole or in part without the express written permission of Corbin Russwin, Inc. is prohibited.

5-Knuckle Architectural Hinges Price Code 50

5-Knuckle Architectural Hinges Split Finish only available with Standard Pin and Plug. For options not offered in price book, contact factory.

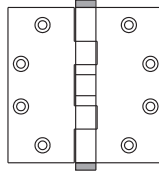

Part Number	Hinge Finish			Book Price
	Hinge	Tips		
78024	D4	x	US14	16.90
	D4	x	US15	16.90
	D4	x	US26	16.90
	D4	x	US26D	16.90
	D4	x	D4	16.90
Hinge Type	10BE	x	10BE	16.90
	US14		D4	18.00
	US15	x	D4	16.90
T2714	US26	x	D4	18.00
	US26D	x	D4	16.90
	US14	x	US14	18.00
Hinge Size	US14	x	US15	16.90
	US15	x	US14	18.00
	US15	x	US15	16.90
4" x 4" 101.60 mm x 101.60 mm	US26	x	US26D	18.00
	US26D	x	US26	16.90
	US26	x	US26	18.00
	US26D	x	US26D	16.90

Part Number	Hinge Finish			Book Price
	Hinge	Tips		
78025	D4	x	US14	19.45
	D4	x	US15	19.45
	D4	x	US26	19.45
	D4	x	US26D	19.45
	D4	x	D4	19.45
Hinge Type	US15	x	D4	19.45
	US26	x	D4	20.70
	US26D	x	D4	18.85
T2714	US14	x	US15	20.70
	US15	x	US15	18.85
	US26	x	US26D	20.70
Hinge Size	US26D	x	US26	18.85
	4 1/2" x 4"			
	114.30 mm x 101.60 mm			

Part Number	Hinge Finish			Book Price
	Hinge	Tips		
78026	D4	x	US14	19.45
	D4	x	US15	19.45
	D4	x	US26	19.45
	D4	x	US26D	19.45
	D4	x	D4	19.45
Hinge Type	10BE	x	10BE	19.45
	US14	x	D4	20.70
	US15	x	D4	18.85
T2714	US26	x	D4	20.70
	US26D	x	D4	18.85
	US14	x	US14	20.70
Hinge Size	US14	x	US15	18.85
	US15	x	US14	18.85
	US15	x	US15	18.85
4 1/2" x 4 1/2" 114.30 mm x 114.30 mm	US26	x	US26D	20.70
	US26D	x	US26	18.85
	US26	x	US26	20.70
	US26D	x	US26D	18.85

Part Number	Hinge Finish			Book Price
	Hinge	Tips		
78028	D4	x	US14	27.25
	D4	x	US15	27.25
	D4	x	US26	27.25
	D4	x	US26D	27.25
	D4	x	D4	27.25
Hinge Type	10BE	x	10BE	27.25
	US14	x	D4	30.40
	US15	x	D4	24.50
TA2714	US26	x	D4	30.40
	US26D	x	D4	24.50
	US14	x	US14	30.40
Hinge Size	US14	x	US15	24.50
	US15	x	US14	24.50
	US15	x	US15	24.50
4" x 4" 101.60 mm x 101.60 mm	US26	x	US26D	30.40
	US26D	x	US26	24.50
	US26	x	US26	30.40
	US26D	x	US26D	24.50

Part Number	Hinge Finish			Book Price
	Hinge	Tips		
78029	D4	x	US14	27.65
	D4	x	US15	27.65
	D4	x	US26	27.65
	D4	x	US26D	27.65
	D4	x	D4	27.65
Hinge Type	10BE	x	10BE	27.65
	US14	x	D4	28.55
	US15	x	D4	25.90
TA2714	US26	x	D4	25.55
	US26D	x	D4	25.90
	US14	x	US14	28.55
Hinge Size	US14	x	US15	25.90
	US15	x	US14	25.90
	US15	x	US15	25.90
4 1/2" x 4" 114.30 mm x 101.60 mm	US26	x	US26D	28.55
	US26D	x	US26	25.90
	US26	x	US26	25.55
	US26D	x	US26D	25.90

Part Number	Hinge Finish			Book Price
	Hinge	Tips		
78027	D4	x	US14	32.00
	D4	x	US15	32.00
	D4	x	US26	32.00
	D4	x	US26D	32.00
	D4	x	D4	32.00
Hinge Type	10BE	x	10BE	32.00
	US14	x	D4	40.25
	US15	x	D4	32.85
T2714	US26	x	D4	40.25
	US26D	x	D4	32.85
	US14	x	US14	40.25
Hinge Size	US14	x	US15	32.85
	US15	x	US14	32.85
	US15	x	US15	32.85
5" x 5" 127 mm x 127 mm	US26	x	US26D	40.25
	US26D	x	US26	32.85
	US26	x	US26	40.25
	US26D	x	US26D	32.85

Continued on next page

800-346-7707 | www.mckinneyhinge.com
Check the web site for the up-to-date catalog

McKinney is a brand associated with Corbin Russwin, Inc., an ASSA ABLOY Group company. Copyright © 2012-2017, Corbin Russwin, Inc. All rights reserved. Reproduction in whole or in part without the express written permission of Corbin Russwin, Inc. is prohibited.

ASSA ABLOY

The global leader in door opening solutions

5-Knuckle Architectural Hinges (Continued) Price Code 50

5-Knuckle Architectural Hinges Split Finish only available with Standard Pin and Plug. For options not offered in price book, contact factory.

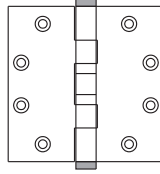

Part Number	Hinge Finish		Tips	Book Price
	Hinge			
78030	D4	x	US14	32.00
	D4	x	US15	32.00
	D4	x	US26	32.00
	D4	x	US26D	32.00
	D4	x	D4	32.00
Hinge Type	10BE	x	10BE	32.00
	US14	x	D4	40.25
	US15	x	D4	32.85
TA2714	US26	x	D4	40.25
	US26D	x	D4	32.85
	US14	x	US14	40.25
Hinge Size	US14	x	US15	32.85
	US15	x	US14	32.85
	US15	x	US15	32.85
4 1/2" x 4 1/2" 114.30 mm x 114.30 mm	US26	x	US26D	40.25
	US26D	x	US26	32.85
	US26	x	US26	40.25
	US26D	x	US26D	32.85
	US26D	x	US26D	32.85

Part Number	Hinge Finish		Tips	Book Price
	Hinge			
78031	D4	x	US14	38.90
	D4	x	US15	38.90
	D4	x	US26	38.90
	D4	x	US26D	38.90
	D4	x	D4	38.90
Hinge Type	10BE	x	10BE	38.90
	US14	x	D4	43.95
	US15	x	D4	40.95
TA2714	US26	x	D4	43.95
	US26D	x	D4	40.95
	US14	x	US14	43.95
Hinge Size	US14	x	US15	40.95
	US15	x	US14	40.95
	US15	x	US15	40.95
5" x 5" 127 mm x 127 mm	US26	x	US26D	43.95
	US26D	x	US26	40.95
	US26	x	US26	43.95
	US26D	x	US26D	40.95
	US26D	x	US26D	40.95

Square Barrel Hinges

Price Code 20

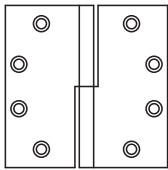

Hinges are handed, offered in special .177" weight only, and cannot be electrified. For options not offered in price book, contact factory.

Part Number	Hinge Type	Hinge Size	Hinge Finish	Book Price
75840	75841	4 1/2" x 4 1/2" 114.30 mm x 114.30 mm	3	58.00
75842	75843		10B	64.00
—	—		10BE	58.00
75844	75845		14	58.00
75742	75743		15	56.00
75846	75847		26	58.00
75744	75745		26D	56.00
SQ3331				

Square Barrel 3-Knuckle Hinges

Price Code 20

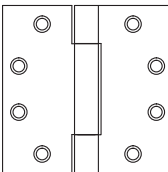

Hinges are non-handed, offered in special .177" weight stainless steel only and cannot be electrified.

Part Number	Hinge Type	Hinge Size	Hinge Finish	Book Price
75850	SQ314	4 1/2" x 4"	32D	56.00
		114.30 mm x 101.60 mm		
75851		4 1/2" x 4 1/2"		
		114.30 mm x 114.30 mm		

Olive Knuckle Hinges

Price Code 20

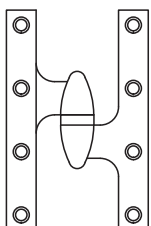

Hinges are handed, offered in standard weight only, and cannot be electrified. For options not offered in price book, contact factory.

Part Number	Hinge Type	Hinge Size	Hinge Finish	Book Price
76204	76205	6" 152.40 mm x 152.40 mm	3	58.00
76204NL	76205NL		3NL	56.00
76206	76207		10B	64.00
—	—		10BE	58.00
76208	76209		14	58.00
76200	76201		15	56.00
76210	76211		26	58.00
76202	76203		26D	56.00
TA3383				

ASSA ABLOY

The global leader in door opening solutions

Listing: R12248



McKINNEY aluminum continuous hinges have been tested and certified by Underwriters Laboratories, Inc. (U.S.A. and Canada) for up to a 3-hour (A Label) Fire Listing for all 4'0" x 10'0" and 8'0" x 10'0" door and frame assemblies. Fire listing certification applies to all approved hollow metal and wood door assemblies in dry wall or masonry wall construction. No special preparations are required for up to 90 minutes. Fire Pins, which also increase the security of the door are required for 3-hour applications. Fire Pin applications fall within the UL guidelines for retrofitting assemblies in the field. Cutting the hinge in the field will not void the UL listing. Drilling locations for Fire Pins are found on each template. The most up to date templates are found on our web site at www.mckinneyhinge.com

All models are approved for UL retrofit applications per NFPA 80.

These hinges conform to ANSI / BHMA Standard A156.26-2000:

Grade 2-150 (150 # Door @ 1,500,000 cycles)	Grade 2-300 (300 # Door @ 500,000 cycles)
Grade 1-300 (300 # Door @ 1,000,000 cycles)	Grade 1-600 (600 # Door @ 500,000 cycles)

Available Options:

(Consult individual pages for availability of option with profile listed)

- Current Carrying Hinges: Each QC4 cable will carry 16 amps continuous at 24 volts in-rush for 820 milliseconds. When ordering, please specify where the modification is to be located from the top of the hinge down to the centerline of prep. Handing is required on all hinges provided with electrical modifications. Molex connectors with ElectroLynx® are warranted for 5 years. Molex connectors are included at each leaf for ease of electrical connection. Each electrical prep is supplied with a 180" cable lead. QC hinges are available with additional options, SER (Serviceable) and ACC (Accessible).
- MM – Magnetic Monitoring Transfer also available with SER and ACC Options.
- QC – ElectroLynx™ Connectors also available with SER (Serviceable) and ACC (Accessible) Options.
- EPT – Power Transfer Prep (Cut Out Only) for Von Duprin. See page CH-10 for location template. This template must be filled out and included with your order.
- PT – Power Transfer Prep (Cut Out Only) – for Securitron, Yale, Centurion, Dorma or Adams Rite. Refer to page CH-10 for location template. This template must be filled out and included with your order.
- Custom Cut to Length (Hinges may be field cut and not void listing. Field-Cut hinges should be cut from bottom)
- Fire Pins Kit – While hinges are rated without fire pins up to 90 minutes, 3-hour ratings require the use of fire pins. Fire pin kit consists of 4 each for 80-95 inch hinges and 5 each for 96 to 120 inch hinges, as well as the installation instructions on what size holes to drill after the hinges have been installed.
- Hospital Type Tips are available on full mortise hinges
- Specify "K" pre-fix for Kawneer Tuffline Series Aluminum Doors on our MCK-12HD Series, order as K-MCK-12HD and include size and finish
- Painted Colors
 - Gear Cap Only - Batch charge and additional charge per hinge
 - Complete Hinge - Batch charge and additional charge per hinge (minimum run 20 hinges) POA

Lengths

McKINNEY aluminum continuous geared hinges are listed and priced here in 79", 83", 85", 95" and 120" actual lengths for ease of installation on standard nominal door openings. The actual length of the hinge provides for head and threshold clearance.

Custom lengths may be ordered as a special run. Consult the factory regarding minimum requirements and non-cancellation policy on custom lengths.

Hinges may be cut to appropriate length in the field. The hinge should be installed with the cut side on the bottom. Cutting in the field does not void the listing. We recommend that after removing cap, a saw blade be used to score and always begin cut at gear head. Never at leaves.

Cut only from bottom of hinge. Do not cut through bearings or screw holes.

12HD - 14HD - 25HD

Option	Price Each
SN - Satin Nickel	40.00 over CLEAR
G - Gold Anodized	Same as BRONZE
BL - Black Anodized	20% over BRONZE
QC-4*	175.00
QC-8*	200.00
QC-12*	335.00
ACC-4*	195.00
ACC-8*	225.00
ACC-12*	350.00
SER-4*	195.00
SER-8*	225.00
SER-12*	350.00
MM*	125.00
EPT Prep for Von Duprin	56.00
PT	56.00
HT*	56.00
Custom Cut to Length*	10.25
FIREPIN-C4 (For 80"-95" hinge)	38.75
FIREPIN-C5 (For 96"-120" hinge)	43.80
Dutch Door Prep*	47.00
Painted Colors	P.O.A.
For QC-12 order one of each of the above	
Fastener Kits (one kit required up to 95" 2 kits for 120")	
FMK-CL (71502)	17.00
FMK-BZ (71503)	17.00
Torx Screws	15.80
PBS12150SP10R21 wood screw pack (21 ea per bag)	\$10.00
PBS12150SP10BLR21 wood screw pack (21 ea per bag)	\$10.00

Replacement SER Sections 12HD

Option	Price Each
94104 SER-4 CL Section	205.00
94105 SER-4 BZ Section	205.00
94106 SER-8 CL Section	235.00
94107 SER-8 BZ Section	235.00
94108 SER-12 CL Section	360.00
94109 SER-12 BZ Section	360.00

When ordering advise location for electrical options from top of hinge to center-line of electrical prep location. Handing is required for hinges with electrical prep.

* Handing Required

Refer to pages CH-10 for the appropriate power transfer locator template. This template must be filled out and included with your order.

Gold or other custom finishes may have 6-8 week lead time.

For 1-3/4 Plastic Laminate Doors request PBS12150SP10 (#12 wood screw with #10 head, 1½' long, available SS or BL \$10.00 per pack of 21

ASSA ABLOY

CG-2 The global leader in door opening solutions

22HD - 54HD - 58HD

Option	Price Each
SN - Satin Nickel	40.00 over CLEAR
G - Gold Anodized	Same as BRONZE
BL - Black Anodized	20% over BRONZE
QC-4*	300.00
QC-8*	350.00
QC-12*	465.00
HT*	56.00
Custom Cut to Length*	10.25
FIREPIN-C4 (For 80"-95" hinge)	38.75
FIREPIN-C5 (For 96"-120" hinge)	43.80
Painted Colors	P.O.A.
For QC-12 order one of each of the above	
C1 Repl Cover 22HD CL	28.00
D1 Repl Cover 22HD BZ	30.00
C1 Repl Cover 54HD CL	28.00
D1 Repl Cover 54HD BZ	30.00
C2931C Repl Cover 58HD Frame Side	28.00
D2931D Repl Cover 58HD Frame Side	28.00

Specify length

Door Side

Option	Price Each
C1-83 / D1-83	28.00
C1-85 / D1/85	28.00

22HD & 54HD

Fastener Kits (one kit required up to 95" 2 kits for 120")

Option	Price Each
FSHSK-CL (77350)	17.00
FSHSK-BZ (77351)	17.00

58HD

Option	Price Each
58K-CL (77348)	17.00
58K-BZ (77349)	17.00

FOR 22HD & 54HD

Option	Price Each
SB14100Z4 (4 pack)	
Shoulder bolt (Zinc) 1/4-20 X 1"	
TB1420Z4 (4 pack)	
Thru-Bolt (Zinc) 1/4-20 X 1 5/8"	

Full Mortise Edge Hung Flush Door MCK-12HD Heavy Duty Price Code 80

Product	Size	Part Number	Finish	Price Each	Crtn Qty.	Crtn Wgt.
	79"	76716	CLEAR	88.46	1	8
	79"	76741	BRONZE	114.41		
	83"	76717	CLEAR	88.46		
	83"	76742	BRONZE	114.41		
	85"	76718	CLEAR	89.87		
	85"	76743	BRONZE	115.89		
	95"	76719	CLEAR	106.42	1	11
	95"	76744	BRONZE	140.58		
	120"	76720	CLEAR	171.52		
	120"	76745	BRONZE	215.20		

K-MCK-12HD Price Code 80

For Kawneer Tuffline Series Aluminum Doors, pre-fix the MCK-12HD series with "K", example 83" K-MCK-12HD CL

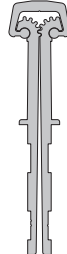
Product	Size	Part Number	Finish	Price Each	Crtn Qty.	Crtn Wgt.
	83"	76826	CLEAR	88.46		

Other sizes available same as MCK-12HD CL price.

MCK-WTHD Heavy Duty Price Code 80

Product	Size	Part Number	Finish	Price Each	Crtn Qty.	Crtn Wgt.
	83"	76822	CLEAR	195.73	1	8
	83"	76823	BRONZE	282.86		
	95"	76824	CLEAR	282.86		
	95"	76825	BRONZE	369.93		

120" CL \$307.95 (WTCFM120HD1)
Not available BZ

MCK-14HD Heavy Duty Price Code 80

Product	Size	Part Number	Finish	Price Each	Crtn Qty.	Crtn Wgt.
	79"	76751	CLEAR	89.87	1	8
	79"	76776	BRONZE	116.94		
	83"	76752	CLEAR	89.87		
	83"	76777	BRONZE	116.94		
	85"	76753	CLEAR	91.33		
	85"	76778	BRONZE	118.41		
	95"	76754	CLEAR	109.02	1	11
	95"	76779	BRONZE	143.52		
	120"	76755	CLEAR	178.40		
	120"	76780	BRONZE	232.55		

Full Mortise Edge Hung Inset Door MCK-22HD Heavy Duty Price Code 80

Product	Size	Part Number	Finish	Price Each	Crtn Qty.	Crtn Wgt.
	79"	76771	CLEAR	148.02	1	11
	79"	76796	BRONZE	206.24		
	83"	76772	CLEAR	148.02		
	83"	76797	BRONZE	206.24		
	85"	76773	CLEAR	149.49		
	85"	76798	BRONZE	208.36		
	95"	76774	CLEAR	185.75	1	11 1/2
	95"	76799	BRONZE	255.35		
	120"	76775	CLEAR	276.68		
	120"	76800	BRONZE	380.43		

Complete installation hardware kit which includes 12-24 x 7/16" Phillips, Flat Head Undercut, Zinc screws for frame leaf, and thru bolts and shoulder screws for the door leaf are provided as standard pack unless otherwise specified.

MCK-25HD Heavy Duty Price Code 80

Product	Size	Part Number	Finish	Price Each	Crtn Qty.	Crtn Wgt.
	79"	76706	CLEAR	92.18	1	9
	79"	76731	BRONZE	111.47	1	9
	83"	76707	CLEAR	94.22	1	9
	83"	76732	BRONZE	113.02	1	9
	85"	76708	CLEAR	97.30	1	9
	85"	76733	BRONZE	117.72	1	9
	95"	76709	CLEAR	120.84	1	10
	95"	76734	BRONZE	135.39	1	10
	120"	76710	CLEAR	179.87	1	15
	120"	76735	BRONZE	203.37	1	15

MCK-28HD Heavy Duty Price Code 80

Product	Size	Part Number	Finish	Price Each	Crtn Qty.	Crtn Wgt.
	83"	76920	CLEAR	137.98	1	10
	83"	76924	BRONZE	160.20	1	10
	85"	76921	CLEAR	139.45	1	10
	85"	76925	BRONZE	161.62	1	10
	95"	76922	CLEAR	160.79	1	11
	95"	76926	BRONZE	197.76	1	11
	120"	76923	CLEAR	247.74	1	14
	120"	76927	BRONZE	254.25	1	14

To order, specify length and finish. Hinges are supplied with # 12-24 x 7/16" Flat Head Undercut, Type C, thread-forming screws.

Available Options:

Option (Suffix)	Each Net Add
Custom Cut to Length*	10.25
Fire Pin Kit:	
FIREPIN-C4 (For 80"-95" hinge)	38.75
FIREPIN-C5 (For 96"-120" hinge)	43.80
Painted Colors:	
Gear Cap Only	P.O.A
Complete Hinge	P.O.A.

* Requires Handing

Fire Pins are required on 3 hour rated doors only.

Full Mortise Safety Hinges

MCK-35HD.....Same Pricing as MCK-12HD

MCK-38HD.....Same Pricing as MCK-12HD

ASSA ABLOY

The global leader in
door opening solutions

Continuous Hinges Full Surface

MCK-54HD

Heavy Duty

Price Code 80

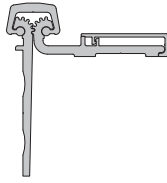

Size	Part Number	Finish	Price Each	Crtn Qty.	Crtn Wgt.
79"	76761	CLEAR	137.99	1	10
79"	76786	BRONZE	168.15		
83"	76762	CLEAR	137.99		
83"	76787	BRONZE	168.22		
85"	76763	CLEAR	139.46	1	11
85"	76788	BRONZE	169.70		
95"	76764	CLEAR	168.85	1	11
95"	76789	BRONZE	207.64		
120"	76765	CLEAR	260.12	1	14
120"	76790	BRONZE	335.95		

Complete installation hardware kit which includes 12-24 x 7/16" self-tapping, Phillips, Flat Head Undercut, Zinc screws for frame leaf, and thru bolts and shoulder screws for the door leaf are provided as standard pack unless otherwise specified.

MCK-58HD

Heavy Duty

Price Code 80



Size	Part Number	Finish	Price Each	Crtn Qty.	Crtn Wgt.
79"	76811	CLEAR	130.06	1	11
79"	76812	BRONZE	155.38		
83"	76813	CLEAR	131.81		
83"	76814	BRONZE	156.93		
85"	76815	CLEAR	135.18	1	11 1/2
85"	76816	BRONZE	160.16		
95"	76817	CLEAR	141.08	1	11 1/2
95"	76818	BRONZE	185.42		
120"	76819	CLEAR	247.15	1	14
120"	76820	BRONZE	278.50		

Complete installation hardware kit which includes 12-24 x 7/16" x #10 head, Thread-Forming, Flat Head Undercut screw for the frame leaf. Door leaf fasteners are 7/8"-20 shoulder bolts and thru bolts for 1 1/2" door.

Available Options:

Option (Suffix) Refer to Page CG-3

ASSA ABLOY

The global leader in door opening solutions

800-346-7707 | www.mckinneyhinge.com

Check the web site for the up-to-date catalog

McKinney PT Information Form

In order to assign an accurate ship date and begin production of your order, please provide us with the information requested. We appreciate your cooperation and time to assist us in providing you with the type of product that will meet our requirements.

ALL PT LOCATIONS ARE REQUIRED FROM TOP OF DOOR TO CENTERLINE OF PREP

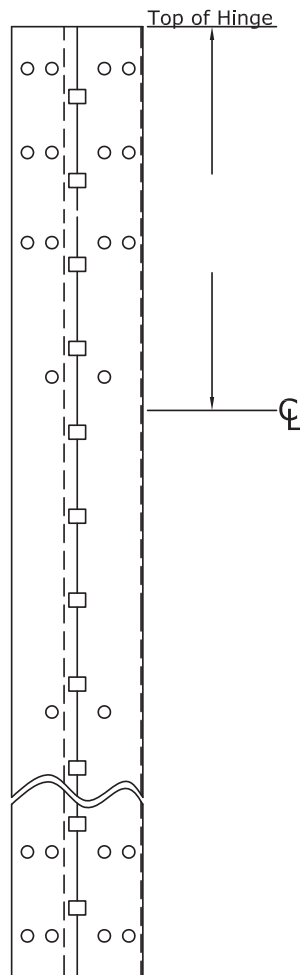

Company Name: _____
 Contact Name: _____
 P.O.#: _____
 Job Name: _____
 Phone Number: _____
 Fax Number: _____

CTP (Power Transfer Model)

- Pemko/Markar EL-CEPT
- Pemko/Markar EL-EPT ***
- Pemko/Markar EL-EPTL ***
- Pemko/Markar EL-EPT-SC
- Securitron CEPT
- Securitron EPT/Adams Rite 4612-1 ***
- Securitron EPTL/Adams Rite 4612-2 ***
- Securitron EPT-SC/Adams Rite 4612-SC
- Von Duprin EPT-2 & EPT-10
- Precision ***
- Other (Template Needed) _____

Mortise Prep In *** (needed)

- Frame Leaf
- Door Leaf

Hinge Length: _____
 RHR/LH: _____
 LHR/RH: _____

Notes: _____

Order acknowledgement will be sent after all information requirements are met to determine a ship date

Numbering System & Standard Lengths

Hinge Prefixes

EG	Edge Guard
FM	Edge Mount
FS	Full Surface
HG	Hinge/Guard
HM	Half Mortise
HS	Half Surface
SC	Swing Clear

Hinge Series

This series number indicates the type of hinge and base material used:

MCK-3700	Carbon steel barrel hinges with stainless pin
MCK-300	Stainless steel barrel hinges with stainless pin
MCK-3500	12 Gauge stainless steel pin and barrel security hinges

Hinge Models

00	Edge mount (formerly full mortise)
01	Full surface, 1/8" offset
02	Full surface, flush
03	Half surface, 1/8" offset
04	Half mortise, 1/8" offset
05	Edge mount hinge/guard
06	Half mortise hinge/guard
08	Edge guard
09	Full surface, swing clear
10	Swing clear hinge/guard
11	Edge mount, self aligning
15	Edge mount, self aligning flush edge guard
21	Full surface inset, 3/4" offset
22	Edge mount hinge/guard, deep
23	Edge mount hinge/guard, deep, thru bolt
25	Edge mount swing clear
26	Edge mount hinge/guard, swing clear
27	Edge mount, safety hinge
29	Edge mount, self aligning

Option Suffixes

AS	Adjust-A-Screws
AMS	Adjustable Monitoring Switch
CTP	Current Transfer Preparation
EL	ElectroLynx® Current Transfer
PoE	Power Over Ethernet
ETAP	Electrical Transfer Access Prep

*The MP-EMAP was changed to MP-ETAP. There is no prepping necessary for the MP-ETAP, although the frame and door need to be prepped for the EL12.

EPT	Electrical Power Transfer
HT	Hospital Tip
LL	Lead Lined
PC	Powder Coated
RB	Raised Barrel
WT	Wide Throw

Standard Hinge Length Conversion Chart

A 6'8"	door opening =	an actual length of 79 ³ / ₁₆ " (handed)
A 7'0"	door opening =	an actual length of 83 ¹ / ₈ "
A 7'2"	door opening =	an actual length of 85 ¹ / ₈ " (handed)
A 8'0"	door opening =	an actual length of 95"
A 10'0"	door opening =	an actual length of 118 ³ / ₄ "

Custom hinge length will be evaluated at the time of request to ensure proper pin to knuckle alignment. Some custom length requests may be adjusted to ensure a proper hinge assembly.

Specify handing on all custom hinge lengths

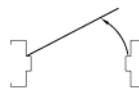

LEFT HAND



RIGHT HAND

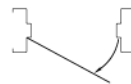

LEFT HAND REVERSE

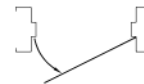

RIGHT HAND REVERSE

Standard Powder Coat Finishes

POA

BHMA #	Nearest McKINNEY Equivalent	Description
690	MP-PC-1	Dark Bronze
714	MP-PC-2	Eggshell White
693	MP-PC-3	Semi Gloss Black
689	MP-PC-4	Aluminum
706	MP-PC-5	Sun Gold
691	MP-PC-6	Light Bronze

For FM300 Series Only

POA

605	MP-PC-7	Polished Brass
-----	---------	----------------

Kynar Paint with Color Approval - POA

Adjust-A-Screws for MCK-HG-305; HG-310; HG-322; HG-323; HG326

7'	Requires 21	
8'	Requires 23	\$1.20 ea.
10'	Requires 27	

ASSA ABLOY

CH-1 The global leader in door opening solutions

800-346-7707 | www.mckinneyhinge.com
Check the web site for the up-to-date catalog

McKinney is a brand associated with Corbin Russwin, Inc., an ASSA ABLOY Group company. Copyright © 2012-2017, Corbin Russwin, Inc. All rights reserved. Reproduction in whole or in part without the express written permission of Corbin Russwin, Inc. is prohibited.

Continuous Hinge Modifications

Cut to Size Charge	ADDITIONAL PRICE
Please specify handing on all custom hinge lengths.	
For hinges 40" to 83 ¹ / ₈ " in length	+30.15 to 7'0" price
For hinges 83 ³ / ₁₆ " to 95" in length	+30.15 to 8'0" price
For hinges 95 ¹ / ₁₆ " to 118 ³ / ₄ " in length	+30.15 to 10'0" price
For hinges 118 ¹³ / ₁₆ " to 192" in length	POA
Handing Required	

PRODUCT	SUFFIX	ADDITIONAL PRICE
Hospital Tip	-HT	+41.70/hinge

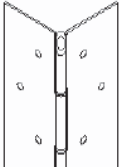

Available on all models except spring-loaded toilet partition hinges.
Helps provide a safe, clean environment.
Handing Required

PRODUCT	SUFFIX	ADDITIONAL PRICE
Wide Throw	-WT	POA

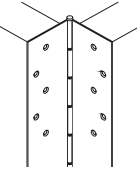

Only available on 300 series hinges.
Specify distance from pin centerline to heel edge of hinge when ordering.
Reinforcement may be required on extreme wide throw applications.

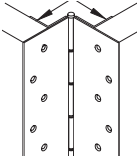

These conditions will be determined through a drawing approval process.
Cost will be determined at time of approval.
Custom Angle: 97.39 per angle

Automatic Door Bottom Cut	+34.70
Weld End Pins	+45.75

PRODUCT	SUFFIX	ADDITIONAL PRICE
		Available on all edge mount and half surface models except on Aluminum hinges.

PRODUCT	SUFFIX	ADDITIONAL PRICE
Lead Lined Cover	-LL	+50.27/cover
Lead lined astragal for EGT	+85.95/astragal	

Only available on surface mounted Hinges.
Used for x-ray room doors and other locations where radiation leakage could be a problem.

PRODUCT	ADDITIONAL PRICE
Security Studs	+ 77.00/hinge up to 85" + 88.00/hinge over 85"

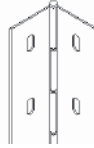

Stainless steel security studs mounted to the frame leaf.
Door leaf is drilled to accommodate studs Three studs installed on hinges up to 85" Four studs installed on hinges over 85" Door and frame must be specially prepared to accommodate security studs.

PRODUCT	ADDITIONAL PRICE
Raised Barrel (Swaged)	+35.00

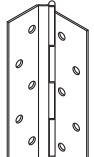

For cased open or center pivot doors. Available on all edge mount and half surface models.

Continuous Hinge & Edge Guard Modifications

PRODUCT ADDITIONAL PRICE

EL Concealed Circuit

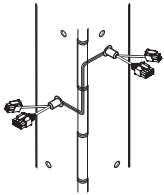

For 300, 3500, and 3700 series Edge mount only. Not available on Raised Barrel applications.

ElectroLynx®

EL-4	+226.18
EL-8	+301.58
EL-12	+402.09
POE	Power over Ethernet +521.25

PRODUCT ADDITIONAL PRICE

Electrical Modification Access Prep (formerly ETAP)

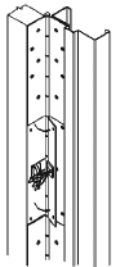

Cutout prep for the AMS & EL. Modifications that allows easy one person access to wiring between the hinge and door/frame.

MP-EMAP +88.46/per

PRODUCT ADDITIONAL PRICE

PoE Power Over Ethernet

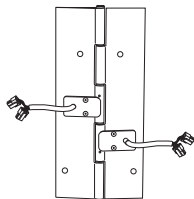

For 300, 3500 and 3700 series edge mount only. With ElectroLynx® connectors (9 wire) and Electrical Transfer Access Prep (ETAP).

PoE Power over Ethernet +521.25

PRODUCT ADDITIONAL PRICE

PT or EPT Power Transfer Prep (formerly CPT)

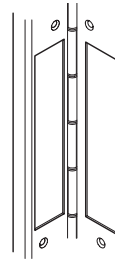

Centerline of hinge is standard location by submitting the Power Transfer Template located on page Ch-10.

Please provide location and handing for all locations.

For swing clear models +60.25/hinge
For all other models +48.25/hinge

PRODUCT ADDITIONAL PRICE

AMS Adjustable Monitoring Switch

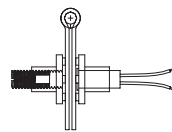

Rigid welded assembly gives you the ability to adjust your monitoring switch to work with all applications.

Not available on aluminum hinges or powder coat finishes.

+240.25 /hinge
+88.46 prep charge
(see MP-EMAP)

Standard Screw Pack (see following pages for additional Screw Packs)

- Standard Screw Pack for FM300; HG305; HG311; HG315 - KMPSS \$8.00
- Standard Screw Pack for FM3500; FS3501; FS3502; HG3505 - MS1244SP10SS24
- Standard Screw Pack for FS301; FS302 - M91-0003-630
- Standard Screw Pack for HS303; HM304; HG306 - M91-0003-630, TKS1267SP10SS23
- Security Fastener USE -TKS1267SP10SS24



ASSA ABLOY

The global leader in door opening solutions

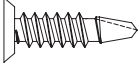
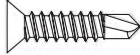
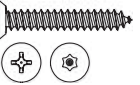
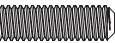

800-346-7707 | www.mckinneyhinge.com
Check the web site for the up-to-date catalog

McKinney is a brand associated with Corbin Russwin, Inc., an ASSA ABLOY Group company. Copyright © 2012-2017, Corbin Russwin, Inc. All rights reserved. Reproduction in whole or in part without the express written permission of Corbin Russwin, Inc. is prohibited.

Fastener / Screw Pack Information

Product Number	Description	Properties	Price
	12-24 x 11/16 x #10 Head, Flat Head Undercut Self-Drilling Screw		
TKS1267SP10SS24	(24 Pack)	Stainless Steel	\$ 5.25
TKS1267SP10BL24	Formerly MP-11; Replaces MP-10, MP-11, MP-12 (24 Pack)	Black Zinc	\$ 6.25
	#8 x 3/4" Flat Head Self-Drilling Screw		
S323-08R12-603	Formerly MP-8; For attaching 100, 200, and 300 series covers (Per each)	Zinc Phillips	\$ 0.25
S323-08R12-663	Formerly MP-9; For attaching 100, 200, and 300 series covers (Per each)	Black	\$ 0.25
TORX-TKS8075Z	Formerly MP-61; For attaching 100, 200, and 300 series covers (Per each)	Zinc Torx	\$ 0.70
	12-8 x 1-1/2 x #10 Head, Particle Board Screw		
PBS12150SP10SS24	Formerly MP-28; For edge mounting to wood (24 Pack)	Stainless Steel	\$ 3.75
PBS12150SP10BLR21	Formerly MP-29; For edge mounting to wood (24 Pack)	Black	\$ 4.75
T25PBS12150SPSS24	Formerly MP-54; For edge mounting to wood. Security Pin. (24 Pack)	Stainless Steel Torx	\$ 10.85
	1-3/8" Adjust-A-Screw™ With 10-32 Internal Thread and Hex Head Adjustment		
M26-0031-01	Formerly MP-25; Right Hand used with MS10075SS screw (Per each) Note: 5/16" pilot hole required for 3/8" - 16 tap 12 ga. reinforcement required		\$ 1.20
	10-32 x 3/4" Flat Head Machine Screw		
MS10075SS	See note on CH1 for quantities required. Formerly MP-7; Used with M26-0031-01 Adjust-A-Screw™ (Per each)	Stainless Steel Phillips	\$ 0.30
TORX-MS10075SS	Formerly MP-55; Used with M26-0031-01 Adjust-A-Screw™ (Per each)	Stainless Steel Torx	\$ 0.75
MS10075BL	Used with M26-0031-01 Adjust-A-Screw™ (Per each)	Black Stainless Steel	\$ 0.40

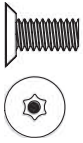
Fastener / Screw Pack Information

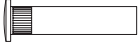
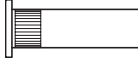
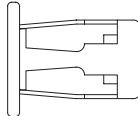
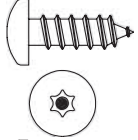
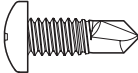
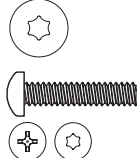
Product Number	Description	Properties	Price
	12-24 x 7/16 x #10 Head, Flat Head Undercut Machine Screw, with Security Pin, Tri-Round Threads		
TORX-MS1244SP10SS24	Formerly MP-52; For edge mounting to metal (24 Pack)	Stainless Steel Torx	\$ 10.85
TORX-MS1244SP10BL24	(24 Pack)	Black Stainless Steel Torx	\$ 12.85
	3/16 x 1-1/4 Phillips Flat Head Concrete Screw		
TC316125	Formerly MP-60; (Per each)	Zinc	\$ 0.52
	1/4-20 x 1-5/8" Thru-bolt		
TB1420Z4	Formerly MP-22; For surface mounting to wood (4 pack)	Zinc Steel	\$ 3.35
TB1420SS	Formerly MP-23, replaces MP-38. For surface mounting to wood (Per each)	Stainless Steel	\$ 3.35
TB1420BL4	Formerly MP-56 For surface mounting to wood (4 Pack)	Black	\$ 3.35
	1/4-20 x 1-1/4" Thru-bolt		
TB138Z	Formerly MP-24 For surface mounting to wood (Per each)	Zinc	\$ 0.85
	8 SJN 1/4-20 Molly Jack Nut		
M26-0015-02	Formerly MP-20; 7/16" hole (Per each)	Zinc	\$ 1.75
	#14 x 3/4" T-27 Torx Button Head Sheet Metal Screw		
S312C14T12-630	Formerly MP-49. (Per each)	Stainless	\$ 1.60
	1/4-14 x 3/4" Pan Head Self-Drilling Screw		
S308-416-12-603	Formerly MP-62; For surface mounting to metal (Per each)	Zinc Torx	\$ 1.60
	1/4-20 x 1" Pan Head Machine Screw		
S222-416R16-603	Formerly MP-14; For surface mounting to metal (Per each)	Zinc Phillips	\$ 0.75
TORX-MS14100Z	Formerly MP-65; For surface mounting to metal (Per each)	Zinc Torx	\$ 1.00

ASSA ABLOY

CH-5 The global leader in door opening solutions

800-346-7707 | www.mckinneyhinge.com
Check the web site for the up-to-date catalog

McKinney is a brand associated with Corbin Russwin, Inc., an ASSA ABLOY Group company. Copyright © 2012-2017, Corbin Russwin, Inc. All rights reserved. Reproduction in whole or in part without the express written permission of Corbin Russwin, Inc. is prohibited.

Stainless Steel Edge Mount Hinge

MCK-FM300 Price Code 83



Door Size	Length	Part Number	Hand Finish	Price Each	Carton Qty	Wgt			
6'8"	79 ³ / ₁₆ "	76850		32D	224.40	1	10		
6'8"	79 ³ / ₁₆ "	76851		32	251.94				
7'0"	83 ¹ / ₈ "	76852		32D	224.40				
7'0"	83 ¹ / ₈ "	76853		32	251.94				
7'2"	85 ¹ / ₈ "	76854		32D	244.80				
7'2"	85 ¹ / ₈ "	76855		32	292.74				
8'0"	95"	76856		32D	270.30				
8'0"	95"	76857		32	318.24				
10'0"	118 ³ / ₄ "	76858		32D	364.14				
10'0"	118 ³ / ₄ "	76859		32	412.08				
								13	

Refer to Pages CH-1 thru CH-3 For Available Options.

Stainless Steel Edge Mount Full-Wrap - Edge Guard

MCK-HG305 Price Code 83



Door Size	Length	Part Number	Hand Finish	Price Each	Carton Qty	Wgt	
6'8"	79 ³ / ₁₆ "	76860	RH	32D	303.46	1	
6'8"	79 ³ / ₁₆ "	77104	LH	32D	303.46		
6'8"	79 ³ / ₁₆ "	76861	RH	32	350.91		
6'8"	79 ³ / ₁₆ "	77105	LH	32	350.91		
7'0"	83 ¹ / ₈ "	76862		32D	303.46		
7'0"	83 ¹ / ₈ "	76863		32	350.91		
7'2"	85 ¹ / ₈ "	76864	RH	32D	343.41		
7'2"	85 ¹ / ₈ "	77106	LH	32D	343.41		
7'2"	85 ¹ / ₈ "	76865	RH	32	390.87		
7'2"	85 ¹ / ₈ "	77107	LH	32	390.87		
8'0"	95"	76866		32D	348.41		
8'0"	95"	76867		32	395.86		
10'0"	118 ³ / ₄ "	76868		32D	417.09		
10'0"	118 ³ / ₄ "	76869		32	464.55		

Refer to Pages CH-1 thru CH-3 For Available Options.

Stainless Steel Edge Mount Half-Wrap - Edge Guard

MCK-HG315 Price Code 83

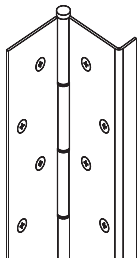

Door Size	Length	Part Number	Hand Finish	Price Each	Carton Qty	Wgt	
6'8"	79 ³ / ₁₆ "	76870	RH	32D	282.86	1	12
6'8"	79 ³ / ₁₆ "	77108	LH	32D	282.86		
6'8"	79 ³ / ₁₆ "	76871	RH	32	330.31		
6'8"	79 ³ / ₁₆ "	77109	LH	32	330.31		
7'0"	83 ¹ / ₈ "	76872		32D	282.86		
7'0"	83 ¹ / ₈ "	76873		32	330.31		
7'2"	85 ¹ / ₈ "	76874	RH	32D	320.31		
7'2"	85 ¹ / ₈ "	77110	LH	32D	320.31		
7'2"	85 ¹ / ₈ "	76875	RH	32	367.77		
7'2"	85 ¹ / ₈ "	77111	LH	32	367.77		
8'0"	95"	76876		32D	326.56		
8'0"	95"	76877		32	374.01		
10'0"	118 ³ / ₄ "	76878		32D	395.86		
10'0"	118 ³ / ₄ "	76879		32	443.32		
							13
							15

Refer to Pages CH-1 thru CH-3 For Available Options.

Stainless Steel Edge Mount Full-Wrap Edge Guard

MCK-HG322 Price Code 83

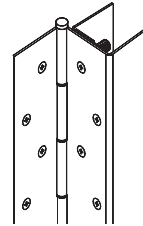

Door Size	Length	Part Number	Hand Finish	Price Each	Carton Qty	Wgt	
6'8"	79 ³ / ₁₆ "	77112	RH	32D	372.14	1	12
6'8"	79 ³ / ₁₆ "	77113	LH	32D	372.14		
6'8"	79 ³ / ₁₆ "	77114	RH	32	419.60		
6'8"	79 ³ / ₁₆ "	77115	LH	32	419.60		
7'0"	83 ¹ / ₈ "	77116		32D	372.14		
7'0"	83 ¹ / ₈ "	77117		32	419.60		
7'2"	85 ¹ / ₈ "	77118	RH	32D	429.58		
7'2"	85 ¹ / ₈ "	77119	LH	32D	429.58		
7'2"	85 ¹ / ₈ "	77120	RH	32	477.03		
7'2"	85 ¹ / ₈ "	77121	LH	32	477.03		
8'0"	95"	77122		32D	429.58		
8'0"	95"	77123		32	477.03		
10'0"	118 ³ / ₄ "	77124		32D	543.22		
10'0"	118 ³ / ₄ "	77125		32	590.68		
							14
							16

Refer to Pages CH-1 thru CH-3 For Available Options.

Stainless Steel Edge Mount Full-Wrap Edge Guard

MCK-HG323 Price Code 83

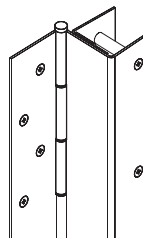

Door Size	Length	Part Number	Hand Finish	Price Each	Carton Qty	Wgt	
6'8"	79 ³ / ₁₆ "	77126	RH	32D	372.14	1	12
6'8"	79 ³ / ₁₆ "	77127	LH	32D	372.14		
6'8"	79 ³ / ₁₆ "	77128	RH	32	419.60		
6'8"	79 ³ / ₁₆ "	77129	LH	32	419.60		
7'0"	83 ¹ / ₈ "	77130		32D	372.14		
7'0"	83 ¹ / ₈ "	77131		32	419.60		
7'2"	85 ¹ / ₈ "	77132	RH	32D	429.58		
7'2"	85 ¹ / ₈ "	77133	LH	32D	429.58		
7'2"	85 ¹ / ₈ "	77134	RH	32	477.03		
7'2"	85 ¹ / ₈ "	77135	LH	32	477.03		
8'0"	95"	77136		32D	429.58		
8'0"	95"	77137		32	477.03		
10'0"	118 ³ / ₄ "	77138		32D	543.22		
10'0"	118 ³ / ₄ "	77139		32	590.68		
							14
							16

Refer to Pages CH-1 thru CH-3 For Available Options.

Stainless Steel Swing Clear Full-Wrap Edge Guard

MCK-HG326 Price Code 83

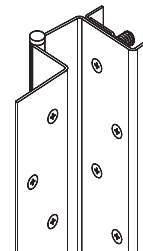

Door Size	Length	Part Number	Hand Finish	Price Each	Carton Qty	Wgt	
6'8"	79 ³ / ₁₆ "	77140	RH	32D	362.15	1	12
6'8"	79 ³ / ₁₆ "	77141	LH	32D	362.15		
6'8"	79 ³ / ₁₆ "	77142	RH	32	409.60		
6'8"	79 ³ / ₁₆ "	77143	LH	32	409.60		
7'0"	83 ¹ / ₈ "	77144		32D	362.15		
7'0"	83 ¹ / ₈ "	77145		32	409.60		
7'2"	85 ¹ / ₈ "	77146	RH	32D	417.09		
7'2"	85 ¹ / ₈ "	77147	LH	32D	417.09		
7'2"	85 ¹ / ₈ "	77148	RH	32	464.55		
7'2"	85 ¹ / ₈ "	77149	LH	32	464.55		
8'0"	95"	77150		32D	423.33		
8'0"	95"	77151		32	470.79		
10'0"	118 ³ / ₄ "	77152		32D	530.74		
10'0"	118 ³ / ₄ "	77153		32	578.19		
							14
							16

Refer to Pages CH-1 thru CH-3 For Available Options.

Stainless Steel Edge Mount Safety Hinge

MCK-FM327 Price Code 83



Door Size	Length	Part Number	Hand Finish	Price Each	Carton Qty	Wgt
6'8"	79 ³ / ₁₆ "	77154	RH	32D	312.20	12
6'8"	79 ³ / ₁₆ "	77155	LH	32D	312.20	
6'8"	79 ³ / ₁₆ "	77156	RH	32	359.65	13
6'8"	79 ³ / ₁₆ "	77157	LH	32	359.65	
7'0"	83 ¹ / ₈ "	77158		32D	312.20	13
7'0"	83 ¹ / ₈ "	77159		32	359.65	
7'2"	85 ¹ / ₈ "	77160	RH	32D	353.41	14
7'2"	85 ¹ / ₈ "	77161	LH	32D	353.41	
7'2"	85 ¹ / ₈ "	77162	RH	32	400.86	14
7'2"	85 ¹ / ₈ "	77163	LH	32	400.86	
8'0"	95"	77164		32D	359.65	16
8'0"	95"	77165		32	407.11	
10'0"	118 ³ / ₄ "	77166		32D	442.07	16
10'0"	118 ³ / ₄ "	77167		32	489.52	

Refer to Pages CH-1 thru CH-3 For Available Options.

Stainless Steel Half Mortise Hinge

MCK-HM304 Price Code 83

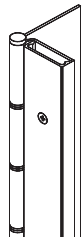

Door Size	Length	Part Number	Hand Finish	Price Each	Carton Qty	Wgt
7'0"	83 ¹ / ₈ "	76882		32D	241.02	10
7'0"	83 ¹ / ₈ "	76883		32	288.48	
7'2"	85 ¹ / ₈ "	77168	RH	32D	282.86	11
7'2"	85 ¹ / ₈ "	77169	LH	32D	282.86	
7'2"	85 ¹ / ₈ "	77170	RH	32	330.31	13
7'2"	85 ¹ / ₈ "	77171	LH	32	330.31	
8'0"	95"	76886		32D	288.48	11
8'0"	95"	76887		32	335.92	
10'0"	118 ³ / ₄ "	77172		32D	353.41	13

Refer to Pages CH-1 thru CH-3 For Available Options.

Stainless Steel Half Mortise, Half-Wrap - Edge Guard

MCK-HG306 Price Code 83



Door Size	Length	Part Number	Hand Finish	Price Each	Carton Qty	Wgt
7'0"	83 ¹ / ₈ "	76892		32D	249.76	12
7'0"	83 ¹ / ₈ "	76893		32	297.22	
7'2"	85 ¹ / ₈ "	77174	RH	32D	292.21	13
7'2"	85 ¹ / ₈ "	77175	LH	32D	292.21	
7'2"	85 ¹ / ₈ "	77176	RH	32	339.67	14
7'2"	85 ¹ / ₈ "	77177	LH	32	339.67	
8'0"	95"	76896		32D	298.45	13
8'0"	95"	76897		32	345.91	
10'0"	118 ³ / ₄ "	77178		32D	362.15	14
10'0"	118 ³ / ₄ "	77179		32	409.60	

Refer to Pages CH-1 thru CH-3 For Available Options.

Stainless Steel Swing Clear Half-Wrap - Edge Guard

MCK-HG311 Price Code 83



Door Size	Length	Part Number	Hand Finish	Price Each	Carton Qty	Wgt
7'0"	83 ¹ / ₈ "	76902		32D	260.99	13
7'0"	83 ¹ / ₈ "	76903		32	308.45	
7'2"	85 ¹ / ₈ "	77180	RH	32D	299.71	13
7'2"	85 ¹ / ₈ "	77181	LH	32D	299.71	
7'2"	85 ¹ / ₈ "	77182	RH	32	347.17	14
7'2"	85 ¹ / ₈ "	77183	LH	32	347.17	
8'0"	95"	76906		32D	305.95	14
8'0"	95"	76907		32	353.41	
10'0"	118 ³ / ₄ "	77184		32D	375.26	16
10'0"	118 ³ / ₄ "	77185		32	422.71	

Refer to Pages CH-1 thru CH-3 For Available Options.

Stainless Steel Full Surface 1/8" Inset Hinge

MCK-FS301 Price Code 83

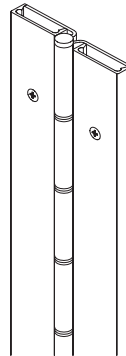

Door Size	Length	Part Number	Hand Finish	Price Each	Carton Qty	Wgt
6'8"	79 ³ / ₁₆ "	77186	RH	32D	269.74	12
6'8"	79 ³ / ₁₆ "	77187	LH	32D	269.74	
6'8"	79 ³ / ₁₆ "	77188	RH	32	317.19	13
6'8"	79 ³ / ₁₆ "	77189	LH	32	317.19	
7'0"	83 ¹ / ₈ "	77190		32D	269.74	13
7'0"	83 ¹ / ₈ "	77191		32	317.19	
7'2"	85 ¹ / ₈ "	77192	RH	32D	311.58	14
7'2"	85 ¹ / ₈ "	77193	LH	32D	311.58	
7'2"	85 ¹ / ₈ "	77194	RH	32	359.03	14
7'2"	85 ¹ / ₈ "	77195	LH	32	359.03	
8'0"	95"	77196		32D	317.82	16
8'0"	95"	77197		32	365.27	
10'0"	118 ³ / ₄ "	77198		32D	437.69	16
10'0"	118 ³ / ₄ "	77199		32	485.15	

Refer to Pages CH-1 thru CH-3 For Available Options.

Stainless Steel Half Surface Hinge

MCK-HS303 Price Code 83

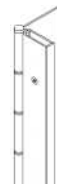

Door Size	Length	Part Number	Hand Finish	Price Each	Carton Qty	Wgt
6'8"	79 ³ / ₁₆ "	77358		32D	241.02	13
7'0"	83 ¹ / ₈ "	77359		32D	241.02	
7'2"	85 ¹ / ₈ "	77360		32D	282.86	14
8'0"	95"	77361		32D	282.86	
10'0"	118 ³ / ₄ "	77362		32D	353.41	16

Refer to Pages CH-1 thru CH-3 For Available Options.

ASSA ABLOY

The global leader in door opening solutions

Stainless Steel Full Surface Flush Mount Hinge

MCK-FS302 Price Code 83



Door Size	Length	Part Number	Hand Finish	Price Each	Carton Qty	Wgt
6'8"	79 ³ / ₁₆ "	76910		32D	269.74	12
6'8"	79 ³ / ₁₆ "	76911		32	317.19	
7'0"	83 ¹ / ₈ "	76912		32D	269.74	13
7'0"	83 ¹ / ₈ "	76913		32	317.19	
7'2"	85 ¹ / ₈ "	76914		32D	311.58	14
7'2"	85 ¹ / ₈ "	76915		32	365.27	
8'0"	95"	76916		32D	323.43	16
8'0"	95"	76917		32	365.27	
10'0"	118 ³ / ₄ "	77204		32D	437.69	16
10'0"	118 ³ / ₄ "	77205		32	485.15	

Refer to Pages CH-1 thru CH-3 For Available Options.

Stainless Steel Full Surface Swing Clear Hinge

MCK-FS309 Price Code 83



Door Size	Length	Part Number	Hand Finish	Price Each	Carton Qty	Wgt
6'8"	79 ³ / ₁₆ "	77206	RH	32D	291.59	12
6'8"	79 ³ / ₁₆ "	77207	LH	32D	291.59	
6'8"	79 ³ / ₁₆ "	77208	RH	32	339.05	13
6'8"	79 ³ / ₁₆ "	77209	LH	32	339.05	
7'0"	83 ¹ / ₈ "	77210		32D	279.10	14
7'0"	83 ¹ / ₈ "	77211		32	339.05	
7'2"	85 ¹ / ₈ "	77212	RH	32D	339.67	16
7'2"	85 ¹ / ₈ "	77213	LH	32D	339.67	
7'2"	85 ¹ / ₈ "	77214	RH	32	387.12	16
7'2"	85 ¹ / ₈ "	77215	LH	32	387.12	
8'0"	95"	77216		32D	345.91	16
8'0"	95"	77217		32	393.36	
10'0"	118 ³ / ₄ "	77218		32D	412.72	16
10'0"	118 ³ / ₄ "	77219		32	460.17	

Refer to Pages CH-1 thru CH-3 For Available Options.

Stainless Steel Full Surface 3/4" Offset Hinge

MCK-FS321 Price Code 83

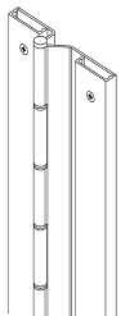

Door Size	Length	Part Number	Hand Finish	Price Each	Carton Qty	Wgt
6'8"	79 ³ / ₁₆ "	77220	RH	32D	316.57	12
6'8"	79 ³ / ₁₆ "	77221	LH	32D	316.57	
6'8"	79 ³ / ₁₆ "	77222	RH	32	364.02	13
6'8"	79 ³ / ₁₆ "	77223	LH	32	364.02	
7'0"	83 ¹ / ₈ "	77224		32D	316.57	14
7'0"	83 ¹ / ₈ "	77225		32	364.02	
7'2"	85 ¹ / ₈ "	77226	RH	32D	362.15	16
7'2"	85 ¹ / ₈ "	77227	LH	32D	362.15	
7'2"	85 ¹ / ₈ "	77228	RH	32	409.60	16
7'2"	85 ¹ / ₈ "	77229	LH	32	409.60	
8'0"	95"	77230		32D	368.39	16
8'0"	95"	77231		32	415.84	
10'0"	118 ³ / ₄ "	77232		32D	480.17	16
10'0"	118 ³ / ₄ "	77233		32	527.62	

Refer to Pages CH-1 thru CH-3 For Available Options.

Stainless Steel Swing Clear Full-Wrap Edge Guard

MCK-HG310 Price Code 83



Door Size	Length	Part Number	Hand Finish	Price Each	Carton Qty	Wgt
6'8"	79 ³ / ₁₆ "	77234	RH	32D	337.17	12
6'8"	79 ³ / ₁₆ "	77235	LH	32D	337.17	
6'8"	79 ³ / ₁₆ "	77236	RH	32	384.63	13
6'8"	79 ³ / ₁₆ "	77237	LH	32	384.63	
7'0"	83 ¹ / ₈ "	77238		32D	337.17	14
7'0"	83 ¹ / ₈ "	77239		32	384.63	
7'2"	85 ¹ / ₈ "	77240	RH	32D	384.01	16
7'2"	85 ¹ / ₈ "	77241	LH	32D	384.01	
7'2"	85 ¹ / ₈ "	77242	RH	32	431.45	16
7'2"	85 ¹ / ₈ "	77243	LH	32	431.45	
8'0"	95"	77244		32D	390.25	16
8'0"	95"	77245		32	437.69	
10'0"	118 ³ / ₄ "	77246		32D	484.53	16
10'0"	118 ³ / ₄ "	77247		32	531.99	

Refer to Pages CH-1 thru CH-3 For Available Options.

3500 Series Stainless Security Hinges

Stainless Steel Heavy Duty Edge Mount Hinge

MCK-FM3500 Price Code 83

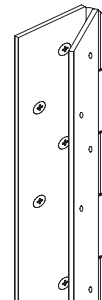

Door Size	Length	Part Number	Hand Finish	Price Each	Carton Qty	Wgt
6'8"	79 ³ / ₁₆ "	77263	RH	32D	312.20	1
6'8"	79 ³ / ₁₆ "	77264	LH	32D	312.20	
6'8"	79 ³ / ₁₆ "	77265	RH	32	359.65	1
6'8"	79 ³ / ₁₆ "	77266	LH	32	359.65	
7'0"	83 ¹ / ₈ "	77267		32D	312.20	1
7'0"	83 ¹ / ₈ "	77268		32	359.65	
7'2"	85 ¹ / ₈ "	77269	RH	32D	366.52	1
7'2"	85 ¹ / ₈ "	77270	LH	32D	366.52	
7'2"	85 ¹ / ₈ "	77271	RH	32	413.98	1
7'2"	85 ¹ / ₈ "	77272	LH	32	413.98	
8'0"	95"	77273		32D	372.76	1
8'0"	95"	77274		32	420.22	
10'0"	118 ³ / ₄ "	77275		32D	437.69	1
10'0"	118 ³ / ₄ "	77276		32	485.15	

Refer to Pages CH-1 thru CH-3 For Available Options.

Stainless Steel Heavy Duty Full Surface 1/8" Inset Hinge

MCK-FS3501 Price Code 83

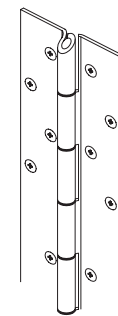

Door Size	Length	Part Number	Hand Finish	Price Each	Carton Qty	Wgt
6'8"	79 ³ / ₁₆ "	77277	RH	32D	342.16	1
6'8"	79 ³ / ₁₆ "	77278	LH	32D	342.16	
6'8"	79 ³ / ₁₆ "	77279	RH	32	389.62	1
6'8"	79 ³ / ₁₆ "	77280	LH	32	389.62	
7'0"	83 ¹ / ₈ "	77281		32D	342.16	1
7'0"	83 ¹ / ₈ "	77282		32	389.62	
7'2"	85 ¹ / ₈ "	77283	RH	32D	391.50	1
7'2"	85 ¹ / ₈ "	77284	LH	32D	391.50	
7'2"	85 ¹ / ₈ "	77285	RH	32	438.95	1
7'2"	85 ¹ / ₈ "	77286	LH	32	438.95	
8'0"	95"	77287		32D	397.74	1
8'0"	95"	77288		32	397.74	
10'0"	118 ³ / ₄ "	77289		32D	484.53	1
10'0"	118 ³ / ₄ "	77290		32	531.99	

Refer to Pages CH-1 thru CH-3 For Available Options.

3500 Series Stainless Security Hinges (Continued)

Stainless Steel Heavy Duty Full Surface Hinge

MCK-FS3502 Price Code 83

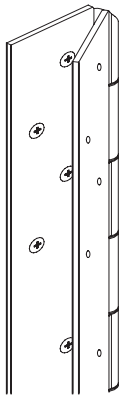

Door Size	Length	Part Number	Hand	Finish	Price Each	Carton Quantity
6'8"	79 ³ / ₁₆ "	77291	RH	32D	359.27	1
6'8"	79 ³ / ₁₆ "	77292	LH	32D	359.27	
6'8"	79 ³ / ₁₆ "	77293	RH	32	409.10	
6'8"	79 ³ / ₁₆ "	77294	LH	32	409.10	
7'0"	83 ¹ / ₈ "	77295		32D	359.27	
7'0"	83 ¹ / ₈ "	77296		32	409.10	
7'2"	85 ¹ / ₈ "	77297	RH	32D	411.08	
7'2"	85 ¹ / ₈ "	77298	LH	32D	411.08	
7'2"	85 ¹ / ₈ "	77299	RH	32	460.90	
7'2"	85 ¹ / ₈ "	77300	LH	32	460.90	
8'0"	95"	77301		32D	417.63	
8'0"	95"	77302		32	467.45	
10'0"	118 ³ / ₄ "	77303		32D	508.76	
10'0"	118 ³ / ₄ "	77304		32	558.59	

Refer to Pages CH-1 thru CH-3 For Available Options.

Stainless Steel Heavy Duty Full Wrap Edge Guard

MCK-HG3505 Price Code 83



Door Size	Length	Part Number	Hand	Finish	Price Each	Carton Quantity
6'8"	79 ³ / ₁₆ "	77305	RH	32D	359.27	1
6'8"	79 ³ / ₁₆ "	77306	LH	32D	359.27	
6'8"	79 ³ / ₁₆ "	77307	RH	32	409.10	
6'8"	79 ³ / ₁₆ "	77308	LH	32	409.10	
7'0"	83 ¹ / ₈ "	77309	RH	32D	359.27	
7'0"	83 ¹ / ₈ "	77310	RH	32	409.10	
7'2"	85 ¹ / ₈ "	77311	RH	32D	411.08	
7'2"	85 ¹ / ₈ "	77312	LH	32D	411.08	
7'2"	85 ¹ / ₈ "	77313	RH	32	460.90	
7'2"	85 ¹ / ₈ "	77314	LH	32	460.90	
8'0"	95"	77315	RH	32D	417.63	
8'0"	95"	77316	RH	32	467.45	
10'0"	118 ³ / ₄ "	77317	RH	32D	508.76	
10'0"	118 ³ / ₄ "	77318	RH	32	558.59	

Refer to Pages CH-1 thru CH-3 For Available Options.

Steel Hinges

Steel Full Mortise Hinge

MCK-FM3700 Price Code 87



Door Size	Length	Part Number	Hand	Finish	Price Each	Carton Qty	Wgt
6'8"	79 ³ / ₁₆ "	76950	RH	Zinc	137.65	1	10
6'8"	79 ³ / ₁₆ "	77248	LH	Zinc	137.65		
7'0"	83 ¹ / ₈ "	76951		Zinc	137.65		
7'2"	85 ¹ / ₈ "	76952	RH	Zinc	160.47		
7'2"	85 ¹ / ₈ "	77249	LH	Zinc	160.47		
8'0"	95"	76953		Zinc	166.71		

Refer to Pages CH-1 thru CH-3 For Available Options.

Steel Full Surface Flush Mount Hinge

MCK-FM3702 Price Code 87

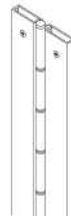

Door Size	Length	Part Number	Hand	Finish	Price Each	Carton Qty	Wgt
6'8"	79 ³ / ₁₆ "	76980	RH	Zinc	168.59	1	10
6'8"	79 ³ / ₁₆ "	77257	LH	Zinc	168.59		
7'0"	83 ¹ / ₈ "	76981		Zinc	168.59		
7'2"	85 ¹ / ₈ "	76982	RH	Zinc	186.07		
7'2"	85 ¹ / ₈ "	77258	LH	Zinc	186.07		
8'0"	95"	76983		Zinc	192.31		

Refer to Pages CH-1 thru CH-3 For Available Options.

Steel Full Surface 1/8" Inset Hinge

MCK-FS3701 Price Code 87

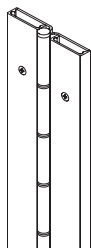

Door Size	Length	Part Number	Hand	Finish	Price Each	Carton Qty	Wgt
6'8"	79 ³ / ₁₆ "	77250	RH	Zinc	168.59	1	10
6'8"	79 ³ / ₁₆ "	77251	LH	Zinc	168.59		
7'0"	83 ¹ / ₈ "	77252		Zinc	168.59		
7'2"	85 ¹ / ₈ "	77253	RH	Zinc	206.67		
7'2"	85 ¹ / ₈ "	77254	LH	Zinc	206.67		
8'0"	95"	77255		Zinc	212.91		

Refer to Pages CH-1 thru CH-3 For Available Options.

Steel Half Surface Hinge

MCK-HS3703 Price Code 87



Door Size	Length	Part Number	Hand	Finish	Price Each	Carton Qty	Wgt
6'8"	79 ³ / ₁₆ "	77319	RH	Zinc	151.73	1	10
6'8"	79 ³ / ₁₆ "	77260	LH	Zinc	151.73		
7'0"	83 ¹ / ₈ "	77320		Zinc	151.73		
7'2"	85 ¹ / ₈ "	77321	RH	Zinc	186.07		
7'2"	85 ¹ / ₈ "	77261	LH	Zinc	186.07		
8'0"	95"	77322		Zinc	192.31		

Refer to Pages CH-1 thru CH-3 For Available Options.

ASSA ABLOY

The global leader in
door opening solutions

McKinney Current Transfer Prep (CTP) Information Form

In order to assign an accurate ship date and begin production of your order, please provide us with the information requested. We appreciate your cooperation and time to assist us in providing you with the type of product that will meet our requirements.

ALL PT LOCATIONS ARE REQUIRED FROM TOP OF DOOR TO CENTERLINE OF PREP

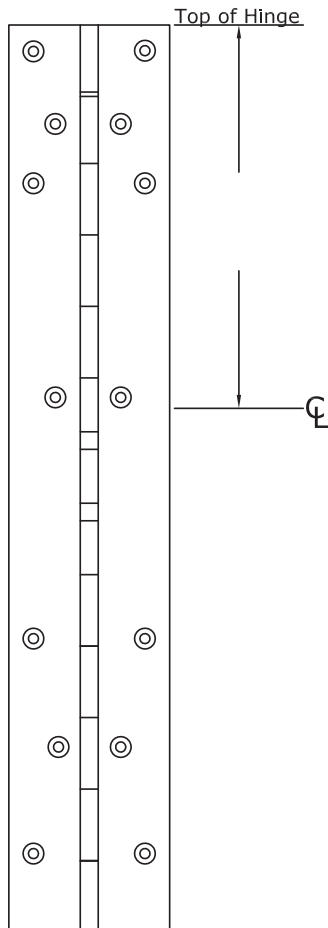

Company Name: _____
 Contact Name: _____
 P.O.#: _____
 Job Name: _____
 Phone Number: _____
 Fax Number: _____

CTP (Power Transfer Model)

- Pemko/Markar EL-CEPT
- Pemko/Markar EL-EPT ***
- Pemko/Markar EL-EPTL ***
- Pemko/Markar EL-EPT-SC
- Securitron CEPT
- Securitron EPT/Adams Rite 4612-1 ***
- Securitron EPTL/Adams Rite 4612-2 ***
- Securitron EPT-SC/Adams Rite 4612-SC
- Von Duprin EPT-2 & EPT-10
- Precision ***
- Other (Template Needed) _____

Mortise Prep In *** (needed)

- Frame Leaf
- Door Leaf

Hinge Length: _____
 RHR/LH: _____
 LHR/RH: _____

Notes: _____

Order acknowledgement will be sent after all information requirements are met to determine a ship date

McKinney 3-Day QuickShip Program

The MCKINNEY 3-Day QuickShip program provides quick access to over 440 of our most popular products to meet the needs of your next job. Orders for items on the program will be shipped within 3 business days.

Fax orders to 877-888-2772 or email to dss-orders@assaabloy.com.

Please note that made-to-order hinges ship in 2-3 weeks. Purchase orders that combine made-to-order and QuickShip items will be held and shipped together. Enter QuickShip items on a separate purchase order to ensure the shorter lead time.

Standard Weight Spring Hinges

SKU	Cat.No.	Size	Finishes	SKU	Cat.No.	Size	Finishes
156007	1502	4-1/2 x 4	15	156021E	1502	4-1/2 x 4-1/2	10BE
156008	1502	4-1/2 x 4	26D	156022	1502	4-1/2 x 4-1/2	15
156015	1502	4-1/2 x 4-1/2	D4	156024	1502	4-1/2 x 4-1/2	26
156017	1502	4-1/2 x 4-1/2	P	156025	1502	4-1/2 x 4-1/2	3
156019	1502	4-1/2 x 4-1/2	4	156045	1522	4-1/2 x 4-1/2	10B
156020	1502	4-1/2 x 4-1/2	10	156046	1522	4-1/2 x 4-1/2	15
156021	1502	4-1/2 x 4-1/2	10B	156047	1522	4-1/2 x 4-1/2	26D

Standard Weight 2K Hinges

SKU	Cat.No.	Size	Options	Finishes	SKU	Cat.No.	Size	Options	Finishes
65623	TA2731	4-1/2 x 4-1/2	RH	26D	65624	TA2731	4-1/2 x 4-1/2	LH	26D

Standard Weight 3K Hinges

SKU	Cat.No.	Size	Options	Finishes	SKU	Cat.No.	Size	Options	Finishes
56402	TA314	4-1/2 x 4	NRP	32D	69230	TA714	4-1/2 x 4-1/2		26
56403	TA714	4-1/2 x 4		15	69232	TA714	4-1/2 x 4-1/2		3
69176	TA714	4-1/2 x 4		10A	69233	HTA714	4-1/2 x 4-1/2		26D
69177	TA714	3-1/2 x 3-1/2		26D	69236	TA714	4-1/2 x 4-1/2		10A
69188	TA714	3-1/2 x 3-1/2		15	69237	TA714	5 x 4-1/2		26D
69207	TA714	4-1/2 x 4		26D	69252	TA714	5 x 5		26D
69210	TA714	4-1/2 x 4		4	69353	TA314	4-1/2 x 4		32D
69211	TA714	4-1/2 x 4		10	69356	TA314	4-1/2 x 4-1/2	NRP	32D
69212	TA714	4-1/2 x 4		10B	69362	TA314	4-1/2 x 4-1/2		10B
69215	TA714	4-1/2 x 4		26	69363	HTA314	4-1/2 x 4-1/2		32D
69217	TA714	4-1/2 x 4		3	69368	TA314	4-1/2 x 4-1/2		32D
69221	TA714	4-1/2 x 4		D4	69383	TA314	5 x 4-1/2		32D
69222	TA714	4-1/2 x 4-1/2		26D	69489	HTA314	4-1/2 x 4		32D
69222FT	TA714	4-1/2 x 4-1/2	FT	26D	69625	TA714	5 x 4		26D
69223	TA714	4-1/2 x 4-1/2		P	73881	TA314	5 x 4		32D
69225	TA714	4-1/2 x 4-1/2		4	74201	TA714	4-1/2 x 4	NRP	26D
69226	TA714	4-1/2 x 4-1/2		10	74283	TA714	4-1/2 x 4-1/2	NRP	26D
69227	TA714	4-1/2 x 4-1/2		10B	74284	TA714	4-1/2 x 4-1/2		D4
69228	TA714	4-1/2 x 4-1/2		15	74350	HTA714	4-1/2 x 4		26D

Standard Weight 5K Hinges

SKU	Cat.No.	Size	Options	Finishes	SKU	Cat.No.	Size	Options	Finishes
55314	T2714	3-1/2 x 3-1/2		15	55563	TA2714	4 x 4		10
55315	T2714	3-1/2 x 3-1/2		P	55569	TA2714	4 x 4		26
55317	T2714	3-1/2 x 3-1/2		3	55571	TA2714	4 x 4		26D
55319	T2714	3-1/2 x 3-1/2		26D	55577	TA2714	4 x 4		10B
55321	T2714	3-1/2 x 3-1/2		10	55616	TA2714	4-1/2 x 4		15
55327	T2714	3-1/2 x 3-1/2		26	55632	RCTA2714	4 x 4		26D
55333	T2714	3-1/2 x 3-1/2		10B	55635	T2714	4-1/2 x 4		P
55337	T2714	3-1/2 x 3-1/2		4	55639	T2714	4-1/2 x 4		26D
55380	T2714	3-1/2 x 3-1/2		D4	55644	T2714	4-1/2 x 4		10B
55385	TA2714	3-1/2 x 3-1/2		P	55656	T2714	4-1/2 x 4		15
55389	TA2714	3-1/2 x 3-1/2		10B	55673	TA2714	4-1/2 x 4		10A
55391	TA2714	3-1/2 x 3-1/2		3	55674	TA2714	4-1/2 x 4		4
55392	TA2714	3 1/2 X 3 1/2		15	55675	TA2714	4-1/2 x 4		P
55393	TA2714	3-1/2 x 3-1/2		26D	55679	TA2714	4-1/2 x 4		26D
55395	TA2714	3 1/2 X 3 1/2		10	55681	TA2714	4-1/2 x 4		10
55430	RCT2714	3-1/2 x 3-1/2		10B	55683	TA2714	4-1/2 x 4		3
55438	RCT2714	3-1/2 x 3-1/2		26D	55688	TA2714	4-1/2 x 4		26
55443	RCT2714	3 1/2 X 3 1/2		D4	55690	TA2714	4-1/2 x 4	NRP	26D
55485	T2714	4 x 4		P	55691	TA2714	4-1/2 x 4		10B
55487	T2714	4 x 4		4	55691E	TA2714	4-1/2 x 4		10BE
55491	T2714	4 x 4		3	55742	T2714	4-1/2 x 4-1/2		10B
55496	T2714	4 x 4		10B	55742E	T2714	4-1/2 x 4-1/2		10BE
55497	T2714	4 x 4		15	55745	T2714	4-1/2 x 4-1/2		P
55499	T2714	4 x 4		26	55747	T2714	4-1/2 x 4-1/2	NRP	P
55501	T2714	4 x 4		26D	55751	T2714	4-1/2 x 4-1/2		15
55509	T2714	4 x 4		D4					
55521	RCT2714	4 x 4		26D					
55555	TA2714	4 x 4		P					
55561	TA2714	4 x 4		3					

Continued on next page



Standard Weight 5K Hinges (Continued)

SKU	Cat.No.	Size	Options	Finishes	SKU	Cat.No.	Size	Options	Finishes
55753	T2714	4-1/2 x 4-1/2		26	56135	TA2714	5 x 5		US4
55755	T2714	4-1/2 x 4-1/2		26D	56139	TA2714	5 x 5		US3
55763	T2714	4-1/2 x 4-1/2		14	56145	TA2714	5 X 5		15
55767	T2714	4-1/2 x 4-1/2		4	56147	TA2714	5 x 5		US26
55771	T2714	4-1/2 x 4-1/2		3	56149	TA2714	5 x 5		26D
55774	T2714	4-1/2 x 4-1/2		10	56155	TA2714	5 x 5		10B
55778	T2714	4-1/2 x 4-1/2	NRP	26D	57533	TA2771	4-1/2		26D
55783	T2714	4-1/2 x 4-1/2		D4	58845	T2314	3-1/2 x 3-1/2		32D
55797	RCTA2714	4-1/2 x 4		26D	58964	T2314	4-1/2 x 4-1/2		32D
55802	RCTA2714	4-1/2 x 4	NRP	D4	58972	T2314	4-1/2 x 4-1/2		10B
55810	TA2714	4-1/2 x 4-1/2		D4	59646	T2314	4 x 4		10B
55812	TA2714	4-1/2 x 4-1/2	NRP	D4	59661	T2314	4 x 4		32D
55819	HTA2714	4-1/2 x 4		26D	59678	TA2314	4 x 4		32D
55820	TA2714	4-1/2 x 4-1/2		P	59680	TA2314	4 x 4		10B
55822	TA2714	4-1/2 x 4-1/2	NRP	P	59746	TA2314	4-1/2 x 4		10B
55841	TA2714	4-1/2 x 4-1/2		5	59752	TA2314	4-1/2 x 4		32D
55842	TA2714	4-1/2 x 4-1/2		4	59755	TA2314	4-1/2 x 4	NRP	26D
55844	TA2714	4-1/2 x 4-1/2		9	59756	TA2314	4-1/2 x 4	NRP	32D
55846	TA2714	4-1/2 x 4-1/2		3	59807	HTA2314	4-1/2 x 4		32D
55847	TA2714	4-1/2 x 4-1/2		10A	59808	HTA2314	4-1/2 x 4-1/2		32D
55848	TA2714	4-1/2 x 4-1/2		10	59822	TA2314	4-1/2 x 4-1/2		4
55852	TA2714	4-1/2 x 4-1/2		14	59823	TA2314	4-1/2 x 4-1/2		32
55853	TA2714	4-1/2 x 4-1/2	NRP	3	59826	TA2314	4-1/2 x 4-1/2		3
55854	TA2714	4-1/2 x 4-1/2		15	59828	TA2314	4-1/2 x 4-1/2		10
55856	TA2714	4-1/2 x 4-1/2		26	59832	TA2314	4-1/2 x 4-1/2		26D
55858	TA2714	4-1/2 x 4-1/2		26D	59837	TA2314	4-1/2 x 4-1/2	NRP	26D
55859	HTA2714	4-1/2 x 4-1/2		26D	59838	TA2314	4-1/2 x 4-1/2		32D
55860	TA2714	4-1/2 x 4-1/2	NRP	26D	59838C	TA2314	4-1/2 x 4-1/2	CPC	32D
55862	TA2714	4-1/2 x 4-1/2		10B	59839	TA2314	4-1/2 x 4-1/2		10B
55862E	TA2714	4-1/2 x 4-1/2		10BE	59839E	TA2314	4-1/2 x 4-1/2	(SS)	10BE
55875	TA2714	4-1/2 x 4-1/2	NRP	10B	59839S	TA2314	4-1/2 x 4-1/2	(SS)	10B
55940	TB2714	4-1/2 x 4-1/2		26D	59840	TA2314	4-1/2 x 4-1/2	NRP	32D
55962	TA2714	5 x 4		26D	59847	TA2314	4-1/2 x 4-1/2	NRP SSF	32D
56010	TA2714	5 x 4-1/2		P	59904	TA2314	5 x 4-1/2		32D
56018	TA2714	5 x 4-1/2		26	59906	TA2314	5 x 4-1/2		10B
56020	TA2714	5 x 4-1/2		26D	59984	TA2314	5 x 5		32D
56021	TA2714	5 x 4-1/2		15	67206	TCA2714	4-1/2 x 4		26D
56026	TA2714	5 x 4-1/2		10B	67226	TCA2714	4-1/2 x 4-1/2		26D
56035	HTA2714	5 x 4-1/2		26D	67246	TCA2714	5 X 4-1/2		26D
56106	TA2714	4-1/2 x 4-1/2	BT	10B	69829	RCT2714	4 X 4		10B

Heavy Weight 3K Hinges

SKU	Cat.No.	Size	Options	Finishes	SKU	Cat.No.	Size	Options	Finishes
56400	TA786	4-1/2 x 4		26D	69396	TA386	4-1/2 x 4	NRP	32D
56401	TA786	4-1/2 x 4	NRP	26D	69413	TA386	4-1/2 x 4-1/2		32D
56404	TA786	4-1/2 x 4		15	69415	TA386	4-1/2 x 4-1/2	NRP	32D
69267	TA786	4-1/2 x 4-1/2		26D	69446	HTA386	4-1/2 x 4		32D
69271	TA786	4-1/2 x 4-1/2		10	74942	HTA386	5 x 4		32D
69272	TA786	4-1/2 x 4-1/2		10B	74956	TA386	5 x 4-1/2	NRP	32D
69275	TA786	4-1/2 x 4-1/2		26	75230	HTA786	4-1/2 x 4		26D
69276	TA786	4-1/2 x 4-1/2		15	75232	HTA786	4-1/2 x 4-1/2		26D
69278	TA786	5 x 4		15	75233	HTA786	5 X 4-1/2		26D
69279	TA786	5 x 4		26D	75240	TA786	4-1/2 x 4-1/2	NRP	26D
69282	TA786	5 x 4-1/2		26D	81306	HTA386	4-1/2 x 4-1/2		32D
69297	TA786	5 x 5		26D	81535	HTB386	4-1/2 x 4-1/2 PSF		32D

Heavy Weight 5K Hinges

SKU	Cat.No.	Size	Options	Finishes	SKU	Cat.No.	Size	Options	Finishes
58331	T4A3786	4-1/2 x 4		26D	58437	T4A3386	5 x 4		32D
58337	T4A3786	4-1/2 x 4	NRP	26D	58440	T4A3786	5 x 4-1/2		P
58341	T4A3786	4-1/2 x 4-1/2		D4	58443	T4A3786	5 x 4-1/2		26D
58343	T4A3786	4-1/2 x 4-1/2		3	58444	T4A3786	5 x 4-1/2		3
58344	T4A3786	4-1/2 x 4-1/2		4	58445	T4A3786	5 x 4-1/2		10
58346	T4A3786	4-1/2 x 4-1/2		10B	58446	T4A3786	5 x 4-1/2		4
58346E	T4A3786	4-1/2 x 4-1/2		10BE	58449	T4A3786	5 x 4-1/2	NRP	26D
58373	T4A3786	4-1/2 x 4-1/2		15	58453	T4A3786	5 x 4-1/2		10A
58375	T4A3786	4-1/2 x 4-1/2		P	58462	HTA3786	5 x 4-1/2		26D
58377	T4A3786	4-1/2 x 4-1/2		26	58464	T4A3786	5 x 4-1/2		10B
58379	T4A3786	4-1/2 x 4-1/2		10	58467	T4A3786	5 x 4-1/2		26
58384	T4A3786	4-1/2 x 4-1/2		26D	58522	T4A3786	5 x 5		26D
58388	T4A3786	4-1/2 x 4-1/2	NRP	26D	58524	T4A3786	5 x 5		10
58396	HT4A3786	4-1/2 x 4-1/2		26D	58532	T4A3786	5 x 5		10B
58435	T4A3786	5 x 4		26D					

Continued on next page

800-346-7707 | www.mckinneyhinge.com

Check the web site for the up-to-date catalog

McKinney is a brand associated with Corbin Russwin, Inc., an ASSA ABLOY Group company. Copyright © 2012-2017, Corbin Russwin, Inc. All rights reserved. Reproduction in whole or in part without the express written permission of Corbin Russwin, Inc. is prohibited.

ASSA ABLOY

The global leader in door opening solutions

Heavy Weight 5K Hinges (Continued)

SKU	Cat.No.	Size	Options	Finishes
58533	T4A3786	5 x 5		15
61772	T4A3386	4-1/2 x 4	NRP	32D
61773	HT4A3386	4-1/2 x 4		32D
61779	T4A3386	4-1/2 x 4		32D
61780	T4A3386	4-1/2 x 4-1/2	NRP SSF	32D
61787	T4A3386	4-1/2 x 4-1/2		32D
61790	T4A3386	4-1/2 x 4-1/2		4
61791	T4A3386	4-1/2 x 4-1/2		32
61794	T4A3386	4-1/2 x 4-1/2		3
61795	T4A3386	4-1/2 x 4-1/2		10B
61795S	T4A3386	4-1/2 x 4-1/2	(SS)	10B
61795E	T4A3386	4-1/2 x 4-1/2	(SS)	10BE
61796	T4A3386	4-1/2 x 4-1/2		10
61810	T4A3386	4-1/2 x 4-1/2	NRP	P
61812	T4A3386	4-1/2 x 4-1/2	NRP	26D
61813	T4A3386	4-1/2 x 4-1/2	NRP	10
61814	T4A3386	4-1/2 x 4-1/2	NRP	32D
61815	T4A3386	4-1/2 x 4-1/2	NRP	10B
61820	HT4A3386	4-1/2 x 4-1/2		32D
61849	T4B3386	4-1/2 x 4-1/2	NRP	32D
61860H	HT4A3386	5 x 4		32D
61861	T4A3386	5 x 4-1/2	NRP	10B
61862	T4A3386	5 x 4-1/2		10
61868	T4A3386	5 x 4-1/2		32D
61868H	HT4A3386	5 x 4-1/2		32D
61871	T4A3386	5 x 4-1/2	NRP	32D
61873	T4A3386	5 x 4-1/2		10B
61928	T4A3386	5 x 5		32D
61946	T4A3386	5 x 5	NRP	32D
67319	TCA3786	4-1/2 x 4-1/2	NRP	26D
67326	TCA3786	4-1/2 x 4-1/2		26D
67335	TCA3786	5 x 4		26D
67346	TCA3786	5 x 4-1/2		26D
68822	T4A3386	6 x 5	NRP	32D
72815	T4A3786	5 x 4-1/2		15

Half Surface Standard Weight 3K Hinges

SKU	Cat.No.	Size	Options	Finishes
74466	TA772	4-1/2		26D

Half Surface & Half Mortise Standard Weight 5K Hinges

SKU	Cat.No.	Size	Options	Finishes
57710	TA2772	4-1/2		P
57717	TA2772	4-1/2		26D
57833	TA2772	5		26D
57880	TA2774	4-1/2		P
57884	TA2774	4-1/2		26D
63240	BP-10 Hinge Back Plate	4-1/2		26D

Electric Hinges

SKU	Cat.No.	Size	Options	Finishes
55669	TA2714	4-1/2 x 4	CC4	26D
55885	TA2714	4-1/2 x 4-1/2	CC4	26D
55904	TA2714	4-1/2 x 4-1/2	CC8	26D
55905	TA2714	4-1/2 x 4-1/2	CC8	26
69083	TA714	4-1/2 x 4	CC8	26D
69084	TA714	4-1/2 x 4-1/2	CC8	26D
69203	TA714	4-1/2 x 4	CC4	26D
69266	TA714	4-1/2 x 4-1/2	CC4	26D
71118	T4A3786	4-1/2 x 4-1/2	CC4	26D
71136	T4A3786	5 x 4-1/2	CC4	26D
71166	T4A3786	4-1/2 x 4-1/2	CC8	26D
71469	TA2714	4-1/2 x 4-1/2	CC8	26D
71475	TA2714	4-1/2 x 4-1/2	CC8	3
71476	TA2714	4-1/2 x 4-1/2	CC8	4

Half Surface Heavy Weight 5K Hinges

SKU	Cat.No.	Size	Options	Finishes
58107	T4A3782	4-1/2		26D
58181	T4A3782	6	1-3/4 DR	26D
61563	T4A3382	4-1/2		32D
72339	T4A3782	6	2-1/4 DR	26D
63240	BP-10 Hinge Back Plate	4-1/2		26D

Swing Clear Heavy Weight 3K Hinges

SKU	Cat.No.	Size	Finishes
75381	TA795	5	26D
75476	TA795	4-1/2	26D
73454	HT4A3795	4-1/2	26D
73461	T4A3795	4-1/2	4

Swing Clear Standard Weight 5K Hinges

SKU	Cat.No.	Size	Finishes
57006	TA2895	4-1/2	26D
57011	TA2895	4-1/2	26
57041	TA4895	4-1/2	26D
57045	TA4895	4-1/2	26
57030	TA2895	5	26D
57049	TA4895	5	26D
73584	TA4395	5	32D
73585	TA2395	5	32D

Swing Clear Heavy Weight 5K Hinges

SKU	Cat.No.	Size	Finishes
55195	T4A3395	4-1/2	32D
55196	T4A3395	5	32D
73441	T4A4395	4-1/2	32D
73449	T4A4795	4-1/2	26
73451	T4A4795	4-1/2	26D
73452	HT4A4795	4-1/2	26D
73463	T4A3795	4-1/2	26D
73482	T4A3795	5	26D
73486	HT4A3795	5	26D
73522	T4A3796	5	26D
73589	HT4A4795	5	26D
73590	T4A4795	5	26D

Anchor Hinge Heavy Weight 3K Hinges

SKU	Cat.No.	Size	Options	Finishes
75492	TA792	5 x 4-1/2	RH	26D
75493	TA792	5 x 4-1/2	LH	26D
75500	TA392	5 x 4-1/2	RH	32D
75501	TA392	5 x 4-1/2	LH	32D
75532	TA5792	5 x 4-1/2	RH	26D
75533	TA5792	5 x 4-1/2	LH	26D
75544	TA5392	5 x 4-1/2	RH	32D
75545	TA5392	5 x 4-1/2	LH	32D
75581	TA5393	5 x 4-1/2	RH	32D
75582	TA5393	5 x 4-1/2	LH	32D

SKU	Cat.No.	Size	Options	Finishes
71477	TA2714	4-1/2 x 4-1/2	CC8	10
71479	TA2714	4-1/2 x 4-1/2	CC8	10B
71494	T4A3786	4-1/2 x 4-1/2	CC8	3
71495	T4A3786	4-1/2 x 4-1/2	CC8	4
71496	T4A3786	4-1/2 x 4-1/2	CC8	10
71498	T4A3786	4-1/2 x 4-1/2	CC8	10B
71499	T4A3786	4-1/2 x 4-1/2	CC8	26
71508	T4A3786	5 x 4-1/2	CC8	26D
71520	TA2714	4-1/2 x 4-1/2	CC8	15
73192	TA2714	4-1/2 x 4-1/2	QC4	26D
73216	T4A3786	4-1/2 x 4-1/2	QC4	26D
73274	T4A3786	4-1/2 x 4-1/2	QC6	26D
73279	T4A3786	5 x 4-1/2	QC6	26D

Continued on next page



The global leader in door opening solutions

Electric Hinges (Continued)

SKU	Cat.No.	Size	Options	Finishes
73300	TA2714	4-1/2 x 4	QC8	26D
73312	TA2714	4-1/2 x 4-1/2	QC8	26D
73332	T4A3786	4-1/2 x 4-1/2	QC8	26D
73336	T4A3786	5 x 4-1/2	QC8	26D
73358	TA2714	4-1/2 x 4	QC12	26D
73364	TA2714	4-1/2 x 4-1/2	QC12	3
73365	TA2714	4-1/2 x 4-1/2	QC12	4
73366	TA2714	4-1/2 x 4-1/2	QC12	10
73368	TA2714	4-1/2 x 4-1/2	QC12	10B
73369	TA2714	4-1/2 x 4-1/2	QC12	26
73370	TA2714	4-1/2 x 4-1/2	QC12	26D

SKU	Cat.No.	Size	Options	Finishes
73390	T4A3786	4-1/2 x 4-1/2	QC12	26D
73394	T4A3786	5 x 4-1/2	QC12	26D
73401	TA714	4-1/2 x 4-1/2	QC12	26D
73439	TA786	4-1/2 x 4	QC12	26D
73749	TA786	4-1/2 x 4-1/2	QC8	26D
73994	TA714	4-1/2 x 4	QC12	26D
73995	T4A3786	4-1/2 x 4	CC8	26D
73996	T4A3786	4-1/2 x 4	QC12	26D
73999	TA786	4-1/2 x 4	CC8	26D
74000	TA786	4-1/2 x 4	QC12	26D

ElectroLynx® Accessories

SKU	Cat.No.	Description	Size
93970	QC-C2500P	12 WIRE	22AWG 25 FT
93971	QC-C3000P	12 WIRE	22AWG 30 FT
93978	QC-RM4	MALE PLUG	4CKT
93979	QC-RM8	MALE PLUG	8CKT
93980	QC-MT2024	MALE TERMINAL	AWG 20-24
93981	QC-C003	12 WIRE	22AWG 3 IN
93982	QC-C006	12 WIRE	22AWG 6 IN
93983	QC-C012	12 WIRE	22AWG 12 IN
93984	QC-C200	12 WIRE	22AWG 26 IN
93985	QC-C206	12 WIRE	22AWG 32 IN
93986	QC-C300	12 WIRE	22AWG 38 IN
93987	QC-C306	12 WIRE	22AWG 44 IN
93988	QC-C400	12 WIRE	22AWG 50 IN
93989	QC-C1500	12 WIRE	22AWG 15 FT 2 IN
93990	QC-C003P	12 WIRE	22AWG 3 IN
93991	QC-C006P	12 WIRE	22AWG 6 IN
93992	QC-C012P	12 WIRE	22AWG 12 IN
93993	QC-C200P	12 WIRE	22AWG 26 IN
93994	QC-C206P	12 WIRE	22AWG 32 IN
93995	QC-C300P	12 WIRE	22AWG 38 IN
93996	QC-C306P	12 WIRE	22AWG 44 IN
93997	QC-C400P	12 WIRE	22AWG 50 IN
93998	QC-C1500P	12 WIRE	AWG 15 FT 2 IN
94002	MCK-TSB-C	DOOR CORD	18 IN
94003	MCK-TSB-CXL	DOOR CORD	36 IN
94004	MCK-EPT	ELEC. PWR TRANSFER	
94005	MCK-EPTL	ELEC. PWR TRNSFR LONG	

SKU	Cat.No.	Description	Size
94006	MCK EL-EPT-12	ELEC. PWR TRNSFR	12 WIRE
94007	MCK EL-EPTL-12	ELEC. PWR TRNSFR	"12 WIRE, LONG "
94016	POE-MT2024	MALE TERMINAL	AWG 20-24
94017	POE-RM6	MALE PLUG	6 CKT
94018	POE-RF6	FEMALE PLUG	6 CKT
94019	POE-MT2630	MALE TERMINAL	AWG 26-30
94020	POE-FT2630	FEMALE TERMINAL	AWG 26-30
94021	PoE-C700P	DOOR HARNESS ASSY	84 IN
94022	PoE-C206P	DOOR HARNESS ASSY	30 IN
94023	PoE-CEPT30	DOOR HARNESS ASSY	30 FT
94026	QC-RF4	FEMALE RECEPTACLE	4 CKT
94027	QC-RF8	FEMALE RECEPTACLE	8 CKT
94028	QC-RM2	MALE PLUG	2 CKT
94029	QC-FT2024	FEMALE TERMINAL	AWG 20-24
94030	QC-FT2630	FEMALE TERMINAL	AWG 26-30
94031	QC-MT2630	MALE TERMINAL	AWG 26-30
94034	QC-R001	MOLEX REPAIR SERVICE KIT	
94035	QC-R002	EXTRACTION TOOL	
94036	QC-R003	MOLEX HAND CRIMP TOOL	
94037	QC-RF2	FEMALE RECEPTACLE	2 CKT
94038	PoE-C300P	DOOR HARNESS ASSY	36 IN
94039	PoE-C306P	DOOR HARNESS ASSY	42 IN
94040	PoE-C400P	DOOR HARNESS ASSY	48 IN
94041	PoE-C406P	DOOR HARNESS ASSY	54 IN
94042	PoE-C500P	DOOR HARNESS ASSY	60 IN
94043	PoE-C1300P	DOOR HARNESS ASSY	156 IN
94044	PoE-C1500P	FRAME HARNESS	180 IN

MACPro Hinges 5K Hinges

SKU	Cat.No.	Size	Options	Finishes
76312	MPB79	4-1/2 x 4-1/2		3
76316	MPB79	4-1/2 x 4-1/2		4
76324	MPB79	4-1/2 x 4-1/2		10B
76324E	MPB79	4-1/2 x 4-1/2		10BE
76325	MPB79	4-1/2 x 4-1/2	NRP	10B
76325E	MPB79	4-1/2 x 4-1/2	NRP	10BE
76328	MPB79	4-1/2 x 4-1/2		26
76332	MPB79	4-1/2 x 4-1/2		26D
76333	MPB79	4-1/2 x 4-1/2	NRP	26D
76336	MPB79	4-1/2 x 4-1/2		P
76337	MPB79	4-1/2 x 4-1/2	NRP	P
76340	MPB91	4-1/2 x 4-1/2		32D
76341	MPB91	4-1/2 x 4-1/2	NRP	32D
76344	MP79	4-1/2 x 4-1/2		3
76360	MP79	4-1/2 x 4-1/2		26
76362	MPB79	4-1/2 x 4		26D
76363	MPB79	4-1/2 x 4	NRP	26D
76364	MP79	4-1/2 x 4-1/2		26D
76364E	MP79	4-1/2 x 4-1/2		10BE
76365	MP79	4-1/2 x 4-1/2	NRP	26D

SKU	Cat.No.	Size	Options	Finishes
76368	MP79	4-1/2 x 4-1/2		P
76369	MP79	4-1/2 x 4-1/2	NRP	P
76374	MPB68	4-1/2 x 4-1/2		26D
76375	MPB68	4-1/2 x 4-1/2	NRP	26D
76376	MPB99	4-1/2 x 4-1/2		32D
76377	MPB99	4-1/2 x 4-1/2	NRP	32D
76378	MPS60	4-1/2 x 4-1/2		26D
76379	MPS679	4-1/2 x 4-1/2		26D
76380	MPS60	4-1/2 x 4-1/2		P
76383	MPB79	4-1/2 x 4-1/2		15
76384	MP79	4-1/2 x 4-1/2		15
76385	MPS 60	4-1/2 x 4-1/2		15
76386	MPB79	4-1/2 x 4		15
76387	MP79	4-1/2 x 4		15
76388	MPS60	4-1/2 x 4		15
76390	MPB68	5 x 4-1/2		26D
76392	MPB99	5 x 4-1/2		32D
76393	MPB99	5 x 4-1/2	NRP	32D
76395	MPB68	4-1/2 x 4-1/2		15
76383	MPB79	4-1/2 x 4-1/2		15

MACPro Electric Hinges 5K Hinges

SKU	Cat.No.	Size	Options	Finishes
76402	MPB79	4-1/2 x 4	CC8	26D
76404	MPB79	4-1/2 x 4	QC12	26D
76405	MPB79	4-1/2 x 4-1/2	CC4	26D
76407	MPB79	4-1/2 x 4-1/2	CC8	26D

SKU	Cat.No.	Size	Options	Finishes
76409	MPB79	4-1/2 x 4-1/2	QC12	26D
76412	MPB68	4-1/2 x 4-1/2	CC8	26D
76414	MPB68	4-1/2 x 4-1/2	QC12	26D

800-346-7707 | www.mckinneyhinge.com

Check the web site for the up-to-date catalog

McKinney is a brand associated with Corbin Russwin, Inc., an ASSA ABLOY Group company. Copyright © 2012-2017, Corbin Russwin, Inc. All rights reserved. Reproduction in whole or in part without the express written permission of Corbin Russwin, Inc. is prohibited.

ASSA ABLOY

The global leader in door opening solutions

Specialty Hinges

SKU	Cat. No.	Size	Options	Finishes
55957	RBTB2714	4-1/2 x 4-1/2		26D
58436	RBT4A3786	4-1/2 x 4-1/2		26D
57470	TA2714	5 x 4-1/2	Interim	26D
57475	T4A3386	5 x 4-1/2	Interim	32D
57480	T4A3786	5 x 4-1/2	Interim	26D
63539	PH-4			26D

Rescue Hardware

SKU	Cat. No.	Size	Finishes
63330	CSS-9 Center Hung	5-3/4	26D
63332	CSS-9 Offset Hung	5-3/4	26D
63345	DS-6	-	26D
63346	EP-5J	-	26D
63293	CSS-9 Offset Hung	5-7/8	26D
63313	CSS-9 Center Hung	5-7/8	26D
63331	CSS-9 Center Hung	6-3/4	26D

Square Barrel Hinges

SKU	Cat. No.	Size	Options	Finishes
75844	SQ3331	4-1/2 x 4-1/2	LH	14
75742	SQ3331	4-1/2 x 4-1/2	LH	15
75846	SQ3331	4-1/2 x 4-1/2	LH	26
75744	SQ3331	4-1/2 x 4-1/2	LH	26D
75840	SQ3331	4-1/2 x 4-1/2	LH	3
75843	SQ3331	4-1/2 x 4-1/2	RH	10B
75845	SQ3331	4-1/2 x 4-1/2	RH	14
75743	SQ3331	4-1/2 x 4-1/2	RH	15
75847	SQ3331	4-1/2 x 4-1/2	RH	26
75745	SQ3331	4-1/2 x 4-1/2	RH	26D
75841	SQ3331	4-1/2 x 4-1/2	RH	3

Butt Hinge Finish Sample Case

SKU	Cat. No.	Description
73002	FS-86	Finish Sample Case

Residential Hinges

SKU	Cat. No.	Size	Finishes
56288	1400	3-1/2	26D
56821	1414	3-1/2	26D
56868	1458	3-1/2	26D

Door Springs

SKU	Cat. No.	Size	Finishes
155371	451	9	D4
155381	453	11	D4
155401	452	13	D4

Olive Knuckle Hinges

SKU	Cat. No.	Size	Options	Finishes
76206	TA3383	6	LH	10B
76207	TA3383	6	RH	10B
76208	TA3383	6	LH	14
76209	TA3383	6	RH	14
76200	TA3383	6	LH	15
76201	TA3383	6	RH	15
76210	TA3383	6	LH	26
76211	TA3383	6	RH	26
76202	TA3383	6	LH	26D
76203	TA3383	6	RH	26D
76204	TA3383	6	LH	3
76205	TA3383	6	RH	3

Stocking Programs

Pick up orders must be placed by noon.

These items are in stock at both:

Ventura, CA Stocking Program:
4226 Transport Street, Ventura, CA 93003
Phone: 805-535-3262 or 805-535-3246

Mason City, IA Stocking Program:
1600 12TH Street, NE, Mason City, IA 50401
Phone: 641-494-1683 • Fax: 641-422-1965

SKU	Size	Cat. No.	Finish	Option
-----	------	----------	--------	--------

Three Knuckle Steel Standard Weight Hinges

69222	4 1/2 x 4 1/2	TA714	26D	
69227	4 1/2 x 4 1/2	TA714	10B	

Five Knuckle Steel Standard Weight Hinges

55742	4 1/2 x 4 1/2	T2714	10B	
55755	4 1/2 x 4 1/2	T2714	26D	
55820	4 1/2 x 4 1/2	TA2714	P	
55846	4 1/2 x 4 1/2	TA2714	3	
55848	4 1/2 x 4 1/2	TA2714	10	
55854	4 1/2 x 4 1/2	TA2714	15	
55856	4 1/2 x 4 1/2	TA2714	26	
55858	4 1/2 x 4 1/2	TA2714	26D	
55860	4 1/2 x 4 1/2	TA2714	26D	NRP
55862	4 1/2 x 4 1/2	TA2714	10B	
55875	4 1/2 x 4 1/2	TA2714	10B	NRP
55940	4 1/2 x 4 1/2	TB2714	26D	
56020	5 x 4 1/2	TA2714	26D	

Five Knuckle Non-Ferrous Standard Weight Hinges

59832	4 1/2 x 4 1/2	TA2314	26D	
59837	4 1/2 x 4 1/2	TA2314	26D	NRP
59838	4 1/2 x 4 1/2	TA2314	32D	
59840	4 1/2 x 4 1/2	TA2314	32D	NRP

Five Knuckle Steel Heavy Weight Hinges

58384	4 1/2 x 4 1/2	T4A3786	26D	
58388	4 1/2 x 4 1/2	T4A3786	26D	NRP
58443	5 x 4 1/2	T4A3786	26D	

Five Knuckle Non-Ferrous Heavy Weight Hinges

61787	4 1/2 x 4 1/2	T4A3386	32D	
61814	4 1/2 x 4 1/2	T4A3386	32D	NRP
61871	5 x 4 1/2	T4A3386	32D	NRP

Steel Spring Hinges

156023	4 1/2 x 4 1/2	1502	26D	
--------	---------------	------	-----	--

SKU	Size	Cat. No.	Finish	Option
-----	------	----------	--------	--------

Five Knuckle Steel Standard Weight Electric Hinges

73192	4 1/2 x 4 1/2	TA2714	26D	QC4
73312	4 1/2 x 4 1/2	TA2714	26D	QC8
73370	4 1/2 x 4 1/2	TA2714	26D	QC12

Five Knuckle Steel Heavy Weight Electric Hinges

73216	4 1/2 x 4 1/2	T4A3786	26D	QC4
73332	4 1/2 x 4 1/2	T4A3786	26D	QC8

Mac Pro Standard Weight Steel Hinges

76364	4 1/2 x 4 1/2	MP79	26D	
76332	4 1/2 x 4 1/2	MPB79	26D	
76333	4 1/2 x 4 1/2	MPB79	26D	NRP
76336	4 1/2 x 4 1/2	MPB79	P	

Mac Pro Standard Weight Non-Ferrous Hinges

76340	4 1/2 x 4 1/2	MPB91	32D	
76341	4 1/2 x 4 1/2	MPB91	32D	NRP

Mac Pro Heavy Weight Steel Hinges

76374	4 1/2 x 4 1/2	MPB68	26D	
76375	4 1/2 x 4 1/2	MPB68	26D	NRP

Mac Pro Heavy Weight Non-Ferrous Hinges

76376	4 1/2 x 4 1/2	MPB99	32D	
76377	4 1/2 x 4 1/2	MPB99	32D	NRP

Mac Pro Steel Spring Hinges

76378	4 1/2 x 4 1/2	MPS60	26D	
-------	---------------	-------	-----	--

Transfer Device Cables

93981	QC-C003	12 WIRE 22AWG 3 INCH		
93984	QC-C200	12 WIRE 22AWG 26 INCH		
93985	QC-C206	12 WIRE 22AWG 32 INCH		
93986	QC-C300	12 WIRE 22AWG 38 INCH		
93987	QC-C306	12 WIRE 22AWG 44 INCH		
93988	QC-C400	12 WIRE 22AWG 50 INCH		
93989	QC-C1500	12 WIRE 22AWG 15 FT, 2 IN.		
93998	QC-C1500P	12 WIRE 22AWG 15 FT, 2 IN.		

ASSA ABLOY

QS-5 The global leader in door opening solutions

800-346-7707 | www.mckinneyhinge.com

Check the web site for the up-to-date catalog

McKinney is a brand associated with Corbin Russwin, Inc., an ASSA ABLOY Group company. Copyright © 2012-2017, Corbin Russwin, Inc. All rights reserved. Reproduction in whole or in part without the express written permission of Corbin Russwin, Inc. is prohibited.

Berlin, CT Stocking Program

These items are in stock at 225 Episcopal Road, Berlin CT 06037
 Phone 800-346-7707 - Fax 800-541-1073.
 Pick up orders must be placed by noon.

Prices Effective September 1, 2017

Berlin, CT Stocking Program

These items are in stock at 225 Episcopal Road, Berlin CT 06037 • Phone 800-346-7707 - Fax 800-541-1073. Pick up orders must be placed by noon.

STEEL HINGES

SKU	Size	Cat.No.	Finish	Option
Residential Hinges				
56868	3-1/2 x 3-1/2	1458	26D	
56821	3-1/2 x 3-1/2	1414	26D	
56288	3-1/2 x 3-1/2	1400	26D	
Full Mortise Standard Weight Two Knuckle				
65623	4-1/2	TA2731	26D	RH
65624	4-1/2	TA2731	26D	LH
Full Mortise Standard Weight Three Knuckle				
69177	3-1/2 x 3-1/2	TA714	26D	
69188	3-1/2 x 3-1/2	TA714	15	
56403	4-1/2 x 4	TA714	15	
69176	4-1/2 x 4	TA714	10A	
69207	4-1/2 x 4	TA714	26D	
69210	4-1/2 x 4	TA714	4	
69211	4-1/2 x 4	TA714	10	
69212	4-1/2 x 4	TA714	10B	
69215	4-1/2 x 4	TA714	26	
69217	4-1/2 x 4	TA714	3	
69221	4-1/2 x 4	TA714	D4	
74201	4-1/2 x 4	TA714	26D	NRP
69222	4-1/2 x 4-1/2	TA714	26D	
69222FT	4-1/2 x 4-1/2	TA714	26D	FT
69223	4-1/2 x 4-1/2	TA714	P	
69225	4-1/2 x 4-1/2	TA714	4	
69226	4-1/2 x 4-1/2	TA714	10	
69227	4-1/2 x 4-1/2	TA714	10B	
69228	4-1/2 x 4-1/2	TA714	15	
69230	4-1/2 x 4-1/2	TA714	26	
69232	4-1/2 x 4-1/2	TA714	3	
69236	4-1/2 x 4-1/2	TA714	10A	
74283	4-1/2 x 4-1/2	TA714	26D	NRP
74284	4-1/2 x 4-1/2	TA714	D4	
69625	5 x 4	TA714	26D	
69237	5 x 4-1/2	TA714	26D	
69252	5 x 5	TA714	26D	
Full Mortise Standard Five Knuckle				
55314	3-1/2 x 3-1/2	T2714	15	
55315	3-1/2 x 3-1/2	T2714	P	
55317	3-1/2 x 3-1/2	T2714	3	
55319	3-1/2 x 3-1/2	T2714	26D	
55321	3-1/2 x 3-1/2	T2714	10	
55327	3-1/2 x 3-1/2	T2714	26	
55333	3-1/2 x 3-1/2	T2714	10B	
55337	3-1/2 x 3-1/2	T2714	4	
55380	3-1/2 x 3-1/2	T2714	D4	
55430	3-1/2 x 3-1/2	RCT2714	10B	
55438	3-1/2 x 3-1/2	RCT2714	26D	
55443	3-1/2 x 3-1/2	RCT2714	D4	
55385	3-1/2 x 3-1/2	TA2714	P	
55389	3-1/2 x 3-1/2	TA2714	10B	
55391	3-1/2 x 3-1/2	TA2714	3	
55392	3-1/2 x 3-1/2	TA2714	15	
55393	3-1/2 x 3-1/2	TA2714	26D	
55395	3-1/2 x 3-1/2	TA2714	10	
55485	4 x 4	T2714	P	
55487	4 x 4	T2714	4	
55491	4 x 4	T2714	3	
55496	4 x 4	T2714	10B	
55497	4 x 4	T2714	15	
55499	4 x 4	T2714	26	
55501	4 x 4	T2714	26D	
55509	4 x 4	T2714	D4	
55521	4 x 4	RCT2714	26D	
69829	4 x 4	RCT2714	10B	
55555	4 x 4	TA2714	P	
55561	4 x 4	TA2714	3	
55563	4 x 4	TA2714	10	
55569	4 x 4	TA2714	26	
55571	4 x 4	TA2714	26D	
55577	4 x 4	TA2714	10B	

SKU	Size	Cat.No.	Finish	Option
55632	4 x 4	RCTA2714	26D	
55635	4-1/2 x 4	T2714	P	
55639	4-1/2 x 4	T2714	26D	
55644	4-1/2 x 4	T2714	10B	
55656	4-1/2 x 4	T2714	15	
55616	4-1/2 x 4	TA2714	15	
55673	4-1/2 x 4	TA2714	10A	
55674	4-1/2 x 4	TA2714	4	
55675	4-1/2 x 4	TA2714	P	
55679	4-1/2 x 4	TA2714	26D	
55681	4-1/2 x 4	TA2714	10	
55683	4-1/2 x 4	TA2714	3	
55688	4-1/2 x 4	TA2714	26	
55690	4-1/2 x 4	TA2714	26D	NRP
55691	4-1/2 x 4	TA2714	10B	
55691E	4-1/2 x 4	TA2714	10BE	
55797	4-1/2 x 4	RCTA2714	26D	
55802	4-1/2 x 4	RCTA2714	D4	NRP
55742	4-1/2 x 4-1/2	T2714	10B	
55742E	4-1/2 x 4-1/2	T2714	10BE	
55745	4-1/2 x 4-1/2	T2714	P	
55747	4-1/2 x 4-1/2	T2714	P	NRP
55751	4-1/2 x 4-1/2	T2714	15	
55753	4-1/2 x 4-1/2	T2714	26	
55755	4-1/2 x 4-1/2	T2714	26D	
55763	4-1/2 x 4-1/2	T2714	14	
55767	4-1/2 x 4-1/2	T2714	4	
55771	4-1/2 x 4-1/2	T2714	3	
55774	4-1/2 x 4-1/2	T2714	10	
55778	4-1/2 x 4-1/2	T2714	26D	NRP
55783	4-1/2 x 4-1/2	T2714	D4	
55810	4-1/2 x 4-1/2	TA2714	D4	
55812	4-1/2 x 4-1/2	TA2714	D4	NRP
55820	4-1/2 x 4-1/2	TA2714	P	
55822	4-1/2 x 4-1/2	TA2714	P	NRP
55841	4-1/2 x 4-1/2	TA2714	5	
55842	4-1/2 x 4-1/2	TA2714	4	
55844	4-1/2 x 4-1/2	TA2714	9	
55846	4-1/2 x 4-1/2	TA2714	3	
55847	4-1/2 x 4-1/2	TA2714	10A	
55848	4-1/2 x 4-1/2	TA2714	10	
55852	4-1/2 x 4-1/2	TA2714	14	
55853	4-1/2 x 4-1/2	TA2714	3	NRP
55854	4-1/2 x 4-1/2	TA2714	15	
55856	4-1/2 x 4-1/2	TA2714	26	
55858	4-1/2 x 4-1/2	TA2714	26D	
55860	4-1/2 x 4-1/2	TA2714	26D	NRP
55862	4-1/2 x 4-1/2	TA2714	10B	
55862E	4-1/2 x 4-1/2	TA2714	10BE	
55875	4-1/2 x 4-1/2	TA2714	10B	NRP
55940	4-1/2 x 4-1/2	TB2714	26D	
56106	4-1/2 x 4-1/2	TA2714	10B	BT
55962	5 x 4	TA2714	26D	
56010	5 x 4-1/2	TA2714	P	
56018	5 x 4-1/2	TA2714	26	
56020	5 x 4-1/2	TA2714	26D	
56021	5 x 4-1/2	TA2714	15	
56026	5 x 4-1/2	TA2714	10B	
56135	5 x 5	TA2714	4	
56139	5 x 5	TA2714	3	
56145	5 x 5	TA2714	15	
56147	5 x 5	TA2714	26	
56149	5 x 5	TA2714	26D	
56155	5 x 5	TA2714	10B	
Full Mortise Heavy Weight Three Knuckle				
56400	4-1/2 x 4	TA786	26D	
56401	4-1/2 x 4	TA786	26D	NRP
56404	4-1/2 x 4	TA786	15	
69267	4-1/2 x 4-1/2	TA786	26D	
69271	4-1/2 x 4-1/2	TA786	10	
69272	4-1/2 x 4-1/2	TA786	10B	

Continued on next page

800-346-7707 | www.mckinneyhinge.com

Check the web site for the up-to-date catalog

McKinney is a brand associated with Corbin Russwin, Inc., an ASSA ABLOY Group company. Copyright © 2012-2017, Corbin Russwin, Inc. All rights reserved. Reproduction in whole or in part without the express written permission of Corbin Russwin, Inc. is prohibited.

ASSA ABLOY

The global leader in
 door opening solutions

QS-6

SKU	Size	Cat.No.	Finish	Option
Full Mortise Heavy Weight Three Knuckle (Continued)				
69275	4-1/2 x 4-1/2	TA786	26	
69276	4-1/2 x 4-1/2	TA786	15	
75240	4-1/2 x 4-1/2	TA786	26D	NRP
69278	5 x 4	TA786	15	
69279	5 x 4	TA786	26D	
69282	5 x 4-1/2	TA786	26D	
69297	5 x 5	TA786	26D	

SKU	Size	Cat.No.	Finish	Option
Full Mortise Heavy Weight Five Knuckle				
58331	4-1/2 x 4	T4A3786	26D	
58337	4-1/2 x 4	T4A3786	26D	NRP
58341	4-1/2 x 4-1/2	T4A3786	D4	
58373	4-1/2 x 4-1/2	T4A3786	15	
58379	4-1/2 x 4-1/2	T4A3786	10	
58343	4-1/2 x 4-1/2	T4A3786	3	
58344	4-1/2 x 4-1/2	T4A3786	4	
58346	4-1/2 x 4-1/2	T4A3786	10B	
58346E	4-1/2 x 4-1/2	T4A3786	10BE	
58375	4-1/2 x 4-1/2	T4A3786	P	
58377	4-1/2 x 4-1/2	T4A3786	26	
58384	4-1/2 x 4-1/2	T4A3786	26D	
58388	4-1/2 x 4-1/2	T4A3786	26D	NRP
58435	5 x 4	T4A3786	26D	
58440	5 x 4-1/2	T4A3786	P	
58443	5 x 4-1/2	T4A3786	26D	
58444	5 x 4-1/2	T4A3786	3	
58445	5 x 4-1/2	T4A3786	10	
58446	5 x 4-1/2	T4A3786	4	
58449	5 x 4-1/2	T4A3786	26D	NRP
58453	5 x 4-1/2	T4A3786	10A	
58464	5 x 4-1/2	T4A3786	10B	
58467	5 x 4-1/2	T4A3786	26	
72815	5 x 4-1/2	T4A3786	15	
58522	5 x 5	T4A3786	26D	
58524	5 x 5	T4A3786	10	
58532	5 x 5	T4A3786	10B	
58533	5 x 5	T4A3786	15	

SKU	Size	Cat.No.	Finish	Option
Three Knuckle Standard Weight Hospital Tip Hinges				
74350	4-1/2 x 4	HTA714	26D	
69233	4-1/2 x 4-1/2	HTA714	26D	

SKU	Size	Cat.No.	Finish	Option
Five Knuckle Standard Weight Hospital Tip Hinges				
55819	4-1/2 x 4	HTA2714	26D	
55859	4-1/2 x 4-1/2	HTA2714	26D	
56035	5 x 4-1/2	HTA2714	26D	

SKU	Size	Cat.No.	Finish	Option
Three Knuckle Heavy Weight Hospital Tip Hinges				
75230	4-1/2 x 4	HTA786	26D	
75233	5 x 4-1/2	HTA786	26D	
75232	4-1/2 x 4-1/2	HTA786	26D	

SKU	Size	Cat.No.	Finish	Option
Five Knuckle Heavy Weight Hospital Tip Hinges				
58396	4-1/2 x 4-1/2	HT4A3786	26D	
58462	5 x 4-1/2	HT4A3786	26D	

SKU	Size	Cat.No.	Finish	Option
Five Knuckle Concealed Bearing Standard Weight Hinges				
67206	4-1/2 x 4	TCA2714	26D	
67226	4-1/2 x 4-1/2	TCA2714	26D	
67246	5 x 4-1/2	TCA2714	26D	

SKU	Size	Cat.No.	Finish	Option
Five Knuckle Concealed Bearing Heavy Weight Hinges				
67319	4-1/2 x 4-1/2	TCA3786	26D	NRP
67326	4-1/2 x 4-1/2	TCA3786	26D	
67335	5 x 4	TCA3786	26D	
67346	5 x 4-1/2	TCA3786	26D	

SKU	Size	Cat.No.	Finish	Option
Three Knuckle Standard Weight Electric Hinges				
69203	4-1/2 x 4	TA714	26D	CC4
69083	4-1/2 x 4	TA714	26D	CC8
73994	4-1/2 x 4	TA714	26D	QC12
69084	4-1/2 x 4-1/2	TA714	26D	CC8
69266	4-1/2 x 4-1/2	TA714	26D	CC4
73401	4-1/2 x 4-1/2	TA714	26D	QC12

SKU	Size	Cat.No.	Finish	Option
Three Knuckle Heavy Weight Electric Hinges				
73999	4-1/2 x 4	TA786	26D	CC8
74000	4-1/2 x 4	TA786	26D	QC12
73749	4-1/2 x 4-1/2	TA786	26D	QC8
73439	4-1/2 x 4-1/2	TA786	26D	QC12

SKU	Size	Cat.No.	Finish	Option
Five Knuckle Standard Weight Electric Hinges				
55669	4-1/2 x 4	TA2714	26D	CC4
71469	4-1/2 x 4	TA2714	26D	CC8
73300	4-1/2 x 4	TA2714	26D	QC8
73358	4-1/2 x 4	TA2714	26D	QC12
55885	4-1/2 x 4-1/2	TA2714	26D	CC4
55904	4-1/2 x 4-1/2	TA2714	26D	CC8
55905	4-1/2 x 4-1/2	TA2714	26	CC8
71475	4-1/2 x 4-1/2	TA2714	3	CC8
71476	4-1/2 x 4-1/2	TA2714	4	CC8
71477	4-1/2 x 4-1/2	TA2714	10	CC8
71479	4-1/2 x 4-1/2	TA2714	10B	CC8
71520	4-1/2 x 4-1/2	TA2714	15	CC8
73192	4-1/2 x 4-1/2	TA2714	26D	QC4
73312	4-1/2 x 4-1/2	TA2714	26D	QC8
73364	4-1/2 x 4-1/2	TA2714	3	QC12
73365	4-1/2 x 4-1/2	TA2714	4	QC12
73366	4-1/2 x 4-1/2	TA2714	10	QC12
73368	4-1/2 x 4-1/2	TA2714	10B	QC12
73369	4-1/2 x 4-1/2	TA2714	26	QC12
73370	4-1/2 x 4-1/2	TA2714	26D	QC12

SKU	Size	Cat.No.	Finish	Option
Five Knuckle Heavy Weight Electric Hinges				
73995	4-1/2 x 4	T4A3786	26D	CC8
73996	4-1/2 x 4	T4A3786	26D	QC12
71118	4-1/2 x 4-1/2	T4A3786	26D	CC4
73216	4-1/2 x 4-1/2	T4A3786	26D	QC4
73274	4-1/2 x 4-1/2	T4A3786	26D	QC6
71166	4-1/2 x 4-1/2	T4A3786	26D	CC8
71494	4-1/2 x 4-1/2	T4A3786	3	CC8
71495	4-1/2 x 4-1/2	T4A3786	4	CC8
71496	4-1/2 x 4-1/2	T4A3786	10	CC8
71498	4-1/2 x 4-1/2	T4A3786	10B	CC8
71499	4-1/2 x 4-1/2	T4A3786	26	CC8
73332	4-1/2 x 4-1/2	T4A3786	26D	QC8
71136	5 x 4-1/2	T4A3786	26D	CC4
73279	5 x 4-1/2	T4A3786	26D	QC6
73336	5 x 4-1/2	T4A3786	26D	QC8
71508	5 x 4-1/2	T4A3786	26D	CC8
73390	4-1/2 x 4-1/2	T4A3786	26D	QC12
73394	5 x 4-1/2	T4A3786	26D	QC12

SKU	Size	Cat.No.	Finish	Option
Anchor Hinges				
75492	5 x 4-1/2	TA792	26D	RH
75493	5 x 4-1/2	TA792	26D	LH
75532	5 x 4-1/2	TA5792	26D	RH
75533	5 x 4-1/2	TA5792	26D	LH

SKU	Size	Cat.No.	Finish	Option
Steel Door Springs				
155371		451	D4	
155401		452	D4	
155381		453	D4	

SKU	Size	Cat.No.	Finish	Option
Steel Spring Hinges				
156007	1502	4-1/2 x 4	15	
156008	1502	4-1/2 x 4	26D	
156015	1502	4-1/2 x 4-1/2	D4	
156017	1502	4-1/2 x 4-1/2	P	
156019	1502	4-1/2 x 4-1/2	4	
156020	1502	4-1/2 x 4-1/2	10	
156021	1502	4-1/2 x 4-1/2	10B	
156021E	1502	4-1/2 x 4-1/2	10BE	
156022	1502	4-1/2 x 4-1/2	15	
156024	1502	4-1/2 x 4-1/2	26	
156025	1502	4-1/2 x 4-1/2	3	
156045	1522	4-1/2 x 4-1/2	10B	
156046	1522	4-1/2 x 4-1/2	15	
156047	1522	4-1/2 x 4-1/2	26D	

SKU	Size	Cat.No.	Finish	Option
Mac Pro Standard Weight Steel Hinges				
76387	4-1/2 x 4	MP79	15	
76386	4-1/2 x 4	MPB79	15	
76362	4-1/2 x 4	MPB79	26D	
76363	4-1/2 x 4	MPB79	26D	NRP
76344	4-1/2 x 4-1/2	MP79	3	
76360	4-1/2 x 4-1/2	MP79	26	
76364	4-1/2 x 4-1/2	MP79	26D	
76364E	4-1/2 x 4-1/2	MP79	10BE	
76365	4-1/2 x 4-1/2	MP79	26D	NRP

Continued on next page

ASSA ABLOY

QS-7 The global leader in door opening solutions

Berlin, CT Stocking Program

These items are in stock at 225 Episcopal Road, Berlin CT 06037
 Phone 800-346-7707 - Fax 800-541-1073.
 Pick up orders must be placed by noon.

Prices Effective September 1, 2017

SKU	Size	Cat.No.	Finish	Option
Mac Pro Standard Weight Steel Hinges (Continued)				
76368	4-1/2 x 4-1/2	MP79	P	
76369	4-1/2 x 4-1/2	MP79	P	NRP
76384	4-1/2 x 4-1/2	MP79	15	
76312	4-1/2 x 4-1/2	MPB79	3	
76316	4-1/2 x 4-1/2	MPB79	4	
76324	4-1/2 x 4-1/2	MPB79	10B	
76324E	4-1/2 x 4-1/2	MPB79	10BE	
76325	4-1/2 x 4-1/2	MPB79	10B	NRP
76325E	4-1/2 x 4-1/2	MPB79	10BE	NRP
76328	4-1/2 x 4-1/2	MPB79	26	
76332	4-1/2 x 4-1/2	MPB79	26D	
76333	4-1/2 x 4-1/2	MPB79	26D	NRP
76336	4-1/2 x 4-1/2	MPB79	P	
76337	4-1/2 x 4-1/2	MPB79	P	NRP
76383	4-1/2 x 4-1/2	MPB79	15	

SKU	Size	Cat.No.	Finish	Option
Mac Pro Heavy Weight Steel Hinges				
76395	4-1/2 x 4-1/2	MPB68	15	
76374	4-1/2 x 4-1/2	MPB68	26D	
76375	4-1/2 x 4-1/2	MPB68	26D	NRP
76390	5 x 4-1/2	MPB68	26D	

SKU	Size	Cat.No.	Finish	Option
Mac Pro Standard Weight Electric Hinges				
76402	4-1/2 x 4	MPB79	26D	CC8
76404	4-1/2 x 4	MPB79	26D	QC12
76405	4-1/2 x 4-1/2	MPB79	26D	CC4
76407	4-1/2 x 4-1/2	MPB79	26D	CC8
76409	4-1/2 x 4-1/2	MPB79	26D	QC12

SKU	Size	Cat.No.	Finish	Option
Mac Pro Heavy Weight Electric Hinges				
76412	4-1/2 x 4-1/2	MPB68	26D	CC8
76414	4-1/2 x 4-1/2	MPB68	26D	QC12

SKU	Size	Cat.No.	Finish	Option
Mac Pro Spring Hinges				
76388	4-1/2 x 4	MPS60	15	
76378	4-1/2 x 4-1/2	MPS60	26D	
76379	4-1/2 x 4-1/2	MPS679	26D	
76380	4-1/2 x 4-1/2	MPS60	P	
76385	4-1/2 x 4-1/2	MPS60	15	

SKU	Size	Cat.No.	Finish	Option
Miscellaneous				
63293	CSS-9 5 7/8 Offset	26D		
63313	CSS-9 5-7/8 Center Hung	26D		
63330	CSS-9 5 3/4 Center Hung	26D		
63331	CSS-9 6 3/4 Center Hung	26D		
63332	CSS-9 5 3/4 Offset Hung	26D		
63345	DS-6	26D		
63346	EP-5J	26D		
63539	PH-4	26D		
73002	FS-86 Sample Case			

SKU	Size	Cat.No.	Finish	Option
Steel Raised Barrel Standard Weight Hinges				
55957	4-1/2 x 4-1/2	RBTB2714	26D	

SKU	Size	Cat.No.	Finish	Option
Steel Raised Barrel Heavy Weight Hinges				
58436	4-1/2 x 4-1/2	RBT4B3786	26D	

SKU	Size	Cat.No.	Finish	Option
Specialty Hinges (Interim Hinges)				
57470	Interim 5 x 4-1/2	TA2714	26D	
57475	Interim 5 x 4-1/2	T4A3386	32D	
57480	Interim 5 x 4-1/2	T4A3786	26D	

SKU	Size	Cat.No.	Finish	Option
Wire Harness Transfer Devices				
93970	QC-C2500p 25' Ft. 12 Wire 22AWG			
93971	QC-C3000p 30' Ft. 12 Wire 22AWG			
93978	QC-RM4 Male Plug (4CKT)			
93979	QC-RM8 Male Plug (8CKT)			
93980	QC-MT2024 Male Terminal (AWG 20-24)			
93981	QC-C003-12 Wire 22AWG 3 In.			
93982	QC-C006 12 Wire 22AWG 6 Inch			
93983	QC-C012 12 Wire 22AWG 12 Inch			
93984	QC-C200 12 Wire 22AWG 26 Inch			
93985	QC-C206 12 Wire 22AWG 32 Inch			
93986	QC-C300 12 Wire 22AWG 38 Inch			
93987	QC-C306 12 Wire 22AWG 44 Inch			

SKU	Size	Cat.No.	Finish	Option
Wire Harness Transfer Devices				
93988	QC-C400 12 Wire 22AWG 50 Inch			
93989	QC-C1500 12 Wire 22AWG 15 Ft,2 In.			
93990	QC-C003p 12 Wire AWG 3 Inch			

SKU	Size	Cat.No.	Finish	Option
93991	QC-C006p 12 Wire AWG 6 Inch			
93992	QC-C012p 12 Wire 22AWG 12 Inch			
93993	QC-C200p 12 Wire 22AWG 26 Inch			
93994	QC-C206p 12 Wire 22AWG 32 Inch			
93995	QC-C300p 12 Wire 22AWG 38 Inch			
93996	QC-C306p 12 Wire 22AWG 44 Inch			
93997	QC-C400p 12 Wire 22AWG 50 Inch			
93998	QC-C1500p 12 Wire 22AWG 15 Ft,2 In.			
94002	MCK-TSB-C Door Cord 18 Inch			
94003	MCK-TSB-C X L Door Cord 36 Inch			
94004	MCK-EPT			
94005	MCK-EPTL			
94006	MCK EL-EPT-12			
94007	MCK EL-EPTL-12			
94016	PoE-Mt2024 Male Terminal(AWG 20-24)			
94017	PoE-RM6 Male Plug (6 CKT)			
94018	PoE-RF6 Female Plug (6 CKT)			
94019	PoE-MT2630 Male Terminal(AWG 26-30)			
94020	PoE-FT2630 Female Termin (AWG 26-30)			
94021	PoE-C700p 84 Inch Door Harness Assy			
94022	PoE-C206p 30 Inch Door Harness Assy			
94023	PoE-Cept30 30 Ft Door Harness Assy.			
94026	QC-Rf4 Female Recep. (4ckt) Per C			
94027	QC-Rf8 Female Recep (8ckt) Per C			
94028	QC-RM2 Male Plug (2CKT) Per C			
94029	QC-FT2024 Female Term (AWG 20-24)			
94030	QC-FT2630 Female Term (AWG 26-30)			
94031	QC-MT2630 Male Terminal (AWG 26-30)			
94034	QC-R001 Mole X Repair Service Kit			
94035	QC-R002 E X Traction Tool			
94036	QC-R003 Mole X Hand Crimp Tool			
94037	QC-RF2 Female Recep. (2ckt) Per C			
94038	PoE-C300p 36 Inch Door Harness Assy			
94039	PoE-C306p 42 Inch Door Harness Assy			
94040	PoE-C400p 48 Inch Door Harness Assy			
94041	PoE-C406p 54 Inch Door Harness Assy			
94042	PoE-C500p 60 Inch Door Harness Assy			
94043	PoE-C1300p 156 In Door Harness Assy			
94044	PoE-C1500p 180 Inch Frame Harness			

SKU	Size	Cat.No.	Finish	Option
Non-Ferrous Standard Weight Swing Clear Hinges				
73585	5	TA2395	32D	
73584	5	TA4395	32D	

SKU	Size	Cat.No.	Finish	Option
Steel Standard Weight Swing Clear Hinges				
57006	4-1/2	TA2895	26D	
57011	4-1/2	TA2895	26	
57041	4-1/2	TA4895	26D	
57045	4-1/2	TA4895	26	
57030	5	TA2895	26D	
57049	5	TA4895	26D	

SKU	Size	Cat.No.	Finish	Option
Steel Heavy Weight Swing Clear Hinges				
75476	4-1/2	TA795	26D	
75381	5	TA795	26D	
73454	4-1/2	HT4A3795	26D	
73461	4-1/2	T4A3795	4	
73463	4-1/2	T4A3795	26D	
73449	4-1/2	T4A4795	26	
73451	4-1/2	T4A4795	26D	
73452	4-1/2	HT4A4795	26D	
73589	5	HT4A4795	26D	
73590	5	T4A4795	26D	
73482	5	T4A3795	26D	
73486	5	HT4A3795	26D	
73522	5	T4A3796	26D	

SKU	Size	Cat.No.	Finish	Option
Non-Ferrous Heavy Weight Swing Clear Hinges				
55195	4-1/2	T4A3395	32D	
55196	5	T4A3395	32D	
73441	4-1/2	T4A3395	32D	

SKU	Size	Cat.No.	Finish	Option
Back Plates For Half Surface Hinges				
63240	4-1/2	BP-10	26D	

SKU	Size	Cat.No.	Finish	Option
Steel Half Surface Standard Weight Hinges				
74466	4-1/2	TA772	26D	
57717	4-1/2	TA2772	26D	
57710	4-1/2	TA2772	P	
57833	5	TA2772	26D	

800-346-7707 | www.mckinneyhinge.com
 Check the web site for the up-to-date catalog

McKinney is a brand associated with Corbin Russwin, Inc., an ASSA ABLOY Group company. Copyright © 2012-2017, Corbin Russwin, Inc. All rights reserved. Reproduction in whole or in part without the express written permission of Corbin Russwin, Inc. is prohibited.

ASSA ABLOY

The global leader in door opening solutions

SKU	Size	Cat.No.	Finish	Option
Steel Half Surface Heavy Weight Hinges				
58181	6	T4A3782	26D	1-3/4 DR
72339	6	T4A3782	26D	2-1/4 DR
Non-Ferrous Half Surface Heavy Weight Hinges				
61563	4-1/2	T4A3382	32D	
58107	4-1/2	T4A3782	26D	
Steel Full Surface Standard Weight Hinges				
57533	4-1/2	TA2771	26D	
Steel Half Mortise Standard Weight Hinges				
57880	4-1/2	TA2774	P	
57884	4-1/2	TA2774	26D	
NON-FERROUS				
Full Mortise Standard Weight Three Knuckle				
56402	4-1/2 x 4	TA314	32D	NRP
69353	4-1/2 x 4	TA314	32D	
69356	4-1/2 x 4-1/2	TA314	32D	NRP
69362	4-1/2 x 4-1/2	TA314	10B	
69368	4-1/2 x 4-1/2	TA314	32D	
69383	5 x 4-1/2	TA314	32D	
73881	5 x 4	TA314	32D	
Full Mortise Standard Five Knuckle				
58845	3-1/2 x 3-1/2	T2314	32D	
58964	4-1/2 x 4-1/2	T2314	32D	
58972	4-1/2 x 4-1/2	T2314	10B	
59646	4 x 4	T2314	10B	
59661	4 x 4	T2314	32D	
59678	4 x 4	TA2314	32D	
59680	4 x 4	TA2314	10B	
59746	4-1/2 x 4	TA2314	10B	
59752	4-1/2 x 4	TA2314	32D	
59755	4-1/2 x 4	TA2314	26D	NRP
59756	4-1/2 x 4	TA2314	32D	NRP
59822	4-1/2 x 4-1/2	TA2314	4	
59823	4-1/2 x 4-1/2	TA2314	32	
59826	4-1/2 x 4-1/2	TA2314	3	
59828	4-1/2 x 4-1/2	TA2314	10	
59832	4-1/2 x 4-1/2	TA2314	26D	
59837	4-1/2 x 4-1/2	TA2314	26D	NRP
59838	4-1/2 x 4-1/2	TA2314	32D	
59838C	4-1/2 x 4-1/2	TA2314	32D	CPC
59838E	4-1/2 x 4-1/2	TA2314	10BE	(SS)
59838S	4-1/2 x 4-1/2	TA2314	10B	(SS)
59839	4-1/2 x 4-1/2	TA2314	10B	
59840	4-1/2 x 4-1/2	TA2314	32D	NRP
59847	4-1/2 x 4-1/2	TA2314	32D	NRP SSF
59904	5 x 4-1/2	TA2314	32D	
59906	5 x 4-1/2	TA2314	10B	
59910	5 x 4-1/2	TA2314	32D	NRP
59984	5 x 5	TA2314	32D	
76001	4-1/2 x 4-1/2	TA2314	10B	NRP
Mac Pro Standard Weight Non-Ferrous Hinges				
76340	4-1/2 x 4-1/2	MPB91	32D	
76341	4-1/2 x 4-1/2	MPB91	32D	NRP
Full Mortise Heavy Weight Three Knuckle				
69396	4-1/2 x 4	TA386	32D	NRP
69407	4-1/2 x 4-1/2	TA386	10B	
69413	4-1/2 x 4-1/2	TA386	32D	
69415	4-1/2 x 4-1/2	TA386	32D	NRP
74956	5 x 4-1/2	TA386	32D	NRP
Full Mortise Heavy Weight Five Knuckle				
58437	5 x 4	T4A3386	32D	
61772	4-1/2 x 4	T4A3386	32D	NRP
61779	4-1/2 x 4	T4A3386	32D	
61780	4-1/2 x 4-1/2	T4A3386	32D	NRP SSF
61787	4-1/2 x 4-1/2	T4A3386	32D	
61790	4-1/2 x 4-1/2	T4A3386	4	
61791	4-1/2 x 4-1/2	T4A3386	32	
61794	4-1/2 x 4-1/2	T4A3386	3	
61795	4-1/2 x 4-1/2	T4A3386	10B	
61795E	4-1/2 x 4-1/2	T4A3386	10BE	(SS)
61795S	4-1/2 x 4-1/2	T4A3386	10B	(SS)
61796	4-1/2 x 4-1/2	T4A3386	10	
61810	4-1/2 x 4-1/2	T4A3386	P	NRP
61812	4-1/2 x 4-1/2	T4A3386	26D	NRP

SKU	Size	Cat.No.	Finish	Option
61813	4-1/2 x 4-1/2	T4A3386	10	NRP
61814	4-1/2 x 4-1/2	T4A3386	32D	NRP
61815	4-1/2 x 4-1/2	T4A3386	10B	NRP
61849	4-1/2 x 4-1/2	T4B3386	32D	NRP
61861	5 x 4-1/2	T4A3386	10B	NRP
61862	5 x 4-1/2	T4A3386	10	
61868	5 x 4-1/2	T4A3386	32D	
61871	5 x 4-1/2	T4A3386	32D	NRP
61873	5 x 4-1/2	T4A3386	10B	
61928	5 x 5	T4A3386	32D	
61946	5 x 5	T4A3386	32D	NRP
68822	6 x 5	T4A3386	32D	NRP
Mac Pro Heavy Weight Non-Ferrous Hinges				
76376	4-1/2 x 4-1/2	MPB99	32D	
76377	4-1/2 x 4-1/2	MPB99	32D	NRP
76392	5 x 4-1/2	MPB99	32D	
76393	5 x 4-1/2	MPB99	32D	NRP
Three Knuckle Standard Weight Hospital Tip Hinges				
69489	4-1/2 x 4	HTA314	32D	
69363	4-1/2 x 4-1/2	HTA314	32D	
Five Knuckle Standard Weight Hospital Tip Hinges				
59807	4-1/2 x 4	HTA2314	32D	
59808	4-1/2 x 4-1/2	HTA2314	32D	
Three Knuckle Heavy Weight Hospital Tip Hinges				
69446	4-1/2 x 4	HTA386	32D	
81306	4-1/2 x 4-1/2	HTA386	32D	
81535	4-1/2 x 4-1/2	HTB386	32D	W/PSF
74942	5 x 4	HTA386	32D	
Five Knuckle Heavy Weight Hospital Tip Hinges				
61773	4-1/2 x 4	HT4A3386	32D	
61820	4-1/2 x 4-1/2	HT4A3386	32D	
61860H	5 x 4	HT4A3386	32D	
61868H	5 x 4-1/2	HT4A3386	32D	
Stainless Steel Spring Hinges				
156056	4-1/2 x 4	1552	32D	
156080	4-1/2 x 4-1/2	1552	32D	
Anchor Sets				
75500	5 x 4-1/2	TA392	32D	RH
75501	5 x 4-1/2	TA392	32D	LH
75544	5 x 4-1/2	TA5392	32D	RH
75545	5 x 4-1/2	TA5392	32D	LH
75581	5 x 4-1/2	TA393	32D	RH
75582	5 x 4-1/2	TA393	32D	LH
Specialty Hinges (Square Barrel Hinges)				
75742	4-1/2 x 4-1/2	SQ3331 LH	15	
75743	4-1/2 x 4-1/2	SQ3331 RH	15	
75744	4-1/2 x 4-1/2	SQ3331 LH	26D	
75745	4-1/2 x 4-1/2	SQ3331 RH	26D	
75840	4-1/2 x 4-1/2	SQ3331 LH	3	
75841	4-1/2 x 4-1/2	SQ3331 RH	3	
75843	4-1/2 x 4-1/2	SQ3331 RH	10B	
75844	4-1/2 x 4-1/2	SQ3331 LH	14	
75845	4-1/2 x 4-1/2	SQ3331 RH	14	
75846	4-1/2 x 4-1/2	SQ3331 LH	26	
75847	4-1/2 x 4-1/2	SQ3331 RH	26	
Specialty Hinges (Olive Knuckle Hinges)				
76200	6	TA3383	15	LH
76201	6	TA3383	15	RH
76202	6	TA3383	26D	LH
76203	6	TA3383	26D	RH
76204	6	TA3383	3	LH
76205	6	TA3383	3	RH
76206	6	TA3383	10B	LH
76207	6	TA3383	10B	RH
76208	6	TA3383	14	LH
76209	6	TA3383	14	RH
76210	6	TA3383	26	LH
76211	6	TA3383	26	RH

ASSA ABLOY

The global leader in door opening solutions

McKinney

Screw Packs – Sales Code: 15, Stock Pol: O

Part#	Description	Inv Type	Price
MK22590P	1 1/2 X 12 PHWS 26D SOLID	FG	\$0.40
MK22594	1 1/2 X 12 PHWS SOL 10 PER C	MS	\$0.40
MK22581	1 1/2 X 12 PHWS SOL 10B	MS	\$0.40
MK22590	1 1/2 X 12 PHWS SOL 26D	MS	\$0.40
MK22597	1 1/2 X 12 PHWS SOL PC	MS	\$0.40
MK22484	1 1/4 X 12 PHWS 10B SOL PER C	MS	\$0.40
MK22480P	1 1/4 X 12 PHWS 26 SOLID	FG	\$0.40
MK22481P	1 1/4 X 12 PHWS 26D SOLID	FG	\$0.40
MK22483	1 1/4 X 12 PHWS SOL 10 PER C	MS	\$0.40
MK22480	1 1/4 X 12 PHWS SOL 26 PER C	MS	\$0.40
MK22470	1 1/4 X 12 PHWS SOL 3	MS	\$0.40
MK22487	1 1/4 X 12 PHWS SOL AP	FG	\$0.40
MK22475	1 1/4 X 12 PHWS SOL PC	MS	\$0.40
MK22390	1 1/4 X 12 FL PH SS WS 32D	MS	\$0.40
MK22476	1 1/4X12 PHWS SOL 4 PER C	MS	\$0.40
MK22449	1 X 10 FH PHWS SOLID P	MS	\$0.40
MK22450	1 X 10 FHPHWS SOLID 26	MS	\$0.40
MK22452	1 X 10 FHPHWS SOLID 26D	MS	\$0.40
MK22451	1 X 10 FHPHWS SOLID 32D	MS	\$0.40
MK21369	1 X 10 PHWS 10B SOLID	MS	\$0.40
MK22682	1/2 X 10 24PHMS SOL 10 PER C	FG	\$0.30
MK22371	1/2 X 12 24PHMS 32D PER C	MS	\$0.30
MK22709	1/2 X 12 24PHMS SOL 10 PER C	MS	\$0.30
MK22706	1/2 X 12 24PHMS SOL 26 PER C	MS	\$0.30
MK22706P	1/2 X 12-24 PHMS 26 SOLID	FG	\$0.30
MK22707P	1/2 X 12-24 PHMS 26D SOLID	FG	\$0.30
MK22710	1/2 X 12-24 PHMS SOL 10B	MS	\$0.30
MK22703	1/2 X 12-24 PHMS SOL 3	MS	\$0.30
MK22702	1/2 X 12-24 PHMS SOL 4	MS	\$0.30
MK22714	1/2 X 12-24 PHMS SOL AP	FG	\$0.30
MK22701	1/2 X 12-24 PHMS SOL PC	MS	\$0.30
MK22707	1/2 X 12 24PHMS BR 26D PER C	MS	\$0.30
MK21988P	1 1/2 X 12 PHWS 26D	FG	\$0.20
MK21989	1 1/2 X 12 PHWS STEEL 10 PER C	MS	\$0.20
MK21678	1 1/2 X 12 PHWS STEEL P PER C	MS	\$0.20
MK21988	1 1/2 X 12 PHWS STL 26D PER C	MS	\$0.20
MK21994	1 1/2X 12 PHWS 10B STL	MS	\$0.20
MK21412	1 1/4 X 10 PHWS STL 10 PER C	FG	\$0.20
MK21473	1 1/4 X 12 PHWS 10B STL PER C	MS	\$0.20
MK21469P	1 1/4 X 12 PHWS 26	FG	\$0.20
MK21475	1 1/4 X 12 PHWS 2C STL	MS	\$0.20
MK21466P	1 1/4 X 12 PHWS 3	MS	\$0.20
MK21465P	1 1/4 X 12 PHWS 4	MS	\$0.20
MK22481	1 1/4 X 12 PHWS BR 26D PER C	MS	\$0.20
MK21660	1 1/4 X 12 PHWS D3 STL	MS	\$0.20
MK21659	1 1/4 X 12 PHWS D4 STL	MS	\$0.20
MK21464P	1 1/4 X 12 PHWS P	FG	\$0.20
MK21469	1 1/4 X 12 PHWS STEEL 26 PER C	MS	\$0.20
MK22009	1 1/4 X 12 PHWS STL 10A	MS	\$0.20
MK21470	1 1/4 X 12 PHWS STL 26D PER C	MS	\$0.20
MK21466	1 1/4 X 12 PHWS STL 3 PER C	MS	\$0.20
MK21478	1 1/4 X 12 PHWS STL AP PER C	MS	\$0.20
MK21680	1 1/4 X 12 PHWS STL D2	MS	\$0.20
MK21405	1 1/4X10 0 PHWS STL 4 PER C	MS	\$0.20
MK21410	1 1/4X10 0PHWS STL 26D PER C	FG	\$0.20
MK21472	1 1/4X12 PHWS STL 10 PER C	MS	\$0.20
MK21465	1 1/4X12 PHWS STL 4	MS	\$0.20
MK21363	1 X 10 PHWS 10B STL PER C	MS	\$0.20
MK21359P	1 X 10 PHWS 26	FG	\$0.20
MK21360P	1 X 10 PHWS 26D	FG	\$0.20
MK21365	1 X 10 PHWS 2C STL	MS	\$0.20
MK21359ZB	1 X 10 PHWS 2C-BRIGHT	FG	\$0.20

Part#	Description	Inv Type	Price
MK21354	1 X 10 PHWS P.STL PER C	MS	\$0.20
MK21362	1 X 10 PHWS STEEL 10 PER C	MS	\$0.20
MK21355	1 X 10 PHWS STEEL 4 PER C	MS	\$0.20
MK21368	1 X 10 PHWS STEEL AP PER C	MS	\$0.20
MK22008	1 X 10 PHWS STL 10A	MS	\$0.20
MK21359	1 X 10 PHWS STL 26 PER C	MS	\$0.20
MK21360	1 X 10 PHWS STL 26D PER C	MS	\$0.20
MK21356	1 X 10 PHWS STL 3 PER C	MS	\$0.20
MK22010	1 X 10 PHWS STL D1	FG	\$0.20
MK22011	1 X 10 PHWS STL D2	MS	\$0.20
MK22012	1 X 10 PHWS STL D3	MS	\$0.20
MK22013	1 X 10 PHWS STL D4	MS	\$0.20
MK21328	1 X 9 PHWS STEEL 10 PER C	FG	\$0.20
MK21321	1 X 9 PHWS STEEL 4 PER C	FG	\$0.20
MK22007	3/4X6 PHWS STEEL 10 PER C	FG	\$0.20
MK21728	1/2 X 10 24PHMS STEEL 4 PER C	MS	\$0.15
MK21741	1/2 X 10 24PHMS STEEL AP PER C	MS	\$0.15
MK21727	1/2 X 10 24PHMS STEEL P PER C	MS	\$0.15
MK21736	1/2 X 10 24PHMS STL 10B PER C	MS	\$0.15
MK21729	1/2 X 10 24PHMS STL 3 PER C	MS	\$0.15
MK21732P	1/2 X 10-24 PHMS 26	FG	\$0.15
MK21732	1/2 X 10-24 PHMS 26 STL	MS	\$0.15
MK21733P	1/2 X 10-24 PHMS 26D	MS	\$0.15
MK21738	1/2 X 10-24 PHMS 2C STL	MS	\$0.15
MK22380	1/2 X 10-24 PHMS 32D	MS	\$0.15
MK22122	1/2 X 10-24 PHMS D3 STL	MS	\$0.15
MK22128	1/2 X 10-24 PHMS D4 STL	FG	\$0.15
MK22297	1/2 X 12 24PHMS STEEL 26 PER C	MS	\$0.15
MK22388	1/2 X 12 24PHMS STEEL AP PER C	MS	\$0.15
MK22386	1/2 X 12 24PHMS STEEL P PER C	MS	\$0.15
MK21766	1/2 X 12 24PHMS STL 10B PER C	MS	\$0.15
MK22298	1/2 X 12 24PHMS STL 26D PER C	MS	\$0.15
MK21759	1/2 X 12 24PHMS STL 3 PER C	MS	\$0.15
MK22300P	1/2 X 12-24 PHMS 10	FG	\$0.15
MK22017P	1/2 X 12-24 PHMS 10A	FG	\$0.15
MK22017	1/2 X 12-24 PHMS 10A STL	MS	\$0.15
MK21766P	1/2 X 12-24 PHMS 10B	FG	\$0.15
MK22297P	1/2 X 12-24 PHMS 26	FG	\$0.15
MK21768	1/2 X 12-24 PHMS 2C STL	MS	\$0.15
MK21759P	1/2 X 12-24 PHMS 3	MS	\$0.15
MK21968	1/2 X 12-24 PHMS D4 STL	MS	\$0.15
MK21758	1/2 X 12-24PHMS STL 4	MS	\$0.15
MK22207	12 X 1 1/2 FL TX SS WS 32D	MS	\$0.60
MK22208	12 X 1 1/4 FL TX SS WS 32D	MS	\$0.60
MK22209	STS TORX BAGS 1/2X12-24		\$0.74
MK22200	1/4-20 X 5/8 FL TX SS MSCR	FG	\$0.75
MK22203	1/4-20 X1/2 FL TX ST MS 26D	MS	\$0.75
MK22196	1/4-20 X 1/2 FL TX ST MS P	FG	\$0.75
MK22197	12 X 1 1/2 FL TX ST WS 26D	MS	\$0.47
MK22190	12 X 1 1/2 FL TX ST WS P	MS	\$0.47
MK22198	12 X 1 1/4 FL TX ST WS 26D	MS	\$0.47
MK22191	12 X 1 1/4 FL TX ST WS P	FG	\$0.47
MK22192	12 X 24 X 1/2 FL TX ST MS P	MS	\$0.47
MK22199	12-24 X 1/2 FL TX ST MS 26D	MS	\$0.47
MK22129	14X1 1/2 FL,PH,ST,STCR,10B	MS	\$0.50
MK22708	8-32X1/2 TORX SC FOR CSS-9	MS	\$0.75
MK21825	2 X 1/4-20 O.H.P.H.M.S. 10 STL	MS	\$0.75
MK21826	2 X 1/4-20 O.H.P.H.M.S. 10B ST	MS	\$0.75
MK21823	2 X 1/4-20 O.H.P.H.M.S. 26D ST	MS	\$0.75
MK21831	2 X 1/4-20 O.H.P.H.M.S. AP STL	MS	\$0.75
MK21817	2 X 1/4-20 O.H.P.H.M.S. PC STL	MS	\$0.75
MK21823P	2 X 1/4-20 OHPHMS 26D	FG	\$0.75

800-346-7707 | www.mckinneyhinge.com

Check the web site for the up-to-date catalog

McKinney is a brand associated with Corbin Russwin, Inc., an ASSA ABLOY Group company. Copyright © 2012-2017, Corbin Russwin, Inc. All rights reserved. Reproduction in whole or in part without the express written permission of Corbin Russwin, Inc. is prohibited.

ASSA ABLOY

The global leader in door opening solutions

McKinney

Complete Screw Packs – Sales Code: 15, For Full Moritse Hinges, SS = Stainless, STL = Steel

Part#	Description	Inv Type	Price	Part#	Description	Inv Type	Price
MK07755	4 1/2 SS USP SCREW PACK	PR	\$4.80	MK07766	4 1/2 STL D3 SCREW PACK	PR	\$4.80
MK07756	4 1/2 STL 10B SCREW PACK	PR	\$6.40	MK07767	4 1/2 STL D4 SCREW PACK	PR	\$4.80
MK07757	4 1/2 STL 10 SCREW PACK	PR	\$4.80	MK07768	4 1/2 STL TA2772 26D SCREW PACK	PR	\$6.00
MK07758	4 1/2 SS 10B SCREW PACK	PR	\$6.40	MK07769	4 1/2 SS US3 SCREW PACK	PR	\$6.40
MK07759	4 1/2 STL USP SCREW PACK	PR	\$4.80	MK07770	4 1/2 SS US4 SCREW PACK	PR	\$4.80
MK07760	4 1/2 STL 26D SCREW PACK	PR	\$4.80	MK07771	4 1/2 SS 10 SCREW PACK	PR	\$4.80
MK07761	4 1/2 STL 10BE SCREW PACK	PR	\$4.80	MK07772	4 1/2 SS 26 SCREW PACK	PR	\$6.40
MK07762	4 1/2 STL US3 SCREW PACK	PR	\$6.40	MK07773	4 1/2 SS D3 SCREW PACK	PR	\$4.80
MK07763	4 1/2 STL US4 SCREW PACK	PR	\$4.80	MK07774	4 1/2 SS D4 SCREW PACK	PR	\$4.80
MK07764	4 1/2 STL 15 SCREW PACK	PR	\$4.80	MK07775	4 1/2 SS 32D SCREW PACK	PR	\$6.40
MK07765	4 1/2 STL 26 SCREW PACK	PR	\$6.40				

Continuous Gear

Screw Packs for 12HD - 14HD - 25HD

– Sales Code: 80X

Part#	Description	Inv Type	Price
MK71502	FMK-CL (FULL MORT SCR PACK)CL	PR	\$17.00
MK71503	FKM-BZ (FULL MORT SCR PACK) BZ	PR	\$17.00

Screw Packs for 22HD - 54HD

– Sales Code: 80X

Part#	Description	Inv Type	Price
MK77350	FSHSK-CL (FS/HS SCREW PACK) CL	PR	\$17.00
MK77351	FSHKS-BZ (FS/ HS SCREW PACK) BZ	PR	\$17.00

Screw Packs for 58HD

– Sales Code: 80X

Part#	Description	Inv Type	Price
MK71502	FMK-CL (FULL MORT SCR PACK)CL	PR	\$17.00
MK71503	FKM-BZ (FULL MORT SCR PACK) BZ	PR	\$17.00

Stainless Pin & Barrel

Standard Screw Packs

– Sales Code: 80X

Part#	Description	Inv Type	Price
KMPSS	Screw Pack for FM300; HG305; HG311; HG315	PR	\$17.00
MS1244SP10SS24	Screw Pack for FM3500; FS3501; FS3502; HG3505	PR	
M91-0003-630	Screw Pack for FS301; FS302; HS303; HM304; HG306	PR	\$17.00

Includes 2 TKS1267SP10SS23; 6 M22-0130-01; 16 TORX-TKS14075R

ASSA ABLOY

The global leader in
SPK-2 door opening solutions

800-346-7707 | www.mckinneyhinge.com

Check the web site for the up-to-date catalog

McKinney is a brand associated with Corbin Russwin, Inc., an ASSA ABLOY Group company. Copyright © 2012-2017, Corbin Russwin, Inc. All rights reserved. Reproduction in whole or in part without the express written permission of Corbin Russwin, Inc. is prohibited.

Notes:

800-346-7707 | www.mckinneyhinge.com
Check the web site for the up-to-date catalog

McKinney is a brand associated with Corbin Russwin, Inc., an ASSA ABLOY Group company. Copyright © 2012-2017, Corbin Russwin, Inc. All rights reserved. Reproduction in whole or in part without the express written permission of Corbin Russwin, Inc. is prohibited.

ASSA ABLOY

The global leader in
door opening solutions

ASSA ABLOY is the global leader in door opening solutions, dedicated to satisfying end-user needs for security, safety and convenience

ASSA ABLOY



225 Episcopal Road
Berlin, CT 06037
Phone: (800) 346-7707 • Fax: (800) 541-1073
www.McKinneyhinge.com

(In Canada)
Door Security Solutions Canada
160 Four Valley Drive
Vaughan, ON L4K 4T9
800-461-3007 • www.assaabloy.ca