

March 2017

To Our Valued Customers:

dormakaba thanks you for the continued opportunity to provide you with quality building access solutions. We appreciate your business and look forward to working with you in 2017.

These Interior Glass Systems Price List #27 and MUTO Price List #27, effective March 6, 2017, contain updated information on products and programs for the coming year. Here are the highlights from the Glass Price List #27:

- New part numbers added for 6" square end caps & 10" square Dri-Fit® rails
- New part numbers added for header and floating header cover with RTS adjustment, 4-1/8"
- Overall pricing remains the same, however there are a handful of pricing adjustments below.

Page	Part Number	Page	Part Number
25, 30	925.033	25, 30	925.533
25, 30	925.034	25, 30	925.733
26, 31	925.028	26, 31	925.528
26	925.240	26	925.920
101, 116, 187, 188	MKD	101, 116	MK2
156	807.118	156	907.900

A PDF version of both the Interior Glass Systems Price List #27 and the MUTO Price List #27 are available on our website.

Remember, one call to our professional Customer Service team provides access to the entire interior glass systems portfolio. Our highly knowledgeable Technical Services team provides fast, accurate product application assistance including part number conversions.

If you have pending projects which were bid under Price List #26, dated March 6, 2017, just indicate PRICE PROTECTION and send your Purchase Order to Customer Service no later than close of business April 5, 2017, with shipment at normal factory lead times.

Please contact your local representative or our Customer Service team at 800-523-8483 if you have any questions. We truly appreciate your choice of dormakaba products and thank you for your business.

Sincerely,

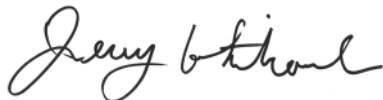

Jerry Whitcomb
Sr. Product Manager, Interior Glass Systems

Glass Systems and Solutions

Pricelist 27
March 6, 2017



Table of Contents

Introduction	Contact Information	iii
	Finish Codes	iv
	Product Shipping Schedule	v
	Warranty Policy	vi
	Terms of Sale	vii
	Application Guide	viii
DRS Rails, Channels and Accessories		1
Patch Fittings and Designer Pivots		37
Offset Hung Patch Fittings		59
Headers and Accessories		65
Closers and Hardware		77
Locksets		95
Pulls and Handles		111
Sliding Systems		127
MANET		159
Panic Hardware		179

Contact Information

dormakaba
DORMA USA, INC.
Dorma Drive, Drawer AC
Reamstown, PA 17567-0411

Office Hours

Monday–Friday
8:00 AM to 6:00 PM EST

Phone

800-523-8483
717-336-3881

Email

dormaglassorders@dorma.com

Email requesting quotes

dormaglassestimates@dorma.com

FAX

888-238-4401



Finish Codes

	dormakaba GMBH Finish #	Ref. dormakaba USA Finish #	BHMA Equivalent	Reference dormakaba Code
Anodized Aluminum Parts				
Mill	100	719	719	ML
Clear	101/150	628	628	CL
Anodized Brass	105	606	606	SB
Similar to Stainless Steel	107/113	107/113	670	SSS
Dark Bronze	108	710	710	DB
Black	109	711	711	BK
Aluminum Color	114	718	718	EV-1
Polished Chrome	122	625	672	ARC
Special Anodized	199	199	—	SA
Brass				
Polished Brass with Lacquer	502	605	605	PBL
Polished Brass without Lacquer	503	—	—	PB
Satin Brass without Lacquer	599	728	728	SB
Satin Nickel (Similar to Satin Stainless)	619	619	619	SN
Steel or Stainless Steel				
Satin Chrome Plated	500	626	626	SC
Polished Chrome Plated	501	625	625	PC
Satin Stainless Steel	700	630	630	SS
Polished Stainless Steel	701	629	629	PS
Bronze				
Satin Bronze without Lacquer	600	612	612	SBZ
Polished Bronze without Lacquer	601	611	611	PBZ
Dark Bronze Oxidized, Oil Rubbed	602	613	613	10B
Special Clad (Plating)				
Special Clad (Plated) Finish	299	299	—	SPL
Painted or Powder Coated				
Primer	314	600	600	PR
Special Paint/Powder	399	999	—	SF
Aluminum	689	689	689	SBZ
Satin Bronze	690	690	690	PBZ
Dark Bronze	691	691	691	10B
Black	693	693	693	BK
Dark Duranodic Bronze	695	695	695	DB
Gold	696	696	696	—
Plastic Parts				
Black	803	693	693	BK
Similar to 101/150 Clear	807	689	—	—
Similar to Satin Stainless	808	—	—	—

List \$

Finish Sample	Item # 925.001 (includes finishes 101, 108, 109, 503, 599, 600, 601, 700, 701)	30
----------------------	--	----

NOTES:

- Custom powder or paint finishes ordered as 399 or 999, non-standard cladding ordered as 299, or non-standard anodizing ordered as 199 must be approved by dormakaba prior to quoting. Not all custom finishes are possible at the published list prices. If a non-standard finish request is approved by dormakaba for processing, a quote will be required.
- dormakaba always reserves the right to refuse any custom finish order.
- Finish # is dormakaba's numerical representation within the part number.
- Please contact factory for special finishes.
- Note that full length finished extrusions may include clamping marks to be cut off in field prior to installation.
- dormakaba finishes are representative of industry recognized BHMA or other finishes. Exact match from dormakaba to a base metal finish, a competitors product, or from lot to lot is never guaranteed.

Product Shipping Schedule

Key	Orders received by 2:00 PM EST	Mon.	Tues.	Wed.	Thurs.	Fri.
①	Non-Fabricated items ship in 1 business day:	Tues.	Wed.	Thurs.	Fri.	*Mon.
③	Standard Fabricated and Non-Standard Fabricated items ship in up to 3 business days:	Thurs.	Fri.	*Mon.	*Tues.	*Wed.
⑤	Custom Fabricated items ship in up to 5 business days:	*Mon.	*Tues.	*Wed.	*Thurs.	*Fri.
⑩	Special Fabricated/Finishes and Special Order items:	up to 5 weeks.				

* Indicates the following week.

NOTE: Above fabrication schedule is based on 10 fabrication items per order. For fabrication orders over 10 per order, please contact Customer Service for a custom schedule.

①	NON-FABRICATED	<ul style="list-style-type: none"> Select Patch Fittings and Accessories; see individual price pages for details. RTS88 and BTS80 Closers and Accessories in limited finishes. Select Handles; see individual price pages for details. (Excludes custom handles.)
③	STANDARD FABRICATED	<ul style="list-style-type: none"> Select DRS Rails and Accessories; see individual price pages for details. (Excludes Mitres.) Select DRS Dri-Fit™ Sidelite rails; see individual price pages for details. (Excludes Mitres.) Select 4-1/8" or 4-1/2" Headers; see individual price pages for details. (Excludes Mitres.) NOTE: All headers are shipped with closers installed unless supplied from select service or requested otherwise. U-Channels and Dri-Fit™ Channels, any length. Select Mechanical Channel components; see individual price pages for details. Select Manual Slider Systems; see individual price pages for details. (Excludes Syncro & DORMOTION.)
③	NON-STANDARD FABRICATED	<ul style="list-style-type: none"> Select 4-1/8" or 4-1/2" Headers fabricated to special lengths (standard 2-3/4" pivot point, standard finishes). NOTE: All headers are shipped with closers installed unless supplied from select service or requested otherwise.
⑤	CUSTOM FABRICATED	<ul style="list-style-type: none"> Miters (DRS Rails, Headers, Dri-Fit™ Sidelites and U-Channel) at any length and any angle. EMSL 2765 Shear Locks installed in DRS Rails and/or Headers (standard or non-standard Fab lengths). Special pivot point preparations, other than 2-3/4" pivot point, DRS Rails and/or Headers). Vertical Stile, Floating Header, Offset Pivot preparation and/or installation.
⑩	SPECIAL FABRICATED/ FINISHES	<ul style="list-style-type: none"> Orders requiring competitor (non-dormakaba) hardware preparation or installation are scheduled on a project basis once all competitor product/templates are received. Allow up to five (5) weeks from that point. HSW/FSW systems see notes below. Special finishes will be scheduled based on required process capacity. Allow up to five (5) weeks. Paint/Powder Coat capacity based on back log; last in last out (LIFO) at time of purchase order. Allow up to five (5) weeks. No returns/no cancellations accepted on special order items.
⑩	SPECIAL ORDER	<ul style="list-style-type: none"> Special finishes will be scheduled based on required process capacity. Allow up to five (5) weeks. Paint/Powder Coat capacity based on back log; last in last out (LIFO) at time of purchase order. Allow up to five (5) weeks. No returns/no cancellations accepted on special order items.

NOTES:

- UPS will ship a maximum of 130 united inches (length + circumference) @ 108" maximum length.
- Accelerated shipping is available at customer expense.
- dormakaba is committed to using the most efficient method of shipping orders unless otherwise specified.
- Orders are not guaranteed to ship same day.
- Additional expenses to dormakaba as a result of special packaging request from customer will be added to the customer invoice and may extend lead time.
- HSW/FSW lead-time quoted at time of order. Lead-times will vary based on complexity of order.

Delivery

Ship dates are contingent upon conditions at time of acknowledgement and can be subject to delays due to strikes and/or other labor issues, material shortages, equipment failure, fire, flood, or other acts of God, or causes beyond our control. DORMA is not liable under any circumstances for consequential damages arising from such delays.

Freight Policy

All goods are shipped F.O.B. Leola, PA. Shipments will be prepaid and charges added to the invoice for customers with accounts and COD for orders under \$1,000.00 net for non-account holders. Freight charges are prepaid and allowed on any one order to one destination (Mainland U.S.A) by carrier of DORMA choice, for orders with net price of \$5,000.00 minimum.

Warranty Policy

All DORMA closers that are BHMA certified to ANSI A156.4 Grade 1 Standard for Door Controls-Closers, except U1500 Series, are covered by a 25-year warranty. This includes BTS Series concealed floor closers, except where noted.

All fire/life safety products that are BHMA certified to ANSI A156.15 Grade 1 Standard for Closer-Holder Release Devices carry a 25-year warranty on the closer mechanism and a 2-year warranty on any electrical or electronic component.

The RTS Series overhead-concealed closers carry a 5-year warranty.

All other products not mentioned above carry a 2-year warranty.

All interior wall systems including HSW, FSW, PURE, PURE Enclose, Prive, and Fusion include a five (5) year warranty from date of substantial completion, exclusive of glass, wood doors, labor, or competitors products or components. All door hardware components within the system such as door handles, electronic locking devices, etc. revert to the original component warranty.

All DORMA products including MUNDUS, Universal, TENSOR, DRS, Headers, MUTO Comfort, RS-120, DRS-120, AGILE 150, MANET, BEYOND, VISUR, and Exit Hardware are covered by a 2-year warranty.

All goods sold are warranted to be free from defects in material and workmanship, the foregoing comprises seller's sole and entire warranty. All other warranties, written or verbal, expressed or implied, and including but not limited to warranties of merchantability or fitness for intended purpose are expressly excluded.

Seller's sole obligation under these warranties, during the period after date of manufacture as listed above, shall be to issue credit, repair or replace any items or part thereof which is proved to be other than as warranted.

Seller shall have the sole right to determine whether such parts shall be repaired or replaced or whether credit shall be issued. No allowance shall be made for any labor charges for replacement of parts, adjustments or repairs, or any other work. In no event shall seller be liable for collateral or consequential damages.

If goods are claimed to be other than as warranted, seller, upon notice promptly given, will either examine the goods at their site or issue shipping instructions for return to seller (transportation costs prepaid by buyer). These warranties shall not extend to any goods or parts thereof which have been subjected to misuse or neglect, damage by accident, rendered defective by reason of improper installation or by the performance of repairs, modifications or attachment to other products outside of seller's plant.

Because DORMA has no control over conditions under which its products are used, DORMA specifically does not warrant the adequacy or sufficiency of any device or recommendations given to buyer. Nor does DORMA warrant that every DORMA product complies with every code, standard or regulation in every community except as specifically stated in a published DORMA catalog or in writing by an officer of the company. Nor is DORMA bound by the terms of buyer's agreements with other parties.

For projects located outside the United States or Canada, the limited warranty period for all products is 1 year from the date of manufacture. DORMA regional businesses located outside the United States or Canada may offer different warranty periods. "United States or Canada" is defined as the several states of the United States, the District of Columbia, the commonwealths, territories and possessions of the United States, and all of the Canadian provinces and territories.

Terms of Sale

Prices

All prices shown are in U.S. Dollars and are subject to change without notice. Prices on acknowledged orders are firm for shipment within three months of order date. All other orders subject to price in effect at time of shipment.

Terms

1% 10 Days, Net 30.

Minimum Order

\$50.00 net minimum invoice.

Orders

We reserve the right to decline the whole or part of orders in which price, finishes, quantity of goods, or credit status of the buyer is not satisfactory to us. We reserve the right to discontinue items or change specifications at any time without notice and without incurring any obligations. DORMA cannot be held liable for extended delivery dates that may result in the cancellation of an order.

Acknowledgments

Acknowledgements are exact copies of the manufacturing order and should be checked upon receipt. If acknowledgement is incorrect, please notify DORMA Customer Service immediately.

Order Cancellations and Changes

For standard product or standard fabricated product (i.e., products that are not custom and not special order) with a defined 1 to 3 day lead time:

- Changes or cancellations will be allowed without penalty within 3 hours of order acknowledgement.
- Changes or cancellations made more than 3 hours after order acknowledgement may incur a fee for recovery of processing costs.
- Charges for changing an order will be based on the status of the order at the time of the change.
- Orders cancelled more than 3 hours after order acknowledgement will incur a 50% minimum restock fee.

For standard product or standard fabricated product (i.e., products that are not custom and not special order) with a defined 5 days or more lead time:

- Changes or cancellations will be allowed without penalty within 24 hours of order receipt.
- Changes or cancellations made more than 24 hours of order receipt may incur a fee for recovery of processing costs.
- Charges for changing an order will be based on the status of the order at the time of the change.
- Orders cancelled more than 24 hours after order receipt will incur a 50% minimum restock fee.

Cancellations for custom or special order products will not be accepted and will be invoiced the full value of the order.

Returned Goods

Goods determined defective within the terms of our warranty may be returned for replacement. Goods returned due to any other factors are subject to a 35% restocking fee. For all returns contact the factory for a "Return of Goods Authorization" number (RGA). All returns must bear the RGA number provided. Unauthorized returns will not be accepted. The complete RGA policy is available upon request. All returns must be shipped to DORMA USA, Inc., Returns Department, 38 Industrial Circle, Lancaster PA, 17601.

To protect our customers from liability, do not sign the delivery receipt until shipment has been inspected thoroughly.

Customer is responsible to make necessary notations on the delivery receipt after inspection. Failure to note damaged items and/or shortages on the receipt releases DORMA from all liability; therefore, customer is responsible for any replacement costs. If damage or shortage is noted, please notify your DORMA customer service representative within 48 hours of receiving your shipment.

Application Guide

Type P Door

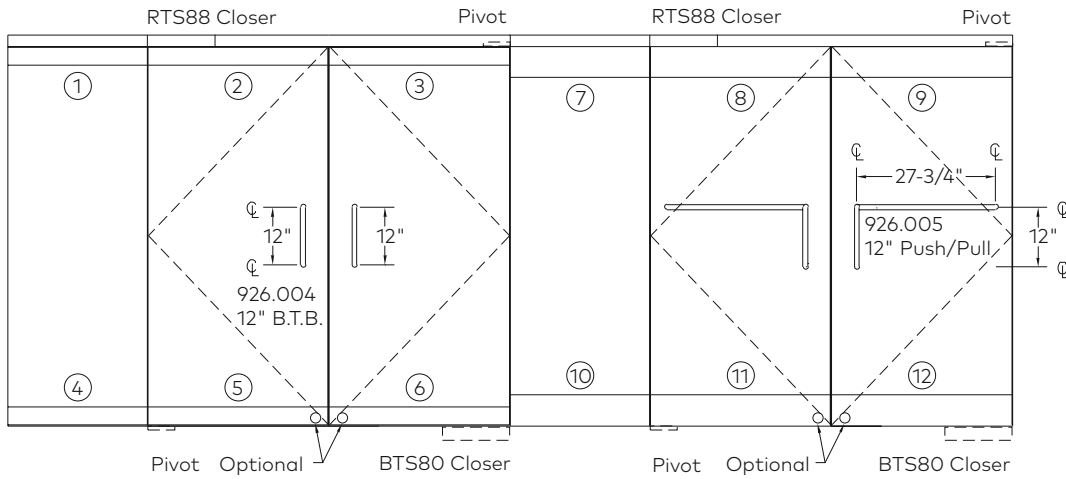

Type BP Door

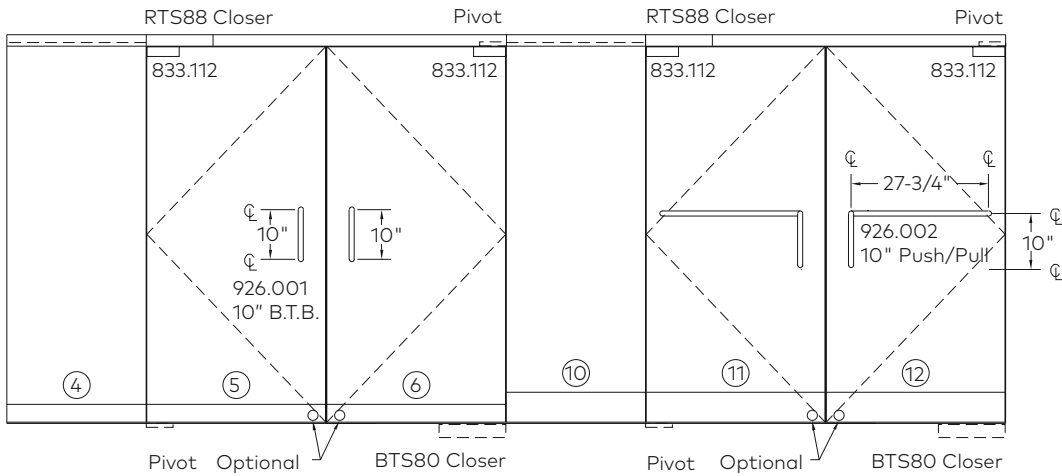

Key

- 1 3-5/8" (92 mm) or 4" (102 mm) DRS Top Dri-Fit® Sidelite Rail (Fixed Panel)
- 2 3-5/8" (92 mm) or 4" (102 mm) DRS Top Rail × 8836 or 8534
- 3 3-5/8" (92 mm) or 4" (102 mm) DRS Top Rail × 355.0 or 355.9
- 4 3-5/8" (92 mm) or 4" (102 mm) DRS Bottom Dri-Fit® Sidelite Rail (Fixed Panel)
- 5 3-5/8" (92 mm) or 4" (102 mm) DRS Bottom Rail × 8852 × with or without Lock
- 6 3-5/8" (92 mm) or 4" (102 mm) DRS Bottom Rail × 355.1 or 7422 with or without Lock
- 7 6" (152 mm) or 10" (254 mm) DRS Top Dri-Fit® Sidelite Rail (Fixed Panel)
- 8 6" (152 mm) or 10" (254 mm) DRS Top Rail × 8836 or 8534
- 9 6" (152 mm) or 10" (254 mm) DRS Top Rail × 355.0 or 355.9
- 10 6" (152 mm) or 10" (254 mm) DRS Bottom Dri-Fit® Sidelite Rail (Fixed Panel)
- 11 6" (152 mm) or 10" (254 mm) DRS Bottom Rail × 8852 × with or without Lock
- 12 6" (152 mm) or 10" (254 mm) DRS Bottom Rail × 355.1 or 7422 × with or without Lock

Type A Door

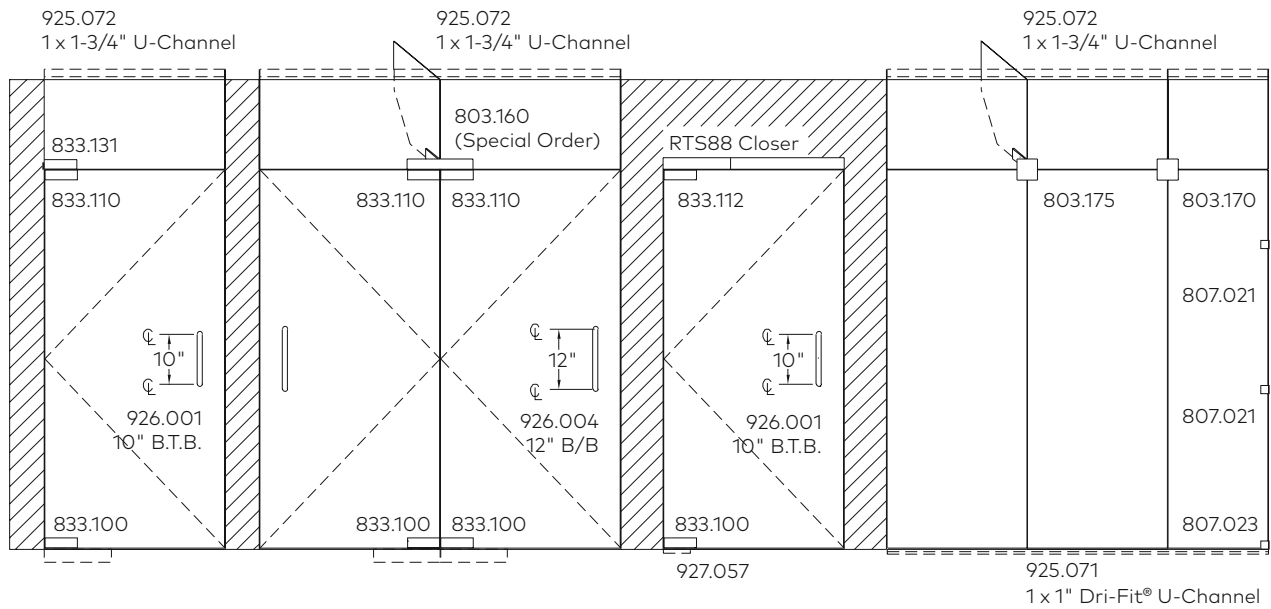
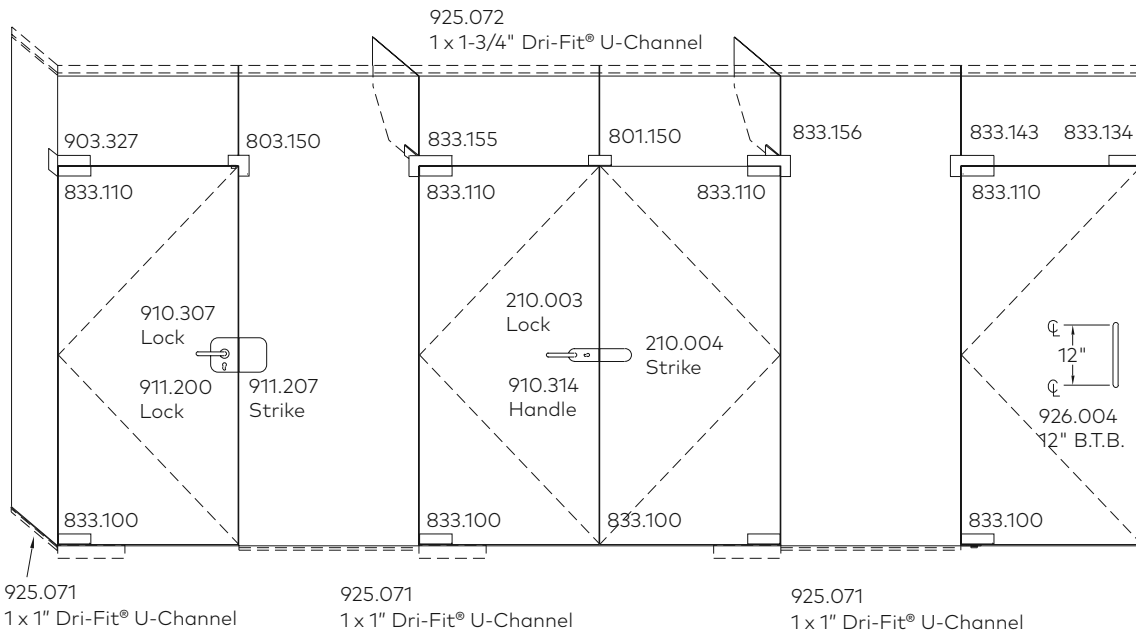

DRS Rails, Channels, and Accessories

	Select Service	2
DRS Rails	Ordering Guides	4
	Top Rails	6
	Bottom Rails	12
	Bottom Rail Locking	17
DRS Accessories and Options	DRS Rails Covers	24
	DRS Rail End Caps	25
	Vertical Stiles	27
	Weather Brush/Weather Seal	27
	DRS Rail Shim	27
DRS Dri-Fit® Sidelite Rails	Saddles and Thresholds	27
	Ordering Guide	28
	Sidelite Rails	29
	Dri-Fit Options and Accessories	30
Glazing and Dri-Fit® U-Channels and Sidelite Accessories	Glazing U-Channel	32
	Dri-Fit Channel for 3/8", 1/2" and 5/8", 3/4" Glass	32
	Dri-Fit Channel for End Cap (Snap Fit)	33
	Dri-Fit Channel Gasket	33
DRS Accessories and Options	DRS Rail Locks	34
	Cylinders	34
	BTS Hardware — Offset Arms and Pivots	34
	RTS88 Hardware — Arms and Pivots	35
	DRS Options	35
	Mechanical Channel and End Cap	36

DRS Rails,
Channels &
AccessoriesPatch Fittings
& Designer
PivotsOffset
Hung Patch
FittingsHeaders &
AccessoriesClosers &
Hardware

Locksets

Pulls &
HandlesSliding
Systems

MANET

Panic
Hardware

Select Service Quick Ship – DRS Rails, Channels, and Accessories

Select service should be used for small quantities of popular dormakaba products that require shipment within 24 hours. The program includes patch fittings, DRS rails, headers, concealed closers and pivots, and pulls and handles. (Customer responsible for shipping costs FOB.)

Subject to Availability

Next Business Day Service (Shipment when Purchase Order is received prior to 4:00 PM EST).

Examples: dormakaba receives P.O. at 3:59 PM on Monday, order will ship by close of business on Tuesday. dormakaba receives P.O. at 3:59 PM on Friday, order will ship by close of business on the following Monday.

Notes:

- Standard freight and discount schedules and terms of sale apply. Please refer to the current price list for full details.
- dormakaba reserves the right to limit quantities or decline an order if the credit status of the buyer is not satisfactory to dormakaba.
- Orders cannot be cancelled.
- Select Service Quick Ship available only in the United States.
- All prices are in U.S. dollars.
- Products and prices are subject to change without notice.
- Limited quantities available.

Key

N	"New" to Select Service, Available in East and West Coast Warehouse
■	Available in East and West Coast Warehouse
E	Available only in East Coast Warehouse
W	Available only in West Coast Warehouse

DRS Rails, Channels, and Accessories

Choose top or bottom rail and rail height from the four options:

1/2" Glass									
Ref. #	Warehouse	Product	Top/Bottom	U/M	Height	Locking	Style	Finish	List \$
33900133	E	DRS Rail	Top	Ea.	2-1/2"	No	SQ	101	336
33900134	E	DRS Rail	Top	Ea.	2-1/2"	No	SQ	108	349
33900135	E	DRS Rail	Top	Ea.	2-1/2"	No	SQ	700	413
33900001	E	DRS Rail	Top	Ea.	3-5/8"	No	SQ	101	218
33900002	E	DRS Rail	Top	Ea.	3-5/8"	No	SQ	700	336
33900004	E	DRS Rail	Top	Ea.	4"	No	SQ	101	218
33900005	E	DRS Rail	Top	Ea.	4"	No	SQ	700	336
33900139	E	DRS Rail	Bottom	Ea.	2-1/2"	No	SQ	101	310
33900144	E	DRS Rail	Bottom	Ea.	2-1/2"	No	SQ	108	323
33900145	E	DRS Rail	Bottom	Ea.	2-1/2"	No	SQ	700	387
33900124	E	DRS Rail	Bottom	Ea.	2-1/2"	Yes	SQ	101	345
33900125	E	DRS Rail	Bottom	Ea.	2-1/2"	Yes	SQ	108	359
33900126	E	DRS Rail	Bottom	Ea.	2-1/2"	Yes	SQ	700	422
33900020	E	DRS Rail	Bottom	Ea.	3-5/8"	No	SQ	101	195
33900021	E	DRS Rail	Bottom	Ea.	3-5/8"	No	SQ	700	312
33900027	E	DRS Rail	Bottom	Ea.	3-5/8"	Yes	SQ	101	195
33900129	E	DRS Rail	Bottom	Ea.	3-5/8"	Yes	SQ	700	312
33900024	E	DRS Rail	Bottom	Ea.	4"	No	SQ	101	195
33900025	E	DRS Rail	Bottom	Ea.	4"	No	SQ	700	312
33900130	E	DRS Rail	Bottom	Ea.	4"	Yes	SQ	101	195
33900132	E	DRS Rail	Bottom	Ea.	4"	Yes	SQ	700	312

NOTE: Top rails include 8836 arm. Bottom rails include 8852 pivot. See page 3 for details.

DRS Top Rails for Center Hung Doors
Choose top or bottom rail and rail height from the four options:

Ref. #	Warehouse	Product	Top/Bottom	Locking	Height	Cover	Style	Glass	Finish	List \$
33900146	☒	DRS Cover	—	No	2-1/2"	COV	SQ	3/8"-9/16"	101	54
33900147	☒	DRS Cover	—	No	2-1/2"	COV	SQ	3/8"-9/16"	108	78
33900148	☒	DRS Cover	—	No	2-1/2"	COV	SQ	3/8"-9/16"	700	138
33900149	☒	DRS Cover	Bottom	Yes	2-1/2"	COV	SQ	3/8"-9/16"	101	59
33900150	☒	DRS Cover	Bottom	Yes	2-1/2"	COV	SQ	3/8"-9/16"	108	86
33900151	☒	DRS Cover	Bottom	Yes	2-1/2"	COV	SQ	3/8"-9/16"	700	152
33900012	☒	DRS Cover	—	—	3-5/8"	COV	SQ	1/2"	101	42
33900014	☒	DRS Cover	—	—	3-5/8"	COV	SQ	1/2"	108	66
33900013	☒	DRS Cover	—	—	3-5/8"	COV	SQ	1/2"	700	114
33900010	☒	DRS Cover	—	—	4"	COV	SQ	1/2"	101	42
33900011	☒	DRS Cover	—	—	4"	COV	SQ	1/2"	700	114
33900152	☒	DRS End Cap	—	—	2-1/2"	End Cap	SQ	1/2"	101	34
33900153	☒	DRS End Cap	—	—	2-1/2"	End Cap	SQ	1/2"	*109	34
33900154	☒	DRS End Cap	—	—	2-1/2"	End Cap	SQ	1/2"	500	68
33900015	☒	DRS End Cap	—	—	3-5/8"	End Cap	SQ	—	101	26
33900017	☒	DRS End Cap	—	—	3-5/8"	End Cap	SQ	—	*109	26
33900016	☒	DRS End Cap	—	—	3-5/8"	End Cap	SQ	—	700	56
33900018	☒	DRS End Cap	—	—	4"	End Cap	SQ	—	101	26
33900019	☒	DRS End Cap	—	—	4"	End Cap	SQ	—	500	56

* 109 finish for all rail end caps, 108 not available
NOTE: 500 finish end caps are used for 700 finish rails.

Ref. #	Warehouse	Product	Description	Finish	List \$
33900155	☒	LCK	Lock, 1-7/8", 5/8" throw	—	32
33900160	☒	CYL	Mortise cylinder for DRS lock, with split ring	108	19
33900156	☒	CYL	Mortise cylinder for DRS lock, with split ring	500	19
33900161	☒	TT	Mortise thumb-turn for DRS lock, with split ring	108	19
33900157	☒	TT	Mortise thumb-turn for DRS lock, with split ring	500	19
33900162	☒	BLNK	Mortise blank (dummy) cylinder for DRS lock, with split ring	108	13
33900158	☒	BLNK	Mortise blank (dummy) cylinder for DRS lock, with split ring	500	13

DRS Top Rails Consist of:

Qty	U/M	HDW
1	Ea.	8836 Arm
1	Ea.	Top Rail
1	Set	Covers
1	Set	End Caps

DRS Bottom Rails Consist of:

1	Ea.	8852 Pivot
1	Ea.	Bottom Rail
1	Set	Covers
1	Set	End Caps
1 (Locking)	Ea.	Brass Lock

DRS Bottom Rails Consist of:

1	Ea.	8852 Pivot
1	Ea.	Bottom Rail
1	Set	Covers
1 (Non-Locking)	Set	End Caps

DRS Rails, Channels & Accessories
 Patch Fittings & Designer Pivots
 Offset Hung Patch Fittings
 Headers & Accessories
 Closers & Hardware
 Locksets
 Pulls & Handles
 Sliding Systems
 MANET
 Panic Hardware

DRS Rails

Ordering Guides

Less Covers Ordered Less Covers or Cladding		Rail Location		Bottom Rail		Top Rail Hardware				
Model		Top & Bottom	TOPBTM	10L	— 10" Bottom Rail w/ Lock	8836	— RTS End Load Arm			
DRS	NO	Bottom	BTM	6L	— 6" Bottom Rail w/ Lock	355.0	— Top Rail Insert (15 mm pin)			
		Top	TOP	4L	— 4" Bottom Rail w/ Lock	355.9	— Top Rail, Side Load, Adjustable Insert (Not Available w/ 2-1/2" Rail)			
				358L	— 3-5/8" Bottom Rail w/ Lock	NONE	— None			
DRS	EC2		TOP	25L	— 2-1/2" Bottom Rail w/ Lock					
			358	10	— 10" Bottom Rail					
				6	— 6" Bottom Rail					
				4	— 4" Bottom Rail					
				358	— 3-5/8" Bottom Rail					
				25	— 2-1/2" Bottom Rail					
DRS		EC1	TOP	358		STK	SQ	8836	8852	continued next page
End Cap for Rail (1 each) —		EC1	2-1/2" Top Rail —	25	Stock 35-3/4" —	STK	SQ — Square Rail		8852	— Bottom Rail Arm for 8852 Floor Pivot
End Cap for Rail (2 each) —		EC2	3-5/8" Top Rail —	358	Custom Length —	SPECIFY	TP — Tapered Rail 1		355.1	— Bottom Rail Insert for BTS (Not Available w/ 2-1/2" Rail)
No End Cap for Rail —		NONE	4" Top Rail —	4		Rail Length	Top Rail Profile		7422	— BTM Rail Arm for BTS/7471K
		End Cap	6" Top Rail —	6					NONE	— None
			10" Top Rail —	10						
										Bottom Rail Hardware

Glass Thickness

9/16	— 9/16" Tempered Laminated Glass
11/16	— 11/16" Tempered Laminated Glass
1/2	— 1/2" Glass
3/8	— 3/8" Glass
5/8	— 5/8" Glass ²
3/4	— 3/4" Glass ²

Bottom Rail Lock

NONE	— None
PANIC	— DG1000/DG1300 Prep
BRASSLK125	— Brass Lock for 2-1/2" Rail
BRASSLK178	— Brass Lock Vertical Stiles
BRASSLK1916	— Brass Lock None

Vertical Stiles

VERTPACK
NONE

Custom Preps

HDWPREP	— Custom Prep/Install of DORMA Hardware
CMP HDWP	— Competitor Hardware Prep
CMP HDW1	— Competitor Hardware Prep/Install
CMP SHEAR	— Competitor Electromagnetic Shear Lock or Magnetic Lock Armature Prep
NO	

1/2	NONE	NONE	NONE	101	NONE	NO
------------	-------------	-------------	-------------	------------	-------------	-----------

Magnetic Shear Lock —	2765
DG1000/DG1300 Prep —	PANIC
None —	NONE

Top Rail Lock

Thumb Turn × Thumb Turn —	TTXTT
Thumb Turn × Blank —	TTXBLNK
Cylinder × Thumb Turn —	CYLXTT
Cylinder × Blank —	CYLXBLNK
None —	NONE

Cylinder for Brass Lock

101	— Clear Anodized (CL)
108	— Dark Bronze (DB)
109	— Black Anodized (BK)
503	— Polished Brass w/o Lacquer (PB)
599	— Satin Brass w/o Lacquer (SB)
600	— Satin Bronze w/o Lacquer (SBZ)
601	— Polished Bronze w/o Lacquer (PB2)
700	— Satin Stainless Steel (SS/US32D)
701	— Polished Stainless Steel (PS/US32)

Standard Finish

999	— Powder Coated Finishes (Specify)
CCLAD	— Custom Cladding (Specify)

Finish Custom ^{3,4}

- 1 Tapered Rail (TP) available only with 2-1/2", 3-5/8", and 4" rails.
- 2 5/8" and 3/4" glass (Not available with 4" high rail).
- 3 dormakaba reserves the right to refuse Custom Finishes.
- 4 All Custom Finishes require customer sign-off/approval of color chip.

- DRS Rails, Channels & Accessories
- Patch Fittings & Designer Pivots
- Offset Hung Patch Fittings
- Headers & Accessories
- Closers & Hardware
- Locksets
- Pulls & Handles
- Sliding Systems
- MANET
- Panic Hardware

DRS Top Rails, Type P, Finished Door Size 24" to 50"

Default 1/2" (12 mm) unless otherwise specified

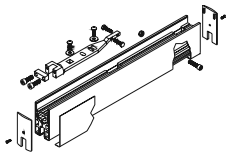

Square (SQ) DRS Top Rail —
8836 (928.006) Arm

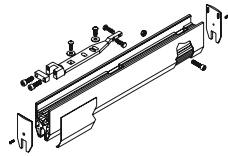

Tapered (TP) DRS Top Rail —
8836 (928.006) Arm

				Standard Finishes \$					Custom Finishes \$	
DRS Top Rail Square (SQ) or Tapered (TP) with 8836 (928.006) Arm				101	108/109	503/599	600/601	700/701	999	Cladding
Profile	Ref. #	U/M	Glass Thickness	3	3	SO	SO	3	SO	SO
(25) 2-1/2" Rail Height										
SQ	234.061	Ea.	3/8"	336	349	506	591	413	600	684
SQ	234.011	Ea.	1/2"	336	349	506	591	413	600	684
SQ	234.091	Ea.	5/8"	376	391	567	661	462	671	767
SQ	234.204	Ea.	3/4"	376	391	567	661	462	671	767
SQ	234.122	Ea.	9/16"	424	437	594	679	501	688	772
SQ	234.125	Ea.	11/16"	464	479	655	749	550	759	855
SQ	234.300	Ea.	13/16"	464	479	655	749	550	759	855
TP	234.064	Ea.	3/8"	336	349	506	591	413	600	684
TP	234.014	Ea.	1/2"	336	349	506	591	413	600	684
TP	234.116	Ea.	5/8"	376	391	567	661	462	671	767
TP	234.119	Ea.	3/4"	376	391	567	661	462	671	767
TP	234.128	Ea.	9/16"	424	437	594	679	501	688	772
TP	234.131	Ea.	11/16"	464	479	655	749	550	759	855
TP	234.307	Ea.	13/16"	464	479	655	749	550	759	855
(358) 3-5/8" Rail Height										
SQ	225.040	Ea.	3/8"	218	244	423	493	336	471	564
SQ	225.001	Ea.	1/2"	218	244	423	493	336	471	564
SQ	225.002	Ea.	5/8"	243	268	448	518	354	496	589
SQ	225.051	Ea.	3/4"	243	268	448	518	354	496	589
SQ	225.011	Ea.	9/16"	306	332	511	581	424	559	652
SQ	225.012	Ea.	11/16"	331	356	536	606	442	584	677
SQ	225.300	Ea.	13/16"	331	356	536	606	442	584	677
TP	225.043	Ea.	3/8"	218	244	423	493	336	471	564
TP	225.021	Ea.	1/2"	218	244	423	493	336	471	564
TP	225.196	Ea.	9/16"	306	332	511	581	424	559	652

				Standard Finishes \$					Custom Finishes \$	
DRS Top Rail Square (SQ) or Tapered (TP) with 8836 (928.006) Arm				101	108/109	503/599	600/601	700/701	999	Cladding
Profile	Ref. #	U/M	Glass Thickness	3	3	(SO)	(SO)	3	(SO)	(SO)
(4) 4" Rail Height										
SQ	225.442	Ea.	3/8"	218	244	423	493	336	471	564
SQ	225.401	Ea.	1/2"	218	244	423	493	336	471	564
SQ	225.013	Ea.	9/16"	306	332	511	581	424	559	652
TP	225.443	Ea.	3/8"	218	244	423	493	336	471	564
TP	225.421	Ea.	1/2"	218	244	423	493	336	471	564
TP	225.198	Ea.	9/16"	306	332	511	581	424	559	652
(6) 6" Rail Height										
SQ	225.140	Ea.	3/8"	435	453	657	671	487	681	777
SQ	225.111	Ea.	1/2"	435	453	657	671	487	681	777
SQ	225.150	Ea.	5/8"	460	478	682	696	515	706	802
SQ	225.161	Ea.	3/4"	460	478	682	696	515	706	802
SQ	225.015	Ea.	9/16"	523	541	745	759	575	769	865
SQ	225.016	Ea.	11/16"	548	566	770	784	603	794	890
SQ	225.360	Ea.	13/16"	548	566	770	784	603	794	890
(10) 10" Rail Height										
SQ	225.340	Ea.	3/8"	641	653	909	967	772	911	1,006
SQ	225.311	Ea.	1/2"	641	653	909	967	772	911	1,006
SQ	225.019	Ea.	5/8"	718	731 (SO)	1,018	1,083	865	1,020	1,127
SQ	225.031	Ea.	3/4"	718	731 (SO)	1,018	1,083	865	1,020	1,127
SQ	225.017	Ea.	9/16"	729	741	997	1,055	860	999	1,094
SQ	225.018	Ea.	11/16"	806	819	1,106	1,171	953	1,108	1,215
SQ	225.350	Ea.	13/16"	806	819	1,106	1,171	953	1,108	1,215

Laminated 3 Standard or Non-Standard Fabricated; lead time up to 3 business days.
 (SO) Special Fabricated/Finish or Special Order; lead time up to 5 weeks.

NOTES:

- Laminated options include 1 ea. tube of adhesive (934.800) and 4 ea. mixing tips (934.805) up to 52" rail.
- Applicator gun sold separately (934.801)
- Specify overall rail size and finish when ordering.
- Shear Locks can be ordered complete with Headers or can be ordered as a separate sales order line item.
- Base Price Includes Rail, Rail Covers/Cladding where appropriate, End Caps and Installed Hardware.
- All 108 finish DRS Rails will be provided with black (109) end caps.
- Reference Options and Prep Charges at the end of rail section.

DRS Rails, Channels & Accessories
 Patch Fittings & Designer Pivots
 Offset Hung Patch Fittings
 Headers & Accessories
 Closers & Hardware
 Locksets
 Pulls & Handles
 Sliding Systems
 MANET
 Panic Hardware

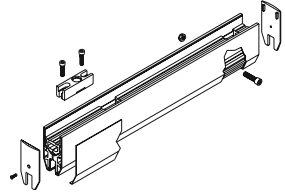
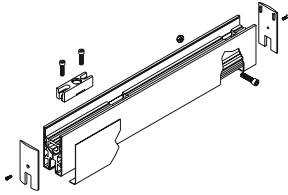

Square (SQ) DRS Top Rail —
355.0 (904.610) Insert

Tapered (TP) DRS Top Rail —
355.0 (904.610) Insert

				Standard Finishes \$					Custom Finishes \$	
DRS Top Rail Square (SQ) or Tapered (TP) with 355.0 (904.610) Insert				101	108/109	503/599	600/601	700/701	999	Cladding
Profile	Ref. #	U/M	Glass Thickness	3	3	(S0)	(S0)	3	(S0)	(S0)
(25) 2-1/2" Rail Height										
SQ	234.062	Ea.	3/8"	345	360	532	626	430	636	728
SQ	234.012	Ea.	1/2"	345	360	532	626	430	636	728
SQ	234.092	Ea.	5/8"	389	406	600	703	484	714	820
SQ	234.205	Ea.	3/4"	389	406	600	703	484	714	820
SQ	234.123	Ea.	9/16"	433	448	620	714	518	724	816
SQ	234.126	Ea.	11/16"	477	494	688	791	572	802	908
SQ	234.301	Ea.	13/16"	477	494	688	791	572	802	908
TP	234.065	Ea.	3/8"	345	360	532	626	430	636	728
TP	234.015	Ea.	1/2"	345	360	532	626	430	636	728
TP	234.117	Ea.	5/8"	389	406	600	703	484	714	820
TP	234.120	Ea.	3/4"	389	406	600	703	484	714	820
TP	234.129	Ea.	9/16"	433	448	620	714	518	724	816
TP	234.132	Ea.	11/16"	477	494	688	791	572	802	908
TP	234.308	Ea.	13/16"	477	494	688	791	572	802	908
(358) 3-5/8" Rail Height										
SQ	225.041	Ea.	3/8"	196	222	401	471	314	449	542
SQ	225.003	Ea.	1/2"	196	222	401	471	314	449	542
SQ	225.020	Ea.	5/8"	221	246	426	496	332	474	567
SQ	225.053	Ea.	3/4"	221	246	426	496	332	474	567
SQ	225.032	Ea.	9/16"	284	310	489	559	402	537	630
SQ	225.033	Ea.	11/16"	309	334	514	584	420	562	655
SQ	225.301	Ea.	13/16"	309	334	514	584	420	562	655
TP	225.044	Ea.	3/8"	196	222	401	471	314	449	542
TP	225.023	Ea.	1/2"	196	222	401	471	314	449	542
TP	225.216	Ea.	9/16"	284	310	489	559	402	537	630

				Standard Finishes \$					Custom Finishes \$	
DRS Top Rail Square (SQ) or Tapered (TP) with 355.0 (904.610) Insert				101	108/109	503/599	600/601	700/701	999	Cladding
Profile	Ref. #	U/M	Glass Thickness	3	3	(SO)	(SO)	3	(SO)	(SO)
(4) 4" Rail Height										
SQ	225.409	Ea.	3/8"	196	222	401	471	314	449	542
SQ	225.403	Ea.	1/2"	196	222	401	471	314	449	542
SQ	225.034	Ea.	9/16"	284	310	489	559	402	537	630
TP	225.444	Ea.	3/8"	196	222	401	471	314	449	542
TP	225.423	Ea.	1/2"	196	222	401	471	314	449	542
TP	225.218	Ea.	9/16"	284	310	489	559	402	537	630
(6) 6" Rail Height										
SQ	225.141	Ea.	3/8"	413	431	635	649	465	659	755
SQ	225.113	Ea.	1/2"	413	431	635	649	465	659	755
SQ	225.151	Ea.	5/8"	438	456	660	674	493	684	780
SQ	225.163	Ea.	3/4"	438	456	660	674	493	684	780
SQ	225.036	Ea.	9/16"	501	519	723	737	553	747	843
SQ	225.037	Ea.	11/16"	526	544	748	762	581	772	868
SQ	225.361	Ea.	13/16"	526	544	748	762	581	772	868
(10) 10" Rail Height										
SQ	225.341	Ea.	3/8"	619	631	887	945	750	889	984
SQ	225.313	Ea.	1/2"	619	631	887	945	750	889	984
SQ	225.046	Ea.	5/8"	693	707 (SO)	993	1,058	840	996	1,102
SQ	225.052	Ea.	3/4"	693	707 (SO)	993	1,058	840	996	1,102
SQ	225.038	Ea.	9/16"	707	719	975	1,033	838	977	1,072
SQ	225.039	Ea.	11/16"	781	795	1,081	1,146	928	1,084	1,190
SQ	225.351	Ea.	13/16"	781	795	1,081	1,146	928	1,084	1,190

Laminated 3 Standard or Non-Standard Fabricated; lead time up to 3 business days.
 (SO) Special Fabricated/Finish or Special Order; lead time up to 5 weeks.

NOTES:

- Laminated options include 1 ea. tube of adhesive (934.800) and 4 ea. mixing tips (934.805) up to 52" rail.
- Applicator gun sold separately (934.801)
- Specify overall rail size and finish when ordering.
- Shear Locks can be ordered complete with Headers or can be ordered as a separate sales order line item.
- Base Price Includes Rail, Rail Covers/Cladding where appropriate, End Caps and Installed Hardware.
- All 108 finish DRS Rails will be provided with black (109) end caps.
- Reference Options and Prep Charges at the end of rail section.

DRS Rails, Channels & Accessories
 Patch Fittings & Designer Pivots
 Offset Hung Patch Fittings
 Headers & Accessories
 Closers & Hardware
 Locksets
 Pulls & Handles
 Sliding Systems
 MANET
 Panic Hardware

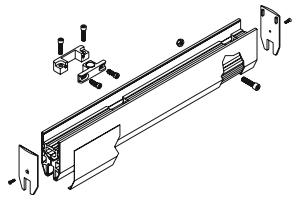
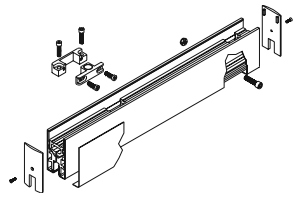

Square (SQ) DRS Top Rail –
355.9 (904.091) Pivot Insert

Tapered (TP) DRS Top Rail –
355.9 (904.091) Pivot Insert

				Standard Finishes \$					Custom Finishes \$	
DRS Top Rail Square (SQ) or Tapered (TP) with 355.9 (904.091) Pivot Insert				101	108/109	503/599	600/601	700/701	999	Cladding
Profile	Ref. #	U/M	Glass Thickness	3	3	SO	SO	3	SO	SO
(25) 2-1/2" Rail Height										
SQ	234.063	Ea.	3/8"	340	353	510	595	417	604	689
SQ	234.013	Ea.	1/2"	340	353	510	595	417	604	689
SQ	234.094	Ea.	5/8"	381	395	571	667	466	675	771
SQ	234.206	Ea.	3/4"	381	395	571	667	466	675	771
SQ	234.287	Ea.	9/16"	428	441	598	683	505	692	777
SQ	234.288	Ea.	11/16"	469	483	659	754	554	763	859
SQ	234.289	Ea.	13/16"	469	483	659	754	554	763	859
TP	234.066	Ea.	3/8"	340	353	510	595	417	604	689
TP	234.016	Ea.	1/2"	340	353	510	595	417	604	689
TP	234.118	Ea.	5/8"	381	395	571	667	466	675	771
TP	234.121	Ea.	3/4"	381	395	571	667	466	675	771
TP	234.130	Ea.	9/16"	428	441	598	683	505	692	777
TP	234.133	Ea.	11/16"	469	483	659	754	554	763	859
TP	234.140	Ea.	13/16"	469	483	659	754	554	763	859
(358) 3-5/8" Rail Height										
SQ	225.042	Ea.	3/8"	222	248	427	497	340	475	568
SQ	225.004	Ea.	1/2"	222	248	427	497	340	475	568
SQ	225.022	Ea.	5/8"	247	272	452	522	358	500	593
SQ	225.054	Ea.	3/4"	247	272	452	522	358	500	593
SQ	225.186	Ea.	9/16"	310	336	515	585	428	563	656
SQ	225.187	Ea.	11/16"	335	360	540	610	446	588	681
SQ	225.302	Ea.	13/16"	335	360	540	610	446	588	681
TP	225.045	Ea.	3/8"	222	248	427	497	340	475	568
TP	225.024	Ea.	1/2"	222	248	427	497	340	475	568
TP	225.220	Ea.	9/16"	310	336	515	585	428	563	656
(4) 4" Rail Height										
SQ	225.417	Ea.	3/8"	222	248	427	497	340	475	568
SQ	225.404	Ea.	1/2"	222	248	427	497	340	475	568
SQ	225.188	Ea.	9/16"	310	336	515	585	428	563	656
TP	225.445	Ea.	3/8"	222	248	427	497	340	475	568
TP	225.424	Ea.	1/2"	222	248	427	497	340	475	568
TP	225.222	Ea.	9/16"	310	336	515	585	428	563	656

				Standard Finishes \$					Custom Finishes \$	
DRS Top Rail Square (SQ) or Tapered (TP) with 355.9 (904.091) Pivot Insert				101	108/109	503/599	600/601	700/701	999	Cladding
Profile	Ref. #	U/M	Glass Thickness	3	3	SO	SO	3	SO	SO
(6) 6" Rail Height										
SQ	225.142	Ea.	3/8"	439	457	661	675	491	685	781
SQ	225.114	Ea.	1/2"	439	457	661	675	491	685	781
SQ	225.152	Ea.	5/8"	464	482	686	700	519	710	806
SQ	225.164	Ea.	3/4"	464	482	686	700	519	710	806
SQ	225.190	Ea.	9/16"	527	545	749	763	579	773	869
SQ	225.191	Ea.	11/16"	552	570	774	788	607	798	894
SQ	225.362	Ea.	13/16"	552	570	774	788	607	798	894
(10) 10" Rail Height										
SQ	225.342	Ea.	3/8"	645	657	913	971	776	915	1,010
SQ	225.314	Ea.	1/2"	645	657	913	971	776	915	1,010
SQ	225.194	Ea.	5/8"	722	736 (SO)	1,023	1,088	869	1,025	1,131
SQ	225.195	Ea.	3/4"	722	736 (SO)	1,023	1,088	869	1,025	1,131
SQ	225.192	Ea.	9/16"	733	745	1,001	1,059	864	1,003	1,098
SQ	225.193	Ea.	11/16"	810	824	1,111	1,176	957	1,113	1,219
SQ	225.352	Ea.	13/16"	810	824	1,111	1,176	957	1,113	1,219

Laminated 3 Standard or Non-Standard Fabricated; lead time up to 3 business days.
 SO Special Fabricated/Finish or Special Order; lead time up to 5 weeks.

NOTES:

- Laminated options include 1 ea. tube of adhesive (934.800) and 4 ea. mixing tips (934.805) up to 52" rail.
- Applicator gun sold separately (934.801)
- Specify overall rail size and finish when ordering.
- Shear Locks can be ordered complete with Headers or can be ordered as a separate sales order line item.
- Base Price Includes Rail, Rail Covers/Cladding where appropriate, End Caps and Installed Hardware.
- All 108 finish DRS Rails will be provided with black (109) end caps.
- Reference Options and Prep Charges at the end of rail section.

Accessories

Model	U/M	Ref. #	Description	List \$
8836	Ea.	928.006	7/8" End Load Top Arm, RTS	50
355.0	Ea.	904.610	Top Rail Insert for 15 mm Pin	26
355.9	Ea.	904.091	Top Rail Adjustable Insert	52
LGAA	Ea.	934.801	3M™ Scotch-Weld™ EPX™ plus II applicator with 2:1 and 1:1 plunger	330
LGA	Ea.	934.800	3M™ Scotch-Weld™ Urethane Adhesive, DP 605 NS, off white, 1 tube per 52" of pre-assembled rail	78
MTIPS	Set	934.805	3M™ Scotch-Weld™ EPX™ plus II mixing square nozzle, 5.3 mm (4 tips pers set)	10
				List Add \$
PANIC			Prep for Glass Panic/Deadbolt Push Bar Device in rail	75
ELCK PREP			dormakaba EMSL Shearlock, or EML Magnetic Lock armature preparation and installation in DRS rail	165
HDWPREP			Prep. and Install of dormakaba hardware (i.e., offset pivots, arms, etc.) in DRS rail	75
CMP HDWP			Competitors hardware only prep. in DRS rail (charge may be reviewed based on complexity)	150
CMP HDWI			Competitors hardware preparation and installation in DRS rails	150
CMP SHEAR			Competitors Electro-Magnetic Shear Lock or Magnetic Lock Armature Preparation only in DRS rails	250
MITER			Miter cut charge	61
				Net Add \$
POWDER			All Custom powder coated orders will include a net charge per purchase order.	200

NOTE: Scotch-Weld™ Urethane Adhesive, Scotch-Weld™ EPX™ plus II applicator, and Scotch-Weld™ EPX™ plus II mixing square nozzle are trademarks of 3M.

DRS Rails, Channels & Accessories
 Patch Fittings & Designer Pivots
 Offset Hung Patch Fittings
 Headers & Accessories
 Closers & Hardware
 Locksets
 Pulls & Handles
 Sliding Systems
 MANET
 Panic Hardware

DRS Bottom Rails, No Lock

Default 1/2" (12 mm) unless otherwise specified

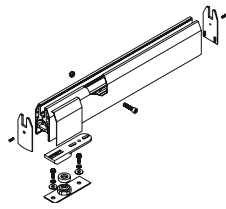
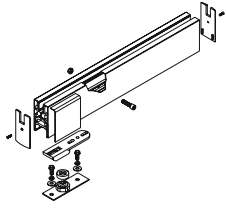

Square (SQ) DRS Bottom Rail
No Lock — 8852 (928.055) Pivot

Tapered (TP) DRS Bottom Rail
No Lock — 8852 (928.055) Pivot

				Standard Finishes \$					Custom Finishes \$	
DRS Bottom Rail Square (SQ) or Tapered (TP) with 8852 (928.055) Pivot				101	108/109	503/599	600/601	700/701	999	Cladding
Profile	Ref. #	U/M	Glass Thickness	3	3	SO	SO	3	SO	SO
(25) 2-1/2" Rail Height										
SQ	234.073	Ea.	3/8"	310	323	481	565	387	574	659
SQ	234.037	Ea.	1/2"	310	323	481	565	387	574	659
SQ	234.219	Ea.	5/8"	351	365	541	636	437	646	741
SQ	234.227	Ea.	3/4"	351	365	541	636	437	646	741
SQ	234.174	Ea.	9/16"	398	411	569	653	475	662	747
SQ	234.177	Ea.	11/16"	439	453	629	724	525	734	829
SQ	234.302	Ea.	13/16"	439	453	629	724	525	734	829
TP	234.076	Ea.	3/8"	310	323	481	565	387	574	659
TP	234.032	Ea.	1/2"	310	323	481	565	387	574	659
TP	234.168	Ea.	5/8"	351	365	541	636	437	646	741
TP	234.171	Ea.	3/4"	351	365	541	636	437	646	741
TP	234.180	Ea.	9/16"	398	411	569	653	475	662	747
TP	234.183	Ea.	11/16"	439	453	629	724	525	734	829
TP	234.309	Ea.	13/16"	439	453	629	724	525	734	829
(358) 3-5/8" Rail Height										
SQ	225.085	Ea.	3/8"	195	223	411	487	312	462	561
SQ	225.006	Ea.	1/2"	195	223	411	487	312	462	561
SQ	225.213	Ea.	5/8"	220	248	436	512	330	487	586
SQ	225.056	Ea.	3/4"	220	248	436	512	330	487	586
SQ	225.061	Ea.	9/16"	283	311	499	575	400	550	649
SQ	225.062	Ea.	11/16"	308	336	524	600	418	575	674
SQ	225.303	Ea.	13/16"	308	336	524	600	418	575	674
TP	225.088	Ea.	3/8"	195	223	411	487	312	462	561
TP	225.026	Ea.	1/2"	195	223	411	487	312	462	561
TP	225.226	Ea.	9/16"	283	311	499	575	400	550	649

				Standard Finishes \$					Custom Finishes \$	
DRS Bottom Rail Square (SQ) or Tapered (TP) with 8852 (928.055) Pivot				101	108/109	503/599	600/601	700/701	999	Cladding
Profile	Ref. #	U/M	Glass Thickness	3	3	(SO)	(SO)	3	(SO)	(SO)
(4) 4" Rail Height										
SQ	225.414	Ea.	3/8"	195	223	411	487	312	462	561
SQ	225.406	Ea.	1/2"	195	223	411	487	312	462	561
SQ	225.063	Ea.	9/16"	283	311	499	575	400	550	649
TP	225.438	Ea.	3/8"	195	223	411	487	312	462	561
TP	225.426	Ea.	1/2"	195	223	411	487	312	462	561
TP	225.228	Ea.	9/16"	283	311	499	575	400	550	649
(6) 6" Rail Height										
SQ	225.147	Ea.	3/8"	411	430	640	655	463	664	764
SQ	225.106	Ea.	1/2"	411	430	640	655	463	664	764
SQ	225.154	Ea.	5/8"	436	455	665	680	491	689	789
SQ	225.156	Ea.	3/4"	436	455	665	680	491	689	789
SQ	225.065	Ea.	9/16"	499	518	728	743	551	752	852
SQ	225.066	Ea.	11/16"	524	543	753	768	579	777	877
SQ	225.363	Ea.	13/16"	524	543	753	768	579	777	877
(10) 10" Rail Height										
SQ	225.344	Ea.	3/8"	641	653	963	988	748	927	1,028
SQ	225.306	Ea.	1/2"	641	653	963	988	748	927	1,028
SQ	225.069	Ea.	5/8"	718	731 (SO)	1,079	1,107	838	1,038	1,151
SQ	225.070	Ea.	3/4"	718	731 (SO)	1,079	1,107	838	1,038	1,151
SQ	225.067	Ea.	9/16"	729	741	1,051	1,076	836	1,015	1,116
SQ	225.068	Ea.	11/16"	806	819	1,167	1,195	926	1,126	1,239
SQ	225.353	Ea.	13/16"	806	819	1,167	1,195	926	1,126	1,239

Laminated 3 Standard or Non-Standard Fabricated; lead time up to 3 business days.
 (SO) Special Fabricated/Finish or Special Order; lead time up to 5 weeks.

NOTES:

- Laminated options include 1 ea. tube of adhesive (934.800) and 4 ea. mixing tips (934.805) up to 52" rail.
- Applicator gun sold separately (934.801)
- Specify overall rail size and finish when ordering.
- Base Price Includes Rail, Rail Covers/Cladding where appropriate, End Caps and Installed Hardware.
- All 108 finish DRS Rails will be provided with black (109) end caps.
- Reference Options and Prep Charges at the end of rail section.

DRS Rails, Channels & Accessories
 Patch Fittings & Designer Pivots
 Offset Hung Patch Fittings
 Headers & Accessories
 Closers & Hardware
 Locksets
 Pulls & Handles
 Sliding Systems
 MANET
 Panic Hardware

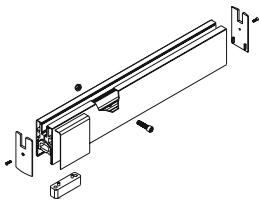

Square (SQ) DRS Bottom Rail
No Lock — 355.1 (904.020) Insert

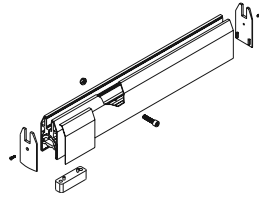

Tapered (TP) DRS Bottom Rail
No Lock — 355.1 (904.020) Insert

				Standard Finishes \$					Custom Finishes \$	
DRS Bottom Rail Square (SQ) or Tapered (TP) with 355.1 (904.020) Insert				101	108/109	503/599	600/601	700/701	999	Cladding
Profile	Ref. #	U/M	Glass Thickness	3	3	(SO)	(SO)	3	(SO)	(SO)
(358) 3-5/8" Rail Height										
SQ	225.086	Ea.	3/8"	187	215	403	479	304	454	553
SQ	225.008	Ea.	1/2"	187	215	403	479	304	454	553
SQ	225.214	Ea.	5/8"	212	240	428	504	322	479	577
SQ	225.058	Ea.	3/4"	212	240	428	504	322	479	577
SQ	225.071	Ea.	9/16"	275	303	491	567	392	542	641
SQ	225.072	Ea.	11/16"	300	328	516	592	410	567	665
SQ	225.304	Ea.	13/16"	300	328	516	592	410	567	665
TP	225.089	Ea.	3/8"	187	215	403	479	304	454	553
TP	225.028	Ea.	1/2"	187	215	403z	479	304	454	553
TP	225.230	Ea.	9/16"	275	303	491	567	392	542	641
(4) 4" Rail Height										
SQ	225.415	Ea.	3/8"	187	215	403	479	304	454	553
SQ	225.408	Ea.	1/2"	187	215	403	479	304	454	553
SQ	225.073	Ea.	9/16"	275	303	491	567	392	542	641
TP	225.439	Ea.	3/8"	187	215	403	479	304	454	553
TP	225.428	Ea.	1/2"	187	215	403	479	304	454	553
TP	225.232	Ea.	9/16"	275	303	491	567	392	542	641
(6) 6" Rail Height										
SQ	225.148	Ea.	3/8"	403	422	632	647	455	656	756
SQ	225.108	Ea.	1/2"	403	422	632	647	455	656	756
SQ	225.165	Ea.	5/8"	428	447	657	672	483	681	781
SQ	225.158	Ea.	3/4"	428	447	657	672	483	681	781
SQ	225.075	Ea.	9/16"	491	510	720	735	543	744	844
SQ	225.076	Ea.	11/16"	516	535	745	760	571	769	869
SQ	225.364	Ea.	13/16"	516	535	745	760	571	769	869
(10) 10" Rail Height										
SQ	225.346	Ea.	3/8"	633	645	955	980	740	919	1,020
SQ	225.308	Ea.	1/2"	633	645	955	980	740	919	1,020
SQ	225.091	Ea.	5/8"	709	722 (SO)	1,070	1,098	829	1,029	1,142
SQ	225.092	Ea.	3/4"	709	722 (SO)	1,070	1,098	829	1,029	1,142
SQ	225.077	Ea.	9/16"	721	733	1,043	1,068	828	1,007	1,108
SQ	225.078	Ea.	11/16"	797	810	1,158	1,186	917	1,117	1,230
SQ	225.354	Ea.	13/16"	797	810	1,158	1,186	917	1,117	1,230

Laminated

3 Standard or Non-Standard Fabricated; lead time up to 3 business days.
 (SO) Special Fabricated/Finish or Special Order; lead time up to 5 weeks.

NOTES:

- Laminated options include 1 ea. tube of adhesive (934.800) and 4 ea. mixing tips (934.805) up to 52" rail.
- Applicator gun sold separately (934.801)
- Specify overall rail size and finish when ordering.
- All 108 finish DRS Rails will be provided with black (109) end caps.
- Reference Options and Prep Charges at the end of rail section.

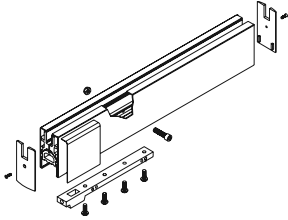

Square (SQ) DRS Bottom Rail No Lock – 7422 (227.002) Arm

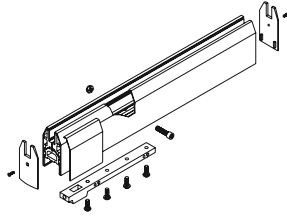

Tapered (TP) DRS Bottom Rail No Lock – 7422 (227.002) Arm

				Standard Finishes \$					Custom Finishes \$	
DRS Bottom Rail Square (SQ) or Tapered (TP) with 7422 (227.002) Arm				101	108/109	503/599	600/601	700/701	999	Cladding
Profile	Ref. #	U/M	Glass Thickness	3	3	SO	SO	3	SO	SO
(25) 2-1/2" Rail Height										
SQ	234.075	Ea.	3/8"	326	339	496	581	403	590	674
SQ	234.039	Ea.	1/2"	326	339	496	581	403	590	674
SQ	234.221	Ea.	5/8"	366	381	557	651	452	661	757
SQ	234.229	Ea.	3/4"	366	381	557	651	452	661	757
SQ	234.176	Ea.	9/16"	414	427	584	669	491	678	762
SQ	234.179	Ea.	11/16"	454	469	645	739	540	749	845
SQ	234.303	Ea.	13/16"	454	469	645	739	540	749	845
TP	234.078	Ea.	3/8"	326	339	496	581	403	590	674
TP	234.036	Ea.	1/2"	326	339	496	581	403	590	674
TP	234.170	Ea.	5/8"	366	381	557	651	452	661	757
TP	234.173	Ea.	3/4"	366	381	557	651	452	661	757
TP	234.182	Ea.	9/16"	414	427	584	669	491	678	762
TP	234.185	Ea.	11/16"	454	469	645	739	540	749	845
TP	234.310	Ea.	13/16"	454	469	645	739	540	749	845
(358) 3-5/8" Rail Height										
SQ	225.087	Ea.	3/8"	209	237	425	501	326	476	575
SQ	225.010	Ea.	1/2"	209	237	425	501	326	476	575
SQ	225.215	Ea.	5/8"	234	262	450	526	344	501	600
SQ	225.060	Ea.	3/4"	234	262	450	526	344	501	600
SQ	225.101	Ea.	9/16"	297	325	513	589	414	564	663
SQ	225.102	Ea.	11/16"	322	350	538	614	432	589	688
SQ	225.305	Ea.	13/16"	322	350	538	614	432	589	688
TP	225.090	Ea.	3/8"	209	237	425	501	326	476	575
TP	225.030	Ea.	1/2"	209	237	425	501	326	476	575
TP	225.234	Ea.	9/16"	297	325	513	589	414	564	663
(4) 4" Rail Height										
SQ	225.416	Ea.	3/8"	209	237	425	501	326	476	575
SQ	225.410	Ea.	1/2"	209	237	425	501	326	476	575
SQ	225.103	Ea.	9/16"	297	325	513	589	414	564	663
TP	225.440	Ea.	3/8"	209	237	425	501	326	476	575
TP	225.430	Ea.	1/2"	209	237	425	501	326	476	575
TP	225.236	Ea.	9/16"	297	325	513	589	414	564	663

DRS Rails, Channels & Accessories
Patch Fittings & Designer Pivots
Offset Hung Patch Fittings
Headers & Accessories
Closers & Hardware
Locksets
Pulls & Handles
Sliding Systems
MANET
Panic Hardware

				Standard Finishes \$					Custom Finishes \$	
DRS Bottom Rail Square (SQ) or Tapered (TP) with 7422 (227.002) Arm				101	108/109	503/599	600/601	700/701	999	Cladding
Profile	Ref. #	U/M	Glass Thickness	3	3	SO	SO	3	SO	SO
(6) 6" Rail Height										
SQ	225.149	Ea.	3/8"	425	444	654	669	477	678	778
SQ	225.110	Ea.	1/2"	425	444	654	669	477	678	778
SQ	225.167	Ea.	5/8"	450	469	679	694	505	703	803
SQ	225.160	Ea.	3/4"	450	469	679	694	505	703	803
SQ	225.115	Ea.	9/16"	513	532	742	757	565	766	866
SQ	225.116	Ea.	11/16"	538	557	767	782	593	791	891
SQ	225.365	Ea.	13/16"	538	557	767	782	593	791	891
(10) 10" Rail Height										
SQ	225.348	Ea.	3/8"	655	667	997	1,002	762	941	1,042
SQ	225.310	Ea.	1/2"	655	667	997	1,002	762	941	1,042
SQ	225.093	Ea.	5/8"	734	747 SO	1,117	1,122	853	1,054	1,167
SQ	225.112	Ea.	3/4"	734	747 SO	1,117	1,122	853	1,054	1,167
SQ	225.117	Ea.	9/16"	743	755	1,085	1,090	850	1,029	1,130
SQ	225.118	Ea.	11/16"	822	835	1,205	1,210	941	1,142	1,255
SQ	225.355	Ea.	13/16"	822	835	1,205	1,210	941	1,142	1,255

Laminated 3 Standard or Non-Standard Fabricated; lead time up to 3 business days.
 SO Special Fabricated/Finish or Special Order; lead time up to 5 weeks.

NOTES:

- Laminated options include 1 ea. tube of adhesive (934.800) and 4 ea. mixing tips (934.805) up to 52" rail.
- Applicator gun sold separately (934.801)
- Specify overall rail size and finish when ordering.
- All 108 finish DRS Rails will be provided with black (109) end caps.
- Reference Options and Prep Charges at the end of rail section.

Accessories

Model	U/M	Ref. #	Description	List \$
8852	Ea.	928.055	7/8" End Load Bottom Arm, RTS	40
355.1	Ea.	904.020	Bottom Rail Insert for 15 mm Pin	32
7422	Ea.	227.002	Bottom Rail Adjustable Insert	54
LGAA	Ea.	934.801	3M™ Scotch-Weld™ EPX™ plus II applicator with 2:1 and 1:1 plunger	330
LGA	Ea.	934.800	3M™ Scotch-Weld™ Urethane Adhesive, DP 605 NS, off white, 1 tube per 52" of pre-assembled rail	78
MTIPS	Set	934.805	3M™ Scotch-Weld™ EPX™ plus II mixing square nozzle, 5.3 mm (4 tips per set)	10
				List Add \$
PANIC			Prep for Glass Panic/Deadbolt Push Bar Device in rail	75
ELCK PREP			dormakaba EMSL Shearlock, or EML Magnetic Lock armature preparation and installation in DRS rail	165
HDWPREP			Prep and Install of dormakaba hardware (i.e., offset pivots, arms, etc.) in DRS rail	75
CMP HDWP			Competitors hardware only prep. in DRS rail (charge may be reviewed based on complexity)	150
CMP HDWI			Competitors hardware preparation and installation in DRS rails	150
CMP SHEAR			Competitors Electro-Magnetic Shear Lock or Magnetic Lock Armature Preparation only in DRS rails	250
MITER			Miter cut charge	61
				Net Add \$
POWDER			All Custom powder coated orders will include a net charge per purchase order.	200

NOTE: Scotch-Weld™ Urethane Adhesive, Scotch-Weld™ EPX™ plus II applicator, and Scotch-Weld™ EPX™ plus II mixing square nozzle are trademarks of 3M.

DRS Bottom Rails, Locking

Default 1/2" (12 mm) unless otherwise specified

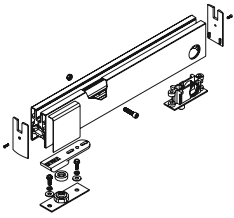

Square (SQ) DRS Bottom Rail Locking — 8852 (928.055) Pivot

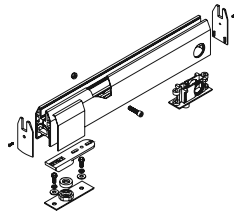

Tapered (TP) DRS Bottom Rail Locking — 8852 (928.055) Pivot

DRS Locking Bottom Rail Square (SQ) or Tapered (TP) with 8852 (928.055) Pivot				Standard Finishes \$					Custom Finishes \$	
				101	108/109	503/599	600/601	700/701	999	Cladding
Profile	Ref. #	U/M	Glass Thickness	3	3	SO	SO	3	SO	SO
(25) 2-1/2" Rail Height										
SQ	234.067	Ea.	3/8"	345	359	516	601	422	609	694
SQ	234.017	Ea.	1/2"	345	359	516	601	422	609	694
SQ	234.216	Ea.	5/8"	386	400	576	671	472	681	777
SQ	234.222	Ea.	3/4"	386	400	576	671	472	681	777
SQ	234.186	Ea.	9/16"	433	447	604	689	510	697	782
SQ	234.189	Ea.	11/16"	474	488	664	759	560	769	865
SQ	234.304	Ea.	13/16"	474	488	664	759	560	769	865
TP	234.070	Ea.	3/8"	345	359	516	601	422	609	694
TP	234.031	Ea.	1/2"	345	359	516	601	422	609	694
TP	234.101	Ea.	5/8"	386	400	576	671	472	681	777
TP	234.104	Ea.	3/4"	386	400	576	671	472	681	777
TP	234.192	Ea.	9/16"	433	447	604	689	510	697	782
TP	234.195	Ea.	11/16"	474	488	664	759	560	769	865
TP	234.311	Ea.	13/16"	474	488	664	759	560	769	865
(358) 3-5/8" Rail Height										
SQ	225.079	Ea.	3/8"	227	255	443	519	346	494	593
SQ	225.005	Ea.	1/2"	227	255	443	519	346	494	593
SQ	225.210	Ea.	5/8"	252	280	468	544	363	519	618
SQ	225.055	Ea.	3/4"	252	280	468	544	363	519	618
SQ	225.119	Ea.	9/16"	315	343	531	607	434	582	681
SQ	225.120	Ea.	11/16"	340	368	556	632	451	607	706
SQ	225.306	Ea.	13/16"	340	368	556	632	451	607	706
TP	225.082	Ea.	3/8"	227	255	443	519	346	494	593
TP	225.025	Ea.	1/2"	227	255	443	519	346	494	593
TP	225.238	Ea.	9/16"	315	343	531	607	434	582	681

DRS Rails, Channels & Accessories
Patch Fittings & Designer Pivots
Offset Hung Patch Fittings
Headers & Accessories
Closers & Hardware
Locksets
Pulls & Handles
Sliding Systems
MANET
Panic Hardware

				Standard Finishes \$					Custom Finishes \$	
DRS Locking Bottom Rail Square (SQ) or Tapered (TP) with 8852 (928.055) Pivot				101	108/109	503/599	600/601	700/701	999	Cladding
Profile	Ref. #	U/M	Glass Thickness	3	3	(SO)	(SO)	3	(SO)	(SO)
(4) 4" Rail Height										
SQ	225.411	Ea.	3/8"	227	255	443	519	346	494	593
SQ	225.405	Ea.	1/2"	227	255	443	519	346	494	593
SQ	225.121	Ea.	9/16"	315	343	531	607	434	582	681
TP	225.432	Ea.	3/8"	227	255	443	519	346	494	593
TP	225.425	Ea.	1/2"	227	255	443	519	346	494	593
TP	225.240	Ea.	9/16"	315	343	531	607	434	582	681
(6) 6" Rail Height										
SQ	225.144	Ea.	3/8"	443	462	672	687	497	696	796
SQ	225.105	Ea.	1/2"	443	462	672	687	497	696	796
SQ	225.153	Ea.	5/8"	468	487	697	712	524	721	821
SQ	225.155	Ea.	3/4"	468	487	697	712	524	721	821
SQ	225.123	Ea.	9/16"	531	550	760	775	585	784	884
SQ	225.124	Ea.	11/16"	556	575	785	800	612	809	909
SQ	225.366	Ea.	13/16"	556	575	785	800	612	809	909
(10) 10" Rail Height										
SQ	225.343	Ea.	3/8"	673	685	995	1,020	781	959	1,060
SQ	225.305	Ea.	1/2"	673	685	995	1,020	781	959	1,060
SQ	225.127	Ea.	5/8"	754	767 (SO)	1,114	1,142	875	1,074	1,187
SQ	225.128	Ea.	3/4"	754	767 (SO)	1,114	1,142	875	1,074	1,187
SQ	225.125	Ea.	9/16"	761	773	1,083	1,108	869	1,047	1,148
SQ	225.126	Ea.	11/16"	842	855	1,202	1,230	963	1,162	1,275
SQ	225.356	Ea.	13/16"	842	855	1,202	1,230	963	1,162	1,275

Laminated 3 Standard or Non-Standard Fabricated; lead time up to 3 business days.
SO Special Fabricated/Finish or Special Order; lead time up to 5 weeks.

- NOTES:**
- Laminated options include 1 ea. tube of adhesive (934.800) and 4 ea. mixing tips (934.805) up to 52" rail.
 - Applicator gun sold separately (934.801)
 - Specify overall rail size and finish when ordering.
 - Base Price Includes Rail, Rail Covers/Cladding where appropriate, End Caps and Installed Hardware.
 - All 108 finish DRS Rails will be provided with black (109) end caps.
 - Reference Options and Prep Charges at the end of rail section.

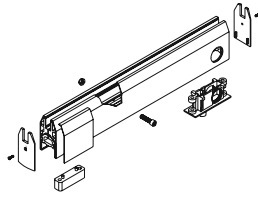
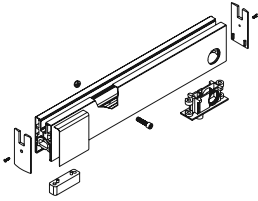

Square (SQ) DRS Bottom Rail
Locking — 355.1 (904.020) Insert

Tapered (TP) DRS Bottom Rail
Locking — 355.1 (904.020) Insert

				Standard Finishes \$					Custom Finishes \$	
DRS Locking Bottom Rail Square (SQ) or Tapered (TP) with 355.1 (904.020) Insert				101	108/109	503/599	600/601	700/701	999	Cladding
Profile	Ref. #	U/M	Glass Thickness	3	3	SO	SO	3	SO	SO
(358) 3-5/8" Rail Height										
SQ	225.080	Ea.	3/8"	219	247	435	511	338	486	585
SQ	225.007	Ea.	1/2"	219	247	435	511	338	486	585
SQ	225.211	Ea.	5/8"	244	272	460	536	355	511	610
SQ	225.057	Ea.	3/4"	244	272	460	536	355	511	610
SQ	225.129	Ea.	9/16"	307	335	523	599	426	574	673
SQ	225.130	Ea.	11/16"	332	360	548	624	443	599	698
SQ	225.307	Ea.	13/16"	332	360	548	624	443	599	698
TP	225.083	Ea.	3/8"	219	247	435	511	338	486	585
TP	225.027	Ea.	1/2"	219	247	435	511	338	486	585
TP	225.242	Ea.	9/16"	307	335	523	599	426	574	673
(4) 4" Rail Height										
SQ	225.412	Ea.	3/8"	219	247	435	511	338	486	585
SQ	225.407	Ea.	1/2"	219	247	435	511	338	486	585
SQ	225.131	Ea.	9/16"	307	335	523	599	426	574	673
TP	225.433	Ea.	3/8"	219	247	435	511	338	486	585
TP	225.427	Ea.	1/2"	219	247	435	511	338	486	585
TP	225.244	Ea.	9/16"	307	335	523	599	426	574	673
(6) 6" Rail Height										
SQ	225.145	Ea.	3/8"	435	454	664	679	489	688	788
SQ	225.107	Ea.	1/2"	435	454	664	679	489	688	788
SQ	225.162	Ea.	5/8"	460	479	689	704	516	713	813
SQ	225.157	Ea.	3/4"	460	479	689	704	516	713	813
SQ	225.133	Ea.	9/16"	523	542	752	767	577	776	876
SQ	225.134	Ea.	11/16"	548	567	777	792	604	801	901
SQ	225.367	Ea.	13/16"	548	567	777	792	604	801	901

DRS Rails, Channels & Accessories
Patch Fittings & Designer Pivots
Offset Hung Patch Fittings
Headers & Accessories
Closers & Hardware
Locksets
Pulls & Handles
Sliding Systems
MANET
Panic Hardware

				Standard Finishes \$					Custom Finishes \$	
DRS Locking Bottom Rail Square (SQ) or Tapered (TP) with 355.1 (904.020) Insert				101	108/109	503/599	600/601	700/701	999	Cladding
Profile	Ref. #	U/M	Glass Thickness	3	3	(SO)	(SO)	3	(SO)	(SO)
(10) 10" Rail Height										
SQ	225.345	Ea.	3/8"	665	677	1,012	773	951	1,020	1,052
SQ	225.307	Ea.	1/2"	665	677	1,012	773	951	1,020	1,052
SQ	225.137	Ea.	5/8"	745	758 (SO)	1,133	866	1,065	1,142	1,178
SQ	225.138	Ea.	3/4"	745	758 (SO)	1,133	866	1,065	1,142	1,178
SQ	225.135	Ea.	9/16"	753	765	1,100	861	1,039	1,140	1,108
SQ	225.136	Ea.	11/16"	833	846	1,221	954	1,153	1,266	1,230
SQ	225.357	Ea.	13/16"	833	846	1,221	954	1,153	1,266	1,230

Laminated 3 Standard or Non-Standard Fabricated; lead time up to 3 business days.
 (SO) Special Fabricated/Finish or Special Order; lead time up to 5 weeks.

NOTES:

- Laminated options include 1 ea. tube of adhesive (934.800) and 4 ea. mixing tips (934.805) up to 52" rail.
- Applicator gun sold separately (934.801)
- Specify overall rail size and finish when ordering.
- Base Price Includes Rail, Rail Covers/Cladding where appropriate, End Caps and Installed Hardware.
- All 108 finish DRS Rails will be provided with black (109) end caps.
- Reference Options and Prep Charges at the end of rail section.

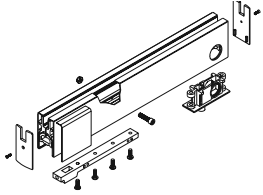

Square (SQ) DRS Bottom Rail Locking — 7422 (227.002) Arm

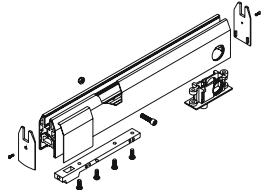

Tapered (TP) DRS Bottom Rail Locking — 7422 (227.002) Arm

				Standard Finishes \$					Custom Finishes \$	
DRS Locking Bottom Rail Square (SQ) or Tapered (TP) with 7422 (227.002) Arm				101	108/109	503/599	600/601	700/701	999	Cladding
Profile	Ref. #	U/M	Glass Thickness	3	3	SO	SO	3	SO	SO
(25) 2-1/2" Rail Height										
SQ	234.069	Ea.	3/8"	361	374	531	616	438	625	710
SQ	234.019	Ea.	1/2"	361	374	531	616	438	625	710
SQ	234.218	Ea.	5/8"	402	416	592	686	487	696	792
SQ	234.226	Ea.	3/4"	402	416	592	686	487	696	792
SQ	234.188	Ea.	9/16"	449	462	619	704	526	713	798
SQ	234.191	Ea.	11/16"	490	504	680	774	575	784	880
SQ	234.305	Ea.	13/16"	490	504	680	774	575	784	880
TP	234.072	Ea.	3/8"	361	374	531	616	438	625	710
TP	234.035	Ea.	1/2"	361	374	531	616	438	625	710
TP	234.103	Ea.	5/8"	402	416	592	686	487	696	792
TP	234.115	Ea.	3/4"	402	416	592	686	487	696	792
TP	234.194	Ea.	9/16"	449	462	619	704	526	713	798
TP	234.197	Ea.	11/16"	490	504	680	774	575	784	880
TP	234.312	Ea.	13/16"	490	504	680	774	575	784	880
(358) 3-5/8" Rail Height										
SQ	225.081	Ea.	3/8"	241	269	457	533	360	508	607
SQ	225.009	Ea.	1/2"	241	269	457	533	360	508	607
SQ	225.212	Ea.	5/8"	266	294	482	558	377	533	632
SQ	225.059	Ea.	3/4"	266	294	482	558	377	533	632
SQ	225.168	Ea.	9/16"	329	357	545	621	448	596	695
SQ	225.169	Ea.	11/16"	354	382	570	646	465	621	720
SQ	225.308	Ea.	13/16"	354	382	570	646	465	621	720
TP	225.084	Ea.	3/8"	241	269	457	533	360	508	607
TP	225.029	Ea.	1/2"	241	269	457	533	360	508	607
TP	225.246	Ea.	9/16"	329	357	545	621	448	596	695

DRS Rails, Channels & Accessories
Patch Fittings & Designer Pivots
Offset Hung Patch Fittings
Headers & Accessories
Closers & Hardware
Locksets
Pulls & Handles
Sliding Systems
MANET
Panic Hardware

				Standard Finishes \$					Custom Finishes \$	
DRS Locking Bottom Rail Square (SQ) or Tapered (TP) with 7422 (227.002) Arm				101	108/109	503/599	600/601	700/701	999	Cladding
Profile	Ref. #	U/M	Glass Thickness	③	③	Ⓢ	Ⓢ	③	Ⓢ	Ⓢ
(4) 4" Rail Height										
SQ	225.413	Ea.	3/8"	241	269	457	533	360	508	607
SQ	225.418	Ea.	1/2"	241	269	457	533	360	508	607
SQ	225.170	Ea.	9/16"	329	357	545	621	448	596	695
TP	225.434	Ea.	3/8"	241	269	457	533	360	508	607
TP	225.429	Ea.	1/2"	241	269	457	533	360	508	607
TP	225.248	Ea.	9/16"	329	357	545	621	448	596	695
(6) 6" Rail Height										
SQ	225.146	Ea.	3/8"	457	476	686	701	511	710	810
SQ	225.109	Ea.	1/2"	457	476	686	701	511	710	810
SQ	225.166	Ea.	5/8"	482	501	711	726	538	735	835
SQ	225.159	Ea.	3/4"	482	501	711	726	538	735	835
SQ	225.172	Ea.	9/16"	545	564	774	789	599	798	898
SQ	225.173	Ea.	11/16"	570	589	799	814	626	823	923
SQ	225.368	Ea.	13/16"	570	589	799	814	626	823	923
(10) 10" Rail Height										
SQ	225.347	Ea.	3/8"	687	699	1,009	1,034	795	973	1,074
SQ	225.309	Ea.	1/2"	687	699	1,009	1,034	795	973	1,074
SQ	225.139	Ea.	5/8"	769	783 Ⓢ	1,130	1,158	890	1,090	1,203
SQ	225.208	Ea.	3/4"	769	783 Ⓢ	1,130	1,158	890	1,090	1,203
SQ	225.174	Ea.	9/16"	775	787	1,097	1,122	883	1,061	1,162
SQ	225.175	Ea.	11/16"	857	871	1,218	1,246	978	1,178	1,291
SQ	225.358	Ea.	13/16"	857	871	1,218	1,246	978	1,178	1,291

Laminated ③ Standard or Non-Standard Fabricated; lead time up to 3 business days.
 Ⓢ Special Fabricated/Finish or Special Order; lead time up to 5 weeks.

- NOTES:**
- Laminated options include 1 ea. tube of adhesive (934.800) and 4 ea. mixing tips (934.805) up to 52" rail.
 - Applicator gun sold separately (934.801)
 - Specify overall rail size and finish when ordering.
 - Base Price Includes Rail, Rail Covers/Cladding where appropriate, End Caps and Installed Hardware.
 - All 108 finish DRS Rails will be provided with black (109) end caps.
 - Reference Options and Prep Charges at the end of rail section.

Options and Prep Charges

Model	U/M	Ref. #	Description	108	500/501 ^(SO)
CLYLXBLNK	—	—	Cylinder x Blank	32	32
CYLXCYL	—	—	Cylinder x Cylinder	38	38
CYLXTT	—	—	Cylinder x Thumb Turn	38	38
TTXBLNK	—	—	Thumb Turn x Blank	32	32
TTXTT	—	—	Thumb Turn x Thumb Turn	38	38
CYL	—	225.999	Mortise Cylinder for DRS Lock, with split ring	19	19
TT	—	225.998	Mortise Thumb Turn for DRS Lock, with split ring	19	19
BLNK	—	225.994	Mortise Blank (Dummy) Cylinder for DRS Lock, with split ring	13	13
					List \$
8852	Ea.	928.055	7/8" (22) End Load Bottom Arm, RTS		40
355.1	Ea.	904.020	Bottom Rail Insert for 15 mm Pin		32
7422	Ea.	227.002	Bottom Rail Adjustable Insert		54
BRASSLK 1916	Ea.	925.019	Bottom Rail Brass Door Lock, 1-9/16" (40) (5/8" (16) Throw)		36
BRASSLK 1916L	Ea.	925.119	Bottom Rail Brass Door Lock 1-9/16" (7/8" long throw fully retracted projects 1/4" below lock base)		50
BRASSLK 178	Ea.	925.018	Bottom Rail Brass Door Lock 1-15/16" (5/8" Throw). Not for use with DRS Rails. Requires 1-15/16" lock height clearance in rail		38
BRASSLK 25	Ea.	934.018	Bottom Rail Brass Door Lock, 1-9/16" (5/8" Throw) Modified for 2-1/2" Rail Only		72
BRASSLK 1916L 25	Ea.	934.017	Bottom Rail Brass Door Lock 1-9/16" (7/8" long throw fully retracted projects 1/4" below lock base) Modified for 2-1/2" Rail Only		84
LGAA	Ea.	934.801	3M™ Scotch-Weld™ EPX™ plus II applicator with 2:1 and 1:1 plunger		330
LGA	Ea.	934.800	3M™ Scotch-Weld™ Urethane Adhesive, DP 605 NS, off white, 1 tube per 52" of pre-assembled rail		78
MTIPS	Set	934.805	3M™ Scotch-Weld™ EPX™ plus II mixing square nozzle, 5.3 mm (4 tips per set)		10
					List Add \$
PANIC			Prep for Glass Panic/Deadbolt Push Bar Device in rail		75
ELCK PREP			dormakaba EMSL Shearlock, or EML Magnetic Lock armature preparation and installation in DRS rail		165
HDWPREP			Prep. and Install of dormakaba hardware (i.e., offset pivots, arms, etc.) in DRS rail		75
CMP HDWP			Competitors hardware only prep. in DRS rail (charge may be reviewed based on complexity)		150
CMP HDWI			Competitors hardware preparation and installation in DRS rails		150
CMP SHEAR			Competitors Electro-Magnetic Shear Lock or Magnetic Lock Armature Preparation only in DRS rails		250
MITER			Miter cut charge		61
					Net Add \$
POWDER			All Custom powder coated orders will include a net charge per purchase order.		200

NOTE: Scotch-Weld™ Urethane Adhesive, Scotch-Weld™ EPX™ plus II applicator, and Scotch-Weld™ EPX™ plus II mixing square nozzle are trademarks of 3M.

DRS Rails,
Channels &
AccessoriesPatch Fittings
& Designer
PivotsOffset
Hung Patch
FittingsHeaders &
AccessoriesClosers &
Hardware







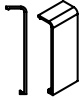

Locksets

Pulls &
HandlesSliding
Systems

MANET

Panic
Hardware



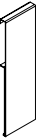



DRS Accessories

	Ref. #	U/M	Description	Standard Finishes \$					Custom Finishes \$	
				101	108/109	503/599	600/601	700/701	999	Plating
				③	③	⑤0	⑤0	③	⑤0	⑤0
2-1/2" Square Rail Covers										
	934.028	Ft.	Anodized (3/8"-9/16")	9	13	—	—	—	32	—
	234.569	Ft.	Cladded (3/8"-9/16")	—	—	38	48	23	—	82
	934.004	Ft.	Anodized (5/8"-13/16")	9	13	—	—	—	32	—
	234.564	Ft.	Cladded (5/8"-13/16")	—	—	38	48	23	—	82
2-1/2" Tapered Rail Covers										
	934.029	Ft.	Anodized (3/8"-9/16")	9	13	—	—	—	—	—
	234.568	Ft.	Cladded (3/8"-9/16")	—	—	38	48	23	—	82
	934.003	Ft.	Anodized (5/8"-13/16")	9	13	—	—	—	—	—
	234.560	Ft.	Cladded (5/8"-13/16")	—	—	38	48	23	—	82
3-5/8" Square Rail Cover										
	925.035	Ft.	Anodized (3/8"-9/16")	7	11	—	—	—	27	—
	225.502	Ft.	Cladded (3/8"-9/16")	—	—	32	40	19	—	68
	925.535	Ft.	Anodized (5/8"-13/16")	7	11	—	—	—	27	—
	225.505	Ft.	Cladded (5/8"-13/16")	—	—	32	40	19	—	68
3-5/8" Tapered Rail Cover										
	925.036	Ft.	Anodized (3/8"-9/16")	7	11	—	—	—	27	—
	225.503	Ft.	Cladded (3/8"-9/16")	—	—	32	40	19	—	68
4" Square Rail Cover										
	925.735	Ft.	Anodized (3/8"-9/16")	7	11	—	—	—	27	—
	225.508	Ft.	Cladded (3/8"-9/16")	—	—	32	40	19	—	68
4" Tapered Rail Cover										
	925.739	Ft.	Anodized (3/8"-9/16")	7	11	—	—	—	27	—
	225.509	Ft.	Cladded (3/8"-9/16")	—	—	32	40	19	—	68
6" Square Rail Cover										
	925.042	Ft.	Anodized (3/8"-9/16")	12	19	—	—	—	33	—
	225.506	Ft.	Cladded (3/8"-9/16")	—	—	42	43	28	—	73
	925.542	Ft.	Anodized (5/8"-13/16")	12	19	—	—	—	33	—
	225.559	Ft.	Cladded (5/8"-13/16")	—	—	42	43	28	—	73
10" Square Rail Cover										
	925.205	Ft.	Anodized (3/8"-9/16")	38	40	—	—	—	64	—
	225.525	Ft.	Cladded (3/8"-9/16")	—	—	79	83	60	—	140
	225.919	Ft.	Anodized or Cladded (5/8"-13/16")	50	59	91	95	72	97	152

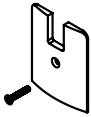
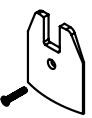

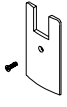
- ① Non-Fabricated item, ships in 1 business day.
- ③ Standard or Non-Standard Fabricated; lead time up to 3 business days.
- ⑤0 Special Fabricated/Finish or Special Order; lead time up to 5 weeks.

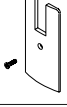
NOTES:

- Must specify length when ordering. dormakaba will cut to specified size, priced per foot (ft.) only.
- Maximum length for extrusion is 144" (3.7 m) before requiring splice/joint; 120" (3 m) for brass or bronze finish.
- 3-5/8" SQ End Cap available Select Service in 101, 108, and 700; 4" SQ End Cap available in 101 and 700.

				Finishes \$			
				101/109	503/599/600/601	500/501	Custom
Model	Ref. #	U/M	Description	3	50	3	50
2-1/2" Square Rail End Caps							
	934.040	Ea.	Anodized (3/8"-9/16")	17	—	—	50
	934.041	Ea.	Cladded (3/8"-9/16")	—	39	34	—
	934.036	Ea.	Anodized (5/8"-13/16")	17	—	—	50
	934.037	Ea.	Cladded (5/8"-13/16")	—	39	34	—
2-1/2" Tapered Rail End Caps							
	934.038	Ea.	Anodized (3/8"-9/16")	17	—	—	50
	934.039	Ea.	Cladded (3/8"-9/16")	—	39	34	—
	934.034	Ea.	Anodized (5/8"-13/16")	17	—	—	50
	934.035	Ea.	Cladded (5/8"-13/16")	—	39	34	—
DRS Rail End Caps							
	925.033	Ea.	3-5/8" (92 mm) Anodized and Cladded Square End Cap 3/8"-9/16" Glass	13	31	28	40
	925.533	Ea.	3-5/8" (92 mm) Anodized and Cladded Square End Cap 5/8"-13/16" Glass	13	31	28	40
	925.034	Ea.	3-5/8" (92 mm) Anodized and Cladded Tapered End Cap 3/8"-9/16" Glass	13	31	28	40
	925.733	Ea.	4" (102 mm) Anodized and Cladded Square End Cap 3/8"-9/16" Glass	13	31	28	40
	925.737	Ea.	4" (102 mm) Anodized Tapered End Cap 3/8"-9/16" Glass	13	—	—	40
	925.738	Ea.	4" (102 mm) Cladded Tapered End Cap 3/8"-9/16" Glass	—	31	28	—

DRS Rails, Channels & Accessories
Patch Fittings & Designer Pivots
Offset Hung Patch Fittings
Headers & Accessories
Closers & Hardware
Locksets
Pulls & Handles
Sliding Systems
MANET
Panic Hardware

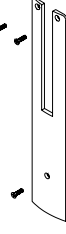
				Finishes \$				
				101/109	503/599/600/601	500/501	Custom	
Model	Ref. #	U/M	Description	3	(S0)	3	(S0)	
	925.028	Ea.	Anodized 6" (152 mm) Square End Cap 3/8"-9/16" Glass	55	—	—	81	
	925.526	Ea.	Cladded 6" (152 mm) Square End Cap 3/8"-9/16" Glass	—	62	60	—	
	925.528	Ea.	Anodized 6" (152 mm) Square End Cap 5/8"-13/16" Glass	55	—	—	81	
	925.527	Ea.	Cladded 6" (152 mm) Square End Cap 5/8"-13/16" Glass	—	62	60	—	
	925.240	Ea.	Anodized 10" (254 mm) Square End Cap (Rails) 3/8"-9/16" Glass	68	—	—	111	
	925.241	Ea.	Cladded 10" (254 mm) Square End Cap 3/8"-9/16" Glass	—	85	82	—	
					101	109		
				3	(S0)			
	925.920	Ea.	Anodized or Cladded 10" (254 mm) Square End Cap (Rails) 5/8"-13/16" Glass	88	88	105	102	137

Net Add \$











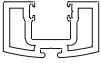

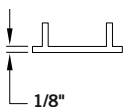
POWDER

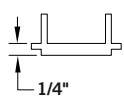
All Custom powder coated orders will include a **net charge** per purchase order

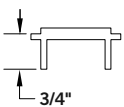
200

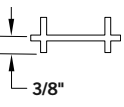
NOTES:

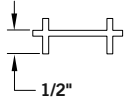
- 3-5/8" SQ End Cap available Select Service in 101, 108, and 700; 4" SQ End Cap available in 101 and 700.
- End caps not available in true stainless steel. 500/501 Satin/Polished Chrome end caps supplied when 700/701 finish rails are ordered.

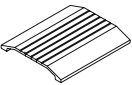
				Standard Finishes \$					Custom Finishes \$	
				101	108/109	503/599	600/601	700/701	999	Plating
Model	Ref. #	U/M	Description	3	3	SO	SO	3	SO	SO
DRS Dri-Fit Vertical Stile										
	225.280*	Ea.	3/8" (10 mm)	165	210	477	491	405	521	537
	225.281	Ea.	1/2" (12 mm)	165	210	477	491	405	521	537
			* Vertical stiles are priced one (1) each @ 144" (3658) anodized or maximum 120" (3048) clad. 1-1/8" (29 mm) x 1-7/8" (48 mm) Wide includes endload cap and Dri-Fit gasket (requires Weather Brush or Seal).							
										List \$
Weather Brush or Weather Seal										
	925.289	Ft.	Weather Brush							① 2
	925.288	Ft.	Weather Seal (Vinyl)							2
DRS Sidelite Rail Shim										
	925.134	Ea.	Stacking Glass Shim (no finish required)							2
				Rail	100	109				
Saddles and Thresholds				3	3					
	925.050	Ft.	Saddle 1/8" Head Typical	3-5/8"-10"	7	7				
	934.135	Ft.	Saddle 1/8" Head Typical	2-1/2"	7	7				
	925.049	Ft.	Saddle 1/4"	3-5/8"-10"	7	7				
	934.136	Ft.	Saddle 1/4"	2-1/2"	7	7				
	925.049	Ft.	Saddle 3/4"	3-5/8"-10"	7	7				
	934.140	Ft.	Saddle 3/4"	2-1/2"	7	7				
	925.051	Ft.	Saddle 3/8"	3-5/8"-10"	7	7				
	934.137	Ft.	Saddle 3/8"	2-1/2"	7	7				
	925.051	Ft.	Saddle 1/2"	3-5/8"-10"	7	7				
	934.138	Ft.	Saddle 1/2"	2-1/2"	7	7				
	925.058	Ft.	1/2" x 4" Threshold Available @ 16' Length	—	14	—				

- ① Non-Fabricated item, ships in 1 business day.
- 3 Standard or Non-Standard Fabricated; lead time up to 3 business days.
- SO Special Fabricated/Finish or Special Order; lead time up to 5 weeks.

NOTE: DRS 10" Rails will project 1/32" (IMM) at both leading edges beyond the vertical door surface if combined with dormakaba Vertical Stiles.

DRS Rails, Channels & Accessories
 Patch Fittings & Designer Pivots
 Offset Hung Patch Fittings
 Headers & Accessories
 Closers & Hardware
 Locksets
 Pulls & Handles
 Sliding Systems
 MANET
 Panic Hardware

Dri-Fit® Sidelite Rails

Ordering Guide

Ordered Less Covers or Cladding —		NO	Specify	Sidelite Profile		End Cap Miter		Saddle Height		Saddle Finish	
				TP — Tapered Rail	SQ — Square Rail	NONE	0	1/2	3/8	3/4	100 — Mill Aluminum
						EC2	1	1/4	1/8	NO	109 — Black Aluminum
						EC1	2	NO			
SDLT	358		35-3/4	SQ	1/2	101	EC2	0			100
SDLT Model	25 — 2-1/2" Sidelite Rail			1/2" Glass — 1/2	101 — Clear Anodized (CL)						
	358 — 3-5/8" Sidelite Rail			3/8" Glass — 3/8	108 — Dark Bronze (DB)						
	4 — 4" Sidelite Rail			9/16" Glass — 9/16	109 — Black Anodized (BK)						
	6 — 6" Sidelite Rail			5/8" Glass — 5/8	503 — Polished Brass without Lacquer (PB)						
	10 — 10" Sidelite Rail			11/16" Glass — 11/16	599 — Satin Brass w/o Lacquer (SB)						
Rail Height				3/4" Glass — 3/4	600 — Satin Bronze w/o Lacquer (SBZ)						
				Glass Thickness	601 — Polished Bronzed w/o Lacquer (PB2)						
					700 — Satin Stainless Steel (SS/US32D)						
					701 — Polished Stainless Steel (PS/US32)						

- 1 Tapered Rail (TP) available with 2-1/2", 3-5/8", and 4" rails.
- 2 5/8" and 3/4" glass available only with 2-1/2", 3-5/8", 6", and 10" rails.
- 3 dormakaba reserves the right to refuse Custom Finishes.
- 4 All Custom Finishes require customer sign-off/approval of color chip.

Standard Finish

999	— Powder Coated Finishes (Specify)
CCLAD	— Custom Cladding (Specify)





Finish Custom^{3,4}

DRS Dri-Fit® Sidelite Rails				Standard Finishes \$					Custom Finishes \$	
				101	108/109	503/599	600/601	700/701	999	Cladding
Profile	Ref. #	U/M	Glass Thickness	3	3	(SO)	(SO)	3	(SO)	(SO)
(25) 2-1/2" Rail Height										
SQ	234.052	Ft.	3/8"	33	43	99	117	69	64	150
SQ	234.046	Ft.	1/2" & 9/16"	37	48	111	131	78	72	167
SQ	234.232	Ft.	5/8" & 11/16"	37	48	111	131	78	72	167
SQ	234.233	Ft.	3/4" & 13/16"	37	48	111	131	78	72	167
TP	234.230	Ft.	3/8"	33	43	99	117	69	64	150
TP	234.231	Ft.	1/2" & 9/16"	37	48	111	131	78	72	167
TP	234.134	Ft.	5/8" & 11/16"	37	48	111	131	78	72	167
TP	234.135	Ft.	3/4" & 13/16"	37	48	111	131	78	72	167
(358) 3-5/8" Rail Height										
SQ	225.200	Ft.	3/8"	32	39	84	101	59	53	131
SQ	225.201	Ft.	1/2" & 9/16"	41	41	93	110	68	62	140
SQ	225.100	Ft.	5/8" & 11/16"	41	41	93	110	68	62	140
SQ	225.209	Ft.	3/4" & 13/16"	41	41	93	110	68	62	140
TP	225.203	Ft.	3/8"	33	41	87	104	62	55	135
TP	225.202	Ft.	1/2" & 9/16"	41	41	93	110	68	62	140
(4) 4" Rail Height										
SQ	225.050	Ft.	3/8"	32	39	84	101	59	53	131
SQ	225.049	Ft.	1/2" & 9/16"	41	41	93	110	68	62	140
TP	225.204	Ft.	3/8"	33	41	87	104	62	55	135
TP	225.205	Ft.	1/2" & 9/16"	41	41	93	110	68	62	140
(6) 6" Rail Height										
SQ	225.224	Ft.	3/8"	37	49	106	110	78	71	144
SQ	225.225	Ft.	1/2" & 9/16"	46	58	115	119	87	80	153
SQ	225.094	Ft.	5/8" & 11/16"	46	58	115	119	87	80	153
SQ	225.095	Ft.	3/4" & 13/16"	46	58	115	119	87	80	153
(10) 10" Rail Height										
SQ	225.048	Ft.	3/8"	53	61	168	175	129	89	228
SQ	225.047	Ft.	1/2" & 9/16"	59	68	188	196	144	100	255
SQ	225.184	Ft.	5/8" & 11/16"	59	68 (SO)	188	196	144	100	255
SQ	225.185	Ft.	3/4" & 13/16"	59	68 (SO)	188	196	144	100	255

3 Standard or Non-Standard Fabricated; lead time up to 3 business days.
 (SO) Special Fabricated/Finish or Special Order; lead time up to 5 weeks.

DRS Rails, Channels & Accessories
 Patch Fittings & Designer Pivots
 Offset Hung Patch Fittings
 Headers & Accessories
 Closers & Hardware
 Locksets
 Pulls & Handles
 Sliding Systems
 MANET
 Panic Hardware

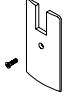
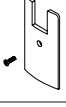
DRS Dri-Fit® Sidelite Rail Options and Accessories

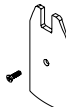
				Finishes \$			
				101/109	503/599/600/601	500/501	Custom
Model	Ref. #	U/M	Description	③	⑤0	③	⑤0
2-1/2" Square Sidelite Rail End Caps							
	934.050	Ea.	Anodized 3/8"-9/16"	17	—	—	50
	934.051	Ea.	Cladded 3/8"-9/16"	—	39	34	—
	934.046	Ea.	Anodized 5/8"-13/16"	17	—	—	50
	934.047	Ea.	Cladded 5/8"-13/16"	—	39	34	—
2-1/2" Tapered Sidelite Rail End Caps							
	934.048	Ea.	Anodized 3/8"-9/16"	17	—	—	50
	934.049	Ea.	Cladded 3/8"-9/16"	—	39	34	—
	934.044	Ea.	Anodized 5/8"-13/16"	17	—	—	50
	934.045	Ea.	Cladded 5/8"-13/16"	—	39	34	—
DRS Sidelite Rail End Caps							
	925.033	Ea.	3-5/8" (92 mm)	13	31	28	40
			Anodized and Cladded Square End Cap 3/8"-9/16" Glass				
	925.533	Ea.	3-5/8" (92 mm)	13	31	28	40
			Anodized and Cladded Square End Cap 5/8"-13/16" Glass				
	925.034	Ea.	3-5/8" (92 mm)	13	31	28	40
			Anodized and Cladded Tapered End Cap 3/8"-9/16" Glass				
	925.733	Ea.	4" (102 mm)	13	31	28	40
			Anodized and Cladded Square End Cap 3/8"-9/16" Glass				
	925.743	Ea.	4" (102 mm)	13	—	—	40
			Anodized Tapered End Cap 3/8"-9/16" Glass				
	925.740	Ea.	4" (102 mm)	—	31	28	—
			Cladded Tapered End Cap 3/8"-9/16" Glass				
Model	U/M	Ref. #	Description	List \$			
SADDLE 1/8 (3 mm)	Ft.	928.050	Saddle for 1/8" height	N/C			
SADDLE 3/8 (10 mm) and 1/2 (12 mm)	Ft.	925.051	Saddle for 3/8" and 1/2" height	N/C			
SADDLE 1/4 (6 mm) and 3/4 (19 mm)	Ft.	925.049	Saddle for 1/4" and 3/4" height	N/C			
LSDL	Ft.	—	Less saddle per ft	Deduct 5			
MITER	Ea.	—	Miter cut charge	61			
				Net Add \$			
POWDER	All Custom powder coated orders will include a net charge per purchase order.						200

③ Standard or Non-Standard Fabricated; lead time up to 3 business days.
 ⑤0 Special Fabricated/Finish or Special Order; lead time up to 5 weeks.

NOTES:

- If saddle is purchased individually, saddle is \$7 list per ft.
- Prices shown above are for saddles supplied with sidelite. Specify sidelite rail cut length, glass thickness, saddle height, and finish when ordering.
- Cut length of sidelite rail does not include end caps.
- Allow 3/16" per end cap ordered.
- Endcaps NOT included, please specify quantity required per sidelite.
- Saddle, gasket, and setting block included with each sidelite.
- Pricing per sidelite is per foot (ft).
- Maximum length for sidelite is 144" (3.7 m) before requiring splice/joint; 120" (3 m) for brass or bronze finish.

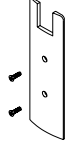
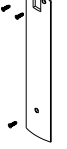
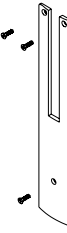

				Finishes \$			
				101/109	503/599/600/601	500/501	Custom
Model	Ref. #	U/M	Description	3	50	3	50
	925.028	Ea.	Anodized 6" (152 mm) Square End Cap 3/8"-9/16" Glass	55	—	—	81
	925.526	Ea.	Cladded 6" (152 mm) Square End Cap 3/8"-9/16" Glass	—	62	60	—
	925.528	Ea.	Anodized 6" (152 mm) Square End Cap 5/8"-13/16" Glass	55	—	—	81
	925.527	Ea.	Cladded 6" (152 mm) Square End Cap 5/8"-13/16" Glass	—	62	60	—
	925.934	Ea.	Anodized 10" (254 mm) Square End Cap (Rails) 3/8"-9/16" Glass	68	—	—	111
	925.922	Ea.	Cladded 10" (254 mm) Square End Cap 3/8"-9/16" Glass	—	85	82	—
				101	109		
				3	50		
	925.921	Ea.	Anodized or Cladded 10" (254 mm) Square End Cap (Rails) 5/8"-13/16" Glass	88	88	105	102
							137
							Net Add \$
POWDER	All Custom powder coated orders will include a net charge per purchase order						200









NOTES:



- 3-5/8" SQ End Cap available Select Service in 101, 108, and 700; 4" SQ End Cap available in 101 and 700.
- End caps not available in true stainless steel. 500/501 Satin/Polished Chrome end caps supplied when 700/701 finish rails are ordered.

DRS Rails, Channels & Accessories
Patch Fittings & Designer Pivots
Offset Hung Patch Fittings
Headers & Accessories
Closers & Hardware
Locksets
Pulls & Handles
Sliding Systems
MANET
Panic Hardware

Glazing and Dri-Fit® U-Channels and Sidelite Accessories

			Standard Finishes \$				Custom Finishes \$		
Ref. #	U/M	Description	103				999		
Glazing U-Channel			(SO)				(SO)		
	925.059	Ft. 1" x 1" U-Channel bright silver anodized	6				25		
	925.060	Ft. 1" x 2" U-Channel bright silver anodized	9				29		

			Standard Finishes \$					Custom Finishes \$		
Ref. #	U/M	Description	101	108/109	113	503/599	600/601	700/701	999	Plating
			3	(SO)	3	(SO)	(SO)	3	(SO)	(SO)
Dri-Fit® Channel for 3/8" and 1/2" Glass (Gasket required for all Dri-Fit U-Channel and priced separately)										
	925.071	Ft. 1" x 1" Dri-Fit Anodized (Gasket Required)	5	6	12	—	—	—	25	—
	925.071	Ft. Cladded (Gasket Required)	—	—	—	25	32	17	—	41
	925.072	Ft. 1" x 1-3/4" Dri-Fit Anodized (Gasket Required)	7	8	14	—	—	—	27	—
	925.072	Ft. Cladded (Gasket Required)	—	—	—	30	40	23	—	51
Dri-Fit® Channel for 5/8" and 3/4" Glass										
	925.371	Ft. 1-1/4" x 1" Dri-Fit Anodized (Gasket Required)	7	7	14	—	—	—	27	—
	925.371	Ft. Cladded (Gasket Required)	—	—	—	26	33	19	—	43
	925.372	Ft. 1-1/4" x 1-3/4" Dri-Fit Anodized (Gasket Required)	8	8	16	—	—	—	28	—
	925.372	Ft. Cladded (Gasket Required)	—	—	—	29	39	22	—	51
					113					
Dri-Fit® Channel for 3/8" and 1/2" Glass with mounting holes pre-drilled					3					
	925.447	Ft. 1" x 1" Dri-Fit Anodized (Gasket Required)	10	10	13	—	—	—	—	—
	925.448	Ft. 1" x 1-3/4" Dri-Fit Anodized (Gasket Required)	11	11	15	—	—	—	—	—
Dri-Fit® Channel for 5/8" and 3/4" Glass with mounting holes pre-drilled										
	925.445	Ft. 1-1/4" x 1" Dri-Fit Anodized (Gasket Required)	10	10	13	—	—	—	—	—
	925.446	Ft. 1-1/4" x 1-3/4" Dri-Fit Anodized (Gasket Required)	11	11	15	—	—	—	—	—

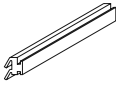
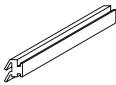
	Ref. #	U/M	Description	803 (Black)	807 (Grey)					
Dri-Fit® Channel End Cap (Snap Fit)										
	925.121	Ea.	End cap for both 1" x 1" and 1" x 1-3/4" (Gasket Required)	5 ^①	5 ^①	—	—	—	—	—
	925.122	Ea.	End cap for both 1-1/4" x 1" and 1-1/4" x 1-3/4" (Gasket Required)	5 ^(SO)	5 ^(SO)	—	—	—	—	—
Dri-Fit® Channel Gasket (Gasket is required for Dri-Fit U-Channel and requires 2-1 length vs. U-channel)										List \$
										③
	925.075	Ft.	Gasket for Vertical Stiles, 3/8" and 5/8" Glass							3
	925.148		Gasket for DRS Rail, Sidelite Rails, and Dri-fit® U-Channel, 3/8" and 5/8" Glass							3
	925.076	Ft.	Gasket for Vertical Stiles, 1/2" and 3/4" Glass							3
	925.147		Gasket for DRS Rail, Sidelite Rails, and Dri-fit® U-Channel, 1/2" and 3/4" Glass							3
MITER	Miter cut charge									61
										Net Add \$
POWDER	All Custom powder coated orders will include a net charge per purchase order									200













- ① Non-Fabricated item, ships in 1 business day.
- ③ Standard or Non-Standard Fabricated; lead time up to 3 business days.
- (SO) Special Fabricated/Finish or Special Order; lead time up to 5 weeks.

NOTES:

- Must specify length when ordering. dormakaba will cut to specified size, priced per foot (Ft.) only.
- Maximum length for extrusion is 144" (3.7 m) before requiring splice/joint; 120" (3 m) for brass or bronze finish.

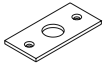

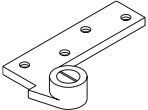
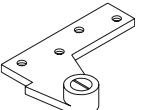

- DRS Rails, Channels & Accessories
- Patch Fittings & Designer Pivots
- Offset Hung Patch Fittings
- Headers & Accessories
- Closers & Hardware
- Locksets
- Pulls & Handles
- Sliding Systems
- MANET
- Panic Hardware

DRS Accessories

Model	Ref. #	U/M	Description	List \$				
DRS Rail Locks								
	925.019	Ea.	Brass Lock 1-9/16" 5/8" Throw					36 ^①
	925.119	Ea.	Bottom Rail Brass Door Lock 1-9/16" (7/8" long throw fully retracted projects 1/4" below lock base)					50 ^①
	925.018	Ea.	Brass Lock 1-15/16" 5/8" Throw. Not for use with DRS Rails. Requires 1-15/16" lock height clearance in rail.					38 ^①
	934.018	Ea.	Brass Door Lock, 1-9/16" (5/8" Throw) Modified for 2-1/2" Rail Only					72 ^③
	934.017	Ea.	Bottom Rail Brass Door Lock 1-9/16" (7/8" long throw fully retracted projects 1/4" below lock base) Modified for 2-1/2" Rail Only					84 ^③
	925.021	Ea.	Extended Lock Bolt 7/8" Throw					14 ^①
	925.022	Ea.	Square Lock Bolt					6 ^{SO}
				101	109	500/501	503/599	600/601
	932.033	Ea.	Dust Proof Strike Overall Length 1-1/2"	26 ^①	26 ^①	26 ^①	26 ^{SO}	26 ^{SO}
	925.140	Ea.	Strike Plate	7 ^①	7 ^①	8 ^①	8 ^{SO}	7 ^{SO}
							Finishes \$	
							108	500/501
Cylinders							^①	^{SO}
	225.999	Ea.	Mortise cylinder for DRS lock, w/split ring. (If cylinder requires Master Keying, lead time is Special Order ^{SO})				19	19
	225.998	Ea.	Mortise Thumb-Turn for DRS Lock, w/split ring				19	19
	225.994	Ea.	Mortise Blank (Dummy) Cylinder for DRS Lock, w/split ring				13	13
BTS Hardware – Offset Arms and Pivots								
	929.034	Ea.	75120 3/4" Offset Top Arm (Specify Hand)				106	106
	929.019	Ea.	15120 1-1/2" Offset Top Arm (Specify Hand)				170	170

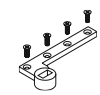
- ① Non-Fabricated item, ships in 1 business day.
- ③ Standard or Non-Standard Fabricated; lead time up to 3 business days.
- SO Special Fabricated/Finish or Special Order; lead time up to 5 weeks.

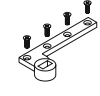
NOTE: Cylinders supplied as Keyed Different (KD). For the Cylinder and Keying Options such as KA, see **Cylinder Types, Keying Options, and Keyways**

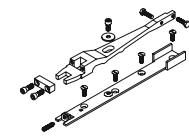
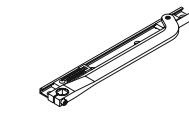
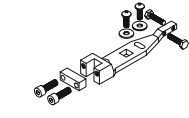
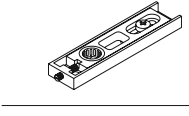
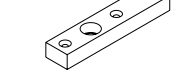
Model	Ref. #	U/M	Description	Finishes \$			
				101	108/109	503/599	500/501
BTS Hardware – Offset Arms and Pivots				①	①	⑤①	①
	229.001 229.002	LH Ea. RH Ea.	75323 3/4" Offset Bottom Arm, BTS	71	71	71	71
							
	229.011 229.012	LH Ea. RH Ea.	15323 1-1/2" Offset Bottom Arm, BTS	174	174	174	174
							
RTS88 Hardware – Arms and Pivots						①	
	228.001	Ea.	8534 7/8" End Load Top Arm, RTS			55	
	928.009	Ea.	8812 Slide Arm for RTS Independent Hung Doors			75	
	928.001	Ea.	8836S 7/8" End Load Top Arm, Glass Door Shoe, RTS			80	
	927.062	Ea.	8062LOWER CH Top Walking Beam Pivot, Rail Portion Only			25	
	927.050	Ea.	HD8062LOWER Heavy-Duty CH Walking Beam Top Pivot, Rail Portion Only			83	



DRS Options

Option	Description	List \$
HDWPREP	Prep and installation of dormakaba hardware (i.e., offset pivots, arms, magnetic lock, etc.)	75
CMP HDWP	Competitors hardware prep (charge may be reviewed based on complexity)	150
CMP HDWI	Competitors hardware preparation and installation	150
CMP SHEAR	Competitors Electro-Magnetic Shear Lock or Magnetic Lock Armature prep	250
		Net Add \$
POWDER	All Custom powder coated orders will include a net charge per purchase order.	200

- ① Non-Fabricated item, ships in 1 business day.
- ⑤① Special Fabricated/Finish or Special Order; lead time up to 5 weeks.

DRS Rails, Channels & Accessories
 Patch Fittings & Designer Pivots
 Offset Hung Patch Fittings
 Headers & Accessories
 Closers & Hardware
 Locksets
 Pulls & Handles
 Sliding Systems
 MANET
 Panic Hardware

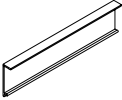
Mechanical Channel and Endcap

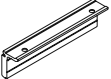
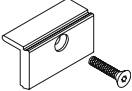
Model	Ref. #	U/M	Description	Standard Finishes \$					Custom Finishes \$
				101	108/109	503	599/600 601/602	700/701	999
Mechanical Channel Cover (No Glass Fabrication Required)				3	(SO)	(SO)	(SO)	(SO)	(SO)
	807.053	Ft.	Clip-On Cover 118" (3 m) max. length	7	12	—	—	—	—
	207.153	Ft.	Clip-On Cover 118" (3 m) max. length	—	—	18	18	16	27
Mechanical Channel Endcap									
	807.007	Ea.	Endcap 3/8" – 1/2" (10 mm – 12 mm)	18 (SO)					
	807.065	Ea.	Endcap 19/32" – 3/4" (15 mm – 19 mm)	22 (SO)					
Mechanical Channel Base (No Glass Fabrication Required)				100					
				3					
	807.051	Ft.	3/8" (10 mm) Base mechanical channel and clamps	64					
	807.055	Ft.	1/2" (12 mm) Base mechanical channel and clamps	64					
	807.057	Ft.	(15 mm) Base mechanical channel and clamps	66					
	807.059	Ft.	3/4" (19 mm) Base mechanical channel and clamps	66					
Mechanical Channel Clamp Brackets				3					
	807.004	Ea.	3/8" (10 mm)	20					
	807.085	Ea.	1/2" (12 mm)	20					
	807.089	Ea.	3/4" (19 mm)	25					
	807.087	Ea.	(15 mm)	25					
									Net Add \$
POWDER	All Custom powder coated orders will include a net charge per purchase order.								200

3 Standard or Non-Standard Fabricated; lead time up to 3 business days.
 (SO) Special Fabricated/Finish or Special Order; lead time up to 5 weeks.

- NOTES:**
- Base mechanical channel includes clamp brackets, first foot pulls two clamps and each remaining foot pulls one clamp per foot.
 - Mechanical channel is not recommended for use with laminated glass.

Center Hung Patch Fittings and Designer Pivots

	Select Service	38
Center Hung Patch Fittings	Center Hung Patch Fittings/Transom, Sidelite, and Fin Patch Fittings	42
	Connectors	46
	Accessories	49
	Options	50
	Standard Sets	52
Designer Pivots	ARCOS Patch Fittings/Transom, Sidelite, and Fin Patch Fittings	53
	Mechanical Channel	55
	TENSOR Designer Pivot/Hinge	56
	VISUR Designer Pivot	57
	BEYOND Pinch-Free Pivot	58

DRS Rails, Channels & Accessories

Patch Fittings & Designer Pivots

Offset Hung Patch Fittings

Headers & Accessories

Closers & Hardware

Locksets

Pulls & Handles

Sliding Systems

MANET

Panic Hardware

Select Service Quick Ship — Patch Fittings and Designer Pivots

Select service should be used for small quantities of popular dormakaba products that require shipment within 24 hours. The program includes patch fittings, DRS rails, headers, concealed closers and pivots, and pulls and handles. Warehouses have been set up in the east and west for faster delivery nationwide. (Customer responsible for shipping costs FOB.)

Subject to Availability

Next Business Day Service (Shipment when Purchase Order is received prior to 4:00 PM EST).

Examples: dormakaba receives P.O. at 3:59 PM on Monday, order will ship by close of business on Tuesday. dormakaba receives P.O. at 3:59 PM on Friday, order will ship by close of business on the following Monday.

Notes:

- Standard freight and discount schedules and terms of sale apply. Please refer to the current price list for full details.
- dormakaba reserves the right to limit quantities or decline an order if the credit status of the buyer is not satisfactory to dormakaba.
- Orders cannot be cancelled.
- Select Service Quick Ship available only in the United States.
- All prices are in U.S. dollars.
- Products and prices are subject to change without notice.
- Limited quantities available.

Key

<input checked="" type="checkbox"/>	"New" to Select Service, Available in East and West Coast Warehouse
<input checked="" type="checkbox"/>	Available in East and West Coast Warehouse
<input type="checkbox"/>	Available only in East Coast Warehouse
<input type="checkbox"/>	Available only in West Coast Warehouse

Patch Fittings and Designer Pivots

3/8"-1/2" Glass

2-3/4" (70 mm) pivot location

PN #	Warehouse	Product	Description	Location	Glass	Finish	List \$
33900050	■	PT20	Use with PT21 WBP	Top patch	1/2"	101	61
33900053	⌚	PT20	Use with PT21 WBP	Top patch	1/2"	108	74
33900051	■	PT20	Use with PT21 WBP	Top patch	1/2"	700	83
33900052	⌚	PT20	Use with PT21 WBP	Top patch	1/2"	701	83
33900054	⌚	PT20	Use with PT21 WBP	Top patch	1/2"	600	140
33900055	■	PT22	Use with RTS	Top patch	1/2"	101	69
33900058	⌚	PT22	Use with RTS	Top patch	1/2"	108	83
33900056	■	PT22	Use with RTS	Top patch	1/2"	700	90
33900057	⌚	PT22	Use with RTS	Top patch	1/2"	701	90
33900059	⌚	PT22	Use with RTS	Top patch	1/2"	600	148
33900045	■	PT10	Use with BTS, 7471K, or 355.5	Bottom patch	1/2"	101	65
33900048	⌚	PT10	Use with BTS, 7471K, or 355.5	Bottom patch	1/2"	108	78
33900046	■	PT10	Use with BTS, 7471K, or 355.5	Bottom patch	1/2"	700	87
33900047	⌚	PT10	Use with BTS, 7471K, or 355.5	Bottom patch	1/2"	701	87
33900049	⌚	PT10	Use with BTS, 7471K, or 355.5	Bottom patch	1/2"	600	143
33900080	■	PT20	Use with PT21 WBP	Top patch	3/4"	101	103
33900083	⌚	PT20	Use with PT21 WBP	Top patch	3/4"	108	123
33900081	■	PT20	Use with PT21 WBP	Top patch	3/4"	700	127
33900082	⌚	PT20	Use with PT21 WBP	Top patch	3/4"	701	127
33900084	⌚	PT20	Use with PT21 WBP	Top patch	3/4"	600	199
33900085	■	PT22	Use with RTS	Top patch	3/4"	101	110
33900088	⌚	PT22	Use with RTS	Top patch	3/4"	108	132
33900086	■	PT22	Use with RTS	Top patch	3/4"	700	134
33900087	⌚	PT22	Use with RTS	Top patch	3/4"	701	134
33900089	⌚	PT22	Use with RTS	Top patch	3/4"	600	206
33900075	■	PT10	Use with BTS, 7471K, or 355.5	Bottom patch	3/4"	101	106
33900078	⌚	PT10	Use with BTS, 7471K, or 355.5	Bottom patch	3/4"	108	127
33900076	■	PT10	Use with BTS, 7471K, or 355.5	Bottom patch	3/4"	700	130
33900077	⌚	PT10	Use with BTS, 7471K, or 355.5	Bottom patch	3/4"	701	130
33900079	⌚	PT10	Use with BTS, 7471K, or 355.5	Bottom patch	3/4"	600	202

- DRS Rails, Channels & Accessories
- Patch Fittings & Designer Pivots
- Offset Hung Patch Fittings
- Headers & Accessories
- Closers & Hardware
- Locksets
- Pulls & Handles
- Sliding Systems
- MANET
- Panic Hardware

Patch Fittings consist of one of:

Qty	UM	HDW	PT10		PT20		PT22	
			3/8"-1/2"	5/8"-3/4"	3/8"-1/2"	5/8"-3/4"	3/8"-1/2"	5/8"-3/4"
1	Set	Fitting	33900217	33900203	33900217	33900203	33900217	33900203
1	Set	Covers	339001xx + finish*	339001xx + finish*	339001xx + finish*	339001xx + finish*	339001xx + finish*	339001xx + finish*
1	Ea.	End Covers	—	339002xx + finish*	—	339002xx + finish*	—	339002xx + finish*
1	Ea.	Insert	33900204	33900204	33900201	33900201	33900200	33900200

* See below for finish codes

Qty	UM	HDW	3/8"-5/8"		1/2"-3/4"		3/8"-5/8"		1/2"-3/4"	
			33900205	33900159	33900205	33900159	33900205	33900159		
1	Set	Gasket	33900205	33900159	33900205	33900159	33900205	33900159	33900205	33900159

Patch Fitting Accessories
PT20, PT22, PT10 (5/8", 3/4", and other glass options)

PN #	Warehouse	Model	Description	Glass	Finish	List \$
33900203	■	Fitting	Fitting only, door / transom PT10, PT20, PT22	5/8" & 3/4"	—	56
33900217	■	Fitting	Fitting only PT10, PT20, PT22	3/8" & 1/2"	—	28
33900101	■	Cover, Fitting	Cover for PT10, PT20, PT22	All	101	22
33900104	□	Cover, Fitting	Cover for PT10, PT20, PT22	All	108	42
33900102	■	Cover, Fitting	Cover for PT10, PT20, PT22	All	700	45
33900103	□	Cover, Fitting	Cover for PT10, PT20, PT22	All	701	45
33900201	■	Insert 319.2	Insert, PT20	All	—	16
33900200	■	Insert 355.41	Insert, PT22	All	—	25
33900204	■	Insert 319.1	Insert, PT10	All	—	20
33900219	■	Cover, End	Cover for end of fitting, PT10, PT20, PT22	5/8" & 3/4"	700	34
33900159	■	Gasket	Gasket for PT10, PT20, PT22	1/2"-3/4"	—	4
33900205	■	Gasket	Gasket for PT10, PT20, PT22	3/8" & 5/8"	—	5

DRS Rails,
Channels &
Accessories

Patch Fittings
& Designer
Pivots

Offset
Hung Patch
Fittings

Headers &
Accessories

Closers &
Hardware

Locksets

Pulls &
Handles

Sliding
Systems

MANET

Panic
Hardware

Center Hung Patch Fittings, Complete

2-3/4" (70 MM) Pivot Center Line

Type A, BP, and F Doors

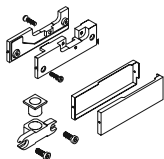
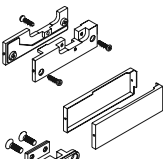
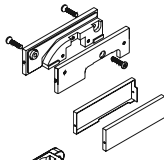

Model	Ref. #	U/M	Description	Standard Finishes \$					Custom Finishes \$	
				101	108/109	503/599	600/601	700/701	999	Cladding
Top Patch PT20 (PT21, 325.6, or 319.3)				3	3	SO	SO	3	SO	SO
 <p>End Cover 5/8" & 3/4"</p>	833.310	Ea.	3/8" (10 mm)	61	74	105	140	83	101	182
	833.110	Ea.	1/2" (12 mm)	61	74	105	140	83	101	182
	833.311	Ea.	5/8" (15 mm)	103	123	145	199	127	143	259
	833.111	Ea.	3/4" (19 mm)	103	123	145	199	127	143	259
Top Patch PT22 (RTS)										
 <p>End Cover 5/8" & 3/4"</p>	833.312	Ea.	3/8" (10 mm)	69	83	112	148	90	109	192
	833.112	Ea.	1/2" (12 mm)	69	83	112	148	90	109	192
	833.313	Ea.	5/8" (15 mm)	110	132	152	206	134	150	268
	833.113	Ea.	3/4" (19 mm)	110	132	152	206	134	150	268
Bottom Patch PT10 (BTS, 7471K, or 355.5)										
 <p>End Cover 5/8" & 3/4"</p>	833.300	Ea.	3/8" (10 mm)	65	78	108	143	87	105	186
	833.100	Ea.	1/2" (12 mm)	65	78	108	143	87	105	186
	833.301	Ea.	5/8" (15 mm)	106	127	148	202	130	146	263
	833.101	Ea.	3/4" (19 mm)	106	127	148	202	130	146	263

Patch Fitting Options	Net Add \$
POWDER All Custom powder coated orders will include a net charge per purchase order.	200

- 3 Standard or Non-Standard Fabricated; lead time up to 3 business days.
- SO Special Fabricated/Finish or Special Order; lead time up to 5 weeks.

NOTES:

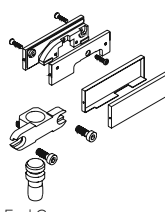
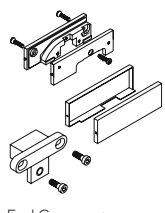
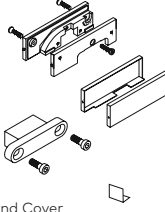
- Patch fitting covers for bronze finish are bronze plating over brass base metal.
- For 5/8" and 3/4" thick glass, a relief cut to the hole preparation will be required.

Model	Ref. #	U/M	Description	Standard Finishes \$					Custom Finishes \$	
				101	108/109	503/599	600/601	700/701	999	Cladding
Transom Patch PT30 with Pivot (319.3)				(SO)	(SO)	(SO)	(SO)	(SO)	(SO)	(SO)
 <p>End Cover 5/8" & 3/4"</p>	833.330	Ea.	3/8" (10 mm)	75	90	120	155	96	115	202
	833.131	Ea.	1/2" (12 mm)	75	90	120	155	96	115	202
	833.321	Ea.	5/8" (15 mm)	116	139	160	214	152	156	278
	833.121	Ea.	3/4" (19 mm)	116	139	160	214	152	156	278
Transom Patch PT30 with Stop (355.42)										
 <p>End Cover 5/8" & 3/4"</p>	833.332	Ea.	3/8" (10 mm)	75	90	120	155	96	115	202
	833.132	Ea.	1/2" (12 mm)	75	90	120	155	96	115	202
	833.333	Ea.	5/8" (15 mm)	116	139	160	214	152	156	278
	833.133	Ea.	3/4" (19 mm)	116	139	160	214	152	156	278
Transom Patch PT30 with Blank (355.43)										
 <p>End Cover 5/8" & 3/4"</p>	833.334	Ea.	3/8" (10 mm)	72	87	117	150	91	112	195
	833.134	Ea.	1/2" (12 mm)	72	87	117	150	91	112	195
	833.335	Ea.	5/8" (15 mm)	112	134	157	204	147	152	265
	833.135	Ea.	3/4" (19 mm)	112	134	157	204	147	152	265
Wall Plate					3 / (SO)			3 / (SO)		
	903.128	Ea.	Wall Plate	20	28 / 28	67	67	67 / 73		
	Wall Anchor or Threaded Rod									
	901.133	Ea.	Wall Anchor							List \$ 11
	901.134	Ea.	Threaded Rod Anchor							15

Patch Fitting Options			Net Add \$
POWDER	All Custom powder coated orders will include a net charge per purchase order.		200

- 3 Standard or Non-Standard Fabricated; lead time up to 3 business days.
- (SO) Special Fabricated/Finish or Special Order; lead time up to 5 weeks.

NOTES:

- Patch fitting covers for bronze finish are bronze plating over brass base metal.
- For 5/8" and 3/4" thick glass, a relief cut to the hole preparation will be required.

DRS Rails, Channels & Accessories

Patch Fittings & Designer Pivots

Offset Hung Patch Fittings

Headers & Accessories

Closers & Hardware

Locksets

Pulls & Handles

Sliding Systems

MANET

Panic Hardware

Center Hung Patch Fittings, Complete

2-3/4" (70 MM) Pivot Center Line

Type A, BP, and F Doors

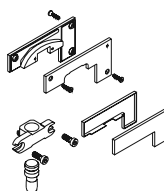
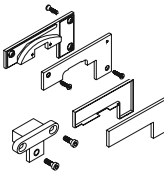
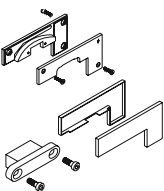
Model	Ref. #	U/M	Description	Standard Finishes \$					Custom Finishes \$	
				101	108/109	503/599	600/601	700/701	999	Cladding
Transom/Sidelite Patch Fitting PT40 with Pivot (319.3)				(SO)	(SO)	(SO)	(SO)	(SO)	(SO)	(SO)
	833.343	Ea.	3/8" (10 mm)	112	135	177	184	159	152	239
	833.143	Ea.	1/2" (12 mm)	112	135	177	184	159	152	239
	833.344	Ea.	5/8" (15 mm)	128	154	208	223	190	168	290
	833.144	Ea.	3/4" (19 mm)	128	154	208	223	190	168	290
End Cover 5/8" & 3/4"										
Transom/Sidelite Patch Fitting PT40 with Stop (355.42)										
	833.336	Ea.	3/8" (10 mm)	112	135	177	184	159	152	239
	833.136	Ea.	1/2" (12 mm)	112	135	177	184	159	152	239
	833.337	Ea.	5/8" (15 mm)	128	154	208	223	190	168	290
	833.137	Ea.	3/4" (19 mm)	128	154	208	223	190	168	290
End Cover 5/8" & 3/4"										
Transom/Sidelite Patch Fitting PT40 with Blank (355.43)										
	833.338	Ea.	3/8" (10 mm)	108	130	173	180	155	148	202
	833.138	Ea.	1/2" (12 mm)	108	130	173	180	155	148	202
	833.339	Ea.	5/8" (15 mm)	123	148	204	219	186	163	242
	833.139	Ea.	3/4" (19 mm)	123	148	204	219	186	163	242
End Cover 5/8" & 3/4"										
Patch Fitting Options										
POWDER	All Custom powder coated orders will include a net charge per purchase order.									Net Add \$ 200

3 Standard or Non-Standard Fabricated; lead time up to 3 business days.

(SO) Special Fabricated/Finish or Special Order; lead time up to 5 weeks.

NOTES:

- Patch fitting covers for bronze finish are bronze plating over brass base metal.
- For 5/8" and 3/4" thick glass, a relief cut to the hole preparation will be required.

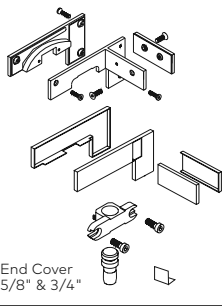
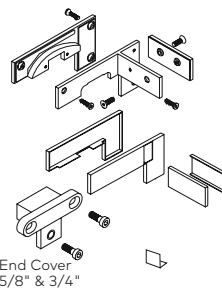
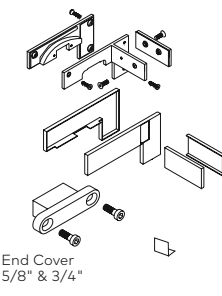
Model	Ref. #	U/M	Description	Standard Finishes \$					Custom Finishes \$	
				101	108/109	503/599	600/601	700/701	999	Cladding
Transom/Sidelite/Fin Patch Fitting PT41 with Pivot (319.3)				(SO)	(SO)	(SO)	(SO)	(SO)	(SO)	(SO)
 <p>End Cover 5/8" & 3/4"</p>	833.355	LH Ea.	3/8" (10 mm)	277	333	365	365	344	337	475
	833.354	RH Ea.	3/8" (10 mm)	277	333	365	365	344	337	475
	833.155	LH Ea.	1/2" (12 mm)	277	333	365	365	344	337	475
	833.154	RH Ea.	1/2" (12 mm)	277	333	365	365	344	337	475
	833.356	LH Ea.	5/8" (15 mm)	346	415	449	457	428	406	594
	833.357	RH Ea.	5/8" (15 mm)	346	415	449	457	428	406	594
	833.156	LH Ea.	3/4" (19 mm)	346	415	449	457	428	406	594
	833.157	RH Ea.	3/4" (19 mm)	346	415	449	457	428	406	594
Transom/Sidelite/Fin Patch Fitting PT41 with Stop (355.42)										
 <p>End Cover 5/8" & 3/4"</p>	833.391	LH Ea.	3/8" (10 mm)	277	333	365	365	344	337	475
	833.393	RH Ea.	3/8" (10 mm)	277	333	365	365	344	337	475
	833.191	LH Ea.	1/2" (12 mm)	277	333	365	365	344	337	475
	833.193	RH Ea.	1/2" (12 mm)	277	333	365	365	344	337	475
	833.392	LH Ea.	5/8" (15 mm)	346	415	449	457	428	406	594
	833.394	RH Ea.	5/8" (15 mm)	346	415	449	457	428	406	594
	833.192	LH Ea.	3/4" (19 mm)	346	415	449	457	428	406	594
	833.194	RH Ea.	3/4" (19 mm)	346	415	449	457	428	406	594
Transom/Sidelite/Fin Patch Fitting PT41 with Blank (355.43)										
 <p>End Cover 5/8" & 3/4"</p>	833.395	LH Ea.	3/8" (10 mm)	273	329	361	361	340	333	471
	833.397	RH Ea.	3/8" (10 mm)	273	329	361	361	340	333	471
	833.195	LH Ea.	1/2" (12 mm)	273	329	361	361	340	333	471
	833.197	RH Ea.	1/2" (12 mm)	273	329	361	361	340	333	471
	833.396	LH Ea.	5/8" (15 mm)	342	411	445	453	424	402	590
	833.398	RH Ea.	5/8" (15 mm)	342	411	445	453	424	402	590
	833.196	LH Ea.	3/4" (19 mm)	342	411	445	453	424	402	590
	833.198	RH Ea.	3/4" (19 mm)	342	411	445	453	424	402	590
Patch Fitting Options										List \$
NSTDFIN	Custom Fins may be available; other than 1/2" (12 mm), verify with Customer Service.									150
										Net Add \$
POWDER	All Custom powder coated orders will include a net charge per purchase order.									200

(SO) Special Fabricated/Finish or Special Order; lead time up to 5 weeks.

NOTES:

- LH shown above.
- Patch fitting covers for bronze finish are bronze plating over brass base metal.
- All fins are designed for 1/2" glass. Verify with Customer Service to determine if available for other than 1/2" (12 mm).
- **Limited** quantities available for 3 business day lead-time. Verify availability at time of order.
- For 5/8" and 3/4" thick glass, a relief cut to the hole preparation will be required.

DRS Rails, Channels & Accessories
Patch Fittings & Designer Pivots
Offset Hung Patch Fittings
Headers & Accessories
Closers & Hardware
Locksets
Pulls & Handles
Sliding Systems
MANET
Panic Hardware

Transom and Sidelite Connectors, Complete

2-3/4" (70 MM) Pivot Center Line

Type A, BP, and F Doors

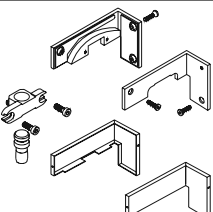
Model	Ref. #	U/M	Description	Standard Finishes \$				Custom Finishes \$	
				101	108/109	503	700/701	999	Cladding
Transom/90° Sidelite Patch Fitting PT42-90 with Pivot, (319.3)				(SO)	(SO)	(SO)	(SO)	(SO)	(SO)
	833.164	LH Ea.	1/2" (12 mm)	780	829	—	904	900	1,217
	833.165	RH Ea.	1/2" (12 mm)	780	829	—	904	900	1,217

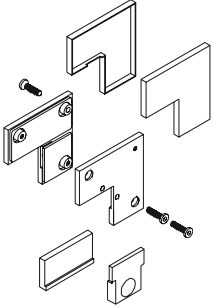
Transom/Sidelite Connector PT60-61 with Stop and Blank Insert, (323.5)									
	803.150	Ea.	3/8" (10 mm)	58	69	117	98	100	195
	803.150	Ea.	1/2" (12 mm)	58	69	117	98	100	195
	803.452	Ea.	5/8" (15 mm)	74	88	132	113	116	215
	803.452	Ea.	3/4" (19 mm)	74	88	132	113	116	215
			Specify thickness		(108 only)				
			Specify thickness		(108 only)				

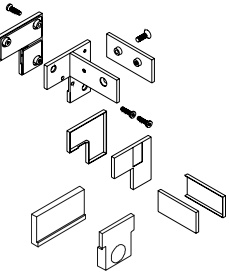
Transom/Sidelite/Fin Connector PT60-61 (Specify Thickness)									
	803.158	LH Ea.	3/8" (10 mm)	58	69	—	98	121	195
	803.157	RH Ea.	3/8" (10 mm)	58	69	—	98	121	195
	803.158	LH Ea.	1/2" (12 mm)	58	69	—	98	121	195
	803.157	RH Ea.	1/2" (12 mm)	58	69	—	98	121	195

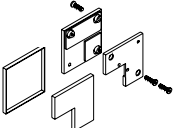
Transom/Sidelite/Stop Connector PT62									
	803.173	Ea.	3/8" (10 mm)	102	—	—	168	142	289
	803.173	Ea.	1/2" (12 mm)	102	—	—	168	142	289

Patch Fitting Options			List \$
NSTDFIN	Custom Fins may be available; other than 1/2" (12 mm), verify with Customer Service.		150
			Net Add \$
POWDER	All Custom powder coated orders will include a net charge per purchase order.		200

(SO) Special Fabricated/Finish or Special Order; lead time up to 5 weeks.

- NOTES:**
- All fins are designed for 1/2" glass. Verify with Customer Service to determine if available for other than 1/2" (12 mm).
 - For 5/8" and 3/4" thick glass, a relief cut to the hole preparation will be required.

Transom and Sidelite Connector Fittings, Complete

Type A, BP, and F Doors

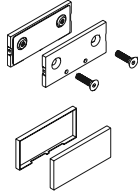
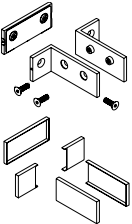
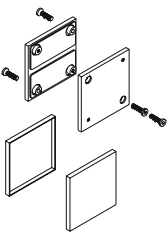
Model	Ref. #	U/M	Description	Standard Finishes \$				Custom Finishes \$	
				101	108/109	503/599	700/701	999	Cladding
Transom Connector PT70 with 2 Ea. Stops/Blanks				(SO)	(SO)	(SO)	(SO)	(SO)	(SO)
	801.150	Ea.	3/8" (10 mm)	65	78	95	87	105	124
	801.150	Ea.	1/2" (12 mm)	65	78	95	87	105	124
	801.158	Ea.	5/8" (15 mm)	90	108	120	112	130	156
	801.158	Ea.	3/4" (19 mm)	90	108	120	112	130	156
			Specify Thickness						
			Specify Thickness						
Transom/Fin Connector PT71									
	801.161	Ea.	3/8" (10 mm)	423	—	591	544	483	1,110
	801.161	Ea.	1/2" (12 mm)	423	—	591	544	483	1,110
Sidelite Patch Fitting PT80									
	803.170	Ea.	3/8" (10 mm)	72	—	—	107	112	202
	803.170	Ea.	1/2" (12 mm)	72	—	—	107	112	202
	803.472	Ea.	5/8" (15 mm)	97	—	—	132	137	234
	803.472	Ea.	3/4" (19 mm)	97	—	—	132	137	234
			Specify Thickness						
			Specify Thickness						
Patch Fitting Options									List \$
NSTDFIN	Custom Fins may be available; other than 1/2" (12 mm), verify with Customer Service.								150
Net Add \$									
POWDER	All Custom powder coated orders will include a net charge per purchase order.								200

(SO) Special Fabricated/Finish or Special Order; lead time up to 5 weeks.

NOTES:

- All fins are designed for 1/2" glass. Verify with Customer Service to determine if available for other than 1/2" (12 mm).
- For 5/8" and 3/4" thick glass, a relief cut to the hole preparation will be required.

DRS Rails, Channels & Accessories
Patch Fittings & Designer Pivots
Offset Hung Patch Fittings
Headers & Accessories
Closers & Hardware
Locksets
Pulls & Handles
Sliding Systems
MANET
Panic Hardware

Connector Fittings, Complete

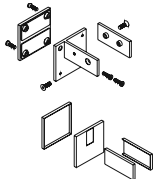
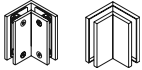
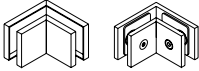
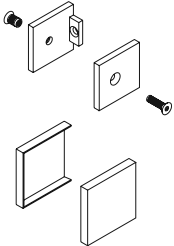
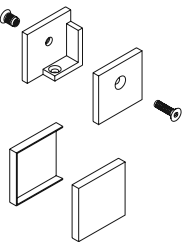



Model	Ref. #	U/M	Description	Standard Finishes \$			Custom Finishes \$		
				101	108/109	700/701	999	Cladding	
Connector/Fin Fitting PT81				(S0)	(S0)	(S0)	(S0)	(S0)	
	803.175	Ea.	3/8" (10 mm)	320	—	366	380	523	
	803.175	Ea.	1/2" (12 mm)	320	—	366	380	523	
90° Angled Connector PT80-90									
	803.171	Ea.	3/8" (10 mm)	380	426 (108 only)	431	420	615	
	803.171	Ea.	1/2" (12 mm)	380	426 (108 only)	431	420	615	
90° Angled Connector PT80-90 Short									
	803.470	Ea.	3/8" (10 mm)	312	375 (108 only)	396	352	744	
	803.470	Ea.	1/2" (12 mm)	312	375 (108 only)	396	352	744	
Edge Fitting PT90									
	807.021	Ea.	3/8" (10 mm)	27	32 (108 only)	59	67	88	
	807.021	Ea.	1/2" (12 mm)	27	32 (108 only)	59	67	88	
	807.210	Ea.	5/8" (15 mm) Specify Thickness	52	62 (108 only)	84	92	121	
	807.210	Ea.	3/4" (19 mm) Specify Thickness	52	62 (108 only)	84	92	121	
Corner Fitting PT91									
	807.023	Ea.	3/8" (10 mm)	38	45 (108 only)	70	78	103	
	807.023	Ea.	1/2" (12 mm)	38	45 (108 only)	70	78	103	
	807.211	Ea.	5/8" (15 mm) Specify Thickness	63	75 (108 only)	95	103	135	
	807.211	Ea.	3/4" (19 mm) Specify Thickness	63	75 (108 only)	95	103	135	
Patch Fitting Options								List \$	
NSTDFIN	Custom Fins may be available; other than 1/2" (12 mm), verify with Customer Service.								150
								Net Add \$	
POWDER	All Custom powder coated orders will include a net charge per purchase order.								200

- ③ Standard or Non-Standard Fabricated; lead time up to 3 business days.
- (S0) Special Fabricated/Finish or Special Order; lead time up to 5 weeks.

NOTES:

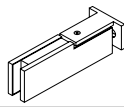
- All fins are designed for 1/2" glass. Verify with Customer Service to determine if available for other than 1/2" (12 mm).
- For 5/8" and 3/4" thick glass, a relief cut to the hole preparation will be required.

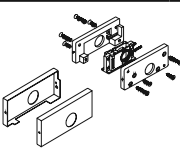
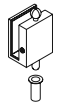
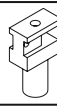
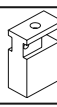
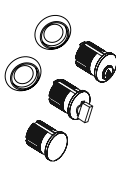
Connectors, Complete, and Accessories

Model	Ref. #	U/M	Description	Standard Finishes \$				Custom Finishes \$	
				101	108/109	503/599	700/701	999	Cladding
Top Patch Fitting PT29 with Wall Mount Pivot Fixing Plate				(SO)	(SO)	(SO)	(SO)	(SO)	(SO)
	833.314	Ea.	3/8" (10 mm)	209	250	312	—	249	406
	833.109	Ea.	1/2" (12 mm)	209	250	312	—	249	406
NOTE: 2-3/16" (55mm) Pivot Center Line Location. Bottom Pivot Must Use Same Pivot Point!									
	801.153	Ea.	3/8" (10 mm)	159	190	247	219	199	321
	801.153	Ea.	1/2" (12 mm)	159	190	247	219	199	321
Patch Lock Fitting AR20 Type F Door				3	3		3		
	801.124	Ea.	3/8" (10 mm)	97	119	177	147	137	230
	801.122	Ea.	1/2" (12 mm)	97	119	177	147	137	230
	801.126	Ea.	5/8" (15 mm)	172	194	252	222	212	328
	801.125	Ea.	3/4" (19 mm)	172	194	252	222	212	328
Slide-On Bolt, 3/8" (10 mm) glass only				(SO)					
	912.302	Ea.	3/4" (19 mm)	92	—	—	—	—	—
Extended Bolt, 7/8" Throw				3					
	925.021	Ea.	Extended Bolt, 7/8" (22 mm) Throw	14	—	—	—	—	—
NOTE: When fully retracted, bolt will remain extended 1/4" (6 mm).									
Extended Bolt, 7/8" Throw				(SO)					
	925.022	Ea.	Square Bolt	6	—	—	—	—	—
								Standard Finishes \$	
								108	500/501
Cylinders for Patch Fitting Brass Lock								(1)	(SO)
	225.997	Ea.	Mortise cylinder for Patch Fitting lock, w/split ring if cylinder requires master keying lead time goes to Special Order (SO).					19	19
	225.996	Ea.	Mortise Thumbturn for Patch Fitting Lock, w/split ring					19	19
	225.995	Ea.	Mortise Blank (Dummy) Cylinder for Patch Fitting Lock, w/split ring					13	13
								Finishes \$	
Model	Ref. #	U/M	Description	101	109	500/501	503/599	600/601	
	932.033	Ea.	Dust Proof Strike Overall Length 1-1/2" (38 mm)	26 (1)	26 (1)	26 (1)	26 (SO)	26 (SO)	



- (1) Non-Fabricated item, ships in 1 business day.
- (3) Standard or Non-Standard Fabricated; lead time up to 3 business days.
- (SO) Special Fabricated/Finish or Special Order; lead time up to 5 weeks.

- NOTES:**
- All fins are designed for 1/2" glass. Verify with Customer Service to determine if available for other than 1/2" (12 mm).
 - For 5/8" and 3/4" thick glass, a relief cut to the hole preparation will be required.

DRS Rails, Channels & Accessories
Patch Fittings & Designer Pivots
Offset Hung Patch Fittings
Headers & Accessories
Closers & Hardware
Locksets
Pulls & Handles
Sliding Systems
MANET
Panic Hardware

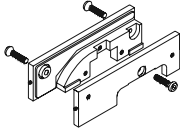
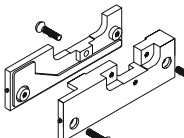
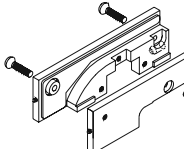
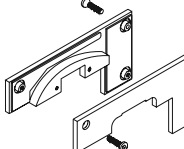
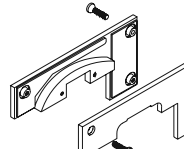
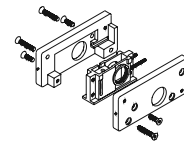
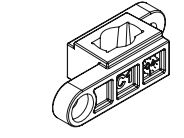
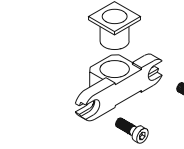
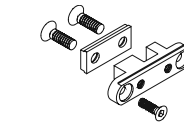
Center Hung Patch Fitting Options

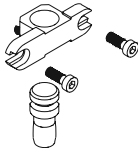
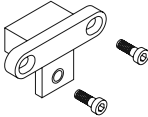
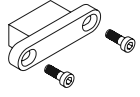
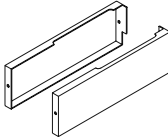
	Ref. #	Model	Description	Standard Finishes \$				
				101	108	700/701	600	No Finish
	903.997	317.12	Fitting for PT10, PT20, PT22, 3/8" (10 mm), or 1/2" (12 mm) glass	—	—	—	—	28
	903.308	317.19	Fitting for PT10, PT20, PT22, PT30, 5/8" (15 mm), or 3/4" (19 mm) glass	—	—	—	—	56
	903.998	317.35	Fitting for PT30, 3/8" (10 mm), or 1/2" (12 mm) glass	—	—	—	—	28
	903.309	317.412	Fitting for PT40, 3/8" (10 mm), or 1/2" (12 mm) glass	—	—	—	—	64
	903.310	317.419	Fitting for PT40, 5/8" (15 mm), or 3/4" (19 mm) glass	—	—	—	—	64
	901.123	351.3	AR20 Patch lock Fitting, 3/8", 1/2", 5/8", or 3/4" glass	—	—	—	—	90
	903.105	319.1	Insert for PT10. Use with BTS, 7471K, or 355.5	—	—	—	—	20
	903.111	319.2	Insert for PT20. Use with PT21, PT24, or PT30 with Pivot 319.3	—	—	—	—	16
	903.999	355.41	Insert for PT22 by RTS, Sideload	—	—	—	—	25

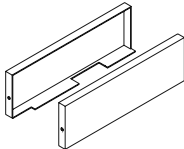
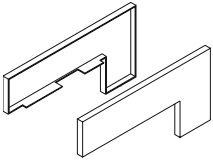
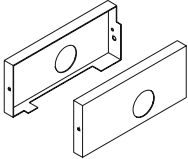
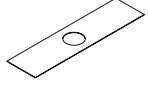
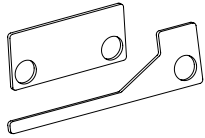
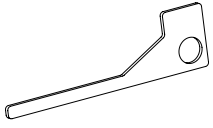
	903.125	319.3	Insert with pivot 319.3 for PT30, PT40, PT41, PT42	—	—	—	—	20	DRS Rails, Channels & Accessories	
Standard Finishes \$										
	Ref. #	Model	Description	101	108/109	700/701	600	No Finish		
	903.127	355.42	Insert with stop for PT30, PT40, PT41	—	—	—	—	20	Patch Fittings & Designer Pivots	
	903.126	355.43	Insert with blank for PT30, PT40, PT41	—	—	—	—	16	Offset Hung Patch Fittings	
	903.104	340.1	Cover, patch fitting,. Use with PT10, PT20, PT22	22	42	45	103	—	Headers & Accessories	
	903.025	317.19	Cover, end angle, all PT10, PT20, PT22 x 5/8 (15 mm) or 3/4" (19 mm) glass	16	18	34	N/A	—	Closers & Hardware	
	903.124	340.5	Cover, patch fitting. Use with PT30	23	44	47	N/A	—	Locksets	
	903.144	340.4	Cover, patch fitting. Use with PT40	36	109	86	N/A	—	Pulls & Handles	
	903.261	351.4	Cover, AR20 patch lock fitting	90	101	138	N/A	—	Sliding Systems	
	903.023	—	Cover, all PT30, PT40, PT41 x 5/8" (15 mm) or 3/4" (19 mm) glass	16	18	34	N/A	—	MANET	
	903.140	—	Gasket 3 mm for use with PT10, PT20, PT22, PT30, PT40 fittings x 1/2" (12 mm) or 3/4" (19 mm) glass	—	—	—	—	4		
	903.014	—	Gasket 2 mm for use with PT10, PT20, PT22, PT30, PT40 fittings x 3/8" (10 mm) or 5/8" (15 mm) glass	—	—	—	—	5		
Patch Fitting Options								Net Add \$		
POWDER								All Custom powder coated orders will include a net charge per purchase order.	200	Panic Hardware

Standard Center Hung Patch Fitting Set for Door

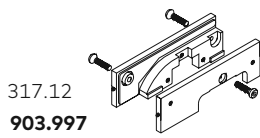

317.12
903.997
Fitting, 3/8" (10 mm or 1/2" (12 mm) glass, PT10, PT20, PT22

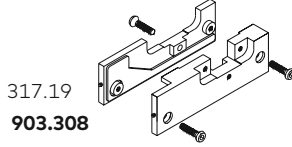

317.19
903.308
Fitting, 5/8" (15 mm) or 3/4" (19 mm) glass, PT10, PT20, PT22

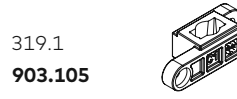

319.1
903.105
Insert fitting, PT10 x BTS, 7471K or 355.5

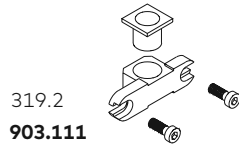

319.2
903.111
Insert fitting, PT20 x PT21

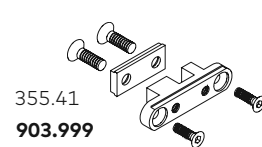

355.41
903.999
Insert fitting, PT22 x RTS

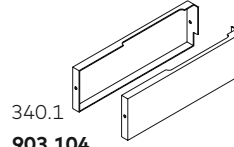

340.1
903.104
Patch fitting cover, all glass thicknesses, PT10, PT20, PT22

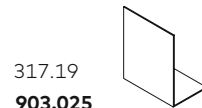

317.19
903.025
End cover, requested for 5/8" (15 mm) or 3/4" (19 mm) glass thicknesses, PT10, PT20, PT22

Standard Center Hung Patch Fitting Set for Transom

PT30 Patch Fitting Guide

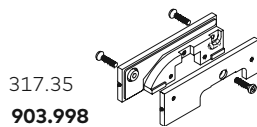

317.35
903.998
Fitting, 3/8" (10 mm) or 1/2" (12 mm) glass, PT30

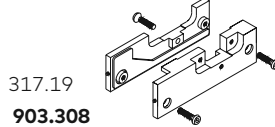

317.19
903.308
Fitting, 5/8" (15 mm) or 3/4" (19 mm) glass, PT30

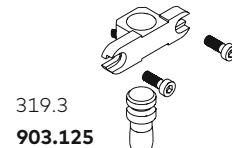

319.3
903.125
Insert fitting, PT30 x PT20

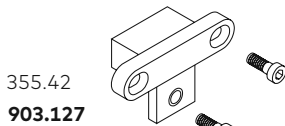

355.42
903.127
Insert fitting, PT30 when used as stop

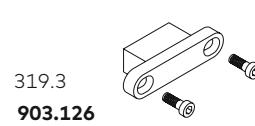

319.3
903.126
Insert fitting, PT30 x double acting door

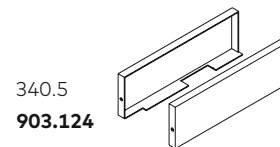

340.5
903.124
Patch fitting cover, all glass thicknesses, PT30

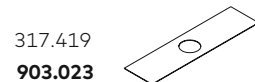









317.419
903.023
Cover PT30, 40, 41 5/8", 3/4" glass for 5/8" (15 mm) or 3/4" (19 mm) glass thicknesses, PT30

ARCOS Center Hung Patch Fittings, Complete

2-3/16" (55 MM) Pivot Center Line





Type A, BP, and F Doors

Model	Ref. #	U/M	Description	Standard Finishes \$			Custom Finishes \$		
				114	108/109	700/701	999	Cladding	
Top Patch PT20 ARCOS (8062, 325.6, or 319.3)				(SO)	(SO)	(SO)	(SO)	(SO)	
	826.110	Ea.	3/8" (10 mm)	162	227	257	202	360	
	833.210	Ea.	1/2" (12 mm)	162	227	257	202	360	
Top Patch PT22 ARCOS (RTS)									
	826.112	Ea.	3/8" (10 mm)	254	356	363	294	508	
	833.208	Ea.	1/2" (12 mm)	254	356	363	294	508	
Bottom Patch PT10 ARCOS (BTS, 7471K, or 355.5)									
	826.100	Ea.	3/8" (10 mm)	165	231	260	205	364	
	833.200	Ea.	1/2" (12 mm)	165	231	260	205	364	
Transom Patch PT30 ARCOS with Pivot (319.3)									
	826.120	Ea.	3/8" (10 mm)	169	237	263	209	368	
	833.220	Ea.	1/2" (12 mm)	169	237	263	209	368	
Transom Patch PT30 ARCOS with Stop (355.42)									
	826.420	Ea.	3/8" (10 mm)	169	237	263	209	368	
	833.222	Ea.	1/2" (12 mm)	169	237	263	209	368	
Transom Patch PT30 ARCOS with Blank (355.43)									
	826.421	Ea.	3/8" (10 mm)	165	231	260	205	364	
	833.223	Ea.	1/2" (12 mm)	165	231	260	205	364	
Wall Plate				3	3 / (SO)	3 / (SO)			
	903.128	Ea.	Wall Plate	20	28 / 28	67 / 73			
Wall Anchor or Threaded Rod								List \$	
	901.133	Ea.	Wall Anchor					11	
	901.134	Ea.	Threaded Rod Anchor					15	
Patch Fitting Options								Net Add \$	
POWDER	All Custom powder coated orders will include a net charge per purchase order.								200

NOTES:

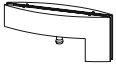
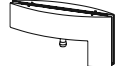
- All fins are designed for 1/2" glass. Verify with Customer Service to determine if available for other than 1/2" (12 mm).
- For 5/8" and 3/4" thick glass, a relief cut to the hole preparation will be required.

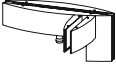
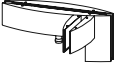
DRS Rails, Channels & Accessories
Patch Fittings & Designer Pivots
Offset Hung Patch Fittings
Headers & Accessories
Closers & Hardware
Locksets
Pulls & Handles
Sliding Systems
MANET
Panic Hardware

Model	Ref. #	U/M	Description	Standard Finishes \$			Custom Finishes \$	
				114	108/109	700/701	999	Cladding
Transom/Sidelite Patch Fitting PT40 ARCOS with Pivot (319.3)				(SO)	(SO)	(SO)	(SO)	(SO)
	826.140	Ea.	3/8" (10 mm)	222	310	363	262	508
	833.240	Ea.	1/2" (12 mm)	222	310	363	262	508
Transom/Sidelite Patch Fitting PT40 ARCOS with Stop (355.42)								
	826.440	Ea.	3/8" (10 mm)	222	310	363	262	508
	833.241	Ea.	1/2" (12 mm)	222	310	363	262	508
Transom/Sidelite Patch Fitting PT40 ARCOS with Blank (355.43)								
	826.441	Ea.	3/8" (10 mm)	219	308	359	259	503
	833.242	Ea.	1/2" (12 mm)	219	308	359	259	503
Transom/Sidelite/Fin Patch Fitting PT41 ARCOS with Pivot (319.3), (LH Shown)								
	826.162	Ea.	3/8" (10 mm) LH	586	820	835	646	1,169
	826.163	Ea.	3/8" (10 mm) RH	586	820	835	646	1,169
	833.245	Ea.	1/2" (12 mm) LH	586	820	835	646	1,169
	833.246	Ea.	1/2" (12 mm) RH	586	820	835	646	1,169
Transom / Sidelite / Fin Patch Fitting PT41 ARCOS with Stop (355.42), (LH Shown)								
	826.262	Ea.	3/8" (10 mm) LH	586	820	835	646	1,169
	826.263	Ea.	3/8" (10 mm) RH	586	820	835	646	1,169
	833.248	Ea.	1/2" (12 mm) LH	586	820	835	646	1,169
	833.249	Ea.	1/2" (12 mm) RH	586	820	835	646	1,169
Transom / Sidelite / Fin Patch Fitting PT41 ARCOS with Blank (355.43), (LH Shown)								
	826.264	Ea.	3/8" (10 mm) LH	586	820	835	646	1,169
	826.265	Ea.	3/8" (10 mm) RH	586	820	835	646	1,169
	833.250	Ea.	1/2" (12 mm) LH	586	820	835	646	1,169
	833.251	Ea.	1/2" (12 mm) RH	586	820	835	646	1,169

Patch Fitting Options

Net Add \$

POWDER

All Custom powder coated orders will include a **net charge** per purchase order.



200

- ③ Standard or Non-Standard Fabricated; lead time up to 3 business days.
- Ⓢ Special Fabricated/Finish or Special Order; lead time up to 5 weeks.

NOTES:

- All fins are designed for 1/2" glass. Verify with Customer Service to determine if available for other than 1/2" (12 mm).
- For 5/8" and 3/4" thick glass, a relief cut to the hole preparation will be required.

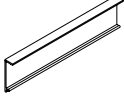
Mechanical Channel and Endcap

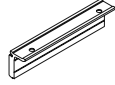
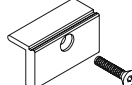
Model	Ref. #	U/M	Description	Standard Finishes \$					Custom Finishes \$
				101	108/109	503	599/600 601/602	700/701	999
Mechanical Channel Cover (No Glass Fabrication Required)				3	(SO)	(SO)	(SO)	(SO)	(SO)
	807.053	Ft.	Clip-On Cover 118" (3 m) max. length	7	12	—	—	—	—
	207.153	Ft.	Clip-On Cover 118" (3 m) max. length	—	—	18	18	16	27
Mechanical Channel Endcap									
	807.007	Ea.	Endcap 3/8" - 1/2" (10 mm - 12 mm)	18	(SO)				
	807.065	Ea.	Endcap 19/32" - 3/4" (15 mm - 19 mm)	22	(SO)				
Mechanical Channel Base (No Glass Fabrication Required)				100					
				3					
	807.051	Ft.	3/8" (10 mm) Base mechanical channel and clamps	64					
	807.055	Ft.	1/2" (12 mm) Base mechanical channel and clamps	64					
	807.057	Ft.	(15 mm) Base mechanical channel and clamps	66					
	807.059	Ft.	3/4" (19 mm) Base mechanical channel and clamps	66					
Mechanical Channel Clamp Brackets				3					
	807.004	Ea.	3/8" (10 mm)	20					
	807.085	Ea.	1/2" (12 mm)	20					
	807.089	Ea.	3/4" (19 mm)	25					
				(SO)					
	807.087	Ea.	(15 mm)	25					
Net Add \$									
POWDER	All Custom powder coated orders will include a net charge per purchase order.								200

3 Standard or Non-Standard Fabricated; lead time up to 3 business days.
(SO) Special Fabricated/Finish or Special Order; lead time up to 5 weeks.

- NOTES:**
- Base mechanical channel includes clamp brackets, first foot pulls two clamps and each remaining foot pulls one clamp per foot.
 - Mechanical channel is not recommended for use with laminated glass.

DRS Rails, Channels & Accessories
 Patch Fittings & Designer Pivots
 Offset Hung Patch Fittings
 Headers & Accessories
 Closers & Hardware
 Locksets
 Pulls & Handles
 Sliding Systems
 MANET
 Panic Hardware

TENSOR Designer Pivot/Hinge

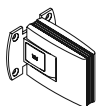
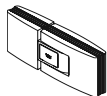
Model	Ref. #	U/M	Description	Finishes \$		
				114	113	122
TENSOR Glass to Wall				(SO)	3	(SO)
	812.520	Pr.	3/8" (10 mm)	1,134	1,161	1,255
	812.520	Pr.	1/2" (12 mm)	1,134	1,161	1,255
TENSOR Glass to Glass				(SO)		
	812.523	Pr.	3/8" (10 mm)	1,492	1,541	1,453
	812.523	Pr.	1/2" (12 mm)	1,492	1,541	1,453

3 Standard or Non-Standard Fabricated; lead time up to 3 business days.
 (SO) Special Fabricated/Finish or Special Order; lead time up to 5 weeks.

VISUR Designer Pivot

Center Hung Double-Acting All-Glass Door System
Safe pinch-free glass door operation for 3/8" and 1/2" (10 mm and 12 mm) glass

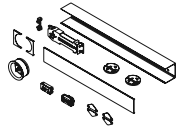
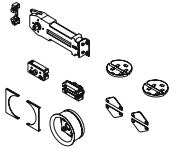
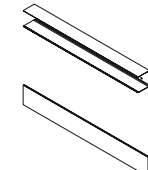
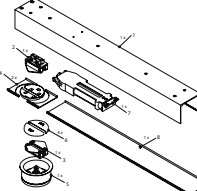
Model	Ref. #	U/M	Description	Finish \$	
VISUR Complete Sets				①	
	803.770	Set	DORMA VISUR complete set for single door includes header tube, RTS 88, top and bottom pivot. Please indicate finished opening width.	1,700	
	803.771	Set	DORMA VISUR complete set for pair of doors includes header tube, RTS 88, top and bottom pivot. Please indicate finished opening width.	3,400	
VISUR Components					
	803.772	Ea.	DORMA VISUR set composed of RTS 88, top and bottom pivot.	1,145	
	803.773	Ea.	DORMA VISUR set composed of top and bottom pivot (without RTS 88).	845	
	803.775	Ea.	DORMA VISUR header tube profile for single door. Max. 43-3/8" (1100 mm) door panel width. Please indicate finished opening width.	222	
	803.776	Ea.	DORMA VISUR header tube profile for pair of doors. Max. 2 x 43-3/8" (1100 mm) door panel width. Please indicate finished opening width.	448	
	803.777	Ea.	DORMA VISUR header tube cover profile for single door. Max. 43-3/8" (1100 mm) in fixed length door panel width. Please indicate finished opening width.	117	
	803.778	Ea.	DORMA VISUR header tube cover profile for pair of doors. Max. 2 x 43-3/8" (1100 mm), in fixed length door panel width. Please indicate finished opening width.	178	
	803.779	Ea.	DORMA VISUR header tube profile in stock length 125-15/16" (3200 mm).	633	
	803.780	Ea.	DORMA VISUR header tube profile in stock length 157" (4000 mm).	305	
	803.785	Ea.	cover profile parts for RTS, 3-1/2" (90 mm), top	17	
	803.786	Ea.	Bottom bearing housing with cover ring	408	
	803.784	Ea.	Cover caps, bottom	38	
	List \$				
	803.783	Ea.	Glass clamp, top	179	
	803.782	Ea.	Glass clamp, bottom	146	
Door Stops					
	926.870	Ea.	Decorative floor stop with bumper (619 only, equivalent to 700)	① 50	

① Non-Fabricated item, ships in 1 business day.







② Special Fabricated/Finish or Special Order; lead time up to 5 weeks.

NOTE: For Visur with RTS, specify 90° or 105°, HO or NHO, and spring size

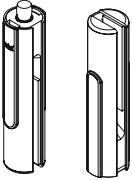
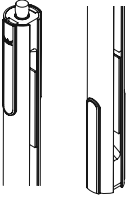
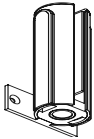
DRS Rails, Channels & Accessories
 Patch Fittings & Designer Pivots
 Offset Hung Patch Fittings
 Headers & Accessories
 Closers & Hardware
 Locksets
 Pulls & Handles
 Sliding Systems
 MANET
 Panic Hardware

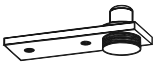
BEYOND Pinch-Free Pivot

Center Hung Double-Acting All-Glass Door System
 Safe pinch-free glass door operation for 3/8" and 1/2" (10 mm and 12 mm) glass

Model	Ref. #	U/M	Description	Finishes \$	
				114	107
BEYOND Basic Pivot Set – Short				(SO)	(SO)
	Pivoting fitting set, short type, consists of: 1 top pivot fitting with pivot 15 mm dia., 1 bottom pivot fitting with insert for DORMA floor closer spindle or round pivot (ordered separately)				
	830.100	Set	3/8" (10 mm)	561	685
	830.101	Set	1/2" (12 mm)	561	—
BEYOND Basic Pivot Set – Long					
	Pivoting fitting, long type, with pivot dia. 15 mm at top and insert for DORMA floor closer spindle or round pivot at bottom (ordered separately). Please indicate "exact door height = glass measurement" with order.				
	830.110	Set	3/8" (10 mm)	634	772
	830.111	Set	1/2" (12 mm)	634	—
BEYOND Components					
	BEYOND Transom fitting, wall connector with plastic socket for top pivot				
	830.120	Ea.	3/8" (10 mm)	266	324
	830.121	Ea.	1/2" (12 mm)	278	—
	BEYOND Transom fitting, glass connector with plastic socket for top pivot				
	830.130	Ea.	3/8" (10 mm)	271	331
	830.131	Ea.	1/2" (12 mm)	271	—
				List \$	
BEYOND Components					(SO)
	901.106 .001	Ea.	Adjustable Floor Pivot 5/16" (8 mm) to 1/2" (12 mm) (no cover)		61
BEYOND Glass Connector					109
	830.320	Ea.	BEYOND glass connector for connection of sidelite at closing side 3/8" (10 mm) and 1/2" (12 mm)		39
Bearings and Bushings					List \$
	901.130	Ea.	Top pivot bearing (aluminum)		39
	805.194	Ea.	Eccentric socket, adjustable		39
	901.107	Ea.	Floor Bearing		71

(SO) Special Fabricated/Finish or Special Order; lead time up to 5 weeks.

Offset Hung Patch Fittings

Patch Fittings	For Single-Acting 1-1/16" (43 mm) Offset Hung Doors	60
	For Single-Acting 3/8" (10 mm), and 1/2" (12 mm) Offset Hung Doors	63

NOTE: Refer to pages 77-94 for Closers and Hardware.

- DRS Rails, Channels & Accessories
- Patch Fittings & Designer Pivots
- Offset Hung Patch Fittings**
- Headers & Accessories
- Closers & Hardware
- Locksets
- Pulls & Handles
- Sliding Systems
- MANET
- Panic Hardware

1-11/16" (43 mm) Doors

Type A and F Doors – 3/8" (10 mm) and 1/2" (12 mm) Thick Glass

Offset Patch Fittings, Complete				Standard Finishes \$		Custom Finishes \$		
Model	Ref. #	U/M	Description	101	108/109	501	503	107
Top of Door, Offset Patch Fitting 312.1				(SO)	(SO)	(SO)	(SO)	(SO)
	902.110	Ea.	LHR (Shown)	238	340	595	542	338
	902.111	Ea.	RHR	238	340	595	542	338
Bottom of Door, Offset Patch Fitting 311.1								
	902.100	Ea.	LHR (Shown)	246	352	604	580	350
	902.101	Ea.	RHR	246	352	604	580	350
Transom, Offset Pivot Fitting 326.1								
	902.120	Ea.	LHR (Shown)	265	379	611	553	377
	902.121	Ea.	RHR	265	379	611	553	377
Transom/ Sidelite, Offset Pivot Fitting 327.1								
	902.140	Ea.	LHR (Shown)	311	448	650	591	445
	902.141	Ea.	RHR	311	448	650	591	445
Wall Anchor or Threaded Rod								List Add \$
	901.133	Ea.	Wall Anchor					11
	901.134	Ea.	Threaded Rod Anchor					15

(SO) Special Fabricated/Finish or Special Order; lead time up to 5 weeks.

NOTES:

- Handing for angle of fin fittings viewed from outside and above as shown in diagram.
- Please specify glass thickness when ordering.

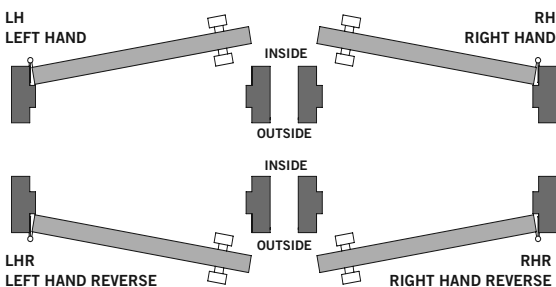

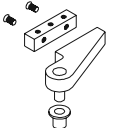
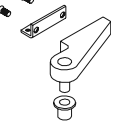
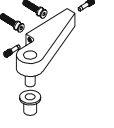
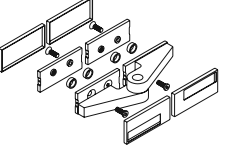
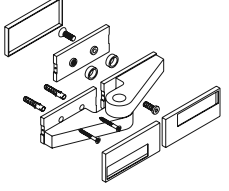
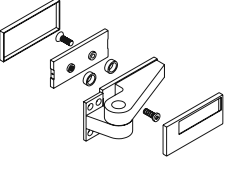
Offset Patch Fittings, Complete				Standard Finishes \$		Custom Finishes \$		
Model	Ref. #	U/M	Description	101	108/109	501	503	107
Frame Mount Offset Patch Fitting 339.1				(SO)	(SO)	(SO)	(SO)	(SO)
	902.150	Ea.		141	205	366	333	293
Frame Mount Offset Patch Fitting 339.2								
	902.151	Ea.		141	205	366	333	293
Frame Mount Offset Patch Fitting 339.3								
	902.152	Ea.	LHR	141	205	366	333	293
	902.153	Ea.	RHR	141	205	366	333	293
Glass Door to Glass Sidelite Offset Patch Fitting 312.4								
	902.200	Ea.	LHR (Shown)	522	747	1,013	920	742
	902.201	Ea.	RHR	522	747	1,013	920	742
Wall to Glass Door Offset Patch Fitting 312.5								
	902.202	Ea.	LHR (Shown)	522	747	1,013	920	742
	902.203	Ea.	RHR	522	747	1,013	920	742
Wall to Glass Door Offset Patch Fitting 312.6								
	902.204	Ea.	LHR (Shown)	522	747	1,013	920	742
	902.205	Ea.	RHR	522	747	1,013	920	742

(SO) Special Fabricated/Finish or Special Order; lead time up to 5 weeks.

NOTES:

- Handing for angle of fin fittings viewed from outside and above as shown in diagram.
- USA HANDING SHOWN (OPPOSITE EUROPEAN HANDING).
- Please specify glass thickness when ordering.

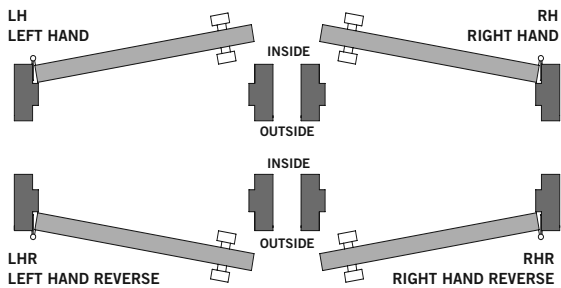

DRS Rails, Channels & Accessories
Patch Fittings & Designer Pivots
Offset Hung Patch Fittings
Headers & Accessories
Closers & Hardware
Locksets
Pulls & Handles
Sliding Systems
MANET
Panic Hardware

Offset Patch Fittings, Complete				Standard Finishes \$		Custom Finish \$	
Model	Ref. #	U/M	Description	101	108/109	501	503
Top of Door Offset Patch Fitting 312.2 Type A & F shortened 19/32" (15 mm) side only				(S0)	(S0)	(S0)	(S0)
	902.112	Ea.	3/8" (10 mm) glass LHR	238	340	595	542
	902.113	Ea.	3/8" (10 mm) glass RHR	238	340	595	542
	902.164	Ea.	1/2" (12 mm) glass LHR	238	340	595	542
	902.165	Ea.	1/2" (12 mm) glass RHR	238	340	595	542
Bottom of Door Offset Patch Fitting 311.2 Type A & F shortened 19/32" (15 mm) side only							
	902.102	Ea.	3/8" (10 mm) glass LHR	246	352	604	580
	902.103	Ea.	3/8" (10 mm) glass RHR	246	352	604	580
	902.160	Ea.	1/2" (12 mm) glass LHR	246	352	604	580
	902.161	Ea.	1/2" (12 mm) glass RHR	246	352	604	580
Wall to Glass Door Offset Patch Fitting 312.7 Type A & F shortened 19/32" (15 mm) side only							
	902.206	Ea.	3/8" (10 mm) glass LHR	522	747	1,013	920
	902.207	Ea.	3/8" (10 mm) glass RHR	522	747	1,013	920
	902.170	Ea.	1/2" (12 mm) glass LHR	522	747	1,013	920
	902.171	Ea.	1/2" (12 mm) glass RHR	522	747	1,013	920
Top of Door Offset Patch Fitting 312.3 Type A & F shortened 19/32" (15 mm) top and side							
	902.114	Ea.	3/8" (10 mm) glass LHR	238	340	595	542
	902.115	Ea.	3/8" (10 mm) glass RHR	238	340	595	542
	902.166	Ea.	1/2" (12 mm) glass LHR	238	340	595	542
	902.167	Ea.	1/2" (12 mm) glass RHR	238	340	595	542
Bottom of Door Offset Patch Fitting 311.3 Type A & F shortened 19/32" (15 mm) bottom and side							
	902.104	Ea.	3/8" (10 mm) glass LHR (Shown)	246	352	604	580
	902.105	Ea.	1/2" (12 mm) glass RHR	246	352	604	580
	902.162	Ea.	3/8" (10 mm) glass LHR	246	352	604	580
	902.163	Ea.	1/2" (12 mm) glass RHR	246	352	604	580

(S0) Special Fabricated/Finish or Special Order; lead time up to 5 weeks.

NOTES:

- Handing for angle of fin fittings viewed from outside and above as shown in diagram.
- Please specify glass thickness when ordering.

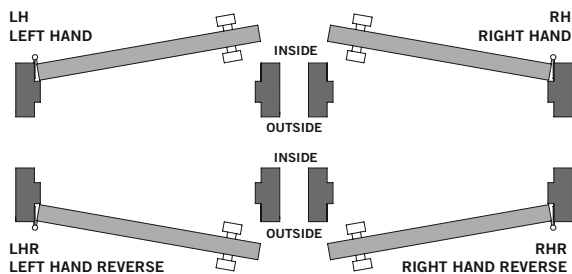

5/16" (8 mm), 3/8" (10 mm), and 1/2" (12 mm) Doors

Type A and F Doors – 3/8" (10 mm) and 1/2" (12 mm) Thick Glass

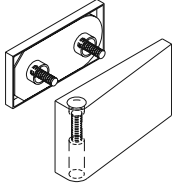
Offset Patch Fittings, Complete				Standard Finishes \$		Custom Finish \$
Model	Ref. #	U/M	Description	101	108	107
Top and Bottom of Door Offset Patch Fitting 412.1				(SO)	(SO)	(SO)
	912.040	Ea.	LHR (Shown)	231	265	312
	912.041	Ea.	RHR	231	265	312

(SO) Special Fabricated/Finish or Special Order; lead time up to 5 weeks.

NOTES:

- Handing for angle of fin fittings viewed from outside and above as shown in diagram.
- Please specify glass thickness when ordering.
- Maximum door weight 176 lb (80 kg).
- Maximum door width 43-1/4" (1100 mm).

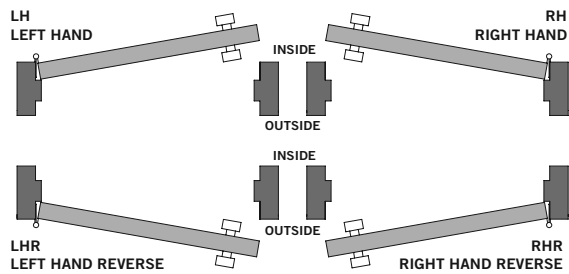

Headers and Accessories

	Select Service	66
Headers	Ordering Guide	67
	Header — Single Opening	68
	Header — Paired Opening	69
	Header Options	70
	RTS88 Options	70
	Header Accessories and Service Parts	72
Floating Header for All-Glass Entrances with Transom	Ordering Guide	75
	Floating Header — Single Opening	75
	Floating Header — Paired Opening	76
	Floating Header Accessories	76

- DRS Rails, Channels & Accessories
- Patch Fittings & Designer Pivots
- Offset Hung Patch Fittings
- Headers & Accessories
- Closers & Hardware
- Locksets
- Pulls & Handles
- Sliding Systems
- MANET
- Panic Hardware

Select Service Quick Ship – Headers and Accessories

Select service should be used for small quantities of popular dormakaba products that require shipment within 24 hours. The program includes patch fittings, DRS rails, headers, concealed closers and pivots, and pulls and handles. Warehouses have been set up in the east and west for faster delivery nationwide. (Customer responsible for shipping costs FOB.)

Subject to Availability

Next Business Day Service (Shipment when Purchase Order is received prior to 4:00 PM EST).

Examples: dormakaba receives P.O. at 3:59 PM on Monday, order will ship by close of business on Tuesday. dormakaba receives P.O. at 3:59 PM on Friday, order will ship by close of business on the following Monday.

Notes:

- Standard freight and discount schedules and terms of sale apply. Please refer to the current price list for full details.
- dormakaba reserves the right to limit quantities or decline an order if the credit status of the buyer is not satisfactory to dormakaba.
- Orders cannot be cancelled.
- Select Service Quick Ship available only in the United States.
- All prices are in U.S. dollars.
- Products and prices are subject to change without notice.
- Limited quantities available.

Key

N "New" to Select Service, Available in East and West Coast Warehouse

■ Available in East and West Coast Warehouse

E Available only in East Coast Warehouse

W Available only in West Coast Warehouse

Headers and Accessories

2-3/4" (70 mm) Pivot Location

Ref. #	Warehouse	Product	Description	Finish	List \$
33900090	W	Header	36" x 4.5" with PT21 WBP (PT21 Pre-Installed)	101	170
33900091	W	Header	36" x 4.5" with PT21 WBP (PT21 Pre-Installed)	700	284
33900092	■	Header	36" x 4.5" with RTS Prep (Prepared for RTS)	101	128
33900093	■	Header	36" x 4.5" with RTS Prep (Prepared for RTS)	700	242
33900120	■	Header	72" x 4.5" with 2 ea. PT21 WBP (PT21 Pre-Installed)	101	340
33900121	■	Header	72" x 4.5" with 2 ea. PT21 WBP (PT21 Pre-Installed)	700	568
33900122	■	Header	72" x 4.5" with 2 ea. RTS88 Prep (Prepared for RTS)	101	256
33900123	■	Header	72" x 4.5" with 2 ea. RTS88 Prep (Prepared for RTS)	700	484

NOTE: Headers x RTS Prep are prepared for RTS installation. RTS sold separately.

Headers and Accessories

Ordering Guide

Doors/Panels

None	— No Door or Panels
2D/2P	— 2 Doors, 2 Panels w/Flat Covers
2D/2GP	— 2 Doors, 2 Panels w/Glazing Pockets
2D/1P	— 2 Doors, 1 Panel w/Flat Covers
2D/1GP	— 2 Doors, 1 Panel w/Glazing Pocket
2D	— 2 Doors
1D/2P	— 1 Door, 2 Panels w/Flat Covers
1D/2GP	— 1 Door, 2 Panel w/Glazing Pockets
1D/1P	— 1 Door, 1 Panel w/Flat Covers
1D/1GP	— 1 Door, 1 Panel w/Glazing Pocket
1D	— 1 Door

Glass Thickness

3/4
5/8
3/8
1/2

Cut Length Panel Two Specify

EC2 — Pack of 2 ea. End Caps

Length Specify — Specify Length

Header Width

4-1/8	— 1-3/4" x 4-1/8"
4-1/2	— 1-3/4" x 4-1/2"
6	— 1-3/4" x 6"

Cover Options

FLTCVR	Specify — Specify Length
GLZCVR	

Cut Length Panel One

Closer Spring Size

SZ2
SZ4
BFE
BFI
SZ3

Hardware

PT21
RTS88-5MM

Standard Spindle Location

Y
N

Closer Bumper Position

90
105

Miter

2
1

Ordering Example: **HDR** _____ **1D** **FLTCVR** _____ **1/2** _____ **101** **RTS88-5MM** _____ **Y** _____ **105** **NH** **SZ3** **SHEAR** _____

Hand **Paired Hardware** **Hold/Non-Hold Open** **Shear Lock**

101 — Clear Anodized (CL)
108 — Dark Bronze (DB)
109 — Black Anodized (BK)
503 — Polished Brass w/o Lacquer (PB)
599 — Satin Brass w/o Lacquer (SB)
600 — Satin Bronze w/o Lacquer (SBZ)
601 — Polished Bronze w/o Lacquer (PB2)
700 — Satin Stainless Steel (SS/US32D)
701 — Polished Stainless Steel (PS/US32)

Standard Finish

113	— Similar to Satin Stainless (Limited Availability)
199	— Custom Anodized Finishes (Specify)
299	— Custom Cladding (Specify)
399	— Powder Coated Finishes (Specify)

Custom Finish ^{1,2}

1 dormakaba reserves the right to refuse Custom Finishes.
 2 All Custom Finishes require customer sign-off/approval of color chip.

DRS Rails, Channels & Accessories
 Patch Fittings & Designer Pivots
 Offset Hung Patch Fittings
 Headers & Accessories
 Closers & Hardware
 Locksets
 Pulls & Handles
 Sliding Systems
 MANET
 Panic Hardware

Header, Single Opening

24" (610 mm) – 48" (1219 mm)

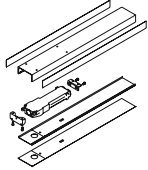
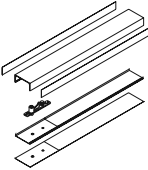
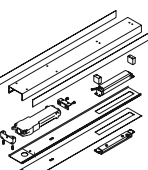
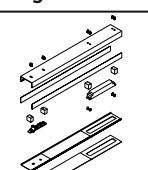
				Standard Finishes \$						Custom Finishes \$	
				101	108/109	113	503/599	600/601	700/701	199/399	299
Model	Ref. #	U/M	Description	3	3	3	SO	SO	3	SO	SO
Single with 1-RTS88 (928.3xx) Installed, Flat Cover				Single Header Base Price							
	233.018	Ea.	4-1/8" (105 mm)	344	354	375	541	676	454	504	879
	233.040	Ea.	4-1/2" (114 mm)	353	366	—	561	701	467	513	911
	233.060	Ea.	6" (152 mm)	457 SO	485 SO	—	633	713	549 SO	—	—
Single with 1-PT21 (801.117) Installed, Flat Cover											
	233.036	Ea.	4-1/8" (105 mm)	161	171	188	358	493	271	321	696
	233.044	Ea.	4-1/2" (114 mm)	170	183	—	378	518	284	330	728
	233.064	Ea.	6" (152 mm)	274 SO	302 SO	—	450	530	366 SO	—	—
Single with 1-RTS88 (928.3xx) and 1-Shear Lock (933.025) Installed, Sheer Lock Header Cap											
	233.025	Ea.	4-1/8" (105 mm)	1,634	1,644	—	1,831	1,966	1,744	1,794	2,169
	233.032	Ea.	4-1/2" (114 mm)	1,643	1,656	—	1,851	1,991	1,757	1,803	2,201
	233.068	Ea.	6" (152 mm)	1,747 SO	1,775 SO	—	1,923	2,003	1,839 SO	—	—
Single with 1-PT21 (801.117) and 1-Shear Lock (933.025) Installed											
	233.023	Ea.	4-1/8" (105 mm)	1,454	1,464	1,501	1,651	1,786	1,564	1,614	1,989
	233.043	Ea.	4-1/2" (114 mm)	1,463	1,476	—	1,671	1,811	1,577	1,623	2,021
	233.072	Ea.	6" (152 mm)	1,567	1,595	1,635	1,743	1,823	1,659	—	—
Header Options											
										List Add \$	
PANIC	Prep for Glass Panic/Deadbolt Push Bar Device in dormakaba header, manual strike.									75	
ELCK PREP	dormakaba EMSL Shearlock, or EML Magnetic Lock preparation and installation of magnet portion of lock in dormakaba header. In addition, panic prep for electric strike.									165	
HDWPREP	Prep and Install of dormakaba hardware (ie; offset pivots, arms, etc.) in dormakaba header.									75	
CMP HDWP	Competitor hardware component preparation only for dormakaba header (ie; pivots and arms). Charge may be reviewed based on complexity.									90	
CMP HDWI	Competitors hardware preparation and installation (ie; pivots and arms) in dormakaba header									150	
CMP SHEAR	Competitors Shear Lock, Magnetic Lock, Overhead Concealed Closer prep and install in dormakaba header									250	
MITER	Miter cut charge									61	
										Net Add \$	
POWDER	All Custom powder coated orders will include a net charge per purchase order.									200	

- ① Non-Fabricated item, can ship in 1 business day through Select Service Program, quantities limited.
- ③ Standard or Non-Standard Fabricated; lead time up to 3 business days.
- SO Special Fabricated/Finish or Special Order; lead time up to 5 weeks.

NOTES:

- For headers with RTS, specify 90° or 105°, HO or NHO, and spring size.
- Anodized headers are finished 4 sides, clad are finished 3 sides.
- Reference header accessories for cladding purchased separately.
- Default RTS pivot location is 2-3/4" (70 mm) centerline unless otherwise specified.
- Specify finished header length for any header above.
- End caps are optional and sold in sets of two (2) each.
- Headers requiring RTS preparation, less closers, deduct \$225 list per closer.
- Specify "LC" at the end of reference number. Example: 223.018.LC
- CMP Charges do not include cost of competitors product. Customer responsible to provide competitors products if pre-installation of competitors product is desired.

Header, Paired Opening

48" (1219 mm) – 92" (2438 mm)

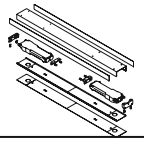
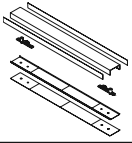
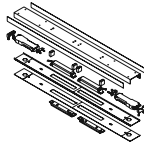
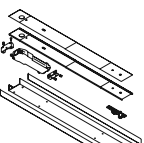
				Standard Finishes \$					Custom Finishes \$		
				101	108/109	113	503/599	600/601	700/701	199/399	299
Model	Ref. #	U/M	Description	③	③	③	(SO)	(SO)	③	(SO)	(SO)
Paired with 2-RTS88 (928.3xx) Installed, Flat Cover				Paired Header Base Price							
	233.020	Ea.	4-1/8" (105 mm)	688	708	750	1,082	1,352	908	1,008	1,758
	233.042	Ea.	4-1/2" (114 mm)	706	732	—	1,122	1,402	934	1,026	1,823
	233.061	Ea.	6" (152 mm)	914 (SO)	970 (SO)	—	1,266	1,426	1,098 (SO)	—	—
Paired with 2-PT21 (801.117) Installed, Flat Cover											
	233.038	Ea.	4-1/8" (105 mm)	322	342	375	716	986	542	642	1,392
	233.046	Ea.	4-1/2" (114 mm)	340	366	—	756	1,036	568	660	1,457
	233.065	Ea.	6" (152 mm)	548 (SO)	604 (SO)	—	900	1,060	732 (SO)	—	—
Ref. # 233.046 in 101 or 700/701 available Select Service.											
Paired with 2-RTS88 (928.3xx) and 2-Shear Locks (933.025) Installed, Shear Lock Header Cap											
	233.027	Ea.	4-1/8" (105 mm)	3,268	3,288	—	3,662	3,932	3,488	3,588	4,338
	233.034	Ea.	4-1/2" (114 mm)	3,286	3,312	—	3,702	3,982	3,514	3,606	4,403
	233.069	Ea.	6" (152 mm)	3,494 (SO)	3,550 (SO)	—	3,846	4,006	3,678 (SO)	—	—
Paired with 1-RTS88 (928.3xx) and 1-PT21 (801.117) Installed, Flat Cover											
	233.019	Ea.	4-1/8" (105 mm)	505	525	563	899	1,169	725	825	1,575
	233.041	Ea.	4-1/2" (114 mm)	523	549	—	939	1,219	751	843	1,640
	233.062	Ea.	6" (152 mm)	731 (SO)	787 (SO)	—	1,083	1,243	915 (SO)	—	—
Header Options											
										List Add \$	
PANIC	Prep for Glass Panic/Deadbolt Push Bar Device in dormakaba header, manual strike.										75
ELCK PREP	dormakaba EMSL Shearlock, or EML Magnetic Lock preparation and installation of magnet portion of lock in dormakaba header. In addition, panic prep for electric strike.										165
HDWPREP	Prep. and Install of dormakaba hardware (ie; offset pivots, arms, etc.) in dormakaba header.										75
CMP HDWP	Competitor hardware component preparation only for dormakaba header (ie; pivots and arms). Charge may be reviewed based on complexity.										90
CMP HDWI	Competitors hardware preparation and installation (ie; pivots and arms) in dormakaba header										150
CMP SHEAR	Competitors Shear Lock, Magnetic Lock, Overhead Concealed Closer prep and install in dormakaba header										250
MITER	Miter cut charge										61
										Net Add \$	
POWDER	All Custom powder coated orders will include a net charge per purchase order.										200

① Non-Fabricated item, can ship in 1 business day through Select Service. Program, quantities limited.

③ Standard or Non-Standard Fabricated; lead time up to 3 business days.

(SO) Special Fabricated/Finish or Special Order; lead time up to 5 weeks.

NOTES:

- For headers with RTS, specify 90° or 105°, HO or NHO, and spring size.
- Anodized headers are finished 4 sides, clad are finished 3 sides.
- Reference header accessories for cladding purchased separately.
- Default RTS pivot location is 2-3/4" (70 mm) centerline unless otherwise specified.
- Specify finished header length for any header above.
- End caps are optional and sold in sets of two (2) each.
- Headers requiring RTS preparation, less closers, deduct \$225 list per closer.
- Specify "LC" at the end of reference number. Example: 223.018.LC
- CMP Charges do not include cost of competitors product. Customer responsible to provide competitors products if pre-installation of competitors product is desired.

DRS Rails, Channels & Accessories
Patch Fittings & Designer Pivots
Offset Hung Patch Fittings
Headers & Accessories
Closers & Hardware
Locksets
Pulls & Handles
Sliding Systems
MANET
Panic Hardware

Header Options

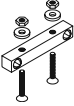
Header Stops			Standard Finishes \$					Custom Finishes \$
			101	108/109	500/501	503/599	600/601/602	199/299/399
	233.989	Ea. Header Stop	19 ^①	19 ^①	46 ^①	46 ^①	46 ^{⑧⑩}	59 ^{⑧⑩}

RTS88 Options

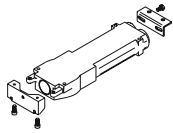

Model	Ref. #	U/M	Description	List Add \$
RTS88 Overhead Concealed Closer – Light Opening Force, Exterior Doors				③
	928.317	Ea.	105° HO BFE (5 mm Ext.)	225
	928.319	Ea.	105° NHO BFE (5 mm Ext.)	225
RTS88 Overhead Concealed Closer – Barrier Free (BFI) Interior Doors Only				
	928.321	Ea.	105° HO BFI (5 mm Ext.)	225
	928.323	Ea.	105° NHO BFI (5 mm Ext.)	225
RTS88 Overhead Concealed Closer – Hold Open Heavier Spring Sizes				
	928.329	Ea.	90° HO SZ 3 (5 mm Ext.)	225
	928.330	Ea.	105° HO SZ3 (5 mm Ext.)	225
RTS88 Overhead Concealed Closer – Non-Hold Open Heavier Spring Sizes				
	928.337	Ea.	105° NHO SZ 3 (5 mm Ext.)	225
	928.338	Ea.	90° NHO SZ3 (5 mm Ext.)	225

① Non-Fabricated item, can ship in 1 business day through Select Service Program, quantities limited.

③ Standard or Non-Standard Fabricated; lead time up to 3 business days.







NOTES:

- dormakaba requires the use of 5 mm Ext. spindles with all Herculite type door applications when supplied with RTS88 overhead concealed closers. This allows for optimum spindle engagement. Inadequate engagement can cause premature wear on the closers and hardware, voiding warranty.

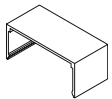
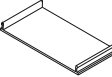
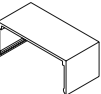
Optional Sidelite Headers

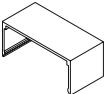
4-1/8" (105 mm), 4-1/2" (114 mm), and 6" (152 mm) Wide × 1-3/4" (44 mm)

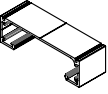
Sidelite Header Options

				Standard Finishes \$					Custom Finishes \$	
				101	108/109	503/599	600/601	700/701	199/399	299
	Ref. #	U/M	Description	3	3	SO	SO	3	SO	SO
Header with Flat Cover										
	233.700	Ft.	4-1/8" (105 mm) Header with Flat Cover	15	18	61	77	40	55	100
	233.705	Ft.	4-1/2" (114 mm) Header with Flat Cover	17	20	76	88	45	57	109
	233.710	Ft.	6" (152 mm) Header with Flat Cover	28	39	74	90	53	65	113
4-1/8" Header with Dri-Fit® (Includes gasket)										
	233.701	Ft.	4-1/8" (105 mm) Header with 3/8" (10 mm) Dri-Fit®	24	29	70	87	47	64	111
	233.702	Ft.	4-1/8" (105 mm) Header with 1/2" (12 mm) Dri-Fit®	24	29	70	87	47	64	111
	233.703	Ft.	4-1/8" (105 mm) Header with 5/8" (15 mm) Dri-Fit®	29	32	79	98	52	72	125
	233.704	Ft.	4-1/8" (105 mm) Header with 3/4" (19 mm) Dri-Fit®	29	32	79	98	52	72	125
4-1/2" Header with Dri-Fit® (Includes gasket)										
	233.706	Ft.	4-1/2" (114 mm) Header with 3/8" (10 mm) Dri-Fit®	28	32	77	94	53	68	121
	233.707	Ft.	4-1/2" (114 mm) Header with 1/2" (12 mm) Dri-Fit®	28	32	77	94	53	68	121
	233.708	Ft.	4-1/2" (114 mm) Header with 5/8" (15 mm) Dri-Fit®	31	36	87	107	60	77	138
	233.709	Ft.	4-1/2" (114 mm) Header with 3/4" (19 mm) Dri-Fit®	31	36	87	107	60	77	138
6" Header with Dri-Fit® (Includes gasket)										
	233.711	Ft.	6" (152 mm) Header with 3/8" (10 mm) Dri-Fit®	37	50	83	100	60	74	124
	233.712	Ft.	6" (152 mm) Header with 1/2" (12 mm) Dri-Fit®	37	50	83	100	60	74	124
	233.713	Ft.	6" (152 mm) Header with 5/8" (15 mm) Dri-Fit®	42	53	92	111	65	82	138
	233.714	Ft.	6" (152 mm) Header with 3/4" (19 mm) Dri-Fit®	42	53	92	111	65	82	138
										List Add \$
MITER	Miter cut charge									61
JAMB	Jamb prep charge includes blocking support if required. Allow up to 5 additional days lead-time.									61
										Net Add \$
POWDER	All Custom powder coated orders will include a net charge per purchase order.									200

3 Standard or Non-Standard Fabricated; lead time up to 3 business days.

SO Special Fabricated/Finish or Special Order; lead time up to 5 weeks.







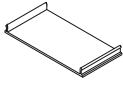

NOTES:

- Must specify length when ordering. dormakaba will cut to specified size, priced per foot only.
- Maximum overall length 144" (3.66M) before requiring a splice joint; 120" (3M) for Brass and Bronze finishes.
- Above priced per foot for the combined parts defined.

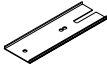
DRS Rails, Channels & Accessories
Patch Fittings & Designer Pivots
Offset Hung Patch Fittings
Headers & Accessories
Closers & Hardware
Locksets
Pulls & Handles
Sliding Systems
MANET
Panic Hardware

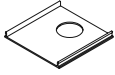
Header Accessories and Service Parts

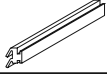
4-1/8" (105 mm) Wide x 1-3/4" (44 mm)

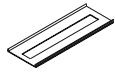





	Ref. #	U/M	Description	Standard Finishes \$					Custom Finishes \$		
				101	108/109	503/599	600/601	700/701	199/399	299	
				3	3	SO	SO	3	SO	SO	
Header Tube, 4-1/8"											
	933.032	Ft.	4-1/8" (105 mm) Header Tube, Anodized	10	12	—	—	—	30	—	
	233.999	Ft.	4-1/8" (105 mm) Header Tube with Clad on sides only	—	—	35	44	23	—	57	
Header Flat Cover, 4-1/8"											
	933.030	Ft.	4-1/8" (105 mm) Flat Cover, Anodized	5	6	—	—	—	25	—	
	233.998	Ft.	4-1/8" (105 mm) Flat Cover, with Clad on face only.	—	—	26	33	17	—	43	
Header Cover for RTS Adjustment, 4-1/8"											
	933.443	Ft.	4-1/8" (105mm) Cover for RTS Adjustment, Anodized	9	15	—	—	—	63	—	
	933.444	Ft.	4-1/8" (105mm) Cover for RTS Adjustment, Clad on face only	—	—	51	45	19	—	56	
Floating Header Cover for RTS Adjustment, 4-1/8"											
	933.447	Ft.	4-1/8" (105mm) Floating Header Cover for RTS Adjustment, Anodized	15	21	—	—	—	81	—	
	933.448	Ft.	4-1/8" (105mm) Floating Header Cover for RTS Adjustment, Clad on face only	—	—	57	51	25	—	59	
Header Glazing Pocket/Cover, 4-1/8"											
	933.031	Ft.	3/8" (10 mm) and 1/2" (12 mm) glass	8	11	—	—	—	28	—	
	233.997	Ft.	3/8" (10 mm) and 1/2" (12 mm) glass Clad on face only (Gasket Required)	—	—	29	37	18	—	48	
	933.331	Ft.	5/8" (15 mm) and 3/4" (19 mm) glass	13	14	—	—	—	36	—	
	233.986	Ft.	5/8" (15 mm) and 3/4" (19 mm) glass Clad on face only (Gasket Required)	—	—	38	48	23	—	62	
Header Cover Caps, 4-1/8"											
	933.029	Ea.	4-1/8" (105 mm) RTS Cover Cap, Anodized	16	17	—	—	—	36	—	
	233.996	Ea.	4-1/8" (105 mm) RTS Cover Cap, Clad on face only. Length is 3-15/16" (100 mm)	—	—	45	57	33	—	74	
	933.505	Ea.	4-1/8" (105 mm) PT21 Cover Cap, Anodized	16	17	—	—	—	36	—	
	233.984	Ea.	4-1/8" (105 mm) PT21 Cover Cap, Clad on Face Only. Length is 3-15/16"	—	—	45	57	33	—	74	
Header End Cap				(109 only)							
	933.039	Ea.	4-1/8" (105 mm) x 1-3/4" (44 mm) Header End Cap, Anodized	18	18	—	—	—	—	—	
	933.340	Ea.	4-1/8" (105 mm) x 1-3/4" (44 mm) Header End Cap, Clad	—	—	20	37	18	—	—	
Dri-Fit® Gasket											
	925.148	Ft.	3/8" (10 mm) and 5/8" (15 mm) glass	3	—	—	—	—	—	—	
	925.147	Ft.	1/2" (12 mm) and 3/4" (19 mm) glass	3	—	—	—	—	—	—	
EMSL 2765 Shear Lock											
	933.025	Ea.	EMSL 2765 Shear Lock (Not Installed)						1,140	①	
EMSL Shear Lock Header Cap, 4-1/8"				5	5	SO	SO	5	SO	SO	
	933.021	Ea.	4-1/8" (105 mm) Header Cap for Shear Lock, Anodized	9	10	—	—	—	29	—	
	233.991	Ea.	4-1/8" (105 mm) Header Cap for Shear Lock, Clad on face only. Length is 12-1/8" (308 mm)	—	—	64	70	51	—	91	

- ① Non-Fabricated item, ships in 1 business day.
- 3 Standard or Non-Standard Fabricated; lead time up to 3 business days.
- 5 Custom Fabricated; lead time up to 5 business days.
- SO Special Fabricated/Finish or Special Order; lead time up to 5 weeks.

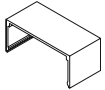
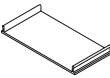
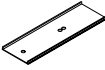
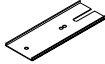
- NOTES:**
- Must specify length when ordering header extrusions. dormakaba will cut to specified size, priced per foot only.
 - Maximum overall length 144" (3.66M) before requiring a splice joint; 120" (3M) for Brass and Bronze finishes.

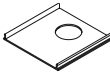
Header Accessories and Service Parts

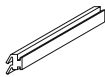

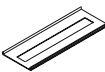



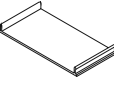

4-1/2" (114 mm) Wide x 1-3/4" (44 mm)

Ref. #	U/M	Description	Standard Finishes \$					Custom Finishes \$		
			101	108/109	503/599	600/601	700/701	199/399	299	
			3	3	SO	SO	3	SO	SO	
Header Tube, 4-1/2"										
 933.033	Ft.	4-1/2" (114 mm) Header Tube, Anodized	12	13	—	—	—	32	—	
233.995	Ft.	4-1/2" (114 mm) Header Tube, with Clad on sides only	—	—	37	46	25	—	60	
Header Flat Cover, 4-1/2"										
 933.034	Ft.	4-1/2" (114 mm) Flat Cover, Anodized	5	7	—	—	—	25	—	
233.994	Ft.	4-1/2" (114 mm) Flat Cover, with Clad on face only	—	—	39	42	20	—	49	
Header Cover for RTS Adjustment, 4-1/2"										
 933.428	Ft.	4-1/2" (114mm) RTS Adjustment Cover, Anodized	10	17	—	—	—	63	—	
933.429	Ft.	4-1/2" (114mm) RTS Adjustment Cover, Clad on face only	—	—	48	45	20	—	56	
Floating Header Cover for RTS Adjustment, 4-1/2"										
 933.430	Ft.	4-1/2" (114mm) Floating Header Cover for RTS Adjustment, Anodized	16	23	—	—	—	81	—	
933.431	Ft.	4-1/2" (114mm) Floating Header Cover for RTS Adjustment, Clad on face only	—	—	54	51	26	—	68	
Header Glazing Pocket/Cover, 4-1/2"										
 933.035	Ft.	3/8" (10 mm) and 1/2" (12 mm) glass	10	13	—	—	—	30	—	
233.993	Ft.	3/8" (10 mm) and 1/2" (12 mm) glass Clad on face only (Gasket Required)	—	—	34	42	22	—	55	
933.335	Ft.	5/8" (15 mm) and 3/4" (19 mm) glass	13	17	—	—	—	39	—	
233.985	Ft.	5/8" (15 mm) and 3/4" (19 mm) glass Clad on face only (Gasket Required)	—	—	44	55	29	—	72	
Header Cover Caps, 4-1/2"										
 933.036	Ea.	4-1/2" (114 mm) RTS Cover Cap, Anodized	16	17	—	—	—	36	—	
233.992	Ea.	4-1/2" (114 mm) RTS Cover Cap, Clad on face only. Length is 3-15/16" (100 mm)	—	—	45	57	33	—	74	
933.555	Ea.	(6" & 4-1/8") PT21 Cover Cap, Anodized	16	17	—	—	—	36	—	
233.988	Ea.	(6" & 4-1/8") PT21 Cover Cap, Clad on Face Only. Length is 3-15/16"	—	—	45	57	33	—	74	
Header End Cap (109 only)										
 933.040	Ea.	4-1/2" (114 mm) x 1-3/4" (44 mm) Header End Cap, Anodized	18	18	—	—	—	—	—	
933.341	Ea.	4-1/2" (114 mm) x 1-3/4" (44 mm) Header End Cap, Clad	—	—	20	37	18	—	—	
Dri-Fit® Gasket										
 925.148	Ft.	3/8" (10 mm) and 5/8" (15 mm) glass	3	—	—	—	—	—	—	
925.147	Ft.	1/2" (12 mm) and 3/4" (19 mm) glass	3	—	—	—	—	—	—	
EMSL 2765 Shear Lock										
 933.025	Ea.	EMSL 2765 Shear Lock (Not Installed)							1,140	①
EMSL Shear Lock Header Cap, 4-1/2"										
 933.037	Ea.	4-1/2" (114 mm) Header Cap for Shear Lock, Anodized	12	13	—	—	—	32	—	
233.990	Ea.	4-1/2" (114 mm) Header Cap for Shear Lock, Clad on face only. Length is 12-1/8" (308 mm).	—	—	70	77	54	—	100	

DRS Rails, Channels & Accessories
Patch Fittings & Designer Pivots
Offset Hung Patch Fittings
Headers & Accessories
Closers & Hardware
Locksets
Pulls & Handles
Sliding Systems
MANET
Panic Hardware

Header Accessories and Service Parts

6" (152 mm) Wide × 1-3/4" (44 mm)

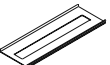
Ref. #	U/M	Description	Standard Finishes \$					Custom Finishes \$		
			101	108/109	503/599	600/601	700/701	199/399	299	
			3	3	SO	SO	3	SO	SO	
Header Tube, 6"										
	933.432	Ft. 6" (152 mm) Header Tube, Anodized	23	33	—	—	—	40	—	
	233.987	Ft. 6" (152 mm) Header Tube, Clad on sides only	—	—	48	57	36	—	70	
Header Flat Cover, (6" and 4-1/8")										
	933.030	Ft. (6" (152 mm) and 4-1/8" (105 mm)) Flat Cover, Anodized	5	6	—	—	—	25	—	
	233.998	Ft. (6" (152 mm) and 4-1/8" (105 mm)) Flat Cover, with Clad on face only.	—	—	26	33	17	—	43	
Header Cover for RTS Adjustment, (6" and 4-1/8")										
	933.443	Ft. (6" (152 mm) and 4-1/8" (105 mm)) Cover for RTS Adjustment, Anodized	9	15	—	—	—	63	—	
	933.444	Ft. (6" (152 mm) and 4-1/8" (105 mm)) Cover for RTS Adjustment, with Clad on face only.	—	—	51	45	19	—	56	
Floating Header Cover for RTS Adjustment, (6" and 4-1/8")										
	933.447	Ft. (6" (152mm) & 4-1/8" (104mm)) Floating Header Cover for RTS Adjustment, Anodized	15	21	—	—	—	81	—	
	933.448	Ft. (6" (152mm) & 4-1/8" (104mm)) Floating Header Cover for RTS Adjustment, Clad on face only	—	—	57	51	25	—	59	
Header Glazing Pocket/Cover, (6" and 4-1/8")										
	933.031	Ft. 3/8" (10 mm) and 1/2" (12 mm) glass	8	11	—	—	—	28	—	
	233.997	Ft. 3/8" (10 mm) and 1/2" (12 mm) glass Clad on face only (Gasket Required)	—	—	29	37	18	—	48	
	933.331	Ft. 5/8" (15 mm) and 3/4" (19 mm) glass	13	14	—	—	—	36	—	
	233.986	Ft. 5/8" (15 mm) and 3/4" (19 mm) glass Clad on face only (Gasket Required)	—	—	38	48	23	—	62	
Header Cover Caps, (6" and 4-1/8")										
	933.029	Ea. (6" (152 mm) and 4-1/8" (105 mm)) RTS Cover Cap, Anodized	16	17	—	—	—	36	—	
	233.996	Ea. (6" (152 mm) and 4-1/8" (105 mm)) RTS Cover Cap, Clad on face only. Length is 3-15/16" (100 mm)	—	—	45	57	33	—	74	
	933.505	Ea. PT21 Cover Cap, Anodized	16	17	—	—	—	36	—	
	233.984	Ea. PT21 Cover Cap, Clad on Face Only. Length is 3-15/16"	—	—	45	57	33	—	74	
Header End Cap (109 only)										
	933.467	Ea. 6" (152 mm) × 1-3/4" (44 mm) Header End Cap, Anodized	18	18	—	—	—	—	—	
	933.468	Ea. 6" (152 mm) × 1-3/4" (44 mm) Header End Cap, Clad	—	—	20	37	18	—	—	
Dri-Fit® Gasket										
	925.148	Ft. 3/8" (10 mm) and 5/8" (15 mm) glass	3	—	—	—	—	—	—	
	925.147	Ft. 1/2" (12 mm) and 3/4" (19 mm) glass	3	—	—	—	—	—	—	
EMSL 2765 Shear Lock										
	933.025	Ea. EMSL 2765 Shear Lock (Not Installed)								1,140 ^①
EMSL Shear Lock Header Cap, (6" and 4-1/8")										
	933.021	Ea. (6" (152 mm) and 4-1/8" (105 mm)) Header Cap for Shear Lock, Anodized.	9	10	—	—	—	29	—	
	233.991	Ea. (6" (152 mm) and 4-1/8" (105 mm)) Header Cap for Shear Lock, Clad on face only. Length is 12-1/8" (308mm)	—	—	64	70	51	—	91	

NOTES:

- Must specify length when ordering header extrusions. dormakaba will cut to specified size, priced per foot only.
- Maximum overall length 144" (3.66M) before requiring a splice joint; 120" (3M) for Brass and Bronze finishes.
- Please note, 6" (152 mm) header channel utilizes inserts from 4-1/8" (105 mm) header design.

- ① Non-Fabricated item, ships in 1 business day.
- 3 Standard or Non-Standard Fabricated; lead time up to 3 business days.
- 5 Custom Fabricated; lead time up to 5 business days.
- SO Special Fabricated/Finish or Special Order; lead time up to 5 weeks.

Floating Header for All-Glass Entrances with Transom

Ordering Guide

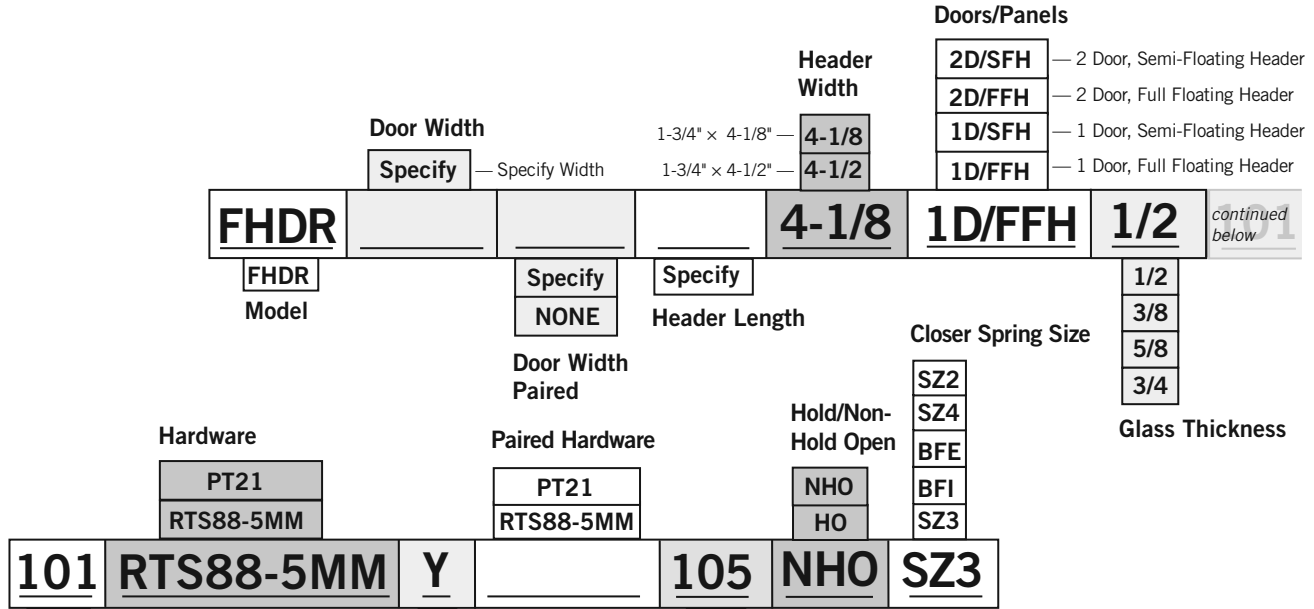

101	RTS88-5MM	Y		105	NHO	SZ3
101	Clear Anodized (CL)	Y		105		
108	Dark Bronze (DB)	N		90		
109	Black Anodized (BK)		Standard Spindle Location		Closer Bumper Position	
503	Polished Brass w/o Lacquer (PB)					
599	Satin Brass w/o Lacquer (SB)					
600	Satin Bronze w/o Lacquer (SBZ)					
601	Polished Bronzed w/o Lacquer (PB2)					
700	Satin Stainless Steel (SS/US32D)					
701	Polished Stainless Steel (PS/US32)					

Standard Finish

- 113** — Similar to Satin Stainless (Limited Availability)
- 199** — Custom Anodized Finishes (Specify)
- 299** — Custom Cladding (Specify)
- 399** — Powder Coated Finishes (Specify)

Finish Custom^{1,2}

¹ dormakaba reserves the right to refuse Custom Finishes.
² All Custom Finishes require customer sign-off/approval of color chip.

Floating Header, Single Opening

24" (610 mm) – 48" (1219 mm)



				Standard Finishes \$					Custom Finishes \$		
				101	108/109	113	503/599	600/601	700/701	199/399	299
Model	Ref. #	U/M	Description	(5)	(5)		(SO)	(SO)	(5)	(SO)	(SO)
Single Floating Header with 1-RTS88 (928.3xx) Installed				Single Header Base Price							
	233.418	Ea.	4-1/8" (105 mm)	740	757	814	966	1,045	894	904	1,359
	233.440	Ea.	4-1/2" (114 mm)	756	780	—	999	1,080	917	921	1,405
Single Floating Header with 1-PT21 (801.117) Installed											
	233.436	Ea.	4-1/8" (105 mm)	557	574	613	783	862	711	721	1,176
	233.444	Ea.	4-1/2" (114 mm)	573	597	—	816	897	734	738	1,222

DRS Rails, Channels & Accessories

Patch Fittings & Designer Pivots

Offset Hung Patch Fittings

Headers & Accessories

Closers & Hardware

Locksets

Pulls & Handles

Sliding Systems

MANET

Panic Hardware

Floating Header, Paired Opening

48" (1219 mm) – 96" (2438 mm)



				Standard Finishes \$					Custom Finishes \$		
				101	108/109	113	503/599	600/601	700/701	199/399	299
Model	Ref. #	U/M	Description	(5)	(5)	(SO)	(SO)	(5)	(SO)	(SO)	
Paired Floating Header with 2-RTS88 (928.3xx) Installed				Paired Header Base Price							
	233.420	Ea.	4-1/8" (105 mm)	1,480	1,514	1,628	1,932	2,090	1,788	1,808	2,718
	233.442	Ea.	4-1/2" (114 mm)	1,512	1,560	—	1,998	2,160	1,834	1,842	2,810
Paired Floating Header with 2-PT21 (801.117) Installed											
	233.438	Ea.	4-1/8" (105 mm)	1,114	1,148	1,225	1,566	1,724	1,422	1,442	2,352
	233.446	Ea.	4-1/2" (114 mm)	1,146	1,194	—	1,632	1,794	1,468	1,476	2,444
Paired Floating Header with 1-RTS88 (928.3xx) and 1-PT21 (801.117) Installed											
	233.437	Ea.	4-1/8" (105 mm)	1,297	1,331	1,427	1,749	1,907	1,605	1,625	2,535
	233.445	Ea.	4-1/2" (114 mm)	1,329	1,377	—	1,815	1,977	1,651	1,659	2,627
Header Options											
										List Add \$	
PANIC	Prep for Glass Panic/Deadbolt Push Bar Device in dormakaba header, manual strike.									75	
ELCK PREP	dormakaba EMSL Shearlock, or EML Magnetic Lock preparation and installation of magnet portion of lock in dormakaba header. In addition, panic prep for electric strike.									165	
HDWPREP	Prep. and Install of dormakaba hardware (ie; offset pivots, arms, etc.) in dormakaba header.									75	
										Net Add \$	
POWDER	All Custom powder coated orders will include a net charge per purchase order.									200	

Floating Header Accessories

Model	Ref. #	U/M	Description	Standard Finishes \$	
				101/109	503/599/600/601/700/701
End Caps					
	933.461	Set	4-1/8" (105 mm) Floating Header End Caps, Anodized	30	—
	933.464	Set	4-1/8" (105 mm) Floating Header End Caps, Clad	—	105
	933.462	Set	4-1/2" (114 mm) Floating Header End Caps, Anodized	30	—
	933.465	Set	4-1/2" (114 mm) Floating Header End Caps, Clad	—	105
	933.463	Set	6" (152 mm) Floating Header End Caps, Anodized	35	—
	933.466	Set	6" (152 mm) Floating Header End Caps, Clad	—	115

(5) Custom Fabricated; lead time up to 5 business days.

(SO) Special Fabricated/Finish or Special Order; lead time up to 5 weeks.

NOTES:

- Must specify length when ordering. dormakaba will cut to specified size, priced per foot only.
- Maximum overall length 144" (3.66 m) before requiring a splice joint; 120" (3 m) for Brass and Bronze finishes.
- For floating Header with RTS, specify 90° or 105°, HO or NHO, and spring size.
- Headers requiring RTS preparation, less closers, deduct \$150 list per closer.
- Specify "LC" at the end of reference number. Example: 233.420.LC

Closers and Hardware

	Select Service	78
RTS88	Overhead Concealed Closers and Covers	81
	RTS88 Hardware	82
BTS	Floor Closers	86
	BTS Hardware	90
Hardware	Shear Locks	92
	Locks and Cylinders	93
	Strikes, Saddles, and Thresholds	94

DRS Rails,
Channels &
Accessories

Patch Fittings
& Designer
Pivots

Offset
Hung Patch
Fittings

Headers &
Accessories

Closers &
Hardware

Locksets

Pulls &
Handles

Sliding
Systems

MANET

Panic
Hardware

Select Service Quick Ship – Closers and Hardware

Select service should be used for small quantities of popular dormakaba products that require shipment within 24 hours. The program includes patch fittings, DRS rails, headers, concealed closers and pivots, and pulls and handles. Warehouses have been set up in the east and west for faster delivery nationwide. (Customer responsible for shipping costs FOB.)

Subject to Availability



Next Business Day Service (Shipment when Purchase Order is received prior to 4:00 PM EST).

Examples: dormakaba receives P.O. at 3:59 PM on Monday, order will ship by close of business on Tuesday.
 dormakaba receives P.O. at 3:59 PM on Friday, order will ship by close of business on the following Monday.

Notes:

- Standard freight and discount schedules and terms of sale apply. Please refer to the current price list for full details.
- dormakaba reserves the right to limit quantities or decline an order if the credit status of the buyer is not satisfactory to dormakaba.
- Orders cannot be cancelled.
- Select Service Quick Ship available only in the United States.
- All prices are in U.S. dollars.
- Products and prices are subject to change without notice.
- Limited quantities available.

Key

	"New" to Select Service, Available in East and West Coast Warehouse
	Available in East and West Coast Warehouse
	Available only in East Coast Warehouse
	Available only in West Coast Warehouse

Closers and Hardware

RTS Series

Ref. #	Warehouse	Package	Spring	Stop	NHO/HO	Extension	List \$
33600003	■	RTS88	SZ3	105°	NHO	5 mm	225
33600004	■	RTS88	SZ3	105°	HO	5 mm	225
33600005	■	RTS88	SZ3	90°	NHO	5 mm	225
33600006	■	RTS88	SZ3	90°	HO	5 mm	225
33600007	■	RTS88	BFI	105°	NHO	5 mm	225
33600008	■	RTS88	BFI	105°	HO	5 mm	225
33600009	■	RTS88	BFE	105°	NHO	5 mm	225
33600010	■	RTS88	BFE	105°	HO	5 mm	225

RTS Accessories and Service Items

Ref. #	Warehouse	Model	Description	Finish	List \$
33600011	□	CRNR BRKT	Header to side Jamb	—	6
33600012	■	8835	End load arm, 1" web	—	55
33600013	■	8836	End load arm, 7/8" web	—	50
33600014	□	8837	End load arm, 5/8" web	—	55
33600015	■	8838	End load arm, 3/4" web	—	55
33600016	■	8812	Offset arm	—	75
33600017	■	8852	Short floor pivot	—	40
33600018	■	8853	Tall floor pivot	—	49
33600019	■	8855	Short threshold pivot	—	49
33600020	□	8575	Cover, steel	500	105
33600021	■	8563	Cover, aluminum	689	44
33600023	□	* 8521E	2-5/16" (Add-On) spindle extension	—	37

* dormakaba recommends never combining RTS88 size BFI, BFE, or SZ2 closer with 8521E add-on extended spindle. These closers may not generate enough power to close and latch a door if used in combination with 8521E.

- DRS Rails, Channels & Accessories
- Patch Fittings & Designer Pivots
- Offset Hung Patch Fittings
- Headers & Accessories
- Closers & Hardware
- Locksets
- Pulls & Handles
- Sliding Systems
- MANET
- Panic Hardware

BTS Accessories and Service Items

Ref. #	Warehouse	Product	Hand	Finish	List \$
33600028	■	BTS80 Sz. 3 (was BFE)	—	—	590
33600029	■	BTS80 Sz. 4 (was SZ3)	—	—	590
33600030	■	BTS80 Sz. 6 (was SZ2)	—	—	590
33600031	■	BTS75V NHO 1-4	—	—	550
33600032	■	BTS75V BF NHO 1-4	—	—	550
33600033	■	BTS75V 90 HO 1-4	—	—	570
33600034	■	74003 (spindle insert) 5/16" Clearance	—	—	45
33600035	■	74005 (spindle insert) 1/2" Clearance	—	—	45
33600036	■	74007 (spindle insert) 5/8" Clearance	—	—	45
33600037	■	74010 (spindle insert) 3/4" Clearance	—	—	45
33600038	■	74015 (spindle insert) 7/8" Clearance	—	—	55
33600039	■	74020 (spindle insert) 1-1/8" Clearance	—	—	55
33600040	■	74025 (spindle insert) 1-5/16" Clearance	—	—	55
33600041	■	80010 (3° spindle insert) 3/4" Clearance	RH	—	45
33600042	■	80010 (3° spindle insert) 3/4" Clearance	LH	—	45
33600043	■	7410 (BTS80 cover plate)	—	700	95
33600044	■	7410 (BTS80 cover plate)	—	602	95
33600045	■	7510 (BTS75V cover plate)	—	700	90
33600046	■	7510 (BTS75V cover plate)	—	602	90

Overhead Concealed Closers and Covers

	Ref. #	U/M	Description	List \$
RTS88 Closers — Barrier Free Exterior (BFE)				
	928.017	Ea.	105° HO (5 mm ext.)*	225 ①
	928.019	Ea.	105° NHO (5 mm ext.)*	225 ①
	928.016	Ea.	105° HO	225 ⑤
	928.018	Ea.	105° NHO	225 ①
RTS88 Closers — Barrier Free Interior (BFI)				
	928.021	Ea.	105° HO (5 mm ext.)*	225 ①
	928.023	Ea.	105° NHO (5 mm ext.)*	225 ①
	928.020	Ea.	105° HO	225 ⑤
	928.022	Ea.	105° NHO	225 ①
RTS88 Closers — Hold Open				
	928.029	Ea.	90° (5 mm ext.) Size 3*	225 ①
	928.030	Ea.	105° (5 mm ext.) Size 3*	225 ①
	928.025	Ea.	105° Size 3	225 ①
	928.026	Ea.	105° Size 4	225 ⑤
	928.027	Ea.	90° Size 3	225 ①
	928.028	Ea.	90° Size 4	225 ⑤
RTS88 Closers — No Hold Open				
	928.037	Ea.	105° (5 mm ext.) Size 3*	225 ①
	928.038	Ea.	90° (5 mm ext.) Size 3*	225 ①
	928.032	Ea.	105° Size 3	225 ①
	928.033	Ea.	105° Size 4	225 ⑤
	928.034	Ea.	90° Size 2	225 ⑤
	928.035	Ea.	90° Size 3	225 ①
	928.036	Ea.	90° Size 4	225 ⑤
				Finishes \$
RTS88 Closers Covers**				
				101 108 600/601 500/501
	Model			⑤ ⑤ ⑤ ⑤
	8561	928.051	Ea. Cover when installed in Wood Header	44 44 — 105
	8563	928.052	Ea. Cover when installed in Aluminum Header	44 44 — —
	8575	928.053	Ea. Cover when installed in Steel Header	44 44 105 105

① Non-Fabricated item, ships in 1 business day
 ⑤ Non-Fabricated item, ships in 5 business days
 ⑤ Special Fabricated/Finish or Special Order; lead time up to 5 weeks.

NOTE:

* dormakaba Glass requires the use of 5 mm extended spindles with ALL Herculite glass door applications when an OHCC is specified. This allows for optimum spindle bite. Inadequate bite can cause premature wear on the closers and hardware, potentially voiding warranty. Spring sizes other than what is listed above are available—please consult factory.

** Always use an auxillary stop in conjunction with RTS88 installations.

DRS Rails, Channels & Accessories

Patch Fittings & Designer Pivots

Offset Hung Patch Fittings

Headers & Accessories

Closers & Hardware

Locksets

Pulls & Handles



Sliding Systems

MANET

Panic Hardware

RTS88 Hardware

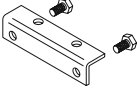
Brackets and Arms

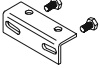
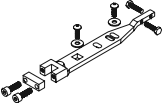
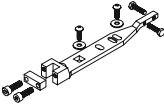
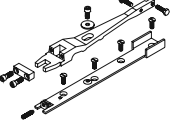
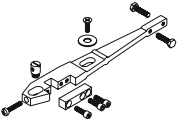
Model	Ref. #	U/M	Description	Finishes \$
Brackets				101
				①
	928.012	Ea.	Round Angle Bracket (screws not included)	3
	928.997	Ea.	Screw Package	1
	928.013	Ea.	Corner Bracket	6
	928.999	Ea.	Screw Package	1
	928.014	Ea.	Slotted Angle Bracket (screws not included)	4
	928.997	Ea.	Screw Package	1
Top Arms				100/101
	8837	928.004	Ea. Rail Top Arm End Load 5/8" (16 mm) web depth	55 ⑤
	8838	928.003	Ea. Rail Top Arm End Load 3/4" (19 mm) web depth	55 ①
	8836	928.006	Ea. Rail Top Arm End Load 7/8" (22 mm) web depth	50 ①
	8836S	928.001	Ea. Rail Short Top Arm End Load 7/8" (22 mm) web depth	80 ⑥
	8534	228.001	Ea. Rail Top Arm End Load 7/8" (22 mm) web depth	55 ⑥
	8835	928.002	Ea. Rail Top Arm End Load 1" (25 mm) web depth	55 ⑥
	8831	928.007	Ea. Rail Top Arm Side Load 1/2" (13mm) web depth	55 ⑥

① Non-Fabricated item, ships in 1 business day
 ⑤ Non-Fabricated item, ships in 5 business days
 ⑥ Special Fabricated/Finish or Special Order; lead time up to 5 weeks.

Arms and Pivots

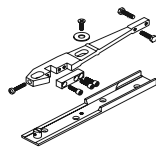
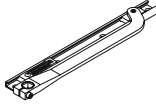
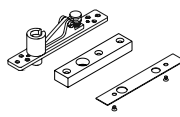
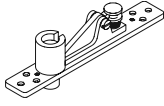
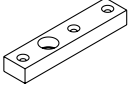
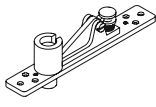
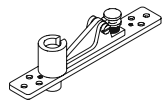
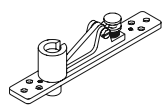
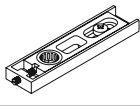
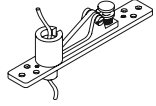
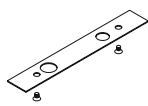
Model	Ref. #	U/M	Description	Finishes \$			
Top Arms				100			
	8832	928.008	Ea. Rail Top Arm Side Load 5/8" (16 mm) web depth	127	(SO)		
	8812	928.009	Ea. Rail Top Slide Arm 3/4" (19 mm) Offset 3/4" (19 mm) web depth	75	(5)		
Top Pivots				101	700/701		
	HD8062	927.066	Ea. Walking Beam Pivot with 5/8" (16 mm) Pin COMPLETE Heavy Duty	200	(SO)	200	(SO)
	HD8062 TOP	927.065	Ea. Top Walking Beam Pivot with 5/8" (16 mm) Pin (HD)	90	(5)		
	HD8062 LOWER	927.050	Ea. Top Walking Beam Pivot Door Portion (5/8" (16 mm) Pin)	83	(5)		
	8062.5	927.063	Ea. Top Walking Beam Pivot with 1/2" (13 mm) Pin (Used for custom 1/2" (13 mm) Receiver (Bearing) applications)	48	(5)		
	8062	927.064	Ea. Top Walking Beam Pivot with 19/32" (15 mm) Pin (Do not use with 355.0, 355.9, or 319.2 inserts) Use with 927.062 Lower.	42	(1)		
	PT21	801.117	Ea. Top Walking Beam Pivot for use with inserts (Standard Glass WBP) 355.0, 355.9, and 319.2 (904.610, 904.091, and 903.111 respectively)	45	(1)		
	8062 LOWER	927.062	Ea. Top Walking Beam Pivot Door Portion (15 mm Pin) use with 8062 (Use with 927.065)	25	(1)		
				108	500/501	599	
	E8062	927.061	Ea. Top Walking Beam Pivot Electrified (5/8" (16 mm) Pin)	410	(SO)	410	(SO) 410
				108/109	503/599	600/601	700/701
	8062COV	227.004	Ea. Top Walking Beam Pivot Cover Plate	15	(1)	15	(SO) 15 (SO) 15 (1)

(1) Non-Fabricated item, ships in 1 business day
 (5) Non-Fabricated item, ships in 5 business days
 (SO) Special Fabricated/Finish or Special Order; lead time up to 5 weeks.

DRS Rails, Channels & Accessories
 Patch Fittings & Designer Pivots
 Offset Hung Patch Fittings
 Headers & Accessories
 Closers & Hardware
 Locksets
 Pulls & Handles
 Sliding Systems
 MANET
 Panic Hardware

RTS88 Hardware

Pivots

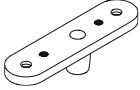
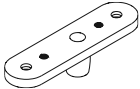
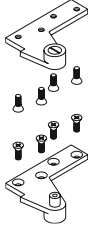
	Model	Ref. #	U/M	Description						List \$
	325.3 PT25	901.115	Ea.	Top Pivot with Threaded Rod						9 ^①
Finishes \$										
					101	108				
	325.6 PT24	901.116	Ea.	Top Pivot with 6 mm Mounting Plate	26 ^①	26 ^①				
					108/109		700			
	325.6 PT24	901.923	Ea.	3 mm Mounting Plate	26 ^①	29 ^①	35 ^①			
3/4" Top Offset Pivot					314 (Primer)	503/599	600/601/602	700/701		
	75120	929.034	Ea.	3/4" (19mm) Top Offset Pivot	106 ^{SO}	106 ^{SO}	106 ^{SO}	106 ^{SO}	106 ^①	
1-1/2" Top Offset Pivot										
	15120	929.019	Ea.	1-1/2" (38 mm) Top Offset Pivot	170 ^①	170 ^①	170 ^①	170 ^①	170 ^{SO}	





① Non-Fabricated item, ships in 1 business day

SO Special Fabricated/Finish or Special Order; lead time up to 5 weeks.

NOTE: 75120 and 15120 in 700 or 701 Finish is Satin or Polished Chrome Bronze base metal.

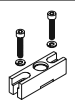
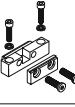
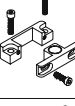
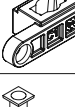
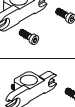
RTS88 Hardware

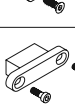
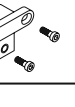
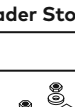
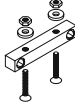
Inserts and Header Stops

	Model	Ref. #	U/M Description	List \$
Top Inserts				
	*355.0	904.610	Ea. Top Rail Insert for 15 mm Diameter Pin	26 ^①
	355.4	904.611	Ea. Top Rail Insert RTS	85 ^{SO}
	*355.9	904.091	Ea. Top Rail Adj. Insert	52 ^①
	319.1	903.105	Ea. Bottom fitting insert for PT10, used with BTS closers, or 7471K or 355.5 floor bearings	20 ^①
	*319.2	903.111	Ea. Top Fitting Insert for 15 mm Pin	16 ^①
	319.3	903.125	Ea. Top Fitting Pivot Insert	20 ^①
	355.41	903.999	Ea. Top Fitting Sideload Insert RTS88	25 ^①
	355.43	903.126	Ea. Top Fitting Insert Blank	16 ^①
	355.42	903.127	Ea. Top Fitting Insert Stop	20 ^①
Header Stops				
				Standard Finishes \$
				Custom Finishes \$
				101 108/109 500/501 503/599 600/601/602 999
		233.989	Ea. Header Stop	19 ^① 19 ^① 46 ^① 46 ^① 46 ^{SO} 39 ^{SO}
Extension				
	**8521E	928.063	Ea. RTS88 Spindle Extension	37 ^③

- ① Non-Fabricated item, ships in 1 business day
- ③ Non-Fabricated item, ships in 3 business days
- SO Special Fabricated/Finish or Special Order; lead time up to 5 weeks.

* If using with walking beam top portion, use only with walking beam pivot PT21 (801.117). Other walking beam pins may not engage properly.

** dormakaba recommends never combining RTS88 size BFI, BFE, or SZ2 closer with 8521E add-on extended spindle. These closers may not generate enough power to close and latch a door if used in combination with 8521E.

DRS Rails, Channels & Accessories
 Patch Fittings & Designer Pivots
 Offset Hung Patch Fittings
 Headers & Accessories
 Closers & Hardware
 Locksets
 Pulls & Handles
 Sliding Systems
 MANET
 Panic Hardware

BTS Floor Closers

How to Determine Hand of Door

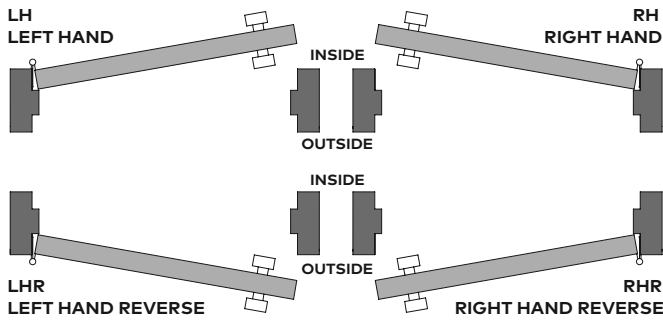

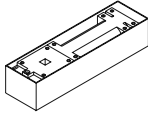
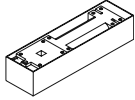
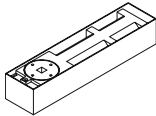
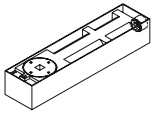
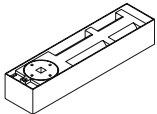
	Ref. #	U/M	Description	Finishes \$ 100/101
BTS75V Closers				①
	927.013	Ea.	HO 105°	570
	927.014	Ea.	HO 90°	570
	927.018	Ea.	NHO	550
BTS75V Closers – Barrier Free (BF)				
	927.016	Ea.	HO 90°	570
	927.017	Ea.	NHO	550
BTS80 Closers				
	927.020	Ea.	ANSI Size 4 (Standard)	590
	927.021	Ea.	ANSI Size 6 (Strong)	590
	927.019	Ea.	ANSI Size 3 (BFE)	590
BTS80 Closers – EMB (Electromagnetic Hydraulic Hold Open)				
	927.029	Ea.	ANSI Size 5 Left Hand	1,600 ⑤
	927.030	Ea.	ANSI Size 5 Right Hand	1,600 ⑤
BTS80F Closers (Fire Rated)				
	927.024	Ea.	ANSI Size 5 Left Hand	600 ⑩
	927.025	Ea.	ANSI Size 5 Right Hand	600 ⑩

- ① Non-Fabricated item, ships in 1 business day
- ⑤ Non-Fabricated item, ships in 5 business days
- ⑩ Special Fabricated/Finish or Special Order; lead time up to 5 weeks.

- NOTES:**
- Cement box included with all BTS closers listed above. Additional cement boxes available.
 - EMB handing determined from push side of door.

BTS Floor Closers

Covers and Cement Boxes

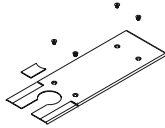
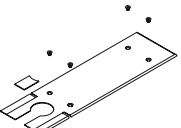
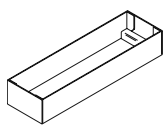
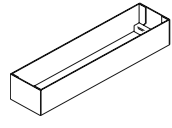
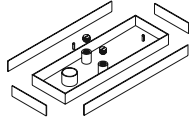
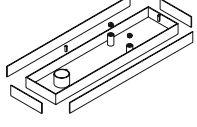
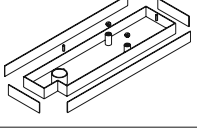
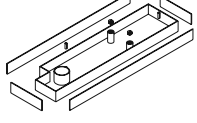











				Finishes \$			
Model	Ref. #	U/M	Description	503/599	600/602	*618/619	700/701
Covers and Cement Boxes				(SO)	(SO)	(SO)	(1)
	7510	927.043	Ea. BTS75V Cover	90	90	90	90
	7410	227.003	Ea. BTS80 Cover	95	95	95	95
							List \$
	927.007	Ea.	BTS75V Cement Box				44 (3)
	927.008	Ea.	BTS80 Cement Box				45 (3)
	TP75V	927.049	Ea. BTS75V Terrazzo Cover CH				256 (3)
	TP80CH	927.046	Ea. BTS80 Terrazzo Cover CH				275 (3)
	TP80LH	927.047	Ea. BTS80 Terrazzo Cover LH 3/4" (19 mm) Offset				300 (SO)
	TP80RH	927.048	Ea. BTS80 Terrazzo Cover RH 3/4" (19 mm) Offset				300 (SO)

- (1) Non-Fabricated item, ships in 1 business day
- (3) Non-Fabricated item, ships in 3 business days
- (SO) Special Fabricated/Finish or Special Order; lead time up to 5 weeks.

* 618 and 619 satin and polished nickel respectively are BHMA finish codes.



DRS Rails, Channels & Accessories
 Patch Fittings & Designer Pivots
 Offset Hung Patch Fittings
 Headers & Accessories
 Closers & Hardware
 Locksets
 Pulls & Handles
 Sliding Systems
 MANET
 Panic Hardware

BTS Spindles

	Model	Ref. #	U/M	Description	List \$
Bottom Spindles					
	74003	927.091	Ea.	5/16" (8 mm) Spindle	45 ^①
	74005	927.092	Ea.	1/2" (13 mm) Spindle	45 ^①
	74007	927.093	Ea.	5/8" (16 mm) Spindle	45 ^①
	74010	927.094	Ea.	3/4" (19 mm) Spindle	45 ^①
	74012	927.095	Ea.	13/16" (21 mm) Spindle	55 ^⑤
	74015	927.096	Ea.	7/8" (22 mm) Spindle	55 ^⑤
	74020	927.097	Ea.	1-1/8" (29 mm) Spindle	55 ^⑤
	74025	927.098	Ea.	1-5/16" (33 mm) Spindle	55 ^①
	74030	927.099	Ea.	1-1/2" (38 mm) Spindle	55 ^①
	74035	927.100	Ea.	1-11/16" (43 mm) Spindle	55 ^⑤
	74040	927.101	Ea.	1-7/8" (48 mm) Spindle	55 ^{⑤⑩}
	74045	927.102	Ea.	2-1/16" (52 mm) Spindle	55 ^{⑤⑩}
	74050	927.103	Ea.	2-5/16" (59 mm) Spindle	55 ^{⑤⑩}

① Non-Fabricated item, ships in 1 business day
 ⑤ Non-Fabricated item, ships in 5 business days
 ⑩ Special Fabricated/Finish or Special Order; lead time up to 5 weeks.









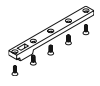
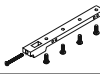
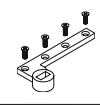

BTS Spindles

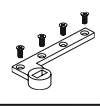
Model	Ref. #	U/M	Description	List \$
Bottom 3° Offset Spindles				
	80003	927.104	Ea. 5/16" (8 mm) Spindle Left Hand	45 ^①
		927.105	Ea. 5/16" (8 mm) Spindle Right Hand	45 ^①
	80005	927.106	Ea. 1/2" (13 mm) Spindle Left Hand	45 ^①
		927.107	Ea. 1/2" (13 mm) Spindle Right Hand	45 ^①
	80010	927.108	Ea. 3/4" (19 mm) Spindle Left Hand	45 ^①
		927.109	Ea. 3/4" (19 mm) Spindle Right Hand	45 ^①
	80015	927.110	Ea. 7/8" (22 mm) Spindle Left Hand	55 [Ⓢ]
		927.111	Ea. 7/8" (22 mm) Spindle Right Hand	55 [Ⓢ]
	80020	927.112	Ea. 1-1/8" (29 mm) Spindle Left Hand	55 [Ⓢ]
		927.113	Ea. 1-1/8" (29 mm) Spindle Right Hand	55 [Ⓢ]
	80025	927.114	Ea. 1-5/16" (33 mm) Spindle Left Hand	50 [Ⓢ]
		927.115	Ea. 1-5/16" (33 mm) Spindle Right Hand	50 [Ⓢ]
	80030	927.116	Ea. 1-1/2" (38 mm) Spindle Left Hand	50 [Ⓢ]
		927.117	Ea. 1-1/2" (38 mm) Spindle Right Hand	50 [Ⓢ]

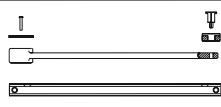
① Non-Fabricated item, ships in 1 business day
 Ⓢ Special Fabricated/Finish or Special Order; lead time up to 5 weeks.

- DRS Rails, Channels & Accessories
- Patch Fittings & Designer Pivots
- Offset Hung Patch Fittings
- Headers & Accessories
- Closers & Hardware
- Locksets
- Pulls & Handles
- Sliding Systems
- MANET
- Panic Hardware

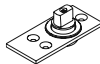
BTS Hardware



					Finishes \$				
Model	Ref. #	U/M	Description	100	108/109	503/599	600/601	700/701	
Bottom Arms				①					
 7421	227.001	Ea.	Bottom Arm	42	—	—	—	—	
 7422	227.002	Ea.	Bottom Arm	54	—	—	—	—	
Bottom 3/4" Offset Arm				101					
 75323	229.001	Ea.	COMPLETE Left Hand	71	71	71	71	71	
	229.002	Ea.	Right Hand	71	71	71	71	71	
 75323 COV	929.006	Ea.	Offset Arm Cover Left Hand	21	21	21	21	21	
	929.007	Ea.	Right Hand	21	21	21	21	21	
Bottom 1-1/2" Offset Arm									
 15323	229.011	Ea.	COMPLETE Left Hand	174	174	174	174	174	
	229.012	Ea.	Right Hand	174	174	174	174	174	
 15323 COV	929.037	Ea.	Offset Arm Cover Left Hand	26	26	26	26	26	
	929.038	Ea.	Right Hand	26	26	26	26	26	
 7451N/7453N	927.003	Ea.	Bottom Slide Arm	118 (100)					
Bottom/Floor Pivots				101/108 ^① 109 [Ⓢ]	503 ^① 599 [Ⓢ]	602	700/701 ^①	List \$	
 355.6	901.106 .001	Ea.	Adjustable Floor Pivot 5/16" (8 mm) to 1/2" (13 mm) (no cover)	—	—	—	—	61 ^①	
 355.5	901.079	Ea.	Adjustable Floor Pivot Cover Plate	18	21	22 [Ⓢ]	23	—	
 355.5	904.602	Ea.	Floor Pivot 5/16" (8 mm) Clearance	—	—	—	—	41 [Ⓢ]	
 355.5 ext 5 mm	904.771	Ea.	Floor Pivot 1/2" (13 mm) Clearance (5 mm ext.)	—	—	—	—	77 [Ⓢ]	
 355.5 ext 10 mm	904.772	Ea.	Floor Pivot 11/16" (18 mm) Clearance (10 mm ext.)	—	—	—	—	77 [Ⓢ]	
 355.5 ext 15 mm	904.773	Ea.	Floor Pivot 15/16" (23 mm) Clearance (15 mm ext.)	—	—	—	—	102 [Ⓢ]	

(see Handing Chart pg. 86)

① Non-Fabricated item, ships in 1 business day
 Ⓢ Special Fabricated/Finish or Special Order; lead time up to 5 weeks.

NOTE: 75323 & 15323 cover caps in 700 or 701 finish are Satin and Polished Chrome

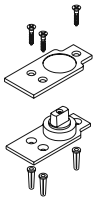
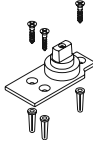
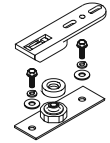
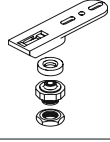
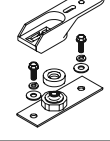
BTS Hardware

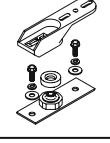
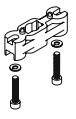
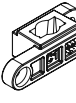
					Finishes \$				
Model	Ref. #	U/M	Description	101	108/109	503/599	600/601	700/701	
Floor Pivot with 3/4" Clearance				①	SO	SO	SO	①	
	7471K	229.003	Ea. COMPLETE	65	65	65	65	65	
		929.008	Ea. Floor Pivot Cover	21	21	24	24	24	①/SO
		929.017	Ea. Floor Pivot 3/4" (19 mm) Clearance (no cover)	42	—	—	—	—	
Floor Pivots									List \$
	7471K 5 mm ext.	929.018	Ea. Floor Pivot 15/16" (23 mm) Clearance (5 mm ext.) (no cover)						50 ⑥
	8852	928.055	Ea. Bottom Pivot 7/8" (22 mm) Web Depth (Adj. 3/8"(10 mm)-5/8" (16mm))						40 ①
	8855	928.058	Ea. Threshold Pivot 7/8" (22 mm) Web Depth (Adj. 3/16" (5 mm)-7/16" (11 mm))						49 ①
	8853	928.056	Ea. Bottom Pivot 1-9/16" (40 mm) Web Depth (Adj. 1/4" (6 mm)-1/2" (13 mm))						49 ①
	8856	928.059	Ea. Threshold Pivot 1-3/8" (35 mm) Web Depth (Adj. 3/16" (5 mm)-7/16" (11 mm))						49 ⑥
	8857	928.060	Ea. Bottom Pivot 1-9/16" (40 mm) Web Depth (Adj. 3/16" (5 mm)-7/16" (11 mm))						49 ⑥
Bottom Inserts									
	355.1	904.020	Ea. Rail Bottom Insert						27 ①
	319.1	903.105	Ea. Fitting Bottom Insert						20 ①

① Non-Fabricated item, ships in 1 business day
 ⑥ Non-Fabricated item, ships in 5 business days
 SO Special Fabricated/Finish or Special Order; lead time up to 5 weeks.

DRS Rails,
Channels &
Accessories

Patch Fittings
& Designer
Pivots

Offset
Hung Patch
Fittings

Headers &
Accessories

Closers &
Hardware

Locksets

Pulls &
Handles

Sliding
Systems

MANET

Panic
Hardware

Hardware

Shear Locks

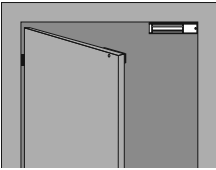
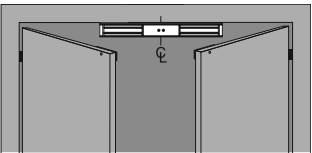
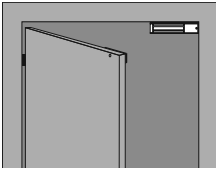
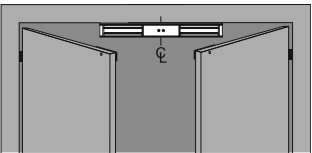
	Ref. #	U/M Description	Finishes \$
EMSL Shear Locks			700
	933.025	Ea. EMSL 2765 Shear Lock not installed	1,140 ³
EML Magnetic Locks			101 ³
	08114722	Ea. EML 310 electromagnetic lock, single door, 1,500 lb (680 kg)	430
	08114742	Ea. EML 310 BA DP electromagnetic lock, single door, 1,500 lb (680 kg) with BA bond sensor and DP door position sensor	570
	08114842	Ea. EML 320 electromagnetic lock, double door, 1,500 lb (680 kg)	820
	08114862	Ea. EML 320 BA DP electromagnetic lock, double door, 1,500 lb (680 kg) with BA bond sensor and DP door position sensor	1,080
	925.811	Ea. EML 371 electromagnetic lock, single door, 750 lb (340 kg)	330
	925.812	Ea. EML 371 BA DP electromagnetic lock, single door, 750 lb (340 kg) with BA bond sensor and DP door position sensor	445
	925.810	Ea. EML 372 electromagnetic lock, double door, 750 lb (340 kg)	660
	925.813	Ea. EML 372 BA DP electromagnetic lock, double door, 750 lb (340 kg) with BA bond sensor and DP door position sensor	890















³ Non-Fabricated item, ships in 3 business days

Model	Ref. #	Glass Thickness	Description	List \$
GDB14	08116170	1/2" (13 mm)	Glass door bracket for EML-310 mag lock, single	169
GDB16	08116180	3/4" (19 mm)	Glass door bracket for EML-310 mag lock, single	169
GDB24	08116190	1/2" (13 mm)	Glass door bracket for EML-320 mag lock, double	320
GDB26	08116200	3/4" (19 mm)	Glass door bracket for EML-320 mag lock, double	320
GDB714	08116210	1/2" (13 mm)	Glass door bracket for EML-371 mag lock, single	160
GDB716	08116220	3/4" (19 mm)	Glass door bracket for EML-371 mag lock, single	160
GDB724	08116230	1/2" (13 mm)	Glass door bracket for EML-372 mag lock, double	320
GDB726	08116240	3/4" (19 mm)	Glass door bracket for EML-372 mag lock, double	320

NOTE: Prices shown for EMSL or EML locks do not include factory fabrication or installation fees.

Hardware

Locks and Cylinders

Locks			List \$	
	925.019	Ea. Brass Lock 1-9/16" (40 mm) 5/8" (16 mm) Throw (DRS Rail)	36	①
	925.119	Ea. Brass Door Lock 1-9/16" (7/8" long throw fully retracted projects 1/4" below lock base)	50	⑤
	925.018	Ea. Brass Lock 1-15/16" 5/8" Throw. Not for use with DRS Rails. Requires 1-15/16" lock height clearance in rail.	38	⑤
	925.021	Ea. Extended Lock Bolt 1-7/8" (48 mm) (5/8" (16 mm) Throw, projects 1/4" (6 mm) below lock base when fully retracted) (DRS Rail)	14	⑤
	925.022	Ea. Square Lock Bolt	6	⑤⑥
Cylinders			108	①
			500/501	⑤⑥
	225.999	Ea. Mortise Key Cylinder/ Split Ring (DRS)	19	19
	225.998	Ea. Mortise Thumbturn Cylinder/ Split Ring (DRS)	19	19
	225.994	Ea. Mortise Blank (Dummy) Cylinder for (DRS) Lock, w/ split ring	13	13
	225.997	Ea. Mortise Key Cylinder/ Blocking Ring (AR20)	19	19
	225.996	Ea. Mortise Thumbturn Cylinder/ Blocking Ring (AR20)	19	19
	225.995	Ea. Mortise Blank (Dummy) Cylinder for AR20 Lock, w/split ring	13	13
	932.070	Ea. Mortise Cylinder Rose	15 (108 only)	15
			503/599	700
			①	/701
			⑤⑥	
	901.003	Ea. Profile Key Cylinder	81	60
	901.002	Ea. Profile Thumbturn Cyl. RH Lock Housing	78	66
	901.004	Ea. LH Lock Housing	78	66

- ① Non-Fabricated item, ships in 1 business day
- ⑤ Non-Fabricated item, ships in 5 business days
- ⑥ Special Fabricated/Finish or Special Order; lead time up to 5 weeks.

NOTES:



- For Cylinder and Keying Options such as KA, see **Cylinder Types, Keying Options, and Keyways.**
- LH housing requires RH profile thumbturn cylinder; RH housing requires LH profile thumbturn cylinder.

* When retracted, long throw extends beyond lock base by 1/4".

DRS Rails, Channels & Accessories
Patch Fittings & Designer Pivots
Offset Hung Patch Fittings
Headers & Accessories
Closers & Hardware
Locksets
Pulls & Handles
Sliding Systems
MANET
Panic Hardware

Hardware

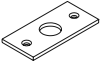
Strikes, Saddles, Threshold

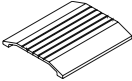
		Finishes \$					
	Ref #	U/M Description	101	109	500/501	503/599	600/601
Strikes							
	932.033	Ea. Dust Proof Strike Overall Length 1-1/2" (38 mm)	26 ^①	26 ^①	26 ^①	26 ^{SO}	26 ^{SO}
	925.140	Ea. Strike Plate		108/109	500		701
			7 ^③	7 ^③	8 ^③	8 ^③	7 ^③
	932.908	Ea. Adjustable Strike	27 ^{SO}				
Saddles and Thresholds			100				
	925.058	Ft. 1/2" (13 mm) x 4" (102 mm) Threshold Available @ 16' Length	14 ^{SO}				
							List \$
Miter	Miter cut charge per miter						61

- ① Non-Fabricated item, ships in 1 business day
- ③ Non-Fabricated item, ships in 3 business days
- SO Special Fabricated/Finish or Special Order; lead time up to 5 weeks.

NOTES:

- Must specify length when ordering. dormkaba will cut to specified size, priced per foot only.
- Maximum length for extrusions is 144" (3.66 m) before requiring a splice joint; 120" (3 m) for Brass and Bronze finishes.

Locksets for Glass Doors

CLM9000	Ordering Guide	96
	Housing and Strikes Options	97
	Cast or Forged Levers	99
	Cylinder Types, Keying Options, and Keyways	101
Studio and Junior	Studio Lockset Housings and Strikes	102
	Junior Office Lockset Housings and Strikes	104
	Junior Office Classic Lockset	105
	Studio and Junior Levers, Knobs, and Accessories	106
ARCOS	ARCOS Lockset Housings and Strikes	107
	ARCOS Accessories	108
Locks for Sliding Doors	Locksets, Strikes, and Handles	109

DRS Rails,
Channels &
AccessoriesPatch Fittings
& Designer
PivotsOffset
Hung Patch
FittingsHeaders &
AccessoriesClosers &
Hardware

Locksets

Pulls &
HandlesSliding
Systems

MANET

Panic
Hardware

CLM9000

Ordering Guide

Trim

L118A	– Premium Designer Lever and A Rose
L117A	– Premium Designer Lever and A Rose
L114A	– Premium Designer Lever and A Rose
L113A	– Premium Designer Lever and A Rose
L112A	– Premium Designer Lever and A Rose
L110A	– Premium Designer Lever and A Rose
L109A	– Premium Designer Lever and A Rose
LVA	– Premium Curved Lever and A Rose
LNA	– Tapered Lever and A Rose
LFA	– Premium Curved Lever and A Rose
LDA	– Swept Lever and A Rose
LAA	– Premium Tubular No Return Lever and A Rose
LGA	– Curved No Return Lever
LTA	– Tubular Lever and A Rose and A Rose
LCA	– Curved Lever and A Rose
LRA	– Rectangular Lever and A Rose

Lock Function

Classroom Intruder w/DB	9974
Storeroom	9080
Classroom	9070
Office/Entry (Alt FØ4)	9053
Office/Entry	9050
Passage/Closet	9010

Less Levers

Less Both Levers/Roses	LLL
Less Both Levers	LB
Less Inside Lever/Rose	LILR
Less Outside Lever/Rose	LOLR

Glass Thickness

3/8"	– 3/8"
1/2"	– 1/2"

See Page 101 for Keying Cylinder Options

CLM9	9053	D	Y		LRA	700	LHR	12MM	STRKHSNG	XXXX
-------------	-------------	----------	----------	--	------------	------------	------------	-------------	-----------------	-------------

Model	CLM9	Conventional	D	N	Satin Stainless	700	RH	– Right Hand	LS	Keying Options
		Combinated SFIC	C	Y		Finish	RHR	– Right Hand Reverse	STRKHSNG	
		Combination SFIC (6-Pin)	C6				LH	– Left Hand	WALLSTRK	
		SFIC w/Disposable Core	J				LHR	– Left Hand Reverse		
		SFIC w/Temporary Construction Core	T							
		Less Conventional Core	L							
		Housing Prepped for Schlage FSIC	R							

Cylinder Type

Lever Handles

Handing

CLM9000 Lockset Housing and Strikes

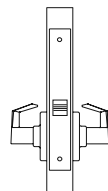
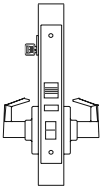
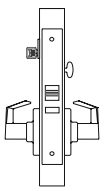
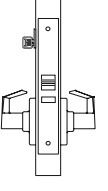
Model	Ref. #	U/M	Handing	Description	Finish \$
CLM9010 700				Passage/Closet — Latch bolt operated by trim either side	700
	211.948	Ea.	RH		802
	211.949	Ea.	LH		802
	211.950	Ea.	RHR		802
	211.951	Ea.	LHR		802
CLM9050 D KD 700				Office/Entry — Latch bolt operated by trim either side except when outside trim locked by stopworks. When outside trim locked, latch bolt retracted by key outside or operated by trim inside.	
	211.944	Ea.	RH		954
	211.945	Ea.	LH		954
	211.946	Ea.	RHR		954
	211.947	Ea.	LHR		954
CLM9053 D KD 700				Office/Entry — Latch bolt operated by trim either side except when outside trim locked by key outside or by inside turn. If outside trim locked, latch bolt actuated by key outside or trim inside. Outside trim remains locked until inside turn set to unlock position or unlocked by key. Auxiliary latch deadlocks latch bolt when door locked.	
	211.940	Ea.	RH		976
	211.941	Ea.	LH		976
	211.942	Ea.	RHR		976
	211.943	Ea.	LHR		976
CLM9070 D KD 700				Classroom — Latch bolt operates trim either side, except when outside trim locked by key outside. When outside trim locked, latch bolt operated by trim inside. Auxiliary latch deadlocks latch bolt.	
	211.962	Ea.	RH		954
	211.963	Ea.	LH		954
	211.964	Ea.	RHR		954
	211.965	Ea.	LHR		954

NOTE:

- Handing Based on American Standards (Opposite Euro DIN Standards)
- CLM9000 series does not come standard with a strike due to possible sidelite configurations. Customer must chose appropriate strike from the strike options page as an "add" option.

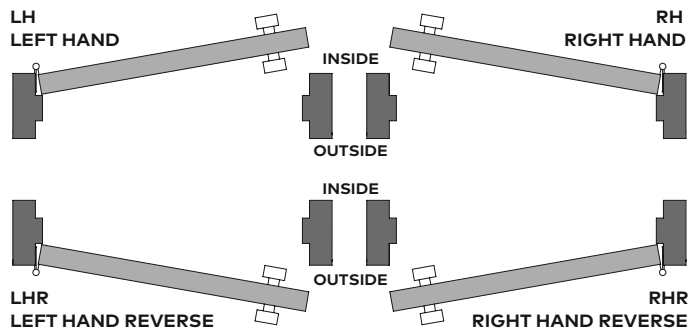

DRS Rails, Channels & Accessories

Patch Fittings & Designer Pivots

Offset Hung Patch Fittings

Headers & Accessories

Closers & Hardware

Locksets

Pulls & Handles

Sliding Systems

MANET

Panic Hardware

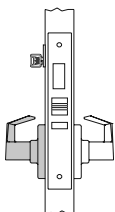
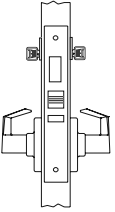
Model	Ref. #	U/M	Description	Finish \$
				700
CLM9080 D KD 700 	Configured Only (CF)*		Storeroom — Latch bolt retracted by key outside or trim inside. Outside trim always rigid. Auxiliary Latch deadlocks latch bolt.	(SO)
	CLM9080 RH	Ea.		954
	CLM9080 LH	Ea.		954
	CLM9080 RHR	Ea.		954
	CLM9080 LHR	Ea.		954
CLM9974 D KD 700 			Classroom/Intruder w/ Dead Bolt — Latch bolt operates trim either side, except when locked by projection of dead bolt. Dead bolt actuated by key either side. Inside trim operates both bolts, outside trim remains locked. Key either side unlocks outside trim allowing latch bolt actuation. Auxiliary latch deadlocks latch bolt.	
	CLM9974 RH	Ea.		1,022
	CLM9974 LH	Ea.		1,022
	CLM9974 RHR	Ea.		1,022
	CLM9974 LHR	Ea.		1,022

(SO) Special Fabricated/Finish or Special Order; lead time up to 5 weeks.







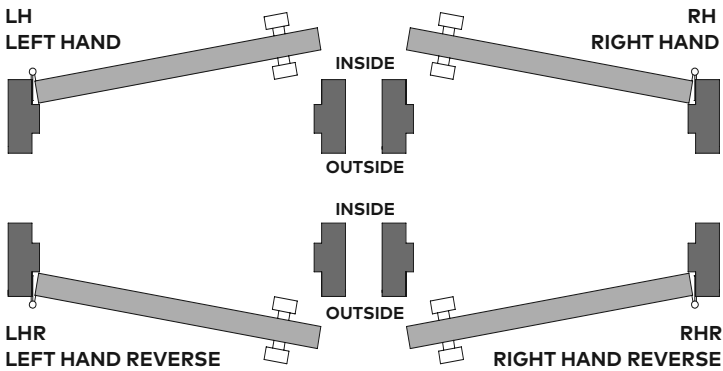

NOTES:

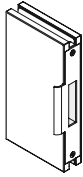
- Reference handing diagram and hand according to the locked side of the opening.
- Lever handles must be specified. Levers marked as N/C are included in the base price of the lockset. Other levers are an upcharge, listed accordingly, see page 106.
- Conventional "D" cylinder is part of base price, KD.
- For Cylinder and Keying Options such as KA, see **Cylinder Types, Keying Options, and Keyways.**
- Specify, 1/2" (12 mm) or 3/8" (10 mm) glass thickness.
- CLM9000 series does not come standard with a strike due to possible sidelite configurations. Customer must chose appropriate strike from the strike options page as an "add" option.

* CF product is configured to order only. No finished goods part numbers exist.

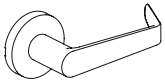



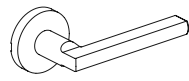



How to Determine Hand of Door

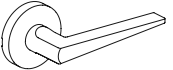

Model	Ref. #	UM	Description	Finish \$
CLM9000 Strikes (Strikes ordered independently of lock)				700
	211.921	Ea	Sidelite Mount Strike, Non-Handed (Cannot be used with 9974 deadbolt function)	650
	911.922	Ea	Strike for jamb/wall installation, No sidelite, Non-Handed	155
	911.923	Ea..	Handed Strike for CLM9974 jamb/wall installation (RH)	155
	911.924	Ea..	Handed Strike for CLM9974 jamb/wall installation (LH)	155
Standard Cast or Forged Levers		Handing		
	211.953	Ea.	LRA	N/C
	211.954	Ea.	LCA	N/C
	211.955	Ea.	LTA	N/C
	211.956	Ea.	LGA	N/C
			Supplied only in a complimentary 500 finish (BHMA 626)	
	L118A	Ea.	L118A	N/C

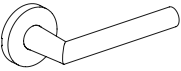
⑤ Custom Fabricated; lead time up to 5 business days.

DRS Rails, Channels & Accessories
Patch Fittings & Designer Pivots
Offset Hung Patch Fittings
Headers & Accessories
Closers & Hardware
Locksets
Pulls & Handles
Sliding Systems
MANET
Panic Hardware

					Finish \$
Model	Ref. #	U/M	Description		
Cast or Forged Levers					(S)
	211.952	Ea.	LAA		
	211.957	Ea.	LDA	Supplied only in a complimentary 500 finish (BHMA 626)	26
	211.958	Ea.	LNA	Supplied only in a complimentary 500 finish (BHMA 626)	26
	LFA	Ea.	LFA	Supplied only in a complimentary 500 finish (BHMA 626)	26
	LVA	Ea.	LVA	Supplied only in a complimentary 500 finish (BHMA 626)	26
	211.959	Ea.	L110A		
	211.961	Ea.	L114A	Supplied only in a complimentary 500 finish (BHMA 626)	26
	L109A	Ea.	L109A		
	L112A	Ea.	L112A		
	L117A	Ea.	L117A		

(S) Custom Fabricated; lead time up to 5 business days.

NOTES:

- All levers standard with "A" style Rose.
- "LL" = Less Lever/ Rose Set, deduct \$10.
- Lead time for premium levers will be determined by availability at the time order is placed. Premium levers are MTO (manufactured to order).

Cylinder Types, Keying Options, and Keyways

Cylinder	Option	Description	List Add/Deduct \$
Conventional Cylinders (non-interchangeable core)			
D		Conventional cylinder	Example: CLM9070D N/C
	KD	Keyed differently to a random combination; SC keyway with 2 keys (default)	N/C
	KA2	Keyed alike in pairs to a random combination; SC keyway with 2 keys	N/C
	KA4	Keyed alike in sets of 4 to a random combination; SC keyway with 2 keys	N/C
	0-Bit	Operated by a key blank for easy rekeying; SC, SE keyway with 2 keys	N/C
	0-Bit	Operated by a key blank for easy rekeying; D100 keyway — Keys sold separately	N/C
	0-Bit	Operated by a key blank for easy rekeying; AA, CA, CB, CC, CD, CE, RA, RB, GA, SF, WA, YA, YG keyways with 2 keys	12
	NSK	Non-stock keyed — KA quantities other than KA2/KA4; SC keyway with 2 keys	12
	MKD	Master keyed or SKD, SC, SE, or D100 keyway — Keys sold separately	16
	NS2	Non-stock keyed double cylinder locks; SC keyway with 2 keys	24
	MK2	Master keyed or SKD double cylinder lock; SC, SE, or D100 keyway — Keys sold separately	32
	CMK	Construction master keyed single cylinder locks — Keys sold separately	13
	CM2	Construction master keyed double cylinder locks — Keys sold separately	26
L		Lock less conventional cylinder and collar Small Format Interchangeable Core Cylinders	Example: CLM9070L Deduct 30
J		Lock with disposable plastic SFIC construction core	Example: CLM9070J N/C
T		Lock with keyed temporary SFIC construction core (Core may be returned for a full refund) — Keys sold separately	Example: CLM9070T 40
C		Lock with combined SFIC core installed at the factory; BA (default), BB, BC, BD, BE, BF, BG, BH, BJ, BK, BL, BM, BQ, D100 keyway — Keys sold separately	Example: CLM9070C 45
R		Housing prepared for Schlage FSIC	M9070R 8

Cut Keys Ordered Separately

Part #	Description	List \$
45101	Change key, master key, construction master key, or control key; BA, BB, BC, BD, BE, BF, BG, BH, BJ, BK, BL, BM, BQ, SC, SE section	5
45401	Change key, master key, or control key; SKC selections - D100 etc.	10

Locks will be supplied w/plastic construction core, Option J.

⊗ Denotes keys must be ordered separately.

NOTES:

- M9985D and M9986D are available MKD, CMK, or 0-bit only.
- Emergency keys for M9985D and M9986D are 45101 or 45401.
- D100 keyway is restricted. Call customer service for dormakaba SKC policies.

DRS Rails,
Channels &
AccessoriesPatch Fittings
& Designer
PivotsOffset
Hung Patch
FittingsHeaders &
AccessoriesClosers &
Hardware











Locksets

Pulls &
HandlesSliding
Systems

MANET

Panic
Hardware

Studio Lockset Housings and Strikes

Model	Ref. #	U/M	Description	Finishes \$			
				101	107	108/109	501/502
Studio Rondo – Lockset Housings for Jambs or Sidelite Applications							
Non-Locking							
	910.200	Ea.	3/8" (10 mm)	240 (5)	320 (5)	320 (SO)	466 (SO)
	210.200	Ea.	1/2" (12 mm)	240 (5)	320 (5)	320 (SO)	466 (SO)
Non-Locking, Lever at Latch End							
	910.201	Ea.	3/8" (10 mm)	240 (SO)	320 (SO)	320 (SO)	466 (SO)
	210.003	Ea.	1/2" (12 mm)	240 (SO)	320 (SO)	320 (SO)	466 (SO)
Locking (Prepared for Europrofile Cylinder)							
	910.202	Ea.	3/8" (10 mm)	240 (5)	320 (5)	320 (SO)	466 (SO)
	210.001	Ea.	1/2" (12 mm)	240 (5)	320 (5)	320 (SO)	466 (SO)
Locking, Privacy Function, Thumb Turn Included							
	910.206	Ea.	3/8" (10 mm)	350 (SO)	474 (SO)	410 (SO)	693 (SO)
	210.206	Ea.	1/2" (12 mm)	350 (SO)	474 (SO)	410 (SO)	693 (SO)
Strike Housing (Sidelite Mount)							
	910.220	Ea.	3/8" (10 mm)	259 (SO)	347 (SO)	371 (SO)	477 (SO)
	210.004	Ea.	1/2" (12 mm)	259 (SO)	347 (SO)	371 (SO)	477 (SO)
Studio Classic – Lockset Housings for Jambs or Sidelite Applications							
Non-Locking							
	910.001	Ea.	3/8" (10 mm)	240 (5)	320 (5)	410 (SO)	—
	210.012	Ea.	1/2" (12 mm)	240 (5)	320 (5)	410 (SO)	—
Non-Locking, Lever at Latch End							
	910.002	Ea.	3/8" (10 mm)	240 (5)	320 (5)	410 (SO)	—
	210.013	Ea.	1/2" (12 mm)	240 (5)	320 (5)	410 (SO)	—
Locking (Prepared for Euro Cylinder)							
	910.003	Ea.	3/8" (10 mm)	240 (5)	320 (5)	410 (SO)	—
	210.011	Ea.	1/2" (12 mm)	240 (5)	320 (5)	410 (SO)	—
Locking, Privacy Function, Thumb Turn Cylinder Included							
	910.006	Ea.	3/8" (10 mm)	350 (SO)	474 (SO)	540 (SO)	—
	210.006	Ea.	1/2" (12 mm)	350 (SO)	474 (SO)	540 (SO)	—
Strike Housing (Sidelite Mount)							
	910.005	Ea.	3/8" (10 mm)	259 (SO)	347 (5)	443 (SO)	—
	210.014	Ea.	1/2" (12 mm)	259 (SO)	347 (5)	443 (SO)	—

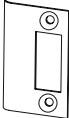
Model	Ref. #	U/M	Description	Finishes \$			
				101	107	108	501
Accessories for Studio Applications							
	Corner Strike Plate						
	910.401	Ea.	15/16" (24 mm) Return	25 (SO)	37 (SO)	34 (SO)	30 (SO)
	910.411	Ea.	5/8" (16 mm) Return	25 (SO)	37 (SO)	—	30 (SO)
	Strike Plate						
							599
	910.421	Ea.	Stainless Steel Base	—	17 (SO)	—	—
	910.422	Ea.	Brass Base	—	—	—	17



- (S) Custom Fabricated; lead time up to 5 business days.
- (SO) Special Fabricated/Finish or Special Order; lead time up to 5 weeks.

NOTES:

- Levers are ordered seperately for all locksets, See page 106.
- Studio Locksets are shipped right hand reverse. Field adjustable to left hand levers
- LHR Lockset Requires RH cylinder, RHR Lockset requires LH cylinder.

- DRS Rails, Channels & Accessories
- Patch Fittings & Designer Pivots
- Offset Hung Patch Fittings
- Headers & Accessories
- Closers & Hardware
- Locksets
- Pulls & Handles
- Sliding Systems
- MANET
- Panic Hardware

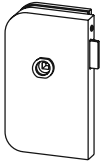
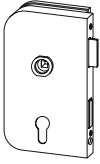
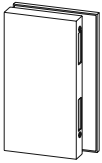
Junior Office Lockset Housings and Strikes

Model	Ref. #	U/M	Finishes \$						
			101	107	109	501/502			
Junior Office – Lockset Housings for Jamb or Sidelite Applications			(SO)	(SO)	(SO)	(SO)			
	Non-Locking								
	811.264	Ea. 3/8" (10 mm) LHR	210	287	290	—			
	811.265	Ea. 3/8" (10 mm) RHR	210	287	290	—			
	211.264	Ea. 1/2" (12 mm) LHR	210	287	290	—			
211.265	Ea. 1/2" (12 mm) RHR	210	287	290	—				
	Locking, (Prepared for Europrofile Cylinder)								
	811.260	Ea. 3/8" (10 mm) LHR	267	341	370	676			
	811.261	Ea. 3/8" (10 mm) RHR	267	341	370	676			
	211.260	Ea. 1/2" (12 mm) LHR	267	341	370	676			
211.261	Ea. 1/2" (12 mm) RHR	267	341	370	676				
	Strike Housing (Sidelite Mount)								
	811.206	Ea. 3/8" (10 mm) LHR	273	327	333	600			
	811.207	Ea. 3/8" (10 mm) RHR	273	327	333	600			
	211.206	Ea. 1/2" (12 mm) LHR	273	327	333	600			
211.207	Ea. 1/2" (12 mm) RHR	273	327	333	600				
Junior Models							599	602	619
	811.313	Ea. Strike Plate (Double)	54	—	—	—	—	—	
	911.313	Ea. Strike Plate (Double)	—	—	—	—	57	57	

(SO) Special Fabricated/Finish or Special Order; lead time up to 5 weeks.

NOTES:

- Levers are ordered separately for all locksets, see page 106.
- LHR Lockset requires RH cylinder; RHR Lockset requires LH cylinder.

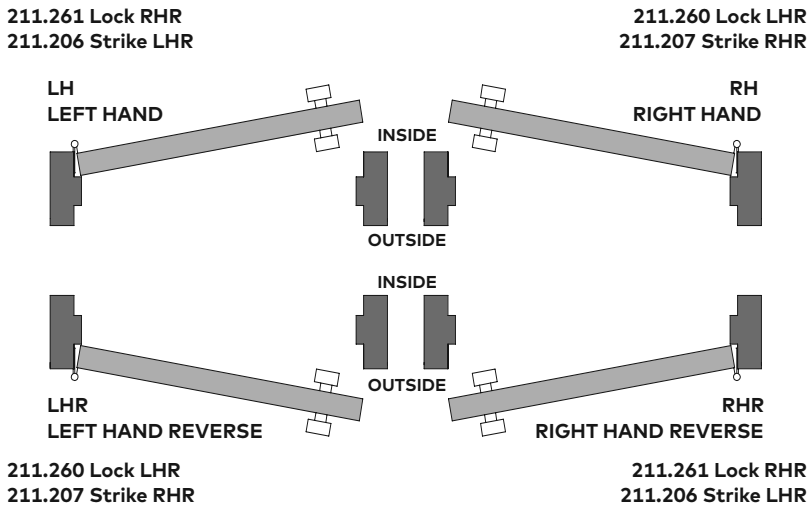

How to Determine Hand of Door



211.260 Lock LHR
211.207 Strike RHR

211.261 Lock RHR
211.206 Strike LHR

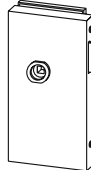
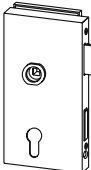
Junior Office Classic Lockset Housings and Strikes

				Finishes \$			
Model	Ref. #	U/M	Description	101	107	109	
Junior Office Classic – Lockset Housings for Jamb or Sidelight Applications				(SO)	(SO)	(SO)	
	Non-Locking						
	811.284	Ea.	3/8" (10 mm) LHR	239	287	373	
	811.285	Ea.	3/8" (10 mm) RHR	239	287	373	
	211.284	Ea.	1/2" (12 mm) LHR	239	287	373	
	211.285	Ea.	1/2" (12 mm) RHR	239	287	373	
	Locking (Prepared for Euro Cylinder)						
	811.280	Ea.	3/8" (10 mm) LHR	267	333	477	
	811.281	Ea.	3/8" (10 mm) RHR	267	333	477	
	211.280	Ea.	1/2" (12 mm) LHR	267	333	477	
	211.281	Ea.	1/2" (12 mm) RHR	267	333	477	
	Strike Housing (Sidelite Mount)						
	811.286	Ea.	3/8" (10 mm) LHR	245	327	373	
	811.287	Ea.	3/8" (10 mm) RHR	245	327	373	
	211.286	Ea.	1/2" (12 mm) LHR	245	327	373	
	211.287	Ea.	1/2" (12 mm) RHR	245	327	373	
Accessories					599	602	619
	811.313	Ea.	Strike Plate (Double)	54	—	—	—
	911.313	Ea.	Strike Plate (Double)	—	—	—	57 57 57

(SO) Special Fabricated/Finish or Special Order; lead time up to 5 weeks.

NOTES:



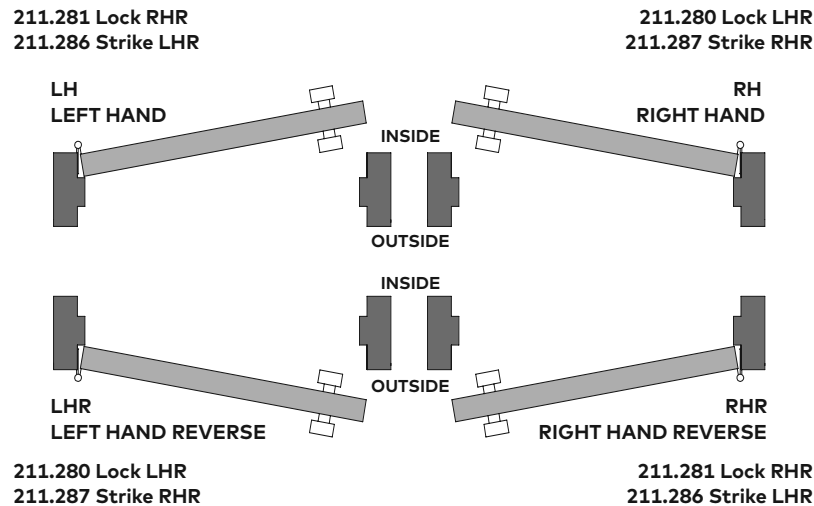

- Levers are ordered separately for all locksets, see page 106.
- LHR Lockset requires RH cylinder; RHR.
- Lockset requires LH cylinder.

How to Determine Hand of Door

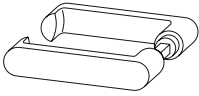

DRS Rails, Channels & Accessories
Patch Fittings & Designer Pivots
Offset Hung Patch Fittings
Headers & Accessories
Closers & Hardware
Locksets
Pulls & Handles
Sliding Systems
MANET
Panic Hardware

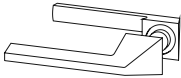
Studio and Junior Levers, Knob, and Accessories

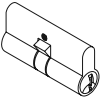
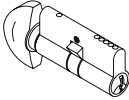
Model	Ref. #	U/M	Description	Finishes \$		
				101	107	199
Lever Sets						
	910.314	Ea.	Flat (471)	57 ⁽⁵⁾	74 ⁽⁵⁾	105 ^(SO)
	910.301	Ea.	Tubular (467.1)	127 ⁽⁵⁾	143 ⁽⁵⁾	183 ^(SO)
	910.304	Ea.	Flat Lever w/Knob One Side (450.20)	130 ^(SO)	190 ^(SO)	239 ^(SO)
	910.010	Ea.	Angular Lever	51 ^(SO)	79 ^(SO)	105 ^(SO)
	919.009	Ea.	Beveled	107 ^(SO)	143 ^(SO)	—
	910.305	Ea.	Knob, Round (450.0)	117 ^(SO)	140 ^(SO)	—
Lever Sets				503/599	700/701	
	901.003	Ea.	Profile Key Cylinder (Euro Cylinder)	81	60	
	901.002	Ea.	Profile Thumb Turn Cylinder, Right Hand Cam	78	66	
	901.004	Ea.	Left Handed Cam Add, Profile Thumb Turn Cylinder.	78	66	







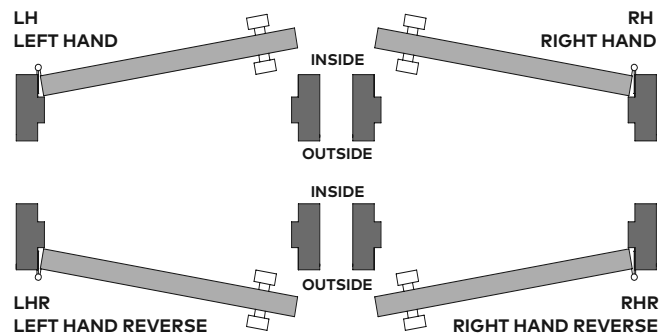

- ⁽⁵⁾ Custom Fabricated; lead time up to 5 business days.
- ^(SO) Special Fabricated/Finish or Special Order; lead time up to 5 weeks.

NOTES:

- Euro cylinders are KA by default and KD is a special order.
- LHR Lockset requires RH cylinder; RHR Lockset requires LH cylinder.
- For 108 or 109 finish requirements, specify 199 finish and specify "to be finished black or dark bronze." Check with factory for availability of 501 or 502 finish requirements.



ARCOS Lockset Housings and Strikes

Model	Ref. #	U/M Description	Finishes \$		
			107	108	114
ARCOS Studio – Lockset Housings for Jamb or Sidelite Applications			(SO)	(SO)	(SO)
Non-Locking					
	924.200	Ea. 3/8" (10 mm)	320	414	267
	224.200	Ea. 1/2" (12 mm)	320	414	267
Non-Locking, Lever at Latch End					
	924.201	Ea. 3/8" (10 mm)	320	414	267
	224.201	Ea. 1/2" (12 mm)	320	414	267
Locking, (Prepared for Euro Cylinder)					
	924.202	Ea. 3/8" (10 mm)	320	414	267
	224.202	Ea. 1/2" (12 mm)	320	414	267
Locking, Privacy Function, Thumb Turn Included					
	924.206	Ea. 3/8" (10 mm)	473	537	397
	224.206	Ea. 1/2" (12 mm)	473	537	397
Strike Housing (Sidelite Mount)					
	924.220	Ea. 3/8" (10 mm)	280	359	235
	224.220	Ea. 1/2" (12 mm)	280	359	235
ARCOS Office – Lockset Housings for Jamb or Sidelite Applications					
Non-Locking					
	825.264	Ea. 3/8" (10 mm) LHR	303	399	224
	825.265	Ea. 3/8" (10 mm) RHR	303	399	224
	225.264	Ea. 1/2" (12 mm) LHR	303	399	224
	225.265	Ea. 1/2" (12 mm) RHR	303	399	224
Locking (Prepared for Euro Cylinder)					
	825.260	Ea. 3/8" (10 mm) LHR	357	506	282
	825.261	Ea. 3/8" (10 mm) RHR	357	506	282
	225.260	Ea. 1/2" (12 mm) LHR	357	506	282
	225.261	Ea. 1/2" (12 mm) RHR	357	506	282
Strike Housing (Sidelite Mount)					
	825.206	Ea. 3/8" (10 mm) LHR	343	416	264
	825.207	Ea. 3/8" (10 mm) RHR	343	416	264
	225.206	Ea. 1/2" (12 mm) LHR	343	416	264
	225.207	Ea. 1/2" (12 mm) RHR	343	416	264

(SO) Special Fabricated/Finish or Special Order; lead time up to 5 weeks.

NOTES:

- Levers are ordered separately for all locksets. See ARCOS Accessories.
- ARCOS Studio Locksets are shipped right hand reverse. Field adjustable to left hand reverse.
- ARCOS Office Locksets left hand reverse shown.
- LHR Lockset requires RH cylinder; RHR Lockset requires LH cylinder.

DRS Rails, Channels & Accessories

Patch Fittings & Designer Pivots

Offset Hung Patch Fittings

Headers & Accessories

Closers & Hardware

Locksets

Pulls & Handles

Sliding Systems

MANET

Panic Hardware

ARCOS Accessories

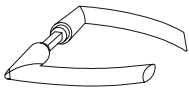
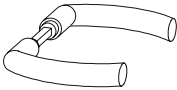
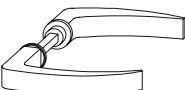
Model	Ref. #	U/M	Description	Finishes \$		
				107	114	199
Sets of Levers for Locks with Strikes				(SO)	(SO)	(SO)
	924.301	Ea.	Tubular, Mitered	172	163	242
	924.302	Ea.	Tubular, Oval	172	163	242
	924.303	Ea.	Chiseled	192	181	259

NOTE: For 108 or 109 finish requirements, specify 199 finish and specify "to be finished black or dark bronze."

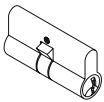
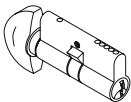
Model	Ref. #	U/M	Description	Finishes \$	
				503/599	700/701
Europrofile Accessories					
	901.003	Ea.	Profile Key Cylinder (Euro Cylinder)	81	60
	901.002	Ea.	Profile Thumb Turn Cylinder, Right Hand Cam	78	66
	901.004	Ea.	Profile Thumb Turn Cylinder, Left Hand Cam	78	66



(SO) Special Fabricated/Finish or Special Order; lead time up to 5 weeks.

NOTES:

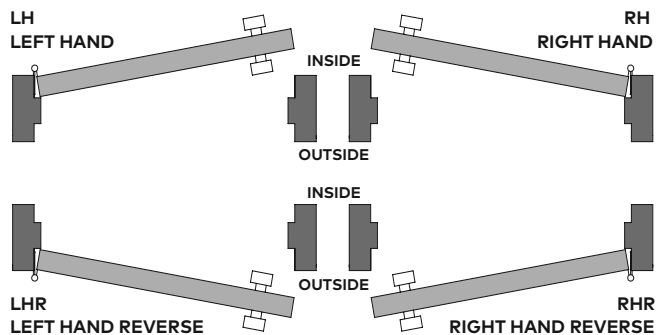
- Euro cylinders are KA by default and KD is a special order.
- LHR Lockset requires RH cylinders, RHR Lockset requires LH cylinder.

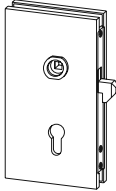
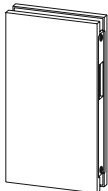

Locksets, Strikes, and Handles

Model	Ref. #	U/M	Finishes \$		
			101	105/107	108/109
Hook Lock					
	905.202	Ea. (Includes wall mounted strike plate)	367 (SO)	477 (SO)	612 (SO)
Strike Box					
	905.201	Ea.	367 (SO)	434 (SO)	612 (SO)
199					
Set of Flat Lever Handles					
	910.314	Set	57 (5)	74 (SO)	105 (SO)
Set of Tubular Lever Handles					
	910.301	Set	127 (5)	143 (SO)	183 (SO)
107					
Flush Pull					
	907.200	Set	125 (1)	188 (1)	188 (SO)

- (5) Custom Fabricated; lead time up to 5 business days.
- (1) Non-Fabricated item, ships in 1 business day.
- (SO) Special Fabricated/Finish or Special Order; lead time up to 5 weeks.

NOTES:

- Cylinders supplied keyed different (KD). For other cylinder and keying options such as keyed alike (KA) See **Cylinder Types, Keying Options, and Keyways.**
- For 108 or 109 finish requirements, specify 199 finish and specify "to be finished black or dark bronze."

- DRS Rails, Channels & Accessories
- Patch Fittings & Designer Pivots
- Offset Hung Patch Fittings
- Headers & Accessories
- Closers & Hardware
- Locksets
- Pulls & Handles
- Sliding Systems
- MANET
- Panic Hardware

Pulls and Handles for Tempered Glass Doors

TG 138 Ladder Pulls	Ordering Guide	112
	TG 138 Locking and Non-Locking Single and Back-to-Back Ladder Pulls	113
	TG 138 Accessories	114
TG 9000 Ladder Pulls	TG 9387 Non-Locking Single and Back-to-Back Ladder Pulls	117
MANET Pulls	MANET Decorative Non-Locking Single and Back-to-Back Ladder Pulls	120
TG Decorative Pulls	TG 9000 Decorative Pulls and Handles	122
ARCOS and BEYOND Pulls	ARCOS and BEYOND Decorative Pulls and Handles	124
Economy Pulls	Economical Tubular and Solid Pulls and Handles	125

DRS Rails,
Channels &
AccessoriesPatch Fittings
& Designer
PivotsOffset
Hung Patch
FittingsHeaders &
AccessoriesClosers &
Hardware

Locksets

Pulls &
HandlesSliding
Systems

MANET

Panic
Hardware

TG 138 Ladder Pulls

Ordering Guide

Screwpack Options

ROSE	– Sex Nut, up to 3-5/16"
SNUT	– Sex Nut, up to 3-5/16"
BLIND	– 1-3/4" wood door, not through door
B2B80	– Back-to-back up to 3-5/16" thick door
B2B44	– Back-to-back 1-3/4" wood
B2B19	– Back-to-back 3/4" glass
B2B12	– Back-to-back 1/2" glass, STD. Pkg

Door Thickness



134	– 1-3/4" Wood Door
75	– 3/4" Glass
STD	– 3/8" or 1/2" Glass

Function

Locking –	L
Non-Locking –	NL

TG 138	NL	B2B	STD	49		B2B12	700	XXXX
TG 138	Back-To-Back –	B2B	49" Length –	49	75ADAPT	Satin Stainless –	700	Keying Options Field
Model	Single Sided –	SNG	60" Length –	60	Accessories	Custom Polished finish –	701	
		Pull Type	72" Length –	72		Custom Paint or Powder –	999	
			84" Length –	84		Finish		
			XX" (Specify) Length –	Custom				
				(L) Length				

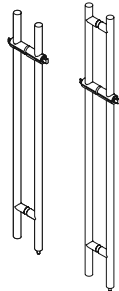
TG 138 Locking and Non-Locking Ladder Pulls

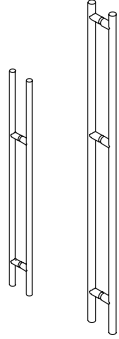
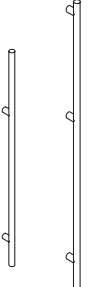
Locking Ladder Pull Configurations Single and Back-To-Back Locking and Non-Locking Pulls					Standard Finish \$		Custom Finish \$	
Model	Ref. #	U/M	No. Of Fixing Posts	Description	700	701	999	
Back-to-Back Locking Ladder Pull with Small Format Interchangeable Core (SFIC) Cylinder, Less Core (00)					3	(S0)	(S0)	
	926.933	Set	3F	L B2B STD 84" 700	1,425	1,853	—	
	926.932	Set	3F	L B2B STD 72" 700	1,388	1,804	—	
	926.936	Set	3F	L B2B STD 60" 700	1,354	1,760	—	
	926.930	Set	2F	L B2B STD 49" 700	1,298	1,687	—	
Single Sided Locking Ladder Pull with (CYL) Cylinder (SFIC), Less Core (00), or Thumb-Turn (TT)								
	926.934	Ea.	2F	L SNG STD 49" CYL 700	720	936	—	
	926.935	Ea.	2F	L SNG STD 49" TT 700	720	936	—	
NOTE: Cylinder or Thumb-Turn are Top Mounted								
Back-to-Back Non-Locking Ladder Pull								
	926.923	2 Ea.	3F	NL B2B STD 84" 700	622	809	822	
	926.922	2 Ea.	3F	NL B2B STD 72" 700	588	764	788	
	926.924	2 Ea.	3F	NL B2B STD 60" 700	551	716	751	
	926.920	2 Ea.	2F	NL B2B STD 49" 700	495	644	695	
NOTE: Non-locking ladder pulls are stocked in single units. Specify 2 Ea. during ordering for a back-to-back set. Includes appropriate fixings.								
Single Sided Non-Locking Ladder Pull								
	926.923	Ea.	3F	NL SNG STD 84" 700	361	469	481	
	926.922	Ea.	3F	NL SNG STD 72" 700	341	443	461	
	926.924	Ea.	3F	NL SNG STD 60" 700	320	416	440	
	926.920	Ea.	2F	NL SNG STD 49" 700	287	373	407	
NOTE: Customer must specify Fixing Pack and adjust List Price accordingly for Non-Locking Single Ladder Pulls.								

(S0) Special Fabricated/Finish or Special Order; lead time up to 9 weeks.



3 Standard or Non-Standard Fabricated; lead time up to 3 business days.

NOTES:

- Default cylinder for TG 138 L pulls uses "87" Small Format Interchangeable Core (SFIC) cylinder, less core (00).
- Other cylinder and keying options available, see **Cylinder Types, Keying Options, and Keyways**.
- 999 Finish is Custom Paint and Powder only.
- Default glass thickness is 3/8" - 3/4" for non-locking pulls. For locking pulls default glass thickness is 3/8" - 5/8". For locking pulls with 3/4" thick glass order 926.911 from following page.

DRS Rails, Channels & Accessories
Patch Fittings & Designer Pivots
Offset Hung Patch Fittings
Headers & Accessories
Closers & Hardware
Locksets
Pulls & Handles
Sliding Systems
MANET
Panic Hardware

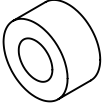
TG 138 Locking and Non-Locking Ladder Pulls Accessories

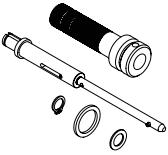
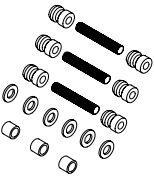
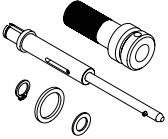
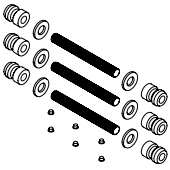
Mounting	Ref. #	Description	List \$
	926.891	Adaptor, .75 adaptor allows NL Pull to install in Locking Post Prep	5
	926.937	Strike, Dustproof, Standard 1-1/8" (29 mm)	37
Door Thickness			
	926.890	Locking Post Mounting Pack, Back-to-back, (Non-Locking Post— Fasteners not included)	202
	926.941	Mounting Pack, Back-to-back, Non-Locking	44
	926.911	Locking Post Mounting Pack, Back-to-back, (Non-Locking Post— Fasteners not included)	212
	926.909	Mounting Pack, Back-to-back Non-Locking Post	53

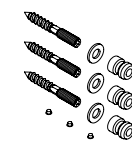
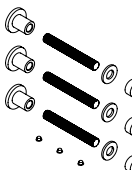
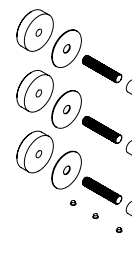
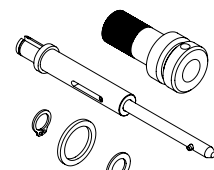
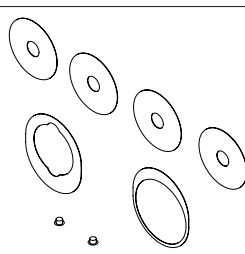
Mounting	Ref. #	Description	Door Thickness	List \$
	926.910	Mounting Pack, SNG Blind, 3 each in pack (Will not project through door)	min. 1-3/4" (44 mm)	25
	926.908	Mounting Pack, Single Non-Locking x Sex Nut	3/4" (19 mm) – 3-1/8" (80 mm)	56
	926.906	Mounting Pack, Single Non-Locking x Rose	3/8" (10 mm) – 3/4" (19 mm)	54
	926.938	Locking Post Replacement Set for Standard 1/2" Glass Thickness	1/2" (13 mm)	112
	926.939	Washer Pack		14

 Special Fabricated/Finish or Special Order; lead time up to 9 weeks.

NOTE: Default cylinder for Locking Ladder pulls uses **87** Small Format Interchangeable Core (SFIC) cylinder, less core (00). Other cylinder and keying options available, see next page.

- DRS Rails, Channels & Accessories
- Patch Fittings & Designer Pivots
- Offset Hung Patch Fittings
- Headers & Accessories
- Closers & Hardware
- Locksets
- Pulls & Handles
- Sliding Systems
- MANET
- Panic Hardware

TG 138 Cylinder Types, Keying Options, and Keyways

Cylinder Option	Description	List Add \$
Conventional Cylinders (non-interchangeable core)		
D	Conventional cylinder; Example: CML9070D	N/C
KD	Keyed differently to a random combination; SC keyway with 2 keys (default)	N/C
KA2	Keyed alike in pairs to a random combination; SC keyway with 2 keys	N/C
KA4	Keyed alike in sets of 4 to a random combination; SC keyway with 2 keys	N/C
0-Bit	Operated by a key blank for easy rekeying; SC, SE keyway with 2 keys	N/C
0-Bit	Operated by a key blank for easy rekeying; D100 keyway – ⊗ Keys sold separately	N/C
0-Bit	Operated by a key blank for easy rekeying; AA, CA, CB, CC, CD, CE, RA, RB, GA, SF, WA, YA, YG keyways with 2 keys	12
NSK	Non-stock keyed – KA quantities other than KA2/KA4; SC keyway with 2 keys	12
MKD	Master keyed or SKD, SC, SE, or D100 keyway – ⊗ Keys sold separately	16
NS2	Non-stock keyed double cylinder locks; SC keyway with 2 keys	24
MK2	Master keyed or SKD double cylinder lock; SC, SE, or D100 keyway – ⊗ Keys sold separately	32
CMK	Construction master keyed single cylinder locks – ⊗ Keys sold separately	13
CM2	Construction master keyed double cylinder locks – ⊗ Keys sold separately	26
L	Lock less conventional cylinder and collar Small Format Interchangeable Core Cylinders; Example: CML9070L	Deduct 30
J	Lock with disposable plastic SFIC construction core; Example: CML9070J	N/C
T	Lock with keyed temporary SFIC construction core; Example: CML9070T (Core may be returned for a full refund) – ⊗ Keys sold separately;	40
C	Lock with combined SFIC core installed at the factory ¹ ; BA (default), BB, BC, BD, BE, BF, BG, BH, BJ, BK, BL, BM, BQ, D100 keyway; Example: CML9070C – ⊗ Keys sold separately	45
R	Housing prepared for Schlage FSIC; Example: CML9070R	8

Ladder Pulls will be supplied w/plastic construction core, Option J.

⊗ Denotes keys must be ordered separately.

Cut Keys Ordered Separately

Part #	Description	List \$
45101	Change key, master key, construction master key, or control key; BA, BB, BC, BD, BE, BF BG, BH, BJ, BK, BL, BM, BQ, SC, SE section	6
45401	Change key, master key, or control key; SKC selections – D100 etc.	10

NOTE: D100 keyway is restricted. Call customer service for dormakaba SKC policies.

TG 9387 Ladder Pulls

Ordering Guide

		Door Thickness				SNG Mounting Type	
3/8" Thick Glass Screw Pack	—	3/8				ROSE	— Screw-on-Rose
1/2" Thick Glass Screw Pack	—	1/2				BLIND	— Concealed
5/8" Thick Glass Screw Pack	—	5/8					
3/4" Thick Glass Screw Pack	—	3/4					
1-3/8" Thick Wood Screw Pack	—	138					
1-3/4" Thick Wood Screw Pack	—	134					
>1-3/4" Thick Wood Screw Pack	—	other					

S-TG 9387	SNG	134	18	BLIND	700
------------------	------------	------------	-----------	--------------	------------

S-TG 9387	Single Sided — SNG	12" Length — 12	DORMA 700/ BHMA 630	700
Model	Back-To-Back — B2B	18" Length — 18		
	Pull Type	36" Length — 36		
		42" Length — 42		
		60" Length — 60		
		(L) Length		Finish



Stock TG 9387 Standard Size Non-Locking Ladder Pulls, with Straight Fixing Posts

Stock Pull Handles for 1/2" Glass Doors						Finish \$
Model	Ref. #	U/M	No. Of Fixing Posts	Description		700
Back-to-Back 1-1/4" (32 mm) Dia.						3
	B2B.905.370	Set	3F	L = 60" CTC = 37-1/2"		245
	B2B.905.371	Set	2F	L = 42" CTC = 26-1/4"		168
	B2B.905.372	Set	2F	L = 36" CTC = 22-1/2"		152
	B2B.905.373	Set	2F	L = 18" CTC = 11-1/4"		122
	B2B.905.382	Set	2F	L = 18" CTC = 12"		122
	B2B.905.374	Set	2F	L = 12" CTC = 7-1/2"		114
Single Sided 1-1/4" (32 mm) Dia.						3
	SNG.905.370	Ea.	3F	L = 60" CTC = 37-1/2"		125
	SNG.905.371	Ea.	2F	L = 42" CTC = 26-1/4"		85
	SNG.905.372	Ea.	2F	L = 36" CTC = 22-1/2"		77
	SNG.905.373	Ea.	2F	L = 18" CTC = 11-1/4"		62
	SNG.905.382	Ea.	2F	L = 18" CTC = 12"		62
	SNG.905.374	Ea.	2F	L = 12" CTC = 7-1/2"		58
						Net Add \$
POWDER	All Custom powder coated orders will include a net charge per purchase order.					200

NOTES:

- Prefix Ref. # with (SNG) single or (B2B) back-to-back. Specify part number, pull height, door material, and door thickness. For single pull on wood door, specify roses or blind fasteners.
- Inserts and mounting hardware included in stock pull TG 9387, list price as shown.
- Mounting hardware also available as multi-pack service packs and priced separately following pulls.

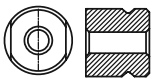
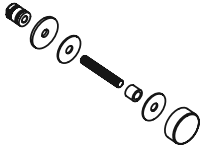
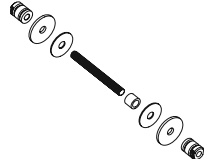
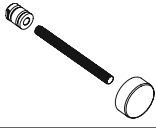
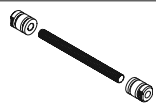
DRS Rails, Channels & Accessories
Patch Fittings & Designer Pivots
Offset Hung Patch Fittings
Headers & Accessories
Closers & Hardware
Locksets
Pulls & Handles
Sliding Systems
MANET
Panic Hardware

Model	Ref. #	U/M	Description	List \$
	905.390	Set	Service inserts, reduces post thread from 8 mm – 6 mm, used for every mounting post. Bulk pack of 6. Used as service item.	7
	905.387	Set	Service mounting pack with finished mounting ROSE used for SNG GLASS mount 3/8" – 3/4" (10 mm – 19 mm). Bulk pack of 6. Used as service item.	42
	905.385	Set	Service mounting pack used for BACK-TO-BACK GLASS mount 3/8" – 3/4" (10 mm – 19 mm). Bulk pack of 6. Used as service item.	42
	905.388	Set	Service mounting pack with finished mounting ROSE used for SNG WOOD mount 1-3/8" – 2" (40 mm – 51 mm). Bulk pack of 6. Used as service item.	33
	905.386	Set	Service mounting pack used for BACK-TO-BACK WOOD mount 1-3/8" – 2" (40 mm – 51 mm). Bulk pack of 6. Used as service item.	17
	905.389	Set	Service mounting pack with BLIND (concealed) fasteners, used for SNG WOOD mount ≥ 1-3/8" (40 mm). Bulk pack of 6. Used as service item.	17

øG	1-1/4" (32)					
øS	1" (25)					
H	3-3/8" (85)					
3 fixings required	60" (1,524)					
(CTC) Center-to-Center	37-1/2" (953)	26-1/4" (667)	22-1/2" (571)	11-1/4" (286)	12" (305)	7-1/2" (191)
L (Length)	60" (1,524)	42" (1,067)	36" (914)	18" (457)	18" (457)	12" (305)

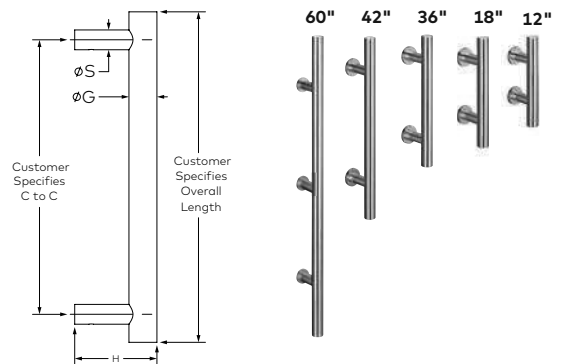

TG 9387 Custom Size Non-Locking Ladder Pulls, with Straight Fixing Posts

Pull Handles for 1/2" Glass Doors, Includes Fixings for 1/2" Glass & Roses					Standard Finish \$		Custom Finish \$
Model	Ref. #	U/M	No. Of Fixing Posts	Description	700	701	999
Back-to-Back 1-1/4" (32 mm) Dia.					(SO)	(SO)	(SO)
	905.568	Ea.	3F	L = 94-1/2" through 110-3/16"	1,091	1,200	1,491
	905.567	Ea.	3F	L = 74-13/16" through 94-7/16"	944	1,038	1,344
	905.566	Ea.	2F	L = 59-1/16" through 74-3/4"	797	877	1,197
	905.565	Ea.	2F	L = 43-5/16" through 59"	650	715	950
	905.564	Ea.	2F	L = 27-9/16" through 43-1/4"	503	553	803
	905.563	Ea.	2F	L = 11-13/16" through 27-1/2"	355	391	655
Single Sided 1-1/4" (32 mm) Dia.							
	905.368	Ea.	3F	L = 94-1/2" through 110-3/16"	645	710	845
	905.367	Ea.	3F	L = 74-13/16" through 94-7/16"	565	622	765
	905.366	Ea.	2F	L = 59-1/16" through 74-3/4"	485	534	685
	905.365	Ea.	2F	L = 43-5/16" through 59"	405	446	555
	905.364	Ea.	2F	L = 27-9/16" through 43-1/4"	325	358	475
	905.363	Ea.	2F	L = 11-13/16" through 27-1/2"	244	268	394
Back-to-Back 1" (25 mm) Dia.							
	905.527	Ea.	3F	L = 94-1/2" through 110-3/16"	950	1,045	1,350
	905.526	Ea.	3F	L = 74-13/16" through 94-7/16"	845	930	1,245
	905.525	Ea.	3F	L = 59-1/16" through 74-3/4"	740	814	1,140
	905.524	Ea.	2F	L = 43-5/16" through 59"	635	699	935
	905.523	Ea.	2F	L = 27-9/16" through 43-1/4"	530	583	830
	905.522	Ea.	2F	L = 11-13/16" through 27-1/2"	425	468	725
Single Sided 1" (25 mm) Dia.							
	905.327	Ea.	3F	L = 94-1/2" through 110-3/16"	616	678	816
	905.326	Ea.	3F	L = 74-13/16" through 94-7/16"	549	604	749
	905.325	Ea.	3F	L = 59-1/16" through 74-3/4"	482	530	682
	905.324	Ea.	2F	L = 43-5/16" through 59"	415	457	565
	905.323	Ea.	2F	L = 27-9/16" through 43-1/4"	348	383	498
	905.322	Ea.	2F	L = 11-13/16" through 27-1/2"	280	308	430

Net Add \$

POWDER All Custom powder coated orders will include a **net charge** per purchase order.

200

øG	1" (25)	1-1/4" (32)
øS	11/16" (18)	1" (25)
H	2-15/16" (75)	3-3/8" (85)
3 fixings required	59-1/16" (1,500)	59-1/16" (1,500)

(SO) Special Fabricated/Finish or Special Order; lead time up to 5 weeks.

NOTES:

- When required, 3rd fixing post is centered on L dimension unless otherwise requested. Any center distance specifically tailored to your requirements.
- Specify door thickness and desired screwpack.

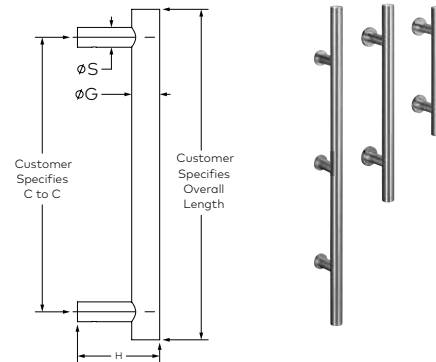

DRS Rails, Channels & Accessories
Patch Fittings & Designer Pivots
Offset Hung Patch Fittings
Headers & Accessories
Closers & Hardware
Locksets
Pulls & Handles
Sliding Systems
MANET
Panic Hardware

MANET Non-Locking Ladder Pulls, with Straight Fixing Posts and Manet Clamping Disks

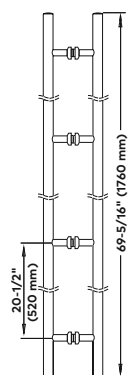
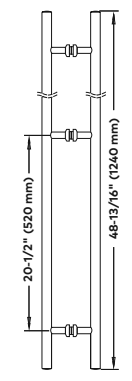
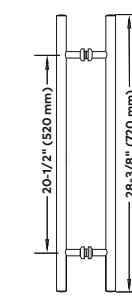
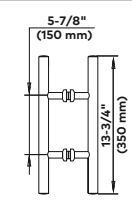
Pull Handles for 3/8" (9 mm) or 1/2" (12 mm) Glass Doors, Back-to-Back (B2B) or Single Sided					Standard Finish \$	Custom Finish \$
Model	Ref. #	U/M	No. Of Fixing Posts	Description	700	999
Back-To-Back					①	SO
	821.276	Ea.	4F	20-1/2" (520 mm) Center-to-Center Length 69-5/16" (1760 mm)	607	1,162
	821.273	Ea.	3F	20-1/2" (520 mm) Center-to-Center Length 48-13/16" (1240 mm)	505	1,068
	821.270	Ea.	2F	20-1/2" (520 mm) Center-to-Center Length 28-3/8" (720 mm)	379	679
	821.267	Ea.	2F	5-7/8" (150 mm) Center-to-Center Length 13-3/4" (350 mm)	294	594
Net Add \$						
POWDER	All Custom powder coated orders will include a net charge per purchase order.					200

- ① Non-Fabricated item, ships in 1 business day
- SO Special Fabricated/Finish or Special Order; lead time up to 5 weeks.

NOTES:

- Specify door thickness.
- Specify 829.991 for 1-3/4" (44 mm) wood door fasteners, no additional charge.

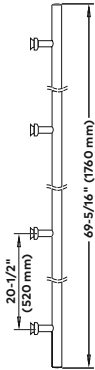
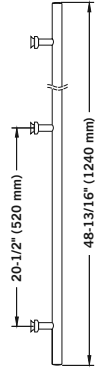
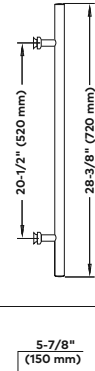
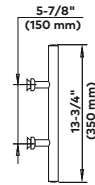
Pull Handles for 3/8" (9 mm) or 1/2" (12 mm) Glass Doors, Back-to-Back (B2B) or Single Sided					Standard Finish \$	Custom Finish \$
Model	Ref. #	U/M	No. Of Fixing Posts	Description	700	999
Single Sided					(SO)	(SO)
	821.243	Ea.	4F	20-1/2" (520 mm) Center-to-Center Length 69-5/16" (1760 mm)	474	674
	821.242	Ea.	3F	20-1/2" (520 mm) Center-to-Center Length 48-13/16" (1240 mm)	385	585
	821.241	Ea.	2F	20-1/2" (520 mm) Center-to-Center Length 28-3/8" (720 mm)	267	417
	821.240	Ea.	2F	5-7/8" (150 mm) Center-to-Center Length 13-3/4" (350 mm)	219	369

Net Add \$

POWDER All Custom powder coated orders will include a **net charge** per purchase order. 200

(SO) Special Fabricated/Finish or Special Order; lead time up to 5 weeks.

NOTES:

- Specify door thickness.
- Specify 829.991 for 1-3/4" (44 mm) wood door fasteners, no additional charge.

DRS Rails, Channels & Accessories
Patch Fittings & Designer Pivots
Offset Hung Patch Fittings
Headers & Accessories
Closers & Hardware
Locksets
Pulls & Handles
Sliding Systems
MANET
Panic Hardware

TG 9335 Decorative Pulls, Straight Pull with Mitered Corners/Posts

Pull Handles for 1/2" Glass Doors, Includes Fixings for 1/2" Glass & Roses					Standard Finish \$		Custom Finish \$
Model	Ref. #	U/M	No. Of Fixing Posts	Description	700	701	999
Back-to-Back 1-1/4" (32 mm) Dia.					(S)	(S)	(S)
	905.545	Ea.	3F	CTC = 94-1/2" through 110-3/16"	1,002	1,102	1,402
	905.544	Ea.	3F	CTC = 74-13/16" through 94-7/16"	862	948	1,262
	905.543	Ea.	3F	CTC = 59-1/16" through 74-3/4"	722	794	1,122
	905.542	Ea.	2F	CTC = 43-5/16" through 59"	582	640	882
	905.541	Ea.	2F	CTC = 27-9/16" through 43-1/4"	442	486	742
	905.540	Ea.	2F	CTC = 7-7/8" through 27-1/2"	302	332	602
Single Sided 1-1/4" (32 mm) Dia.							
	905.345	Ea.	3F	CTC = 94-1/2" through 110-3/16"	601	661	801
	905.344	Ea.	3F	CTC = 74-13/16" through 94-7/16"	524	576	724
	905.343	Ea.	3F	CTC = 59-1/16" through 74-3/4"	447	492	647
	905.342	Ea.	2F	CTC = 43-5/16" through 59"	370	407	520
	905.341	Ea.	2F	CTC = 27-9/16" through 43-1/4"	293	322	443
	905.340	Ea.	2F	CTC = 7-7/8" through 27-1/2"	218	240	368
Back-to-Back 1" (25 mm) Dia.							
	905.506	Ea.	3F	CTC = 94-1/2" through 110-3/16"	1,265	1,392	1,665
	905.505	Ea.	3F	CTC = 74-13/16" through 94-7/16"	1,120	1,232	1,520
	905.504	Ea.	3F	CTC = 59-1/16" through 74-3/4"	975	1,073	1,375
	905.503	Ea.	2F	CTC = 43-5/16" through 59"	830	913	1,130
	905.502	Ea.	2F	CTC = 27-9/16" through 43-1/4"	685	754	985
	905.501	Ea.	2F	CTC = 8-1/4" through 27-1/2"	540	594	840
Single Sided 1" (25 mm) Dia.							
	905.306	Ea.	3F	CTC = 94-1/2" through 110-3/16"	742	816	942
	905.305	Ea.	3F	CTC = 74-13/16" through 94-7/16"	661	727	861
	905.304	Ea.	3F	CTC = 59-1/16" through 74-3/4"	580	638	780
	905.303	Ea.	2F	CTC = 43-5/16" through 59"	499	549	649
	905.302	Ea.	2F	CTC = 27-9/16" through 43-1/4"	418	460	568
	905.301	Ea.	2F	CTC = 8-1/4" through 27-1/2"	337	371	487
							Net Add \$
POWDER	All Custom powder coated orders will include a net charge per purchase order.						200

(S) Special Fabricated/Finish or Special Order; lead time up to 5 weeks.

NOTES:

- When required, 3rd fixing post is centered on CTC dimension unless otherwise requested.
- CTC = Center-to-center of mounting posts.
- Specify Door thickness and desired screwpack.

TG Decorative Pulls

Pull Handles for 1/2" Glass Doors, Includes Fixings for 1/2" Glass & Roses **Standard Finish \$** **Custom Finish \$**

Model	Ref. #	U/M	Description	700	701	999
-------	--------	-----	-------------	-----	-----	-----

TG 9830 Bowed Pull, 13-3/4" (349 mm) Center-to-Center

Model	Ref. #	U/M	Description	700	701	999
				(SO)	(SO)	(SO)
	905.530	Set	Back-to-Back	597	657	797
	905.330	Ea.	Single Sided	366	403	516

TG 9304 Curved Pull, Radius Standoff, 1-1/4" (32 mm) Diameter, 13-3/4" (349 mm) Center-to-Center

	905.569	Set	Back-to-Back	302	332	502
	905.369	Ea.	Single Sided	197	217	347
				Ø	1-1/4" (32 mm)	
				R	1-3/4" (44 mm)	
				R1	6-7/8" (175 mm)	
				B	8-11/16" (220 mm)	
				H	3-3/8" (85 mm)	
				CTC	13-3/4" (350 mm)	

TG 9306 Curved Pull, Sharp/Straight Standoff, 1-9/16" (40 mm) Dia. 13-3/4" (349 mm) Center-to-Center

	905.611	Set	Back-to-Back	669	736	869
	905.411	Ea.	Single Sided	401	441	551
				ØGØS	1-9/16" (40 mm)	
				R	6-7/8" (175 mm)	
				B	8-3/16" (205 mm)	
				H	3-15/16" (100 mm)	
				M	1" (24 mm)	

NOTE: Specify door thickness and desired screwpack.

Fixings for TG Handles to Glass Doors 5/16" (8 mm)–9/16" (15 mm) Thick

				701	999
				(SO)	(SO)
	905.900	Ea.	Back-to-Back – M6	22	24
	905.902	Ea.	Back-to-Back – M8	22	24
	905.905	Ea.	Single Sided – M6	40	44
	905.904	Ea.	Single Sided – M8	40	44

Fixings for TG Handles to Glass Doors 1-3/8" (35 mm)–3-15/16" (100 mm) Thick

	905.901	Ea.	Back-to-Back – M6	24	26
	905.903	Ea.	Back-to-Back – M8	24	26
	905.907	Ea.	Single Sided – M6	42	46
	905.906	Ea.	Single Sided – M8	42	46

Rose Options for TG Pulls

	905.971	Ea.	1-9/16" (40 mm) Rose – M6	10	12
	905.972	Ea.	1-3/4" (44 mm) Rose – M8	10	12

Net Add \$

POWDER



All Custom powder coated orders will include a **net charge** per purchase order.

200

(SO) Special Fabricated/Finish or Special Order; lead time up to 5 weeks.

DRS Rails, Channels & Accessories
 Patch Fittings & Designer Pivots
 Offset Hung Patch Fittings
 Headers & Accessories
 Closers & Hardware
 Locksets
 Pulls & Handles
 Sliding Systems
 MANET
 Panic Hardware

ARCOS and BEYOND Decorative Pulls

Pulls for 3/8" (10 mm) and 1/2" (12 mm) Glass Doors					Standard Finish \$	Custom Finish \$
Model	Ref. #	U/M	No. Of Fixing Posts	Description	114	999
ARCOS 15-11/16" (398 mm) Length					(SO)	(SO)
	826.500	Set	2F	13-3/4" (350 mm) Center-to-Center	340	540
ARCOS 32-1/16" (824 mm) Length						
	826.510	Set	2F	29-1/2" (750 mm) Center-to-Center	401	801
					107	
BEYOND, Specify Door Thickness					(SO)	
	830.300	Set	2F	17-3/4" (450 mm) Center-to-Center 3/8" (10 mm) or 1/2" (12 mm)	815	1,015
	830.305	Set	2F	23-5/8" (600 mm) Center-to-Center 3/8" (10 mm) or 1/2" (12 mm)	945	1,145
	830.310	Set	2F	35-7/16" (900 mm) Center-to-Center 3/8" (10 mm) or 1/2" (12 mm)	1,128	1,528
						Net Add \$
POWDER	All Custom powder coated orders will include a net charge per purchase order.					200

(SO) Special Fabricated/Finish or Special Order; lead time up to 5 weeks.

NOTE: Specify door thickness.

Solid and Tubular Pull Handles for 3/8" (10 mm) and 1/2" (12 mm) Glass

Model	Ref. #	U/M	Description	Finishes \$						
				101	108	109	503/599	600/601	700	701
Solid and Tubular, Back-to-Back, 10" and 12" (Center-to-Center) Handles										
	926.001	Set	10" (254 mm) Solid	58 (1)	61 (1)	61 (SO)	—	250 (SO)	132 (1)	132 (SO)
	926.601	Set	10" (254 mm) Tubular	—	—	—	106 (SO)	—	70 (1)	70 (SO)
	926.004	Set	12" (305 mm) Solid	61 (1)	65 (1)	65 (1)	179 (SO)	450 (SO)	146 (1)	146 (1)
	926.604	Set	12" (305 mm) Tubular	—	—	—	112 (SO)	—	73 (1)	73 (1)
Solid and Tubular, Single Sided, 10" and 12" (Center-to-Center) Handles										
	926.012	Ea.	10" (254 mm) Solid	(SO)	(SO)	(SO)	(SO)	(SO)	(SO)	(SO)
	926.612	Ea.	10" (254 mm) Tubular	35	40	40	—	—	—	—
	926.016	Ea.	12" (305 mm) Solid	45	48	48	—	—	—	—
	926.616	Ea.	12" (305 mm) Tubular	—	—	—	—	—	48	48
Solid and Tubular, Back-to-Back Offset, 10" and 12" (Center-to-Center) Handles										
	926.622	Set	10" (254 mm) Tubular	—	—	—	—	—	88	88
	926.009	Set	12" (305 mm) Solid	70	77	77	—	—	—	—
	926.609	Set	12" (305 mm) Tubular	—	—	—	143	—	95 (1)	95 (SO)
Solid and Tubular, Back-to-Back, 10" and 12" (Center-to-Center) x 27-3/4" Handles										
	926.002	Set	10" x 27-3/4" (254 x 705 mm) Solid	80	90	90	—	—	—	—
	926.602	Set	10" x 27-3/4" (254 x 705 mm) Tubular	—	—	—	—	—	113	113
	926.005	Set	12" x 27-3/4" (305 x 705 mm) Solid	77 (1)	86 (1)	86	—	—	247 (1)	247 (1)
	926.605	Set	12" x 27-3/4" (305 x 705 mm) Tubular	—	—	—	152	—	121 (1)	121 (1)

(1) Non-Fabricated item, 2-day lead time.

(SO) Special Fabricated/Finish or Special Order; lead time up to 5 weeks.

NOTES:

- Tubular handles include a 1-1/4" (32 mm) washer.
- Specify Door thickness.
- Call customer service for door thicknesses 1-3/8" - 2-1/2" for fastener pack ordering guidance.

DRS Rails, Channels & Accessories
Patch Fittings & Designer Pivots
Offset Hung Patch Fittings
Headers & Accessories
Closers & Hardware
Locksets
Pulls & Handles
Sliding Systems
MANET
Panic Hardware

Finger Pulls and Knobs for 3/8" (10 mm) and 1/2" (12 mm) Glass

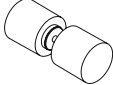
Model	Ref. #	U/M	Description	Finishes \$		
				101	700	199
Finger Pulls				①	①	SO
	907.200	Set	Flush Pull	125	188	188
Knobs						
	906.999	Ea.	Glass Knob	114 SO	—	—

① Non-Fabricated item, 2-day lead time.

SO Special Fabricated/Finish or Special Order; lead time up to 5 weeks.

Sliding Systems

AGILE 150	Ordering Guide	128
	Manual Sliding Systems Wall and Ceiling Mount	129
	Accessories and Components	134
	Syncro Manual Sliding System Wall and Ceiling Mount	136
	Accessories and Components	137
AGILE 150 DORMOTION	DORMOTION Sliding Door System, Comfortable Cushioning	141
	Accessories and Components	144
DRS-120	Ordering Guide – DRS and RS-120	146
	Ceiling Mount Sliding Systems	147
	Accessories and Components	151
RS-120	Wall and Ceiling Mount Sliding Systems	152
	Accessories and Components	156
Handle Options	Sliding Applications Handle Options	158

DRS Rails,
Channels &
AccessoriesPatch Fittings
& Designer
PivotsOffset
Hung Patch
FittingsHeaders &
AccessoriesClosers &
Hardware

Locksets

Pulls &
HandlesSliding
Systems

MANET

Panic
Hardware

AGILE 150

Ordering Guide

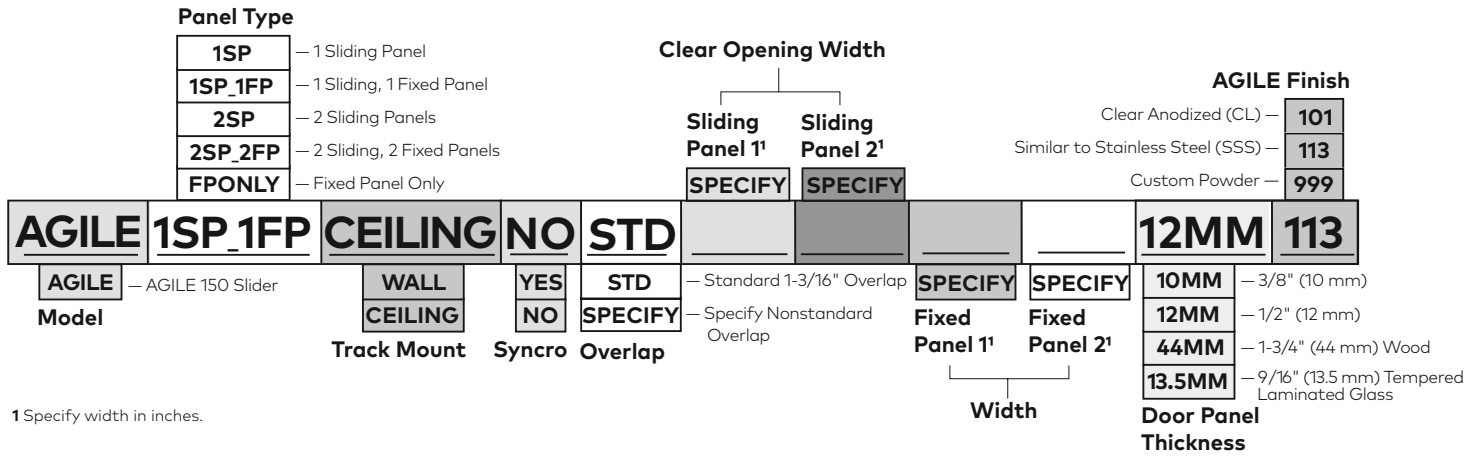

¹ Specify width in inches.

AGILE 150 Manual Sliding System, Wall and Ceiling Mount

5/16" (8 mm) through 9/16" (15 mm) Glass Door Thickness

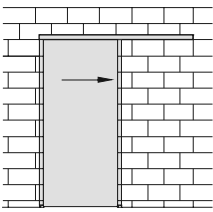
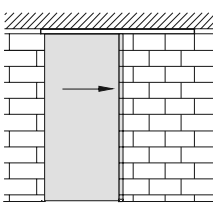
Model	Ref. #	U/M	Description	Standard Finishes \$		Custom Powder \$
				101	113	999
Single Manual Sliding Panel (1SP) Complete						
Wall Mount				3	3	SO
	807.300	Unit	0" to 37" (940 mm) Max. track length 1 at 74" (1,880 mm)	1,353	1,440	1,647
	807.302	Unit	37" to 57" (940 mm to 1,448 mm) Max. track length 1 at 114" (2,896 mm)	1,397	1,481	1,796
Ceiling Mount						
	807.301	Unit	0" to 37" (940 mm) Max. track length 1 at 74" (1,880 mm)	1,193	1,253	1,487
	807.303	Unit	37" to 57" (940 mm to 1,448 mm) Max. track length 1 at 114" (2,896 mm)	1,236	1,295	1,635

AGILE 150 Sliding – Wall Mount Complete

- 1 track profile
- 1 angle profile
- 2 clamp carriers with stabilizer
- 2 endstops with safety catch
- 1 AGILE floor guide
- Track brush

Calculations for wall mount with 2 overlapping edges

- Sliding Panel Width = (Clear opening* + 2-3/8" (60 mm))
- Track Length = (Clear opening* + 2-3/8" (60 mm)) × 2

* Allow for handle or lock projection when calculating.
(Clear opening + 1-3/16" [30 mm] + panel projection allowance for handle/lock)

AGILE 150 Sliding – Ceiling Mount Complete

- 1 track profile
- 1 cover profile
- 2 clamp carriers with stabilizer
- 2 endstops with safety catch
- 1 AGILE floor guide
- Track brush

Calculations for ceiling mount with 1 overlapping edge

- Sliding Panel Width = (Clear opening* + 1-3/16" (30 mm))
- Track Length = (Clear opening* + 1-3/16" (30 mm)) × 2

3 Standard or Non-Standard Fabricated; lead time up to 3 business days.

SO Special Fabricated/Finish or Special Order; lead time up to 5 weeks.

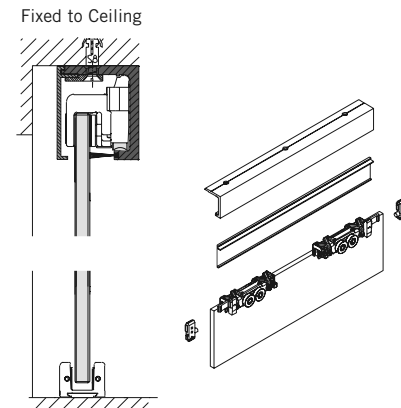
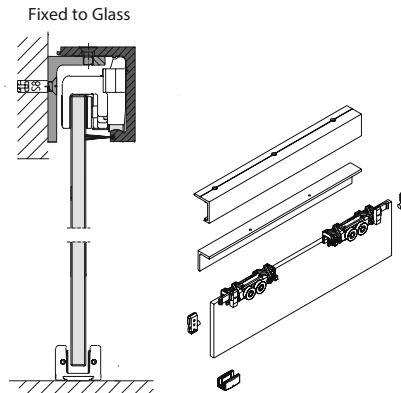

DRS Rails, Channels & Accessories
Patch Fittings & Designer Pivots
Offset Hung Patch Fittings
Headers & Accessories
Closers & Hardware
Locksets
Pulls & Handles
Sliding Systems
MANET
Panic Hardware

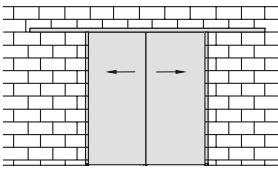
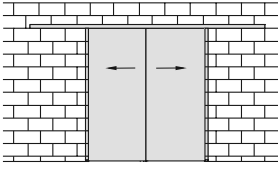
Model	Ref. #	U/M	Description	Standard Finishes \$		Custom Powder \$
				101	113	999
Two Manual Sliding Panels (2SP) Complete						
Wall Mount				3	3	SO
	207.600	Unit	0" to 37" (940 mm) Max. track length 2 at 74" (1,880 mm)	2,878	3,045	3,466
	207.602	Unit	37" to 57" (940 mm to 1,448 mm) Max. track length 2 at 114" (2,896 mm)	2,963	3,128	3,761
Ceiling Mount						
	207.601	Unit	0" to 37" (940 mm) Max. track length 2 at 74" (1,880 mm)	2,558	2,671	3,146
	207.603	Unit	37" to 57" (940 mm to 1,448 mm) Max. track length 2 at 114" (2,896 mm)	2,643	2,734	3,496

AGILE 150 Sliding – Wall Mount Complete

- 2 track profiles
- 2 angle profiles
- 4 clamp carriers with stabilizer
- 4 endstops with safety catch
- 2 AGILE floor guides
- Track brush

Calculations for wall mount with 2 overlapping edges

- Sliding Panel Width = (Clear opening* + 2-3/8" (60 mm))
- Track Length = (Clear opening* + 2-3/8" (60 mm)) × 2

* Allow for handle or lock projection when calculating.
(Clear opening + 1-3/16" [30 mm] + panel projection allowance for handle/lock)

AGILE 150 Sliding – Ceiling Mount Complete

- 2 track profiles
- 2 cover profiles
- 4 clamp carriers with stabilizer
- 4 endstops with safety catch
- 2 AGILE floor guides
- Track brush

Calculations for ceiling mount with 2 overlapping edges

- Sliding Panel Widths = (Clear opening* + 2-3/8" (60 mm)) / 2
- Track Length = (Clear opening* + 2-3/8" (60 mm)) × 2

3 Standard or Non-Standard Fabricated; lead time up to 3 business days.

NOTE: Units will have splice joints. To avoid a splice joint, you must specify NO SPLICE JOINTS on purchase order. Max. length without splice is 144" (3.66 m).

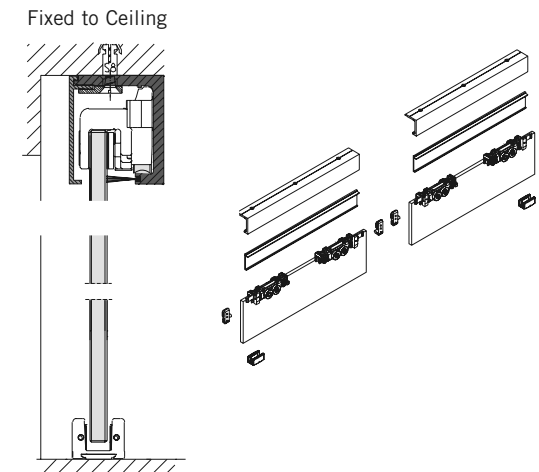
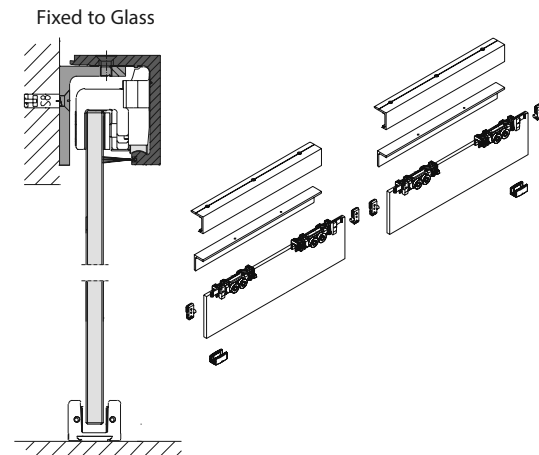

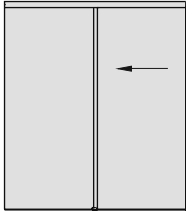
Model	Ref. #	U/M	Description	Standard Finishes \$		Custom Powder \$
				101	113	999
Single Manual Sliding Panel with One Fixed Panel (1SP_1FP) Complete						
Ceiling Mount Only				3	3	SO
	207.311	Unit	0" to 37" (940 mm) Max. Track Length: 74" (1,880 mm)	1,784	1,898	2,225
	207.313	Unit	37" to 57" (940 mm to 1,448 mm) Max. Track Length: 114" (2,896 mm)	1,854	1,985	2,400
	Additional Linear Foot of Sidelite Inlaid Profile					
	207.399	Ft.	Track with Sidelite Inlaid Profile for openings greater than 114" (2,896 mm)	124	136	190

AGILE 150 Sliding — Ceiling Mount Complete

- 1 track profile
- 1 view profile
- 1 sidelite fixing profile
- 2 clamp carriers with stabilizer
- 2 endstops with safety catch
- 1 AGILE floor guide
- 1 bottom sidelite Dri-Fit channel with gasket (equal to fixed panel width)
- Track brush

Calculations for ceiling mount with 2 overlapping edges

- Sliding Panel Width = (Clear opening* + 1-3/16" (30 mm))
- Track Length = (Clear opening* + 1-3/16" (30 mm)) × 2
- Fixed Panel Width = Overall opening width – Clear opening width

* Allow for handle or lock projection when calculating.
(Clear opening + 1-3/16" [30 mm] + panel projection allowance for handle/lock)

3 Standard or Non-Standard Fabricated; lead time up to 3 business days.

NOTE: Use sidelite inlaid profile when fixed lites are longer than sliding panel width. When ordering, please advise overall opening width AND fixed panel width.

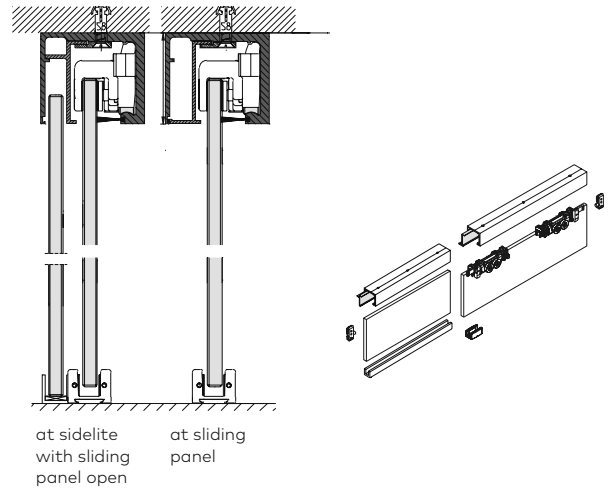

- DRS Rails, Channels & Accessories
- Patch Fittings & Designer Pivots
- Offset Hung Patch Fittings
- Headers & Accessories
- Closers & Hardware
- Locksets
- Pulls & Handles
- Sliding Systems
- MANET
- Panic Hardware

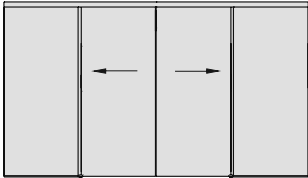
Model	Ref. #	U/M	Description	Standard Finishes \$		Custom Powder \$
				101	113	999
Two Manual Sliding Panels with Two Fixed Panels (2SP_2FP) Complete						
Ceiling Mount Only				3	3	SO
	207.611	Unit	0" to 37" (940 mm) Max. panel width 2 at 74" (1,880 mm)	3,739	3,997	4,180
	207.613	Unit	37" to 57" (940 mm to 1,448 mm) Max. panel width 2 at 114" (2,896 mm)	3,880	4,134	4,426
	Additional linear foot of sidelite Inlaid Profile					
	207.399	Ft.	Track with Sidelite Inlaid Profile for openings greater than 114" (2,896 mm)	124	136	190

AGILE 150 Sliding – Wall Mount Complete

- 2 track profiles
- 2 view profiles
- 2 sidelite fixing profiles
- 4 clamp carriers with stabilizer
- 4 endstops with safety catch
- 2 AGILE floor guides
- 2 Bottom sidelite Dri-Fit channels with gasket (equal to fixed panel width)
- Track brush

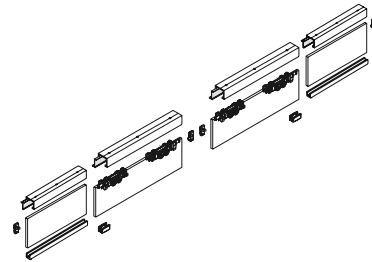

Calculations for ceiling mount with 2 overlapping edges

- Sliding Panel Width = (Clear opening* + 2-3/8" (60 mm)) / 2
- Track Length = Overall opening width
- Fixed Panel Width = (Overall opening width – Clear opening width) / 2

* Allow for handle or lock projection when calculating.
(Clear opening + 1-3/16" [30 mm] + panel projection allowance for handle/lock)

3 Standard or Non-Standard Fabricated; lead time up to 3 business days.

NOTES:

- Use sidelite inlaid profile when fixed lites are longer than sliding panel width.
- Units will have splice joints. To avoid a splice joint, you must specify NO SPLICE JOINTS on purchase order. Max. length without splice is 144" (3.66 m).
- When ordering, please advise overall opening width AND fixed panel width.

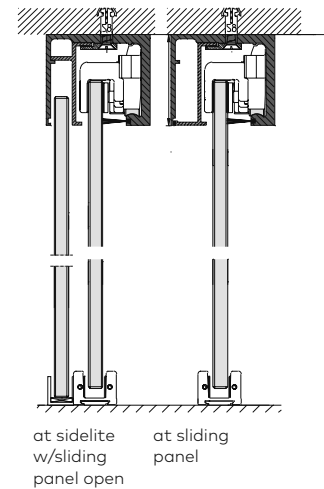

AGILE 150 Manual Sliding System, Glass to Glass Mount

1/2" (13 mm) or 3/8" (10 mm) Glass Door Thickness

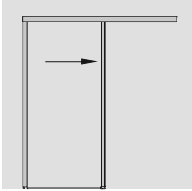
Model	Ref. #	U/M	Description	Standard Finishes \$	
				101	113
Single Manual Sliding Panel (1SP) Complete				3	3
Wall Mount					
	807.736	Unit	91" (3,211 mm) Pre-cut track length 41-5/16" Clear opening width	1,863	2,004
	807.737	Unit	107" (2,718 mm) Pre-cut track length 49-1/4" Clear opening width	2,101	2,270

AGILE 150 Sliding – Glass Mount Complete (91")

- 91" track profile
- 91" track to glass
- 91" cover profile
- 8 plates track to glass
- 1 set end caps
- 1 roller kit
- 2 track brushes

* Allow for handle or lock projection when calculating.
(Clear opening + 1-3/16" [30 mm] + panel projection allowance for handle/lock)

AGILE 150 Sliding – Glass Mount Complete (107")

- 107" track profile
- 107" track to glass
- 107" cover profile
- 10 plates track to glass
- 1 set end caps
- 1 roller kit
- 3 track brushes

* Allow for handle or lock projection when calculating.
(Clear opening + 1-3/16" [30 mm] + panel projection allowance for handle/lock)

3 Standard or Non-Standard Fabricated; lead time up to 3 business days.

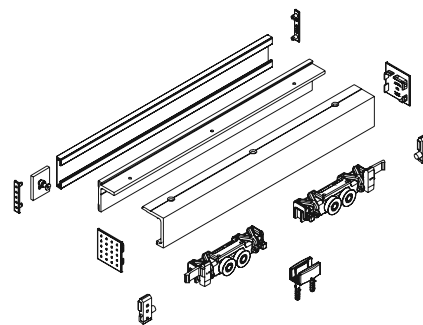
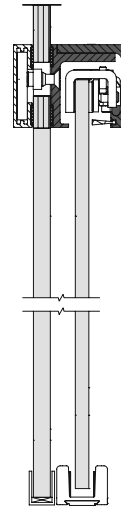

DRS Rails,
Channels &
Accessories

Patch Fittings
& Designer
Pivots

Offset
Hung Patch
Fittings

Headers &
Accessories

Closers &
Hardware

Locksets







Pulls &
Handles

Sliding
Systems

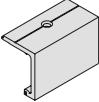
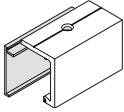
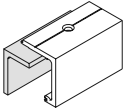
MANET

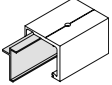
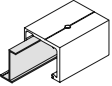
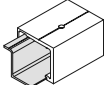
Panic
Hardware

Accessories and Components

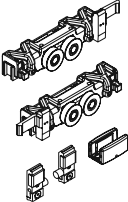
Model	Ref. #	U/M	Description	Standard Finishes \$		Custom Powder \$
				101	113	999
Maximum Profile Extrusion Length = 144" (3.66 m)				3	3	(SO)
Sliding Applications (No Sidelites) – Wall or Ceiling						
	807.340	Ln.	Track Profile	428	501	659
		Ft.	Ceiling or Wall Mount	36	42	61
	807.711		Track Profile Glass Mount	684	787	—
	807.341	Ln.	Cover Profile*	140	163	371
		Ft.	for Ceiling Mount Applications	12	14	36
	807.710		Cover Profile – for glass wall mount applications	415	477	—
	807.342	Ln.	Angle Profile*	325	377	556
		Ft.	for Wall Mount Applications	28	32	52
Sliding Applications (with Sidelites) – Ceiling						
	807.360	Ln.	Track Profile w/ Sidelites	745	870	1,050
		Ft.	Ceiling Mount	65	75	90
	807.361	Ft.	Fixed Panel Profile* for Track Profile w/ Sidelites	14	17	39
	807.362	Ft.	View Protection Profile* to Cover Gap in Entry Area	13	15	37
	807.364	Ft.	Inlaid Profile for Sidelite* to Cover Gap in Sidelite Area Where Sliding Panel Does Not Travel	17	20	41
AGILE Roller Package				807/808	Custom Paint \$	List \$
	807.720	Set	Endcaps (LH/RH) 2-1/4" (57 mm) for Wall Mount Track Use with 807.340 Track Profiles	25	47	—
	807.721	Set	Endcaps (LH/RH) 2-1/8" (54 mm) for Ceiling Mount Track Use with 807.340 Track Profiles	25	47	—
	807.722	Set	Endcaps (LH/RH) 2-27/32" (72 mm) for Sidelite Mount Track Use with 807.360 Track Profiles	25	47	—
	807.730	Set	Endcaps (LH/RH) for glass to glass mount Use with 807.736/807.737 Track Profiles	—	—	35
	807.725	Set	Roller Package for Use with 3/8" (9 mm) to 9/16" (14 mm) Glass Doors (includes track stops and floor guide)			668
	807.915	Set	Track Stops for Use with AGILE Roller Carriers			102
	807.326	Ea.	Floor guide adjustable, 5/16" (8 mm) to 17/32" (13.5 mm)			65 ^①

* Track components sold separately. Track Profiles shown for application purposes only.



NOTES:

- Extrusions ordered in full length are sold at a slight price break over cut lengths.
- Drop lengths will not be shipped with order unless specifically requested by customer.

- ① Non-Fabricated item, ships in 1 business day.
- ③ Standard or Non-Standard Fabricated; lead time up to 3 business days.
- (SO) Special Fabricated/Finish or Special Order; lead time up to 5 weeks.

Screw Packs	Ref. #	U/M	Description	List \$
	807.319	ST	Used with extrusion 807.364 set screws only	8
	807.320	ST	Used with extrusion 807.360 clips, wood screws and anchors	20
	807.321	ST	Used with extrusion 807.341 clips and wood screws	18
	807.322	ST	Used with extrusion 807.340 wood screws and anchors	6
	807.323	ST	Used with extrusion 807.342 clips, wood screws, anchors and machine screws (metric)	6

Laminated Glass Accessories

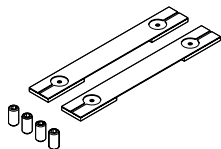
Model	Ref. #	U/M	Description	List \$
	LGAA	934.801	Ea. 3M™ Scotch-Weld™ EPX™ plus II applicator with 2:1 and 1:1 plunger	330
	LGA	934.800	Ea. 3M™ Scotch-Weld™ Urethane Adhesive, DP 605 NS, off white, 1 tube per 4 roller carriers	78
	MTIPS	934.805	Set. 3M™ Scotch-Weld™ EPX™ plus II mixing square nozzle, 5.3 mm (4 tips per set)	10
		807.640	Set. Laminated glass component, pair of clamp carrier plates, backset, and screws	24

NOTE: Scotch-Weld™ Urethane Adhesive, Scotch-Weld™ EPX™ plus II applicator, and Scotch-Weld™ EPX™ plus II mixing square nozzle are trademarks of 3M.

DRS Rails, Channels & Accessories

Patch Fittings & Designer Pivots

Offset Hung Patch Fittings

Headers & Accessories

Closers & Hardware

Locksets

Pulls & Handles

Sliding Systems

MANET

Panic Hardware

Syncro Manual Sliding Systems, Wall and Ceiling Mount

5/16" (8 mm) through 9/16" (15 mm) Glass Door Thickness

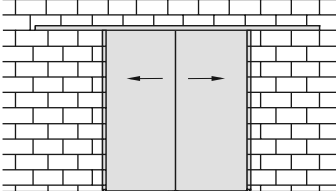
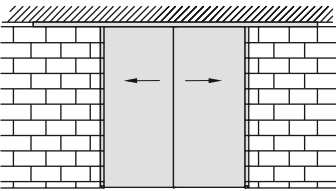
Model	Ref. #	U/M	Description	Standard Finishes \$		Custom Powder \$
				101	113	999
Two Manual Sliding Synchronized Panels (2SP) Complete						
Wall Mount				(SO)	(SO)	(SO)
	207.390	Unit	Sliding Panel Width 0" to 39-3/8" (1,000 mm)	3,411	3,497	3,999
Ceiling Mount						
	207.391	Unit	Sliding Panel Width 0" to 39-3/8" (1,000 mm)	3,543	3,640	4,131

AGILE 150 Syncro Sliding Door Gear – Wall Mount COMPLETE

- 2 tracks
- 2 angle profiles
- 4 clamp carriers with stabilizer and deflection device/cables
- 4 endstops with safety catch
- 2 AGILE floor guides
- Track brush

Calculations for wall mount with 2 overlapping edges

- Sliding Panel Width = (Clear opening* + 2-3/8" (60 mm)) / 2
- Track Length = (Clear opening* + 2-3/8" (60 mm)) × 2

* Allow for handle or lock projection when calculating.
(Clear opening + 1-3/16" [30 mm] + panel projection allowance for handle/lock)
AGILE 150 Syncro Sliding Door Gear

Ceiling Mount COMPLETE



- 2 tracks
- 2 cover profiles
- 4 clamp carriers with stabilizer and deflection device/cables
- 4 endstops with safety catch
- 2 AGILE floor guides
- Track brush

Calculations for ceiling mount with 2 overlapping edges

- Sliding Panel Width = (Clear opening* + 2-3/8" (60 mm)) / 2
- Track Length = (Clear opening* + 2-3/8" (60 mm)) × 2

(SO) Special Fabricated/Finish or Special Order; lead time up to 5 weeks.

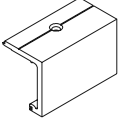
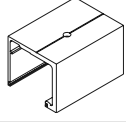
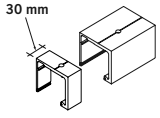
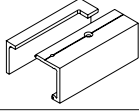
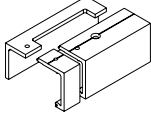
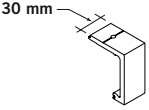
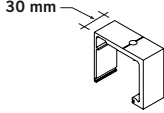

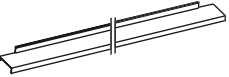
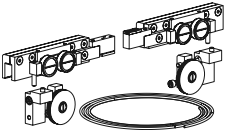
Manual Sliding Syncro System, Accessories and Components

Model	Ref. #	U/M	Description	Standard Finishes \$		Custom Powder \$
				101	113	999
Maximum Profile Extrusion Length = 144" (3.66 M) or Less				(SO)	(SO)	(SO)
AGILE Syncro Profiles – Ceiling Fixing (cut to length)						
	807.353	Ln.	Track Profile for Applications without Sidelites (Cover profile 807.341 ordered separately)	422	436	713
	807.373	Ft. Ln.	Track/Sidelite Profile, Drilled (Edge profile 807.361 and view protection 807.362 ordered separately)	35 422	36 436	59 713
	807.374	Ln.	Track/Sidelite Profile, Drilled, with Revision Piece (Edge profile 807.361 and view protection 807.362 ordered separately)	230	275	301
AGILE Syncro Profiles – Wall Fixing (cut to length)						
	807.355	Ft. Ln.	Angle and Track Profiles (Drilled)	37 449	39 462	62 739
	807.354	Ft. Ln.	Angle and Track Profiles for Wall Fixings between 2 walls, Drilled	47 568	51 607	72 858
AGILE Syncro Revision Pieces for Track Access (when track is butted to wall on either end)						
	807.158	Ea.	Revision Wall Mounted-No Sidelites	35	40	59
	807.364	Ft.	Revision Ceiling Mounted-Sidelites	58	68	83
AGILE Syncro Profiles – Wall Fixing (cut to length)						
	807.376	Ea.	Fixed Dimension: 62-1/8" (1578 mm)	410	407	718
	807.375	Ft.	Cut to Length/Ft.	26	28	51
AGILE Syncro Roller Package						List \$
	807.330	Set	Roller Package for Use with 3/8" (8 mm) to 9/16" (14 mm)			2,162



(SO) Special Fabricated/Finish or Special Order; lead time up to 5 weeks.

DRS Rails, Channels & Accessories
Patch Fittings & Designer Pivots
Offset Hung Patch Fittings
Headers & Accessories
Closers & Hardware
Locksets
Pulls & Handles
Sliding Systems
MANET
Panic Hardware

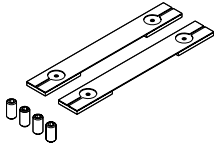
Laminated Glass Accessories

	Model	Ref. #	U/M	Description	List \$
	LGAA	934.801	Ea.	3M™ Scotch-Weld™ EPX™ plus II applicator with 2:1 and 1:1 plunger	330
	LGA	934.800	Ea.	3M™ Scotch-Weld™ Urethane Adhesive, DP 605 NS, off white, 1 tube per 4 roller carriers	78
	MTIPS	934.805	Set.	3M™ Scotch-Weld™ EPX™ plus II mixing square nozzle, 5.3 mm (4 tips per set)	10
		807.640	Set.	Laminated glass component, pair of clamp carrier plates, backset, and screws	24

NOTE: Scotch-Weld™ Urethane Adhesive, Scotch-Weld™ EPX™ plus II applicator, and Scotch-Weld™ EPX™ plus II mixing square nozzle are trademarks of 3M.

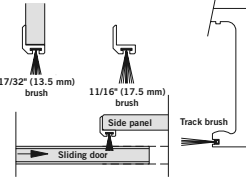
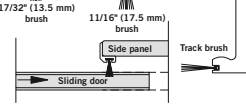
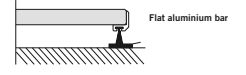
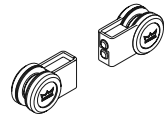
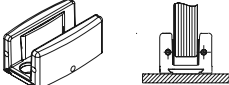
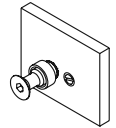



Model	Ref. #	U/M	Description	Standard Finishes \$		Custom Paint \$
				807/808	999	(S0)
Maximum Profile Extrusion Length = 144" (3.66 M) or Less				3		(S0)
AGILE Syncro Endcaps						
	807.721	Ea.	Endcap – Ceiling Mount Track*	25		47
	807.720	Ea.	Endcap – Wall Mount Track*	25		47
	807.722	Ea.	Endcap – Track with Sidelite Installation*	25		47
Optional Accessories				101	113	
	807.400	Ln.	Brush Profile for gaps 3/8" (10 mm) to 1/2" (12 mm) 118" (3,000 mm) Long	78 (S0)	83 (S0)	138
	807.402	Ln.	Brush Profile for gaps 9/16" (14 mm) to 23/32" (18 mm) Only sold in 118" (3 m) Stock Length	78 3	83 (S0)	138
	807.385	Ln.	Track Brush 49" (1,250 mm) (grey color)			List \$ 22
	829.420	Set	Spacer for Bi-Parting Sliding Panels			98
	807.326	Ea.	Floor Guide Adjustable, 5/16" (8 mm) to 17/32" (13.5 mm)			65 ①
	807.282	Ea.	AGILE 150 plate for glass mount includes connecting screws.			29 (S0)

* Track components sold separately. Track profiles shown for application purposes only.

- ① Non-Fabricated item, ships in 1 business day.
- 3 Standard or Non-Standard Fabricated; lead time up to 3 business days.
- (S0) Special Fabricated/Finish or Special Order; lead time up to 5 weeks.

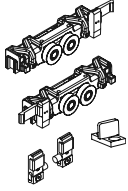
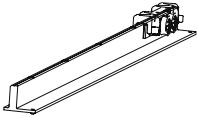
DRS Rails, Channels & Accessories
Patch Fittings & Designer Pivots
Offset Hung Patch Fittings
Headers & Accessories
Closers & Hardware
Locksets
Pulls & Handles
Sliding Systems
MANET
Panic Hardware

Manual Sliding Door Accessories and Components

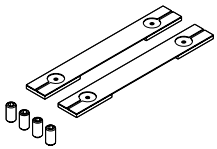
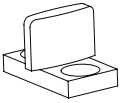
Model	Ref. #	U/M	Description			
Maximum Profile Extrusion Length = 157" (4 M) or Less						
AGILE Wood Door Accessories						List \$
	807.845	Set	Wood Door Accessory Set Version 2010 1-1/16" to 1-3/4" (28 mm to 44 mm) thickness			668 ³
				NOTE: Includes 2 ea. rollers, end stops, and 1 ea. wood door floorguide		
						Finishes \$
				101	113	999
	807.367	Ln.	Adapter profile wood doors, drilled length 157" (4 m) 1-9/16" (40 mm) wood door	515	572	829
	807.369**	Ft.	Max. length 157" (4 m) 1-3/4" (44 mm) wood doors			109 ³
Laminated Glass Accessories						List \$
	LGAA	934.801	Ea. 3M™ Scotch-Weld™ EPX™ plus II applicator with 2:1 and 1:1 plunger			330
	LGA	934.800	Ea. 3M™ Scotch-Weld™ Urethane Adhesive, DP 605 NS, off white, 1 tube per 4 roller carriers			78
	MTIPS	934.805	Set. 3M™ Scotch-Weld™ EPX™ plus II mixing square nozzle, 5.3 mm (4 tips per set)			10
		807.640	Set. Laminated glass component, pair of clamp carrier plates, backset, and screws			24
		807.226	Ea. Floor guide for Wood Door			3 ³

* Track components sold separately. Track profiles shown for application purposes only.

** Rollers not included. 109 Black Anodized only.

³ Standard or Non-Standard Fabricated; lead time up to 3 business days.

^{SO} Special Fabricated/Finish or Special Order; lead time up to 5 weeks.

NOTES:

- Scotch-Weld™ Urethane Adhesive, Scotch-Weld™ EPX™ plus II applicator, and Scotch-Weld™ EPX™ plus II mixing square nozzle are trademarks of 3M.
- AGILE 150 profiles required. Sold separately.

DORMOTION Sliding Door System, Comfortable Cushioning

5/16" (8 mm) through 1/2" (13.5 mm) Glass Door Thickness

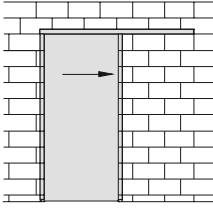
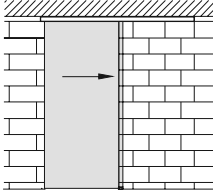
Model	Ref. #	U/M	Description	Standard Finishes \$		Custom Powder \$
				101	113	999
Maximum Profile Extrusion Length = 157" (4 M) or Less				(SO)	(SO)	(SO)
DORMOTION Wall Mounted Single Panel						
Set Type L						
	207.502	Set	Min. Width 32-5/8" (830 mm) Max. Width 56" (1,422 mm) Max. Height 108" (2,743 mm) Max. Weight 176 lb (80 kg)	1,726	1,892	2,075
	Set Type XL					
	207.512	Set	Min. Width 45-5/8" (1,160 mm) Max. Width 56" (1,422 mm) Max. Height 108" (2,743 mm) Max. Weight 330 lb (150 kg)	1,781	1,948	2,186
DORMOTION Ceiling Mounted Single Panel						
Set Type L						
	207.501	Set	Min. Width 32-5/8" (830 mm) Max. Width 56" (1,422 mm) Max. Height 108" (2,743 mm) Max. Weight 176 lb (80 kg)	1,523	1,646	1,817
	Set Type XL					
	207.511	Set	Min. Width 45-5/8" (1,160 mm) Max. Width 56" (1,422 mm) Max. Height 108" (2,743 mm) Max. Weight 330 lb (150 kg)	1,577	1,702	1,818

DORMOTION – Wall Mount Complete

- 2 clamp carriers with end stops
- Anti-jump mechanism
- Floor guide for all glass thicknesses
- Both-way DORMOTION cushioning/spring mechanism
- 2 track end caps
- DORMOTION track and angle profile with brush profile

DORMOTION – Ceiling Mount Complete

- 2 clamp carriers with end stops
- Anti-jump mechanism
- Floor guide for all glass thicknesses
- Both-way DORMOTION cushioning/spring mechanism
- 2 track end caps
- DORMOTION track and angle profile with brush profile

(SO) Special Fabricated/Finish or Special Order; lead time up to 5 weeks.

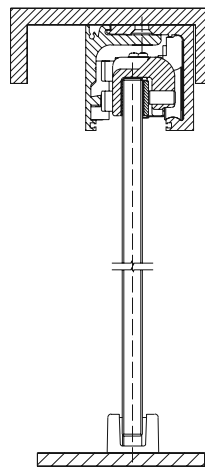

Section Details
Fixed to Ceiling

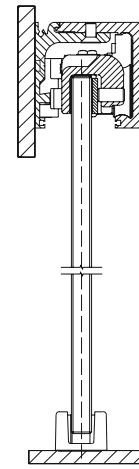

Section Details
Fixed to Wall

DRS Rails,
Channels &
Accessories

Patch Fittings
& Designer
Pivots

Offset
Hung Patch
Fittings

Headers &
Accessories

Closers &
Hardware

Locksets

Pulls &
Handles

Sliding
Systems

MANET

Panic
Hardware

Model	Ref. #	U/M	Description	Standard Finishes \$		Custom Powder \$
				101	113	999
Maximum Profile Extrusion Length = 157" (4 M) or Less				(SO)	(SO)	(SO)

DORMOTION Ceiling mounted for installation with One Door and One Fixed Panel

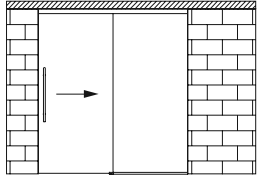
Set Type L						
	207.503	Set	Min. Width 32-5/8" (830 mm) Max. Width 56" (1,422 mm) Max. Height 108" (2,743 mm) Max. Weight 176 lb (80 kg)	2,275	2,512	2,863
	Set Type XL					
	207.513	Set	Min. Width 45-5/8" (1,160 mm) Max. Width 56" (1,422 mm) Max. Height 108" (2,743 mm) Max. Weight 330 lb (150 kg)	2,366	2,610	2,954

DORMOTION Ceiling mounted for installation with One Door and Two Fixed Panels (Left and Right)

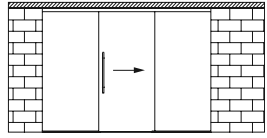
Set Type L						
	207.504	Set	Min. Width 32-5/8" (830 mm) Max. Width 56" (1,422 mm) Max. Height 108" (2,743 mm) Max. Weight 176 lb (80 kg)	3,030	3,443	3,618
	Set Type XL					
	207.514	Set	Min. Width 45-5/8" (1,160 mm) Max. Width 56" (1,422 mm) Max. Height 108" (2,743 mm) Max. Weight 330 lb (150 kg)	3,155	3,518	3,743

DORMOTION – Ceiling Mount Complete

- 2 clamp carriers with end stops
- Anti-jump mechanism
- Floor guide for all glass thicknesses
- Both-way DORMOTION cushioning/spring mechanism
- 2 track end caps
- DORMOTION track, angle profile, sidelite profile, view protection and filling profile
- Requires optional U-Channel, U-Channel end caps, and Dri-fit® Gasket

(SO) Special Fabricated/Finish or Special Order; lead time up to 5 weeks.

NOTE: \$100 net cut charge for orders cut at the factory.

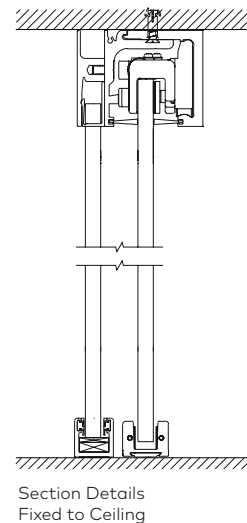

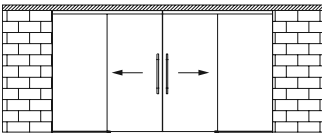
Model	Ref. #	U/M	Description	Standard Finishes \$		Custom Powder \$
				101	113	999
Maximum Profile Extrusion Length = 157" (4 M) or Less				(SO)	(SO)	(SO)
DORMOTION Ceiling Mounted for Installation with Two Doors and Two Fixed Panels (Left and Right)						
Set Type L						
	207.505	Set	Min. Width 32-5/8" (830 mm) Max. Width 56" (1,422 mm) Max. Height 108" (2,743 mm) Max. Weight 176 lb (80 kg)	4,769	5,256	5,357
	Set Type XL					
	207.515	Set	Min. Width 45-5/8" (1,160 mm) Max. Width 56" (1,422 mm) Max. Height 108" (2,743 mm) Max. Weight 330 lb (150 kg)	4,949	5,435	5,518

DORMOTION – Ceiling Mount Complete

- 2 clamp carriers with end stops
- Anti-jump mechanism
- Floor guide for all glass thicknesses
- Both-way DORMOTION cushioning/spring mechanism
- 2 track end caps
- DORMOTION track, angle profile, sidelite profile, view protection and filling profile
- Requires optional U-Channel, U-Channel end caps, and Dri-fit® Gasket





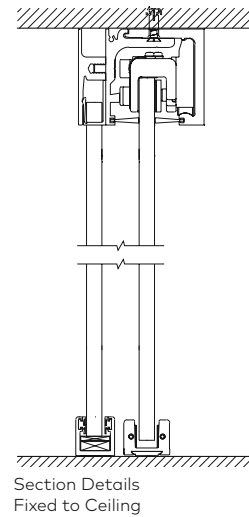

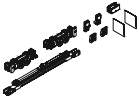

(SO) Special Fabricated/Finish or Special Order; lead time up to 5 weeks.

NOTE: \$290 list cut charge for orders cut at the factory.



- DRS Rails, Channels & Accessories
- Patch Fittings & Designer Pivots
- Offset Hung Patch Fittings
- Headers & Accessories
- Closers & Hardware
- Locksets
- Pulls & Handles
- Sliding Systems
- MANET
- Panic Hardware

Manual Sliding System Accessories and Components

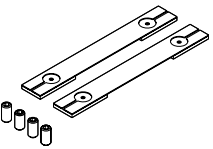
Model	Ref. #	U/M Description	Standard Finishes \$		Custom Powder \$
			101	113	999
Maximum Profile Extrusion Length = 144" (3.66 M) or Less			(SO)	(SO)	(SO)
Sliding Applications (No Sidelites) – Wall or Ceiling					
	807.582	Set AGILE DORMOTION Set Type L Up to 175 lb (80 kg), Consists of: 2 carriers, with end stops, anti-jump mechanism, floor guide, be-directional cushioning/spring assembly, starter & two end caps.	1,055	1,055	—
	807.583	Set AGILE DORMOTION Set Type XL Up to 330 lb (150 kg), Consists of: 2 carriers, with end stops, anti-jump mechanism, floor guide, be-directional cushioning/spring assembly, starter & two end caps.	1,218	1,218	—
	807.591	Ln. DORMOTION Profile Standard Set Panel without sidelite, track mounted to wall. Consists of: track rail, angle profile & view protection brush.	810	931	1,217
	807.590	Ln. DORMOTION Profile Ceiling Track Mount Set Panel without sidelite, track mounted to ceiling. Consists of: track rail, angle profile & view protection brush.	810	931	1,217
	807.592	Ln. DORMOTION Profile Track Mount with Sidelites Set Panel with sidelite, track mounted to sidelite. Consists of: track rail, angle profile & view protection & filling profile, view protection brush.	1,780	2,069	2, 416
	807.724	Pr. Endcap, DORMOTION Set (LH/RH)	25	25	47 (Painted)
					List \$
	LGAA	934.801	Ea.	3M™ Scotch-Weld™ EPX™ plus II applicator with 2:1 and 1:1 plunger	330
	LGA	934.800	Ea.	3M™ Scotch-Weld™ Urethane Adhesive, DP 605 NS, off white, 1 tube per 4 roller carriers	78
	MTIPS	934.805	Set.	3M™ Scotch-Weld™ EPX™ plus II mixing square nozzle, 5.3 mm (4 tips per set)	10
		807.640	Set.	Laminated glass component, pair of clamp carrier plates, backset, and screws	24

3 Standard or Non-Standard Fabricated; lead time up to 3 business days.

(SO) Special Fabricated/Finish or Special Order; lead time up to 5 weeks.

NOTE: Scotch-Weld™ Urethane Adhesive, Scotch-Weld™ EPX™ plus II applicator, and Scotch-Weld™ EPX™ plus II mixing square nozzle are trademarks of 3M.

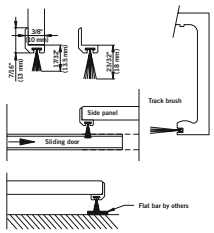
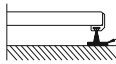
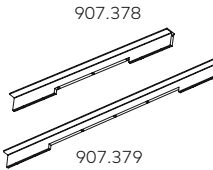
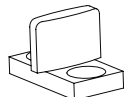
Optional Accessories	Ref. #	U/M Description	Standard Finishes \$		Custom Paint \$
			101	113	999
	807.400	Ln. Brush Profile for gaps 3/8" (10 mm) to 1/2" (12 mm) 118" (3,000 mm) Long	78	83	138
	807.402	Ln. Brush Profile for gaps 9/16" (14 mm) to 23/32" (18 mm) Only sold in 118" (3 m) Stock Length	78 ³	83	138
	807.385	Ea. (Grey Color)	List \$		
	807.326	Ea. Floor Guide Adjustable, 5/16" (8 mm) to 17/32" (13.5 mm)	65 ³		
Maximum Profile Extrusion Length = 157" (4 M) or Less			109		
DORMOTION Wood Door Accessories			3		
	907.378*	Ft. DORMOTION wood door bracket for "L" system. Maximum length 157" (4 m), for 1-3/4" (44 mm) thick door.	46		
	907.379*	Ft. DORMOTION wood door bracket for "XL" system. Maximum length 157" (4 m), for 1-3/4" (44 mm) thick door.	46		
	807.226	Ea. Floor Guide for Wood Door	3		

* Rollers not included. 109 Black Anodized only.

- ³ Standard or Non-Standard Fabricated; lead time up to 3 business days.
- ^{S0} Special Fabricated/Finish or Special Order; lead time up to 5 weeks.

NOTE: If ordering DORMOTION for 1-3/4" (44 mm) wood door applications 807.369 wood door adaptor and 807.226 wood door floor guide is required to be ordered separately. Standard DORMOTION roller kits are used.

- DRS Rails, Channels & Accessories
- Patch Fittings & Designer Pivots
- Offset Hung Patch Fittings
- Headers & Accessories
- Closers & Hardware
- Locksets
- Pulls & Handles
- Sliding Systems
- MANET
- Panic Hardware

DRS-120 and RS-120

Ordering Guide

Panel Type				Clear Opening Width	
FPONLY	— Fixed Panel Only	RS120 Options		Sliding Panel 1¹	Sliding Panel 2¹
2SP_2FP	— 2 Sliding, 2 Fixed Panels	807150	— RS 120 Syncro	SPECIFY	SPECIFY
2SP	— 2 Sliding Panels	807330	— RS 120 Wood		
1SP_1FP	— 1 Sliding, 1 Fixed Panel	NONE	— None		
1SP	— 1 Sliding Panel				
DRS120	1SP	CEILING	NONE	STD	continued below
DRS120	— DRS 120 Slider	WALL		STD	— Standard 1-3/16" Overlap
RS120	— RS 120 Slider	CEILING		SPECIFY	— Nonstandard Overlap, Specify
Model		Mount Type		Overlap	

Width		DRS Rail Height		Other DRS Rail Height²		Lock	
Fixed Panel 1¹	Fixed Panel 2¹	358	— 3-5/8"	358		BRASSLCK	Brass Lock 1-9/16" w/ 5/8" Throw
SPECIFY	SPECIFY	4	— 4"	4		NONE	None
		6	— 6"	6			
		10	— 10"	10			
		12MM		SQ	358	SQ	113
3/8" (10 mm)	10MM			TP	— Tapered	TP	101
1/2" (12 mm)	12MM			SQ	— Square	SQ	107
Glass Thickness		DRS Rail Profile		Other DRS Rail Profile²			108
							109
							114
							503
							599
							600
							601
							700
							701
							999
							Slider Finish

¹ Specify width in inches.

² Specify other DRS Rail Height or Other DRS Rail Profile if different from first set of rails.

DRS-120 Sliding System, Ceiling Mount

3/8" (10 mm) and 1/2" (12 mm) Glass Door Thickness

Model	Ref. #	U/M Description	Standard Finishes \$					Custom Powder \$
			101	108/109	503/599	600/601	700/701	999
Single Sliding Panel, Complete			3	3	(SO)	(SO)	3	(SO)
Square								
	207.051	Ea. Panel Width 20" to 35"	980	1,005	1,465	1,603	1,286	1,190
	207.052	Ea. Panel Width 36" to 47"	1,050	1,081	1,671	1,851	1,433	1,330
	207.053	Ea. Panel Width 48" to 59"	1,119	1,162	1,877	2,099	1,580	1,469
	207.054	Ea. Panel Width 60" to 72"	1,193	1,241	2,084	2,347	1,725	1,613
Tapered								
	207.067	Ea. Panel Width 20" to 35"	985	1,018	1,465	1,606	1,287	1,195
	207.068	Ea. Panel Width 36" to 47"	1,055	1,101	1,671	1,854	1,433	1,335
	207.069	Ea. Panel Width 48" to 59"	1,126	1,179	1,877	2,101	1,580	1,476
	207.070	Ea. Panel Width 60" to 72"	1,197	1,262	2,084	2,350	1,725	1,617

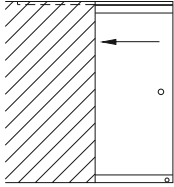

*See below for metric widths

Includes the following items

- Track (2 x panel width)
- Top 3-5/8" (92 mm) DRS rail with rollers
- Brackets
- Panel guides and panel stops
- Bottom 3-5/8" (92 mm) DRS rail with lock
- Cylinder, thumbturn, and dust-proof strike
- Concealed floor guide
- Handle not included, optional

Calculations for ceiling mount with 1 overlapping edge

- Sliding Panel Width = Clear opening* + 1-3/8" (35 mm)
- Track Length = (Clear opening* + 1-3/8" (35 mm)) x 2

* Allow for handle or lock projection when calculating.
 DRS lock projection allowance should be > 3" (76 mm).
 (Clear opening + 1-3/8" [35 mm] + panel projection allowance for handle/lock)

- 3** Standard or Non-Standard Fabricated; lead time up to 3 business days.
- (SO)** Special Fabricated/Finish or Special Order; lead time up to 5 weeks.

NOTES:

- When ordering, please specify glass thickness and sliding panel width.
- Maximum weight of sliding panel = 264 lb (120 kg).
- Track will be spliced when length exceeds 157" (4 m).
- Track only available mill finish, to be recessed when installed.

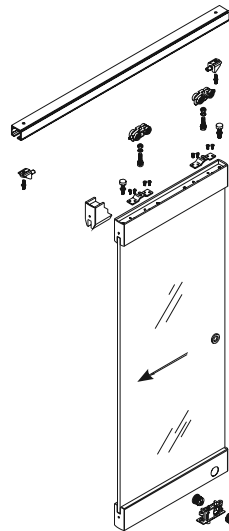

* Equivalent metric widths:
 20" to 35" = 508 mm to 889 mm
 36" to 47" = 914 mm to 1,194 mm
 48" to 59" = 1,219 mm to 1,499 mm
 60" to 72" = 1,524 mm to 1,829 mm

- DRS Rails, Channels & Accessories
- Patch Fittings & Designer Pivots
- Offset Hung Patch Fittings
- Headers & Accessories
- Closers & Hardware
- Locksets
- Pulls & Handles
- Sliding Systems
- MANET
- Panic Hardware

Model	Ref. #	U/M Description	Standard Finishes \$					Custom Powder \$
			101	108/109	503/599	600/601	700/701	999
Single Sliding Panel with Fixed Panel, Complete			3	3	SO	SO	3	SO
Square								
	207.059	Ea. Panel Width 20" to 35"	1,414	1,478	2,303	2,591	1,944	1,834
	207.060	Ea. Panel Width 36" to 47"	1,496	1,582	2,706	3,070	2,228	2,056
	207.061	Ea. Panel Width 48" to 59"	1,629	1,735	3,102	3,548	2,503	2,329
	207.062	Ea. Panel Width 60" to 72"	1,762	1,890	3,498	4,027	2,780	2,602
Tapered								
	207.075	Ea. Panel Width 20" to 35"	1,420	1,494	2,303	2,438	1,944	1,840
	207.076	Ea. Panel Width 36" to 47"	1,505	1,604	2,706	3,036	2,228	2,065
	207.077	Ea. Panel Width 48" to 59"	1,637	1,619	3,102	3,515	2,503	2,337
	207.078	Ea. Panel Width 60" to 72"	1,770	1,919	3,498	3,994	2,780	2,610

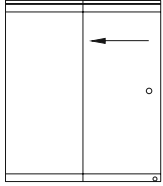

*See below for metric widths

Includes the following items

- Track (equal to overall opening width)
- Top 3-5/8" (92 mm) DRS rail with rollers Brackets
- Panel guides and panel stops
- Bottom 3-5/8" (92 mm) DRS rail with lock
- Cylinder, thumbturn, and dust-proof strike
- Concealed floor guide
- Top and bottom 3-5/8" (92 mm) DRS Dri-Fit Sidelites, including angle brackets to attach Dri-Fit Sidelites to track
- Handle not included, optional

Calculations for ceiling mount with 1 overlapping edge

- Sliding Panel Width = Clear opening* + 1-3/8" (35 mm)
- Track Length = Overall opening width
- Fixed Panel Width = Overall opening width – clear opening* width

* Allow for handle or lock projection when calculating.
 DRS lock projection allowance should be > 3" (76 mm).
 (Clear opening + 1-3/8" [35 mm] + panel projection allowance for handle/lock)

- 3 Standard or Non-Standard Fabricated; lead time up to 3 business days.
- SO Special Fabricated/Finish or Special Order; lead time up to 5 weeks.

NOTES:

- When ordering, please specify glass thickness, sliding panel width, and fixed panel width.
- Maximum weight of sliding panel = 264 lb (120 kg).
- Track will be spliced when length exceeds 157" (4 m).
- Track only available mill finish, to be recessed when installed.

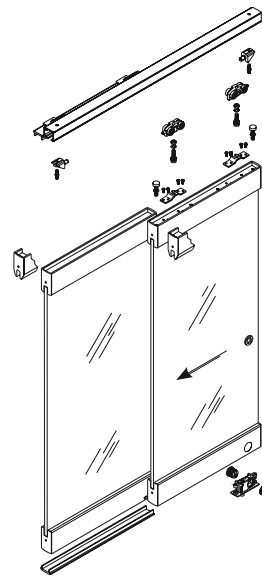

* Equivalent metric widths:
 20" to 35" = 508 mm to 889 mm
 36" to 47" = 914 mm to 1,194 mm
 48" to 59" = 1,219 mm to 1,499 mm
 60" to 72" = 1,524 mm to 1,829 mm

Model	Ref. #	U/M	Description	Standard Finishes \$					Custom Powder \$
				101	108/109	503/599	600/601	700/701	999
Two Sliding Panels, Complete				3	3	SO	SO	3	SO
Square									
	207.055	Ea.	Panel Width 20" to 35"	1,960	2,008	2,867	3,214	2,572	2,380
	207.056	Ea.	Panel Width 36" to 47"	2,102	2,166	3,343	3,709	2,865	2,662
	207.057	Ea.	Panel Width 48" to 59"	2,243	2,322	3,755	4,205	3,158	2,943
	207.058	Ea.	Panel Width 60" to 72"	2,385	2,480	4,168	4,701	3,452	3,226
Tapered									
	207.071	Ea.	Panel Width 20" to 35"	1,969	2,038	2,930	3,214	2,572	2,389
	207.072	Ea.	Panel Width 36" to 47"	2,111	2,203	3,343	3,709	2,865	2,671
	207.073	Ea.	Panel Width 48" to 59"	2,253	2,358	3,755	4,205	3,158	2,953
	207.074	Ea.	Panel Width 60" to 72"	2,393	2,522	4,168	4,701	3,452	3,233

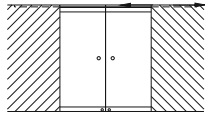

*See below for metric widths

Includes the following items

- Two tracks (each 2 x single panel width)
- Two top 3-5/8" (92 mm) DRS rails with rollers
- Brackets
- Panel guides and panel stops
- Two bottom 3-5/8" (92 mm) DRS rails with lock
- Cylinder, thumbturn, and dust-proof strike
- Concealed floor guides
- Handles not included, optional

Calculations for ceiling mount with 2 overlapping edges

- Sliding Panel Widths = (Clear opening* + 2-3/4" (70 mm)) / 2
- Track Length = (Clear opening* + 2-3/4" (70 mm)) x 2

* Allow for handle or lock projection when calculating.
 DRS lock projection allowance should be > 3" (76 mm).
 (Clear opening + 1-3/8" [35 mm] + panel projection allowance for handle/lock)

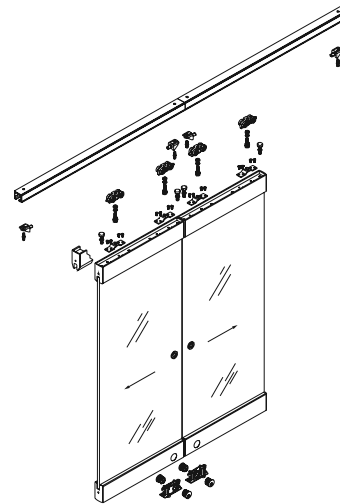

- 3 Standard or Non-Standard Fabricated; lead time up to 3 business days.
- SO Special Fabricated/Finish or Special Order; lead time up to 5 weeks.

† Equivalent metric widths:
 20" to 35" = 508 mm to 889 mm
 36" to 47" = 914 mm to 1,194 mm
 48" to 59" = 1,219 mm to 1,499 mm
 60" to 72" = 1,524 mm to 1,829 mm

NOTES:

- When ordering, please specify glass thickness and panel width.
- Maximum weight of sliding panel = 264 lb (120 kg).
- Track will be spliced when length exceeds 157" (4 m).
- Track available in mill finish only, to be recessed when installed.

DRS Rails, Channels & Accessories
 Patch Fittings & Designer Pivots
 Offset Hung Patch Fittings
 Headers & Accessories
 Closers & Hardware
 Locksets
 Pulls & Handles
 Sliding Systems
 MANET
 Panic Hardware

Model	Ref. #	U/M	Description	Standard Finishes \$					Custom Powder \$
				101	108/109	503/599	600/601	700/701	999
Two Sliding Panels with Two Fixed Panels, Complete				3	3	SO	SO	3	SO
Square									
	207.063	Ea.	Panel Width 20" to 35"	2,830	2,958	4,605	5,182	3,889	3,670
	207.064	Ea.	Panel Width 36" to 47"	2,992	3,163	5,412	6,139	4,456	4,112
	207.065	Ea.	Panel Width 48" to 59"	3,257	3,472	6,205	7,097	5,009	4,657
	207.066	Ea.	Panel Width 60" to 72"	3,522	3,779	6,996	8,055	5,561	5,202
Tapered									
	207.079	Ea.	Panel Width 20" to 35"	2,840	2,990	4,605	4,874	3,889	3,680
	207.080	Ea.	Panel Width 36" to 47"	3,010	3,208	5,412	6,074	4,456	4,130
	207.081	Ea.	Panel Width 48" to 59"	3,275	3,239	6,205	7,030	5,009	4,675
	207.082	Ea.	Panel Width 60" to 72"	3,540	3,839	6,996	7,988	5,561	5,220

*See below for metric widths

Includes the following items

- One or two tracks (equal to overall opening width)
- Two top 3-5/8" (92 mm) DRS rails with rollers
- Brackets
- Panel guides and panel stops
- Two bottom 3-5/8" (92 mm) DRS rails with lock
- Cylinder, thumbturn, and dust-proof strike
- Concealed floor guides
- Two top and bottom 3-5/8" (92 mm) DRS Dri-Fit Sidelites, including angle brackets to attach Dri-Fit Sidelites to track
- Handles not included, optional

Calculations for ceiling mount with 2 overlapping edges

- Sliding Panel Widths = (Clear opening* + 2-3/4" (70 mm)) / 2
- Track Length = Overall opening width
- Fixed Panel Width = (Overall opening width - clear opening* width)

* Allow for handle or lock projection when calculating.
 DRS lock projection allowance should be > 3" (76 mm).
 (Clear opening + 1-3/8" [35 mm] + panel projection allowance for handle/lock)

3 Standard or Non-Standard Fabricated; lead time up to 3 business days.



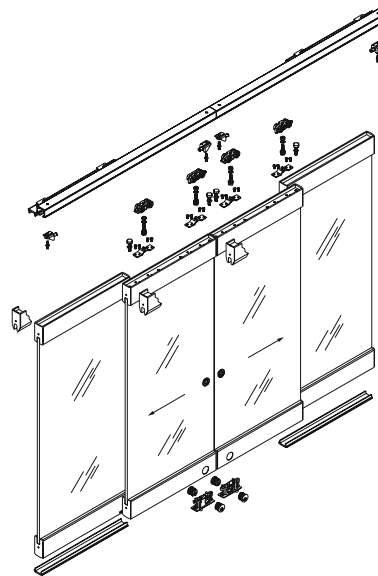





SO Special Fabricated/Finish or Special Order; lead time up to 5 weeks.



* Equivalent metric widths:
 20" to 35" = 508 mm to 889 mm
 36" to 47" = 914 mm to 1,194 mm
 48" to 59" = 1,219 mm to 1,499 mm
 60" to 72" = 1,524 mm to 1,829 mm

Accessories and Components

3/8" (10 mm) and 1/2" (12 mm) Glass Door Thickness

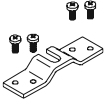
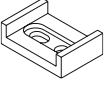
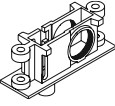
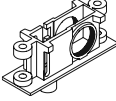
Model	Ref. #	U/M	Description	Standard Finishes \$					Custom Powder \$	List \$
				101	108/109	503/599	600/601	700/701	999	
Extrusions				③	③	Ⓢ0	Ⓢ0	③	Ⓢ0	
	925.035	Ft.	3-5/8" (92 mm) Square Anodized Cover	7	11	—	—	—	27	
	225.502	Ft.	Cladded Cover	—	—	32	40	19	—	
	925.036	Ft.	3-5/8" (92 mm) Tapered Anodized Cover	7	11	—	—	—	27	
	225.503	Ft.	Cladded Cover	—	—	32	40	19	—	
	925.042	Ft.	6" (152 mm) Square Anodized Cover	12	19	—	—	—	33	
	225.506	Ft.	Cladded Cover	—	—	42	43	28	—	
	907.121	Ln.	RS Track Max. Length 157" (4 m)	—	—	—	—	—	619	353 ③
Accessories										①
	907.997	Ea.	Panel Guide							8
	907.998	Ea.	Panel Stop							16
	907.704	Ea.	Roller							25
	907.996	Ea.	Roller Screw							8
	907.999	Ea.	Roller Bracket							17
	932.988	Ea.	Floor Guide							29
	925.019	Ea.	Brass Lock 1-9/16" (5/8" Throw)							36
	925.119	Ea.	Bottom Rail Brass Door Lock 1-9/16" (7/8" long throw fully retracted projects 1/4" below lock base							50

① Non-Fabricated item, ships in 1 business day.

③ Standard or Non-Standard Fabricated; lead time up to 3 business days.

Ⓢ0 Special Fabricated/Finish or Special Order; lead time up to 5 weeks.

NOTES:

- RS Track sold in stock lengths ONLY (linear).
- DORMA will cut to specific length at no charge, drop length will NOT be sent unless specified on purchase order.
- Maximum length for extrusions is 144" (3.66 m) before requiring a splice joint, 120" (3 m) for Brass and Bronze finishes.

DRS Rails, Channels & Accessories
Patch Fittings & Designer Pivots
Offset Hung Patch Fittings
Headers & Accessories
Closers & Hardware
Locksets
Pulls & Handles
Sliding Systems
MANET
Panic Hardware

RS-120 Sliding System, Wall and Ceiling Mount

5/16" (8 mm), 3/8" (10 mm), and 1/2" (12 mm) Glass Door Thickness

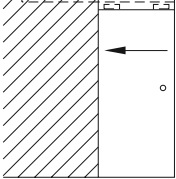
Model	Ref. #	U/M Description	Standard Finishes \$			Custom Powder \$
			101	108	700/701	999
Single Sliding Panel, Complete			3	SO	SO	SO
	207.001	Ea. Panel Width 20" to 35"	777	845	1,003	1,047
	207.002	Ea. Panel Width 36" to 47"	808	898	1,108	1,168
	207.003	Ea. Panel Width 48" to 59"	837	950	1,213	1,287
	207.004	Ea. Panel Width 60" to 72"	867	1,003	1,318	1,407

*See below for metric widths

Includes the following items

- Track (2 x panel width)
- Two covers (equal to panel width)
- Roller package with guide
- Handle and locks not included, optional

NOTE: For wall mount, request single full length cover (equal to track).

Calculations for wall mount with 2 overlapping edges

- Sliding Panel Width = Clear opening* + 3-1/8" (79 mm)
- Track Length = (Clear opening* + 3-1/8" (79 mm)) x 2

Calculations for ceiling mount with 1 overlapping edge

- Sliding Panel Width = Clear opening* + 1-9/16" (39 mm)
- Track Length = (Clear opening* + 1-9/16" (39 mm)) x 2

* Allow for handle or lock projection when calculating:
 (Clear opening + 1-9/16" [39 mm] + panel projection allowance for handle/lock)

3 Standard or Non-Standard Fabricated; lead time up to 3 business days.

SO Special Fabricated/Finish or Special Order; lead time up to 5 weeks.

NOTES:

- When ordering, please specify glass thickness and sliding panel width.
- Track will be spliced when length exceeds 157" (4 m).
- Maximum weight of sliding panel with two rollers = 264 lb (120 kg).
- Maximum weight of sliding panel with additional third roller package = 330 lb (150 kg).

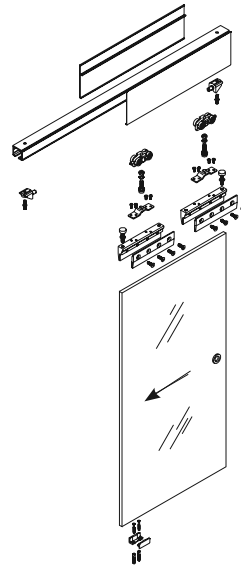

* Equivalent metric widths:
 20" to 35" = 508 mm to 889 mm
 36" to 47" = 914 mm to 1,194 mm
 48" to 59" = 1,219 mm to 1,499 mm
 60" to 72" = 1,524 mm to 1,829 mm

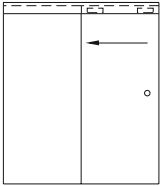
Model	Ref. #	U/M	Description	Standard Finishes \$			Custom Powder \$
				101	108	700/701	999
Single Sliding Panel with Fixed Panel, Complete				3	SO	SO	SO
	207.009	Ea.	Panel Width 20" to 35"	1,049	1,185	1,274	1,589
	207.010	Ea.	Panel Width 36" to 47"	1,165	1,346	1,465	1,885
	207.011	Ea.	Panel Width 48" to 59"	1,282	1,507	1,657	2,182
	207.012	Ea.	Panel Width 60" to 72"	1,397	1,668	1,848	2,477

*See below for metric widths

Includes the following items

- Track (equal to overall opening width)
- Two covers (equal to track)
- Top sidelite extrusion (equal to track)
- Bottom view protection
- Bottom sidelite Dri-Fit channel with gasket (equal to fixed panel width)
- Roller package with guide
- Handle and locks not included, optional

Calculations for ceiling mount with 1 overlapping edge

- Sliding Panel Width = Clear opening* + 1-9/16" (39 mm)
- Track Length = Overall opening width
- Fixed Panel Width = Overall opening width – clear opening* width

* Allow for handle or lock projection when calculating:
(Clear opening + 1-9/16" [39 mm] + panel projection allowance for handle lock)

- 3 Standard or Non-Standard Fabricated; lead time up to 3 business days.
- SO Special Fabricated/Finish or Special Order; lead time up to 5 weeks.

NOTES:

- When ordering, please specify glass thickness and sliding panel width.
- Track, sidelite channel, and covers will be spliced when length exceeds 157" (4 m).
- Maximum weight of sliding panel with two rollers = 264 lb (120 kg).
- Maximum weight of sliding panel with additional third roller package = 330 lb (150 kg).

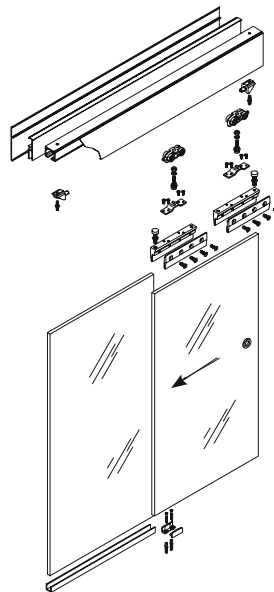

† Equivalent metric widths:
 20" to 35" = 508 mm to 889 mm
 36" to 47" = 914 mm to 1,194 mm
 48" to 59" = 1,219 mm to 1,499 mm
 60" to 72" = 1,524 mm to 1,829 mm

DRS Rails, Channels & Accessories

Patch Fittings & Designer Pivots

Offset Hung Patch Fittings

Headers & Accessories

Closers & Hardware

Locksets

Pulls & Handles

Sliding Systems

MANET

Panic Hardware

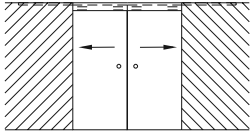
Model	Ref. #	U/M	Description	Standard Finishes \$			Custom Powder \$
				101	108	700/701	999
Two Sliding Panels, Complete				3	(SO)	(SO)	(SO)
	207.005	Ea.	Panel Width 20" to 35"	1,555	1,690	2,006	2,095
	207.006	Ea.	Panel Width 36" to 47"	1,615	1,795	2,215	2,335
	207.007	Ea.	Panel Width 48" to 59"	1,675	1,901	2,425	2,575
	207.008	Ea.	Panel Width 60" to 72"	1,735	2,006	2,635	2,815

*See below for metric widths

Includes the following items

- Two tracks (each 2 x single panel width)
- Two covers (equal to clear opening width)
- Roller package with guide
- Handle and locks not included, optional

NOTE: For wall mount, request single full length cover (equal to track).

Calculations for wall mount with 2 overlapping edges

- Sliding Panel Widths = (Clear opening* + 3-1/8" (79 mm)) / 2
- Track Length = (Clear opening* + 3-1/8" (79 mm)) x 2

Calculations for ceiling mount with 2 overlapping edges

- Sliding Panel Width = (Clear opening* + 3-1/8" (79 mm)) / 2
- Track Length = (Clear opening* + 3-1/8" (79 mm)) x 2

* Allow for handle or lock projection when calculating:
(Clear opening + 3-1/8" [79 mm] + panel projection allowance for handle/lock)

3 Standard or Non-Standard Fabricated; lead time up to 3 business days.

(SO) Special Fabricated/Finish or Special Order; lead time up to 5 weeks.

NOTES:

- When ordering, please specify glass thickness and sliding panel widths.
- Track and covers will be spliced when length exceeds 157" (4 m).
- Maximum weight of sliding panel with two rollers = 264 lb (120 kg).
- Maximum weight of sliding panel with additional third roller package = 330 lb (150 kg).

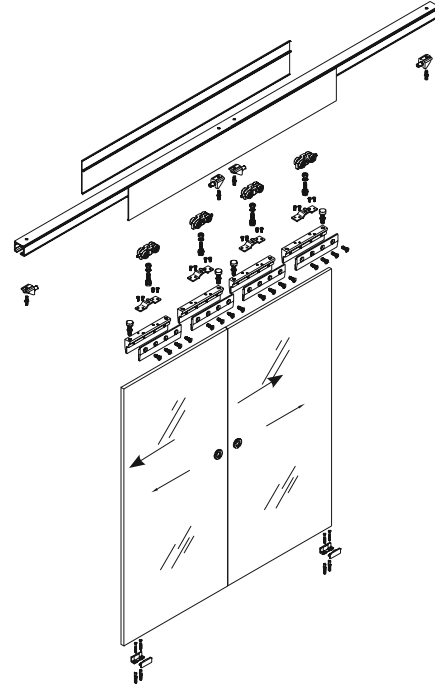

† Equivalent metric widths:
 20" to 35" = 508 mm to 889 mm
 36" to 47" = 914 mm to 1,194 mm
 48" to 59" = 1,219 mm to 1,499 mm
 60" to 72" = 1,524 mm to 1,829 mm

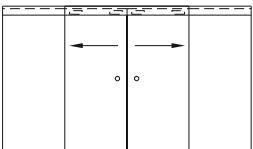
Model	Ref. #	U/M	Description	Standard Finishes \$			Custom Powder \$
				101	108	700/701	999
Two Sliding Panels with Two Fixed Panels, Complete				3	(SO)	(SO)	(SO)
	207.013	Ea.	Panel Width 20" to 35"	2,098	3,380	2,548	3,178
	207.014	Ea.	Panel Width 36" to 47"	2,331	3,590	2,631	3,771
	207.015	Ea.	Panel Width 48" to 59"	2,563	3,800	3,313	4,363
	207.016	Ea.	Panel Width 60" to 72"	2,795	4,010	3,695	4,955

*See below for metric widths

Includes the following items

- One or two tracks (equal to overall opening width)
- Two covers (equal to track or tracks)
- Top sidelite extrusion (equal to track or tracks)
- Bottom view protection (equal to clear opening width)
- Two bottom sidelite Dri-Fit channels with gasket (equal to fixed panel width)
- Roller package with guide
- Handle and locks not included, optional

Calculations for ceiling mount with 2 overlapping edges

- Sliding Panel Widths = (Clear opening* + 3-1/8" (79 mm)) / 2
- Track Length = Overall opening width
- Fixed Panel Width = (Overall opening width – clear opening* width) / 2

* Allow for handle or lock projection when calculating:
 (Clear opening + 3-1/8" [79 mm] + panel projection allowance for handle/lock)

- 3** Standard or Non-Standard Fabricated; lead time up to 3 business days.
- (SO)** Special Fabricated/Finish or Special Order; lead time up to 5 weeks.

NOTES:

- When ordering, please specify glass thickness and sliding panel widths.
- Track, sidelite channel, and covers will be spliced when length exceeds 157" (4 m).
- Maximum weight of sliding panel with two rollers = 264 lb (120 kg).
- Maximum weight of sliding panel with additional third roller package = 330 lb (150 kg)

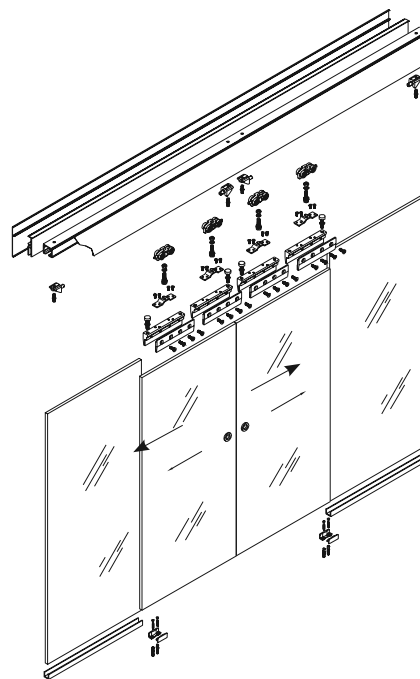

† Equivalent metric widths:
 20" to 35" = 508 mm to 889 mm
 36" to 47" = 914 mm to 1,194 mm
 48" to 59" = 1,219 mm to 1,499 mm
 60" to 72" = 1,524 mm to 1,829 mm

DRS Rails, Channels & Accessories

Patch Fittings & Designer Pivots

Offset Hung Patch Fittings

Headers & Accessories

Closers & Hardware

Locksets

Pulls & Handles





Sliding Systems

MANET

Panic Hardware

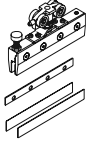
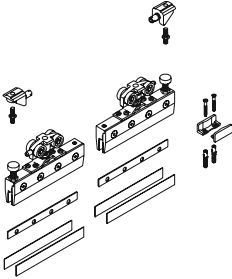
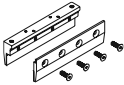

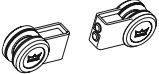







Accessories and Components

5/16" (8 mm), 3/8" (10 mm), and 1/2" (12 mm) Glass Door Thickness

Model	Ref. #	U/M	Description	Finishes \$	
				101	
Single Roller Package, Complete				(SO)	
	907.123	Ea.	Single Roller Package	152	(1)
Double Roller Package, Complete				(SO)	
	907.125	Ea.	Double Roller Package	348	(1)
Hardware					
	907.124	Ea.	Fitting for 3/8" (10 mm) Glass	79	
	807.118	Ea.	Shim for 1/2" (12 mm) Glass	15	
	907.900	Ea.	Shim for 5/16" (8 mm) Glass (gasket)	11	
				108/109	
	829.420	Ea.	Spacer for Bi-Parting Sliding Panels	98	
Endcaps					
	907.127	Ea.	Wall Mounted (without sidelite)	32	79 (SO) (108 only)
	907.129	Ea.	Endcap for Track when Ceiling Mounted (without sidelite)	32	76 (SO)

(1) Non-Fabricated item, ships in 1 business day.

(SO) Special Fabricated/Finish or Special Order; lead time up to 5 weeks.

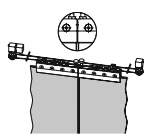
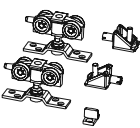
Model	Ref. #	U/M	Description	Standard Finishes \$				Custom Powder \$
				101	108/109	700/701	113	999
Extrusions and Accessories								
	907.120	Ft.	RS Cover	16 ³	28 ^(SO) (108 only)	—	26 ^(SO)	38 ^(SO)
	207.980	Ft.	RS Cover Cladded	—	—	55 ^(SO)	—	—
	907.126	Ea.	Floor Guide	—	14 ^(SO) (109 only)	—	—	—
				107		199		
	907.200	Set	Flush Pull	125 ⁽¹⁾	188 ⁽¹⁾	—	188 ^(SO)	—
				108		999		List \$
	907.121	Ln.	RS Track Length = 157" (4 m)	—	—	—	619 ^(SO)	353 ³
	907.122	Ft.	RS Sidelite Channel 5/16" (8 mm), 3/8" (10 mm), 1/2" (12 mm)	—	—	—	48 ^(SO)	26 ³
	907.138	Ft.	Bottom View Protector (used with Sidelites)	5	7	—	—	—
	907.997	Ea.	Panel Guide	—	—	—	—	8
	907.998	Ea.	Panel Stop	—	—	—	—	16
	907.704	Ea.	Roller	—	—	—	—	25
	907.996	Ea.	Roller Screw	—	—	—	—	8
	907.999	Ea.	Roller Bracket	—	—	—	—	17
RS-120 Synchronized Glass Applications								
	907.150	Ea.	Syncro Bi-Parting Roller Package (includes 2 sets of roller packages 07.125 and the cable set with blocks and pulleys)	1,179 ^(SO)				
NOTE: Track covers, view protection, and sidelite channel sold separately above								
RS-120 Wood Applications								
	807.135	Ea.	Wood Roller Package (track and covers sold separately above)	160 ^(SO)				

- ⁽¹⁾ Non-Fabricated item, ships in 1 business day.
- ⁽³⁾ Standard or Non-Standard Fabricated; lead time up to 3 business days.
- ^(SO) Special Fabricated/Finish or Special Order; lead time up to 5 weeks.

NOTES:

- Track sold in stock lengths ONLY.
- DORMA will cut to specific length at no charge; drop length will not be sent unless specified on purchase order.
- Maximum extrusion length is 157" (4 m) unless otherwise indicated above. Stainless steel covers max. length 144" (3.66 m).

DRS Rails, Channels & Accessories

Patch Fittings & Designer Pivots

Offset Hung Patch Fittings

Headers & Accessories

Closers & Hardware

Locksets



Pulls & Handles

Sliding Systems

MANET

Panic Hardware

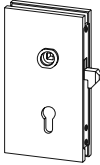
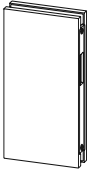
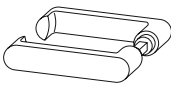
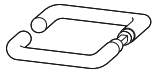
Sliding Applications Handle Options

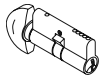
	Ref. #	U/M Description	Finishes \$			
			101	105/107	108/109	199
General Accessories				(SO)	(SO)	
	905.202	Ea. Hook Lock (includes wall mounted strike plate)	367 (SO)	477	612	—
	905.201	Ea. Strike Box	367 (SO)	434	612	—
	910.314	Set Set of Flat Lever Handles	57 (5)	74	—	105
	910.301	Set Set of Tubular Lever Handles	127 (5)	143	—	183
			107			
	907.200	Set Flush Pull	125	188 (1)	—	188 (SO)
Europrofile Accessories					503/599	700/701
	901.003	Ea. Profile Key Cylinder			(SO) 81	(SO) 60
	901.002	Profile Thumbturn Cyl.				
	901.004	Ea. Right Handed Cam			78	66
		Ea. Left Handed Cam			78	66

- (5) Non-Fabricated item, ships in 5 business days.
- (1) Non-Fabricated item, ships in 1 business day.
- (SO) Special Fabricated/Finish or Special Order; lead time up to 5 weeks.

NOTES:

- Euro cylinders are KA by default and KD is a special order.
- LH Housing requires RH cylinder; RH Housing requires LH cylinder.
- For 108 or 109 finish trim specify 199 and specify "to be finished black or dark bronze."

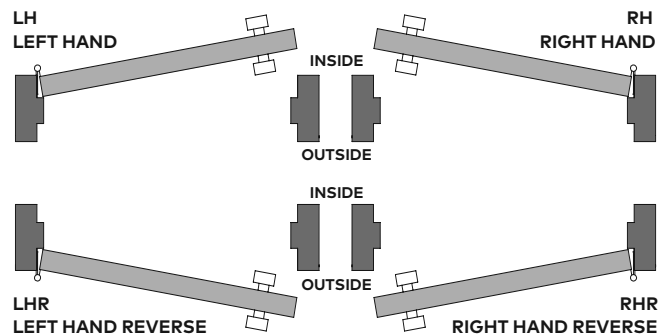

MANET Pivoting/Sliding Door Systems

MANET Compact	Pivoting Doors	160
	Sliding Doors	163
	Handles and Knobs	168
	Options and Accessories	169
MANET Accessories	Wet Environment Components (316 Stainless Steel)	175
	Wood Door Components	177
	Clamp Bracket Reference Chart	178

- DRS Rails, Channels & Accessories
- Patch Fittings & Designer Pivots
- Offset Hung Patch Fittings
- Headers & Accessories
- Closers & Hardware
- Locksets
- Pulls & Handles
- Sliding Systems
- MANET**
- Panic Hardware

DORMA MANET Set 1 Pivoting

Without transom for 3/8" to 1/2" (10 mm to 12 mm) glass

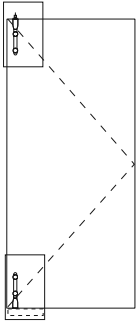
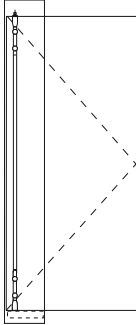
MANET Compact Set 1	Ref. #	U/M	Description	Finish \$
	829.910	Unit	SET 1 Consisting of: Pair of top/bottom pivot poles, short type Including: • 4 Single-point fittings for pivot poles • 1 Top pivot bearing • 1 Eccentric pivot bushing for ceiling install • 1 Bottom pivot bearing for DORMA BTS75V or floor pivot	426 ^①
	829.911	Unit	SET 1 with connecting tube Consisting of: Pair of top/bottom pivot poles, long type, connecting tube Including: • 4 Single-point fittings for pivot poles • 1 Top pivot bearing • 1 Eccentric pivot bushing for ceiling install • 1 Bottom pivot bearing for DORMA BTS75V or floor pivot • 1 Connecting tube at 85-7/16" (2170 mm)	447 ^{SO}

Application example for Set 1
 For detail information see Brochure **DORMA MANET Point fittings for interior applications.**

Door type 1

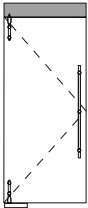

Door type 2

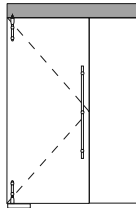

Door type 3

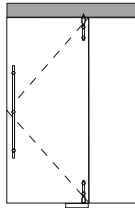

Door type 4

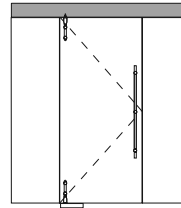

Door type 5

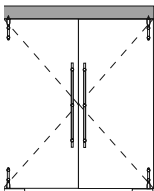

Door type 6

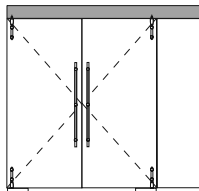

Door type 7

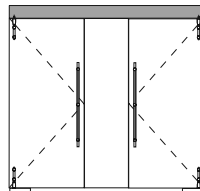

Door type 8

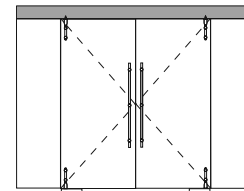

^① Non-Fabricated item, ships in 1 business day.

^{SO} Special Fabricated/Finish or Special Order; lead time up to 5 weeks.

NOTE: For handles, knobs, and other options and accessories, see page 174.

DORMA MANET Set 2 Pivoting

With transom for 3/8" to 1/2" (10 mm to 12 mm) glass

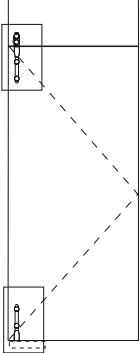
MANET Compact Set 2			Finish \$
Ref. #	U/M	Description	700
	829.912	Unit SET 2 Consisting of: Pair of top/bottom pivot poles, short type Including: • 4 Single-point fittings for pivot poles • 1 Top pivot bearing • 1 Pivot bearing location for transom • 1 Bottom pivot bearing for DORMA BTS75V or floor pivot	551 ^(SO)
	829.913	Unit SET 2 with connecting tube Consisting of: Pair of top/bottom pivot poles, long type, connecting tube Including: • 4 Single-point fittings for pivot poles, • 1 Top pivot bearing, • 1 Pivot bearing location for transom, • 1 Bottom pivot bearing for DORMA BTS75V or floor pivot • 1 Connecting tube at 85-7/16" (2170 mm)	573 ^(SO)

Application example for Set 2
 For detail information see the brochure **DORMA MANET Point fittings for interior applications.**

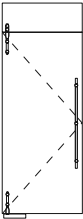
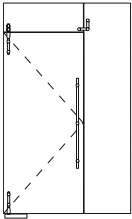
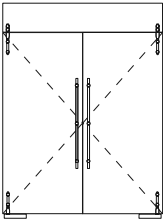
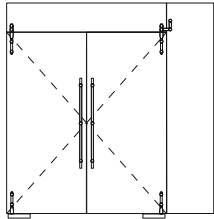
<p>Door type 9 1 × Set 2 required</p> 	<p>Door type 12 1 × Set 2 required and 1 × Transom/sidelite connector</p> 	<p>Door type 18 2 × Set 2 required</p> 	<p>Door type 21 2 × Set 2 required and 1 × Set 3 required</p> 
--	--	---	--

^(SO) Special Fabricated/Finish or Special Order; lead time up to 5 weeks.

NOTE: For handles, knobs, and other options and accessories, see page 174.

- DRS Rails, Channels & Accessories
- Patch Fittings & Designer Pivots
- Offset Hung Patch Fittings
- Headers & Accessories
- Closers & Hardware
- Locksets
- Pulls & Handles
- Sliding Systems
- MANET
- Panic Hardware

DORMA MANET Set 3 Pivoting

With transom and sidelite for 3/8" to 1/2" (10 mm to 12 mm) glass

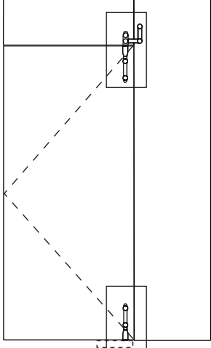
				Finish \$
MANET Compact Set 3	Ref. #	U/M	Description	700
	829.914	Unit	SET 3 Consisting of: Pair of top/bottom pivot poles, short type Including: • 4 Single-point fittings for pivot poles • 1 Top pivot bearing • 1 Transom/sidelite connector with pivot bearing location • 1 Bottom pivot bearing for DORMA BTS75V or floor pivot	668 ^①
	829.915	Unit	SET 3 Consisting of: Pair of top/bottom pivot poles, long type, connecting tube Including: • 4 Single-point fittings for pivot poles • 1 Top pivot bearing • 1 Transom/sidelite connector with pivot bearing location • 1 Bottom pivot bearing for DORMA BTS75V or floor pivot • 1 Connecting tube at 85-7/16" (2170 mm)	690 ^{SO}

Application example for Set 3
 For detail information see the brochure **DORMA MANET Point fittings for interior applications.**

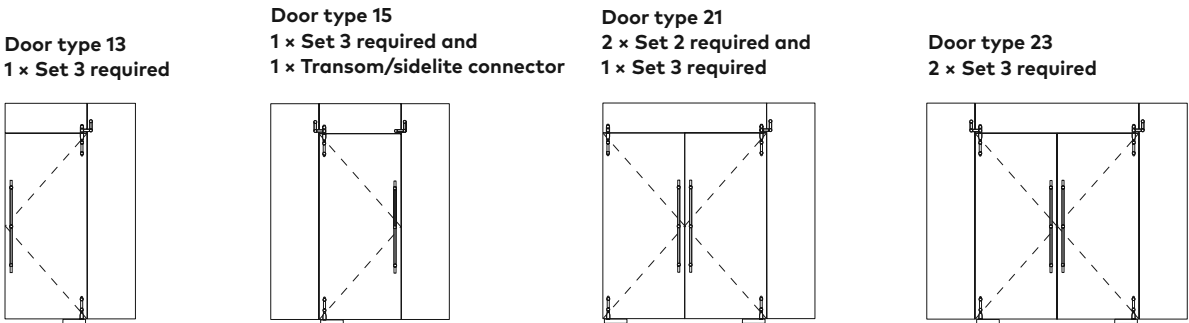

^① Non-Fabricated item, ships in 1 business day.
^{SO} Special Fabricated/Finish or Special Order; lead time up to 5 weeks.

NOTE: For handles, knobs, and other options and accessories, see page 174.

DORMA MANET Set 4.1 Sliding

Wall mount for 3/8" to 1/2" (10 mm to 12 mm)
glass countersunk single-point fittings

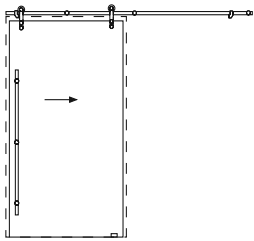
MANET Compact Set 4.1	Ref. #	U/M	Description	Finish \$
	829.916	Unit	SET 4.1 Consisting of: <ul style="list-style-type: none"> • 5 Clamp brackets track/wall • 2 Roller carriers; includes single-point fittings 5/16"-1/2" (8-12 mm) glass • 1 Door stop LH • 1 Door stop RH • 1 Floor guide AGILE • Assembly tool 	700 1,046 ^①
	821.527	Ln.	Sliding track tube including end caps; length 118" (3 m) track NOTE: Sliding track tube must be ordered separately with the above set in order to receive a complete system.	161 ^①

^① Non-Fabricated item, ships in 1 business day.

NOTE: For handles, knobs, and other options and accessories, see page 174.

DRS Rails,
Channels &
Accessories

Patch Fittings
& Designer
Pivots

Offset
Hung Patch
Fittings

Headers &
Accessories

Closers &
Hardware

Locksets

Pulls &
Handles

Sliding
Systems

MANET

Panic
Hardware

DORMA MANET Set 4.2 Sliding

Wall mount for 3/8" to 1/2" (10 mm to 12 mm)
glass clamping disk single-point fittings

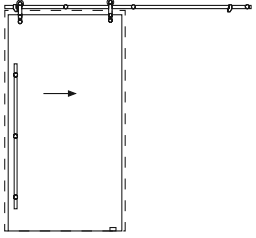
			Finish \$
MANET Compact Set 4.2	Ref. #	U/M Description	700
	829.917	Unit SET 4.2 Consisting of: <ul style="list-style-type: none"> • 5 Clamp brackets track/wall • 2 Roller carriers; includes single-point fittings 5/16" - 1/2" (8-12 mm) glass • 1 Door stop LH • 1 Door stop RH • 1 Floor guide AGILE • Assembly tool 	1,066 ①
	821.527	Ln. Sliding track tube including end caps; length 118" (3 m) track NOTE: Sliding track tube must be ordered separately with the above set in order to receive a complete system.	161 ①

① Non-Fabricated item, ships in 1 business day.

NOTE: For handles, knobs, and other options and accessories, see page 174.

DORMA MANET Set 5.1 Sliding

Glass mount, connected to wall on one side for 3/8" to 1/2" (10 mm to 12mm) glass countersunk single-point fittings

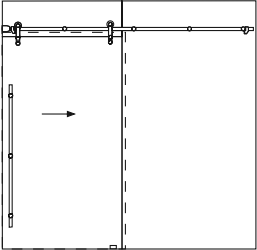
				Finish \$
MANET Compact Set 5.1	Ref. #	U/M	Description	700
	829.918	Unit	SET 5.1 Consisting of: <ul style="list-style-type: none"> • 6 Clamp brackets for glass, countersunk • 2 Roller carriers; includes single-point fitting 5/16" -1/2" (8-12 mm) glass • 1 Wall fitting, flattened • 1 Door stop LH • 1 Door stop RH • 1 Floor guide AGILE • Assembly tool 	1,290 ^①
	821.527	Ln.	Sliding track tube including end caps; length 118" (3 m) track NOTE: Sliding track tube must be ordered separately with the above set in order to receive a complete system.	161 ^①

^① Non-Fabricated item, ships in 1 business day.

NOTE: For handles, knobs, and other options and accessories, see page 174.

DRS Rails, Channels & Accessories

Patch Fittings & Designer Pivots

Offset Hung Patch Fittings

Headers & Accessories

Closers & Hardware

Locksets

Pulls & Handles

Sliding Systems

MANET

Panic Hardware

DORMA MANET Set 5.2 Sliding

Glass mount, connected to wall on one side for 3/8" to 1/2" (10 mm to 12 mm) glass clamping disk single-point fittings

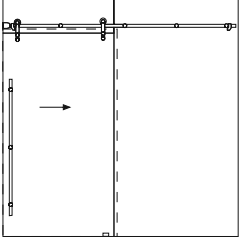
MANET Compact Set 5.2	Ref. #	U/M	Description	Finish \$
	829.919	Unit	SET 5.2 consisting of: <ul style="list-style-type: none"> • 6 Clamp brackets for glass, clamping disk single-point fittings • 2 Roller carriers; includes single-point fittings 5/16"-1/2" (8-12 mm) glass • 1 Wall fitting, flattened • 1 Door stop LH • 1 Door stop RH • 1 Floor guide AGILE • Assembly tool 	700 1,366 ^(SO)
	821.527	Ln.	Sliding track tube including end caps; length 118" (3 m) track NOTE: Sliding track tube must be ordered separately with the above set in order to receive a complete system.	161 ⁽¹⁾

⁽¹⁾ Non-Fabricated item, ships in 1 business day.

^(SO) Special Fabricated/Finish or Special Order; lead time up to 5 weeks.

NOTE: For handles, knobs, and other options and accessories, see page 174.

DORMA MANET Set 6.1 Sliding

Glass mount, sidelite both sides for 3/8" to 1/2" (10 mm to 12 mm) glass countersunk single-point fittings

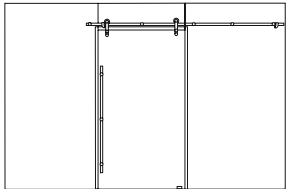
MANET Compact Set 6.1	Ref. #	U/M	Description	Finish \$
	829.920	Unit	SET 6.1 consisting of: <ul style="list-style-type: none"> • 7 Clamp brackets for glass • 2 Roller carriers; includes single-point fittings 5/16"-1/2" (8-12 mm) glass • 1 Door stop LH • 1 Door stop RH • 1 Floor guide AGILE • Assembly tool 	700 1,296 ⁽¹⁾
	821.527	Ln.	Sliding track tube including end caps; length 118" (3 m) track NOTE: Sliding track tube must be ordered separately with the above set in order to receive a complete system.	161 ⁽¹⁾

⁽¹⁾ Non-Fabricated item, ships in 1 business day.

NOTE: For handles, knobs, and other options and accessories, see page 174.

DORMA MANET Set 6.2 Sliding

Glass mount, sidelite both sides for 3/8" to 1/2" (10 mm to 12 mm) glass Clamping disk single-point fittings

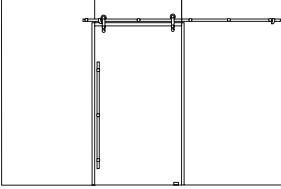
MANET Compact Set 6.2			Finish \$
Ref. #	U/M Description	700	
	829.921 Unit SET 6.2 consisting of:	1,435 ^(SO)	
	<ul style="list-style-type: none"> • 7 Clamp brackets for glass , clamping disk single-point fittings • 2 Roller carriers; includes single-point fittings 5/16" -1/2" (8-12 mm) glass • 1 Door stop LH • 1 Door stop RH • 1 Floor guide AGILE • Assembly tool 		
821.527	Ln. Sliding track tube including end caps; length 118" (3 m) track NOTE: Sliding track tube must be ordered separately with the above set in order to receive a complete system.	161 ⁽¹⁾	

⁽¹⁾ Non-Fabricated item, ships in 1 business day.

^(SO) Special Fabricated/Finish or Special Order; lead time up to 5 weeks.

NOTE: For handles, knobs, and other options and accessories, see page 174.

DRS Rails,
Channels &
Accessories

Patch Fittings
& Designer
Pivots

Offset
Hung Patch
Fittings

Headers &
Accessories

Closers &
Hardware

Locksets

Pulls &
Handles





Sliding
Systems

MANET

Panic
Hardware

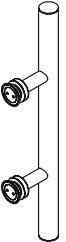
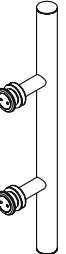
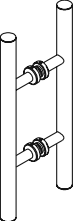
DORMA MANET Compact Sets

Handles and Knobs













Handles and Knobs	Ref. #	U/M Description	Finish \$
Handle, single side, countersunk for 5/16", 3/8", and 1/2" (8/10/12 mm) glass for MANET Compact Sets 1, 2, 3, 4.1, 5.1, and 6.1			(SO)
 <p>829.268 (shown)</p>	829.268	Ea. Length 13-25/32" (350 mm) 2F	209
	829.271	Ea. Length 28-11/32" (720 mm) 2F	276
	829.274	Ea. Length 48-13/16" (1,240 mm) 3F	343
	829.277	Ea. Length 69-9/16" (1,760 mm) 4F	410
Handle, single side, clamping disk for 5/16", 3/8", and 1/2" (8/10/12 mm) glass for MANET Compact Sets 4.2, 5.2, and 6.2			
 <p>821.240 (shown)</p>	821.240	Ea. Length 13-25/32" (350 mm) 2F	219
	821.241	Ea. Length 28-11/32" (720 mm) 2F	304
	821.242	Ea. Length 48-13/16" (1,240 mm) 3F	389
	821.243	Ea. Length 69-5/16" (1,760 mm) 4F	474
Handle, back to back for 5/16", 3/8", and 1/2" (8/10/12 mm) glass			
 <p>821.267 (shown)</p>	821.267	Ea. Length 13-25/32" (350 mm) 2F	303
	821.270	Ea. Length 28-11/32" (720 mm) 2F	404 (1)
	821.273	Ea. Length 48-13/16" (1,240 mm) 3F	505 (1)
	821.276	Ea. Length 69-5/16" (1,760 mm) 4F	607 (1)
Knobs			
	821.423	Ea. Knob, back to back; 5/16"-1/2" (8-12 mm) glass	121
	821.422	Ea. Knob, single side 5/16"-1/2" (8-12 mm) glass with countersunk single point fitting (MANET Compact Sets 4.1, 5.1, and 6.1)	135
	821.426	Ea. Knob, single side 5/16"-1/2" (8-12 mm) glass with clamping disk single point fitting (MANET Compact Sets 4.2, 5.2, and 6.2)	143

(1) Non-Fabricated item, ships in 1 business day.

(SO) Special Fabricated/Finish or Special Order; lead time up to 5 weeks.

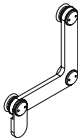
DORMA MANET Compact Sets

Options and Accessories

Accessories	Ref. #	U/M	Description	Finish \$
				700
				①
	821.334	Ea.	Stop for pivoting door, ceiling mounted (MANET Compact Set 1 only)	71
	829.335	Ea.	Door stop at transom (inside/outside) for 3/8"–1/2" (10–12 mm) glass (MANET Compact Sets 2 & 3 only)	122
	829.145	Ea.	G/C or G/F connector 90° (support only, no carrying function) (MANET Compact Set 1 only)	125
	829.337	Ea.	Ceiling connector for 5/16"–1/2" (8–12 mm) glass (MANET Compact Sets 1, 2, 3, 5.1 & 6.1 only)	152
	821.449	Ea.	Top/Bottom lock with profile cylinder rose inside for 5/16"–1/2" (8–12 mm) glass	228
	814.206	Ea.	Profile cylinder (for 821.448/449) (Mill Finish only)	32
	805.194	Ea.	Eccentric pivot bushing (for 821.448/449)	32
	829.320	Ea.	Transom/sidelite connector for 3/8"–1/2" (10–12 mm) glass (MANET Compact Sets 2 & 3 only)	225
	829.322	Ea.	Transom/sidelite connector with inside stop for 3/8"–1/2" (10–12 mm) glass (MANET Compact Sets 2 & 3 only)	316
	829.324	Ea.	Transom/sidelite connector with outside stop for 3/8" (10 mm) glass (MANET Compact Sets 2 & 3 only)	316
	829.325	Ea.	Transom/sidelite connector with outside stop for 1/2" (12 mm) glass (MANET Compact Sets 2 & 3 only)	316
829.322 (shown)				
				List \$
	829.338	Ea.	Ceiling connector for 5/16"–1/2" (8–12 mm) glass (MANET Compact Sets 5.2 & 6.2 only)	152 (SO)
	821.134	Ea.	Assembly tool, MANET single point fittings (Mill Finish)	19 (SO)
	829.217	Ea.	5 pcs. clip-on covers for single point fittings with spring	32 (SO)
	821.432	Ea.	Guide rail with brush seals aluminum; total length 118" (3 m) (MANET Compact Sets 4.1, 4.2, 5.1, 5.2, 6.1 & 6.2 only) (Mill Finish)	173 (SO)

① Non-Fabricated item, ships in 1 business day.

(SO) Special Fabricated/Finish or Special Order; lead time up to 5 weeks.

DRS Rails,
Channels &
AccessoriesPatch Fittings
& Designer
PivotsOffset
Hung Patch
FittingsHeaders &
AccessoriesClosers &
Hardware

Locksets

Pulls &
HandlesSliding
Systems

MANET

Panic
Hardware

DORMA MANET Single-Point Fittings

	Ref. #	U/M	Description	Finish \$
	Single point (3/8") glass to wall			700
				(S0)
	829.200	Ea.	5/16"–7/16" (8–11.5 mm) adjustable	50
	829.201	Ea.	7/16"–9/16" (11.5–14.5 mm) adjustable	50
	829.202	Ea.	9/16"–11/16" (14.5–22 mm) adjustable	50
	Single point (1/2") glass to wall			
	829.210	Ea.	5/16"–7/16" (8–11.5 mm) adjustable	57
	829.211	Ea.	7/16"–9/16" (11.5–14.5 mm) adjustable	57
	829.212	Ea.	9/16"–11/16" (14.5–22 mm) adjustable	57
	Single point (varies) glass to wall			
	829.205	Ea.	5/16"–3/8" (8–10 mm) NOT adjustable	32
	829.215	Ea.	1/2" (12 mm) NOT adjustable	39
	829.217	Ea.	5 pcs. clip-on covers for single point fittings with spring	32

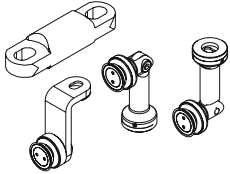
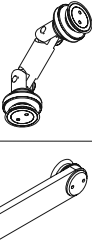

DORMA MANET Connecting System

	Ref. #	U/M	Description	Finish \$
				700
Connecting rods				(S0)
	821.355	Ea.	Length 2-1/16" (52.5 mm)	50
	829.145	Ea.	G/C or G/F connector 90° (support only, no carrying function)	125 (1)
	829.337	Ea.	Ceiling connector countersunk (carrying function)	152 (1)
	829.338	Ea.	Ceiling connector countersunk (clamping disk)	152
Glass to glass corner connectors 90°-180° for 5/16–1/2" glass				
	829.120	Ea.	Connecting rod length 2-1/16" (52.5 mm)	147
	829.122	Ea.	Connecting rod length 2-23/64" (60 mm)	147
	829.125	Ea.	Connecting rod length 3-7/32" (82 mm)	147
	829.130	Ea.	Connecting rod length 4-1/16" (103 mm)	147
	829.148		Connector for 5/16"–1/2" (8–12 mm) glass	95 (1)

(1) Non-Fabricated item, ships in 1 business day.

(S0) Special Fabricated/Finish or Special Order; lead time up to 5 weeks.

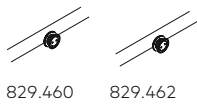
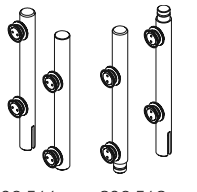
DORMA MANET Pivoting Door System

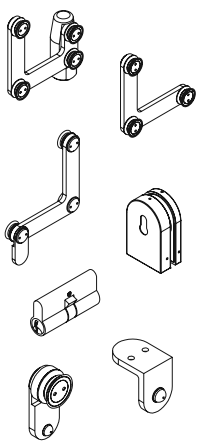
	Ref. #	U/M	Description	Finish \$
				700
Single point, countersunk, track to glass				(SO)
 <p>829.460 829.462</p>	829.460	Ea.	Fixed 3/8", 1/2" (10 mm, 12 mm) glass	26
	829.462	Ea.	Centering 3/8", 1/2" (10 mm, 12 mm) glass	39
Top/Bottom pivot pole set				
 <p>829.546 829.548</p>	829.546	Ea.	Short type (including 4 single point fix)	224
	829.548	Ea.	Short type for intermediate tube (including 4 single point fix)	392
	829.553	Ea.	Pivot pole, full height, RTS88	466
Intermediate tube Dia 1" (25 mm)				
	829.555	Ea.	Fix length up to 85-7/16" (2170 mm)	105
Pivot bearings				
	821.310	Ea.	Transom and ceiling connection	89
	821.314	Ea.	RTS (not shown)	140
	829.545	Ea.	DORMA BTS/floor pivot	111
	829.333	Ea.	Transom for 5/16"-1/2" (8-12 mm) glass	186
Transom/sidelite connector (right/left)				
	829.330	Ea.	With pivot bearing location, complete for 3/8", 1/2" (10 mm, 12 mm) glass	326
	829.320	Ea.	For 3/8", 1/2" (10 mm, 12 mm) glass	225 ^①
	829.322	Ea.	With stop inside for 3/8", 1/2" (10 mm, 12 mm) glass	316
	829.324	Ea.	With stop outside for 3/8" (10 mm) glass (not shown)	316
	829.325	Ea.	With stop outside for 1/2" (12 mm) glass (not shown)	316
	821.449	Ea.	Top/Bottom deadlock w/ profile cylinder rose on inside for 5/16"-1/2" (8-12 mm) glass	228 ^①
	814.206	Ea.	Profile cylinder (for 821.448/449)	32 ^①
	821.334	Ea.	Stop for pivoting door, ceiling mounted	71
829.335	Ea.	Door stop at transom (inside/outside) for 3/8", 1/2" (10 mm, 12 mm) glass	122	

① Non-Fabricated item, ships in 1 business day.

(SO) Special Fabricated/Finish or Special Order; lead time up to 5 weeks.

DRS Rails, Channels & Accessories

Patch Fittings & Designer Pivots

Offset Hung Patch Fittings

Headers & Accessories

Closers & Hardware

Locksets







Pulls & Handles

Sliding Systems

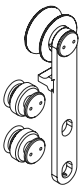
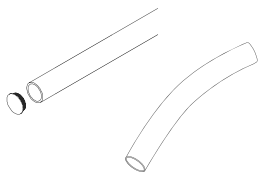
MANET

Panic Hardware

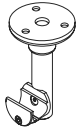





DORMA MANET Sliding Door System

			Finish \$
			700
	Ref. #	U/M Description	
Single point fitting for roller carrier			
	829.430	Ea. Countersunk for 5/16" -1/2" (8-12 mm) glass	56 ^①
	829.432	Ea. Clamping disk for 5/16" -1/2" (8-12 mm) glass (not shown)	56
Sliding track tube			
	821.527	Ea. Sliding track tube fixed length with end caps 118" (3 m) length	161 ^①
	821.413	Ft. Sliding track tube, bent r=min. 23-1/2" (600 mm), max. curve length 18.5' (5.6 m) with end caps	89
	829.506	Ea. Connection sliding track tube (not shown)	52 ^①
Clamp bracket fitting track to:			
	829.176	Ea. Glass, countersunk single point fitting for 3/8" -1/2" (10-12 mm) glass	90
	829.177	Ea. Glass, clamping disk single point fitting for 3/8" -1/2" (10-12 mm) glass	90
	829.175	Ea. Wall	71
	821.316	Ea. Ceiling retainer for sliding track, carrying function	333
Wall fitting for track			^{SO}
 829.445 Shown	829.445	Ea. Round	66
	829.422	Ea. Sliding door roller carrier with antijump mechanism (lug/roller only)	373 ^①

^① Non-Fabricated item, ships in 1 business day.

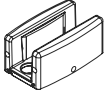
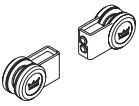
^{SO} Special Fabricated/Finish or Special Order; lead time up to 5 weeks.

DORMA MANET Pivoting/Sliding Door System

	Ref. #	U/M	Description	Finish \$
				700
Door stop				
	829.425	Ea.	Left hand	131
	829.426	Ea.	Right hand	131
Guides				
	821.432	Ea.	Guide rail brush seals, aluminum mill finish; stock length = 118" (3 m)	173 (SO)
	807.326	Ea.	Floor guide, for mount onto floor 5/16"-1/2" (8-12 mm) glass	66 (1)
	829.420	Ea.	Spacer for Bi-Parting Sliding Panels	96 (SO)
		901.106.001	Ea.	Floor pivot (100 only) Adjustable 5/16" to 1/2" (no cover) (MANET Compact Sets 1, 2 & 3 only)
				700
	901.079	Ea.	Floor pivot cover	23 (1)
		926.870	Ea.	Decorative floor stop with Duraflex bumper

(1) Non-Fabricated item, ships in 1 business day.

(SO) Special Fabricated/Finish or Special Order; lead time up to 5 weeks.

DRS Rails, Channels & Accessories

Patch Fittings & Designer Pivots

Offset Hung Patch Fittings

Headers & Accessories

Closers & Hardware

Locksets





Pulls & Handles

Sliding Systems

MANET

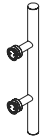
Panic Hardware

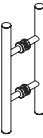
DORMA MANET Handles and Tools

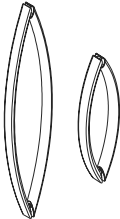



Handles and Knobs			Finish \$
	Ref. #	U/M Description	700
Handle, single side, countersunk for 5/16", 3/8", and 1/2" (8/10/12 mm) glass			(SO)
	829.268	Ea. Length 13-25/32" (350 mm) 2F	209
	829.271	Ea. Length 28-11/32" (720 mm) 2F	276
	829.274	Ea. Length 48-13/16" (1,240 mm) 3F	343
	829.277	Ea. Length 69-5/16" (1,760 mm) 4F	410
Handle, single side, clamping disk for 5/16", 3/8", and 1/2" (8/10/12 mm) glass			
	821.240	Ea. Length 13-25/32" (350 mm) 2F	219
	821.241	Ea. Length 28-11/32" (720 mm) 2F	304
	821.242	Ea. Length 48-13/16" (1,240 mm) 3F	389
	821.243	Ea. Length 69-5/16" (1,760 mm) 4F	474
Handle, back to back for 5/16", 3/8", and 1/2" (8/10/12 mm) glass			
	821.267	Ea. Length 13-25/32" (350 mm) 2F	303 (1)
	821.270	Ea. Length 28-11/32" (720 mm) 2F	404
	821.273	Ea. Length 48-13/16" (1,240 mm) 3F	505
	821.276	Ea. Length 69-5/16" (1,760 mm) 4F	607
Knobs			
	821.290	Ea. Recessed pull grip for 5/16", 3/8", 1/2" (8/10/12 mm) glass	81
	821.422	Ea. Knob, single side 5/16"-1/2" (8-12 mm) glass with countersunk single point fitting	135
	821.426	Ea. Knob, single side 5/16"-1/2" (8-12 mm) glass with clamping disk single point fitting	143
	821.423	Ea. Knob, back to back 5/16"-1/2" (8-12 mm) glass	121
Tools			
	821.134	Ea. Assembly tool, MANET single point fittings (No Finish)	23
	821.137	Ea. Hole gauge (No Finish)	30
	821.995	Ea. Sample case (not shown) (No Finish Designation)	968
ARCOS Handles			114
	826.500	Ea. Back to back ARCOS 13-25/32" (350 mm)	340
	826.510	Ea. Back to back ARCOS 29-17/32" (750 mm)	401

(1) Non-Fabricated item, ships in 1 business day.

(SO) Special Fabricated/Finish or Special Order; lead time up to 5 weeks.

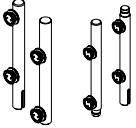
DORMA MANET Wet Environment Components

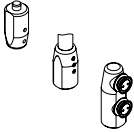
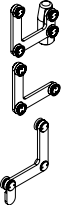
316 Stainless Steel

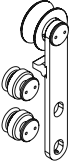
				Finish \$
Wet Environment Components	Ref. #	U/M	Description	700
Ceiling connectors, 5/16"-1/2" (8-12 mm) glass				(SO)
	829.339	Ea.	Ceiling connectors; 5/16"-1/2" (8-12 mm) glass (countersunk)	239
	829.340	Ea.	Ceiling connectors; 5/16"-1/2" (8-12 mm) glass (clamping disk); not shown	248
Wet single point, countersunk, track to glass				
	829.461	Ea.	Fixed 3/8", 1/2" (10 mm, 12 mm) glass	33
	829.463	Ea.	Centering 3/8", 1/2" (10 mm, 12 mm) glass	46
Wet intermediate tube dia. 1" (25 mm)				
	829.557	Ea.	Fixed length up to 85-7/16" (2170 mm)	387
Wet pivot bearings				
	821.350	Ea.	Transom and ceiling connection	107
	829.550	Ea.	DORMA BTS/floor pivot	198
	829.353	Ea.	Transom for 5/16"-1/2" (8-12 mm) glass; not shown	283
	829.540	Ea.	Floor pivot; max. door weight 132 lb (60 kg)	148
Wet transom/sidelite connector (right/left)				
	829.362	Ea.	With pivot bearing location, complete for 3/8", 1/2" (10 mm, 12 mm) glass	423
	829.360	Ea.	For 3/8", 1/2" (10 mm, 12 mm) glass	260
Wet sliding door systems (not shown)				
	829.423	Ea.	Sliding door roller carrier with anti-jump mechanism; lug/roller only (2 fittings required per roller, not included)	473
Wet 2 pcs. single point fitting for roller carrier				
	829.431	Ea.	Countersunk for 5/16"-1/2" (8-12 mm) glass	98
	829.433	Ea.	Clamping disk for 5/16"-1/2" (8-12 mm) glass (not shown)	121

(SO) Special Fabricated/Finish or Special Order; lead time up to 5 weeks.

DRS Rails,
Channels &
AccessoriesPatch Fittings
& Designer
PivotsOffset
Hung Patch
FittingsHeaders &
AccessoriesClosers &
Hardware

Locksets

Pulls &
HandlesSliding
Systems





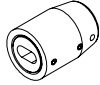
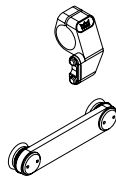
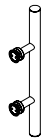
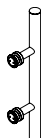
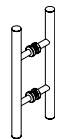



MANET

Panic
Hardware

			Finish \$
Wet Environment Components	Ref. #	U/M Description	700
Wet clamp bracket fitting track to:			(SO)
	829.185	Ea. Glass, countersunk single point fitting for 3/8"-1/2" (10-12 mm) glass	123
	829.186	Ea. Glass, clamping disk single point fitting for 3/8"-1/2" (10-12 mm) glass	140
	829.163	Ea. Wall	102
Wet wall fitting for track			
	829.446	Ea. Round	110
Wet door stop			
	829.427	Ea. Left hand	202
	829.428	Ea. Right hand	202
	829.368	Ea. Connector for 5/16"-1/2" (8-12 mm) glass	121
Wet handle, single side; countersunk for 5/16", 3/8", 1/2" (8/10/12 mm) glass			
	829.269	Ea. Length 13-25/32" (350 mm) 2F	318
	829.272	Ea. Length 28-11/32" (720 mm) 2F	333
	829.275	Ea. Length 48-13/16" (1,240 mm) 3F	405
	829.278	Ea. Length 69-5/16" (1,760 mm) 4F	524
Wet handle, single side, clamping disk			
	821.280	Ea. Length 13-25/32" (350 mm) 2F	330
	821.281	Ea. Length 28-11/32" (720 mm) 2F	375
	821.282	Ea. Length 48-13/16" (1,240 mm) 3F	507
	821.283	Ea. Length 69-5/16" (1,760 mm) 4F	657
Wet handle, Back to back			
	821.247	Ea. Length 13-25/32" (350 mm) 2F	485
	821.250	Ea. Length 28-11/32" (720 mm) 2F	578
	821.253	Ea. Length 48-13/16" (1,240 mm) 3F	673
	821.256	Ea. Length 69-5/16" (1,760 mm) 4F	802

(SO) Special Fabricated/Finish or Special Order; lead time up to 5 weeks.

Manet Wood Door Package Components

	Ref. #	U/M	Description	Finish \$
				700
	829.422	Ea.	Roller Carrier, stainless steel, lug only with roller, includes anti-jump, use with solid track tube (2 required per door panel/ price per roller)	373
	829.423	Ea.	Roller carrier, classic in 316L stainless steel	473
	829.510	Set	Countersunk single point fitting for roller carrier, 15/16" (24 mm) to 1-3/4" (44 mm) door thickness (1 set required per roller carrier)	71
	829.178	Ea.	Clamp bracket for mounting track to wall, 5/8" (16 mm) between track and wall, (See chart on the next page for quantity of clamps recommended)	123
	829.425	Ea.	Door stop, left hand (1 LH and RH required per door panel)	131
	829.426	Ea.	Door stop, right hand (1 LH and RH required per door panel)	131
	821.527	Ln.	Sliding track tube fixed length, 118" (3,000 mm) with end caps	161
				List \$
	807.226	Ea.	Floor guide for 1-3/4" (44 mm) wood door (1 required per sliding door panel)	3
	829.506	Ea.	Connector for sliding track tube (1 required for every 2 ea. 821.527)	52
	821.134	Ea.	Assembly tool, MANET single point fittings (No finish)	23

- DRS Rails, Channels & Accessories
- Patch Fittings & Designer Pivots
- Offset Hung Patch Fittings
- Headers & Accessories
- Closers & Hardware
- Locksets
- Pulls & Handles
- Sliding Systems
- MANET
- Panic Hardware

Clamp Bracket Reference Chart

Recommended distance of track clamp bracket points for hanging track tube

Door Height	Door Width — 27-1/2" (700 mm)		Door Width — 31-1/2" (800 mm)	
	Glass Thickness		Glass Thickness	
	3/8" (10 mm)	1/2" (12 mm)	3/8" (10 mm)	1/2" (12 mm)
74-13/16" (1,900 mm)	13-3/4" (350 mm)	13-3/4" (350 mm)	15-3/4" (400 mm)	15-3/4" (400 mm)
78-3/4" (2,000 mm)	13-3/4" (350 mm)	13-3/4" (350 mm)	15-3/4" (400 mm)	15-3/4" (400 mm)
82-11/16" (2,100 mm)	13-3/4" (350 mm)	13-3/4" (350 mm)	15-3/4" (400 mm)	15-3/4" (400 mm)
86-1/2" (2,200 mm)	13-3/4" (350 mm)	13-3/4" (350 mm)	15-3/4" (400 mm)	15-3/4" (400 mm)
90-9/16" (2,300 mm)	13-3/4" (350 mm)	13-3/4" (350 mm)	15-3/4" (400 mm)	15-3/4" (400 mm)
94-1/2" (2,400 mm)	13-3/4" (350 mm)	13-3/4" (350 mm)	15-3/4" (400 mm)	15-3/4" (400 mm)
98-7/16" (2,500 mm)	13-3/4" (350 mm)	13-3/4" (350 mm)	15-3/4" (400 mm)	15-3/4" (400 mm)
	Door Width — 35-7/16" (900 mm)		Door Width — 39-3/8" (1000 mm)	
	Glass Thickness		Glass Thickness	
	3/8" (10 mm)	1/2" (12 mm)	3/8" (10 mm)	1/2" (12 mm)
74-13/16" (1,900 mm)	17-11/16" (450 mm)	17-11/16" (450 mm)	19-11/16" (500 mm)	19-11/16" (500 mm)
78-3/4" (2,000 mm)	17-11/16" (450 mm)	17-11/16" (450 mm)	19-11/16" (500 mm)	19-11/16" (500 mm)
82-11/16" (2,100 mm)	17-11/16" (450 mm)	17-11/16" (450 mm)	19-11/16" (500 mm)	19-11/16" (500 mm)
86-1/2" (2,200 mm)	17-11/16" (450 mm)	17-11/16" (450 mm)	19-11/16" (500 mm)	19-11/16" (500 mm)
90-9/16" (2,300 mm)	17-11/16" (450 mm)	17-11/16" (450 mm)	19-11/16" (500 mm)	19-11/16" (500 mm)
94-1/2" (2,400 mm)	17-11/16" (450 mm)	17-11/16" (450 mm)	19-11/16" (500 mm)	19-11/16" (500 mm)
98-7/16" (2,500 mm)	17-11/16" (450 mm)	17-11/16" (450 mm)	19-11/16" (500 mm)	19-11/16" (500 mm)
	Door Width — 43-5/16" (1,100 mm)		Door Width — 47-1/4" (1,200 mm)	
	Glass Thickness		Glass Thickness	
	3/8" (10 mm)	1/2" (12 mm)	3/8" (10 mm)	1/2" (12 mm)
74-13/16" (1,900 mm)	21-3/4" (550 mm)	20-3/4" (530 mm)	21-5/8" (550 mm)	20-1/2" (520 mm)
78-3/4" (2,000 mm)	21-1/4" (540 mm)	20-1/16" (510 mm)	21-1/4" (540 mm)	20-1/16" (510 mm)
82-11/16" (2,100 mm)	20-3/4" (530 mm)	19-11/16" (500 mm)	20-7/8" (530 mm)	19-11/16" (500 mm)
86-1/2" (2,200 mm)	20-1/2" (520 mm)	19-5/16" (490 mm)	20-1/16" (510 mm)	18-7/8" (480 mm)
90-9/16" (2,300 mm)	20-1/16" (510 mm)	18-7/8" (480 mm)	19-11/16" (500 mm)	18-1/2" (470 mm)
94-1/2" (2,400 mm)	19-11/16" (500 mm)	18-1/2" (470 mm)	19-5/16" (490 mm)	18-1/8" (460 mm)
98-7/16" (2,500 mm)	19-5/16" (490 mm)	18-1/8" (460 mm)	18-7/8" (480 mm)	17-11/16" (450 mm)
	Door Width — 51-3/16" (1,300 mm)		Door Width — 55-1/8" (1,400 mm)	
	Glass Thickness		Glass Thickness	
	3/8" (10 mm)	1/2" (12 mm)	3/8" (10 mm)	1/2" (12 mm)
74-13/16" (1,900 mm)	21-3/4" (550 mm)	20-1/16" (510 mm)	21-1/4" (540 mm)	20-1/16" (510 mm)
78-3/4" (2,000 mm)	20-3/4" (530 mm)	19-11/16" (500 mm)	20-3/4" (530 mm)	19-11/16" (500 mm)
82-11/16" (2,100 mm)	20-1/2" (520 mm)	19-5/16" (490 mm)	20-1/2" (520 mm)	19-5/16" (490 mm)
86-1/2" (2,200 mm)	20-1/16" (510 mm)	18-7/8" (480 mm)	19-11/16" (500 mm)	18-1/2" (470 mm)
90-9/16" (2,300 mm)	19-11/16" (500 mm)	18-1/2" (470 mm)	19-5/16" (490 mm)	18-1/8" (460 mm)
94-1/2" (2,400 mm)	19-5/16" (490 mm)	18-1/8" (460 mm)	18-7/8" (480 mm)	—
98-7/16" (2,500 mm)	18-7/8" (480 mm)	17-11/16" (450 mm)	18-1/2" (470 mm)	—

Glass Panic Hardware

Order Forms	Glass Push Bar Hardware	180
	Cylinder and Keying	181
Ordering Guides	DG1000/DG1100/DG1300 Series	182
	Keyways	183
Glass Push Bar Hardware	Exterior Fixed Pull Handles	184
	DG1000/DG1100/DG1300 Series Hardware and Options	185
	Keyways and Keying Options	187

- DRS Rails, Channels & Accessories
- Patch Fittings & Designer Pivots
- Offset Hung Patch Fittings
- Headers & Accessories
- Closers & Hardware
- Locksets
- Pulls & Handles
- Sliding Systems
- MANET
- Panic Hardware**

Glass Push Bar Hardware Order Form

Fax completed form to
(888) 238-4401

Complete one form for each unit or set of units defined by the same options.

Date: ____ / ____ / ____

Company Name: _____ PO# _____

Contact Name: _____ Tel.# _____

Project Name: _____ City/State: _____

Architect: _____

Unit Type — check one:

Panic (P) Bar Type

- Dead Bolt (DB) Bar Type DG1000
- Dummy (DM) Bar Type DG1000

Top Latch

- DG1000
- DG1000
- DG1000

Bottom Latch Full Length Bar

- DG1100
- DG1100
- DG1300
- DG1100
- DG1300

Exterior Handle:

- A B C D
- E F G H J JS
- K KS L LS M MS
- N P X Y Z None

(See page I-7 for descriptions of exterior handles.)

DG1300 only: Top Bolt only (default) Bottom Bolt only Top and Bottom Bolts

Quantity of Units: _____

Swing: (Refer to Chart)

Single Acting, 3 4
Single Door: 5 6

Single Acting, 3 & 4
Pair: 5 & 6

DG1300 Only for Double Acting

Double Acting,
Single Door: 1 2

Double
Acting, Pair: 1 & 2

IMPORTANT

Jamb Condition: Sidelites Frame Clear Opening Width: _____
 Wall (Pivot distance must be increased to 3-1/2")

Header Size: 4-1/2" (DB Units only)
 6" (DG1000 P)

NOTE: DG1000 P and DG1100 P available in swing 3, 4 single doors, or 3 & 4 pairs only. Swing 1, 2, 5, 6 in singles or pairs for DB units (DG1000 DB, DG1100 DB, or all DG1300).

Electric Strike: 310-1 3/4" Straight Keeper — ES3101 PS610RF Power Supply

Check one < 24VDC 24VAC
 Fail Secure Fail Safe

Sill Condition: Floor Mounted Strike
 Threshold Ramp Strike (min. 1/2" x 7")

DORMA DRS Rails: Square Tapered (3-5/8" only) Height: 3-5/8" 4" 6" 10"

Door Type:

*F door type for use with DM units only

**Specify stile width

Narrow
Medium
Wide

Metal or Wood:
Specify x"

x" = Thickness of metal or wood door.

Glass/Door Thickness: 3/8" (9.5 mm) 1/2" (13 mm) 5/8" (16 mm) 3/4" (19 mm)

Actual Door Size: Width: _____ Height: _____ **Push Bar Height from Floor:** 42" Other: _____

Finish: Satin Stainless Steel (700/630) Polished Stainless Steel (701/629)
 Satin Brass (599/606) Polished Brass (503/605)
 Dark Oxidized Oil Rubbed Bronze (602/613) Custom: _____
(Special order; quote only) (Special order; quote only)

Cylinder and Keying Order Form

- Cylinder Type:**
- D – Conventional (default)
 - 91 – Dummy (Blank Cylinder)
 - 92 – Thumbturn Cylinder (Check local codes)
 - J – SFIC Cylinder with Dispensable Temporary Core
 - C – SFIC with Core (specify core)
 - T – SFIC with Temporary Construction Core

Cylinder Location by Bar Type

Panic (P): Exterior (default) Exterior x Dummy (blank)

Dead Bolt (DB): Cylinder Exterior x Thumbturn Interior (default)
 Cylinder Exterior x Cylinder Interior
 Thumbturn Exterior x Thumbturn Interior (Check local codes)

Keyways Options

Conventional: SC – Schlage C (default) SE – Schlage E D100 – DORMA SKC

SFIC:

- Less Core 00
- Best Keyways
 - BA
 - BB
 - BC
 - BD
 - BE
 - BF
 - BG
 - BH
 - BJ
 - BK
 - BL
 - BM
 - BQ
- DORMA D100 (DORMA SKC 7-pin Core only)
- Construction Colors Black Blue Green

Keying Options

Conventional: KD – Keyed Different (default) MKD – Master Keyed
 KA2 – Keyed Alike (set of 2) CMK – Construction Master Keyed
 KA4 – Keyed Alike (set of 4) 0BIT – 0-Bitted
 NSK – Non-Stock Keyed Alike

SFIC:

- TMP – Temporary Construction Core
- MKD – Combinated (Master Keyed)
- UNC – Uncombinated (No Pins)

NOTE: Default cylinder **D SC** is always shipped installed in device. Other cylinder options require replacement in the field.

- DRS Rails, Channels & Accessories
- Patch Fittings & Designer Pivots
- Offset Hung Patch Fittings
- Headers & Accessories
- Closers & Hardware
- Locksets
- Pulls & Handles
- Sliding Systems
- MANET
- Panic Hardware

DG1000 Series

Ordering Guide

Pull Type		Strike		Finish		Cylinder Location (1300 DB Only)		Shear Lock	
Straight Horizontal	A	S1	— Single Ramp Strike	700	— Satin Stainless Steel (SS/630)	CYL×TT	— Cylinder × Thumbturn (Default)	NONE	— None
90° Up, Short	B	S2	— Double Ramp Strike	701	— Polished Stainless Steel (PS/629)	CYL×CYL	— Cylinder × Cylinder	2765	— 2765
90° Down, Long	C	S3	— Floor Mount Dome Strike – DG1100, 5/8" protection off floor	503	— Polished Brass w/o Laquer (PB)	TT×TT	— Thumbturn × Thumbturn ⁴		
90° Up, Long	D	S4	— Threshold Mount Ramp Strike	599	— Satin Brass w/o Laquer (SB)				
90° Down, Short	E	ES1	— Ramp w/ Single Electric Strike	602	— Oil Rubbed Bronze (10B/613) ²				
Straight Vertical, Full Length	F	ES2	— Ramp w/ Double Electric Strike						
Straight Vertical Centered Short, Radius Top	G	S5	— Adjustable Eccentric Bushing						
Straight Vertical Centered Short, Radius Bottom	H	S6	— 1-1/4" Dust Proof Strike						
Straight Vertical, Center to Top, Radius Bottom	J	S7	— Flat Strike Plate						
Straight Vertical, Center to Top, No Radius	JS								
Straight Vertical, Center to Bottom, Radius Top	K								
Straight Vertical, Center to Bottom, No Radius	KS								
Straight Vertical, 3/4 Length from Top, Radius Bottom	L								
Straight Vertical, 3/4 Length from Top, No Radius	LS								
Straight Vertical, 3/4 Length from Bottom, Radius Top	M								
Straight Vertical, 3/4 Length from Bottom, No Radius	MS								
Straight Vertical, Mini, Radius Bottom	N								
Straight Vertical, Mini, Radius Top	P								
Straight Vertical, Mini, Off Center Up, Radius Top & Bottom	X								
Straight Vertical, Mini, Off Center Down, Radius Top & Bottom	Y								

Series	Bar Style	Function	Bolt Location (1300 DB Only)	Door Type	Swing	Glass/Door Thickness	Electric Strike	Keyway & Keying Options
DG1000	P	D	4	1/2	700	NONE		
Top Bar Only	1000	P — Panic	TB — Top Bolt Only (default)	A	3	1/2 — 1/2"	SEDC — Fail Secure, 24VDC	Keyway & Keying Options 
Bottom Bar Only	1100	DB — Dead Bolt	BB — Bottom Bolt Only	BP	4	3/8 — 3/8"	SADC — Fail Safe, 24VDC	
Full Length Straight	1300	DM — Dummy Bar	TBB — Top & Bottom Bolt	P	3&4	5/8 — 5/8"	SAAC — Fail Secure, 24VAC	
Straight Vertical Bar				F		3/4 — 3/4"	SEAC — Fail Safe, 24VAC	
				X³		1-3/4 — 1-3/4" >1-3/4 — Specify ¹		

¹Specify glass/door thickness if greater than 1-3/4".

²Special Order—Quote Only. Not available for all products.

³Specify X if none of the above door types.

⁴Check local codes.

Keyways

Ordering Guide

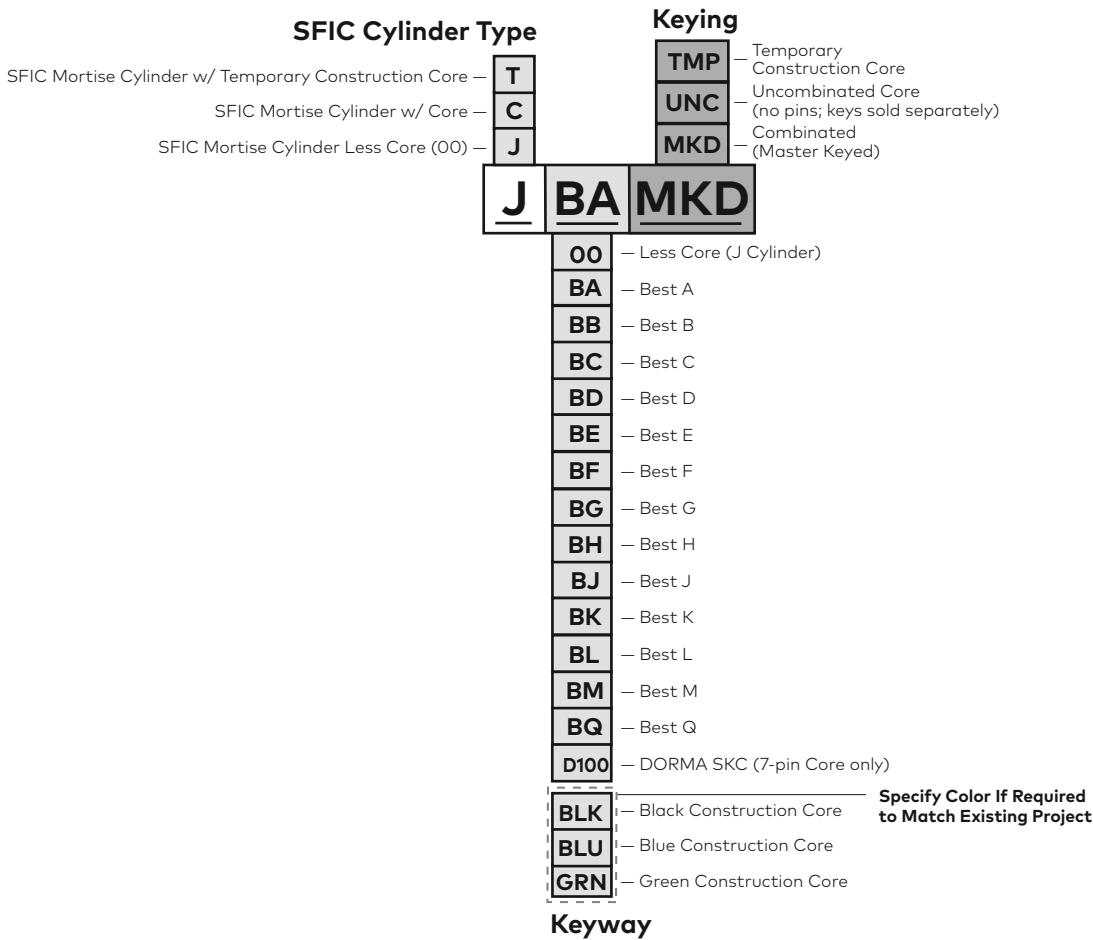
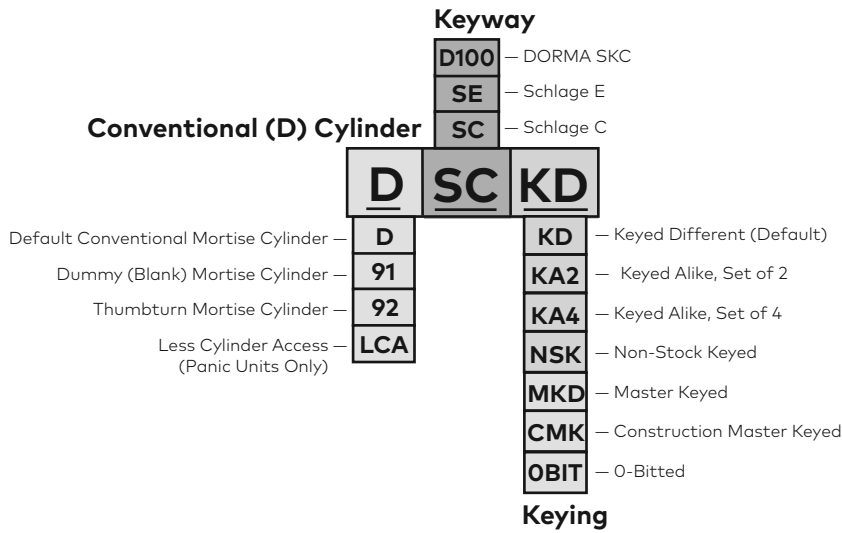

NOTES:

- Allow additional 4-week lead-time for D conventional cylinder by SE or D100 keyways.
- Allow additional 4-week lead-time for all keying options on D conventional cylinders except default KD.
- See page 188 for SFIC cylinder list price ADDs.
- If SFIC (J or C) cylinder is ordered, a default core is provided at no charge. It includes BA keyway, change key, and two operable keys.
- Core for C type cylinder option packaged separately, see page 187 for list price ADDs.
- Allow up to 4-week lead-time for SFIC cores for C type cylinder options and Master Keying.

- DRS Rails, Channels & Accessories
- Patch Fittings & Designer Pivots
- Offset Hung Patch Fittings
- Headers & Accessories
- Closers & Hardware
- Locksets
- Pulls & Handles
- Sliding Systems
- MANET
- Panic Hardware

Exterior Fixed Hardware Pull Handles

Product Detail

All available handle types are shown below. For reference, the following information appears below each handle:

The List Add Price for that handle in Finish 700.

Symbols for the door types allowed with that handle.

Key to symbols:

- DG1000
- DG1100
- △ DG1300

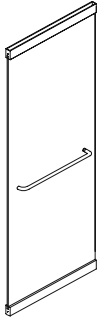

Handle A

List Add \$: 391
Door Type: ● ○ △

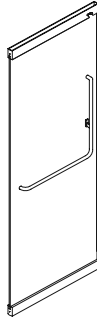

Handle B

List Add \$: 1,077
Door Type: ● ○ △

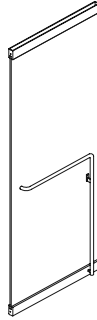

Handle C

List Add \$: 1,611
Door Type: ● ○ △

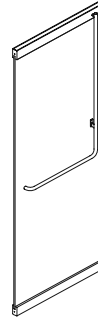

Handle D

List Add \$: 1,040
Door Type: ● ○ △

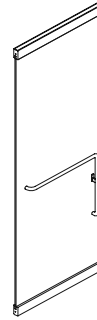

Handle E

List Add \$: 895
Door Type: ● ○ △

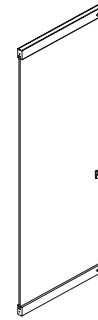

Handle F

List Add \$: 1,506
Door Type: ● ○ △

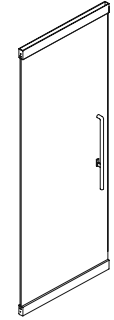

Handle G

List Add \$: 943
Door Type: ● △

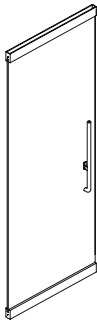

Handle H

List Add \$: 931
Door Type: ● △

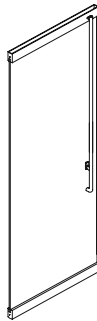

Handle J

List Add \$: 991
Door Type: ● △



Handle JS

List Add \$: 991
Door Type: ● △



Handle K

List Add \$: 991
Door Type: ○ △



Handle KS

List Add \$: 991
Door Type: ○ △



Handle L

List Add \$: 991
Door Type: ○ △

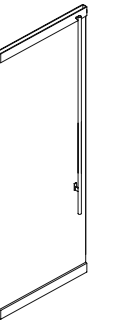

Handle LS

List Add \$: 991
Door Type: ○ △

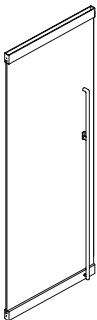

Handle M

List Add \$: 991
Door Type: ● △

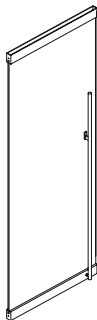

Handle MS

List Add \$: 991
Door Type: ● △

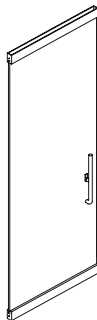

Handle N

List Add \$: 857
Door Type: ○ △

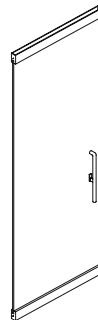

Handle P

List Add \$: 857
Door Type: ● ○ △



Handle X

List Add \$: 857
Door Type: ● ○ △

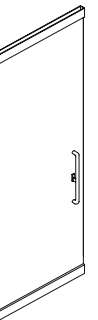

Handle Y

List Add \$: 857
Door Type: ● ○ △

DG1000/DG1100/DG1300 Series

Hardware and Options

			Finishes \$			
Product Configuration	Ref. #	Description	700	701	599	503
			(20)	(20)	(20)	(20)
DG1000P	970.100	Top bar only, latching panic, no pull	3,305	3,773	4,173	4,833
DG1000DB	970.210	Top bar only, dead bolt, no pull	3,449	3,697	4,126	4,831
DG1000DM	970.310	Dummy, non-latching top bar only, no pull	1,183	1,183	1,210	1,354
DG1100P	970.110	Bottom bar only, latching panic, no pull	3,596	4,676	4,411	5,068
DG1100DB	970.211	Bottom bar only, dead bolt, no pull	3,763	4,666	4,380	5,086
DG1100DM	970.311	Dummy, non-latching bottom bar only, no pull	1,183	1,183	1,210	1,354
DG1300DB	970.213	Dead bolt, full length vertical bar, no pull (Specify Top only [default], Bottom only, or Top/Bottom bolt)	3,763	4,666	4,380	5,086
DG1300DM	970.313	Dummy, full length vertical bar, no bolt, no pull	1,220	1,220	1,334	1,500
Pull Handle Options			List Add \$			
A	970.401	A style pull	391	454	534	740
B	970.402	B style pull	1,077	1,140	1,220	1,426
C	970.403	C style pull	1,611	1,677	1,760	1,963
D	970.404	D style pull	1,040	1,163	1,246	1,449
E	970.405	E style pull	894	974	1,097	1,303
F	970.406	F style pull	1,506	1,566	1,643	1,831
G	970.407	G style pull	943	1,026	1,146	1,351
H	970.408	H style pull	931	1,011	1,134	1,340
J	970.409	J style pull	991	1,060	1,183	1,389
JS	970.410	JS style pull	991	1,060	1,183	1,389
K	970.411	K style pull	991	1,060	1,183	1,389
KS	970.412	KS style pull	991	1,060	1,183	1,389
L	970.413	L style pull	991	1,060	1,183	1,389
LS	970.414	LS style pull	991	1,060	1,183	1,389
M	970.415	M style pull	991	1,060	1,183	1,389
MS	970.416	MS style pull	991	1,060	1,183	1,389
N	970.417	N style pull	857	940	1,183	1,389
P	970.418	P style pull	857	940	1,183	1,389
X	970.419	X style pull	857	940	1,183	1,389
Y	970.420	Y style pull	857	940	1,183	1,389
Z	—	No pull	—	—	—	—

(20) Custom Fabricated; lead time up to 20 business days.

NOTES:

- Manual or electric strikes not included in base price.
- Allow up to an additional 4 weeks lead time for 602 or other non-standard finishes, fabrication, or configurations.

DRS Rails, Channels & Accessories
Patch Fittings & Designer Pivots
Offset Hung Patch Fittings
Headers & Accessories
Closers & Hardware
Locksets
Pulls & Handles
Sliding Systems
MANET
Panic Hardware

Hardware and Options Continued

Product Configuration	Ref. #	Description	Finishes \$			
			700	701	599	503
			(20)	(20)	(20)	(20)
Options			List Add \$			
S1	970.598	Ramp strike for DG1000, single door	143	146	174	177
S2	970.599	Ramp strike for DG1000, double door	246	249	426	460
ES1	ES1	Single ramp plus 1 each ES3101 Electric Strike for DG1000, single door	1,089	1,091	1,103	1,100
ES2	ES2	Double ramp plus 2 each ES3101 Electric Strikes for DG1000, double door	2,011	2,017	2,026	2,020
ES2-3	ES2-3	Double ramp plus 1 each Manual Strike and 1 each ES3101 Electric Strike for DG1000, double door	1,840	1,846	1,854	1,849
S3	970.593	Floor mounted dome strike for DG1100, 5/8" (16mm) projection off floor	86	—	—	—
S4	970.592	Threshold mounted strike for DG1100 (ADA)	160	—	—	—
S5	805.194	Eccentric bushing, adjustable center for DB units	46	—	—	—
S6	932.033	Dust-proof strike, 1-1/4" (32 mm) length	26	26	26	26
S7	925.140	Flat strike plate	13	13	13	13
FIT5875	970.582	Fitting pack for 5/8" (16 mm) or 3/4" (19 mm) thick glass	83	83	83	83
FIT175	970.583	Fitting pack for 1-3/4" (44 mm) thick wood or aluminum door	83	83	83	83
FIT>175	970.584	Fitting pack for greater than 1-3/4" (44 mm) thick wood or aluminum door (Verify desired door thickness with Technical Service.)	150	150	150	150
Panic Accessories						
ES1.C	970.499	Ramp Assembly Component for Electric Strike (Less Electric Strike)	246	249	260	257
ES2.C	970.500	Double Ramp Assembly Component for Pair of Electric Strikes (Less Electric Strike)	326	331	340	334
ES3101_SE_DC	970.506	FA 310-1 24VDC Fail Secure	848	—	—	—
ES3101_SA_DC	970.505	FA 310-1 24VDC Fail Safe	848	—	—	—
ES3101_SE_AC	970.502	FA 310-1 24VAC Fail Secure	848	—	—	—
ES3101_SA_AC	970.501	FA 310-1 24VAC Fail Safe	848	—	—	—
EMSL2765	933.025	2700 LB Shear Lock	1,140	—	—	—
EMSL2765SC	925.846	2700 LB Semi-Concealed	1140	—	—	—
						101
EML-371	925.811	Single Magnetic Lock, 750 lb (340 kg)				330
EML-371 BA DP	925.812	Single Magnetic Lock, 750 lb (340 kg) with bond sensor and door position switch				445
EML-372	925.810	Double Magnetic Lock, 750 lb (340 kg)				660
EML-372 BA DP	925.813	Double Magnetic Lock, 750 lb (340 kg) with bond sensor and door position switch				890

(20) Custom Fabricated; lead time up to 15 business days.

Product Configuration	Ref. #	Description	Finishes \$					
			101	700	701	599	503	
				②0	②0	②0	②0	
				List Add \$				
HSTOP	233.989	Header stop for single or pairs of doors (top latching panic only)	19	46	46	46	46	
DBSTOP	233.988	Dead bolt header stop for single or pairs of doors (DB only)	—	140	155	—	—	
3118	970.790	Armored flex conduit, 18" (457 mm)	—	33 (101)	33 (108)	49 (714) White Painted	—	
3218	970.791	Heavy-Duty armored flex conduit, 18" (457 mm) with J-box	—	65	—	—	—	

②0 Custom Fabricated; lead time up to 15 business days.

Keyways and Keying Options

Model	Conventional Cylinder Options with Panic or Dead Bolt Bars	All Standard Finishes [†]	Additional
Cylinder Description		List Add \$	Lead Time
D SC	Conventional Cylinder with Schlage C Keyway (default)	NC	None
D SE	Conventional Cylinder with Schlage E Keyway	NC	20 Days
D D100	Conventional Cylinder with DORMA Patented Keyway	NC	20 Days
91	**Dummy (Blank) Mortise Cylinder (in lieu of D)	NC	None
92	**Thumbturn Mortise Cylinder (in lieu of D)	14	None
Conventional Cylinder Keying Description			
KD	Keyed Different (Default)	NC	None
KA2	Keyed Alike, Set of 2	NC	20 Days
KA4	Keyed Alike, Set of 4	NC	20 Days
NSK	Non-Stock Keyed	10	20 Days
MKD	Master Keyed (per core)	16	20 Days
CMK	Construction Master Keyed (per core)	13	20 Days
0-Bit	0 Bitted	NC	20 Days

②0 Custom Fabricated; lead time up to 20 business days.

NOTE: Cylinder options other than **D SC** will be shipped loose to be replaced in the field.

** For Model 91 or 92, check local codes.

[†] Standard finishes: 503 (605), 599 (606), 700 (630), and 701 (629).

DRS Rails, Channels & Accessories
Patch Fittings & Designer Pivots
Offset Hung Patch Fittings
Headers & Accessories
Closers & Hardware
Locksets
Pulls & Handles
Sliding Systems
MANET
Panic Hardware

Model	SFIC Cylinder Options	All Standard Finishes [†]	
	SFIC Cylinder Type Description	List Add \$	
C	SFIC "C" Cylinder Type	41	
T	SFIC "T" Cylinder Type	26	
J	SFIC "J" Cylinder Type, Plastic Disposable Temporary Core	NC	
	SFIC "C" Core/Keyway Description	List Add \$	
00	Less Core	NC	
BA	Best A	NC	
BB	Best B	NC	
BC	Best C	NC	
BD	Best D	NC	
BE	Best E	NC	
BF	Best F	NC	
BG	Best G	NC	
BH	Best H	NC	
BJ	Best J	NC	
BK	Best K	NC	
BL	Best L	NC	
BM	Best M	NC	
BQ	Best Q	NC	
D100	DORMA Patented 7 Pin	NC	
	SFIC "T" Core/Keyway Description	List Add \$	
BLK	Black Construction Core	NC	
BLU	Blue Construction Core	NC	
GRN	Green Construction Core	NC	
	SFIC Keying Description	List Add \$	Lead Time
MKD	Combinated (Master Keyed)	16	20 Days
UNC	Uncombinated (core with no pins; keys sold separately)	NC	20 Days
TMP	Temporary Construction Core	13	None

NOTE: Cylinder options other than **D SC** will be shipped loose to be replaced in the field.

[†] Standard finishes: 503 (605), 599 (606), 700 (630), and 701 (629).

Panic Hardware	MANET	Sliding Systems	Pulls & Handles	Locksets	Closers & Hardware	Headers & Accessories	Offset Hung Patch Fittings	Patch Fittings & Designer Pivots	DRS Rails, Channels & Accessories
-----------------------	-------	-----------------	-----------------	----------	--------------------	-----------------------	----------------------------	----------------------------------	-----------------------------------

dormakaba
DORMA USA, Inc.
Tel: 800-523-8483
Fax: 800-274-9724
www.dormakaba.com
dormaglassorders.usa@dorma.com