

## TABLE OF CONTENTS

<b>A</b>		<b>I</b>	
Anchor .....	13	Interlocking Thresholds .....	13
Astragal .....	21, 23-27	Interlocking Weatherstripping.....	15-16
<b>B</b>		Intumescent Weatherstripping.....	16-18
Barrier Free Ramps .....	9	<b>J</b>	
Bumper Thresholds .....	9-10	Jamb Weatherstripping	
Bumper/Stop Strips .....	11	Jamb Weatherstripping.....	22-23, 25-28
<b>C</b>		Adjustable.....	25-26
Carpet Thresholds .....	11	Magnetic.....	25
Cast Abrasive Aluminum Thresholds		<b>L</b>	
Panic Thresholds.....	13	Lead Times .....	5
Saddle Thresholds .....	13-14	<b>M</b>	
Cover Plate .....	15	Materials and Finishes.....	2
<b>D</b>		<b>P</b>	
Door Bottoms		Panic Thresholds .....	11-13
Automatic Door Bottoms.....	18-20	Press-On Weatherstripping.....	16-19
Door Shoes .....	20-22	Product Information.....	2
Door Sweeps .....	20-21, 26	<b>R</b>	
Rain Drip .....	21-23	Rain Drips	
<b>E</b>		DoorBottom Rain Drip.....	21-22
Edge Sealing Systems .....	16-18	Overhead Rain Drip.....	23
Elevator.....	10	Replacement Inserts.....	4
<b>F</b>		Residential Thresholds .....	6-7
Fabrication Options .....	5	<b>S</b>	
Fasteners.....	2	Smoke Seals .....	16-19
Fastener Options .....	3	Saddle Thresholds.....	6-11, 13-14
Finish Options.....	2,5	Spring Bronze.....	24
Fire Labeling.....	2	Stock Numbers .....	29-44
Floor Closer Thresholds .....	14-15	Sure-Step.....	5
Floor Plates and Supports .....	9-10	<b>T</b>	
<b>G</b>		Thermal Barrier Thresholds	
Garage Weatherstripping .....	22	Saddle Thresholds .....	7-8, 10
<b>H</b>		Panic Thresholds.....	11-12
Half Saddle Thresholds.....	6, 8-9, 12	<b>W</b>	
How to Order .....	3	Water Return - Interlocking .....	13



# Thresholds & Weatherstripping

---

## PRODUCT INFORMATION

Drawings or illustrations used in the Price Book are subject to change without notice. Questions regarding any dimensions should be directed to Hager Companies Customer Service.

## MATERIALS AND FINISHES

### Metals

All aluminum extrusions are of alloy 6063-T5. All bronze extrusions are of alloy CDA385 brass specified as Architectural Bronze in the industry. For stock finishes, refer to the code listed below each individual item throughout the price book. Please inquire for the availability on non-stock finishes.

MIL-	Mill Finish Aluminum	LBA -	Light Bronze Anodized Aluminum
300-	Polished Bronze (CDA385)	MIB-	Mill Finish Bronze (CDA385)
CAL-	Cast Aluminum	GYP-	Primed Steel (Grey)
DBA-	Dark Bronze Anodized Aluminum	BLA-	Black Anodized Aluminum
SCA-	Hager Carb-Coat on Aluminum	32D-	Matte Stainless Steel (Non-Extruded)
SCB-	Hager Carb-Coat on Bronze	WH-	White Paint on Aluminum
GLD-	Gold Anodized Aluminum	CLR-	Clear Anodized Aluminum
10B-	Antique Bronze, Oiled	BCA-	Bright Clear Anodized Aluminum

### Gaskets

Gasketing is available in a wide variety of materials. Vinyl is an economical choice and remains flexible down to -40°F. Neoprene gasketing is supplied both as a solid (dense) and as a closed cell sponge with a tough outer skin, remaining flexible down to -50°F. Silicone gasketing provides the best resistance to cold by remaining flexible down to -70°F. To order gasket only, see how to order example on page 3.

B-	Nylon Brush (Black)	V-	Vinyl
N-	Neoprene, Solid EPDM	W-	Pile (Thread May Be Removed To Allow Expansion) (Grey)
	Closed Cell Sponge EPDM, TPE (Black)	F-	Vinyl with Fins (Grey)
S-	Silicone		

### Colors for Press-On Gasketing

- B - Brown
- S - Charcoal or Black
- T - Tan
- W - White
- G - Grey

## FASTENERS

All products are furnished with appropriate fasteners as listed, except where noted. Most thresholds are furnished with mounting holes and #10 x 1-1/2" flat head sheet metal screws. Most weatherstripping products are furnished with slotted holes and #6 x 5/8" pan head sheet metal screws. Brass screws are furnished with bronze products.

## FIRE LABELING

All products containing non-metallic seals have been listed and labeled resulting from a determination by a certified fire laboratory that these products do not adversely affect the fire resistance of the door or frame. All products are regularly checked under a labeling and listing inspection service.



## HOW TO ORDER

When placing your order, please specify item number, gasket code, size and finish code. Also be sure to state any special fabrication needs or optional fasteners desired. Thresholds are fabricated in standard sizes with 1/2" extra on thresholds 50" and under. Thresholds over 50" are supplied with 1" extra length for fitting.

**Example:** 891S V 36 x 84 MIL

Item #	Gasketing	Size	Finish
515S	S-Silicone	36"	GLD
575S	W-Pile	48"	MIB
750S	N-Neoprene	36" x 84"	32D
802S	B-Nylon Brush	48" x 96"	MIL
885S	V-Vinyl	36" x 84"	DBA
881S*	N-Neoprene	48" x 84"	000

\*Use Finish 000 to receive gasket only

Thresholds must be purchased and billed at 4" increments, except for Abrasive Cast Aluminum Thresholds and Automatic Door Bottoms. Weatherstripping must be purchased and billed at 4" increments. Threshold and weatherstripping products supplied in lengths up to 12'.

## FASTENER OPTIONS

### Thresholds

### Add to List Price

#10 Wood Screws and Plastic Anchors.....	\$ 0.60 /ft
#10 Wood Screws and Lead Anchors .....	0.80 /ft
#10 Machine Screws and Lead Anchors.....	0.90 /ft
#10 S.S. Machine Screws and Lead Anchors .....	1.40 /ft
#10 S.S. Wood Screws .....	0.95 /ft
#10 S.S. Wood Screws and Plastic Anchors .....	1.30 /ft
#10 S.S. Wood Screws and Lead Anchors.....	1.55 /ft
#10 Torx Wood Screws .....	1.85 /ft
#10 S.S. Torx Wood Screws .....	2.75 /ft
#10 Torx Machine Screws.....	1.70 /ft
#10 S.S. Torx Machine Screws.....	2.65 /ft
#10 S.S Torx Machine Screws and Lead Anchors .....	2.30 /ft
1/4-20 Machine Screws and Lead Anchors.....	1.20 /ft
1/4-20 S.S. Machine Screws and Lead Anchors.....	1.85 /ft
1/4-20 Flat Head Sleeve Anchor .....	2.25 /ft
1/4 Tap-Con Type (Self-Tapping Concrete).....	1.20 /ft
Cast-On Anchors (Cast Products Only) .....	7.60 /ea
Thru-bolts 1/4 - 20 x 1-1/4" FPHM with 1-1/4" post .....	2.80 /ft

**Note:** Standard fasteners included: #10 x 1-1/2" Phillips flat-head sheet metal screws.

### Weatherstripping

### Add to List Price

#6 x 5/8" Phillips Pan-head Stainless Steel Screws.....	\$ 0.45 /ft
#6 x 5/8" Phillips Self-drilling (TEK) Screws .....	0.30 /ft
#6 x 5/8" S.S. Phillips Self-drilling (TEK) Screws .....	0.35 /ft
#6 x 5/8" Phillips Pan-head Torx Sheet Metal Screws.....	1.45 /ft
Two-way Self-adhesive Tape .....	1.30 /ft

**Note:** Standard fasteners included: #6 x 5/8" Phillips pan-head sheet metal screws.



# Thresholds & Weatherstripping

## REPLACEMENT INSERTS

### Vinyl - Grey

List Price (Per Foot)

400S.....	\$ 1.20
434S, 435S, 477S, 478S, 481S, 515S, 516S, 517S, 518S, 520S, 532S, 541S, 552S, 560S, 565S, 570S, 575S, 580S, 599S, 771S, 837S, 860S.....	0.80
751S, 772S.....	2.30
756S, 770S, 884S.....	1.00
774S, 777S, 778S, 779S, 780S, 782S, 783S.....	1.20
881S, 885S, 890S, 891S, 896S.....	0.80

### Vinyl - Black

*Black inserts are supplied standard with DBA aluminum extrusions. Must specify on order for black replacement gaskets.*

434S, 435S, 477S, 478S, 481S, 515S, 516S, 517S, 518S, 520S, 532S, 541S, 552S, 560S, 565S, 570S, 575S, 580S, 599S, 771S, 837S, 860S.....	0.80
881S, 885S, 890S, 891S, 896S.....	0.70

### Silicone - Grey

434S, 435S, 477S, 478S, 481S, 515S, 516S, 517S, 518S, 520S, 532S, 541S, 552S, 560S, 565S, 570S, 575S, 580S, 599S, 771S, 837S, 860S.....	2.20
730S, 740S.....	4.50
750S.....	1.25
751S, 772S.....	2.00
875S.....	1.40
881S, 885S, 890S, 891S, 896S.....	1.50

### Silicone - Black

*Black inserts are supplied standard with DBA aluminum extrusions. Must specify on order for black replacement gaskets.*

434S, 435S, 477S, 478S, 481S, 515S, 516S, 517S, 518S, 520S, 532S, 541S, 552S, 560S, 565S, 570S, 575S, 580S, 599S, 771S, 837S, 860S.....	2.20
881S, 885S, 890S, 891S, 896S.....	1.50

### Neoprene - Black

434S, 435S, 477S, 478S, 481S, 515S, 516S, 517S, 518S, 520S, 532S, 541S, 552S, 560S, 565S, 570S, 575S, 580S, 599S, 771S, 837S, 860S.....	2.00
730S, 740S, 751S, 772S, 864S, 870S, 872S*, 873S, 877S, 878S, 880S, 892S.....	1.20
743S, 747S, 861S.....	2.40
754S, 774S, 777S, 778S, 779S, 780S, 782S.....	1.20
750S, 753S, 862S, 863S.....	1.35
858S, 865S, 866S.....	3.45
871S, 874S, 875S.....	1.35
881S, 885S, 890S, 891S, 896S.....	0.95

### Neoprene - Grey

872S(MIB and US32D finishes only).....	4.70
--	------

### Pile - Grey

434S, 435S, 477S, 478S, 515S, 516S, 517S, 518S, 520S, 532S, 541S, 552S, 560S, 565S, 570S, 575S, 580S, 599S, 728S, 751S, 771S, 772S, 789S, 806S, 808S, 837S, 845S, 847S, 881S, 885S, 893S..	0.90
---	------

### Nylon Brush - Black

770S, 800S, 802S, 882S, 883S.....	2.70
801S, 803S, 806S, 808S.....	5.30



**FABRICATION OPTIONS**

	<b>Add to List Price</b>
Bevel One Edge of Threshold.....	\$ 5.40 /ft
Rip One Edge (Width) of Threshold.....	5.40 /ft
L-Notch Both Ends of Threshold.....	10.40 /ea
U-Notch Both Ends of Threshold.....	20.65 /ea
Cast Abrasive Notching.....	POA
Miter Return on One Edge, One End of Threshold.....	35.25 /ea
Miter Return on One Edge, Both Ends of Threshold.....	70.50 /ea
Miter Return on Both Edges, One End of Threshold.....	70.50 /ea
Miter Return on Both Edges, Both Ends of Threshold.....	141.00 /ea
Tack Weld One Line of Threshold.....	POA
Pan for Water Return Threshold.....	1.00 /ft
End Caps for Automatic Door Bottoms (Mortised Models).....	DBA 7.10 /2 Caps
	GLD 7.10 /2 Caps
Lead Lining (Automatic Door Bottoms) - Up to 48".....	120.50

**FINISH OPTIONS**

	<b>Add to List Price</b>
Clear Anodized (CLR).....	Price on Application
Black Anodized (BLA).....	Price on Application
Oil Rubbed Bronze (10B).....	Price on Application
Polished Bronze (300).....	Price on Application
White Paint (WHP).....	Price on Application

**SURE-STEP**

	<b>Add to List Price</b>
Up to 4" Width.....	20.90 /ft
Up to 5" Width.....	26.10 /ft
Up to 6" Width.....	31.30 /ft
Up to 7" Width.....	36.60 /ft
Up to 8" Width.....	41.80 /ft

**LEAD TIMES**

Products identified as Quick Ship items will ship in 3 days or less (these items are denoted with stock numbers in **bold and red** in the Stock Numbers section in the back of Thresholds & Weatherstripping). Stock items will typically ship within 5 business days. Non-stock items will typically ship within 2 weeks depending on seasonal volume and order complexity. Made to order industrials must be scheduled. Items that require outside finishing (anodizing, custom paint) or include non-standard components may take longer. Custom orders that require a request for quote are subject to longer lead times. The anticipated ship date will be included with each order acknowledgement.



# Thresholds and Weatherstripping

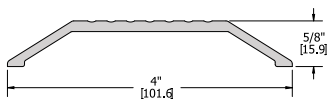
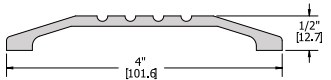
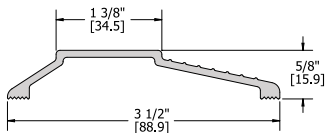
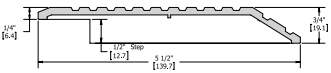
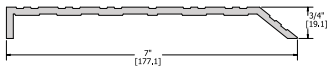
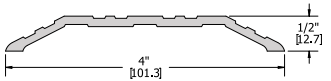
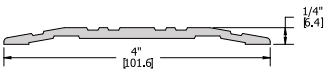
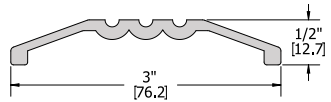
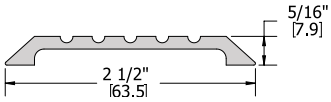
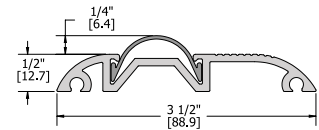

Description	Finish	Without Insert		With Insert		Comparison Numbers
		Insert	N	S	V	
<b>400S</b> Threshold - Saddle w/ Vinyl 3-1/2" x 3/4"	MIL				9.60	NGP: 405 Pemko: 206V
	DBA				12.70	ANSI: J31130
	GLD				14.40	
<b>401S</b> Threshold - Saddle 2-1/2" x 5/16"	MIL	6.55				NGP: 211 Pemko: 166
	DBA	9.05				ANSI: J32130
	GLD	10.15				
	MIB	124.90				
<b>402S</b> Threshold - Saddle 3" x 1/2"	MIL	6.95				NGP: 211 Pemko: 169
	DBA	9.55				ANSI: J32100
	GLD	10.75				
<b>403S</b> Threshold - Saddle 4" x 1/4"	MIL	6.90				NGP: 413 Pemko: 270
	DBA	11.70				ANSI: J32130
	GLD	13.00				
	MIB	110.00				
	32D	120.00				
<b>404S</b> Threshold - Saddle 4" x 1/2"	MIL	7.90				NGP: 424E NGP: 412SS
	DBA	11.45				Pemko: 170
	GLD	12.55				ANSI: J32130
	MIB	103.00				
	32D	130.00				
<b>406S</b> Threshold - Half Saddle 7" x 3/4"	MIL	22.40				NGP: 458 Pemko: 1877
	DBA	23.70				ANSI: J33100
	GLD	26.40				
<b>407S</b> Threshold - Half Saddle 1/2" Step 5-1/2" x 3/4"	MIL	12.75				NGP: 655 Pemko: 157
	DBA	19.75				ANSI: J33180
	GLD	22.30				
<b>408S</b> Threshold - Saddle 3-1/2" x 5/8"	MIL	6.15				Pemko: 212
	DBA	8.70				ANSI: J30100
	GLD	9.85				
<b>410S</b> Threshold - Saddle 4" x 1/2"	MIL	7.85				NGP: 424 Pemko: 170
	DBA	11.40				ANSI: J32130
	GLD	12.55				
	MIB	124.55				
<b>411S</b> Threshold - Saddle 4" x 5/8"	MIL	10.90				NGP: 524 Pemko: 198
	DBA	16.70				ANSI: J32100
	GLD	19.30				
	MIB	125.00				

# Thresholds and Weatherstripping

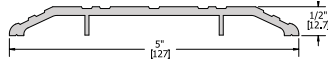

Description	Finish	Without Insert			With Insert			Comparison Numbers
		Insert	N	S	V	W		
<b>412S</b> Threshold - Saddle 5" x 1/2"	MIL		10.60				NGP: 425E NGP: 512SS Pemko: 171 ANSI: J32130	
	DBA		15.45					
	GLD		16.90					
	MIB		135.00					
	32D		150.00					

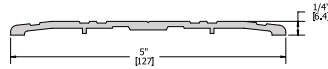

<b>413S</b> Threshold - Saddle 5" x 1/4"	MIL		9.85				NGP: 513 Pemko: 271 ANSI: J32130
	DBA		14.85				
	GLD		15.75				
	MIB		115.00				
	32D		130.00				

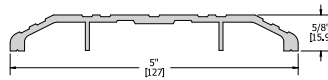

<b>414S</b> Threshold - Saddle 5" x 5/8"	MIL		14.50				NGP: 525 Pemko: 156 ANSI: J32100
	DBA		16.70				
	GLD		18.75				

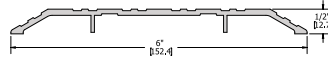

<b>415S</b> Threshold - Saddle 6" x 1/2"	MIL		12.60				NGP: 426 Pemko: 172 ANSI: J32130
	DBA		17.45				
	GLD		19.65				
	MIB		175.00				

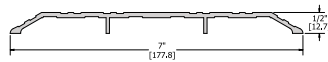

<b>416S</b> Threshold - Saddle 7" x 1/2"	MIL		16.55				NGP: 427 Pemko: 176 ANSI: J32130
	DBA		21.65				
	GLD		23.85				
	MIB		200.00				

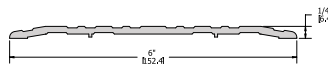

<b>417S</b> Threshold - Saddle 6" x 1/4"	MIL		12.35				NGP: 613 Pemko: 272 ANSI: J32130
	DBA		16.70				
	GLD		19.65				
	MIB		150.00				

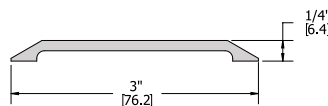

<b>418S</b> Threshold - Saddle 3" x 1/4"	MIL		7.05				NGP: 411 Pemko: 151 ANSI: J32330
	DBA		9.55				
	GLD		11.00				
	MIB		90.00				

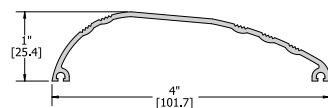

<b>419S</b> Threshold - Saddle 4" x 1"	MIL		6.90				Pemko: 219 ANSI: J30100
	DBA		8.60				
	GLD		9.65				

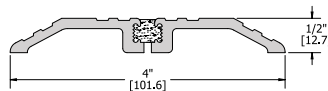

<b>420S</b> Threshold - Saddle Thermal Barrier 4" x 1/2"	MIL		14.25				NGP: 8424 Pemko: 252X2FG ANSI: J32193
	DBA		18.50				
	GLD		20.50				



<b>421S</b> Threshold - Saddle Thermal Barrier 5" x 1/2"	MIL		16.00				NGP: 8425 Pemko: 252X3FG ANSI: J32193
	DBA		20.80				
	GLD		23.30				

Price Code: POA - Price on Application  
 Insert Codes: V - Vinyl; N - Neoprene, EDPM, or TPE; S - Silicone; W - Pile; B - Nylon Brush; F - Vinyl Fin  
 Finish Codes: MIL - Mill Finished Aluminum; DBA - Dark Bronze Anodized; GLD - Gold Anodized; MIB - Mill Finished Bronze; 32D - Matte Stainless Steel; GYP - Primed for Painting; CLR - Clear Anodized; CAL - Cast Aluminum



# Thresholds and Weatherstripping

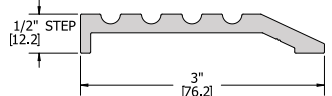
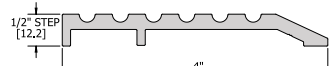
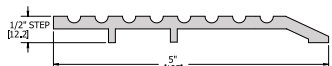
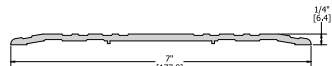
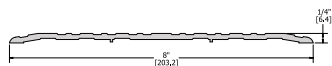
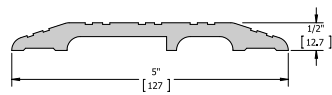
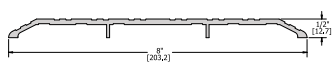
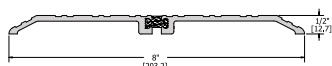
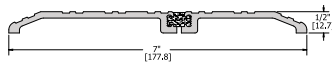
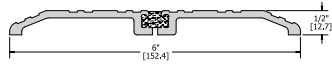

Description	Finish	Without Insert		With Insert		Comparison Numbers
		N	S	V	W	
<b>422S</b> Threshold - Saddle Thermal Barrier 6" x 1/2"	MIL	18.00				NGP: 8426 Pemko: 253X3FG ANSI: J32193
	DBA	23.40				
	GLD	25.90				
<b>423S</b> Threshold - Saddle Thermal Barrier 7" x 1/2"	MIL	19.60				NGP: 8427 Pemko: 253X4FG ANSI: J32193
	DBA	25.75				
	GLD	28.45				
<b>424S</b> Threshold - Saddle Thermal Barrier 8" x 1/2"	MIL	21.40				NGP: 8428 Pemko: 254X4FG ANSI: J32193
	DBA	28.40				
	GLD	31.40				
<b>426S</b> Threshold - Saddle 8" x 1/2"	MIL	20.50				NGP: 428E Pemko: 2548 ANSI: J32130
	DBA	27.35				
	GLD	30.80				
	MIB	260.00				
<b>427S</b> Threshold - Saddle Heavy Duty 5" x 1/2"	MIL	26.65				NGP: 425HD Pemko: 1715 ANSI: J32130
	DBA	36.05				
<b>428S</b> Threshold - Saddle 8" x 1/4"	MIL	19.60				NGP: 813 Pemko: 2748 ANSI: J32130
	DBA	25.90				
	GLD	29.20				
	MIB	245.00				
<b>430S</b> Threshold - Saddle 7" x 1/4"	MIL	16.75				NGP: 713 Pemko: 276 ANSI: J32130
	DBA	21.55				
	GLD	25.40				
<b>431S</b> Threshold - Half Saddle 5" x 1/2"	MIL	19.75				NGP: 325 Pemko: 229 ANSI: J33130
	DBA	26.45				
	GLD	29.80				
	MIB	195.00				
<b>432S</b> Threshold - Half Saddle 4" x 1/2"	MIL	17.35				NGP: 324 Pemko: 227 ANSI: J33130
	DBA	24.25				
	GLD	26.00				
	MIB	185.00				
<b>433S</b> Threshold - Half Saddle 3" x 1/2"	MIL	7.90				NGP: 322 Pemko: 168 ANSI: J33130
	DBA	10.25				
	GLD	11.85				
	MIB	150.00				



# Thresholds and Weatherstripping

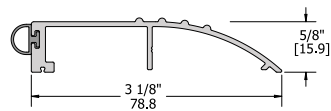

Description	Finish	Without Insert		With Insert		Comparison Numbers
		Insert	N	S	V	
<b>434S</b> Threshold - Bumper Vinyl insert supplied unless other material specified 3-1/8" x 5/8"	MIL		7.95	7.95	6.00	NGP: 21
	DBA		10.10	10.10	7.50	Pemko: 205
	GLD		11.50	11.50	8.75	ANSI: J30100

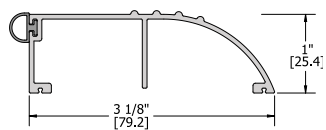

<b>435S</b> Threshold - Bumper Vinyl insert supplied unless other material specified 3-1/8" x 1"	MIL		9.45	9.45	7.10	NGP: 25
	DBA		12.00	12.00	8.90	Pemko: 2051
	GLD		13.70	13.70	10.40	ANSI: J30100

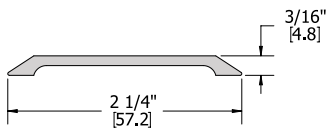

<b>436S</b> Threshold - Saddle 2-1/4" x 3/16"	MIL	5.00				NGP: 410
	DBA	7.15				Pemko: 158
	GLD	8.20				ANSI: J32330

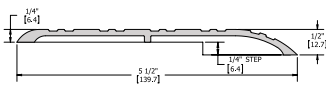

<b>438S</b> Threshold - Half Saddle 1/4" Step 5-1/2" x 1/2"	MIL	12.50				NGP: 653
	DBA	19.20				Pemko: 173 ANSI: J32330

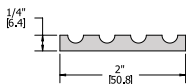

<b>440S</b> Threshold - Floor Plate 2" x 1/4"	MIL	7.60				NGP: 8142
	DBA	9.50				Pemko: 190
	GLD	10.60				ANSI: J37100
	MIB	70.00				

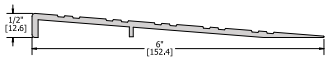

<b>442S</b> Threshold Barrier Free Ramp 1/2" Rise 6" x 1/2"	MIL	11.85				NGP: 657
	DBA	16.00				Pemko: 259
	GLD	17.95				ANSI: J38130

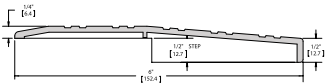

<b>443S</b> Threshold Barrier Free Ramp 1/4" Rise 6" x 3/4"	MIL	13.95				NGP: 658
	DBA	18.55				Pemko: 257
	GLD	20.90				ANSI: J30180

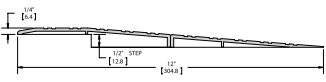

<b>444S</b> Threshold Barrier Free Ramp 3/4" Rise 12" x 3/4"	MIL	24.60				NGP: R72
	DBA	30.15				Pemko: 257X259
	GLD	36.90				ANSI: J38183

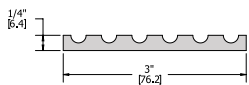

<b>445S</b> Threshold - Floor Plate 3" x 1/4"	MIL	10.30				NGP: 8143
	DBA	13.70				Pemko: 191
	GLD	15.45				ANSI: J37100
	MIB	110.00				

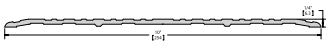

<b>448S</b> Threshold - Saddle 10" x 1/4"	MIL	25.65				NGP: 8143
	DBA	33.80				ANSI: J37100

Price Code: POA - Price on Application  
 Insert Codes: V - Vinyl; N - Neoprene, EDPM, or TPE; S - Silicone; W - Pile; B - Nylon Brush; F - Vinyl Fin  
 Finish Codes: MIL - Mill Finished Aluminum; DBA - Dark Bronze Anodized; GLD - Gold Anodized; MIB - Mill Finished Bronze; 32D - Matte Stainless Steel; GYP - Primed for Painting; CLR - Clear Anodized; CAL - Cast Aluminum



# Thresholds and Weatherstripping

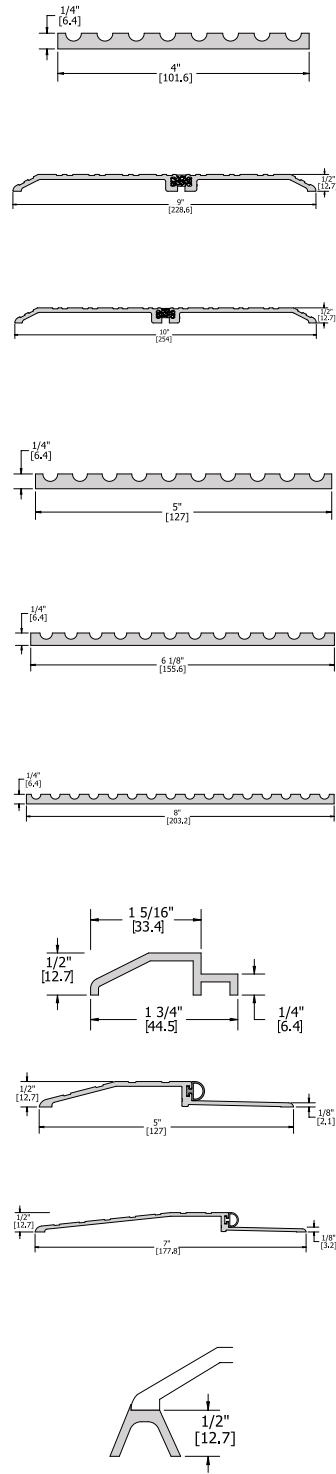

Description	Finish	Without Insert		With Insert			Comparison Numbers
		Insert	N	S	V	W	
<b>450S</b> Threshold - Floor Plate 4" x 1/4"	MIL	13.95					NGP: 8144 Pemko: 192 ANSI: J37100
	DBA	18.60					
	GLD	19.60					
	MIB	140.00					
<b>451S</b> Threshold - Saddle Thermal Barrier 9" x 1/2"	MIL	25.75					NGP: 8429 Pemko: 254X5FG ANSI: J32193
	DBA	32.30					
	GLD	35.70					
<b>452S</b> Threshold - Saddle Thermal Barrier 10" x 1/2"	MIL	28.75					NGP: 8430 Pemko: 255X5FG ANSI: J32193
	DBA	36.75					
	GLD	40.60					
<b>455S</b> Threshold - Floor Plate 5" x 1/4"	MIL	16.95					NGP: 8145 ANSI: J37100
	DBA	22.65					
	GLD	26.20					
	MIB	185.00					
<b>460S</b> Threshold - Floor Plate 6-1/8" x 1/4"	MIL	19.85					NGP: 8146 Pemko: 193 ANSI: J37100
	DBA	26.40					
	GLD	29.75					
	MIB	220.00					
<b>465S</b> Threshold - Floor Plate 8" x 1/4"	MIL	25.80					NGP: 8148 Pemko: 228 ANSI: J37100
	DBA	35.25					
	GLD	39.60					
<b>470S</b> Threshold Plate Support 1-3/4" x 1/2"	MIL	4.85					NGP: 8140 Pemko: 195
	DBA	6.95					
	GLD	7.75					
	MIB	50.00					
<b>477S</b> Threshold - Bumper 5" x 1/2"	MIL		12.15	12.75	11.50	11.50	NGP: 950 Pemko: 2001 ANSI: J36100
	DBA		15.90	17.00	15.25	15.25	
	GLD		17.25	17.85	16.55	16.55	
<b>478S</b> Threshold - Bumper 7" x 1/2"	MIL		17.65	18.40	16.80	16.80	ANSI: J30100
	DBA		23.25	23.85	22.25	22.25	
	GLD		24.40	25.45	23.45	23.45	
<b>480S</b> Threshold Elevator 1/2"	MIL	3.80					NGP: 58 Pemko: 188
	DBA	4.90					

1. U/M is feet unless otherwise noted.

# Thresholds and Weatherstripping

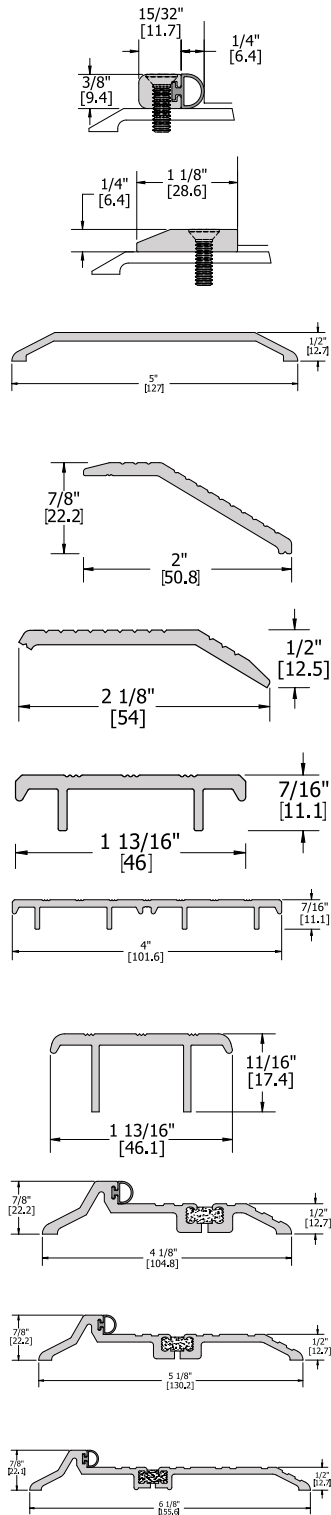

Description	Finish	Without Insert		With Insert		Comparison Numbers	
		Insert	N	S	V		W
<b>481S</b> Threshold Bumper Strip 23/32" x 3/8"	MIL		5.90	6.15	5.25	5.25	NGP: 2 Pemko: 184
	DBA		7.65	8.00	6.90	6.90	
	GLD		8.85	8.50	8.30	8.30	
<b>484S</b> Threshold Bumper Strip 1-1/8" x 1/4"	MIL	5.00					NGP: 8136 Pemko: 196
	DBA	7.25					
	GLD	8.00					
	MIB	55.00					
<b>492S</b> Threshold - Saddle 5" x 1/2"	MIL	12.50					Pemko: 154 ANSI: J32330
	DBA	15.65					
	GLD	18.10					
<b>503S</b> Threshold - Carpet Edge 2" x 7/8"	MIL	6.00					NGP: 416 ANSI: J32180
	DBA	9.60					
	GLD	10.90					
<b>504S</b> Threshold - Carpet Edge 2-1/8" x 1/2"	MIL	7.90					NGP: 417 Pemko: 174 ANSI: J32183
	DBA	10.30					
	GLD	11.70					
<b>505S</b> Threshold - Carpet Divider 1-13/16" x 7/16"	MIL	5.50					NGP: 414 Pemko: 236 ANSI: J32113
	DBA	7.40					
	GLD	8.35					
<b>506S</b> Threshold - Carpet Divider 4" x 7/16"	MIL	9.70					NGP: 404 Pemko: 2364 ANSI: J32113
	DBA	13.20					
	GLD	14.85					
<b>508S</b> Threshold - Carpet Divider 1-13/16" x 11/16"	MIL	5.85					NGP: 414-75 Pemko: 246 ANSI: J32140
	DBA	7.60					
	GLD	8.20					
<b>515S</b> Threshold - Panic Thermal Barrier 4-1/8" x 7/8"	MIL		17.30	17.30	15.75	15.75	NGP: 8432 Pemko: 252X226FG ANSI: J36190
	DBA		22.50	22.50	20.50	20.50	
	GLD		24.20	24.20	22.05	22.05	
<b>516S</b> Threshold - Panic Thermal Barrier 5-1/8" x 7/8"	MIL		18.65	18.65	17.75	17.75	NGP: 8435 Pemko: 253X226FG ANSI: J36190
	DBA		24.75	24.75	23.10	23.10	
	GLD		26.00	26.00	24.85	24.85	
<b>517S</b> Threshold - Panic Thermal Barrier 6-1/8" x 7/8"	MIL		20.75	20.75	19.75	19.75	NGP: 8436 Pemko: 254X226FG ANSI: J36190
	DBA		27.55	27.55	26.25	26.25	
	GLD		29.00	29.00	27.65	27.65	

Price Code: POA - Price on Application  
 Insert Codes: V - Vinyl; N - Neoprene, EDPM, or TPE; S - Silicone; W - Pile; B - Nylon Brush; F - Vinyl Fin  
 Finish Codes: MIL - Mill Finished Aluminum; DBA - Dark Bronze Anodized; GLD - Gold Anodized; MIB - Mill Finished Bronze; 32D - Matte Stainless Steel; GYP - Primed for Painting; CLR - Clear Anodized; CAL - Cast Aluminum



# Thresholds and Weatherstripping

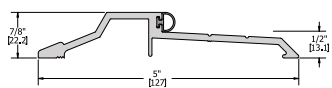
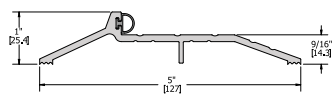
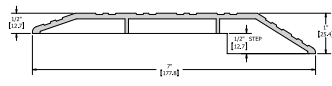
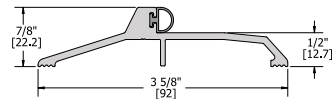
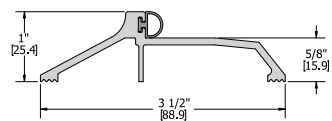
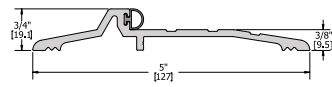
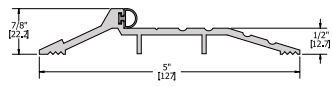
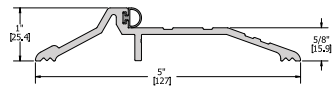
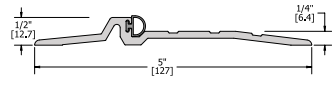
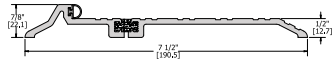

Description	Finish	Without Insert		With Insert		Comparison Numbers
		Insert	N	S	V	
<b>518S</b> Threshold - Panic Thermal Barrier 7-1/2" x 7/8"	MIL		23.55	23.55	22.30	NGP: 8437
	DBA		31.35	31.35	29.65	Pemko: 255X226FG
	GLD		34.55	34.55	33.80	ANSI: J36190
<b>520S</b> Threshold - Panic 5" x 1/2"	MIL		11.75	11.75	10.90	NGP: 896
	DBA		15.25	15.25	14.10	Pemko: 2005
	GLD		16.90	16.90	15.60	ANSI: J36130
	MIB		125.00	125.00	125.00	
<b>532S</b> Threshold - Panic 5" x 1"	MIL		14.45	14.45	13.40	NGP: 803
	DBA		19.20	19.20	17.85	Pemko: 181
	GLD		20.95	20.95	19.45	ANSI: J36100
	MIB		170.00	170.00	170.00	
<b>541S</b> Threshold - Panic 5" x 7/8"	MIL		14.00	14.00	13.00	NGP: 884
	DBA		18.90	18.90	18.55	Pemko: 177
	GLD		21.00	21.00	21.00	ANSI: J36100
	MIB		155.00	155.00	155.00	
<b>552S</b> Threshold - Panic 5" x 3/4"	MIL		13.95	13.95	13.30	NGP: 890
	DBA		18.55	18.55	17.80	Pemko: 179
	GLD		20.95	20.95	19.95	ANSI: J36100
	MIB		155.00	155.00	140.00	
<b>560S</b> Threshold - Panic 3-1/2" x 1"	MIL		12.15	12.15	11.40	NGP: 891
	DBA		17.00	17.00	15.90	Pemko: 185
	GLD		18.70	18.70	17.55	ANSI: J36300
<b>565S</b> Threshold - Panic 3-5/8" x 7/8"	MIL		12.50	12.50	11.55	NGP: 892
	DBA		16.90	16.90	16.30	Pemko: 1855
	GLD		18.55	18.55	16.90	ANSI: J36300
<b>572S</b> Threshold - Half Saddle 1/2" Offset 7" x 1"	MIL	17.15				Pemko: 182
	DBA	23.50				ANSI: J33180
	GLD	26.30				
<b>575S</b> Threshold - Panic 5" x 1"	MIL		14.30	14.30	13.45	Pemko: 181
	DBA		19.30	19.30	18.15	ANSI: J36100
	GLD		20.75	20.75	19.50	
	MIB		185.00	185.00	185.00	
<b>580S</b> Threshold - Panic 5" x 7/8"	MIL		16.50	16.50	15.75	NGP: 804
	DBA		21.45	21.45	20.45	Pemko: 277
	GLD		23.10	23.10	22.10	ANSI: J36100

# Thresholds and Weatherstripping

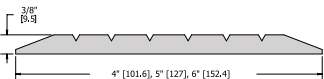
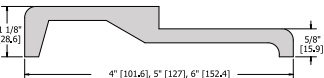
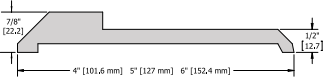
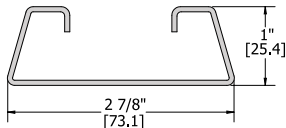
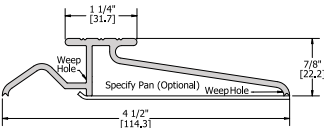
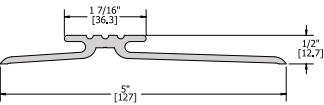
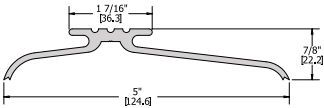
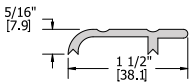
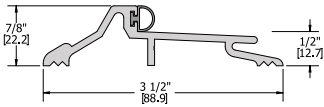

Description	Finish	Without Insert		With Insert			Comparison Numbers
		Insert	N	S	V	W	
<b>599S</b> Threshold - Panic 3-1/2" x 7/8"	MIL		13.65	13.65	13.00	13.00	NGP: 895 Pemko: 159 ANSI: J36300
	DBA		18.15	18.15	19.30	19.30	
	GLD		19.80	19.80	18.85	18.85	
<b>600S</b> Threshold - Interlock Cap 1-1/2" x 5/16"	MIL	5.55					NGP: 432 Pemko: 101 ANSI: J34170
	DBA	6.10					
	GLD	8.05					
<b>603S</b> Threshold - Interlock 5" x 7/8" * 701S Interlocking Hook provided	MIL	13.40					Pemko: 120 ANSI: J34170
	DBA	19.45					
	MIB	135.00					
<b>604S</b> Threshold - Interlock 5" x 1/2" * 701S Interlocking Hook provided	MIL	13.65					NGP: 442-5 Pemko: 114 ANSI: J34170
	DBA	17.05					
	MIB	130.00					
<b>608S</b> Threshold - Interlock Water Return *Pan Extra - See options, must specify on order 4-1/2" x 7/8"	MIL	14.70					Pemko: 145 ANSI: J34170
	DBA	16.80					
	MIB	105.00					
<b>619S</b> Adjustable Threshold Anchor 2-7/8" x 1"	MIL	9.90					NGP: 721
<b>621S</b> Threshold - Panic Cast Abrasive Aluminum 8' Max Length							ANSI: J35400
4" x 7/8"	CAL	119.70					
5" x 7/8"	CAL	143.65					
6" x 7/8"	CAL	167.60					
<b>622S</b> Threshold - Panic Cast Abrasive Aluminum 8' Max Length							ANSI: J35400
4" x 1-1/8"	CAL	119.70					
5" x 1-1/8"	CAL	143.65					
6" x 1-1/8"	CAL	167.60					
<b>626S</b> Threshold - Saddle Cast Abrasive Aluminum 8' Max Length							ANSI: J37230
4" x 3/8"	CAL	94.50					
5" x 3/8"	CAL	113.40					
6" x 3/8"	CAL	132.30					

Price Code: POA - Price on Application  
 Insert Codes: V - Vinyl; N - Neoprene, EDPM, or TPE; S - Silicone; W - Pile; B - Nylon Brush; F - Vinyl Fin  
 Finish Codes: MIL - Mill Finished Aluminum; DBA - Dark Bronze Anodized; GLD - Gold Anodized; MIB - Mill Finished Bronze; 32D - Matte Stainless Steel; GYP - Primed for Painting; CLR - Clear Anodized; CAL - Cast Aluminum



# Thresholds and Weatherstripping

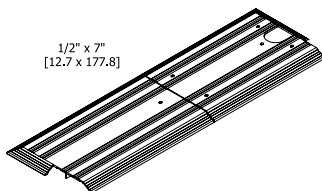
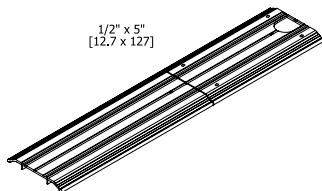
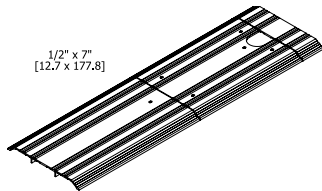
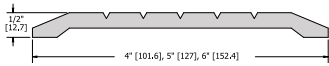

Description	Finish	Without Insert	N	With Insert S	V	W	Comparison Numbers
<b>627S</b> Threshold - Saddle Cast Abrasive Aluminum 8' Max Length							ANSI: J32230
4" x 1/2"	CAL	94.50					
5" x 1/2"	CAL	113.65					
6" x 1/2"	CAL	132.30					
<b>651S</b> Threshold - Saddle for floor closers center hung without mitered end 7" x 1/2"							NGP: Type 1 Pemko: Type 11 ANSI: J39130
Up to 36"	MIL	136.55					
	DBA	152.40					
	MIB	POA					
Up to 72"	MIL	272.20					
	DBA	304.60					
	MIB	POA					
Lengths over 72" add the following per inch	MIL	1.65					
	DBA	2.00					
	MIB	POA					
<b>652S</b> Threshold - Saddle for floor closers center hung without mitered end 5" x 1/2"							NGP: Type 1 Pemko: Type 11 ANSI: J39130
Up to 36"	MIL	109.40					
	DBA	122.10					
	MIB	POA					
Up to 72"	MIL	222.80					
	DBA	248.65					
	MIB	POA					
Lengths over 72" add the following per inch	MIL	1.65					
	DBA	2.00					
	MIB	POA					
<b>653S</b> Threshold - Saddle For Floor Closers Offset hung with Mitered Ends 7" x 1/2"							NGP: Type 3 Pemko: Type 13 ANSI: J39153
Up to 36"	MIL	190.25					
	DBA	212.35					
	MIB	POA					
Up to 72"	MIL	370.50					
	DBA	395.60					
	MIB	POA					
Lengths over 72" add the following per inch	MIL	1.65					
	DBA	2.00					
	MIB	POA					

# Thresholds and Weatherstripping

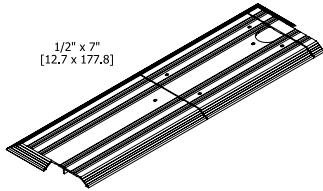

Description	Finish	Without Insert		With Insert			Comparison Numbers
		Insert	N	S	V	W	
<b>654S</b> Threshold - Saddle For Floor Closers Offset hung with Mitered Ends 7" x 1/2" Up to 36"	MIL	190.25					NGP: Type 4 Pemko: Type 14 ANSI: J39153
	DBA	212.35					
	MIB	POA					
Up to 72"	MIL	380.50					
	DBA	424.65					
	MIB	POA					
Lengths over 72" add the following per inch	MIL	1.65					
	DBA	2.00					
	MIB	POA					

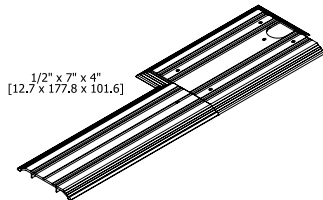

<b>655S</b> Threshold - Saddle For Floor Closers Offset hung with Mitered Ends 7" x 1/2" Up to 36"	MIL	229.95					NGP: Type 5 Pemko: Type 15 ANSI: J39153
	DBA	256.60					
	MIB	POA					
Up to 72"	MIL	459.90					
	DBA	513.25					
	MIB	POA					
Lengths over 72" add the following per inch	MIL	0.75					
	DBA	1.10					
	MIB	POA					

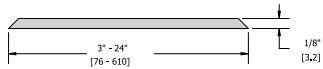

<b>676S</b> Cover Plate 8' Max. Length 1/8" Height Charges: length X per foot charge X width in inches (3" min.) Example: 6 (ft. length) x \$6.15 (ft. list) x 6 (in. width)	MIL	7.00					NGP: 818 Pemko: 18/1A ANSI: J17300
--	-----	------	--	--	--	--	--

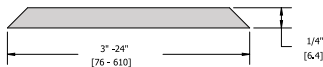

<b>677S</b> Cover Plate 8' Max. Length 1/4" Height Charges: length X per foot charge X width in inches (3" min.) Example: 6 (ft. length) x \$9.40 (ft. list) x 6 (in. width)	MIL	11.20					NGP: 814 Pemko: 14/1A ANSI: J17300
--	-----	-------	--	--	--	--	--

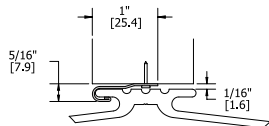

<b>701S</b> Weatherstrip Interlock "J" Hook	MIL	3.40					NGP: 80 Pemko: 61 ANSI: ROY016
	MIB	5.65					

Price Code: POA - Price on Application  
 Insert Codes: V - Vinyl; N - Neoprene, EDPM, or TPE; S - Silicone; W - Pile; B - Nylon Brush; F - Vinyl Fin  
 Finish Codes: MIL - Mill Finished Aluminum; DBA - Dark Bronze Anodized; GLD - Gold Anodized; MIB - Mill Finished Bronze; 32D - Matte Stainless Steel; GYP - Primed for Painting; CLR - Clear Anodized; CAL - Cast Aluminum



# Thresholds and Weatherstripping

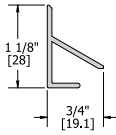

Description	Finish	Without Insert		With Insert			Comparison Numbers
		Insert	N	S	V	W	
<b>7175</b> Weatherstrip Interlock Overhead Rain Drip	MIL DBA	3.90 6.25					NGP: 124 Pemko: 347 ANSI: R3Y106

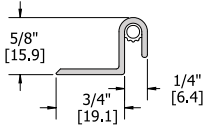

<b>7185</b> Weatherstrip Interlock Overhead w/ Vinyl	MIL DBA				3.80 5.80		NGP: 123 Pemko: 68 ANSI: R3D036
---	------------	--	--	--	--------------	--	---------------------------------------

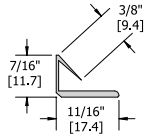

<b>719</b> Press-on Weatherstrip Edge Sealing System & Smoke Seal Intumescent material							NGP: 9450 ANSI: ROW154
7'	Brown	32.00					
8'	Gray	36.50					
9'	Charcoal	41.25					
3' x 7'	Tan	77.75					
4' x 7'	White	82.25					
4' x 8'		91.50					
6' x 7'		91.50					
7' x 7'		96.00					

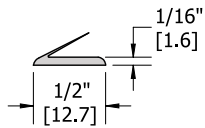

<b>720</b> Press-on Weatherstrip Edge Sealing System & Smoke Seal Intumescent material							NGP: 9850 Pemko: HSS2000XS44 ANSI: ROW154
3' x 7'	Brown	64.55					
4' x 7'	Gray	68.30					
4' x 8'	Charcoal	74.85					
6' x 7'	Tan	74.85					
7' x 7'	White	78.05					
6' x 8'		81.55					
8' x 8'		88.10					

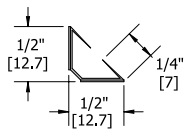

<b>721</b> Press-on Weatherstrip Smoke Seal TPE							NGP: 5020 ANSI: ROW154
7'	Brown	14.10					
8'	Gray	16.10					
9'	Charcoal	18.15					
3' x 7'	Tan	34.25					
4' x 7'	White	36.25					
4' x 8'		40.30					
6' x 7'		40.30					
7' x 7'		42.30					



# Thresholds and Weatherstripping

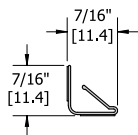
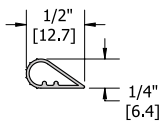
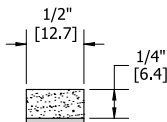
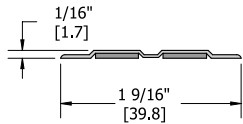
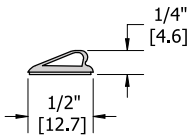

Description	Finish	Without Insert			With Insert			Comparison Numbers
		Insert	N	S	V	W		
<b>722</b> Press-on Weatherstrip Edge Sealing System & Smoke Seal Intumescent material								Pemko: HSS2000xs88 ANSI: ROW154
3' x 7'	Charcoal							
4' x 7'	Brown							
4' x 8'	Tan							
6' x 7'	White							
7' x 7'								
6' x 8'								
8' x 8'								
<b>724</b> Press-on Weatherstrip Edge Sealing System Intumescent material								NGP: 9500 ANSI: ROW156
7'	Brown							
8'	Gray							
9'	Charcoal							
3' x 7'	Tan							
4' x 8'	White							
<b>725</b> Press-on Weatherstrip Sponge Neoprene	Charcoal		0.95					Pemko: P493 ANSI: ROC156
<b>726</b> Press-on Weatherstrip Smoke Seal								NGP: 5050 Pemko: S88 ANSI: ROE154
17'	Brown				24.05			
18'	Charcoal				26.20			
19'	Tan				27.25			
20'	White				28.30			
21'					30.60			
22'					32.05			
25'					36.40			
260'					359.70			
520'					719.40			
<b>727</b> Press-on Weatherstrip TPE material								NGP: PF180 ANSI: ROY156
7'	Charcoal				10.95			
8'					12.50			
3' x 7'					26.60			
4' x 8'					31.30			

Price Code: POA - Price on Application  
 Insert Codes: V - Vinyl; N - Neoprene, EDPM, or TPE; S - Silicone; W - Pile; B - Nylon Brush; F - Vinyl Fin  
 Finish Codes: MIL - Mill Finished Aluminum; DBA - Dark Bronze Anodized; GLD - Gold Anodized; MIB - Mill Finished Bronze;  
 32D - Matte Stainless Steel; GYP - Primed for Painting; CLR - Clear Anodized; CAL - Cast Aluminum



# Thresholds and Weatherstripping

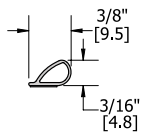
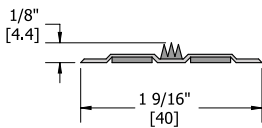
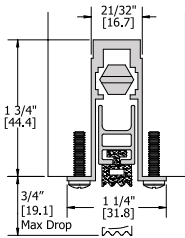
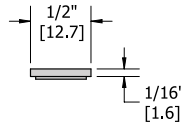
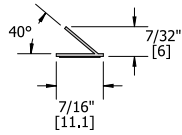

Description	Finish	Without Insert		With Insert		Comparison Numbers
		Insert	N	S	V	
<b>728</b> Press-on Weatherstrip TPE						NGP: 5030 Pemko: S44 ANSI: R00154
17'	Charcoal			23.55		
20'	White			27.60		
21'				28.85		
25'				34.40		
260'				325.45		
520'				650.30		
<b>729</b> Press-on Weatherstrip Edge Sealing System Intumescent material						NGP: 9800 Pemko: HSS2000 ANSI: ROW156
17'	Brown	32.15				
19'	Charcoal	35.85				
21'	Tan	39.70				
25'	White	47.20				
150'		277.60				
<b>730S</b> Automatic Door Bottom Mortise Application End Caps Furnished (max. drop 3/4")						NGP: 225 Pemko: 411 ANSI: R3Y326
24" to 36"	MIL		52.95	62.85		
37" to 48"	MIL		65.35	78.85		
<b>734</b> Press-on Weatherstrip Edge Sealing System & Smoke Seal Intumescent material						NGP: 9550 ANSI: ROW154
7'	Brown	39.00				
8'	Charcoal	44.55				
9'	Tan	50.10				
3' x 7'	White	94.65				
6' x 7'		111.30				
8' x 8'		133.65				
<b>736</b> Press-on Weatherstrip Smoke Seal						NGP: 2525 Pemko: PK33 ANSI: ROE154
17'	Charcoal			24.15		
18'	White			26.10		
19'	Tan			27.30		
20'				28.50		
21'				30.45		
22'				31.90		
25'				36.20		
260'				357.65		
520'				715.30		

# Thresholds and Weatherstripping

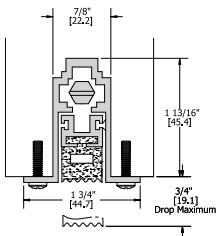
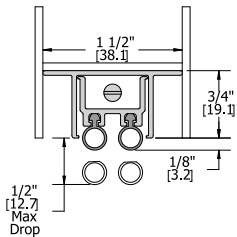
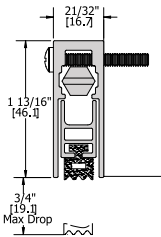
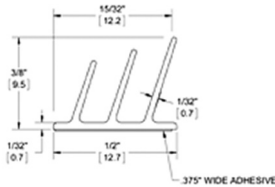
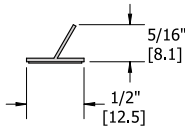

Description	Finish	Without Insert		With Insert		Comparison Numbers
		N	S	V	W	
<b>737</b> Press-on Weatherstrip Smoke Seal						NGP: 5060 Pemko: S77 ANSI: ROE154
17'	Charcoal		27.00			
18'	White		28.60			
19'			30.15			
20'			31.75			
21'			33.20			
22'			34.80			
25'			39.45			
260'			336.20			
520'			621.50			
<b>738</b> Press-on Weatherstrip Smoke Seal						NGP: 5075 Pemko: S773 ANSI: ROE154
17'	Charcoal		31.50			
18'			34.20			
20'			37.30			
21'			39.90			
22'			41.80			
<b>740S</b> Automatic Door Bottom - Surface Applied End Caps Furnished (max. drop 3/4")						NGP: 222 Pemko: 4131 ANSI: R3Y336
24" to 36"	CLR	60.70	71.70			
	DBA	69.20	80.85			
	GLD	77.70	89.70			
37" to 48"	CLR	75.60	87.30			
	DBA	87.30	97.95			
	GLD	97.95	113.10			
<b>742S</b> Automatic Door Bottom - Hollow Metal Door Application (max. drop 1/2")						NGP: 320 Pemko: 420 ANSI: R3D326
24" to 36"	MIL	47.50	47.50			
37" to 48"	MIL	62.00	62.00			
<b>743S</b> Automatic Door Bottom Mortise Application End Caps Furnished (max drop 3/4")						NGP: 422 Pemko: 434 ANSI: R3C326
24" to 36"	MIL	87.40				
37" to 48"	MIL	108.00				

Price Code: POA - Price on Application  
 Insert Codes: V - Vinyl; N - Neoprene, EDPM, or TPE; S - Silicone; W - Pile; B - Nylon Brush; F - Vinyl Fin  
 Finish Codes: MIL - Mill Finished Aluminum; DBA - Dark Bronze Anodized; GLD - Gold Anodized; MIB - Mill Finished Bronze; 32D - Matte Stainless Steel; GYP - Primed for Painting; CLR - Clear Anodized; CAL - Cast Aluminum



# Thresholds and Weatherstripping

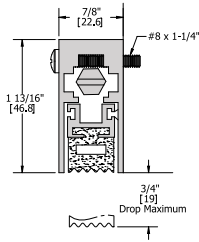

Description	Finish	Without Insert		With Insert		Comparison Numbers	
		Insert	N	S	V		W
<b>747S</b> Automatic Heavy Duty Door Bottom - Surface Applied End Caps Furnished in Listed Furnishes (max. drop 3/4") 24" to 36"	CLR		95.10			NGP: 420 Pemko: 4301 ANSI: R3C336	
	DBA		105.50				
	GLD		117.35				
37" to 48"	CLR		118.60				
	DBA		131.55				
	GLD		146.35				
<b>750S</b> Door Bottom - Sweep	CLR		4.45	6.65		NGP: 200 Pemko: 315 ANSI: ROY436	
	DBA		5.85	8.15			
	GLD		6.45	8.75			
	MIB		25.00	28.00			
	32D		27.00	30.00			
<b>751S</b> Door Bottom - Shoe	MIL		7.00	8.35	7.20	7.55	Pemko: 317 ANSI: ROY436
	DBA		8.50	10.15	8.95	9.25	
	GLD		9.55	10.55	9.35	9.45	
<b>752S</b> Door Bottom - Sweep	MIL				5.55		NGP: 102V ANSI: R3D436
	DBA				6.80		
	GLD				6.65		
<b>753S</b> Door Bottom - Sweep	MIL		6.60				NGP: 114 Pemko: 3151 ANSI: R3B436
	DBA		7.60				
	GLD		8.20				
<b>754S</b> Door Bottom - Sweep	CLR		6.50				NGP: 197 Pemko: 3151 ANSI: R3B436
	DBA		8.50				
	GLD		9.10				

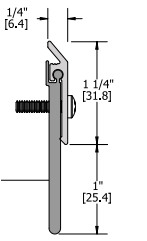
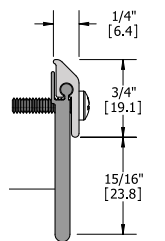
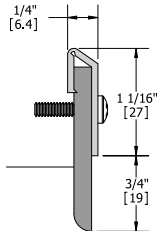
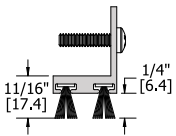
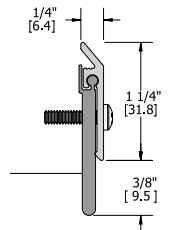

1. U/M is feet unless otherwise noted.

# Thresholds and Weatherstripping

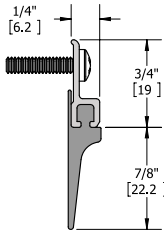

Description	Finish	Without Insert		With Insert		Comparison Numbers
		Insert	N	S	V	
<b>7565</b> Door Bottom - Sweep or Astragal*	MIL				2.95	NGP: 97
	DBA				4.10	Pemko: 307
*Order 2 for a set	GLD				4.35	ANSI: R3D434

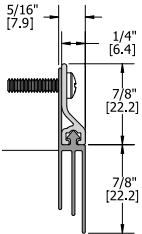

<b>7595</b> Door Bottom - Sweep	MIL				4.40	NGP: 96
	DBA				5.10	Pemko: 57
	GLD				5.60	ANSI: R3D436

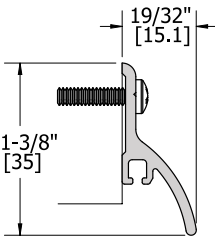

Description	Finish	Without Insert		With Insert		Comparison Numbers
		Insert	B	S	V	
<b>7705</b> Door Bottom - Sweep w/ Rain Drip	MIL	2.70	6.40		4.30	NGP: 17
	DBA	4.80	7.90		5.60	NGP: 101
	GLD	5.20	8.10		6.20	NGP: C627
						Pemko: 345
						ANSI: R3Y534

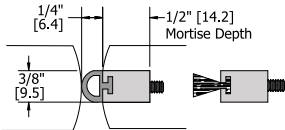

Description	Finish	Without Insert		With Insert		Comparison Numbers	
		Insert	N	S	V		
<b>7715</b> Astragal	MIL		10.10	10.50	9.75	9.30	NGP: 143
	DBA		11.10	11.50	10.60	11.85	Pemko: 300
							ANSI: R3Y725

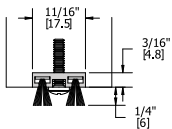

<b>7725</b> Door Bottom - Shoe or Astragal	MIL		6.25	6.70	6.50	6.15	NGP: 116
	DBA		7.70	8.40	7.95	7.55	Pemko: 313
	GLD		8.25	8.70	8.25	7.80	ANSI: R3Y726

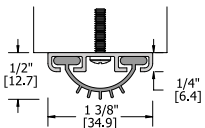

<b>7745</b> Door Bottom - Shoe or Astragal	MIL		4.10		3.40		NGP: 112
	DBA		5.35		4.40		Pemko: 234
							ANSI: R3Y725

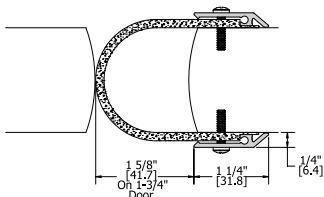

<b>7765</b> Door Bottom - Shoe or Astragal 1-3/4" Door	CLR		11.55				NGP: 14
	DBA		13.65				ANSI: R3C735

Price Code: POA - Price on Application  
 Insert Codes: V - Vinyl; N - Neoprene, EDPM, or TPE; S - Silicone; W - Pile; B - Nylon Brush; F - Vinyl Fin  
 Finish Codes: MIL - Mill Finished Aluminum; DBA - Dark Bronze Anodized; GLD - Gold Anodized; MIB - Mill Finished Bronze; 32D - Matte Stainless Steel; GYP - Primed for Painting; CLR - Clear Anodized; CAL - Cast Aluminum



# Thresholds and Weatherstripping

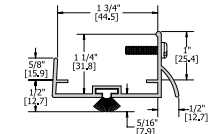
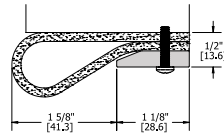
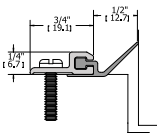
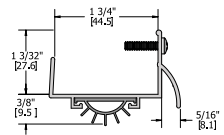
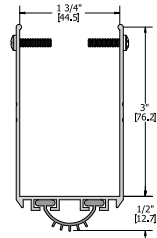
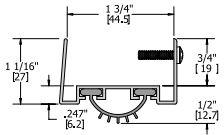
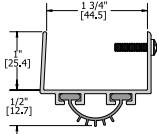
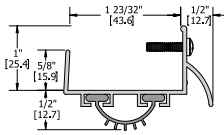
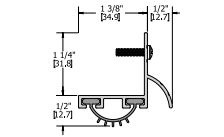

Description	Finish	Without Insert		With Insert		Comparison Numbers
		Insert	N	S	V	
<b>777S</b> Door Bottom - Shoe w/ Rain Drip	MIL		6.00		5.00	NGP: 318
	DBA		7.80		6.50	Pemko: 210
	GLD		8.70		7.25	ANSI: R3D536
<b>778S</b> Door Bottom - Shoe w/ Rain Drip	MIL		6.00		5.00	NGP: 319E
	DBA		7.80		6.50	Pemko: 215
	GLD		8.70		7.25	ANSI: R3D536
<b>779S</b> Door Bottom - Shoe	MIL		6.00		5.00	NGP: 36
	DBA		7.80		6.50	Pemko: 217
	GLD		8.70		7.25	ANSI: R3D436
<b>780S</b> Door Bottom - Shoe	MIL		7.20		6.00	NGP: 35
	DBA		9.35		7.80	Pemko: 222
	GLD		10.45		8.70	ANSI: R3D436
<b>782S</b> Door Bottom - Shoe	MIL		15.95		13.15	NGP: 99
	DBA		20.45		17.10	Pemko: 221
	GLD		21.90		19.70	ANSI: R3D436
<b>783S</b> Door Bottom - Shoe w/ Rain Drip Low Profile	MIL				5.05	NGP: 319E
	DBA				7.10	ANSI: R3D536
	GLD				7.60	
<b>785S</b> Jamb Weatherstrip up to 96"	MIL		4.20			NGP: 188
	DBA		6.10			ANSI: R3D164
	GLD		6.50			
<b>787S</b> Garage Weatherstrip	MIL		34.15			NGP: 81369
						Pemko: E199
						ANSI: R3D016
<b>789S</b> Door Bottom Rain Drip	MIL					ANSI: R3F536
	DBA				9.00	
	GLD				13.00	
					13.60	

# Thresholds and Weatherstripping

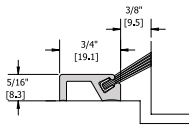

Description	Finish	B	N	With Insert			Comparison Numbers
				S	V	W	
<b>800S</b> Jamb Weatherstrip	MIL	5.50					NGP: A626A Pemko: 29344 ANSI: R3F164
	DBA	7.85					
	GLD	8.45					

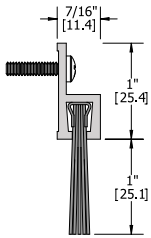

<b>801S</b> Door Sweep or Jamb Weatherstrip or Astragal*	MIL	6.30					NGP: D608 Pemko: 18100 ANSI: R3D434
	DBA	8.20					
	GLD	8.20					

\*Order 2 for a set

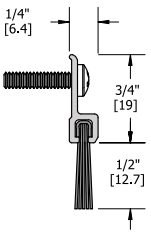

<b>802S</b> Door Sweep or Jamb Weatherstrip or Astragal*	MIL	4.10					NGP: B606 Pemko: 18061 ANSI: R3F164
	DBA	5.40					
	GLD	5.80					

\*Order 2 for a set

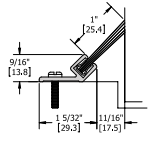

<b>803S</b> Jamb Weatherstrip	MIL	6.90					NGP: D620 Pemko: 45100 ANSI: R3F164
	DBA	8.00					
	GLD	8.50					

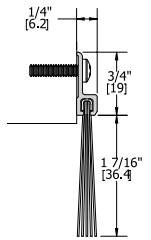

<b>806S</b> Door Sweep	MIL	9.00					NGP: E609 Pemko: 18137 ANSI: R3F436
	DBA	12.95					
	GLD	13.50					

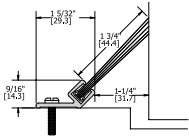

<b>808S</b> Jamb Weatherstrip	MIL	10.50					NGP: G622 Pemko: 45175 ANSI: R3F164
	DBA	15.10					
	GLD	15.70					

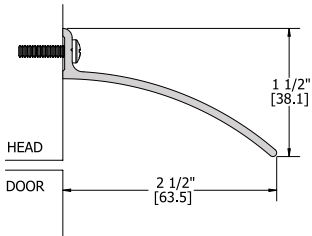

Description	Finish	Without Insert	N	With Insert			Comparison Numbers
				S	V	W	
<b>810S</b> Overhead Rain Drip	MIL	4.75					NGP: 16 Pemko: 346 ANSI: R3Y036
	DBA	6.40					
	GLD	7.35					

Price Code: POA - Price on Application  
 Insert Codes: V - Vinyl; N - Neoprene, EDPM, or TPE; S - Silicone; W - Pile; B - Nylon Brush; F - Vinyl Fin  
 Finish Codes: MIL - Mill Finished Aluminum; DBA - Dark Bronze Anodized; GLD - Gold Anodized; MIB - Mill Finished Bronze; 32D - Matte Stainless Steel; GYP - Primed for Painting; CLR - Clear Anodized; CAL - Cast Aluminum

# Thresholds and Weatherstripping

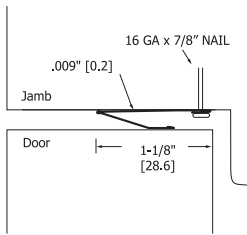

Description	Finish	Without Insert		With Insert			Comparison Numbers
		Insert	N	S	V	W	

<b>822S</b> Jamb Weatherstrip Spring Bronze 8' Lengths only	MIB	4.25					NGP: 43CB Pemko: B75 ANSI: R1Y156
--	-----	------	--	--	--	--	---

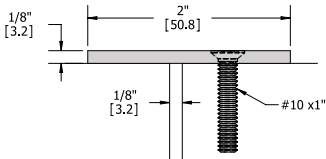

<b>835S</b> Astragal - Bar Type 10' Max length	MIL	6.10					NGP: 139 Pemko: 357 ANSI: ROY636
	DBA	7.85					
	GLD	8.80					
	GYP	6.35					
	32D	28.00					

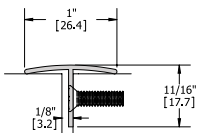

<b>836S</b> Astragal T-Type	MIL	5.25					NGP: 176 Pemko: 359 ANSI: R3Y616
	DBA	7.00					
	GLD	7.55					

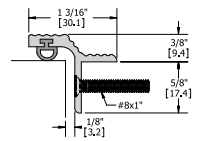

<b>837S</b> Astragal T-Type	MIL		6.95	7.25	5.90	5.90	NGP: 158 Pemko: 355 ANSI: R3Y714
	DBA		9.30	9.40	8.15	8.15	
	GLD		9.70	9.75	8.65	8.65	

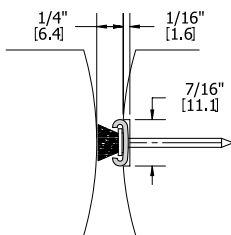

<b>838S</b> Meeting Stile *insert not replaceable	MIL					4.10	NGP: 136P Pemko: A372P ANSI: R3F725
---	-----	--	--	--	--	------	---

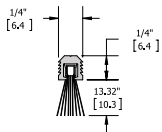

Description	Finish	B	N	With Insert			Comparison Numbers
				S	V	W	

<b>839S</b> Kerf-in Mortise Astragal Sweep *Brush insert	MIL	4.50					Pemko: 5041AP ANSI: R3A425
---	-----	------	--	--	--	--	-------------------------------

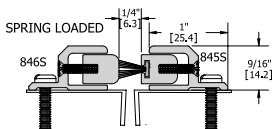

Description	Finish	Without Insert		With Insert			Comparison Numbers
		Insert	N	S	V	W	

<b>845S</b> Astragal - Surface Applied Adjustable Spring Loaded w/ Pile Must also order 846 for a set.	MIL					16.00	NGP: 140P Pemko: 351P
	DBA					19.20	ANSI: R3F834
	GLD					20.80	





# Thresholds and Weatherstripping

Description	Finish	Without Insert		With Insert			Comparison Numbers
		Insert	N	S	V	W	
<b>846S</b> Astragal - Surface Applied Adjustable Spring Loaded Must also order 845 for a set	MIL DBA GLD		15.60 18.75 20.60				NGP: 140P Pemko: 351P ANSI: R3F834
<b>847S</b> Astragal - Mortise Type Adjustable Spring Loaded w/ Pile Must also order 848 for a set	MIL DBA GLD					15.10 18.90 21.00	NGP: 144P Pemko: 354P ANSI: R3F824
<b>848S</b> Astragal - Mortise Type Adjustable Spring Loaded Must also order 847 for a set	MIL DBA GLD	15.10 18.90 21.10					NGP: 144P Pemko: 354P ANSI: R3F824
<b>849S</b> Adjustable Astragals Magnetic 80" to 96" Doors only (sold as set ONLY)	MIL DBA GLD	40.00 48.00 52.00					NGP: 140P ANSI: R3L835
<b>859S</b> Magnetic Weatherstrip	MIL DBA GLD	8.50 10.55 11.00					NGP: 159M Pemko: 2815 ANSI: R3L264
<b>860S</b> Jamb Weatherstrip Adjustable	MIL DBA GLD		15.50 18.60 19.70	16.00 19.20 20.30	15.00 18.00 19.10	15.00 18.00 19.10	NGP: 106 Pemko: 351 ANSI: R3B264
<b>861S</b> Jamb Weatherstrip	MIL DBA GLD		7.80 9.00 9.80				NGP: 108 Pemko: 285 ANSI: R3C164
<b>862S</b> Jamb Weatherstrip	CLR DBA GLD		6.05 6.95 7.65				NGP: 137 Pemko: 319 ANSI: R3B164
<b>863S</b> Jamb Weatherstrip	CLR DBA GLD		6.70 7.95 8.25				NGP: 138 ANSI: R3B164
<b>864S</b> Jamb Weatherstrip Adjustable	CLR DBA GLD		11.20 13.80 14.45				NGP: 107 Pemko: 379 ANSI: R3C164
<b>865S</b> Jamb Weatherstrip Adjustable	MIL DBA GLD		15.30 18.05 19.00				NGP: 103N Pemko: 350 ANSI: R3C264

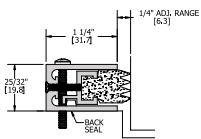
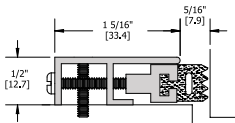
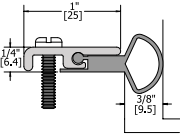
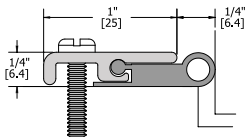
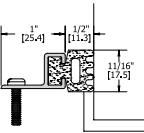
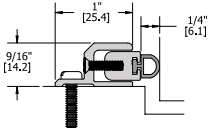
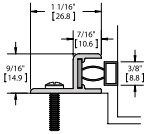
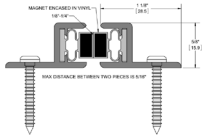
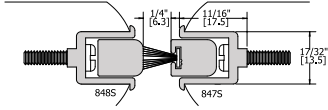

Price Code: POA - Price on Application  
 Insert Codes: V - Vinyl; N - Neoprene, EDPM, or TPE; S - Silicone; W - Pile; B - Nylon Brush; F - Vinyl Fin  
 Finish Codes: MIL - Mill Finished Aluminum; DBA - Dark Bronze Anodized; GLD - Gold Anodized; MIB - Mill Finished Bronze; 32D - Matte Stainless Steel; GYP - Primed for Painting; CLR - Clear Anodized; CAL - Cast Aluminum



# Thresholds and Weatherstripping

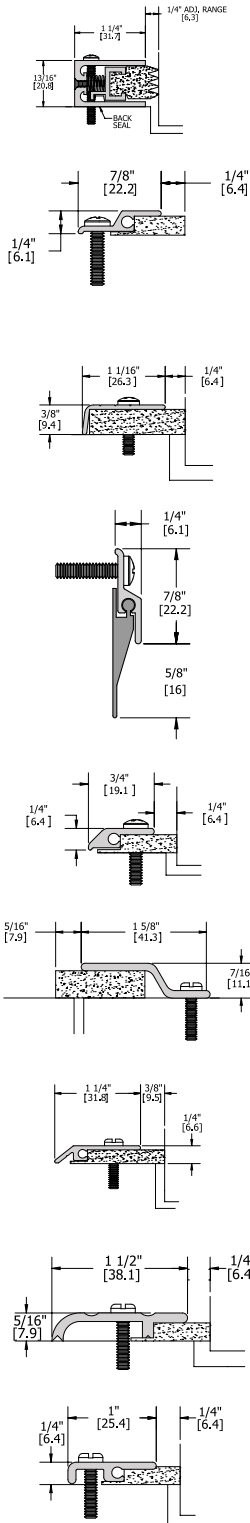

Description	Finish	Without Insert		With Insert		Comparison Numbers
		Insert	N	S	V	
<b>866S</b> Jamb Weatherstrip Adjustable Spring Loaded	MIL		16.00			NGP: 303N ANSI: R3C264
	DBA		19.00			
	GLD		20.15			
<b>870S</b> Jamb Weatherstrip	CLR		3.80			NGP: 127 NPG: 120SS
	DBA		4.90			Pemko: 305
	GLD		5.75			ANSI: ROC164
	MIB		24.00			
	32D		24.00			
<b>871S</b> Jamb Weatherstrip	MIL		5.30			NGP: 133 Pemko: 368
	DBA		6.85			ANSI: R3C164
	GLD		7.05			
<b>872S</b> Door Bottom Sweep or Astragal Order 2 for set *32D and MIB are supplied with gray insert and differ from black gasket supplied with other finishes	CLR		5.30			NGP: 125 Pemko: 305
	DBA		6.25			ANSI: ROB634
	GLD		7.25			
	MIB*		47.75			
	32D*		25.20			
<b>873S</b> Jamb Weatherstrip	MIL		4.10			NGP: 110 Pemko: 332
	DBA		5.20			ANSI: R3C164
	GLD		6.00			
<b>874S</b> Astragal/Jamb Weatherstrip	MIL		6.15			NGP: 122 Pemko: 375
	DBA		8.30			ANSI: R3C164
	GLD		9.00			
	32D		32.00			
<b>875S</b> Jamb Weatherstrip	CLR		4.90	6.50		NGP: 130 Pemko: 315
	DBA		6.00	8.10		ANSI: ROY134
	GLD		6.75	8.80		
	MIB		22.00	25.00		
<b>877S</b> Jamb Weatherstrip	MIL		5.75			ANSI: R3C164
	DBA		7.15			
	GLD		8.05			
<b>878S</b> Jamb Weatherstrip	CLR		4.55			NGP: 134 Pemko: 312
	DBA		5.20			ANSI: R3C164
	GLD		5.45			

# Thresholds and Weatherstripping

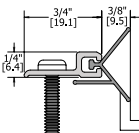
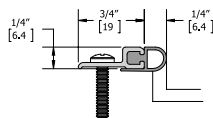
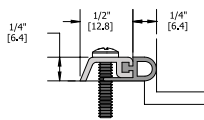
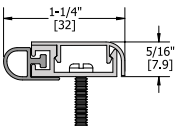
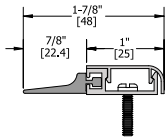
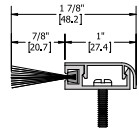
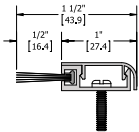
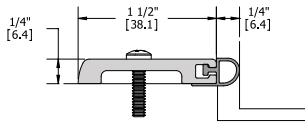
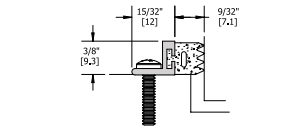

Description	Finish	Without Insert		With Insert			Comparison Numbers
		Insert	N	S	V	W	
<b>880S</b> Jamb Weatherstrip	MIL		4.10				NGP: 165 Pemko: 296 ANSI: R3C164
	DBA		5.50				
	GLD		6.10				

<b>881S</b> Jamb Weatherstrip Hardware Compatible	MIL		6.55	7.05	5.80	7.50	NGP: 700E Pemko: 290 ANSI: R3Y164
	DBA		8.20	8.80	7.25	9.35	
	GLD		9.15	9.85	8.10	10.45	

Description	Finish	B	N	With Insert			Comparison Numbers
				S	V	W	
<b>882S</b> Door Sweep, Astragal or Jamb Weatherstrip with Snap Cover	CLR	6.30					NGP: 170 Pemko: 29326 ANSI: R3Y164
	DBA	8.80					
	GLD	9.45					

<b>883S</b> Door Sweep with Snap Cover	CLR	7.50					NGP: 170 Pemko: 293100 ANSI: R3Y164
	DBA	9.70					
	GLD	10.50					

Description	Finish	F	N	With Insert			Comparison Numbers
				S	V	W	
<b>884S</b> Astragal, Door Sweep with Snap Cover	CLR				6.00		NGP: 170 ANSI: R3Y164
	DBA				7.50		
	GLD				8.05		

<b>885S</b> Jamb Weatherstrip with Snap Cover	CLR	5.65	6.30	6.80	5.65	6.25	NGP: 170 Pemko: 29310 ANSI: R3Y164
	DBA	8.25	8.80	9.50	8.25	8.75	
	GLD	8.70	9.45	9.90	8.70	9.25	

<b>890S</b> Jamb Weatherstrip	MIL		2.25	2.85	1.60		NGP: 152 Pemko: 316 ANSI: R3Y164
	DBA		3.45	4.45	2.70		
	GLD		3.55	4.60	2.80		

<b>891S</b> Jamb Weatherstrip	MIL	1.60	2.25	2.85	1.60		NGP: 155 Pemko: 303 ANSI: R3Y164
	DBA	2.70	3.45	4.45	2.70		
	GLD	2.80	3.55	4.60	2.80		

<b>892S</b> Jamb Weatherstrip Insert: Gray Neoprene	MIL		2.50				NGP: 190 Pemko: 294 ANSI: R3B164
	DBA		3.85				
	GLD		3.95				

Price Code: POA - Price on Application  
 Insert Codes: V - Vinyl; N - Neoprene, EDPM, or TPE; S - Silicone; W - Pile; B - Nylon Brush; F - Vinyl Fin  
 Finish Codes: MIL - Mill Finished Aluminum; DBA - Dark Bronze Anodized; GLD - Gold Anodized; MIB - Mill Finished Bronze; 32D - Matte Stainless Steel; GYP - Primed for Painting; CLR - Clear Anodized; CAL - Cast Aluminum



# Thresholds and Weatherstripping

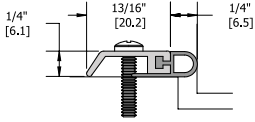
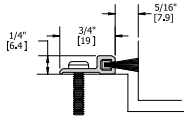

Description	Finish	F	N	With Insert		W	Comparison Numbers
				S	V		
<b>893S</b> Jamb Weatherstrip	MIL					2.65	NGP: A605
	DBA					4.05	Pemko: 309
	GLD					4.20	ANSI: R3F164
<b>896S</b> Jamb Weatherstrip	MIL		2.25	2.85	1.60		NGP: 156
	DBA		3.45	4.45	2.70		Pemko: 297
	GLD		3.55	4.60	2.80		ANSI: R3Y164

## Thresholds

### Thresholds

400S 36" DBA VINYL	.057047
401S 36" DBA	.069704
401S 36" MIB.	.065336
401S 36" MIL	.051003
401S 48" MIB.	.020273
401S 72" SCA.	.134225
402S 36" MIL	.051415
403S 36" US3	.055207
403S 36" US32D	.031227
403S 36" US9	.073874
403S 36" DBA	.054097
403S 36" LBA	.002372
403S 36" MIB.	.063201
<b>403S 36" MIL</b>	<b>051829</b>
403S 36" SCA.	.007258
403S 48" US10B	.046127
403S 48" US3	.055216
403S 48" US32D	.004453
403S 48" MIL	.051420
403S 72" US32D	.037064
403S 72" DBA	.054098
403S 72" MIB.	.062857
404S 36" US3	.066258
404S 36" US32D	.029919
404S 36" DBA	.053510
404S 36" MIB.	.016041
<b>404S 36" MIL</b>	<b>051423</b>
404S 48" US32D	.029920
404S 48" DBA	.058788
404S 48" MIL	.051424
404S 72" US3	.066324
404S 72" US32D	.031159
404S 72" MIL	.051426
404S 96" US32D	.079828
404S 96" MIL	.053016
406S 36" MIL	.051431
406S 72" GLD	.025728
406S 72" MIL	.051434
407S 36" DBA	.069696
407S 36" GLD	.022070
407S 36" MIL	.051435
407S 48" MIL	.051436
407S 72" GLD	.082336
407S 96" MIL	.077245
410S 36" DBA	.058997
410S 36" MIB.	.063300

## Thresholds and Weatherstripping - Stock Numbers

### Thresholds

<b>410S 36" MIL</b>	<b>051009</b>
410S 48" DBA	.061578
410S 48" MIL	.051011
410S 72" DBA	.061579
410S 72" GLD	.038946
410S 72" MIB.	.059484
<b>410S 72" MIL</b>	<b>051013</b>
410S 96" MIL	.056399
411S 36" BLA	.081343
411S 36" MIB.	.030827
411S 36" MIL	.051015
411S 72" MIB.	.030828
412S 36" US32D	.030454
412S 36" US32D NH	.001776
412S 36" DBA	.053693
412S 36" GLD	.053738
<b>412S 36" MIL</b>	<b>051021</b>
412S 36" SCA.	.055441
412S 36" SCB	.017067
412S 48" US10B	.040516
412S 48" US32D	.033440
412S 48" DBA	.054063
<b>412S 48" MIL</b>	<b>051023</b>
412S 48" SCA.	.074258
412S 72" US32D	.030457
412S 72" DBA	.053067
412S 72" GLD	.063301
<b>412S 72" MIL</b>	<b>051025</b>
412S 72" SCA.	.060167
412S 72" SCB	.129267
412S 96" US32D	.090042
412S 96" GLD	.055211
412S 96" MIL	.052764
413S 36" US3	.052029
413S 36" US32D	.025717
413S 36" DBA	.015900
413S 36" MIB.	.065335
<b>413S 36" MIL</b>	<b>051027</b>
413S 48" US32D	.039101
413S 48" DBA	.065227
413S 48" MIB.	.075840
<b>413S 48" MIL</b>	<b>051029</b>
413S 72" US3	.052031
413S 72" US32D	.023441
413S 72" DBA	.054295
<b>413S 72" MIL</b>	<b>051031</b>



**Thresholds**

413S 72" MIB. ....	.065600
413S 96" US3 .....	.052032
413S 96" MIB. ....	.000396
413S 96" MIL. ....	.054157
414S 36" DBA .....	.000955
414S 36" MIL. ....	.051451
414S 72" DBA .....	.117097
415S 36" US3 .....	.047179
415S 36" DBA .....	.057305
415S 36" MIB. ....	.056249
<b>415S 36" MIL .....</b>	<b>.051033</b>
415S 36" SCA. ....	.071687
415S 48" DBA .....	.023733
415S 48" MIB. ....	.069856
415S 48" MIL. ....	.051035
415S 48" SCA. ....	.066494
415S 72" US9 .....	.074543
415S 72" MIB. ....	.054640
415S 72" MIL. ....	.051037
416S 36" DBA .....	.060723
416S 36" GLD .....	.081665
416S 36" MIB. ....	.053151
416S 36" MIL. ....	.051051
416S 36" SCA. ....	.090216
416S 48" DBA .....	.063049
416S 48" MIB. ....	.026002
416S 48" MIL. ....	.051053
416S 72" EBRP .....	.061273
416S 72" DBA .....	.016047
416S 72" MIB. ....	.053150
416S 72" MIL. ....	.051055
416S 96" MIB. ....	.000079
416S 96" MIL. ....	.052960
417S 36" US9 .....	.066359
417S 36" DBA .....	.059553
417S 36" MIB. ....	.079232
<b>417S 36" MIL .....</b>	<b>.056494</b>
417S 36" SCA. ....	.058889
417S 48" DBA .....	.024802
417S 48" MIB. ....	.089813
417S 48" MIL. ....	.057023
417S 72" DBA .....	.075007
417S 72" MIB. ....	.074429
417S 72" MIL. ....	.057024
417S 96" MIL. ....	.060172
418S 36" US10B .....	.031199

**Thresholds**

418S 36" MIB. ....	.061328
418S 36" MIL. ....	.056495
418S 48" MIB. ....	.051530
418S 48" MIL. ....	.062685
418S 72" US3 .....	.048580
418S 72" MIB. ....	.081511
418S 72" MIL. ....	.059607
418S 96" MIL. ....	.066488
419S 36" MIL. ....	.056496
419S 48" DBA .....	.108927
420S 36" MIL. ....	.061332
420S 48" MIL. ....	.030506
420S 72" MIL. ....	.073999
421S 36" MIL. ....	.059872
421S 72" DBA .....	.068739
421S 72" MIL. ....	.064918
422S 36" MIL. ....	.064486
422S 48" MIL. ....	.085099
422S 72" MIL. ....	.064485
423S 72" MIL. ....	.082531
424S 36" MIL. ....	.066013
424S 48" MIL. ....	.095418
426S 36" DBA .....	.002015
426S 36" MIL. ....	.061695
426S 48" MIL. ....	.077225
426S 72" MIL. ....	.064254
426S 96" MIL. ....	.064253
427S 36" MIL. ....	.061190
427S 48" MIL. ....	.061133
427S 72" MIL. ....	.061125
427S 96" DBA .....	.134871
428S 36" MIB. ....	.134160
428S 36" MIL. ....	.069001
428S 48" MIL. ....	.030450
428S 72" DBA .....	.066973
428S 72" MIL. ....	.059870
428S 96" DBA .....	.021942
428S 96" MIB. ....	.021256
430S 36" MIL. ....	.062855
430S 48" MIL. ....	.088799
430S 72" DBA .....	.095313
430S 72" MIL. ....	.070161
430S 72" SCA. ....	.084515
431S 36" DBA .....	.070641
431S 36" GLD .....	.048973
431S 36" MIB. ....	.053331

## Thresholds

### Thresholds

431S 36" MIL	.051455
431S 48" DBA	.078959
431S 48" MIL	.051456
431S 72" DBA	.055522
431S 72" GLD	.066756
431S 72" MIB	.067194
431S 72" MIL	.051458
431S 96" MIL	.096450
432S 36" BLA	.095183
432S 36" DBA	.059786
432S 36" MIL	.053172
432S 48" US10B	.095706
432S 48" MIL	.062853
432S 72" US10B	.095703
432S 72" BLA	.095185
432S 72" DBA	.057872
432S 72" MIB	.055335
432S 72" MIL	.053822
433S 36" DBA	.054825
433S 36" GLD	.058459
433S 36" MIL	.051463
433S 48" MIL	.051464
433S 72" DBA	.063629
433S 72" GLD	.062034
433S 72" MIB	.082680
433S 72" MIL	.051466
434S 36" MIL	.052038
434S 36" MIL NEOPRENE	.026655
434S 36" MIL SILICONE	.031084
434S 36" MIL VINYL	.056329
435S 36" GLD	.106702
435S 36" MIL NEOPRENE	.028335
435S 72" MIL NEOPRENE	.080550
435S 36" MIL VINYL	.056497
435S 72" MIL VINYL	.056644
436S 36" DBA	.038944
436S 36" MIL	.027686
436S 48" DBA	.093704
436S 48" GLD	.089938
436S 48" MIL	.023620
436S 72" DBA	.075861
436S 72" MIL	.032198
436S 96" MIL	.054106
438S 36" DBA	.046790
438S 36" GLD	.048227
438S 36" MIL	.013799

## Thresholds and Weatherstripping - Stock Numbers

### Thresholds

438S 72" DBA	.045585
438S 72" GLD	.078454
440S 36" MIB	.065069
440S 72" GLD	.140089
440S 72" MIB	.140048
442S 36" MIL	.065007
442S 36" SCA	.071626
442S 48" MIL	.063483
442S 72" MIL	.086139
443S 36" MIL	.065346
444S 36" MIL	.089632
444S 48" MIL	.094554
445S 72" MIL	.051471
445S 96" MIL	.062261
448S 36" DBA	.117092
448S 36" MIL	.038781
448S 48" MIL	.111712
448S 72" DBA	.130861
448S 72" MIL	.037440
448S 96" MIL	.066757
448S 96" MIL NH	.139421
450S 36" GLD	.131762
450S 36" MIB	.023360
450S 48" MIB	.069674
450S 48" MIL	.051473
450S 72" GLD	.060490
450S 96" MIL	.012758
451S 48" MIL	.098765
451S 72" MIB	.114897
451S 72" MIL	.073016
452S 72" MIL	.092409
455S 36" MIB	.034908
455S 72" GLD	.031990
455S 72" MIB	.079303
455S 96" MIL	.070042
460S 36" MIB	.044822
460S 72" MIB	.005291
460S 72" MIL	.051483
460S 96" MIL	.075035
465S 72" MIL	.051488
470S 36" MIB	.044823
470S 36" MIL	.051492
470S 72" GLD	.062275
470S 72" MIB	.005297
470S 72" MIL	.051494
477S 48" DBA	.144656



**Thresholds**

477S 36" BLA NEOPRENE . . . . .	.072390
477S 48" MIL NEOPRENE . . . . .	.025060
477S 36" MIL VINYL . . . . .	.089975
477S 48" DBA VINYL . . . . .	.021980
477S 48" MIL VINYL . . . . .	.017278
477S 72" MIL VINYL . . . . .	.094703
478S 36" MIL . . . . .	.144368
478S 36" GLD SILICONE . . . . .	.088825
480S 36" MIL . . . . .	.051495
480S 48" DBA . . . . .	.101556
480S 48" MIL . . . . .	.051496
480S 72" MIL . . . . .	.062474
481S 36" MIL NEOPRENE . . . . .	.055791
481S 48" MIL NEOPRENE . . . . .	.076605
481S 72" MIL NEOPRENE . . . . .	.055980
481S 36" MIL SILICONE . . . . .	.072476
481S 36" DBA VINYL . . . . .	.006126
481S 36" MIL VINYL . . . . .	.056073
481S 48" DBA VINYL . . . . .	.063958
481S 48" MIL VINYL . . . . .	.051940
481S 72" DBA VINYL . . . . .	.050881
481S 72" MIL VINYL . . . . .	.054902
484S 36" DBA . . . . .	.079872
484S 36" MIB . . . . .	.023355
484S 36" MIL . . . . .	.051516
484S 48" DBA . . . . .	.050841
484S 48" MIL . . . . .	.051517
484S 72" DBA . . . . .	.050882
484S 72" MIB . . . . .	.066078
484S 72" MIL . . . . .	.051519
484S 96" MIL . . . . .	.088497
492S 36" MIL . . . . .	.032347
504S 36" MIL . . . . .	.051534
504S 72" MIL . . . . .	.056390
505S 36" MIL . . . . .	.051542
506S 36" BLA . . . . .	.052729
506S 36" MIL . . . . .	.054719
506S 72" BLA . . . . .	.016492
508S 36" DBA . . . . .	.020721
508S 36" MIL . . . . .	.034315
508S 96" DBA . . . . .	.110506
515S 36" MIL PILE . . . . .	.026369
516S 36" MIL . . . . .	.124421
516S 72" MIL . . . . .	.128226
516S 36" MIL NEOPRENE . . . . .	.034721
516S 36" MIL SILICONE . . . . .	.064022

**Thresholds**

516S 36" MIL VINYL . . . . .	.033033
516S 72" MIL VINYL . . . . .	.034574
517S 72" MIL NEOPRENE . . . . .	.013993
517S 72" GLD VINYL . . . . .	.133469
518S 48" GLD VINYL . . . . .	.055794
518S 72" GLD VINYL . . . . .	.138533
520S 36" MIL . . . . .	.033055
520S 72" MIL . . . . .	.051539
520S 36" US10B NEOPRENE . . . . .	.029314
520S 36" US10B NEOPRENE NH . . . . .	.029318
520S 36" MIB NEOPRENE . . . . .	.003933
520S 36" MIL NEOPRENE . . . . .	.054613
520S 48" MIL NEOPRENE . . . . .	.056182
520S 72" US10B NEOPRENE . . . . .	.029312
520S 72" US10B NEOPRENE NH . . . . .	.029315
520S 72" MIL NEOPRENE . . . . .	.055935
520S 72" SCA NEOPRENE . . . . .	.046841
520S 36" US32D SILICONE . . . . .	.107239
520S 36" MIB SILICONE . . . . .	.016393
520S 36" MIL SILICONE . . . . .	.064059
520S 48" MIL SILICONE . . . . .	.080333
520S 72" US32D SILICONE . . . . .	.053973
520S 72" MIB SILICONE . . . . .	.081540
520S 72" MIL SILICONE . . . . .	.064061
520S 36" DBA VINYL . . . . .	.054218
520S 36" MIB VINYL . . . . .	.067031
<b>520S 36" MIL VINYL . . . . .</b>	<b>.051061</b>
520S 36" SCA VINYL . . . . .	.001850
520S 36" SCB VINYL . . . . .	.120773
520S 48" DBA VINYL . . . . .	.079046
520S 48" MIB VINYL . . . . .	.024736
<b>520S 48" MIL VINYL . . . . .</b>	<b>.051062</b>
520S 72" DBA VINYL . . . . .	.054454
<b>520S 72" MIL VINYL . . . . .</b>	<b>.051066</b>
520S 72" SCA VINYL . . . . .	.017347
520S 72" SCB VINYL . . . . .	.120774
520S 96" MIL VINYL . . . . .	.057442
532S 36" MIL . . . . .	.051548
532S 36" DBA NEOPRENE . . . . .	.071073
532S 36" MIL SILICONE . . . . .	.073124
532S 72" MIB SILICONE . . . . .	.048686
532S 72" MIL SILICONE . . . . .	.054919
532S 36" US32D VINYL . . . . .	.107563
532S 36" MIB VINYL . . . . .	.080264
532S 36" MIL VINYL . . . . .	.051552
532S 48" MIL VINYL . . . . .	.051830



## Thresholds

### Thresholds

532S 72" VINYL . . . . .	.062282
532S 72" MIL VINYL . . . . .	.051555
532S 96" MIL VINYL . . . . .	.053837
541S 36" 10B NEOPRENE . . . . .	.078694
541S 36" MIL NEOPRENE . . . . .	.054211
541S 48" 10B NEOPRENE . . . . .	.078680
541S 48" DBA NEOPRENE . . . . .	.000896
541S 48" MIL NEOPRENE . . . . .	.054059
541S 72" MIB NEOPRENE . . . . .	.055086
541S 72" MIL NEOPRENE . . . . .	.054060
541S 36" CLR VINYL . . . . .	.095393
541S 36" DBA VINYL . . . . .	.053658
541S 36" MIB VINYL . . . . .	.000966
<b>541S 36" MIL VINYL . . . . .</b>	<b>051068</b>
541S 48" CLR VINYL . . . . .	.095382
541S 48" MIL VINYL . . . . .	.051070
541S 72" MIB VINYL . . . . .	.000967
541S 72" MIL VINYL . . . . .	.051074
541S 36" MIB PILE . . . . .	.090733
541S 72" MIB PILE . . . . .	.090736
552S 36" MIB SILICONE . . . . .	.076183
552S 48" MIB SILICONE . . . . .	.121791
552S 36" 32D VINYL . . . . .	.108523
<b>552S 36" MIL VINYL . . . . .</b>	<b>051568</b>
552S 48" MIL VINYL . . . . .	.051569
552S 96" MIL VINYL . . . . .	.057479
560S 36" MIL VINYL . . . . .	.051076
560S 36" MIL VINYL NH . . . . .	.008752
560S 48" MIL VINYL . . . . .	.051078
560S 48" MIL VINYL NH . . . . .	.012801
560S 72" MIL VINYL . . . . .	.051082
560S 72" MIL VINYL NH . . . . .	.009223
565S 36" SCA NEOPRENE . . . . .	.145379
565S 48" MIL NEOPRENE . . . . .	.008593
565S 48" SCA NEOPRENE . . . . .	.145380
565S 36" MIL VINYL . . . . .	.057025
565S 36" SCA VINYL . . . . .	.137796
565S 48" SCA VINYL . . . . .	.137797
566S 72" MIL VINYL . . . . .	.017021
572S 36" DBA . . . . .	.025594
572S 72" MIL . . . . .	.030908
575S 36" DBA VINYL . . . . .	.052358
575S 36" MIL VINYL . . . . .	.051084
575S 48" MIL VINYL . . . . .	.051086
575S 72" MIL VINYL . . . . .	.051090
575S 96" MIL VINYL . . . . .	.052982

## Thresholds and Weatherstripping - Stock Numbers

### Thresholds

580S 36" MIL VINYL . . . . .	.021041
599S 48" DBA VINYL . . . . .	.134849
600S 36" MIL . . . . .	.051584
600S 48" MIL . . . . .	.022772
603S 36" US10B . . . . .	.076299
603S 36" US3 . . . . .	.104453
603S 36" DBA . . . . .	.078404
603S 36" MIB . . . . .	.044651
603S 36" MIL . . . . .	.051590
603S 48" MIB . . . . .	.075536
603S 48" MIL . . . . .	.051591
603S 72" DBA . . . . .	.098807
603S 72" MIB . . . . .	.041237
604S 36" DBA . . . . .	.053623
604S 36" MIB . . . . .	.054606
604S 36" MIL . . . . .	.051592
604S 36" SCA . . . . .	.071847
604S 48" DBA . . . . .	.074415
604S 48" MIB . . . . .	.038861
604S 48" MIL . . . . .	.051593
604S 72" US3 . . . . .	.048329
604S 72" DBA . . . . .	.068183
604S 72" MIB . . . . .	.048395
604S 72" MIL . . . . .	.063979
604S 72" SCA . . . . .	.094430
604S 96" MIL . . . . .	.062565
608S 36" US3 . . . . .	.051218
608S 36" MIB . . . . .	.026016
608S 36" MIL . . . . .	.006863
608S 48" MIL . . . . .	.106173
608S 72" US3 . . . . .	.051219
608S 72" DBA . . . . .	.083909
608S 72" MIL . . . . .	.065732
608S 96" DBA . . . . .	.118427
608S 96" MIL . . . . .	.094020
859S 36" DBA . . . . .	.021458
859S 36" MIL . . . . .	.031358
870S 96" MIB NEOPRENE . . . . .	.038660

### Press-On Weatherstripping

726B 204" BROWN . . . . .	.108247
726B 216" BROWN . . . . .	.141854
726B 240" BROWN . . . . .	.110396
726B 252" BROWN . . . . .	.103765
726B 300" BROWN . . . . .	.137455
<b>726S 204" CHARCOAL . . . . .</b>	<b>052216</b>
<b>726S 216" CHARCOAL . . . . .</b>	<b>052583</b>



**Press-On Weatherstripping**

<b>726S 240" CHARCOAL</b> .....	<b>052217</b>
<b>726S 252" CHARCOAL</b> .....	<b>052437</b>
726S 260-FT CHARCOAL .....	.053002
726S 264" CHARCOAL .....	.052582
726S 300" CHARCOAL .....	.052737
726S 520-FT CHARCOAL .....	.053070
726T 204" TAN .....	.068315
726T 240" TAN .....	.068312
726T 252" TAN .....	.139885
726W 204" WHITE .....	.054222
726W 216" WHITE .....	.054799
726W 240" WHITE .....	.054223
726W 252" WHITE .....	.054224
726W 260-FT WHITE .....	.054226
726W 264" WHITE .....	.060177
726W 300" WHITE .....	.054225
726W 520-FT WHITE .....	.054227
728S 204" CHARCOAL .....	.048276
728S 216" CHARCOAL .....	.051094
728S 240" CHARCOAL .....	.049528
728S 252" CHARCOAL .....	.061881
728S 260-FT CHARCOAL .....	.047334
728S 264" CHARCOAL .....	.061882
728S 300" CHARCOAL .....	.064421
728S 520-FT CHARCOAL .....	.002601
728W 204" WHITE .....	.050505
728W 240" WHITE .....	.056601
728W 300" WHITE .....	.074080
729B 204" BROWN .....	.045920
729B 216" BROWN .....	.055100
729B 252" BROWN .....	.046133
729B 300" BROWN .....	.079208
729S 204" BLACK .....	.015885
729S 252" BLACK .....	.068776
729S 300" BLACK .....	.068777
729T 204" TAN .....	.082927
729T 240" TAN .....	.103218
729T 252" TAN .....	.021429
729T 300" TAN .....	.082930
729W 204" WHITE .....	.024763
729W 252" WHITE .....	.027429
729W 300" WHITE .....	.027430
<b>736S 204" CHARCOAL</b> .....	<b>089698</b>
736S 216" CHARCOAL .....	.093251
736S 240" CHARCOAL .....	.096054
736S 252" CHARCOAL .....	.096055

**Press-On Weatherstripping**

736S 260-FT CHARCOAL .....	.095015
736S 264" CHARCOAL .....	.098132
736S 300" CHARCOAL .....	.090886
736S 520-FT CHARCOAL .....	.095014
736T 204" TAN .....	.018642
736T 252" TAN .....	.018641
736W 204" WHITE .....	.096056
736W 216" WHITE .....	.098957
736W 240" WHITE .....	.096057
736W 252" WHITE .....	.096088
736W 260-FT WHITE .....	.095017
736W 264" WHITE .....	.046032
736W 300" WHITE .....	.096033
736W 520-FT WHITE .....	.095016
737S 204" CHARCOAL .....	.035450
737S 216" CHARCOAL .....	.035449
737S 240" CHARCOAL .....	.035447
737S 252" CHARCOAL .....	.035422
737S 260-FT CHARCOAL .....	.035383
737S 264" CHARCOAL .....	.035393
737S 300" CHARCOAL .....	.035392
737S 520-FT CHARCOAL .....	.035382
737W 204" WHITE .....	.035381
737W 216" WHITE .....	.035380
737W 240" WHITE .....	.035358
737W 252" WHITE .....	.035346
737W 260' WHITE .....	.035342
737W 264" WHITE .....	.035345
737W 300" WHITE .....	.035344
737W 520' WHITE .....	.035325
719B 36" x 84" BROWN .....	.082481
719B 48" x 84" BROWN .....	.085139
719B 72" x 84" BROWN .....	.082483
719B 84" BROWN .....	.082511
719B 84" x 84" BROWN .....	.082484
719B 96" BROWN .....	.082514
719B 108" BROWN .....	.082515
719G 36" x 84" GREY .....	.082498
719G 48" x 84" GREY .....	.085140
719G 72" x 84" GREY .....	.082502
719G 84" GREY .....	.082527
719G 84" x 84" GREY .....	.082503
719G 96" GREY .....	.082530
719G 108" GREY .....	.082532
719S 36" x 84" CHARCOAL .....	.082491
719S 48" X 84" CHARCOAL .....	.085084

**Press-On Weatherstripping**

719S 72" x 84" CHARCOAL.....	.082494
719S 84" CHARCOAL.....	.082522
719S 84" x 84" CHARCOAL.....	.082496
719S 96" CHARCOAL.....	.082524
719S 108" CHARCOAL.....	.082525
719T 36" x 84" TAN.....	.082504
719T 48" x 84" TAN.....	.085141
719T 72" x 84" TAN.....	.082507
719T 84" TAN.....	.082534
719T 84" x 84" TAN.....	.082506
719T 96" TAN.....	.082535
719T 108" TAN.....	.082538
719W 36" x 84" WHITE.....	.082485
719W 48" x 84" WHITE.....	.085144
719W 72" x 84" WHITE.....	.082487
719W 84" WHITE.....	.082517
719W 84" x 84" WHITE.....	.082490
719W 96" WHITE.....	.082518
719W 108" WHITE.....	.082519
720B 36" x 84" BROWN FLEX INTUMECENT SINGLE WING.....	.107435
720B 48" X 84" BROWN FLEX INTUMESCENT SINGLE WING ..	.107433
720B 72" X 84" BROWN FLEX INTUMESCENT SINGLE WING ..	.107434
720B 84" x 84" BROWN FLEX INTUMECENT SINGLE WING.....	.112842
720G 36" x 84" GREY FLEX INTUMECENT SINGLE WING.....	.112844
720G 84" x 84" GREY FLEX INTUMECENT SINGLE WING.....	.112846
720S 36" x 84" CHARCOAL FLEX INTUM SINGLE WING.....	.105952
720S 48" X 84" CHARCOAL FLEX INTUM SINGLE WING.....	.105953
720S 72" X 84" CHARCOAL FLEX INTUM SINGLE WING.....	.105954
720S 84" x 84" CHARCOAL FLEX INTUM SINGLE WING.....	.105955
720S 96" X 96" CHARCOAL FLEX INTUM SINGLE WING.....	.118211
720T 36" x 84" TAN FLEX INTUMECENT SINGLE WING.....	.112851
720T 84" x 84" TAN FLEX INTUMECENT SINGLE WING.....	.112853
720W 36" x 84" WHITE FLEX INTUMECENT SINGLE WING.....	.112855
720W 48" x 84" WHITE FLEX INTUMECENT SINGLE WING.....	.136649
720W 72" x 84" WHITE FLEX INTUMECENT SINGLE WING.....	.136650
720W 84" x 84" WHITE FLEX INTUMECENT SINGLE WING.....	.112857
721B 36" x 84" BROWN.....	.029485
721B 48" x 84" BROWN.....	.029488
721B 72" x 84" BROWN.....	.029491
721B 84" BROWN.....	.047510
721B 84" x 84" BROWN.....	.143529
721B 96" BROWN.....	.047517
721B 108" BROWN.....	.047518
721G 36" x 84" GREY.....	.013457
721G 48" x 84" GREY.....	.108615
721G 72" x 84" GREY.....	.089314

**Press-On Weatherstripping**

721G 84" GREY.....	.087654
721G 96" GREY.....	.087652
721S 36" x 84" BLACK.....	.029493
721S 48" x 84" BLACK.....	.029494
721S 72" x 84" BLACK.....	.029496
721S 84" BLACK.....	.081187
721S 84" x 84" BLACK.....	.000002
721S 96" BLACK.....	.081186
721S 96" x 96" BLACK.....	.142009
721S 108" BLACK.....	.081735
721T 36" x 84" TAN.....	.029513
721T 48" x 84" TAN.....	.029515
721T 72" x 84" TAN.....	.029518
721T 84" TAN.....	.097047
721T 96" TAN.....	.062335
721T 108" TAN.....	.123704
721W 36" x 84" WHITE.....	.029520
721W 48" x 84" WHITE.....	.029521
721W 72" x 84" WHITE.....	.029523
721W 84" WHITE.....	.059248
721W 84" x 84" WHITE.....	.074859
721W 96" WHITE.....	.059123
721W 108" WHITE.....	.059122
722B 36" x 84" BROWN.....	.086961
722B 48" x 84" BROWN.....	.086929
722B 72" x 84" BROWN.....	.086793
722B 84" x 84" BROWN.....	.086791
722B 96" x 96" BROWN.....	.086780
722S 36" x 84" CHARCOAL.....	.087124
722S 48" x 84" CHARCOAL.....	.087063
722S 72" x 84" CHARCOAL.....	.087055
722S 84" x 84" CHARCOAL.....	.087054
722S 96" x 96" CHARCOAL.....	.087005
722T 36" x 84" TAN.....	.086777
722T 48" x 84" TAN.....	.086775
722T 72" x 84" TAN.....	.086754
722T 84" x 84" TAN.....	.086752
722T 96" x 96" TAN.....	.086745
722W 36" x 84" WHITE.....	.086996
722W 48" x 84" WHITE.....	.086993
722W 72" x 84" WHITE.....	.086972
722W 84" x 84" WHITE.....	.086969
722W 96" x 96" WHITE.....	.086966
724B 36" x 84" BROWN.....	.047696
724B 48" x 84" BROWN.....	.138515
724B 72" x 84" BROWN.....	.086997



**Press-On Weatherstripping**

724B 84" BROWN. ....	.047527
724B 96" BROWN. ....	.047528
724B 108" BROWN . ....	.047530
724G 36" X 84" GREY . ....	.096307
724G 48" X 84" GREY . ....	.047045
724G 72" X 84" GREY . ....	.096358
724G 84" GREY . ....	.089146
724G 96" GREY . ....	.093403
724S 36" x 84" CHARCOAL. ....	.089572
724S 84" CHARCOAL . ....	.061283
724S 84" x 84" CHARCOAL. ....	.109589
724S 96" CHARCOAL . ....	.000241
724S 108" CHARCOAL . ....	.014723
724T 84" TAN . ....	.051666
724T 96" TAN . ....	.051682
724W 84" WHITE . ....	.033732
724W 96" WHITE . ....	.107109
727S 36" x 84" CHARCOAL. ....	.051140
727S 72" x 84" CHARCOAL. ....	.054064
727S 84" CHARCOAL . ....	.051139
727S 96" CHARCOAL . ....	.053646
734S 36" X 84" BROWN. ....	.026246
734B 72" X 84" BROWN. ....	.026201
734B 84" BROWN. ....	.026247
734B 96" BROWN. ....	.026244
734B 96" X 96" BROWN. ....	.026200
734B 108" BROWN . ....	.026211
734G 36" X 84" GREY . ....	.026193
734G 72" X 84" GREY . ....	.026189
734G 84" GREY . ....	.026198
734G 96" GREY . ....	.026197
734G 96" X 96" GREY . ....	.026188
734G 108" GREY . ....	.026194
734S 36" X 84" BLACK. ....	.026327
734S 72" X 84" BLACK. ....	.026322
734S 84" BLACK. ....	.026357
734S 96" BLACK. ....	.026330
734S 96" X 96" BLACK. ....	.026321
734S 108" BLACK . ....	.026329
734T 36" X 84" TAN. ....	.026171
734T 72" X 84" TAN. ....	.026145
734T 84" TAN . ....	.026187
734T 96" X 96" TAN. ....	.026142
734T 108" TAN . ....	.026172
725S 84" NEOPRENE. ....	.060206
725S 96" NEOPRENE. ....	.060504

**Auto-Door Bottoms**

<b>730S 36" MIL NEOPRENE . ....</b>	<b>.072966</b>
730S 36" MIL NEOPRENE. ....	.051857
730S 42" MIL NEOPRENE. ....	.054841
730S 48" MIL NEOPRENE. ....	.051390
<b>730S 36" MIL SILICONE . ....</b>	<b>.046487</b>
730S 42" MIL SILICONE . ....	.034849
730S 48" MIL SILICONE . ....	.087236
740S 36" NEOPRENE . ....	.076463
<b>740S 36" CLR NEOPRENE . ....</b>	<b>.055452</b>
740S 36" DBA NEOPRENE . ....	.052434
740S 36" GLD NEOPRENE . ....	.057701
740S 42" CLR NEOPRENE . ....	.085096
740S 42" DBA NEOPRENE . ....	.059866
740S 42" GLD NEOPRENE . ....	.074922
740S 48" NEOPRENE . ....	.080708
740S 48" CLR NEOPRENE . ....	.087513
740S 48" DBA NEOPRENE . ....	.052435
740S 48" GLD NEOPRENE . ....	.066177
740S 36" CLR SILICONE . ....	.068926
740S 42" US32D SILICONE. ....	.017715
740S 42" CLR SILICONE . ....	.069035
740S 48" US32D SILICONE. ....	.027269
740S 48" CLR SILICONE . ....	.068927
742S 36" MIL NEOPRENE. ....	.054065
742S 42" MIL NEOPRENE. ....	.061380
742S 48" MIL NEOPRENE. ....	.000739
<b>742S 36" MIL VINYL. ....</b>	<b>.053529</b>
742S 42" MIL VINYL. ....	.058976
742S 48" MIL VINYL. ....	.053865
<b>743S 36" MIL NEOPRENE . ....</b>	<b>.052842</b>
743S 42" MIL NEOPRENE. ....	.056039
743S 48" MIL NEOPRENE. ....	.053078
<b>747S 36" CLR NEOPRENE . ....</b>	<b>.053563</b>
747S 36" DBA NEOPRENE . ....	.053781
747S 36" GLD NEOPRENE . ....	.016063
747S 42" CLR NEOPRENE . ....	.087210
747S 42" DBA NEOPRENE . ....	.057863
747S 48" CLR NEOPRENE . ....	.084717
747S 48" DBA NEOPRENE . ....	.053735
747S 48" GLD NEOPRENE . ....	.058145
<b>Door Bottoms &amp; Sweeps</b>	
750S 36" US10B NEOPRENE . ....	.010703
750S 36" US32D NEOPRENE . ....	.023937
<b>750S 36" CLR NEOPRENE . ....</b>	<b>.053564</b>
750S 36" DBA NEOPRENE . ....	.053069
750S 36" GLD NEOPRENE . ....	.052905

**Door Bottoms & Sweeps**

750S 42" US32D NEOPRENE . . . . .	.037601
750S 42" CLR NEOPRENE . . . . .	.053565
750S 42" DBA NEOPRENE . . . . .	.064869
750S 42" GLD NEOPRENE . . . . .	.071669
750S 48" US3 NEOPRENE . . . . .	.054200
750S 48" US32D NEOPRENE . . . . .	.076771
<b>750S 48" CLR NEOPRENE . . . . .</b>	<b>057658</b>
750S 48" DBA NEOPRENE . . . . .	.053013
750S 48" GLD NEOPRENE . . . . .	.058143
750S 36" US32D SILICONE . . . . .	.040289
750S 36" CLR SILICONE . . . . .	.043444
750S 36" DBA SILICONE . . . . .	.006348
750S 36" MIB SILICONE . . . . .	.020948
750S 42" US32D SILICONE . . . . .	.095058
750S 42" MIB SILICONE . . . . .	.018436
750S 48" US32D SILICONE . . . . .	.055864
750S 48" CLR SILICONE . . . . .	.070213
750S 48" MIB SILICONE . . . . .	.020951
751S 36" DBA NEOPRENE . . . . .	.054176
751S 36" MIL NEOPRENE . . . . .	.054067
751S 36" DBA VINYL . . . . .	.073725
752S 36" DBA VINYL . . . . .	.015097
752S 36" GLD VINYL . . . . .	.057972
<b>752S 36" MIL VINYL . . . . .</b>	<b>061376</b>
752S 42" DBA VINYL . . . . .	.027712
752S 42" GLD VINYL . . . . .	.088346
752S 42" MIL VINYL . . . . .	.067894
752S 48" DBA VINYL . . . . .	.040624
752S 48" GLD VINYL . . . . .	.039647
752S 48" MIL VINYL . . . . .	.007958
752S 48" MIL VINYL TEK . . . . .	.078452
753S 36" DBA NEOPRENE . . . . .	.061082
753S 36" GLD NEOPRENE . . . . .	.077227
<b>753S 36" MIL NEOPRENE . . . . .</b>	<b>051337</b>
753S 42" MIL NEOPRENE . . . . .	.067110
753S 48" MIL NEOPRENE . . . . .	.051338
<b>754S 36" CLR NEOPRENE . . . . .</b>	<b>083440</b>
754S 36" DBA NEOPRENE . . . . .	.052427
754S 42" CLR NEOPRENE . . . . .	.083370
754S 42" DBA NEOPRENE . . . . .	.005796
<b>754S 48" CLR NEOPRENE . . . . .</b>	<b>083372</b>
756S 36" DBA VINYL . . . . .	.054378
756S 36" GLD VINYL . . . . .	.058375
<b>756S 36" MIL VINYL . . . . .</b>	<b>052010</b>
756S 42" MIL VINYL . . . . .	.061396
756S 48" DBA VINYL . . . . .	.055418

**Door Bottoms & Sweeps**

<b>756S 48" MIL VINYL . . . . .</b>	<b>052011</b>
759S 36" DBA VINYL . . . . .	.027134
759S 36" GLD VINYL . . . . .	.066852
759S 36" MIL VINYL . . . . .	.060170
759S 42" DBA VINYL . . . . .	.027167
759S 42" GLD VINYL . . . . .	.104864
759S 42" MIL VINYL . . . . .	.036002
759S 48" DBA VINYL . . . . .	.066858
759S 48" GLD VINYL . . . . .	.093917
759S 48" MIL VINYL . . . . .	.032110
<b>770S 36" MIL . . . . .</b>	<b>051349</b>
770S 36" DBA BRUSH . . . . .	.065591
770S 36" GLD BRUSH . . . . .	.040794
770S 36" MIL BRUSH . . . . .	.061333
770S 42" DBA BRUSH . . . . .	.065066
770S 42" MIL BRUSH . . . . .	.033809
770S 48" DBA BRUSH . . . . .	.046311
770S 48" MIL BRUSH . . . . .	.084855
770S 36" VINYL . . . . .	.075567
770S 36" DBA VINYL . . . . .	.057644
770S 36" GLD VINYL . . . . .	.055454
<b>770S 36" MIL VINYL . . . . .</b>	<b>054681</b>
770S 36" WHP VINYL . . . . .	.048479
770S 42" GLD VINYL . . . . .	.016288
770S 42" MIL VINYL . . . . .	.067931
770S 48" DBA VINYL . . . . .	.070746
770S 48" GLD VINYL . . . . .	.038496
<b>770S 48" MIL VINYL . . . . .</b>	<b>063484</b>
772S 36" MIL NEOPRENE . . . . .	.062461
772S 48" DBA NEOPRENE . . . . .	.016372
772S 36" MIL VINYL . . . . .	.051353
772S 42" DBA VINYL . . . . .	.020595
772S 42" MIL VINYL . . . . .	.020590
772S 48" DBA VINYL . . . . .	.082218
772S 36" MIL PILE . . . . .	.051355
772S 48" MIL PILE . . . . .	.051356
774S 36" NEOPRENE . . . . .	.062304
774S 36" DBA NEOPRENE . . . . .	.064438
774S 36" MIL NEOPRENE . . . . .	.051357
774S 48" MIL NEOPRENE . . . . .	.051358
774S 36" MIL VINYL . . . . .	.051359
774S 48" DBA VINYL . . . . .	.061377
774S 48" MIL VINYL . . . . .	.051360
776S 42" CLR NEOPRENE . . . . .	.094490
777S 36" DBA NEOPRENE . . . . .	.035004
777S 36" MIL NEOPRENE . . . . .	.027008



**Door Bottoms & Sweeps**

777S 36" DBA VINYL . . . . .	.054611
777S 36" MIL VINYL . . . . .	.051363
778S 36" DBA NEOPRENE . . . . .	.015955
778S 36" MIL NEOPRENE . . . . .	.015977
778S 48" DBA NEOPRENE . . . . .	.058254
778S 36" VINYL . . . . .	.062294
778S 36" DBA VINYL . . . . .	.053780
778S 36" GLD VINYL . . . . .	.055193
778S 36" MIL VINYL . . . . .	.051365
778S 42" DBA VINYL . . . . .	.054862
778S 42" GLD VINYL . . . . .	.062642
778S 42" MIL VINYL . . . . .	.059750
778S 48" VINYL . . . . .	.062641
778S 48" DBA VINYL . . . . .	.054896
778S 48" MIL VINYL . . . . .	.051366
779S 36" DBA NEOPRENE . . . . .	.022886
779S 36" MIL NEOPRENE . . . . .	.025961
779S 42" MIL NEOPRENE . . . . .	.035071
779S 48" MIL NEOPRENE . . . . .	.026920
779S 36" DBA VINYL . . . . .	.057067
779S 36" GLD VINYL . . . . .	.066396
779S 36" LBA VINYL . . . . .	.062297
779S 36" MIL VINYL . . . . .	.054773
779S 42" DBA VINYL . . . . .	.021025
779S 42" GLD VINYL . . . . .	.068655
779S 42" MIL VINYL . . . . .	.058978
779S 48" DBA VINYL . . . . .	.012715
779S 48" GLD VINYL . . . . .	.032823
779S 48" MIL VINYL . . . . .	.057028
780S 36" MIL NEOPRENE . . . . .	.027342
780S 48" MIL NEOPRENE . . . . .	.029354
780S 36" DBA VINYL . . . . .	.059252
780S 36" GLD VINYL . . . . .	.086619
780S 36" MIL VINYL . . . . .	.054821
780S 42" DBA VINYL . . . . .	.053662
780S 42" MIL VINYL . . . . .	.065433
780S 48" DBA VINYL . . . . .	.071002
780S 48" MIL VINYL . . . . .	.055420
782S 36" BLA NEOPRENE . . . . .	.081341
782S 36" DBA NEOPRENE . . . . .	.048578
782S 36" MIL NEOPRENE . . . . .	.032350
782S 42" GLD NEOPRENE . . . . .	.044501
782S 48" MIL NEOPRENE . . . . .	.032330
782S 36" VINYL . . . . .	.005870
782S 36" DBA VINYL . . . . .	.034338
782S 36" GLD VINYL . . . . .	.039678

**Door Bottoms & Sweeps**

782S 36" MIL VINYL . . . . .	.022288
782S 36" WHP VINYL . . . . .	.106288
782S 42" DBA VINYL . . . . .	.014122
782S 42" MIL VINYL . . . . .	.054861
782S 48" MIL VINYL . . . . .	.034603
783S 36" MIL . . . . .	.115282
783S 36" GLD VINYL . . . . .	.098197
783S 36" MIL VINYL . . . . .	.037956
783S 48" MIL VINYL . . . . .	.037965
787S 36" MIL NEOPRENE . . . . .	.055268
789S 36" BLA PILE . . . . .	.037433
789S 36" DBA PILE . . . . .	.044987
789S 36" GLD PILE . . . . .	.032351
789S 36" MIL PILE . . . . .	.036194
789S 42" MIL PILE . . . . .	.036195
789S 48" MIL PILE . . . . .	.036617
801S 36" DBA BRUSH . . . . .	.059618
801S 36" GLD BRUSH . . . . .	.063248
<b>801S 36" MIL BRUSH . . . . .</b>	<b>053035</b>
801S 42" MIL BRUSH . . . . .	.055943
801S 48" DBA BRUSH . . . . .	.067890
<b>801S 48" MIL BRUSH . . . . .</b>	<b>054070</b>
802S 36" DBA BRUSH . . . . .	.054610
802S 36" GLD BRUSH . . . . .	.054786
<b>802S 36" MIL BRUSH . . . . .</b>	<b>053194</b>
802S 42" GLD BRUSH . . . . .	.052346
802S 42" MIL BRUSH . . . . .	.065250
802S 48" DBA BRUSH . . . . .	.061397
802S 48" GLD BRUSH . . . . .	.067474
802S 48" MIL BRUSH . . . . .	.054074
806S 36" DBA BRUSH . . . . .	.032352
806S 36" MIL BRUSH . . . . .	.035673
806S 48" DBA BRUSH . . . . .	.029484
806S 48" MIL BRUSH . . . . .	.031581
872S 36" US32D NEOPRENE . . . . .	.044304
872S 36" CLR NEOPRENE . . . . .	.095928
872S 36" MIB NEOPRENE . . . . .	.022021
872S 42" US32D NEOPRENE . . . . .	.086947
872S 48" US32D NEOPRENE . . . . .	.142033

**Jamb Weatherstripping**

785S 36" MIL NEOPRENE . . . . .	.120166
785S 36" x 84" MIL NEOPRENE . . . . .	.120162
785S 36" x 96" GLD NEOPRENE . . . . .	.120178
785S 36" x 96" MIL NEOPRENE . . . . .	.122126
785S 48" DBA NEOPRENE . . . . .	.122470
785S 72" x 84" DBA NEOPRENE . . . . .	.120174

**Jamb Weatherstripping**

785S 72" x 84" MIL NEOPRENE . . . . .	.120163
785S 84" DBA NEOPRENE . . . . .	.120177
785S 84" GLD NEOPRENE . . . . .	.120173
785S 84" MIL NEOPRENE . . . . .	.120164
785S 96" DBA NEOPRENE . . . . .	.120172
785S 96" MIL NEOPRENE . . . . .	.120171
800S 36" MIL BRUSH . . . . .	.054784
800S 36" x 84" MIL BRUSH . . . . .	.051373
800S 48" x 84" MIL BRUSH . . . . .	.051374
800S 72" x 84" MIL BRUSH . . . . .	.051375
800S 72" x 96" MIL BRUSH . . . . .	.019037
800S 84" DBA BRUSH . . . . .	.030583
800S 84" MIL BRUSH . . . . .	.056636
800S 96" MIL BRUSH . . . . .	.061569
802S 36" DBA BRUSH . . . . .	.054610
802S 36" GLD BRUSH . . . . .	.054786
802S 36" MIL BRUSH . . . . .	.053194
802S 36" x 84" MIL BRUSH . . . . .	.051379
802S 48" DBA BRUSH . . . . .	.061397
802S 48" GLD BRUSH . . . . .	.067474
802S 48" MIL BRUSH . . . . .	.054074
802S 48" x 84" MIL BRUSH . . . . .	.051380
802S 72" MIL BRUSH . . . . .	.055939
802S 72" x 84" MIL BRUSH . . . . .	.051381
802S 84" BCA BRUSH . . . . .	.101313
802S 84" BLA BRUSH . . . . .	.016491
802S 84" DBA BRUSH . . . . .	.055941
802S 84" GLD BRUSH . . . . .	.054500
<b>802S 84" MIL BRUSH . . . . .</b>	<b>.052979</b>
802S 96" BCA BRUSH . . . . .	.020711
802S 96" DBA BRUSH . . . . .	.054257
802S 96" MIL BRUSH . . . . .	.058708
803S 36" MIL BRUSH . . . . .	.054075
803S 36" x 84" MIL BRUSH . . . . .	.051382
803S 48" x 96" MIL BRUSH . . . . .	.048945
803S 72" x 84" MIL BRUSH . . . . .	.051394
803S 72" x 96" BLA BRUSH . . . . .	.015019
803S 72" x 96" DBA BRUSH . . . . .	.030527
803S 84" MIL BRUSH . . . . .	.053077
808S 48" MIL BRUSH . . . . .	.043629
808S 72" MIL BRUSH . . . . .	.040087
808S 84" DBA BRUSH . . . . .	.072589
808S 84" MIL BRUSH . . . . .	.038341
859S 36" x 84" DBA . . . . .	.031883
859S 36" x 84" GLD . . . . .	.038948
859S 36" x 84" MIL . . . . .	.080290

**Jamb Weatherstripping**

859S 36" x 96" MIL . . . . .	.030375
859S 36" x 108" MIL . . . . .	.030376
859S 48" GLD . . . . .	.121288
859S 48" MIL . . . . .	.067767
859S 48" x 84" MIL . . . . .	.071926
859S 48" x 96" MIL . . . . .	.042801
859S 72" DBA . . . . .	.090769
859S 72" MIL . . . . .	.095946
859S 72" x 84" MIL . . . . .	.070969
859S 72" x 96" MIL . . . . .	.091951
859S 84" DBA . . . . .	.086427
859S 84" GLD . . . . .	.121287
859S 84" MIL . . . . .	.028610
859S 96" MIL . . . . .	.091966
859S 120" MIL . . . . .	.042496
860S 36" x 84" MIL NEOPRENE . . . . .	.051234
860S 36" x 84" MIL VINYL . . . . .	.091326
861S 36" MIL NEOPRENE . . . . .	.065452
861S 36" x 84" MIL NEOPRENE . . . . .	.051235
861S 72" x 84" MIL NEOPRENE . . . . .	.051237
861S 84" MIL NEOPRENE . . . . .	.065463
862S 36" CLR NEOPRENE . . . . .	.083520
862S 36" x 84" CLR NEOPRENE . . . . .	.083522
862S 48" CLR NEOPRENE . . . . .	.060040
862S 48" x 84" CLR NEOPRENE . . . . .	.084994
862S 72" x 84" CLR NEOPRENE . . . . .	.083517
862S 72" x 84" DBA NEOPRENE . . . . .	.058008
862S 72" x 96" CLR NEOPRENE . . . . .	.083632
862S 72" x 96" DBA NEOPRENE . . . . .	.055343
862S 84" CLR NEOPRENE . . . . .	.083616
862S 84" DBA NEOPRENE . . . . .	.073092
862S 96" DBA NEOPRENE . . . . .	.061765
863S 36" x 84" CLR NEOPRENE . . . . .	.058992
863S 48" x 84" CLR NEOPRENE . . . . .	.092863
863S 72" x 84" CLR NEOPRENE . . . . .	.087142
863S 84" CLR NEOPRENE . . . . .	.084707
864S 36" CLR NEOPRENE . . . . .	.083568
864S 36" x 84" CLR NEOPRENE . . . . .	.057659
864S 36" x 96" CLR NEOPRENE . . . . .	.083570
864S 36" x 108" CLR NEOPRENE . . . . .	.062579
864S 48" x 84" CLR NEOPRENE . . . . .	.086659
864S 48" x 96" CLR NEOPRENE . . . . .	.032695
864S 72" x 84" CLR NEOPRENE . . . . .	.083572
864S 72" x 84" DBA NEOPRENE . . . . .	.065293
864S 84" CLR NEOPRENE . . . . .	.083573
864S 96" CLR NEOPRENE . . . . .	.094658



**Jamb Weatherstripping**

865S 36" DBA NEOPRENE . . . . .	.010688
865S 36" GLD NEOPRENE . . . . .	.055359
865S 36" MIL NEOPRENE . . . . .	.087913
865S 36" x 84" DBA NEOPRENE . . . . .	.036985
865S 36" x 84" GLD NEOPRENE . . . . .	.091572
865S 36" x 84" MIL NEOPRENE . . . . .	.062415
865S 36" x 96" DBA NEOPRENE . . . . .	.096197
865S 36" x 96" MIL NEOPRENE . . . . .	.017295
865S 36" x 108" DBA NEOPRENE . . . . .	.079468
865S 36" x 108" MIL NEOPRENE . . . . .	.083004
865S 48" MIL NEOPRENE . . . . .	.102562
865S 48" x 84" DBA NEOPRENE . . . . .	.101633
865S 48" x 84" GLD NEOPRENE . . . . .	.060542
865S 48" x 84" MIL NEOPRENE . . . . .	.028997
865S 48" x 96" DBA NEOPRENE . . . . .	.125536
865S 48" x 96" MIL NEOPRENE . . . . .	.075191
865S 48" x 108" MIL NEOPRENE . . . . .	.092260
865S 72" MIL NEOPRENE . . . . .	.087915
865S 72" x 84" DBA NEOPRENE . . . . .	.081104
865S 72" x 84" GLD NEOPRENE . . . . .	.091571
865S 72" x 84" MIL NEOPRENE . . . . .	.022917
865S 72" x 96" DBA NEOPRENE . . . . .	.036353
865S 72" x 96" MIL NEOPRENE . . . . .	.037449
865S 84" MIL NEOPRENE . . . . .	.025286
865S 96" GLD NEOPRENE . . . . .	.083908
865S 96" MIL NEOPRENE . . . . .	.054907
866S 36" DBA NEOPRENE TEK. . . . .	.103187
866S 36" MIL NEOPRENE . . . . .	.055632
866S 36" x 84" DBA NEOPRENE . . . . .	.040799
866S 36" x 84" GLD NEOPRENE . . . . .	.067399
866S 36" x 84" MIL NEOPRENE . . . . .	.056313
866S 36" x 96" MIL NEOPRENE . . . . .	.031942
866S 48" MIL NEOPRENE . . . . .	.006290
866S 48" x 84" GLD NEOPRENE . . . . .	.078811
866S 48" x 84" MIL NEOPRENE . . . . .	.037712
866S 48" x 108" MIL NEOPRENE . . . . .	.089576
866S 72" MIL NEOPRENE . . . . .	.055553
866S 72" x 84" DBA NEOPRENE . . . . .	.092913
866S 72" x 84" GLD NEOPRENE . . . . .	.110343
866S 72" x 84" MIL NEOPRENE . . . . .	.007786
866S 72" x 96" GLD NEOPRENE . . . . .	.105904
866S 72" x 96" MIL NEOPRENE . . . . .	.103804
866S 84" GLD NEOPRENE . . . . .	.078809
866S 84" MIL NEOPRENE . . . . .	.042719
866S 96" DBA NEOPRENE . . . . .	.031357
866S 96" MIL NEOPRENE . . . . .	.055485

**Jamb Weatherstripping**

866S 120" MIL NEOPRENE . . . . .	.074592
870S 36" US32D NEOPRENE . . . . .	.043706
870S 36" MIB NEOPRENE . . . . .	.037596
870S 36" x 84" US10B NEOPRENE . . . . .	.020778
870S 36" x 84" US32D NEOPRENE . . . . .	.041926
<b>870S 36" x 84" CLR NEOPRENE . . . . .</b>	<b>.059054</b>
870S 36" x 84" DBA NEOPRENE . . . . .	.053497
870S 36" x 84" GLD NEOPRENE . . . . .	.016082
870S 36" x 84" WHP NEOPRENE . . . . .	.044674
870S 36" x 96" US32D NEOPRENE . . . . .	.001160
870S 36" x 96" CLR NEOPRENE . . . . .	.083619
870S 36" x 96" MIB NEOPRENE . . . . .	.022400
870S 36" x 108" US10B NEOPRENE . . . . .	.048667
870S 48" US32D NEOPRENE . . . . .	.107363
870S 48" CLR NEOPRENE . . . . .	.068708
870S 48" x 84" US32D NEOPRENE . . . . .	.081517
870S 48" x 84" CLR NEOPRENE . . . . .	.063110
870S 48" x 96" CLR NEOPRENE . . . . .	.091229
870S 72" US32D NEOPRENE . . . . .	.133064
870S 72" CLR NEOPRENE . . . . .	.083870
870S 72" x 84" US32D NEOPRENE . . . . .	.047924
870S 72" x 84" CLR NEOPRENE . . . . .	.083596
870S 72" x 84" DBA NEOPRENE . . . . .	.053881
870S 72" x 84" MIB NEOPRENE . . . . .	.003592
870S 72" x 84" WHP NEOPRENE . . . . .	.044675
870S 72" x 96" US32D NEOPRENE . . . . .	.001161
870S 72" x 96" CLR NEOPRENE . . . . .	.084596
870S 72" x 96" WHP NEOPRENE . . . . .	.044676
870S 84" US32D NEOPRENE . . . . .	.054591
870S 84" CLR NEOPRENE . . . . .	.083597
870S 84" DBA NEOPRENE . . . . .	.060876
870S 96" US32D NEOPRENE . . . . .	.097748
870S 96" CLR NEOPRENE . . . . .	.083884
871S 36" MIL NEOPRENE . . . . .	.023335
871S 36" x 84" MIL NEOPRENE . . . . .	.051255
871S 48" x 84" MIL NEOPRENE . . . . .	.051198
871S 72" x 84" BLA NEOPRENE . . . . .	.106806
871S 72" x 84" MIL NEOPRENE . . . . .	.051257
871S 84" MIL NEOPRENE . . . . .	.063621
873S 36" MIL NEOPRENE . . . . .	.053862
873S 36" x 84" DBA NEOPRENE . . . . .	.053712
873S 36" x 84" MIL NEOPRENE . . . . .	.051263
873S 36" x 96" MIL NEOPRENE . . . . .	.058799
873S 48" x 84" MIL NEOPRENE . . . . .	.051264
873S 72" x 84" MIL NEOPRENE . . . . .	.051265
873S 84" DBA NEOPRENE . . . . .	.063162



**Jamb Weatherstripping**

873S 84" MIL NEOPRENE . . . . .	.053864
874S 36" US32D NEOPRENE . . . . .	.105906
874S 36" x 84" US32D NEOPRENE . . . . .	.064413
874S 36" x 84" MIL NEOPRENE . . . . .	.054083
874S 48" US32D NEOPRENE . . . . .	.113653
874S 48" x 84" US32D NEOPRENE . . . . .	.102263
874S 72" x 84" US32D NEOPRENE . . . . .	.102266
874S 72" x 96" US32D NEOPRENE . . . . .	.064095
874S 72" x 96" MIL NEOPRENE . . . . .	.087114
874S 84" MIL NEOPRENE . . . . .	.052592
874S 96" CLR NEOPRENE . . . . .	.130963
874S 96" MIL NEOPRENE . . . . .	.057221
874S 120" US32D NEOPRENE . . . . .	.078861
875S 36" CLR NEOPRENE . . . . .	.083401
875S 36" x 84" CLR NEOPRENE . . . . .	.058096
875S 36" x 96" MIB NEOPRENE . . . . .	.016481
875S 36" x 108" CLR NEOPRENE . . . . .	.053915
875S 48" CLR NEOPRENE . . . . .	.083402
875S 48" x 84" CLR NEOPRENE . . . . .	.084882
875S 72" x 84" CLR NEOPRENE . . . . .	.059921
875S 84" CLR NEOPRENE . . . . .	.084251
875S 96" MIB NEOPRENE . . . . .	.086938
875S 36" x 84" CLR SILICONE . . . . .	.003880
875S 36" x 84" MIB SILICONE . . . . .	.047315
875S 72" x 84" MIB SILICONE . . . . .	.044101
877S 36" x 84" MIL NEOPRENE . . . . .	.072544
878S 36" DBA NEOPRENE . . . . .	.005555
878S 36" x 84" CLR NEOPRENE . . . . .	.058993
880S 36" x 84" BLA NEOPRENE . . . . .	.064900
880S 36" x 84" MIL NEOPRENE . . . . .	.051275
880S 72" x 84" MIL NEOPRENE . . . . .	.051277
881S 36" MIL NEOPRENE . . . . .	.065849
881S 36" x 84" NEOPRENE . . . . .	.035415
881S 36" x 84" DBA NEOPRENE . . . . .	.084186
881S 36" x 84" MIL NEOPRENE . . . . .	.051279
881S 36" x 96" MIL NEOPRENE . . . . .	.087921
881S 48" MIL NEOPRENE . . . . .	.058998
881S 48" x 84" GLD NEOPRENE . . . . .	.058764
881S 48" x 84" MIL NEOPRENE . . . . .	.051280
881S 72" GLD NEOPRENE . . . . .	.092855
881S 72" MIL NEOPRENE . . . . .	.068703
881S 72" x 84" DBA NEOPRENE . . . . .	.062108
881S 72" x 84" GLD NEOPRENE . . . . .	.034678
881S 72" x 84" MIL NEOPRENE . . . . .	.051281
881S 72" x 96" MIL NEOPRENE . . . . .	.087923
881S 84" MIL NEOPRENE . . . . .	.054328

**Jamb Weatherstripping**

881S 96" MIL NEOPRENE . . . . .	.087019
881S 36" MIL SILICONE . . . . .	.065435
881S 36" x 84" GLD SILICONE . . . . .	.076415
881S 36" x 84" MIL SILICONE . . . . .	.055461
881S 36" x 96" MIL SILICONE . . . . .	.080370
881S 36" x 108" MIL SILICONE . . . . .	.049936
881S 48" MIL SILICONE . . . . .	.070160
881S 48" x 84" MIL SILICONE . . . . .	.075414
881S 48" x 96" MIL SILICONE . . . . .	.022364
881S 48" x 108" MIL SILICONE . . . . .	.056004
881S 72" MIL SILICONE . . . . .	.062770
881S 72" x 84" MIL SILICONE . . . . .	.062773
881S 72" x 96" MIL SILICONE . . . . .	.080371
881S 84" MIL SILICONE . . . . .	.054669
881S 96" MIL SILICONE . . . . .	.080374
881S 36" DBA VINYL . . . . .	.074308
881S 36" MIL VINYL . . . . .	.053349
881S 36" x 84" VINYL . . . . .	.000159
881S 36" x 84" DBA VINYL . . . . .	.058981
881S 36" x 84" MIL VINYL . . . . .	.052013
881S 36" x 96" MIL VINYL . . . . .	.078158
881S 36" x 108" MIL VINYL . . . . .	.072388
881S 48" MIL VINYL . . . . .	.055205
881S 48" x 84" MIL VINYL . . . . .	.052014
881S 48" x 96" MIL VINYL . . . . .	.073151
881S 72" MIL VINYL . . . . .	.053348
881S 72" x 84" DBA VINYL . . . . .	.058982
881S 72" x 84" MIL VINYL . . . . .	.056386
881S 72" x 96" DBA VINYL . . . . .	.058983
881S 72" x 96" MIL VINYL . . . . .	.063628
881S 84" MIL VINYL . . . . .	.055208
881S 96" MIL VINYL . . . . .	.062481
881S 36" MIL PILE . . . . .	.061446
881S 36" x 84" MIL PILE . . . . .	.065534
881S 36" x 96" MIL PILE . . . . .	.050803
881S 48" x 84" MIL PILE . . . . .	.079361
881S 48" x 96" MIL PILE . . . . .	.055447
881S 72" MIL PILE . . . . .	.073013
881S 72" x 84" MIL PILE . . . . .	.068518
882S 84" CLR BRUSH . . . . .	.092969
882S 84" DBA BRUSH . . . . .	.092972
882S 84" GLD BRUSH . . . . .	.092977
882S 96" CLR BRUSH . . . . .	.092971
882S 96" DBA BRUSH . . . . .	.092975
882S 96" GLD BRUSH . . . . .	.092978
883S 36" CLR BRUSH . . . . .	.092979



**Jamb Weatherstripping**

883S 36" DBA BRUSH . . . . .	.092980
883S 36" GLD BRUSH . . . . .	.092983
883S 84" CLR BRUSH . . . . .	.022506
884S 36" CLR VINYL . . . . .	.092987
884S 36" x 84" GLD VINYL . . . . .	.145335
884S 48" CLR VINYL . . . . .	.092988
884S 84" VINYL . . . . .	.112086
884S 84" CLR VINYL . . . . .	.092989
884S 84" DBA VINYL . . . . .	.092992
884S 84" GLD VINYL . . . . .	.093003
884S 96" CLR VINYL . . . . .	.092990
884S 96" DBA VINYL . . . . .	.093002
884S 96" GLD VINYL . . . . .	.093004
885S 72" x 84 CLR NEOPRENE . . . . .	.095035
885S 84" NEOPRENE . . . . .	.062195
885S 84" CLR SILICONE . . . . .	.098428
885S 36" x 84" CLR VINYL . . . . .	.094826
885S 36" x 84" DBA VINYL . . . . .	.064909
885S 72" x 84" DBA VINYL . . . . .	.026261
885S 72" x 96" DBA VINYL . . . . .	.098563
885S 84" CLR VINYL . . . . .	.054716
885S 96" DBA PILE . . . . .	.135972
890S 36" x 84" DBA NEOPRENE . . . . .	.054834
890S 36" x 84" MIL NEOPRENE . . . . .	.064142
890S 48" x 84" MIL NEOPRENE . . . . .	.091396
890S 72" x 84" DBA NEOPRENE . . . . .	.054835
890S 72" x 84" MIL NEOPRENE . . . . .	.064143
890S 72" x 96" MIL NEOPRENE . . . . .	.078079
890S 84" MIL NEOPRENE . . . . .	.072200
890S 36" x 84" MIL SILICONE . . . . .	.060628
890S 72" x 96" MIL SILICONE . . . . .	.093708
890S 36" MIL VINYL . . . . .	.065300
890S 36" x 84" DBA VINYL . . . . .	.053199
890S 36" x 84" MIL VINYL . . . . .	.051287
890S 48" MIL VINYL . . . . .	.053842
890S 48" x 84" MIL VINYL . . . . .	.051288
890S 72" MIL VINYL . . . . .	.069373
890S 72" x 84" MIL VINYL . . . . .	.051302
890S 72" x 96" MIL VINYL . . . . .	.056203
890S 84" MIL VINYL . . . . .	.053181
890S 96" MIL VINYL . . . . .	.053841
891S 72" x 84" MIL FVN . . . . .	.008055
891S 36" x 84" DBA NEOPRENE . . . . .	.055108
891S 36" x 84" GLD NEOPRENE . . . . .	.093250
891S 36" x 84" MIL NEOPRENE . . . . .	.056722
891S 36" x 96" DBA NEOPRENE . . . . .	.014000

**Jamb Weatherstripping**

891S 36" x 96" MIL NEOPRENE . . . . .	.057549
891S 48" x 84" DBA NEOPRENE . . . . .	.057018
891S 48" x 84" MIL NEOPRENE . . . . .	.057511
891S 48" x 96" DBA NEOPRENE . . . . .	.033393
891S 72" x 84" DBA NEOPRENE . . . . .	.057019
891S 72" x 84" GLD NEOPRENE . . . . .	.074600
891S 72" x 84" MIL NEOPRENE . . . . .	.057020
891S 72" x 96" DBA NEOPRENE . . . . .	.019682
891S 72" x 96" MIL NEOPRENE . . . . .	.061748
891S 84" DBA NEOPRENE . . . . .	.008359
891S 84" MIL NEOPRENE . . . . .	.073792
891S 96" MIL NEOPRENE . . . . .	.025113
891S 36" x 84" DBA SILICONE . . . . .	.057068
891S 36" x 84" MIL SILICONE . . . . .	.057519
891S 48" x 84" MIL SILICONE . . . . .	.059552
891S 72" GASKET ONLY, SILICONE BLACK . . . . .	.134581
891S 72" GASKET ONLY, SILICONE BLACK BKG . . . . .	.134598
891S 72" x 84" MIL SILICONE . . . . .	.061696
891S 72" x 96" MIL SILICONE . . . . .	.081032
891S 84" GASKET ONLY, SILICONE BLACK BKG . . . . .	.134783
891S 84" MIL SILICONE . . . . .	.056283
891S 96" MIL SILICONE . . . . .	.056284
891S 36" DBA VINYL . . . . .	.003929
891S 36" MIL VINYL . . . . .	.052986
891S 36" x 84" CLR VINYL . . . . .	.033882
891S 36" x 84" DBA VINYL . . . . .	.052356
891S 36" x 84" GLD VINYL . . . . .	.052599
<b>891S 36" x 84" MIL VINYL . . . . .</b>	<b>.051304</b>
891S 36" x 96" DBA VINYL . . . . .	.054437
891S 36" x 96" MIL VINYL . . . . .	.053667
891S 36" x 108" MIL VINYL . . . . .	.057520
891S 48" MIL VINYL . . . . .	.055375
891S 48" x 84" DBA VINYL . . . . .	.052432
891S 48" x 84" GLD VINYL . . . . .	.057871
<b>891S 48" x 84" MIL VINYL . . . . .</b>	<b>.051305</b>
891S 48" x 96" DBA VINYL . . . . .	.054216
891S 48" x 96" MIL VINYL . . . . .	.056032
891S 72" MIL VINYL . . . . .	.053692
891S 72" x 84" DBA VINYL . . . . .	.052357
891S 72" x 84" GLD VINYL . . . . .	.054126
<b>891S 72" x 84" MIL VINYL . . . . .</b>	<b>.051306</b>
891S 72" x 96" DBA VINYL . . . . .	.052433
891S 72" x 96" MIL VINYL . . . . .	.052431
891S 84" DBA VINYL . . . . .	.064207
891S 84" MIL VINYL . . . . .	.053031
891S 96" DBA VINYL . . . . .	.071086

**Jamb Weatherstripping**

891S 96" MIL VINYL . . . . .	.053015
892S 36" x 84" DBA NEOPRENE . . . . .	.044791
892S 36" x 84" GLD NEOPRENE . . . . .	.047155
892S 36" x 84" MIL NEOPRENE . . . . .	.044788
892S 48" x 84" MIL NEOPRENE . . . . .	.044785
892S 72" x 84" DBA NEOPRENE . . . . .	.048297
892S 72" x 84" GLD NEOPRENE . . . . .	.071107
892S 72" x 84" MIL NEOPRENE . . . . .	.044786
892S 84" MIL NEOPRENE . . . . .	.044967
893S 36" DBA PILE . . . . .	.055134
893S 36" MIL PILE . . . . .	.051285
893S 36" x 84" MIL PILE . . . . .	.051314
893S 72" x 84" MIL PILE . . . . .	.051313
893S 72" x 84" WHP PILE . . . . .	.048452
893S 84" CLR PILE . . . . .	.085233
893S 84" DBA PILE . . . . .	.058449
893S 84" GLD PILE . . . . .	.064959
893S 84" MIL PILE . . . . .	.053666
893S 96" MIL PILE . . . . .	.056263
896S 36" x 84" DBA NEOPRENE . . . . .	.036879
896S 36" x 84" MIL NEOPRENE . . . . .	.033668
896S 48" x 84" MIL NEOPRENE . . . . .	.037316
896S 48" x 96" MIL NEOPRENE . . . . .	.050091
896S 72" x 84" MIL NEOPRENE . . . . .	.035258
896S 84" MIL NEOPRENE . . . . .	.035980
896S 96" MIL NEOPRENE . . . . .	.049422
896S 36" x 84" MIL SILICONE . . . . .	.066836
896S 48" x 84" MIL SILICONE . . . . .	.051154
896S 36" MIL VINYL . . . . .	.063497
896S 36" x 84" GLD VINYL . . . . .	.087327
896S 36" x 84" MIL VINYL . . . . .	.073543
896S 72" x 84" MIL VINYL . . . . .	.074012
896S 84" MIL VINYL . . . . .	.033779

**Astragals**

756S 84" DBA VINYL . . . . .	.054120
756S 84" MIL VINYL . . . . .	.059622
756S 96" DBA VINYL . . . . .	.020114
756S 96" MIL VINYL . . . . .	.075551
771S 84" MIL NEOPRENE . . . . .	.097923
771S 96" MIL SILICONE . . . . .	.123173
771S 84" MIL VINYL . . . . .	.037527
771S 96" MIL VINYL . . . . .	.046239
771S 84" MIL PILE . . . . .	.052983
772S 84" DBA NEOPRENE . . . . .	.015390
772S 96" MIL VINYL . . . . .	.064436
772S 84" DBA PILE . . . . .	.098335

**Astragals**

774S 96" MIL NEOPRENE . . . . .	.059422
774S 84" MIL VINYL . . . . .	.085136
802S 84" BCA BRUSH . . . . .	.101313
802S 84" BLA BRUSH . . . . .	.016491
802S 84" DBA BRUSH . . . . .	.055941
802S 84" GLD BRUSH . . . . .	.054500
802S 84" MIL BRUSH . . . . .	.052979
802S 96" BCA BRUSH . . . . .	.020711
802S 96" DBA BRUSH . . . . .	.054257
802S 96" MIL BRUSH . . . . .	.058708
822S 96" MIB . . . . .	.060612
822S 96" MIB BULK . . . . .	.086203
823S 96" MIB . . . . .	.066769
824S 84" MIB . . . . .	.067302
824S 96" MIB . . . . .	.027194
835S 84" US32D . . . . .	.057965
835S 84" DBA . . . . .	.054076
835S 84" GLD . . . . .	.052598
835S 84" GYP . . . . .	.052218
835S 84" MIL . . . . .	.051399
835S 96" US32D . . . . .	.082492
835S 96" DBA . . . . .	.054077
835S 96" GYP . . . . .	.054078
835S 96" MIL . . . . .	.051401
835S 120" US32D . . . . .	.019549
835S 120" DBA . . . . .	.028190
835S 120" GYP . . . . .	.066347
835S 120" MIL . . . . .	.072577
836S 84" DBA . . . . .	.052438
836S 84" GLD . . . . .	.067594
836S 84" MIL . . . . .	.051402
836S 96" DBA . . . . .	.065451
836S 96" GLD . . . . .	.013885
836S 96" MIL . . . . .	.051404
836S 120" DBA . . . . .	.056267
836S 120" MIL . . . . .	.070159
837S 84" DBA NEOPRENE . . . . .	.058049
837S 84" GLD NEOPRENE . . . . .	.060491
837S 84" MIL NEOPRENE . . . . .	.051407
837S 96" DBA NEOPRENE . . . . .	.052767
837S 96" MIL NEOPRENE . . . . .	.051408
837S 120" MIL NEOPRENE . . . . .	.069420
837S 84" DBA SILICONE . . . . .	.058625
837S 84" GLD SILICONE . . . . .	.062464
837S 84" MIL SILICONE . . . . .	.056392
837S 96" DBA SILICONE . . . . .	.058626



**Astragals**

837S 96" GLD SILICONE . . . . .	.079237
837S 96" MIL SILICONE . . . . .	.058141
837S 84" DBA VINYL . . . . .	.052439
837S 84" GLD VINYL . . . . .	.054867
837S 84" MIL VINYL . . . . .	.051405
837S 84" WHP VINYL . . . . .	.076481
837S 96" BCA VINYL . . . . .	.020677
837S 96" DBA VINYL . . . . .	.059436
837S 96" GLD VINYL . . . . .	.090519
837S 96" MIL VINYL . . . . .	.051406
837S 120" GLD VINYL . . . . .	.068238
837S 120" MIL VINYL . . . . .	.059619
838S 84" MIL PILE . . . . .	.056500
838S 96" MIL PILE . . . . .	.063241
839SW 84" MIL BRUSH . . . . .	.141943
839S 84" MIL BRUSH . . . . .	.141944
839S 96" MIL BRUSH . . . . .	.141947
839S 120" MIL BRUSH . . . . .	.141949
845S 84" MIL PILE . . . . .	.051409
846S 84" MIL . . . . .	.051410
847S 84" DBA PILE . . . . .	.075287
847S 84" GLD PILE . . . . .	.000606
847S 96" GLD PILE . . . . .	.135979
848S 84" DBA . . . . .	.075288
848S 84" GLD . . . . .	.128894
849S 84" DBA . . . . .	.038794
849S 84" GLD . . . . .	.022999
849S 84" MIL . . . . .	.014074
849S 96" DBA . . . . .	.075587
849S 96" GLD . . . . .	.080239
849S 96" MIL . . . . .	.031904
872S 84" US32D NEOPRENE . . . . .	.046184
<b>872S 84" CLR NEOPRENE . . . . .</b>	<b>.053566</b>
872S 84" DBA NEOPRENE . . . . .	.052859
872S 84" GLD NEOPRENE . . . . .	.053173
872S 96" US32D NEOPRENE . . . . .	.028509
872S 96" CLR NEOPRENE . . . . .	.083594
872S 120" US32D NEOPRENE . . . . .	.060244
872S 120" CLR NEOPRENE . . . . .	.084691
874S 84" MIL NEOPRENE . . . . .	.052592
874S 96" CLR NEOPRENE . . . . .	.130963
874S 96" MIL NEOPRENE . . . . .	.057221
874S 120" US32D NEOPRENE . . . . .	.078861

**Spring Bronze**

822S 96" MIB . . . . .	.060612
822S 96" MIB BULK . . . . .	.086203

**Rain Drips**

810S 40" US32D . . . . .	.134678
810S 40" AWP . . . . .	.057538
810S 40" DBA . . . . .	.052360
810S 40" GLD . . . . .	.052597
<b>810S 40" MIL . . . . .</b>	<b>.051396</b>
810S 40" WHP . . . . .	.038074
810S 76" US32D . . . . .	.134680
810S 76" DBA . . . . .	.052924
810S 76" GLD . . . . .	.075081
<b>810S 76" MIL . . . . .</b>	<b>.051398</b>
810S 76" WHP . . . . .	.038076