

# PT180 INSTALLATION TEMPLATE

## NOTES:

1. USE TRANSFER CASE HOUSING AS DRILLING TEMPLATE.
2. USE 22 GAUGE STRANDED WIRE ONLY.
3. USE CARE WHEN INSERTING WIRES THROUGH THIS DEVICE.
4. RECTANGULAR CUT-OUT IS 11/16" DEEP (MINIMUM) FOR WOOD FRAME.
5. WIRES SHOULD BE LABELED.
6. SIZE AND NUMBER OF WIRES MUST COMPLY WITH THE NATIONAL ELECTRICAL CODE, NFPA, AND LOCAL ELECTRICAL CODES.
7. THIS DEVICE IS FOR LOW VOLTAGE USE ONLY. (30 VAC, 42.5 VDC, 10 WATTS MAX.)

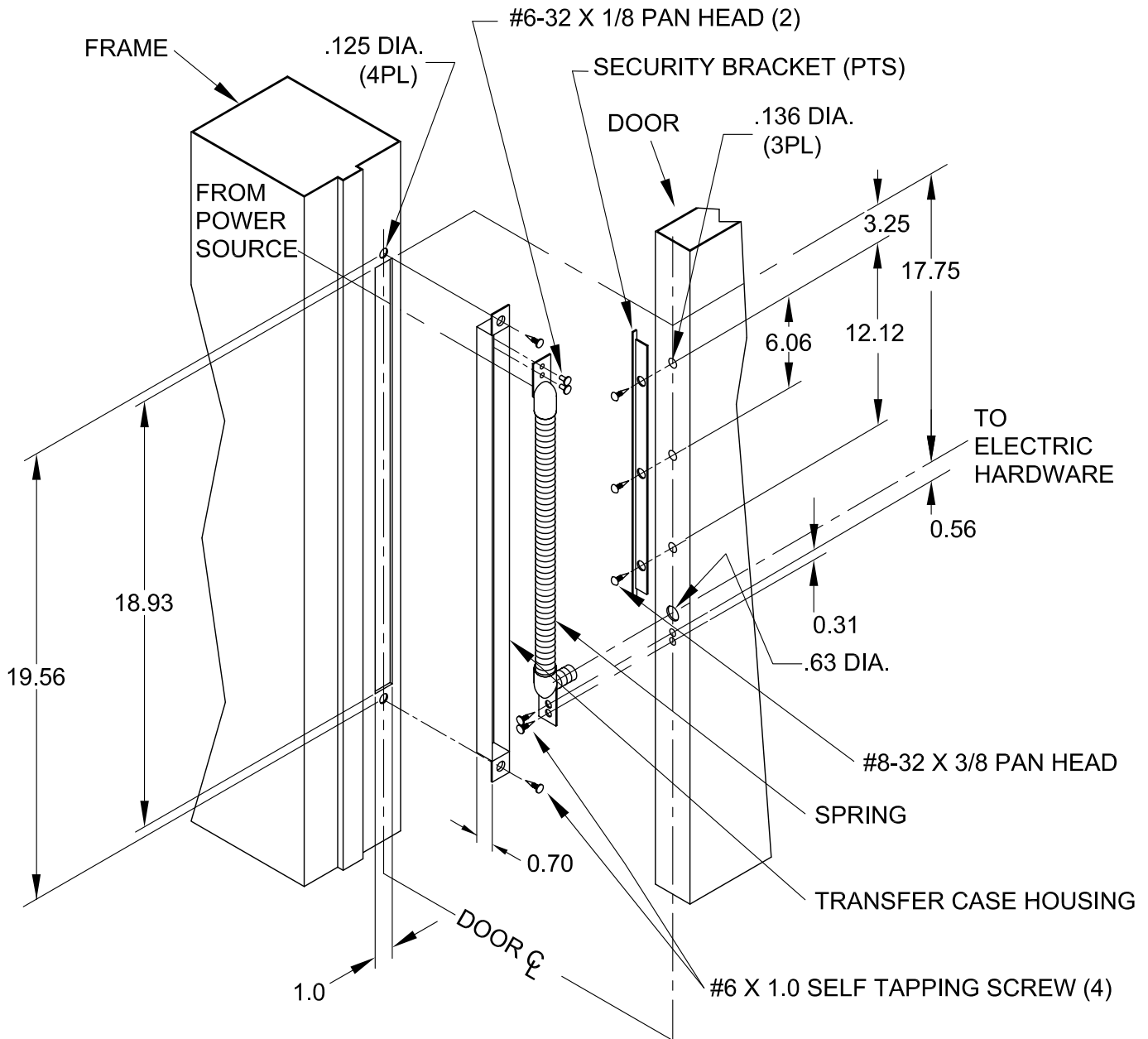

www.abhmf.com  
 E-mail: abhinfo@abhmf.com  
 Architectural Builders Hardware Mfg., Inc.  
 1222 Ardmore Ave., Itasca, IL 60143  
 630.875.9900; FAX 800.9FAXABH (932.9224)



© 2005 ABH Mfg., Inc.  
 printed in USA

PT180 TEMPLATE-00.DWG

PT180

ISSUED 06-23-05